



Underscore® Rectangle

60" x 32" alcove bath
K-1957-LA

Features

- Integral lumbar support.
- Slotted overflow allows for deep soaking.
- Integral apron creates a clean, finished look.
- Integral flange helps prevent water from seeping behind wall and simplifies alcove installation.
- Textured bottom surface.

Material

- Acrylic.

Installation

- Left drain.
- Requires K-7271 or K-7272 Clearflo slotted overflow bath drain (sold separately).
- Alcove.

Required Products/Accessories

K-7271 Brass Slotted Overflow Bath Drain
K-7272 PVC Slotted Overflow Bath Drain

Recommended Products/Accessories

K-23726 Drain treatment
K-23732 Tub & shower cleaner



Codes/Standards









CSA B45.5/IAPMO Z124
ASTM E162
ASTM E662

KOHLER® Plastic Baths and Receptors Lifetime Limited Warranty

See website for detailed warranty information.

Available Colors/Finishes

Color tiles intended for reference only.

| Color | Code | Description |
|---|------|---------------|
|  | 0 | White |
|  | 96 | Biscuit |
|  | NY | Dune |
|  | 95 | Ice™ Grey |
|  | G9 | Sandbar |
|  | K4 | Cashmere |
|  | 58 | Thunder™ Grey |
|  | 7 | Black Black™ |

1-800-4KOHLER (1-800-456-4537)

Kohler Co. reserves the right to make revisions without notice to product specifications.
For the most current Specification Sheet, go to www.kohler.com.

THE BOLD LOOK
OF **KOHLER**®

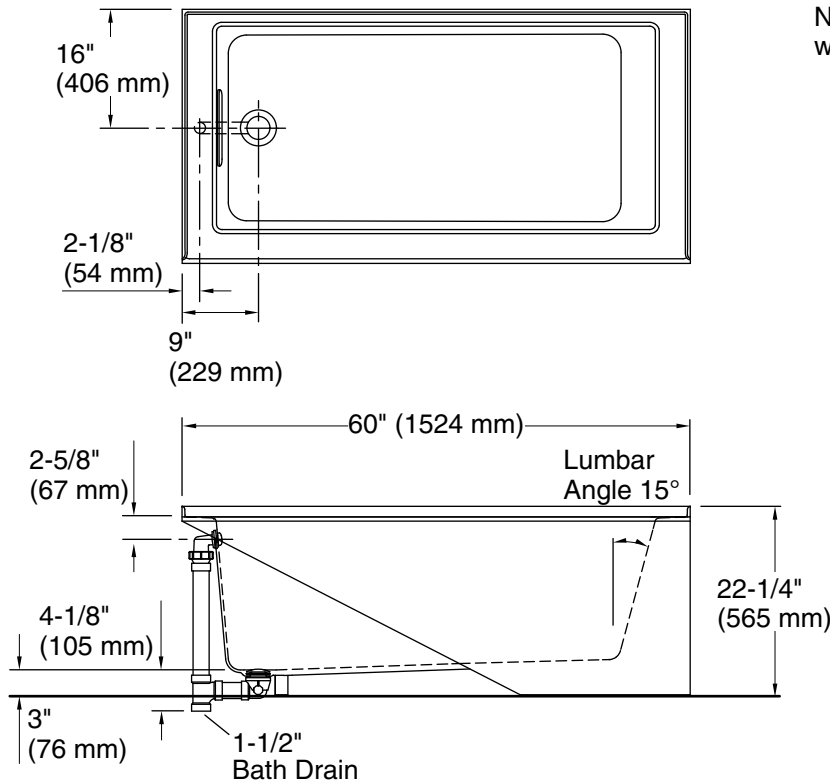

No change in measurements if connected with drain illustrated. (K-7272)

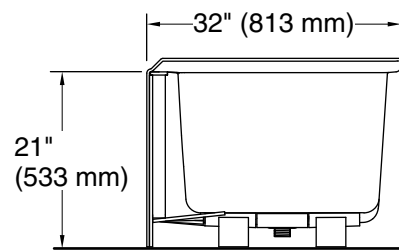
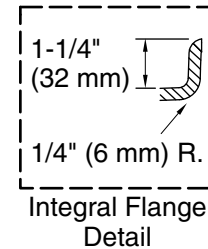

Technical Information

All product dimensions are nominal.

| | |
|------------------------|---|
| Installation: | Three-wall alcove |
| Drain location: | Left |
| Basin area, bottom: | 46-1/4" x 22" (1175 mm x 559 mm) |
| Basin area, top: | 52" x 24" (1321 mm x 610 mm) |
| Weight: | 105 lbs (47.6 kg) |
| Minimum floor load: | 56 lbs/ft ² (273.4 kg/m ²) |
| Water depth: | 15-1/2" (394 mm) |
| Water capacity: | 68 gal (257.4 L) |
| Minimum flat for door: | 2-3/4" (70 mm) |

Notes

Measure your actual product for rough-in details.

Install this product according to the installation instructions.

The hot water supply should be 70% of the capacity of the bath or greater. Installations will vary.