

Features

- 15" (381 mm) minimum base cabinet width.
- Single bowl.
- 7" depth.

Material

- KOHLER® enameled cast iron.

Installation

- Includes undermount installation kit for simplified installation.
- Undermount.

Recommended Products/Accessories

- K-8801 Sink drain and strainer with tailpiece
- K-8799 Sink drain and strainer basket
- K-23726 Drain treatment
- K-23725 Cast iron cleaner

Optional Products/Accessories

- K-11352 Disposal Flange with Stopper
- K-9000 P-Trap

Included Components

- Product consists of:
- 52047 Clamp Accessory Pack, 4 Ea.



ADA

Codes/Standards













- ASME A112.19.1/CSA B45.2
- ADA
- ICC/ANSI A117.1

KOHLER® Enameled Cast Iron Kitchen Sink Lifetime Limited Warranty

See website for detailed warranty information.

Available Colors/Finishes

Color tiles intended for reference only.

Color	Code	Description
	0	White
	FF	Sea Salt™
	96	Biscuit
	NY	Dune
	95	Ice™ Grey
	G9	Sandbar
	33	Mexican Sand™
	K4	Cashmere
	FT	Basalt
	58	Thunder™ Grey
	FP	Caviar
	7	Black Black™

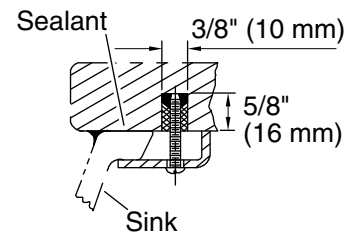
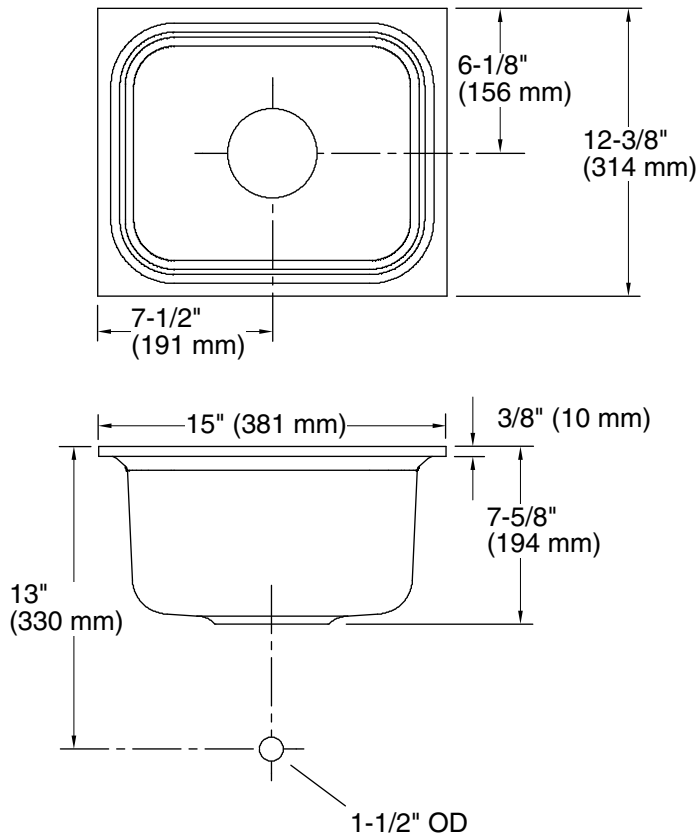

Marble Slab
Installation

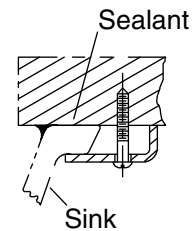

Wood Counter
Installation

Note: Waterproof the unprotected overhang area on the underside of a wood counter.

Technical Information

All product dimensions are nominal.

Bowl configuration:	Single
Installation:	Under-mount
Min. base cabinet width:	15" (381 mm)
Bowl area:	Length: 12" (305 mm) Width: 9-1/4" (235 mm) Bowl depth: 7" (178 mm)
Drain hole:	3-7/8" (98 mm)
Template:	1086707-7, required, included

Notes

Install this product according to the installation instructions.

Supplied bowl clamp assemblies require 1" (25 mm) minimum countertop thickness. Installer must supply anchors for thinner countertops.

For multiple bowl under-mount installations, a minimum distance of 3-3/8" (86 mm) is required between bowls. Countertop supplier to determine required support.

ADA compliant when installed to the specific requirements of these regulations.

ADA permits a parallel approach to wet bars.