

Features

- 36" minimum base cabinet width.
- Single bowl.
- 9" (229 mm) depth provides generous workspace.
- Shortened apron allows sink to be used in most standard cabinetry or retrofitted to existing standard cabinetry.
- Self-Trimming® apron overlaps cabinet face for easy installation and beautiful results.
- Basin slopes 2° toward drain to minimize water pooling.
- Offset drain increases workspace in the sink and storage space underneath.

Material

- KOHLER® enameled cast iron.

Installation

- Undermount.

Recommended Products/Accessories

- K-6639 Sink racks for 36" Whitehaven®
- K-8801 Sink drain and strainer with tailpiece
- K-8799 Sink drain and strainer basket
- K-23726 Drain treatment
- K-23725 Cast iron cleaner

Optional Products/Accessories

- K-11352 Disposal Flange with Stopper
- K-9000 P-Trap



Codes/Standards













ASME A112.19.1/CSA B45.2

KOHLER® Enameled Cast Iron Kitchen Sink Lifetime Limited Warranty

See website for detailed warranty information.

Available Colors/Finishes

Color tiles intended for reference only.

Color	Code	Description
	0	White
	FF	Sea Salt™
	96	Biscuit
	NY	Dune
	95	Ice™ Grey
	K4	Cashmere
	FT	Basalt
	58	Thunder™ Grey
	KA	Black 'n Tan
	FP	Caviar
	7	Black Black™
	GRL	Grey Lavender
	DGB	Indigo Blue
	PLM	Black Plum

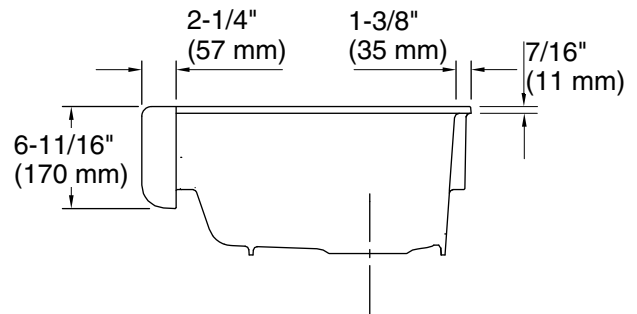
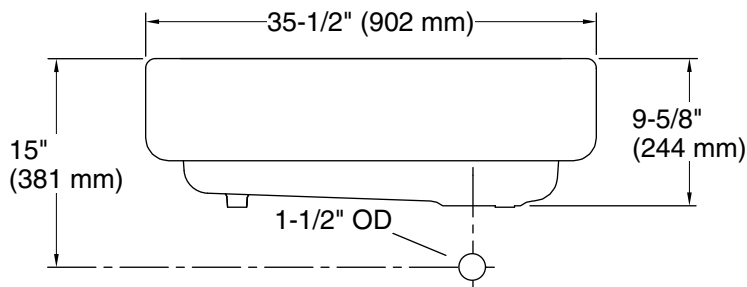
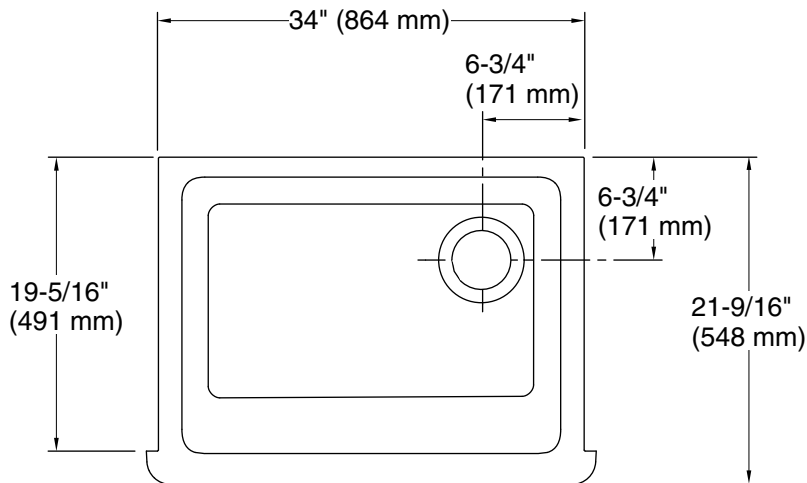

Technical Information

All product dimensions are nominal.

Bowl configuration: Single

Installation: Under-mount

Min. base cabinet width: 36" (914 mm)

Bowl area (Only): Length: 30-3/4" (781 mm)
Width: 18-1/16" (459 mm)
Bowl depth: 9" (229 mm)

Drain hole: 3-5/8" (92 mm)

Template: 1156910-7, required, included
1211449-7, required, included

Notes

Install this product according to the installation instructions.

NOTICE: Countertop manufacturer or cutter must use the current product template available at www.kohler.com, or by calling 1-800-4KOHLER. Kohler Co. is not responsible for cutout errors when the incorrect cutout template is used.

IMPORTANT! The distance from the top edge of the cabinet to the top of the cabinet door must be at least 6-7/8" (175 mm) to install this sink.