

## Features

- 36" minimum base cabinet width.
- Large/medium bowls.
- 9" (229 mm) depth provides generous workspace.
- Shortened apron allows sink to be used in most standard cabinetry or retrofitted to existing standard cabinetry.
- Self-Trimming® apron overlaps cabinet face for easy installation and beautiful results.
- Smart Divide® feature offers a lower bowl divider that increases workspace versatility.
- Basin slopes toward drain to minimize water pooling.
- Offset drain increases workspace in the sink and storage space underneath.

## Material

- KOHLER® enameled cast iron.

## Installation

- Undermount.

## Recommended Products/Accessories

- K-5828 Sink Rack
- K-5874 Sink Rack
- K-8801 Sink drain and strainer with tailpiece
- K-8799 Sink drain and strainer basket
- K-23726 Drain treatment
- K-23725 Cast iron cleaner

## Optional Products/Accessories

- K-11352 Disposal Flange with Stopper
- K-9000 P-Trap

## Included Components

Additional Components:

- Cabinet face cut-out template
- Countertop cut-out template



## Codes/Standards















ASME A112.19.1/CSA B45.2

## KOHLER® Enameled Cast Iron Kitchen Sink Lifetime Limited Warranty

See website for detailed warranty information.

## Available Colors/Finishes

*Color tiles intended for reference only.*

| Color   | Code | Description   |
|---|------|---------------|
|  | 0    | White         |
|  | FF   | Sea Salt™     |
|  | 96   | Biscuit       |
|  | NY   | Dune          |
|  | 95   | Ice™ Grey     |
|  | G9   | Sandbar       |
|  | K4   | Cashmere      |
|  | FT   | Basalt        |
|  | 58   | Thunder™ Grey |
|  | FP   | Caviar        |
|  | 7    | Black Black™  |
|  | GRL  | Grey Lavender |
|  | DGB  | Indigo Blue   |
|  | PLM  | Black Plum    |

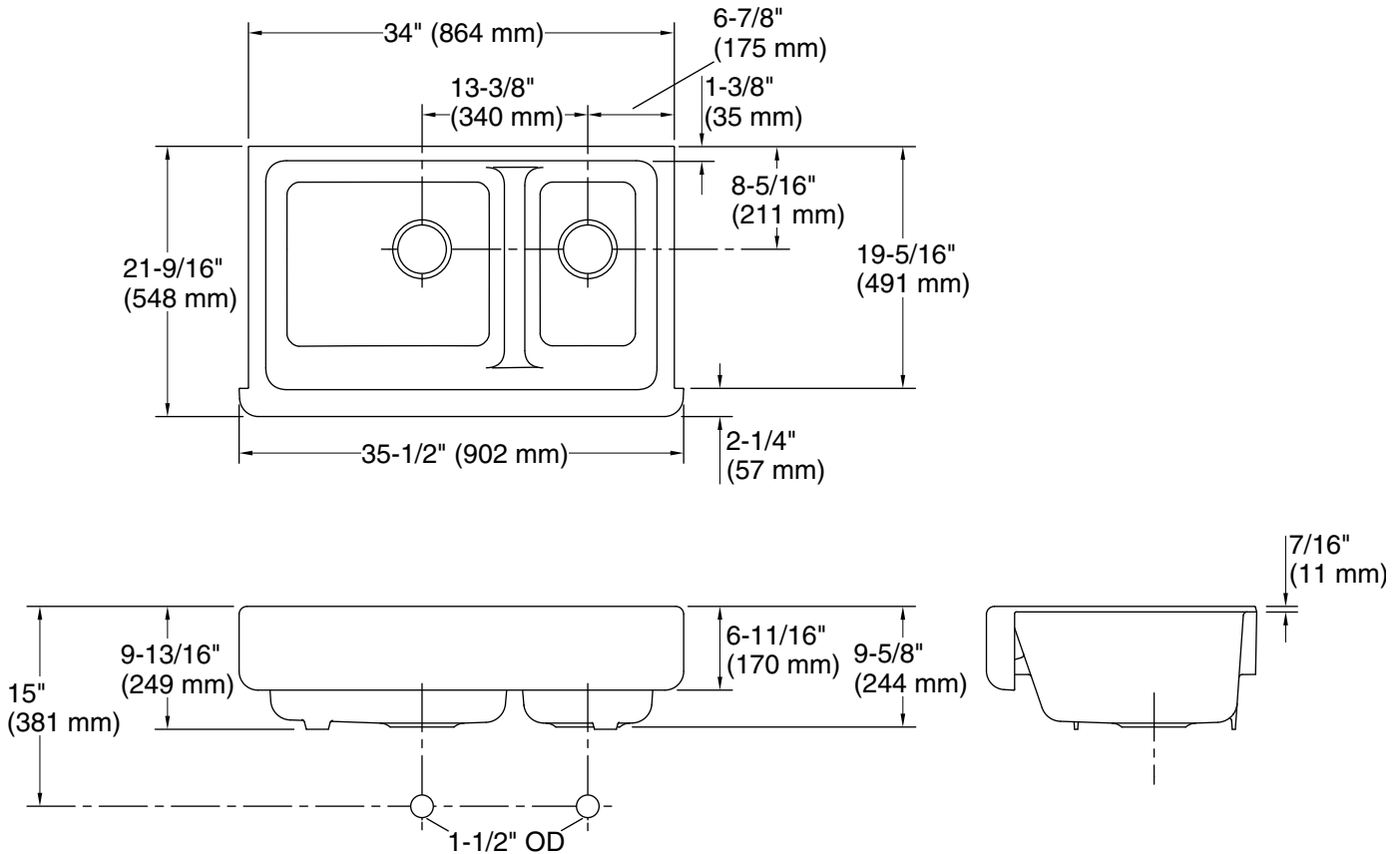

### Technical Information

All product dimensions are nominal.

Bowl configuration: Off-set Large/small

Installation: Under-mount

Min. base cabinet width: 36" (914 mm)

Bowl area: Length: 18-13/16" (478 mm)

Width: 18-1/16" (459 mm)

Bowl depth: 9" (229 mm)

Water depth: 9" (229 mm)

Bowl area: Length: 10-5/16" (262 mm)

Width: 18-1/16" (459 mm)

Bowl depth: 9" (229 mm)

Water depth: 9" (229 mm)

Drain hole: 3-5/8" (92 mm)

### Notes

Install this product according to the installation instructions.

**NOTICE:** The countertop manufacturer or cutter must use the cut-out template provided with the product, or a current one provided by Kohler Co. (call 1-800-4KOHLER). Kohler Co. is not responsible for cut-out errors when the incorrect cut-out template is used.

**IMPORTANT!** The distance from the top edge of the cabinet to the top of the cabinet door must be at least 6-7/8" (175 mm) to install this sink.