

#### Features

- 33" (838 mm) minimum base cabinet width.
- Single bowl.
- 9" (229 mm) depth provides generous workspace.
- Basin slopes 2° toward drain to minimize water pooling.
- Offset drain increases workspace in the sink and storage space underneath.
- Includes K-6239 colander with integral cutting board and K-6237 left-hand bottom sink rack.

#### Material

- KOHLER® enameled cast iron.

#### Installation

- Top-mount.

#### Recommended Products/Accessories

- K-6237 Left-Bowl Sink Rack
- K-6255 Right-Bowl Sink Rack
- K-8801 Sink drain and strainer with tailpiece
- K-8799 Sink drain and strainer basket
- K-23726 Drain treatment
- K-23725 Cast iron cleaner

#### Optional Products/Accessories

- K-6194 Utility Rack With Soaking Cup
- K-6246 Cutting Board
- K-11352 Disposal Flange with Stopper
- K-9000 P-Trap

#### Included Components

Product consists of:

- K-6239 Colander with Cutting Board
- K-6237 Left-Bowl Sink Rack



#### Codes/Standards







ASME A112.19.1/CSA B45.2

#### KOHLER® Enameled Cast Iron Kitchen Sink Lifetime Limited Warranty

See website for detailed warranty information.

#### Available Colors/Finishes

*Color tiles intended for reference only.*

Color	Code	Description
	0	White
	FF	Sea Salt™
	96	Biscuit
	95	Ice™ Grey
	G9	Sandbar
	K4	Cashmere
	7	Black Black™

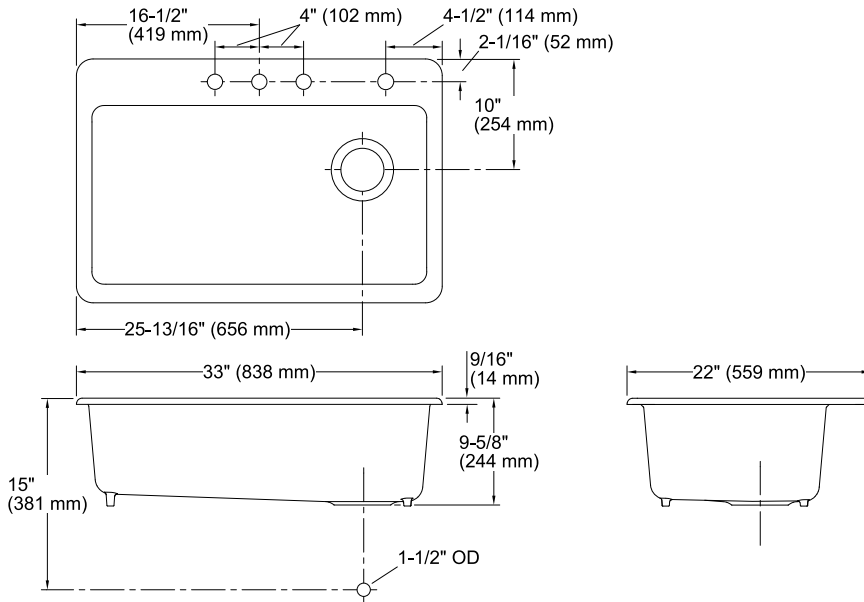

## Technical Information

All product dimensions are nominal.

Bowl configuration: Single

Installation: Top-mount

Min. base cabinet width: 33" (838 mm)

Bowl area (Only): Length: 30-1/4" (768 mm)  
 Width: 15-13/16" (402 mm)  
 Water depth: 9" (229 mm)

Number of deck holes: 4

Faucet hole spacing: 4" (102 mm)

Faucet hole(s): 1-3/8" (35 mm)

Drain hole: 3-7/8" (98 mm)

Template: 1166727-7, required, included

## Notes

Install this product according to the installation instructions.

**NOTICE:** Countertop manufacturer or cutter must use the cut-out template provided with the product, or a current one provided by Kohler Co. (call 1-800-4-KOHLER). Kohler Co. is not responsible for cutout errors when the incorrect cut-out template is used.