

## Features

- 33" (838 mm) minimum base cabinet width.
- Single bowl.
- 9" (229 mm) depth provides generous workspace.
- Single faucet hole.
- Basin slopes 2° toward drain to minimize water pooling.
- Offset drain increases workspace in the sink and storage space underneath.
- Includes K-6239 colander with integral cutting board and K-6237 left-hand bottom sink rack.

## Material

- KOHLER® enameled cast iron.

## Installation

- Top-mount.

## Recommended Products/Accessories

- K-6237 Left-Bowl Sink Rack
- K-6255 Right-Bowl Sink Rack
- K-8801 Sink drain and strainer with tailpiece
- K-8799 Sink drain and strainer basket
- K-23726 Drain treatment
- K-23725 Cast iron cleaner

## Optional Products/Accessories

- K-6194 Utility Rack With Soaking Cup
- K-6246 Cutting Board
- K-11352 Disposal Flange with Stopper
- K-9000 P-Trap

## Included Components

Product consists of:

- K-6239 Colander with Cutting Board
- K-6237 Left-Bowl Sink Rack



## Codes/Standards







ASME A112.19.1/CSA B45.2

## KOHLER® Enameled Cast Iron Kitchen Sink Lifetime Limited Warranty

See website for detailed warranty information.

## Available Colors/Finishes

*Color tiles intended for reference only.*

Color	Code	Description
	0	White
	FF	Sea Salt™
	96	Biscuit
	95	Ice™ Grey
	K4	Cashmere
	7	Black Black™

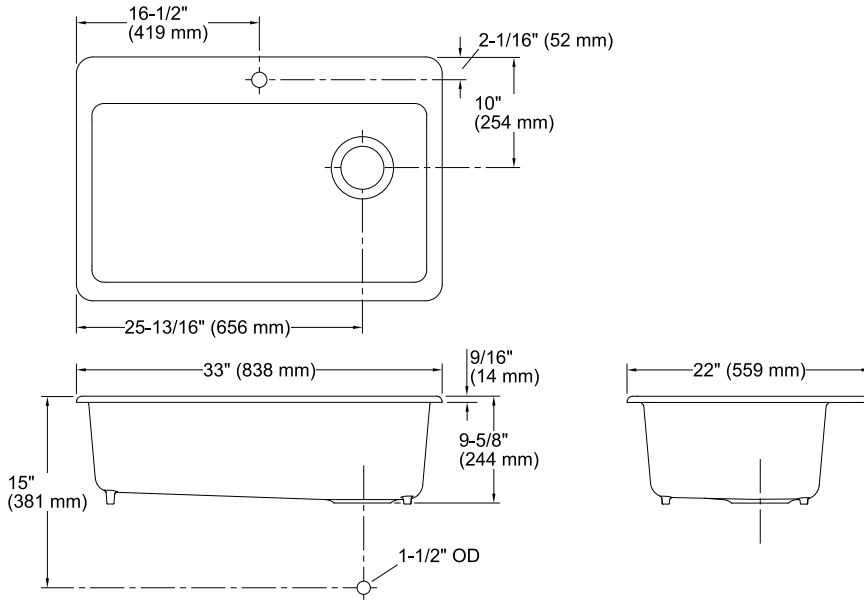

## Technical Information

All product dimensions are nominal.

Bowl configuration:	Single
Installation:	Top-mount
Min. base cabinet width:	33" (838 mm)
Bowl area (Only):	Length: 30-1/4" (768 mm) Width: 15-13/16" (402 mm) Bowl depth: 9" (229 mm)
Number of deck holes:	1
Faucet hole(s):	1-3/8" (35 mm)
Drain hole:	3-7/8" (98 mm)
Template:	1166727-7, required, included

## Notes

Install this product according to the installation instructions.

**NOTICE:** Countertop manufacturer or cutter must use the cut-out template provided with the product, or a current one provided by Kohler Co. (call 1-800-4-KOHLER). Kohler Co. is not responsible for cutout errors when the incorrect cut-out template is used.