



Memoirs® Stately

Drop-in Bathroom Sink
K-2337-1

Features

- Single faucet hole.
- Elegant rectangular basin.
- Overflow drain.
- Coordinates with other products in the Memoirs collection.

Material

- Vitreous china.

Installation

- Drop-in.

Recommended Products/Accessories

- K-8998 P-Trap
- K-23726 Drain treatment
- K-23725 Cast iron cleaner



ADA **CSA B651** **OBC**

Codes/Standards









ASME A112.19.2/CSA B45.1
ADA
ICC/ANSI A117.1
CSA B651
OBC

KOHLER® One-Year Limited Warranty

See website for detailed warranty information.

Available Colors/Finishes

Color tiles intended for reference only.

Color	Code	Description
	0	White
	96	Biscuit
	NY	Dune
	95	Ice™ Grey
	G9	Sandbar
	K4	Cashmere
	58	Thunder™ Grey
	7	Black Black™

1-800-4KOHLER (1-800-456-4537)

Kohler Co. reserves the right to make revisions without notice to product specifications.
For the most current Specification Sheet, go to www.kohler.com.

THE BOLD LOOK
OF **KOHLER**®

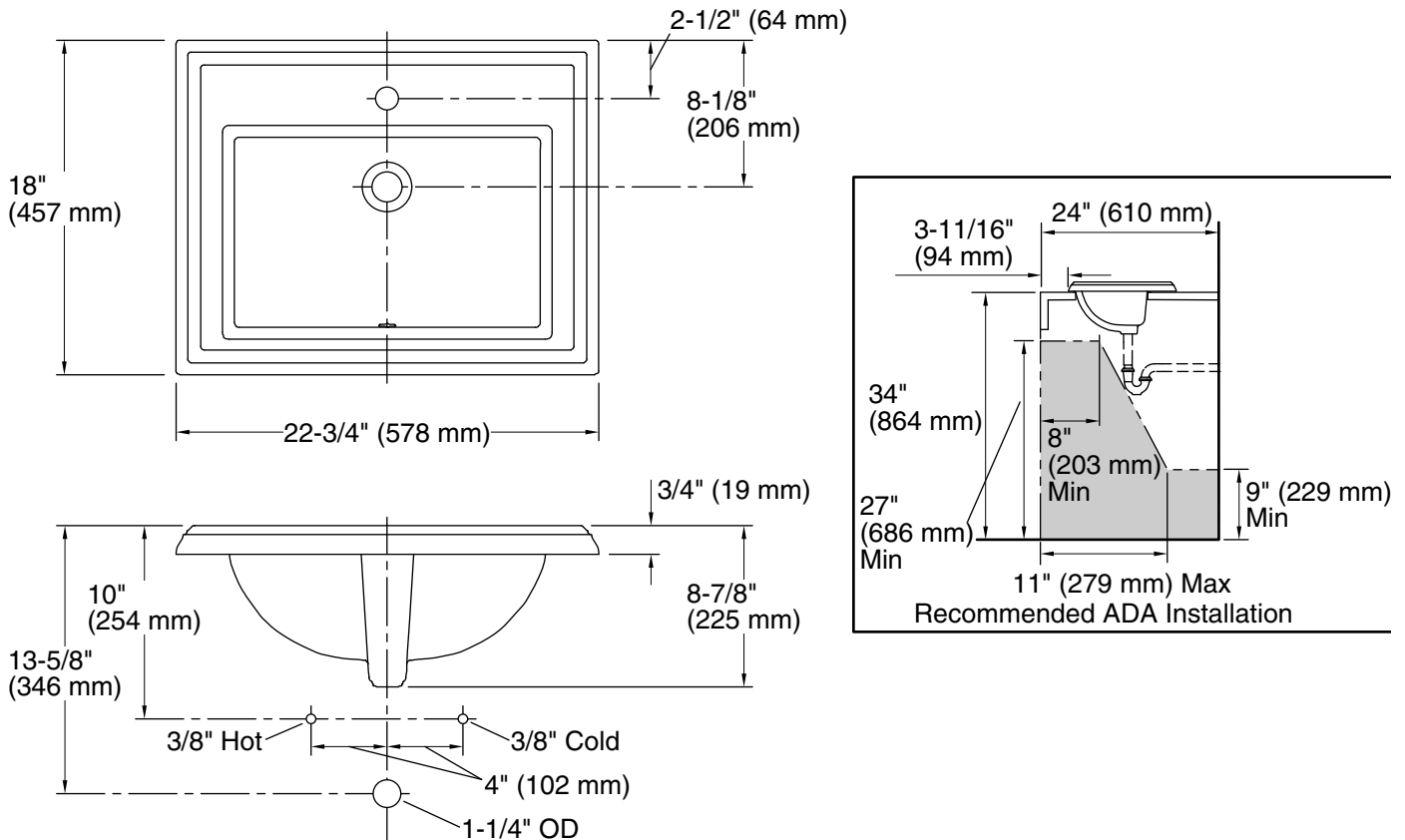

Technical Information

All product dimensions are nominal.

Bowl configuration:	Single
Installation:	Drop-in
Bowl area (Only):	Length: 17" (432 mm) Width: 10" (254 mm) Water depth: 5" (127 mm)
Number of deck holes:	1
Faucet hole(s):	1-3/8" (35 mm)
Drain hole:	1-3/4" (44 mm)
Template:	1003676, required, included

Notes

Install this product according to the installation instructions.

NOTICE: Countertop manufacturer or cutter must use the cut-out template provided with the product, or a current one provided by Kohler Co. (call 1-800-4KOHLER). Kohler Co. is not responsible for cut-out errors when incorrect cut-out template is used.

ADA, OBC, CSA B651 compliant when installed to the specific requirements of these regulations.