



## Medicine Cabinet K-CB-CLC3026FS

### Features

- Two adjustable tempered-glass shelves offer additional bathroom storage.
- Double doors with full-overlay beveled mirrors.
- Mirrored interior.
- Two-way adjustable hinges with 108° opening capability for easy cabinet access.
- Can be installed with left- or right-hand swing.
- Includes mounting hardware for surface or recessed installation.
- Includes side mirror kit for surface mount installation.

### Material

- Anodized aluminum construction with a durable rust-proof and chip-resistant finish.
- Anodized aluminum construction with a durable rust-proof and chip-resistant finish.

### Recommended Products/Accessories

K-23723 Faucet cleaner



### Codes/Standards

None Applicable

### KOHLER® One-Year Limited Warranty

See website for detailed warranty information.

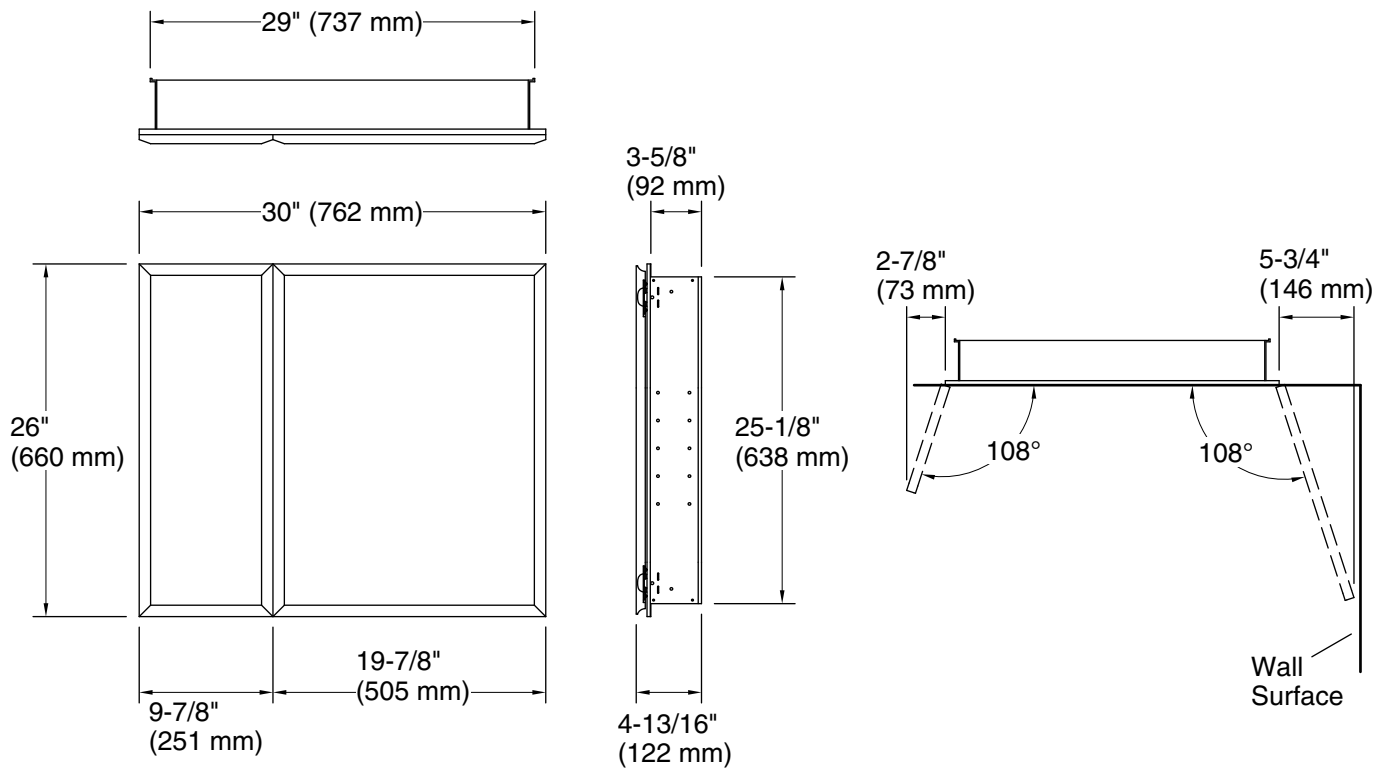

### Technical Information

All product dimensions are nominal.

### Notes

Install this product according to the installation guide.

When determining the height of the medicine cabinet, ensure the mirrored door will clear all obstacles (such as a faucet). A minimum distance of 2" (51 mm) is required.

Secure the screws (provided) to a stud to avoid possible property and product damage. If this is not possible, anchors (not provided) must be inserted before installing the screws.

This cabinet is designed for either right or left door swing. Check for obstructions.

Cutout for recess-mount installation:  
29-1/4" (743 mm) width x 25-1/4" (641 mm) height x 3-5/8" (92 mm) depth.