

Peak PKX11028 Stainless Steel

Exceedingly attractive. Exceptionally crafted in 16 gauge stainless steel. The perfect harmonization of minimalist style and maximum performance makes the Peak sink truly innovative. Each element is fashioned to excel in both form and function to create complete design symmetry. Aesthetically pleasing and remarkably functional, the Peak sink collection brings unparalleled style and utility to any kitchen.

Product Picture



Technical Drawing

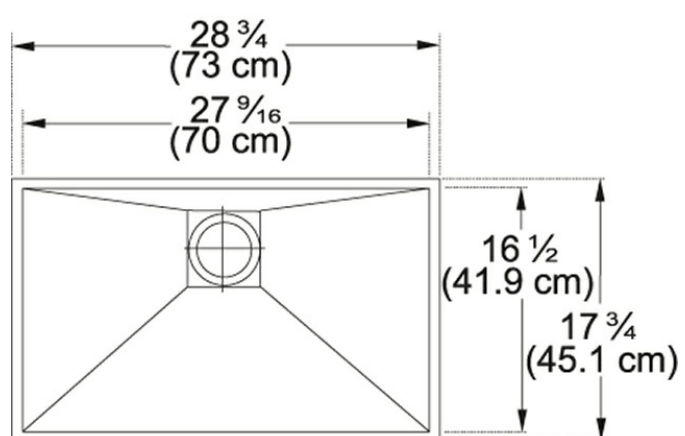

Product Dimensions

Length overall	28 3/4"
Width overall	17 3/4"
Length of large bowl	27 9/16"
Width of large bowl	16 1/2"
Depth of large bowl	9 5/8"
Minimum Cabinet Size	33"

General Information

Type of Material	16 Gauge Stainless Steel
Number of Bowls	1
Installation Clips	Yes
Cut-Out Template	Yes
Franke Integral Ledge	BUILT-IN
Where to buy	Showroom

Article Numbers

FUN#	122.0074.954
US Part Number	PKX11028

