

QS20

Est. 2002 | Vol. 5

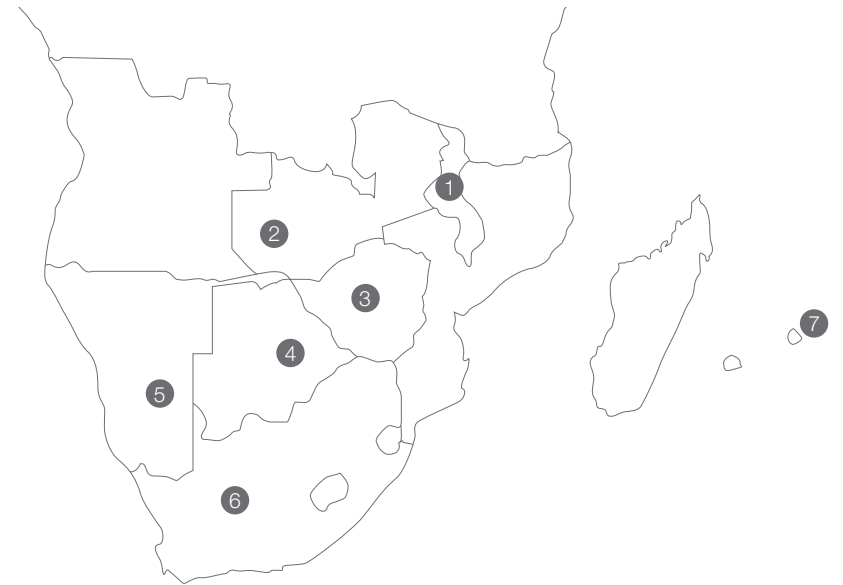



QS products was created as a joint venture in 2002 by Andrew Osborne-Young and Martin Humphry to supply the South African market with affordable stainless steel ironmongery and reasonably priced door controls.

The signature range of stainless steel door handles is supported by a full complement of stainless steel accessories, locks, cylinders, hinges, and hydraulic door controls. All products are covered by a 5-year warranty and are available on an ex-stock basis. The overhead, surface mounted, door controls have a full fire certification for all applications. We have sold more than a million units since conception.

QS is one of the largest suppliers of stainless steel ironmongery in South Africa and in 2022 celebrated its 20-year anniversary.

QS DISTRIBUTION MAP

1. *Malawi*
2. *Zambia*
3. *Zimbabwe*
4. *Botswana*
5. *Namibia*
6. *South Africa*
7. *Mauritius and Indian Ocean islands*

6
lever handles

28
knob handles

30
coupé handles

36
residence lock

38
pvd range

48
black range

58
origine range

64
pull handles

78
locks

86
cylinders

92
hinges

98
accessories

114
door controls

134
panic hardware

140
bathroom accessories

150
access control

154
contact details

ESCUTCHEONS + ROSES



QS4402 **QS4403** **QS4472** **QS4473** **QS4402** **QS4403** **QS4472** **QS4473**
 flush flush flush flush flush flush flush flush

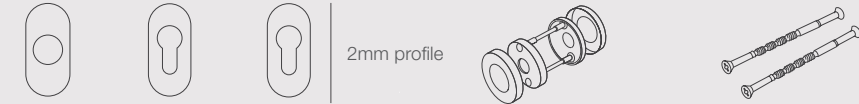

QS4427 **QS4405** **QS4407** **2mm profile** **QS4499.COM** **QS4493**
 with tamper proof lugs for commercial projects male and female screws

PLATES

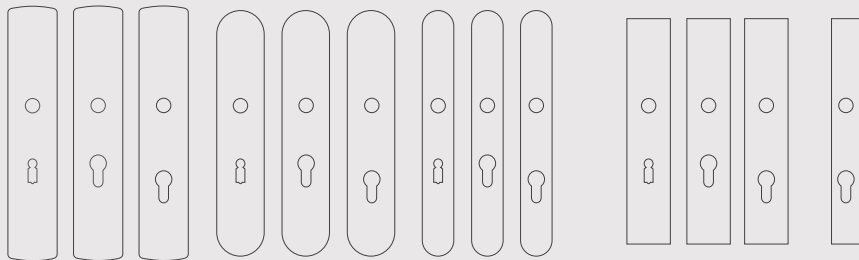

QS4482 **QS4484** **QS4483** **QS4429** **QS4428**
 KH 254x50x57mm KH 245x45x57mm KH 245x36x57mm KH 225x40x57mm CYL
 CYL 254x50x60mm CYL 245x45x60mm CYL 245x36x60mm CYL 225x40x60mm 225x28x85mm
 CYL 254x50x85mm CYL 245x45x85mm CYL 245x36x85mm CYL 225x40x85mm

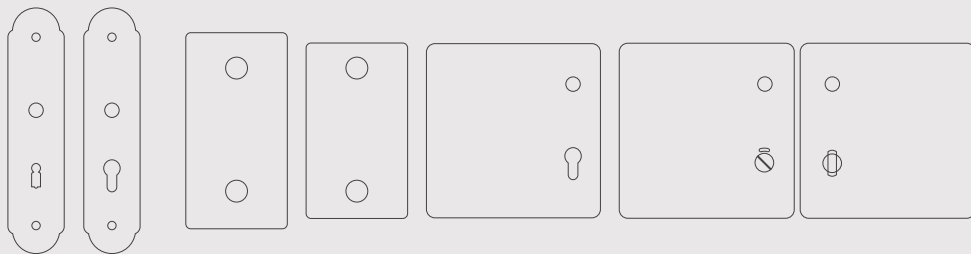

QS4489 **QS4487** **QS4486** **QS4485** **QS4485**
 KH 200x48x57mm 190x100mm 170x100mm 170x170mm with WC indicator
 CYL 200x48x60mm supplied with supplied with
 QS2205/1 QS2203/1

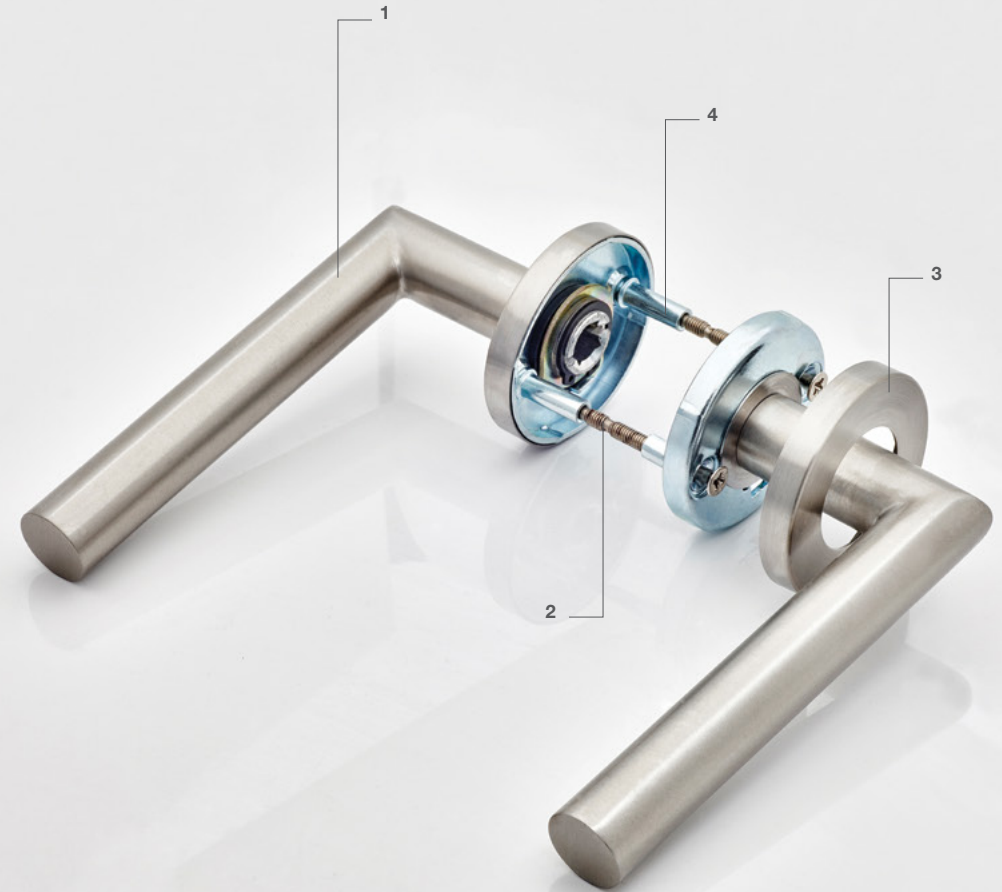

COMMERCIAL ROSE + ESCUTCHEON

The combination of the QS heavy duty handle and .com roses are designed for high traffic commercial buildings and will stand up to the most physically demanding situations. Tested to 250 000 cycles.

1. 0.2mm increase in material thickness over market standard
2. Threaded lug for bolt through fitting, essential on self-closing doors
3. Circular satin finish on rose and escutcheon
4. Tamper-proof fixed locating lugs for added security and to assist in accurate fitting and a firm feel to the handle

lever handles



lever handles



OSLO
Tube handle

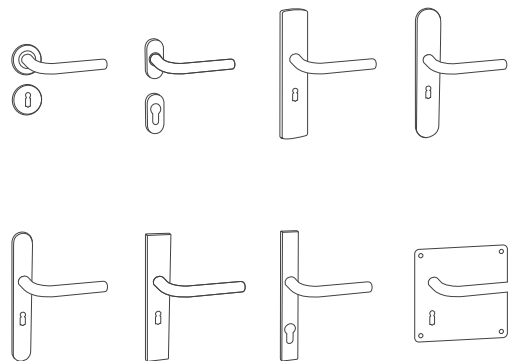

INARI
Tube handle

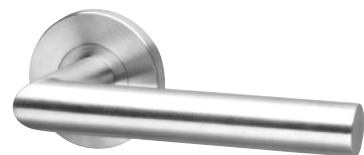
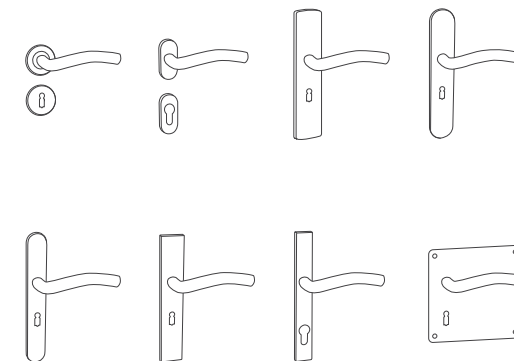

OULU
Tube handle

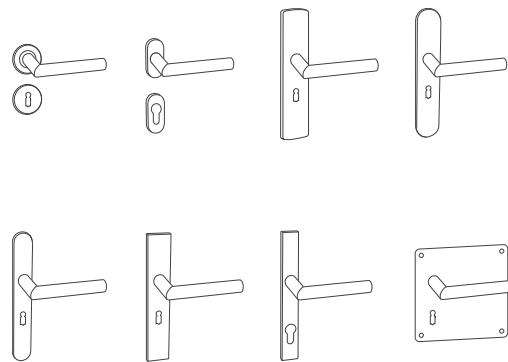

UMEA
Tube handle

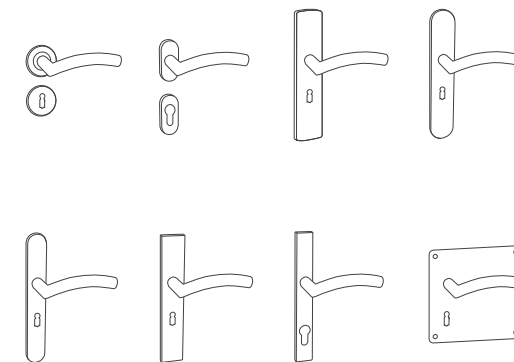

BODO
Tube handle

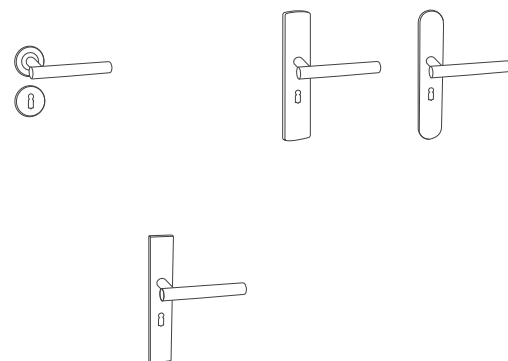

VAASA
Tube handle

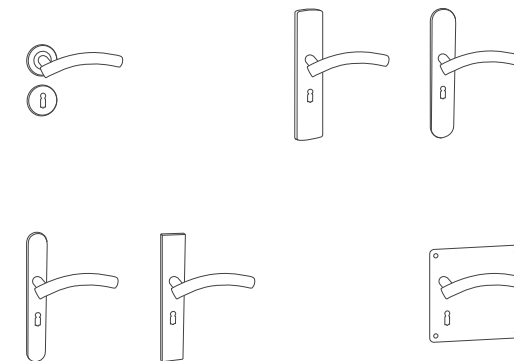

lever handles



KIRUNA
Tube handle

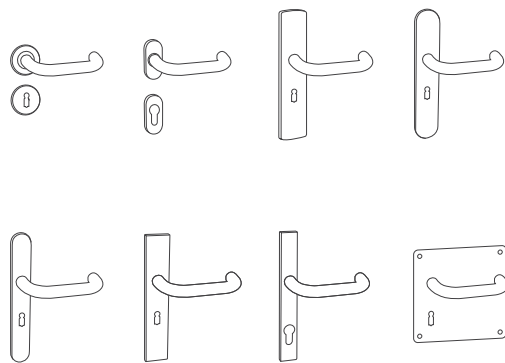

NAMSOS
Tube handle

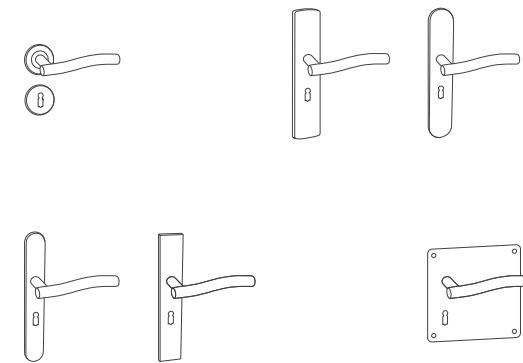

TURKU
Tube handle

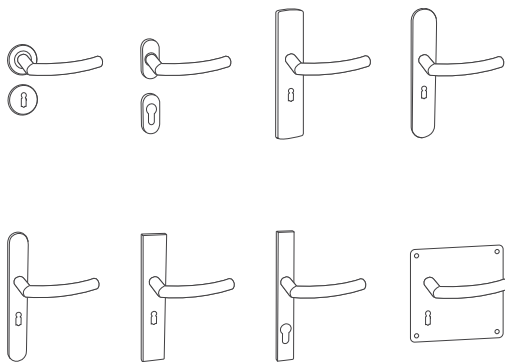

LULEA
Tube handle

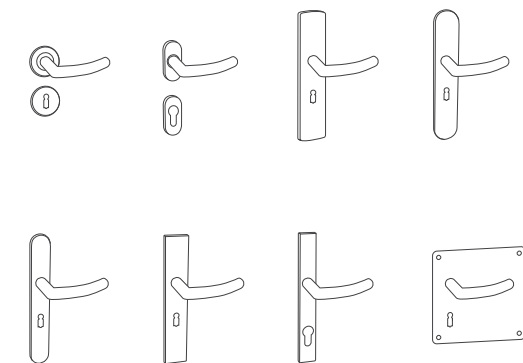

ARHUS
Tube handle

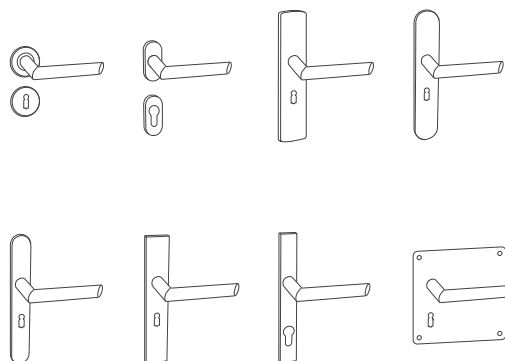

PELLO
Form handle
Available in PVD
Available in black

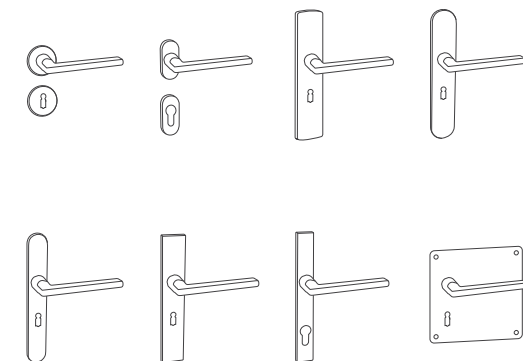

lever handles



SAMBAVA
Form handle

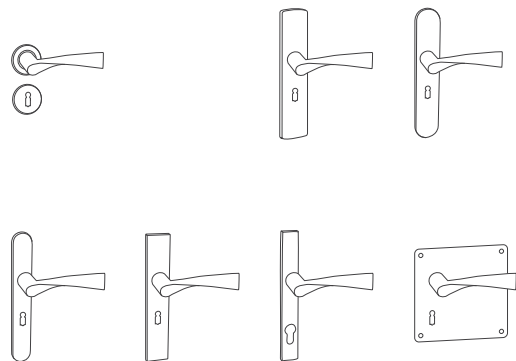

MOLO
Form handle
Available in black

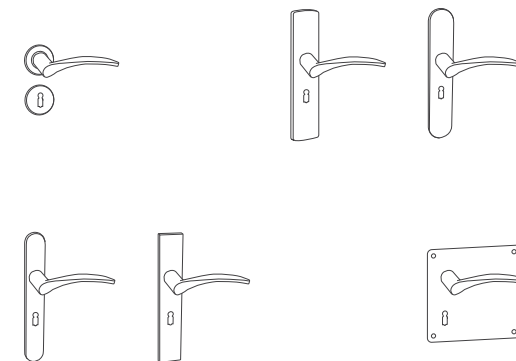

LAMU
Form handle
Available in PVD
Available in black

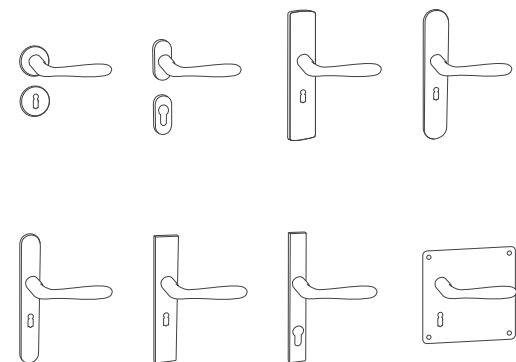

RIGA
Form handle
Available in PVD

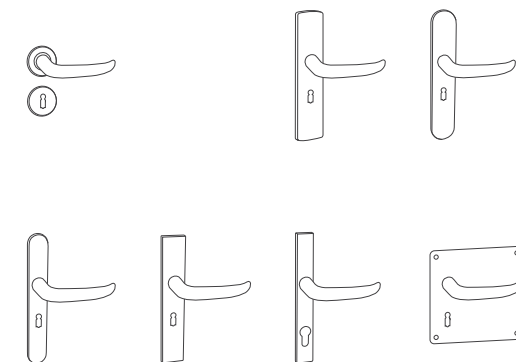

BORAS
Form handle
Available in PVD

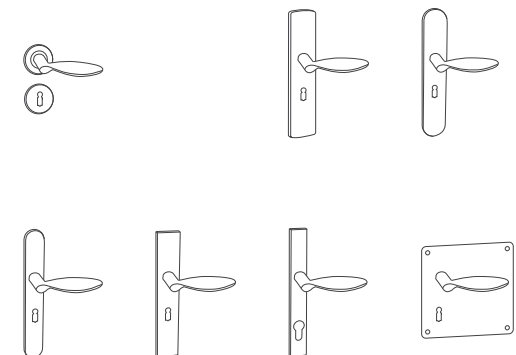

TUVU
Form handle

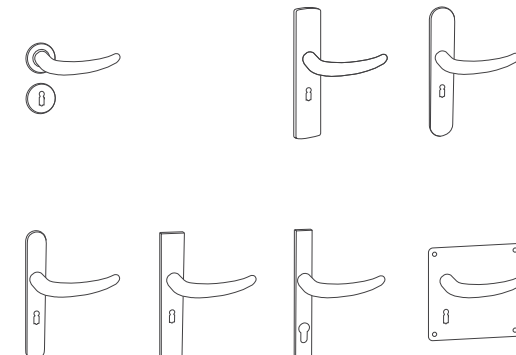

lever handles



MORA
Form handle
Available in PVD

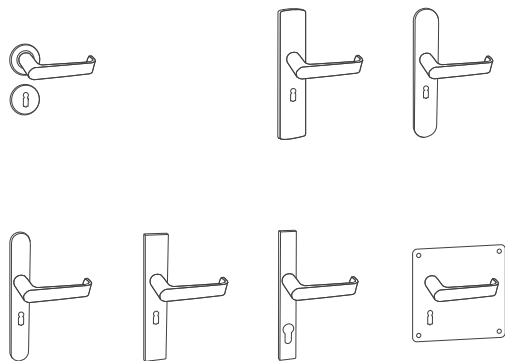

LOJO
Form handle

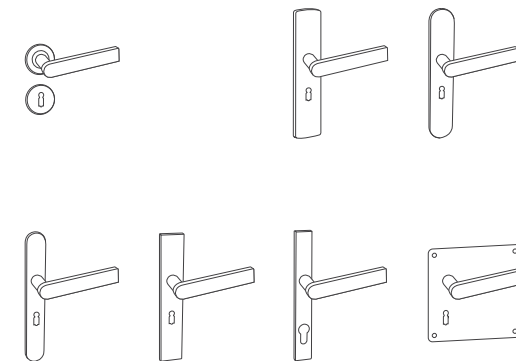

FALON
Form handle

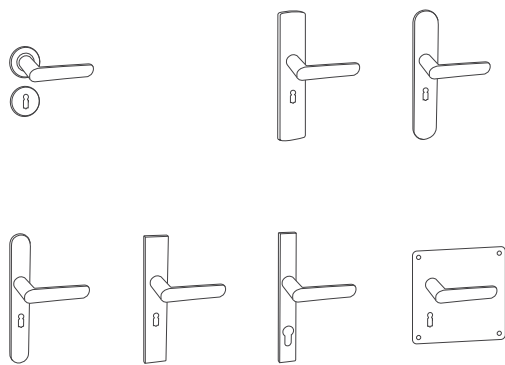

SKIEN
Form handle
Available in PVD

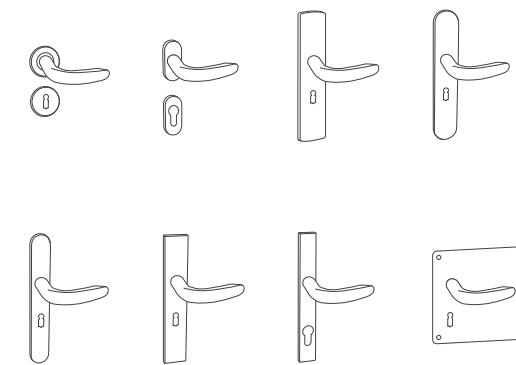

FOSSE
Form handle

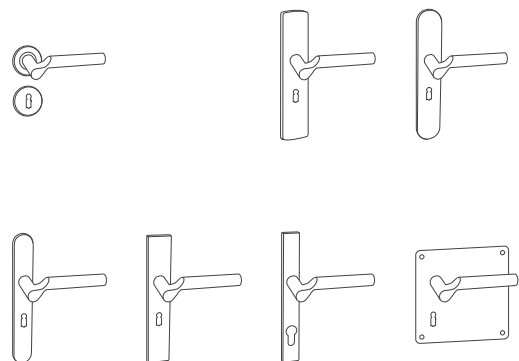

CHAMA
Form handle

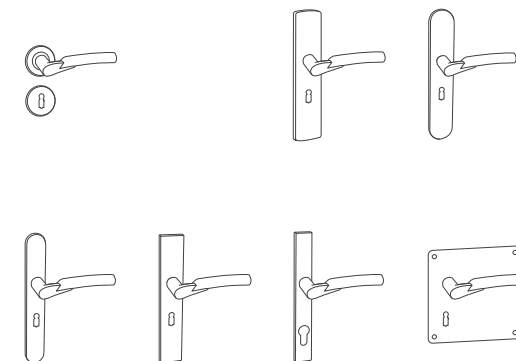

lever handles



MALMÖ
Form handle

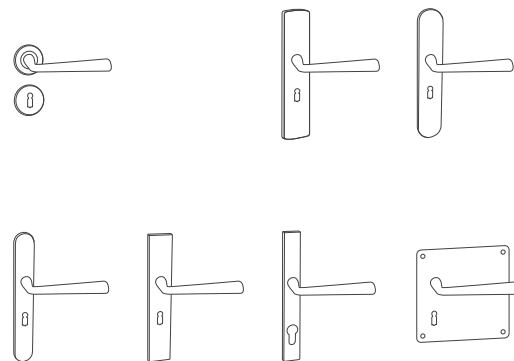

FLEN
Form handle

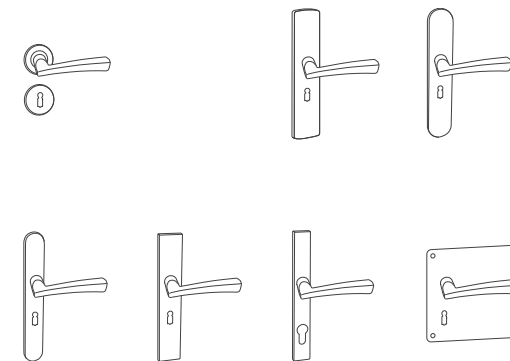

ALTA
Form handle

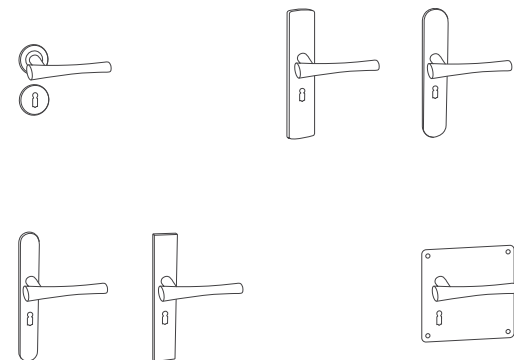

EKERO
Form handle

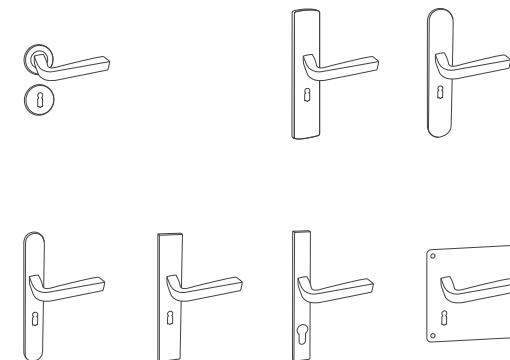

BERGEN
Form handle

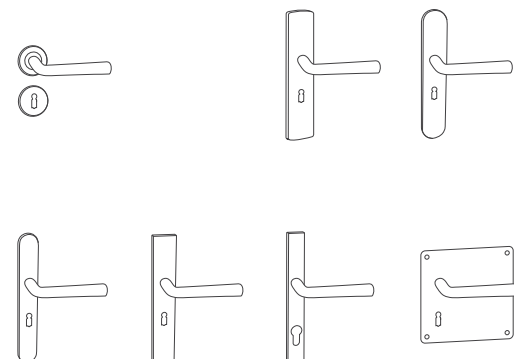

HOLEN
Form handle

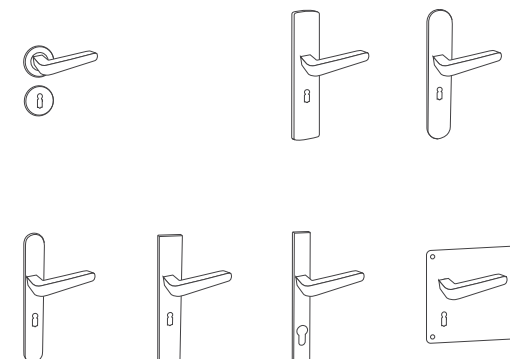

lever handles



KARIS
Form handle
Available in PVD
Available in black

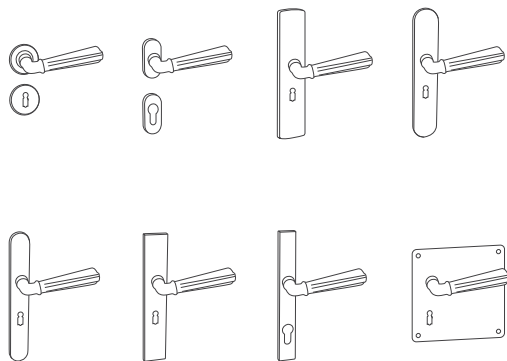

NARVICK
Form handle
Available in black

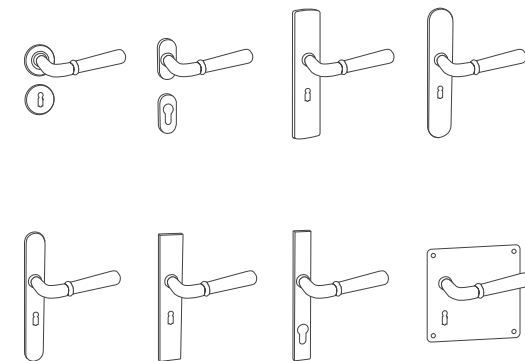

SALO
Form handle
Available in PVD
Available in black

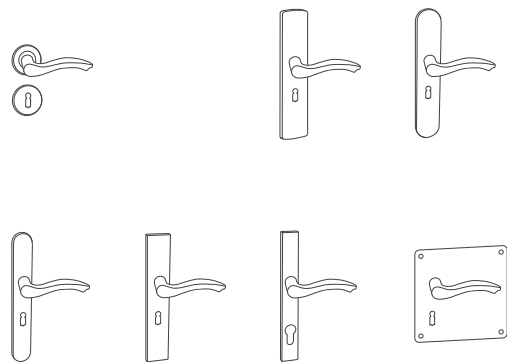

KRONE
Form handle
Available in black

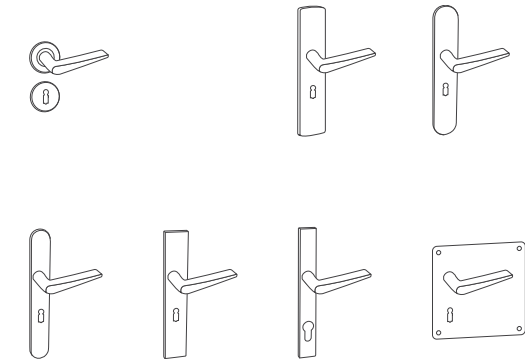

FLORO
Form handle

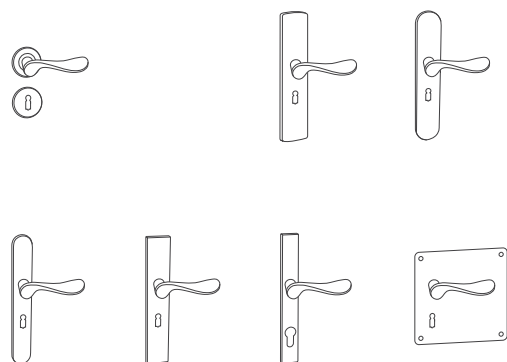

LUND
Form handle

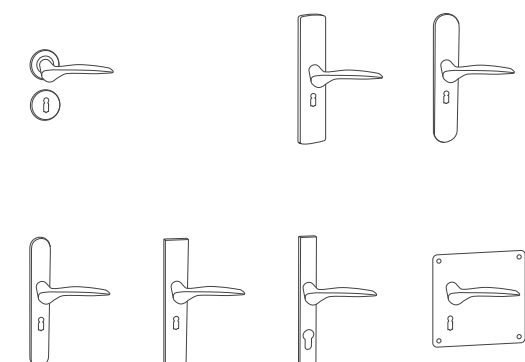

lever handles



NEXO
Form handle

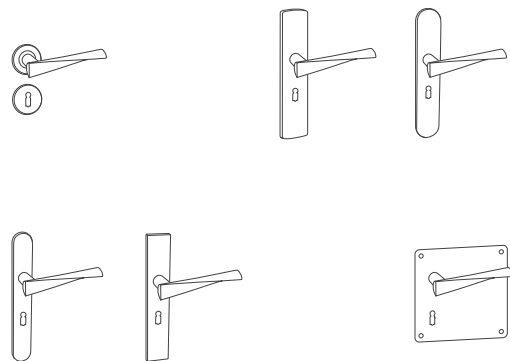

OTTA
Form handle

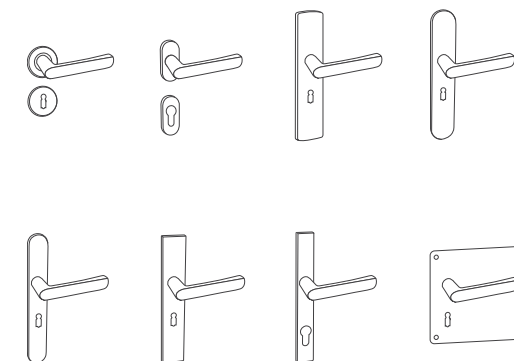

SKI
Form handle

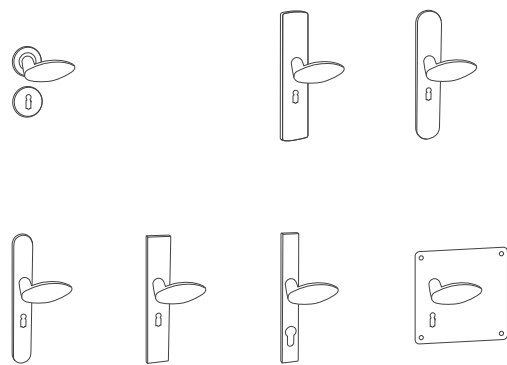

FINN
PVC tube handle

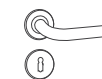

MOSS
Form handle

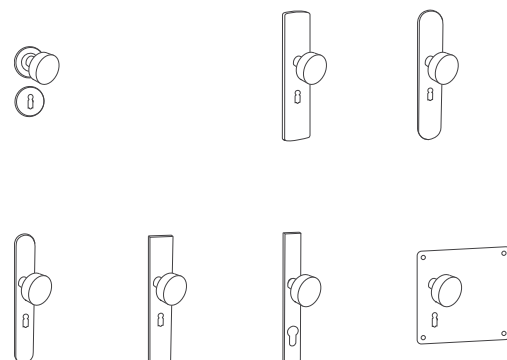

lever handles



JUNIPER
Solid handle
Available in PVD

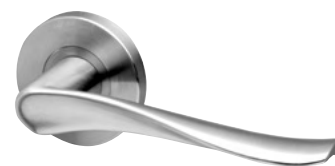
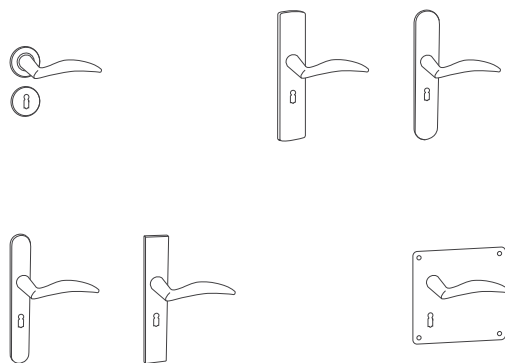

NYBRO
Solid handle

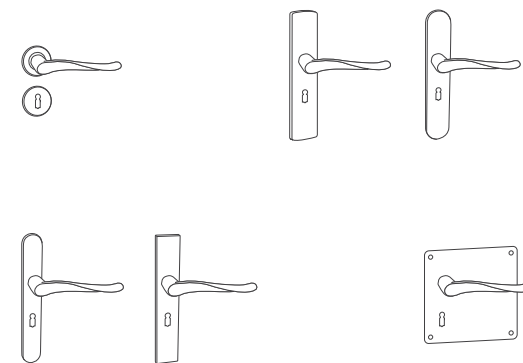

MOLO
Solid handle
Available in PVD

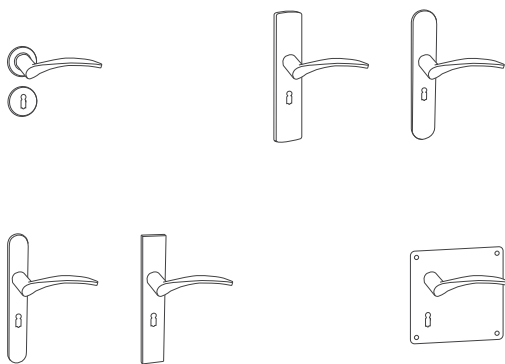

SAMBAVA
Solid handle
Available in PVD

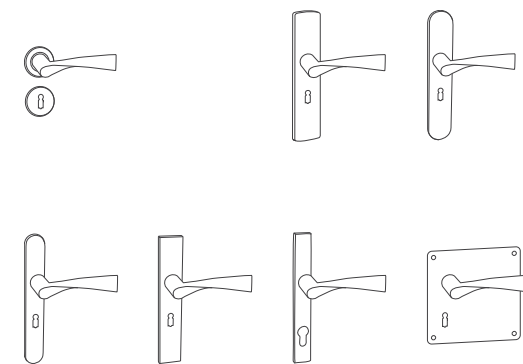

MALINDI
Solid handle

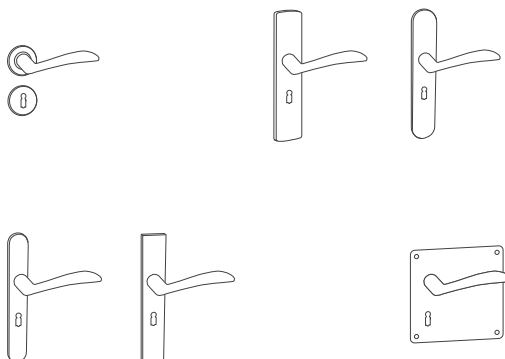

MOROMBE
Solid handle

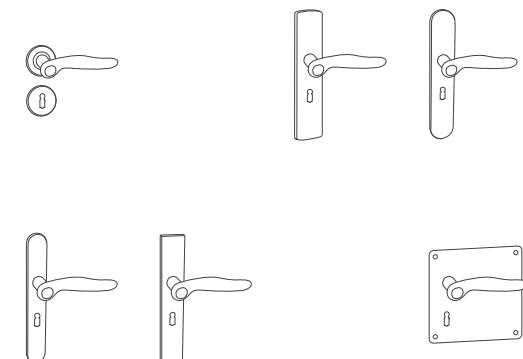

lever handles



MILA
Solid handle

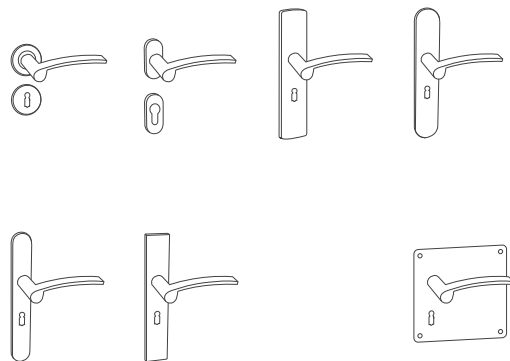

KRUSA
Solid handle

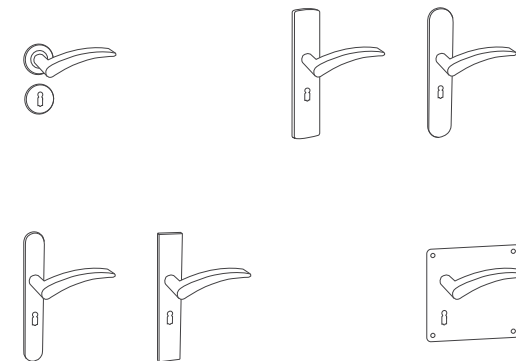

SANDA
Solid handle

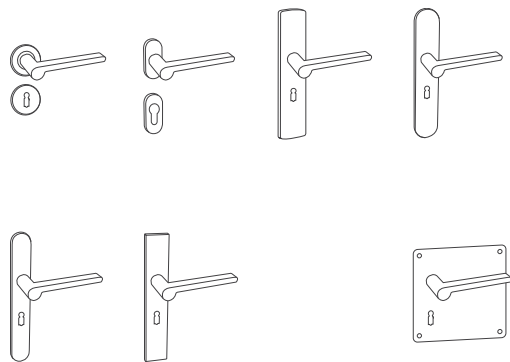

ARIEL
Solid handle

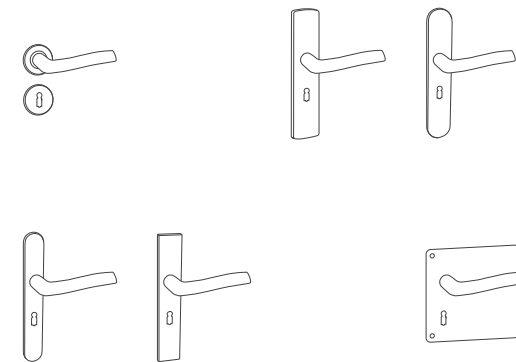

KALMAR
Solid handle

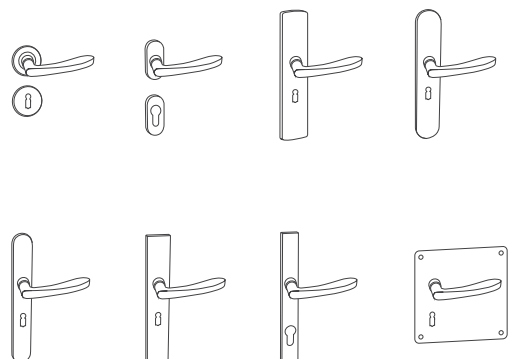

ALBOURG
Solid handle

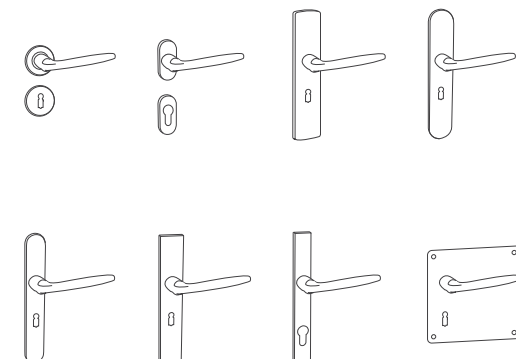

lever handles



KOTKA
Square handle

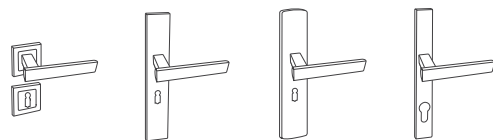

SIRA
Square handle

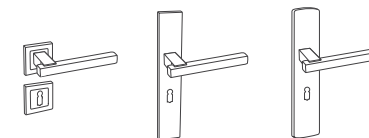

LAHTI
Square handle

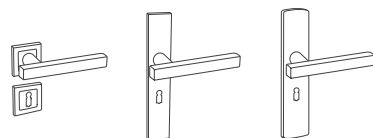

KOLARI
Square handle

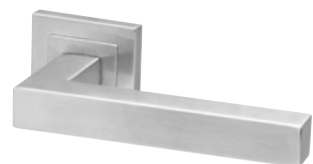
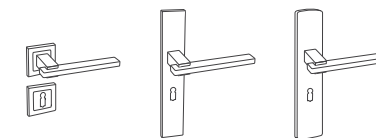

DALA
Square handle
Available in black

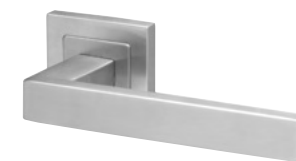
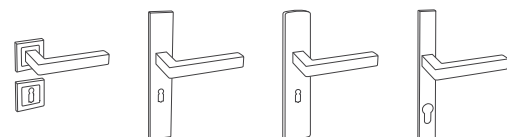

LYA
Square handle

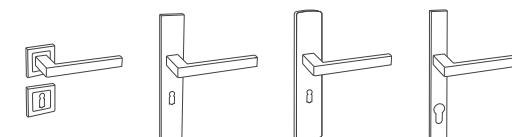

HELSINKI
Square handle

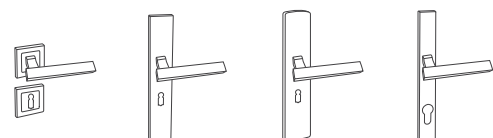

NUUK
Square handle
Available in black

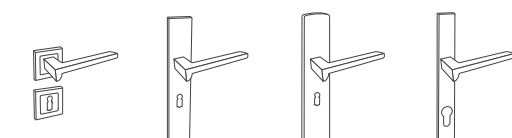

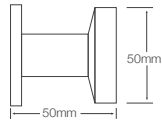

QS3805
Knob handle

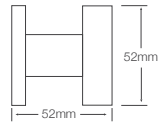

QS3810
Rotating knob handle

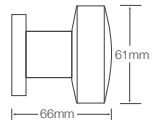

QS3815
Knob handle

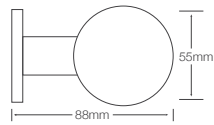

QS3820
Knob handle

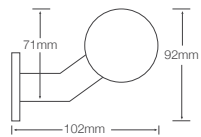

QS3825
Knob handle



coupé handles

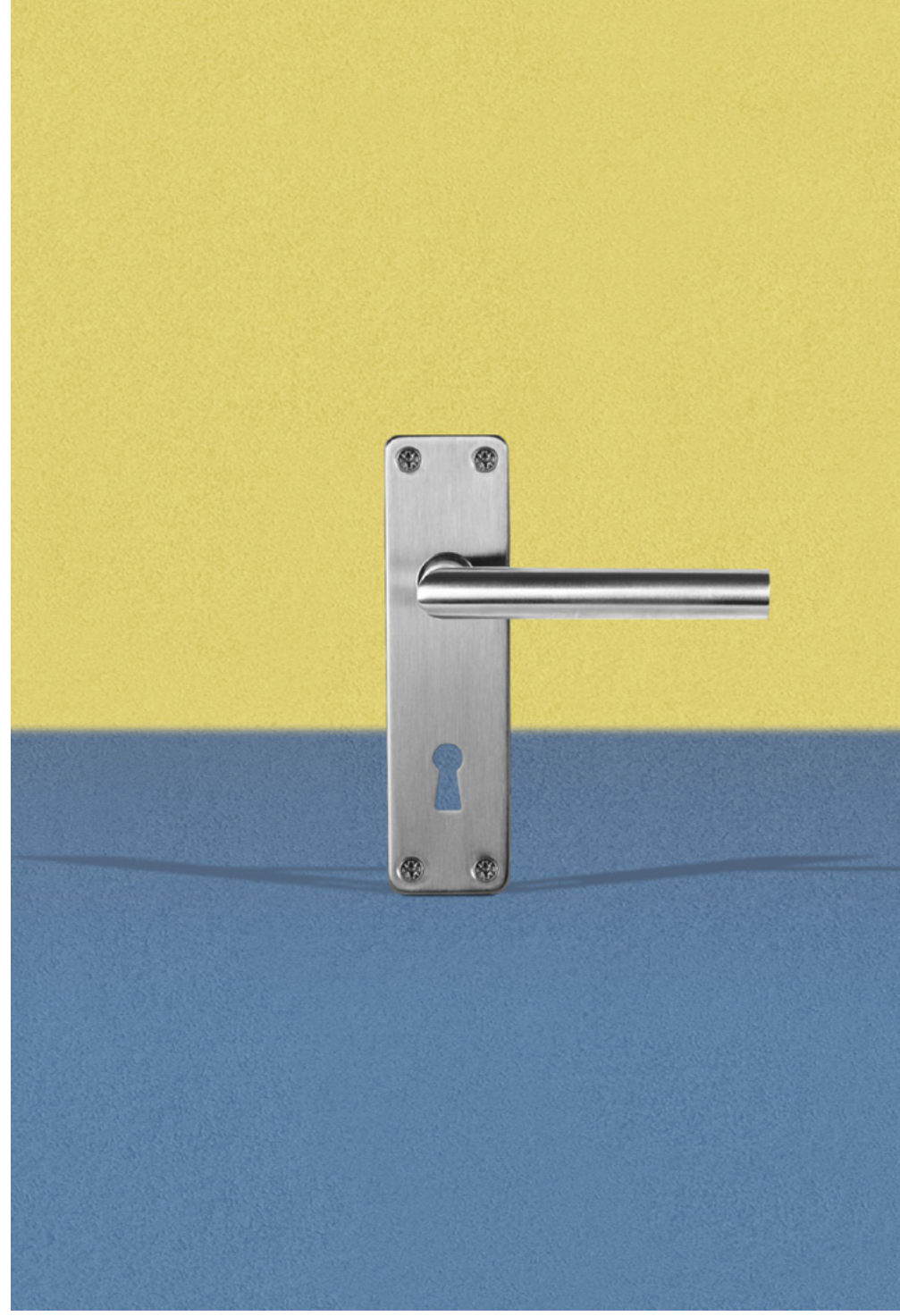



COUPÉ OSLO



COUPÉ UMEÅ



COUPÉ OULU



COUPÉ INARI



COUPÉ SOLNA

150x40x57mmKH
150x40x60mmCYL

Coupé handles available on all QS back plates or roses with escutcheons in keyhole or cylinder. Ø 16mm diameter



COUPÉ VAASA

150x40x57mmKH
150x40x60mmCYL



COUPÉ NAMSOS



COUPÉ KIRUNA

150x40x57mmKH
150x40x60mmCYL

Coupé handles available on all QS back plates or roses with escutcheons in keyhole or cylinder. Ø 16mm diameter

+



All locksets include QS5757J/2L

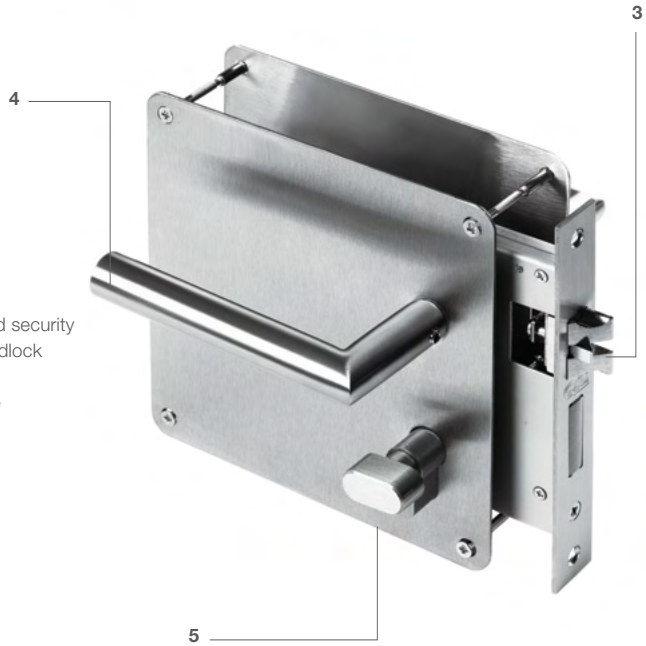
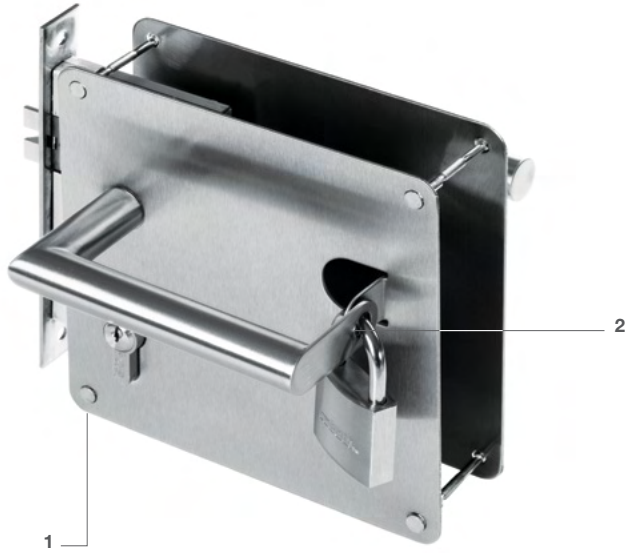

QS4485 RESIDENCE LOCK

- 1. Blank exterior screwhead for added security
 - 2. "Hasp and latch" provided for a padlock
 - 3. QS6055/1 drawback latch lock
 - 4. Oulu lever handle on QS4485 plate
 - 5. Keyed-alike QS1108 knob cylinder
- Padlock not included



pvd range

PVD (Physical Vapour Deposition) is an environmentally-friendly coating process carried out under a vacuum and, in most cases, at temperatures between 150 and 500°C. In the PVD process the high purity, solid coating material (metals such as titanium, chromium and aluminium) is either evaporated by heat or by sputtering (bombardment with ions). At the same time, a reactive gas such as nitrogen is added; it forms a compound with the metal vapour which is deposited on the tools or components as a thin, highly adherent coating. A uniform coating thickness – six times stronger than electroplating – is obtained by rotating the parts at a constant speed about several axes.

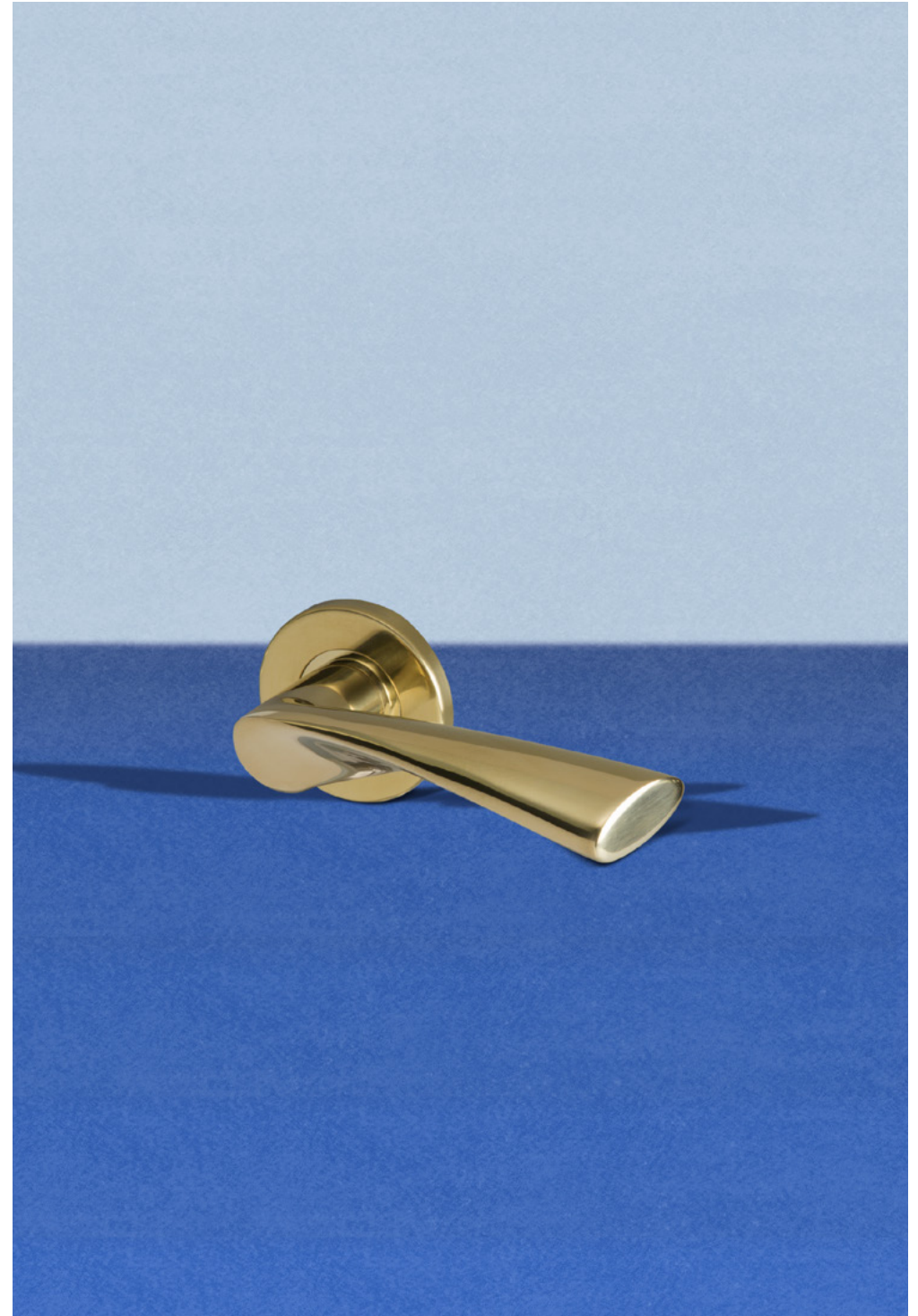



MOLO



SAMBAVA

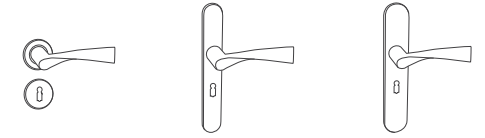

JUNIPER

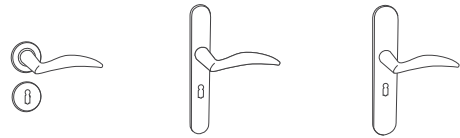

KARIS

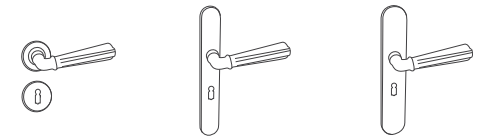

PELLO



SALO



LAMU

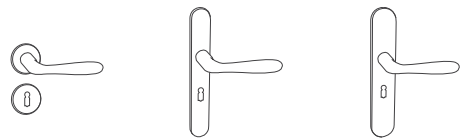

BORAS





SKIEN



T HANDLE
Back-to-back

	D	C	L
QS2503	22	125	200
QS2507	30	300	400



RIGA



QS1102SB
40mm



QS1108SB / SINGLE
Knob cylinder
40mm



QS1103SB 60mm
QS1104SB 66mm
QS1105SB 70mm
QS1109SB 80mm



QS1108SB
Knob cylinder
66mm



MORA



The full QS6055 series is available in PVD including latch, roller + deadbolt



QS4412/1
150x100x3mm

QS4412/2
180x100x3.5mm

QS4412/3
200x100x3.5mm

QS4412/4
230x100x3.5mm



QS4415
100x76x3mm

QS4417
100x76x2mm



QS700DA/2
EN1154 fire rated
Delayed-action
5 year warranty
*Also available in a standard
QS700 and QS750*



QS4413
Ring pull
63x44mm



QS4426
Ring pull
48x38mm



QS6001
Adjustable rollerbolt



QS4418
Oval flush pull
120x40mm



QS4419
Flush pull
102x51mm



QS4422
Hooded door stop



QS4410
Coin release WC thumbturn



QS4467
Door viewer

black range





PELLO

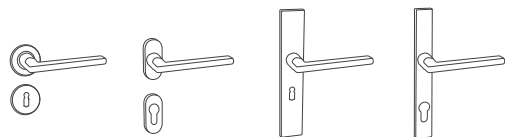

NARVICK

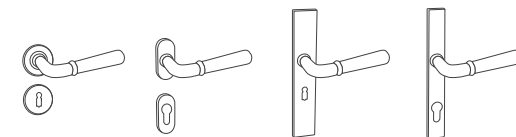

KRONE

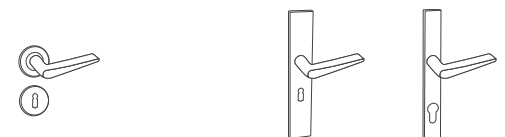

KARIS

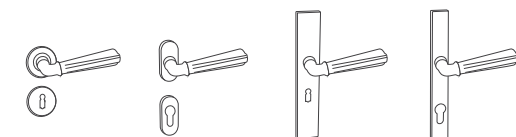

LAMU

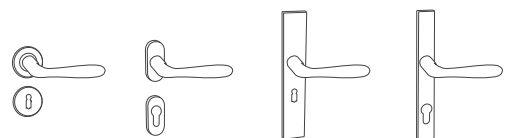

SALO

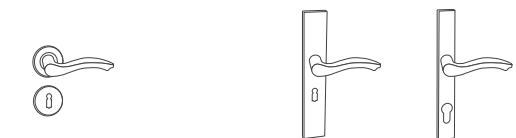



MOLO

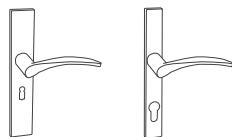
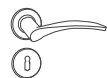

DALA

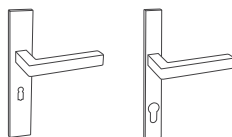
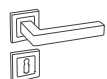

NUUK

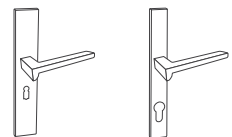

QS4428
Narrow style plate



QS4429
Rectangular plate
Available in CYL + KH

Handles and plates sold separately



MITRED T-HANDLE

	D	C	L
QS2701	30	500	600



SQUARE SECTION HANDLE

	D	C	L
QS2622	19	300	319



T-HANDLE

	D	C	L
QS2507	30	300	400



FALON D-HANDLE

	D	C	L
QS2604	25	300	325



PELLO HANDLE

	D	C	L
QS2627	-	225	250



QS4415
Grade 13 hinge
100x76x3mm



QS4419
102x51mm



QS4422
Door stop



QS4462
Floor mounted magnetic door stop



QS1108
66mm

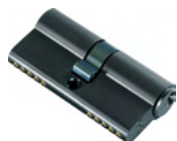

QS1103
60mm



QS1102
40mm



QS680/4
EN1154 fire rated
5 year warranty



QS700DA/4
EN1154 fire rated
Delayed-action
5 year warranty

Door closers available with QS7703/1 slide channel

origine range





ARLES



MELLE



RODEZ



SALERS

Handle supplied with KH escutcheons



BELLAC



BELLAC PEUTER



QS1801
Door knocker



QS1802
Door latch



QS1803
Door bolt



QS1804/1
Oval pull



QS1804/2
Rectangular pull



QS1804/3
Oval pull



QS1804/4
Rectangular pull

pull handles

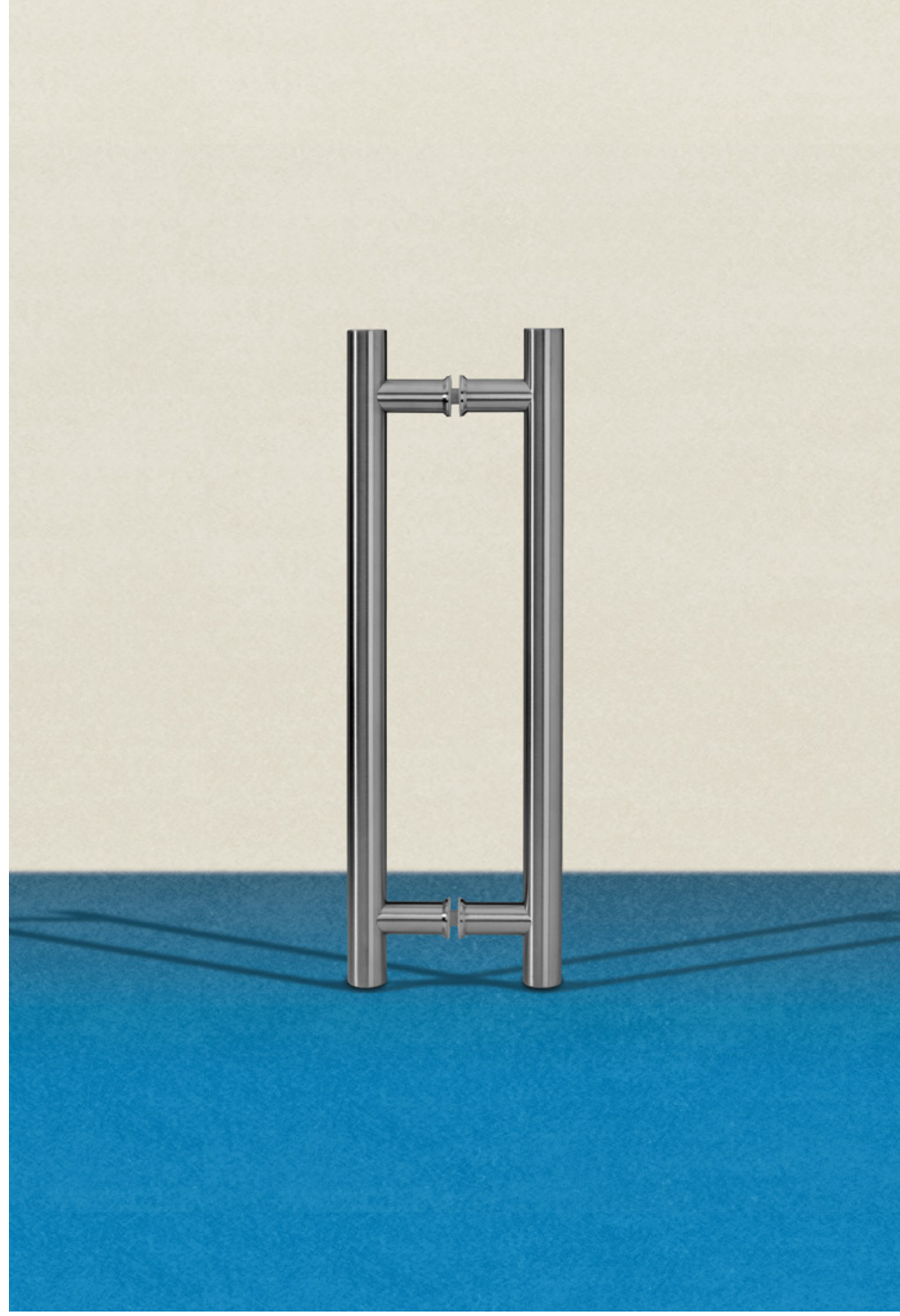

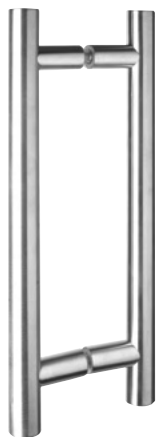

T HANDLE

Back-to-back (also available in BoltThru)

	D	C	L
QS2501	30	400	500
QS2502	25	350	500
QS2503	22	125	200
QS2506	30	200	300
QS2507	30	300	400
QS2508	25	900	1070
QS2509	30	1200	1800



CRANKED T HANDLE

Back-to-back

	D	C	L
QS2703	30	150	400

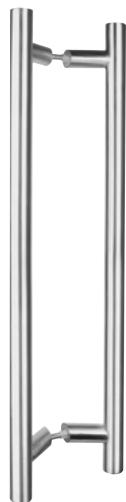

MITRED T HANDLE

Back-to-back

	D	C	L
QS2701	30	500	600
QS2702	25	350	400



SQUARE MITRED T HANDLE

Back-to-back

	D	C	L
QS2704	25	300	375





OVAL T HANDLE

Back-to-back

	D	C	L
QS2631	38x19	400	500



S HANDLE

Back-to-back

	D	C	L
QS2901	25	400	600
QS2902	30	400	600



OFFSET OVAL T HANDLE

Back-to-back

	D	C	L
QS2632	38x19	400	500

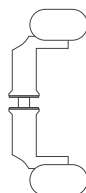



C HANDLE
Back-to-back

	D	C	L
QS2401	32	350	382



D HANDLE
Back-to-back
Also available in BoltThru

	D	C	L
QS2201	30	300	330
QS2203	19	130	
QS2204	19	200	



CRANKED D HANDLE
Back-to-back

	D	C	L
QS2301	30	300	330
QS2206	25	190	



SEMI C HANDLE
Back-to-back

	D	C	L
QS2801	30	350	420



CRESCENT HANDLE
Back-to-back
Also available in BoltThru

	D	C	L
QS2205	19	150	

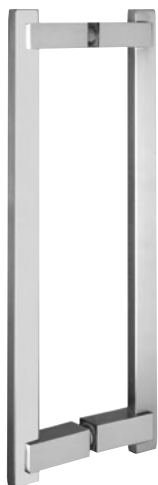

OBLONG SECTION HANDLE

Back-to-back

	D	C	L
QS2611	10x20	225	265
QS2612	10x20	300	340
QS2613	10x20	450	490
QS2614	10x20	600	640



ROUND SECTION HANDLE

Back-to-back

	D	C	L
QS2601	30	425	455
QS2602	25	300	325



SQUARE SECTION HANDLE

Back-to-back

	D	C	L
QS2621	19	225	244
QS2622	19	300	319
QS2623	19	450	469
QS2624	19	600	619



FALON HANDLE

Back-to-back

	D	C	L
QS2604	25	300	325



RECTANGULAR OBLONG HANDLE
Back-to-back

	D	C	L
QS2620	40x20	600	620



PELLO PULL HANDLE
Back-to-back

	D	C	L
QS2627	-	225	250



CRANKED ROUND SQUARE HANDLE
Back-to-back

	D	C	L
QS2603	30	350	380

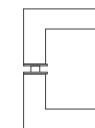

CRANKED SQUARE D HANDLE
Back-to-back

	D	C	L
QS2705	25	300	325

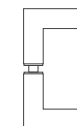

*We offer a range of custom length pull handles
up to 2000mm in the following profiles.
JHB only*

QS2510
38x<2000mm

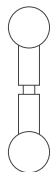

QS2526
20x40x<2000mm

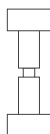

QS2525
40x40x<2000mm

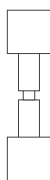

QS2633
(38x19) <2000mm

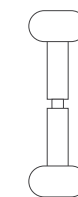

QS2634
(38x19) <2000mm

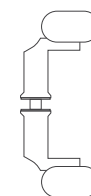

locks

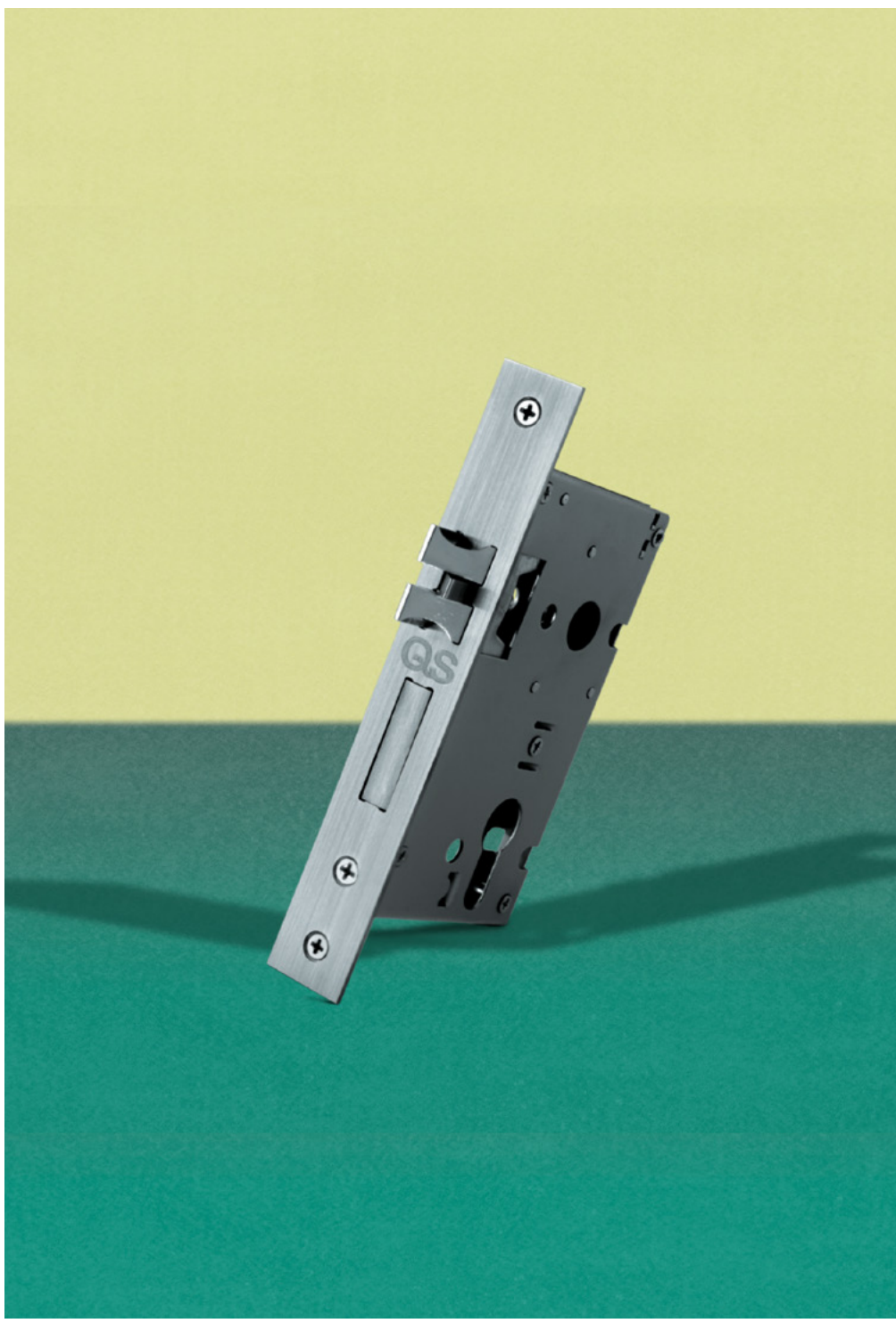



QS6055/1
Latch +
deadbolt
55mm backset
60mm centre

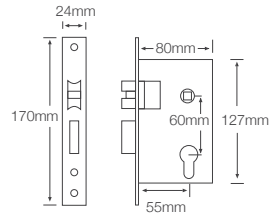

Silent latching
Heavy duty
Stainless steel forend

QS6055/3
Adjustable
rollerbolt +
deadbolt
55mm backset
60mm centre

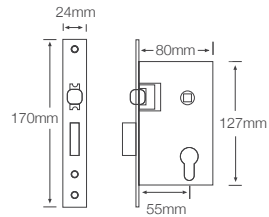

QS6055/4
Deadbolt
55mm backset

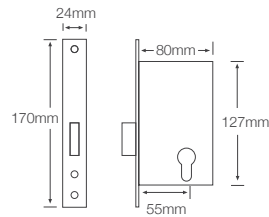

QS6010
Rebate kit

QS6055/5
Bathroom lock
55mm backset
60mm centre

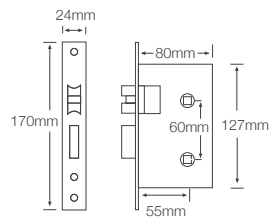

QS6000
Key insert with two keys for use with
any Euro profile lock



SABS
APPROVED
Stainless steel forend

QS5757
Stainless steel
forend – three lever
57mm backset
57mm centre

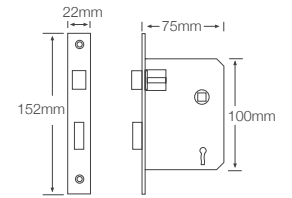

*QS5757A available with 170mm forend

QS5757/1
Cylinder latch lock
+ deadbolt
57mm backset
60mm centre

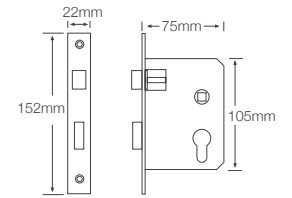

QS6057/4
Cylinder deadbolt
57mm backset

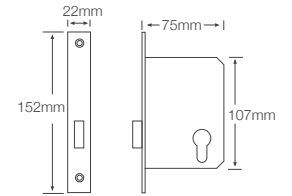

QS5757/5
Bathroom lock for
8mm spindle
57mm backset
57mm centre

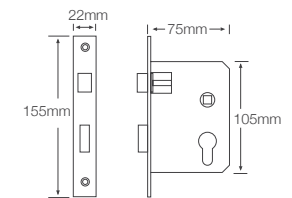

Locks are handed left or right by inverting and turning the latch

QS5757 rebate kit available



QS8555
Timber latch and
double throw
deadbolt
55mm backset
85mm centre

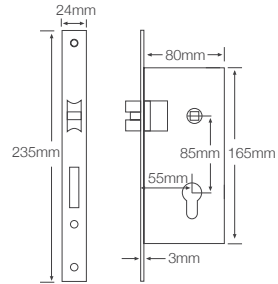

QS0055
Deadbolt
55mm backset

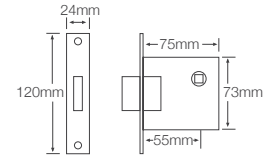

QS6001
Adjustable rollerbolt with
stainless steel catch
*Also available in satin
brass*

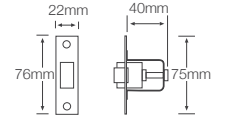

QS5757/2
two lever
57mm backset
57mm centre

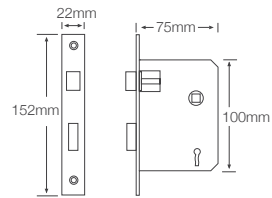

QS6002
Spring bolt

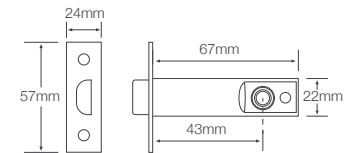



QS8525
Narrow style lock
25mm backset
85mm centre

QS8525/1
Latch + deadbolt

QS8525/3
Rollerbolt + deadbolt

QS8525/4
Deadbolt lock

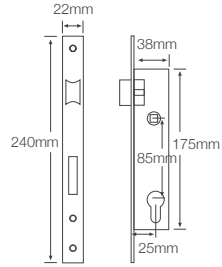

QS6225
Hook lock
25mm backset

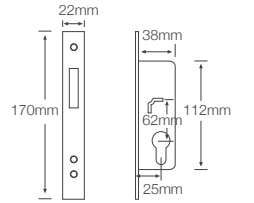

QS6235
Hook lock
35mm backset

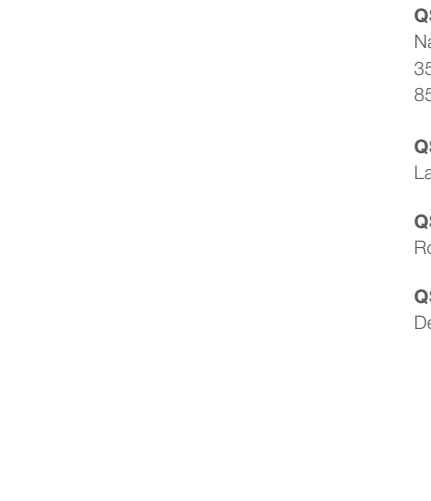
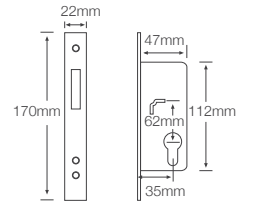

QS8535
Narrow style lock
35mm backset
85mm centre

QS8535/1
Latch + deadbolt

QS8535/3
Rollerbolt + deadbolt

QS8535/4
Deadbolt

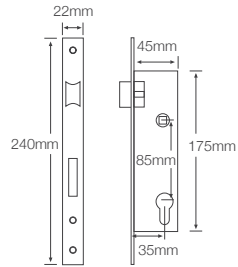

QS0025
Deadbolt
25mm backset

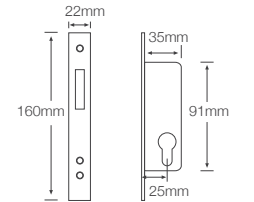

QS0035
Deadbolt
35mm backset

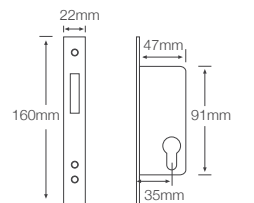

cylinders



S



SINGLE CYLINDER

QS1102SN
QS1102A
40mm



OVAL EMERGENCY KNOB CYLINDER

QS1108SN/EM
66mm



OVAL KNOB SINGLE CYLINDER

QS1108SN SINGLE
40mm



MASTERKEYED PADLOCK

QS1111SS

- For use with all QS masterkeyed and keyed alike cylinders
- 304 grade stainless steel
- 50mm body with 10mm shackle
- Double bolted



CYLINDERS

QS1103SN
QS1103A
60mm

QS1104SN
QS1104A
66mm

QS1105SN
70mm

QS1109SN
80mm



OVAL KNOB CYLINDER

QS1108SN
QS1108A
66mm

- All cylinders are available as standard, keyed alike, masterkey or grand masterkey
- Standard cylinders supplied with two keys

- Keyed alike cylinders supplied with one key per cylinder
- Masterkeyed cylinders supplied with two keys per cylinder and two master keys

- SN - satin nickel
- A - Elemental

*Lead times for masterkeyed cylinders are 10-15 working days.
All orders smaller than 10 will be 5 working days or less.*

MASTER KEY SYSTEMS

Each key can open its individual door, the general key can open all the doors

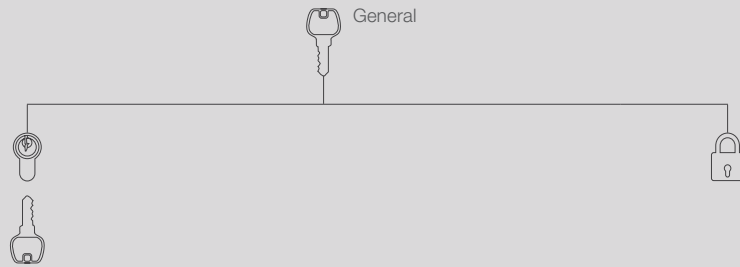

APARTMENT SYSTEMS

Each key can open the public door, passage door and its own individual door

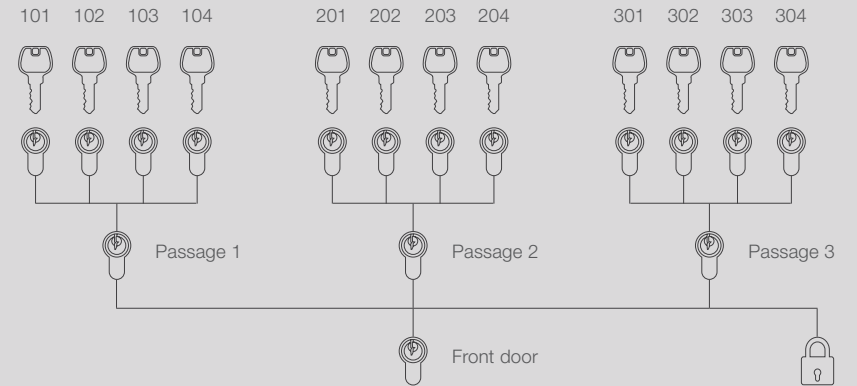

DOMESTIC KEYED-ALIKE WITH STAFF KEY

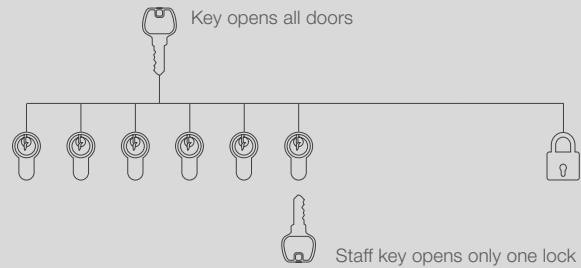

COMPLEX MASTERKEY SYSTEMS

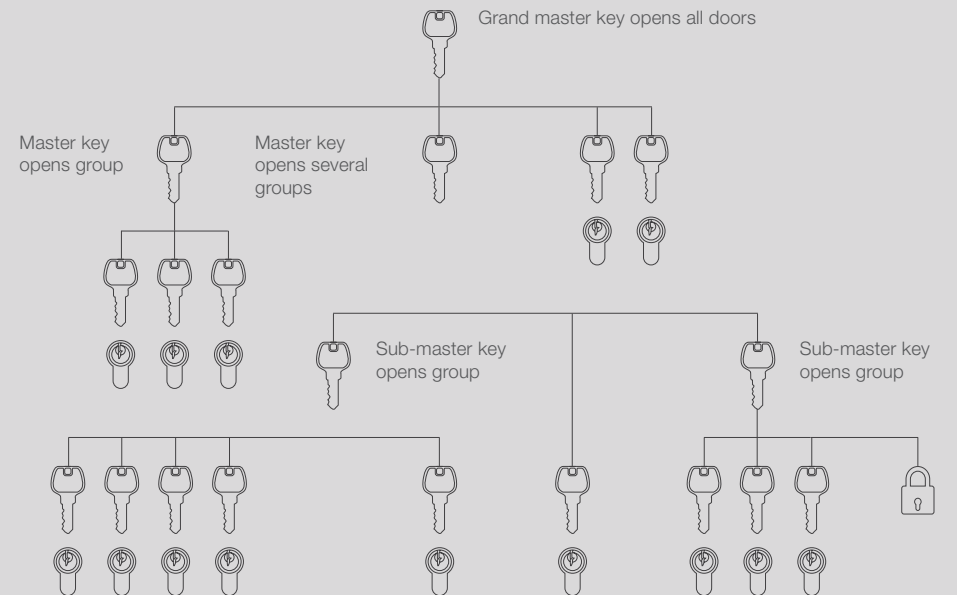

KEYED ALIKE

The key can open all the doors

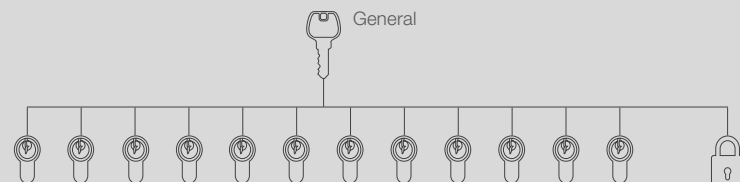

hinges

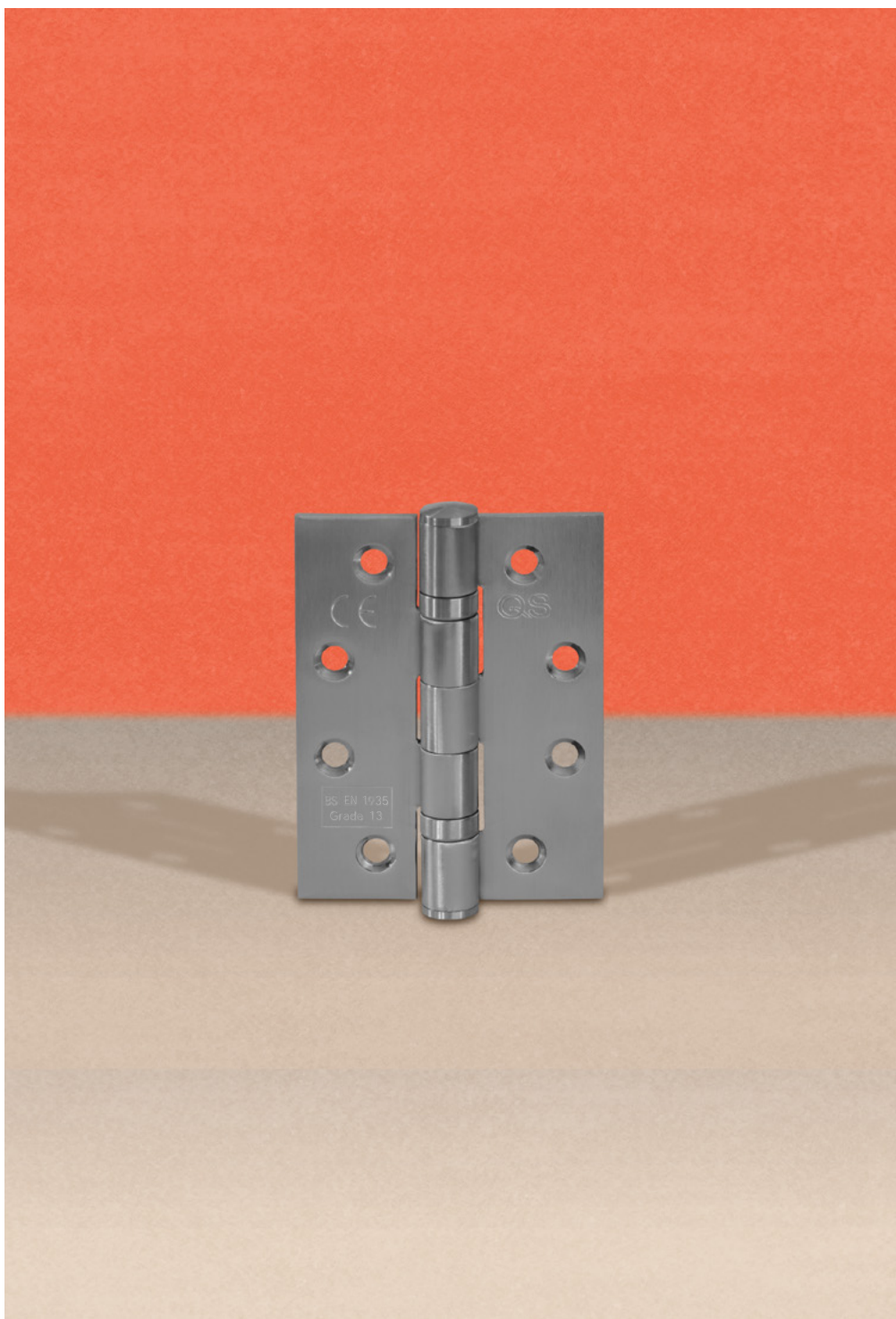

CE RATED BS2002:1935 FOR THE QS4415

**DIGIT 1
CATEGORY OF USE**
Grade 1: light duty
Grade 2: medium duty
Grade 3: heavy duty
Grade 4: severe duty

**DIGIT 3
TEST DOOR MASS**
Grade 0: 10kg
Grade 1: 20kg
Grade 2: 40kg
Grade 3: 60kg
Grade 4: 80kg
Grade 5: 100kg
Grade 6: 120kg
Grade 7: 160kg

**DIGIT 5
SAFETY**
Grade 1: safe to use

**DIGIT 7
SECURITY**
Grade 0: not suitable for use on burglar-resistant door assemblies
Grade 1: suitable for applications requiring a degree of security

QS Product Code

QS4415	4	7	6	1	1	4	0	13
---------------	----------	----------	----------	----------	----------	----------	----------	-----------

**DIGIT 2
DURABILITY**
Grade 3: 10 000 test cycles, for light duty hinges on windows only
Grade 4: 25 000 test cycles for light duty hinges on windows and doors
Grade 7: 200 000 test cycles, for medium, heavy and severe duty hinges on doors only

**DIGIT 6
CORROSION RESISTANCE**
Grade 0: no resistance
Grade 1: mild resistance
Grade 2: moderate resistance
Grade 3: high resistance
Grade 4: very high resistance

**DIGIT 4
FIRE SUITABILITY**
Grade 0: not suitable for fire/smoke resistant door assemblies
Grade 1: suitable for fire/smoke resistant door assemblies

**DIGIT 8
HINGE GRADE**
Grade 1: 10 000 test cycles / 10kg
Grade 2: 10 000 test cycles / 20kg
Grade 3: 25 000 test cycles / 20kg
Grade 4: 200 000 test cycles / 20kg
Grade 5: 10 000 test cycles / 40kg
Grade 6: 25 000 test cycles / 40kg
Grade 7: 200 000 test cycles / 60kg
Grade 8: 10 000 test cycles / 60kg
Grade 9: 25 000 test cycles / 60kg
Grade 10: 200 000 test cycles / 60kg
Grade 11: 200 000 test cycles / 80kg
Grade 12: 200 000 test cycles / 100kg
Grade 13: 10 000 test cycles / 120kg



QS4415
100x76x3mm
European CE rated and stamped



QS4417
100x76x2mm

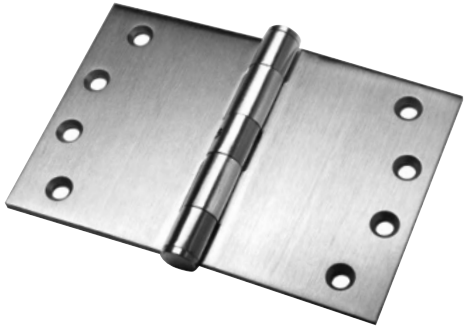

QS4412/1
100x150x3mm

QS4412/2
100x180x3.5mm

QS4412/3
100x200x3.5mm

QS4412/4
100x230x3.5mm

150mm and 180mm also available in 316 stainless steel



QS4441
100x76.5x2mm



QS4416
100x100x3mm



QS4440
102x76x2mm
Available in left hand or right hand



QS4439
100x76x3mm
Single action spring hinge
Three hinges for doors up to 40kg

accessories





QS4433
200mm rod
500mm rod
1000mm rod



QS4448
QS4448/4 Cranked 80mm
QS4448/3 Cranked 150mm



QS4451
QS4451/1 203mm
QS4451/2 305mm



QS4431
QS4431/1 76mm
QS4431/2 102mm
QS4431/3 178mm
QS4431/4 300mm



QS4411
QS4411/1 150mm
QS4411/2 200mm
QS4411/3 250mm
QS4411/4 300mm



QS4443
QS4443/1 150mm
QS4443/2 300mm



QS4448
QS4448/1 100mm
QS4448/2 150mm



QS4425
QS4425/1 60mm
QS4425/2 80mm

QS4492
Dust excluding socket





QS4461
Foot operated door bolt



QS4422
Hooded door stop
Ø 42mm
Available in PVD
Available in black



QS4435
Solid coat hook



QS4421
Round door stop
Ø 30mm



QS4436
Solid coat hook



QS4423
Wall mounted coat hook and door stop



QS4434
Door stop and coat hook

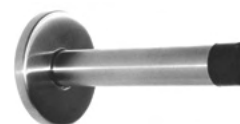

QS4420
Wall mounted door stop



QS4462
Floor mounted magnetic door stop
Available in black

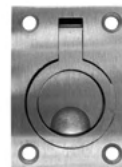

QS4413
Ring pull
63x44mm
Available in PVD



QS4463
Wall mounted magnetic door stop



QS4426
Ring pull
48x38mm
Available in PVD

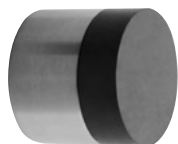

QS4464
Wall mounted handle buffer
Ø 30mm



QS4414
Ring pull
50mm



QS4449
QS4449/1 100mm
QS4449/2 150mm
QS4449/4 200mm

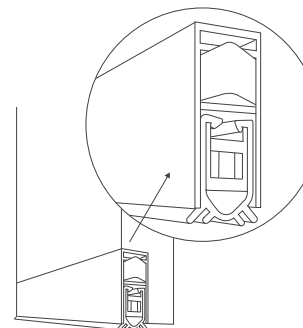

QS4494
Draught excluder
832mm length



QS4430
Security door guard
106x60mm



QS4601
Peg stay with two pegs
300mm | Ø 14mm



QS4466
Oval door bell
64x30mm



QS4602
Casement fastener with mortice keep
Ø 14mm



QS4465
Round door bell
Ø 52mm



QS4603
Hook plate for casement fastener



QS4468
Door viewer
Ø 35mm | 200° views



QS4604
Oulu window handle
Ø 19mm



QS4418
Oval flush pull
120x40mm



QS4419
Flush pull
102x51mm
Available in PVD



QS4459
Round flush pull
QS4459/1 Ø 50mm
QS4459/2 Ø 90mm



QS4453
Rectangular flush pull
with oval pull
120x40mm



QS4450
Rectangular flush pull
85x38mm



QS4457
Round flush pull
QS4457/1 Ø 50mm
QS4457/2 Ø 65mm



QS4452
Inclined rectangular flush pull
128x82mm

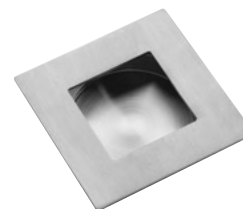

QS4455
Square flush pull
QS4455/1 50X50mm
QS4455/2 70X70mm



QS4478
Demi pull handle
85x36.3mm



QS4451/1
Square flush pull



QS4410
Coin release WC thumbturn
Available in PVD



QS4477
Square WC thumbturn



QS4409
WC thumbturn
Suitable for disabled toilets



QS4488
Square WC thumbturn



QS4479
WC thumbturn
Suitable for disabled toilets



QS4445
Surface mounted WC indicator bolt
Zinc alloy



QS4408
WC thumbturn
Suitable for disabled toilets



QS4446
Surface mounted WC indicator bolt
Stainless steel



QS4501
WC signage
75mm diameter



QS4507
WC signage
75mm diameter



QS4502
WC signage
75mm diameter



QS4508
WC signage
75mm diameter



QS4505
WC signage
75mm diameter



QS4509
WC signage
75mm diameter



QS4506
WC signage
75mm diameter

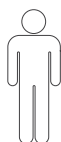

QS4512
WC signage
106mm height

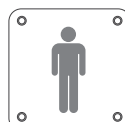

QS4503
WC signage
100x100mm



QS4511
WC signage
106mm height

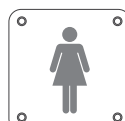

QS4504
WC signage
100x100mm



QS4510
WC signage
110x78mm height

QS custom makes stainless steel door plates to specified sizes for each project. We offer kick plates, push plates or armour plates to protect your door from marring or damage.

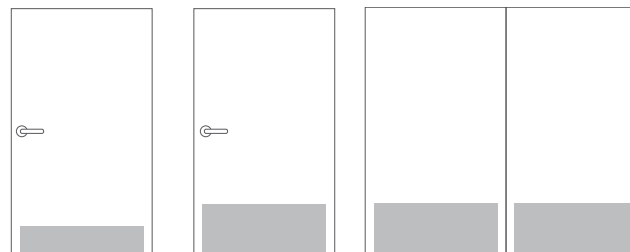

Mop plates

Kick plate

Kick plates

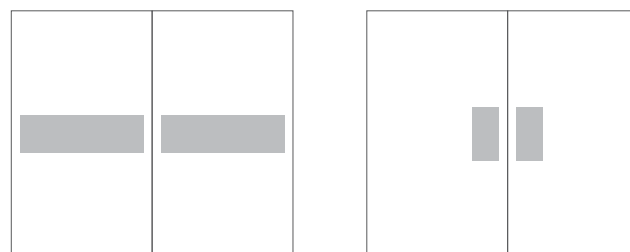

Stretcher plates

Push plates

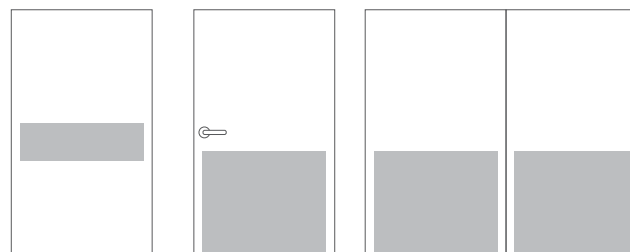

Stretcher plate

Armour plate

Armour plates

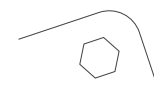
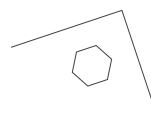

All doorplates are available with square or round anti-sag edging.

door controls



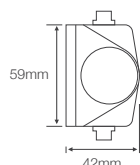

QS680

- For doors up to 1100mm - 80kg
- 5 year warranty
- EN1154 Fire rated
- Suitable for exterior use
- Latching and dampening action
- Suitable for very high traffic
- Stainless steel cover available
- Silver, gold, dark brown and black available

QS690V

- For doors up to 1250mm - 120kg
- 5 year warranty
- EN1154 Fire rated
- Suitable for exterior use
- Latching and dampening action
- Suitable for very high traffic
- Spring strength adjustable

The attractive profile of the **QS680** combined with a high traffic, heavy duty 5 year warranty makes it the most versatile, cost effective closer on the market. Add the stainless steel designer cover and its not out of place in the most prestigious location.

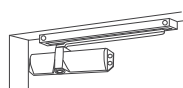

Side arm and channel installation

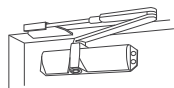

Bracket for opposite hinge installation

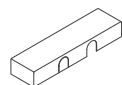

Stainless steel cover

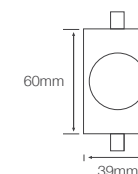

QS700

- For doors up to 1100mm - 100kg
- 5 year warranty
- EN1154 Fire rated
- Suitable for exterior use
- Latching and dampening action
- Stainless steel covers available
- Silver, black, gold and dark brown available
- QS700DA delayed action for disabled access available

QS750

- For doors up to 1250mm - 120kg
- 5 year warranty
- EN1154 Fire rated
- Suitable for exterior use
- Latching and dampening action
- Stainless steel covers available
- Silver, gold and dark brown available

The classic design of the **QS700** together with the various optional stainless steel covers and arms create the most versatile range of door closers on the market.

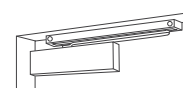

Side arm and channel installation

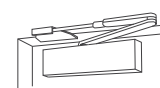

Bracket for opposite hinge installation

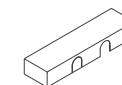

Classic cover

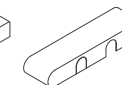

Retro cover

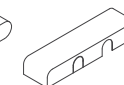

Smooth cover



EN Fire Tested
EN 1154 Tested



EN Fire Tested
EN 1154 Tested

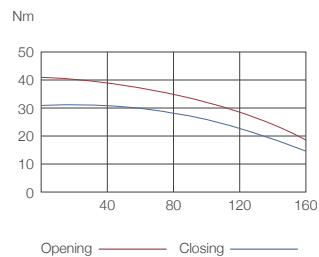

The **QS920** rack and irregular cam-shaped pinion door closer combines features of rack and pinion and cam action closers to work comfortably with the aesthetically preferred slide channel and with a high degree of flexibility when setting the control cycle.

The irregular cam-shaped pinion adjusts the gearing of the lever system within the closer so that as the spring compresses the resistance decreases. Because the piston moves further along the chamber than in the cam action system, more dampening fluid flows through the control valves creating an easy to adjust and forgiving door closer.

The **QS920** can be used on either side of the door without any additional brackets.

QS920

- For doors up to 1100mm - 80kg
- 5 year warranty
- EN1154 Fire rated
- Non-handed
- 180° opening
- Power adjustable after installation
- Latching and dampening action
- Stainless steel cover optional
- Non-hold open standard, hold open options available

**Image pictured with stainless steel cover*

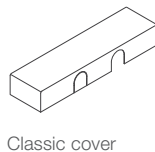
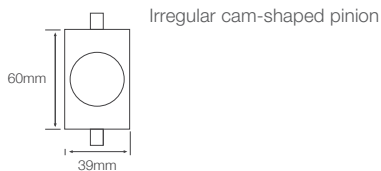
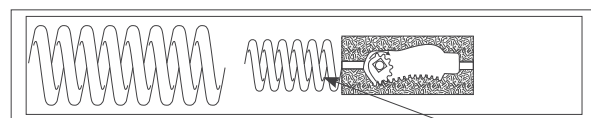

The **QS970**, at only 32mm wide, is the narrowest in-the-door closer available. Genuine cam action for a smooth feel. Ideal for single swing doors where aesthetics are at a premium.

QS970

- For doors up to 1100mm - 80kg
- 5 year warranty
- Latching and back check
- Hold open standard but removable
- Suitable for high traffic areas

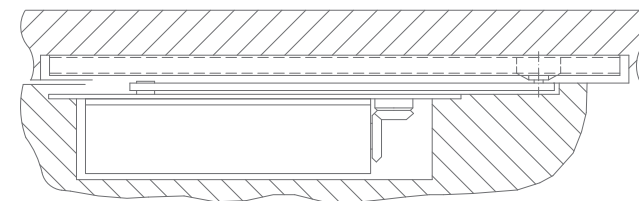

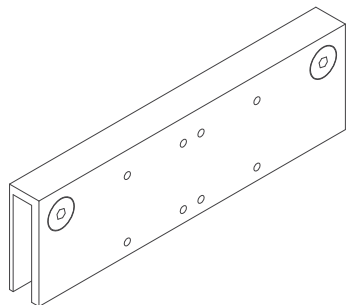

QS7702
Glass door shoe

For the installation of the door closer to all-glass doors (max. 10mm glass thickness)

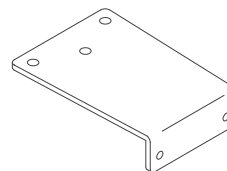
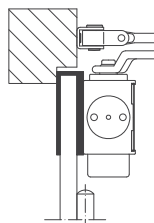

QS7708/A
Parallel arm bracket

For the installation of the arm assembly parallel to the door frame

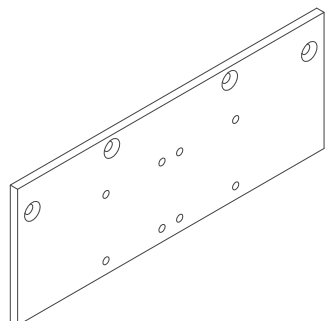
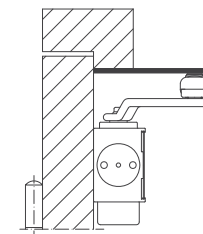

QS7704
Drop plate

For fixing when the door closer cannot be installed directly onto the door frame

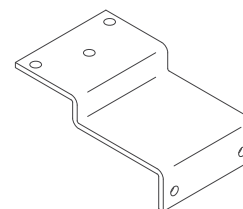
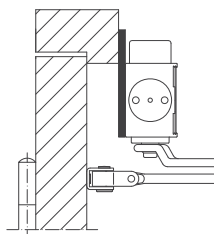

QS7708/B
Parallel arm bracket

For the installation of the arm assembly parallel to the door frame

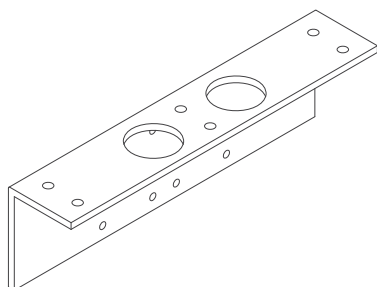
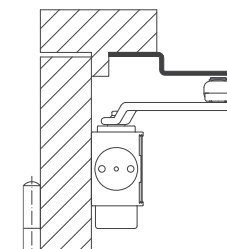

QS7705
Angle bracket

For transom fixing of the door closer on the push side in case of a deep lintel of the door

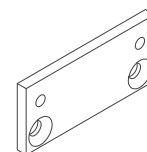
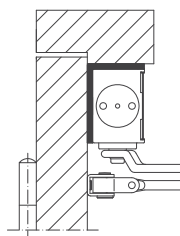

QS7709
Arm adapter plate

For the installation of the arm assembly to a particularly narrow door frame

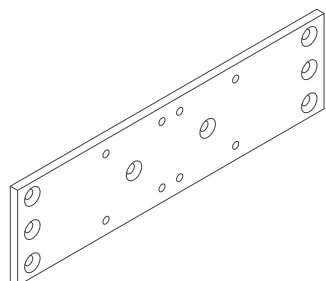
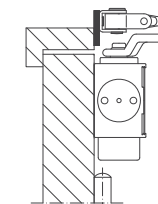

QS7710
Mounting backplate

For the installation of the door closer on fireproof and smoke control doors

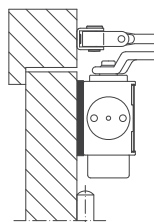

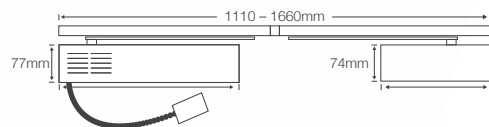

QS761

The **QS761** door co-ordinator for double rebated doors is used to ensure that the doors close in the right sequence.

Can be used in a variety of configurations – magnetic hold open with emergency release or simply on self closing doors. The above picture shows our **QS760EST** combined with **QS700** for a discrete hold open facility with smoke detector.

Door closers sold separately.



QS762

1067mm fire door coordinator

QS763

1320mm fire door coordinator

QS765

Filler bar



QS764

Mounting bracket

DOOR SELECTORS

It is mandatory for double rebated fire escape doors to be equipped with a door sequence selector. This ensures that each leaf feeds correctly into each other, reliably preventing the spreading of smoke and fire. QS can provide you with a number of solutions to best suit your installation requirements.

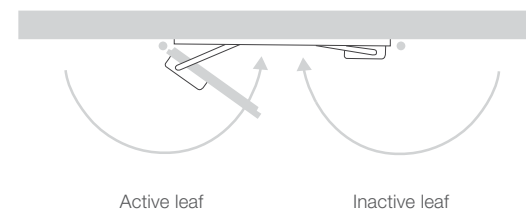
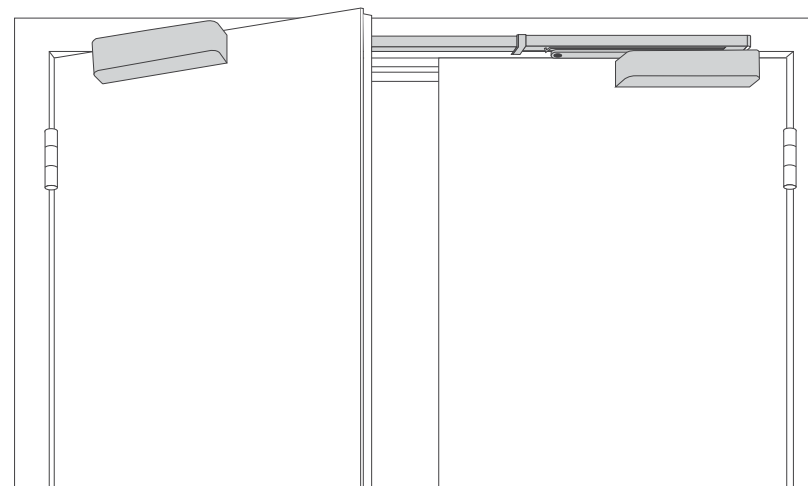

door controls

The **QS760ET** is an electromagnetic hold-open door closer for use with a centrally controlled fire control system. 24 volt DC.



The **QS760EST** is a stand-alone electromagnetic hold-open closer with a built in smoke detector, all that is required is a 24 volt DC current. Doors will be held open until smoke is detected at which time they will revert to self-closing. Ideal for remote doors that are not part of a larger fire control system.



QS768
Floor mounted electromagnetic doorstop

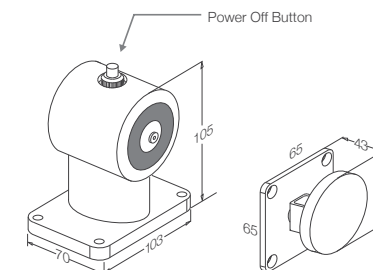

QS767
Wall mounted electromagnetic door holder

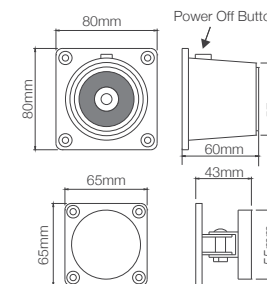

Q760ET / QS760EST

- For doors up to 1450mm - 120kgs
- 5 year warranty
- Variable spring strength for on-the-door adjustment
- Input voltage 24 DC
- 180° open angle
- Stainless steel cover

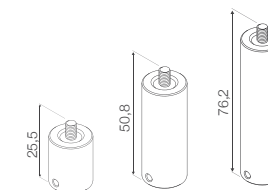
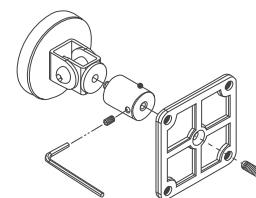

QS767/1 QS767/2 QS767/3

Receiver plate extensions



EN Fire Tested
EN 1154 Tested



The **QS860** is a hard-working, reliable and affordable floor spring for all standard doors weighing up to 100kgs

QS860

- For doors ranging from 750 - 850mm
- For doors weighing up to 100kgs
- 5 year warranty
- Two valve speed control
- 90° hold open or non-hold open
- Extra thick cover plate
- Complete with double action fittings

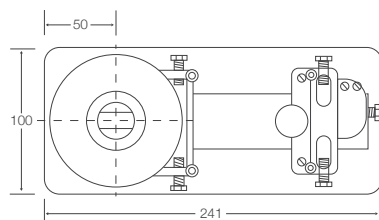

Double action units come with **QS8811** (double action top centre) and **QS8815** (universal bottom strap) as standard. See page 131 for the full specifications of these accessories.



The **QS880** floor spring represents everything the QS brand stands for: great design, superb functionality and exceptional value for money.

QS880

- For doors not bigger than 950mm - 25Nm
- For doors not bigger than 1050mm - 30Nm
- For doors weighing up to 150kgs
- 5 year warranty
- EN1154 compliant
- Two valve speed control
- 90° hold open or non-hold open
- Extra thick cover plate
- Complete with double action fittings

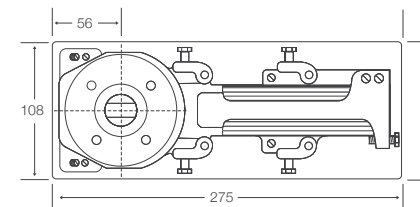

Double action units come with **QS8811** (double action top centre) and **QS8815** (universal bottom strap) as standard. See page 131 for the full specifications of these accessories.

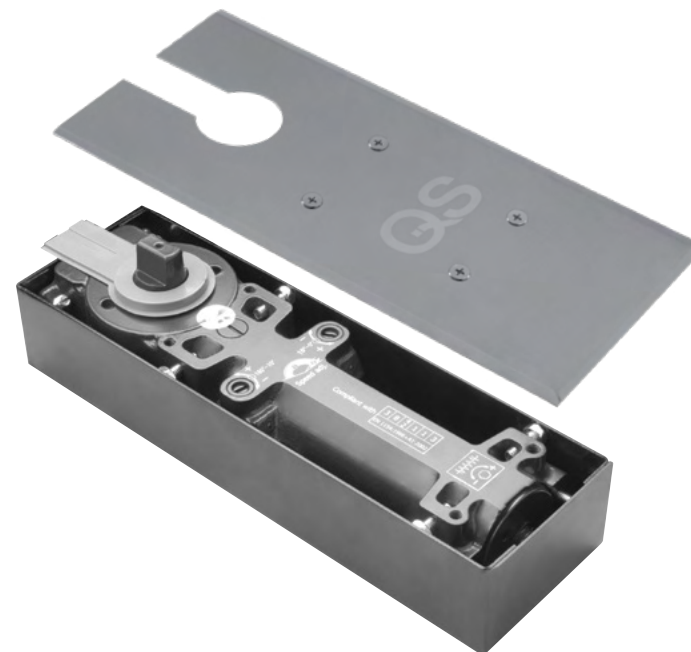

The **QS895** is a hard-working, reliable and affordable floorspring for all bigger doors weighing up to 200kgs.

QS895

- For doors no bigger than 1200mm - 35Nm
- For doors weighing up to 200kgs
- 5 year warranty
- EN1154 compliant
- Two valve speed control
- 90° hold open or non-hold open
- Extra thick cover plate
- Complete with double action fittings

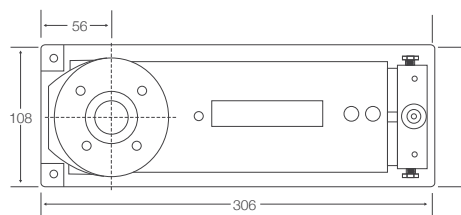

Double action units come with **QS8811** (double action top centre) and **QS8815** (universal bottom strap) as standard. See page 131 for the full specifications of these accessories.

The **QS899V** is arguably the best floorspring available. Its 200kg adjustable 750 - 1200mm range combined with a 5 year warranty makes this the obvious choice on commercial projects.

Q899V

- For doors ranging from 750 - 1200mm
- For doors weighing up to 200kgs
- 5 year warranty
- EN1154 compliant
- Two valve speed control
- 90° hold open or non-hold open
- Extra thick cover plate
- Complete with double action fittings

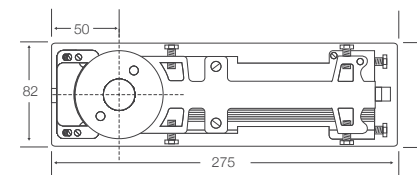

Double action units come with **QS8811** (double action top centre) and **QS8815** (universal bottom strap) as standard. See page 131 for the full specifications of these accessories.



The **QS900** is a concealed transom closer. The ideal closer for double swing doors when floorsprings cannot be used. A must for hospital specifications as floorsprings provide a cavity for “wash down” water to accumulate and breed bacteria.

QS900

- For doors up to 1000mm - 150kg
- 5 year warranty
- Suitable for high traffic areas
- 90° hold open or non-hold open
- Back check

QS900 comes with **QS5502** (pivot and bottom strap) for doors weighing up to 100kg. For extra heavy duty doors, or doors weighing in excess of 100kgs, we recommend the **QS8815** and the **QS5501** as an alternative. See page 131 for the full specifications of these accessories.

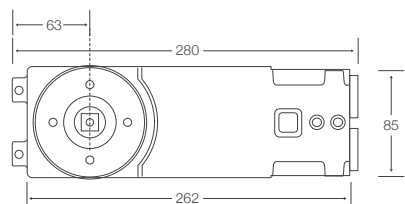

FLOORSPRING ACCESSORIES



QS8801

Single action top centre and strap.
Available in left and right hand variants

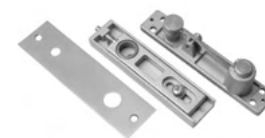

QS8811

Double action top centre



QS8815

Double action door strap.
Available in standard and adjustable versions

PIVOTS



QS5501

Roller bearing pivot for doors up to 250kg



Q5502

Bottom pivot for doors less than 100kg



QS5504 pivot set

Pivot set for doors up to 250kgs, consisting of the **QS5501**, **QS8811** and **QS8815**

TYPE A24

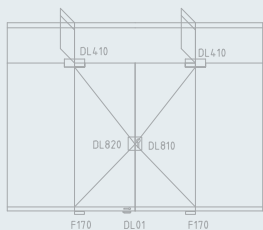

TYPE A10

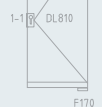
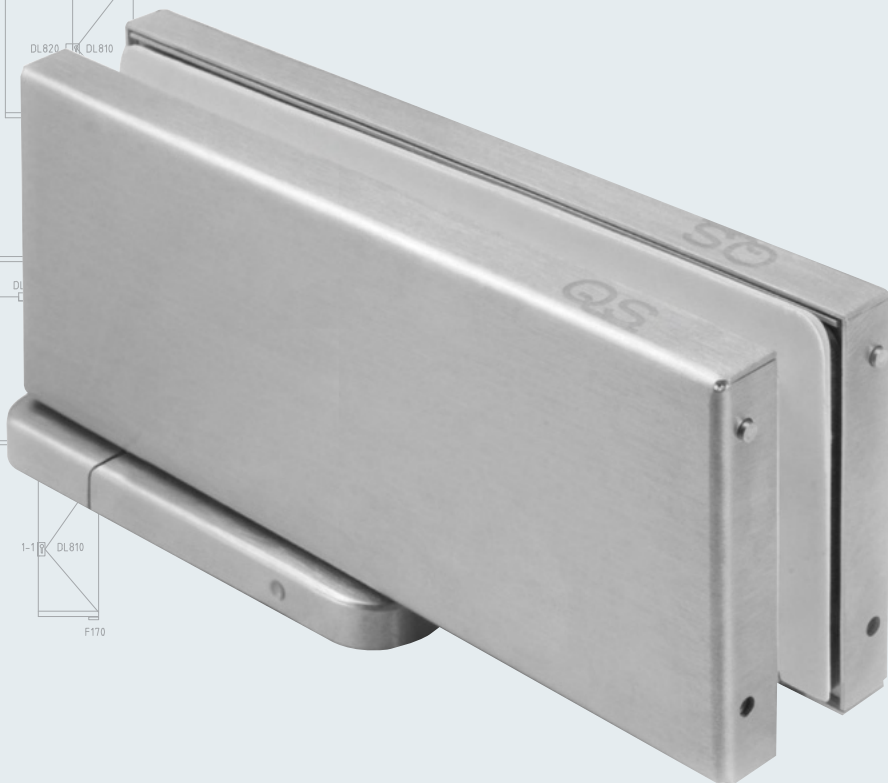
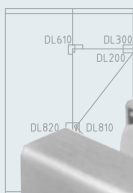

TYPE A10

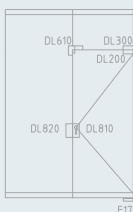

The **QS788** closer for tempered glass – combining bottom patch fitting and door closer in one. This cam-action closer eliminates the need for a floorspring and the floor preparation that goes with it greatly reducing the cost and installation of tempered glass doors.

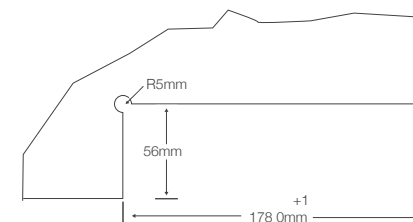
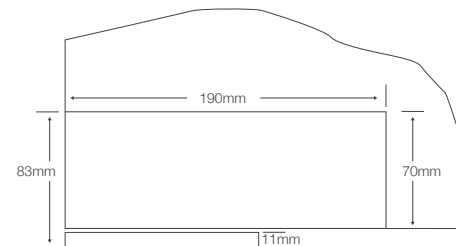

QS788

- For doors up to 1000mm - 100kgs
- Glass thickness 8 - 12mm
- 5 year warranty
- Cam action for smooth feel
- 150° angle of opening
- Double swing action
- Closing speed adjustable
- Checking speed adjustable
- 90° hold open option

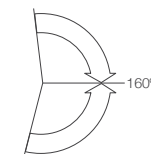

panic hardware

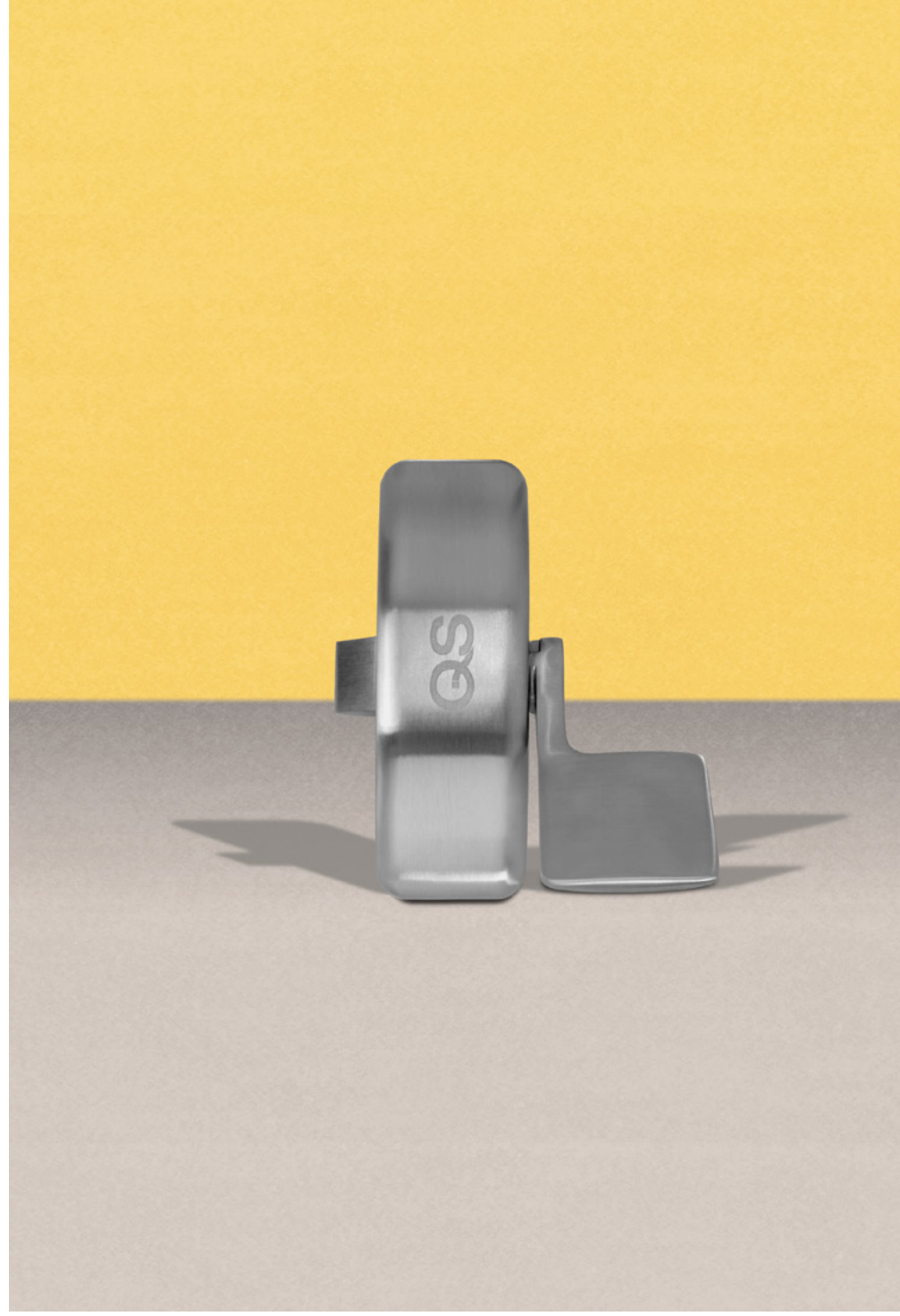



QS400

- Max door capacity 2300x1000mm; 200kg
- 5 year warranty
- EN1125 and EN1634 approved
- In compliance with EN1125: 208
- Fire result: 376B2: 14422AB
- Non-handed design
- Stainless steel

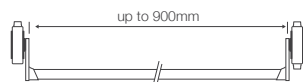

QS400/1

Single door single point locking

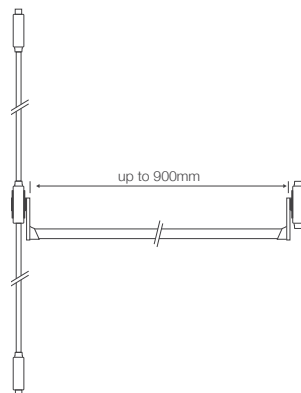

QS400/2

Single door two point locking

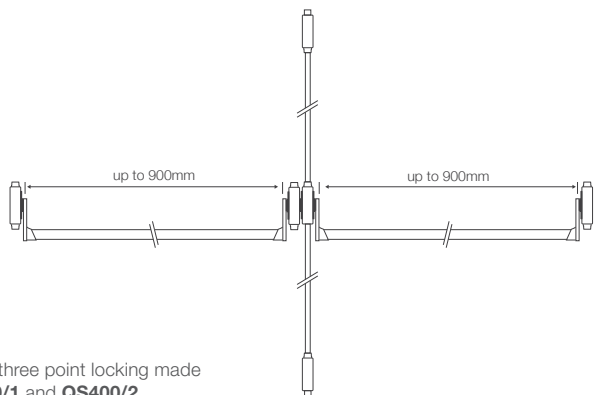

QS400/3

Double door three point locking made up of: **QS400/1** and **QS400/2**



QS430

Masterkey optional



QS431



QS432



QS4495

Automatic flush bolt for use with aluminium doors

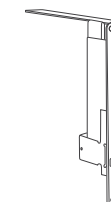

QS4496

Automatic flush bolt for use with timber doors



QS410

- Max door capacity: 650mm - 1389mm; 200kg
- 5 year warranty
- EN179 approved
- Non-handed design
- One lock point
- Stainless steel

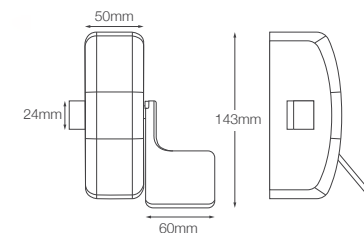



QS300

- Max door capacity 807x1076mm
- 5 year warranty
- Available in powder coated grey
- Reversible non-handed design

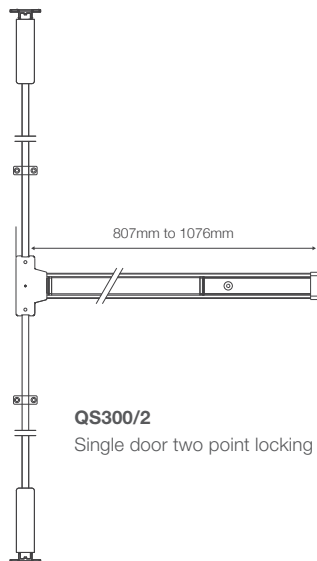
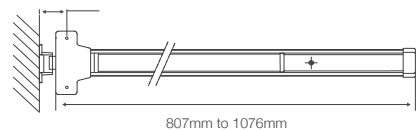

QS300/1

Single door single point locking

QS300/2

Single door two point locking

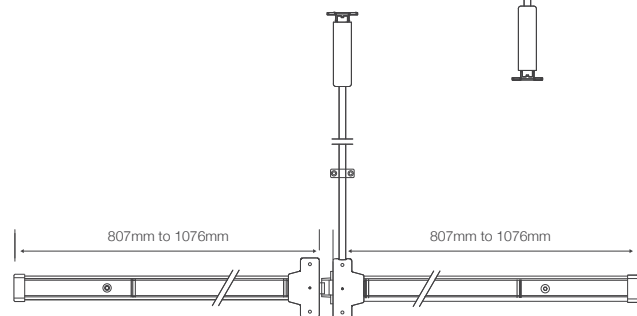

QS300/3

Double door three point locking made up of:
QS300/1 and **QS300/2**
plus overlapping strike plate **QS310**

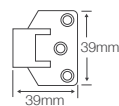

QS310



QS330



QS320

bathroom accessories

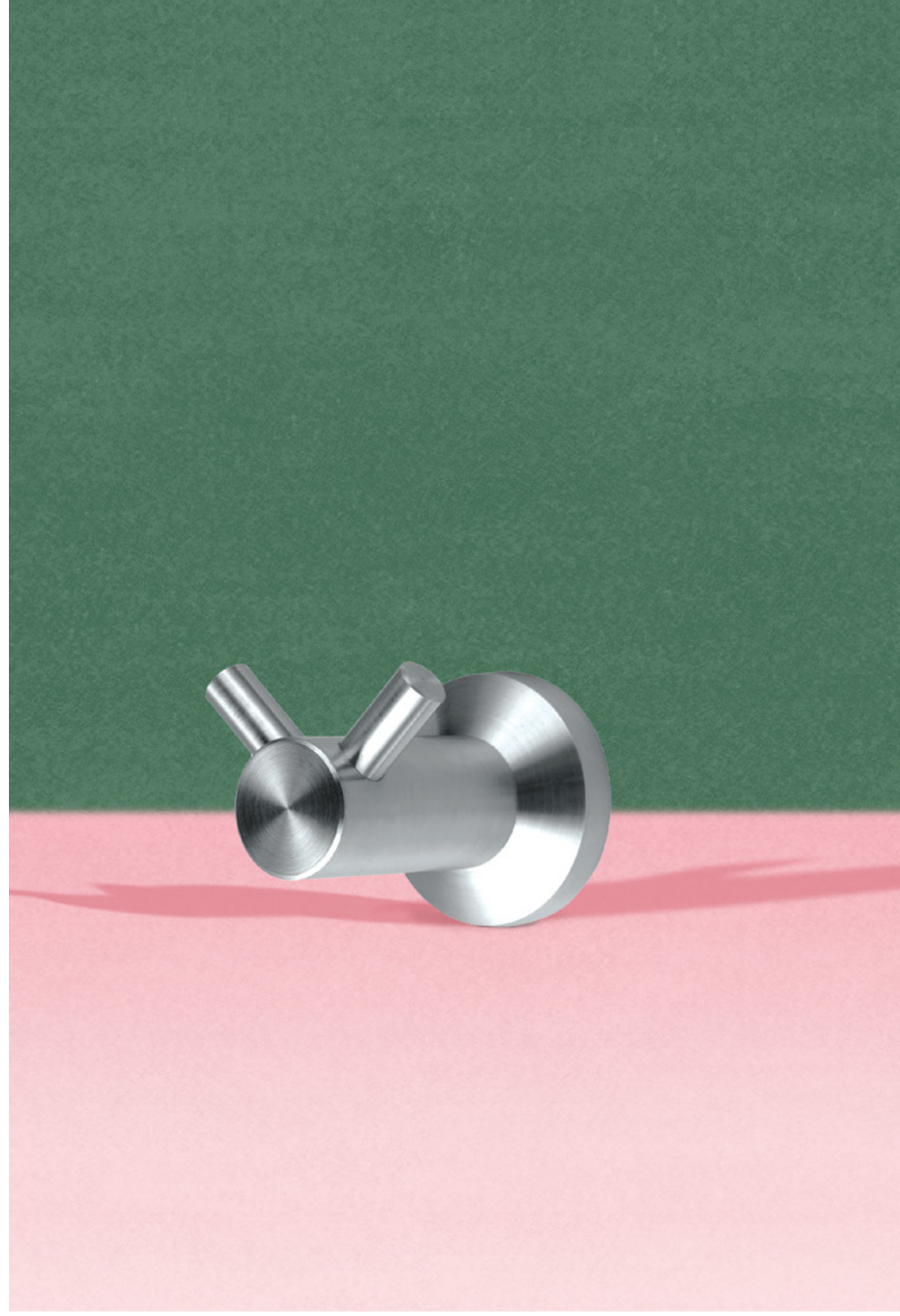



QS1501
Single towel bar



QS1509
Towel ring



QS1502
Double towel bar



QS1513
Single robe hook



QS1503
Glass shelf



QS1514
Double robe hook

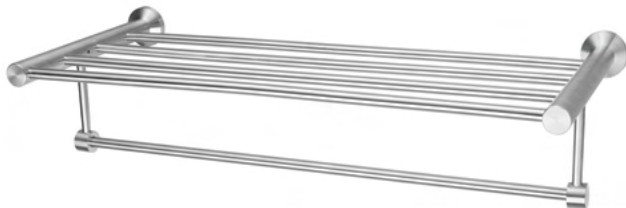

QS1504
Towel shelf

All products featured are available in a polished or satin stainless steel finish



QS1510
Single tumbler holder

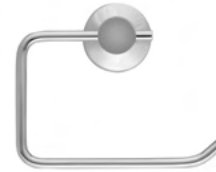

QS1508
Toilet paper holder



QS1507
Double tumbler holder



QS1512
Spare toilet paper holder



QS1511
Soap holder



QS1505
Toilet brush holder



QS1506
Soap basket

All products featured are available in a polished or satin stainless steel finish



QS1522
Single towel bar
550mm length



QS1526
Single tumbler holder



QS1524
Double towel bar
550mm length



QS1527
Soap holder

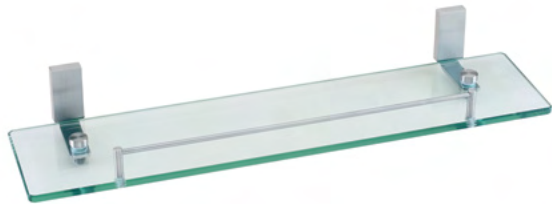

QS1529
Glass shelf
520mm length



QS1521
Robe hook



QS1523
Toilet roll holder



QS1528
Towel holder



QS1525
Toilet brush holder



QS1530
Floor standing toilet
brush holder



QS1601
Straight grab bar
300mm



QS1602
Straight grab rail
750x80mm



QS1603
Straight grab rail
750x206mm



QS1560
Economy bathroom set including towel rail, towel ring, soap dish and toilet roll holder, polished finish



QS1604
Angle grab rail
Three sections of 300mm | 135°



QS1605
Dog leg rail
600mm

Satin stainless steel

access control



QSX4200 smart lock

FEATURES

- Stainless steel lever handle on backplate
- Heavy-duty commercial lock and knob cylinder
- Biometric (fingerprint) reader optional
- Bluetooth mobile access through an app available on Android / iOS
- Digital keypad for passcode access
- Card or tag access
- Mechanical key override with euro profile cylinder and keyed-alike key
- Wireless installation
- Four AAA batteries required
- EN14846 rated for electromechanically operated locks and latches
- 1-year warranty



OVERVIEW

	HOTEL	AIR BNB	RESIDENTIAL/STUDENT	COMMERCIAL
BIOMETRICS			•	•
BLUETOOTH		•	•	
PASSCODE	•	•	•	•
TAG/CARD	•			
KEY	•	•	•	•

BENEFITS

- Passcode and card can be issued
- Manual key override for emergency access
- Lock record downloaded with app
- Up to 240 unlock records kept at a time
- Access can be removed instantly

- Bluetooth access sent remotely with time parameters
- Entry records are available on app
- Should no mobile device be available a passcode can be issued
- Access can be removed through app or master passcode

- Manage all rooms from app easily
- Set access through app easily
- Lock record available through app
- Tamper proof design
- Manual override for latch and deadbolt
- Master passcode can reset lock
- No mechanical key required

- Up to 50 users per lock can be set
- Lock record available through app
- Tamper proof design

contact details

QS

Doorware cc
12 Naaf Street
Strijdom Park, 2194
Johannesburg

Tel: +27 11 792 3334

Fax: +27 11 792 9966

Email: sales@qsproducts.joburg

www.qsproducts.za.com