



# 2019 CATALOG



[www.gabriel.com](http://www.gabriel.com)

## Table of Contents

|   |     |
|---|-----|
| New Part Numbers / Part Numbers Superseded .....                            | 2   |
| <b>Application and Numerical Listings</b>                                   |     |
| Specialty Shocks .....  | 3   |
| Medium Duty & Heavy Duty Trucks, Trailers & Buses Application Listing ..... | 5   |
| Medium Duty & Heavy Duty Trucks, Trailers & Buses Numerical Listing.....    | 227 |
|   |     |
| Fleetline / GasSLX Interchange .....  | 240 |
| Competitive and OEM Interchange .....                                       | 241 |
|   |     |
| How to Determine the Correct Shock for Your Truck.....                      | 291 |
| Specifications by End Mount .....   | 300 |
| Specifications by Part Number.....  | 316 |
|   |     |
| Mounting Accessory Packages and Component Parts .....                       | 331 |
| Mounting Accessory Packages - Buyer's Guide .....                           | 338 |

**NEW PART NUMBERS IN THIS CATALOG  
NOUVEAUX NUMÉROS DE PIÈCES DANS CE CATALOGUE  
NUMERACION NUEVA DE PARTES EN ESTE CATALOGO**

|       |       |
|-------|-------|
| 83081 | 83905 |
| 83180 | 83906 |
| 83363 | 85182 |
| 83364 | 85637 |
| 83391 | 85638 |
| 83395 | 85639 |
| 83901 | 89503 |

**PART NUMBERS DROPPED FROM THIS CATALOG  
NUMÉROS DE PIÈCES SUPPRIMÉS DE CE CATALOGUE  
NUMERACION DE PARTES QUE NO APARECEN EN ESTE CATALOGO**

|       |       |       |       |       |       |
|-------|-------|-------|-------|-------|-------|
| 83052 | 83176 | 85346 | 85731 | 85974 | 89412 |
| 83060 | 85011 | 85347 | 85905 | 85975 | 89441 |
| 83061 | 85083 | 85378 | 85907 | 85980 | 83014 |
| 83100 | 85085 | 85379 | 85912 | 85984 | 83046 |
| 83115 | 85092 | 85380 | 85913 | 86201 | 83634 |
| 83145 | 85097 | 85703 | 85930 | 86202 | 83636 |
| 83155 | 85099 | 85706 | 85966 | 86203 | 85701 |
| 83161 | 85313 | 85707 | 85968 | 87016 | 85719 |
| 83171 | 85324 | 85710 | 85969 | 87017 | 85730 |
| 83174 | 85342 | 85715 | 85971 | 87019 | 89416 |

**9 YEAR SUPERSEDURE LIST  
LISTE DE REMPLACEMENT DES 9  
LISTA DE REEMPLAZOS DE 9 AÑOS**

| <b>DELETE</b> | <b>THEN<br/>USE</b> |
|---------------|---------------------|
| 83032         | 83025HD             |
| 83146         | 83364               |
| 83200         | 89402               |
| 83353         | 85740               |
| 83362         | 83215               |
| 83404         | 83159               |
| 85050         | 83221               |
| 85312         | 85733               |
| 85330         | 85379               |
| 85714         | 85715               |
| 85717         | 85715               |
| 85718         | 85732               |
| 89403         | 89401               |

## APPLICATION GUIDE - SPECIALITY

| Year<br>Año<br>Année                            | Model<br>Modelo<br>Modèle                              | OEM #  | Fleetline #                                    |
|---|--|--|--|
| <b>ADVANCE MIXER</b>                            |  |  |  |
|   | Rear Discharge Mixers with Self - Steering Axle Shock  | 12111 ADV  | 646155   |
| <b>CHALLENGE</b>                                |  |  |  |
|   | Cement Mixer   | 632147<br>632155   | 632147<br>646177                               |
| <b>GRANNING SUSPENSION</b>                      |  |  |  |
|   | Model L120 Self Steer Axle                             | 701071-01  | 646155   |
| <b>HENDRICKSON TRAILER SUSPENSION SYSTEMS</b>   |  |  |  |
| <b>Auxiliary Liftable Steerable System (HL)</b> |  |  |  |
|   | HLP Paralift   | A-14496  | 646155   |
|   | HLU Paralift Ultra                                     | A-14496  | 646155   |
| <b>HENDRICKSON TRUCK SUSPENSION SYSTEMS</b>     |  |  |  |
| <b>Dual Tire Steer Lift Axle</b>                |  |  |  |
|   | Tough Lift LK Series                                   | A-14496  | 646155   |
| <b>INGERSALL MACHINE</b>                        |  |  |  |
|   | 700060-0 Axle Assy.                                    | 665472   | 665472   |
|   | Models with O.E.M. Number                              | 665904   | 665472   |
| <b>KIMBLE MIXER CO</b>                          |  |  |  |
|   | Rear Discharge Mixers with Self - Steering Axle Shock  | OE10455  | 646155   |
| <b>LINK/HIGH-STEER</b>                          |  |  |  |
|   | 6000 Steering Stabilizer                               | 632155   | 646177   |
|   | 9000 Steering Stabilizer                               | 1210-0007<br>1210-0009                                     | 665937<br>665937                               |
|   | Models with O.E.M. Number                              | 1210-0001<br>1210-0002<br>1210-0010<br>1210-0012<br>646168 | 646155<br>632147<br>646155<br>646155<br>646155 |
| <b>LONDON MIXER</b>                             |  |  |  |
|   | Rear Discharge Mixers with Self - Steering Axle Shock  | MB-37737-30  | 646155   |
| <b>MC NEILUS TRUCK &amp; MAN.</b>               |  |  |  |
|   | Booster Axles  | 1170719<br>600-115994B                                     | 632147<br>632147                               |
|   | Bridgemaster V models with Self - Steering Axle Shocks | 600-188206   | 646155   |
|   | Models with O.E.M. Number                              | 1473224<br>2034140 MTM<br>600-11599M                       | 646155<br>646155<br>632147                     |
|   | Pusher Axles   | 600-115994B  | 632147   |
| <b>OSHKOSH MOTORS</b>                           |  |  |  |
|   | Models with O.E.M. Number                              | 2034140  | 646177   |
| <b>PIERCE MANUFACTURING INC.</b>                |  |  |  |
|   | Models with O.E.M. Number                              | 2034140  | 646177   |
| <b>REX MIXER</b>                                |  |  |  |
|   | Rear Discharge Mixers with Self - Steering Axle Shock  | 102-13441-10   | 646155   |
| <b>REYCO SUSPENSION</b>                         |  |  |  |
|   | L132 Steering Stabilizer                               | 701071-01  | 665937   |
| <b>RIDEWELL CORPORATION</b>                     |  |  |  |
|   | RLT-230  | 1310002  | 665937   |
|   | RSS-232  | 1317570B001  | 646155   |
|   | RSS-236/R  | 1310002<br>1310004   | 665937<br>665937                               |



**APPLICATION GUIDE - SPECIALITY**

| Year<br>Año<br>Année | Model<br>Modelo<br>Modèle | OEM # | Fleetline # |
|----------------------|---------------------------|-------|-------------|
|----------------------|---------------------------|-------|-------------|

**SAF HOLLAND**

|  |                             |                    |                  |
|--|-----------------------------|--------------------|------------------|
|  | Self - Steering Axle Shocks | 646201<br>90045331 | 646177<br>646155 |
|--|-----------------------------|--------------------|------------------|

**Neway V-Steer II**

|  |                             |        |        |
|--|-----------------------------|--------|--------|
|  | Self - Steering Axle Shocks | 632155 | 646177 |
|--|-----------------------------|--------|--------|

**SPRING VALLEY**

|  |                            |        |        |
|--|----------------------------|--------|--------|
|  | SS120 Steering Stabilizer  | 632155 | 646177 |
|  | SS130L Steering Stabilizer | 632155 | 646177 |

**SUSPENSIONS INC.**

|  |                          |        |        |
|--|--------------------------|--------|--------|
|  | LP11 Steerable Lift Axle | 200188 | 646155 |
|--|--------------------------|--------|--------|

**TEREX CORPORATION**

|  |   |       |        |
|--|---|-------|--------|
|  | Rear Discharge Mixers with Self - Steering Axle Shock | 12111 | 646155 |
|--|---|-------|--------|

**TUTHILL TECHNOLOGIES**

|  |                           |       |        |
|--|---------------------------|-------|--------|
|  | Models with O.E.M. Number | 66502 | 646155 |
|--|---------------------------|-------|--------|

**VARIOUS**

**Steering Stabilizer**

|  |   |         |       |
|--|---|---------|-------|
|  | Various Class 8 Trucks with Front Axle Rating of 10,000 lb to 20,000 lb | SC-2920 | 83176 |
|--|---|---------|-------|

**WATSON & CHALIN MFG. INC.**

**Self - Steering Axle Suspension Systems**

|  |  |       |        |
|--|--|-------|--------|
|  | LW5L-1100 SR                           | 11418 | 646155 |
|  | Models with O.E.M. Number              | 17069 | 632147 |
|  | SL-2089 Steerable Lift Axle Suspension | 11418 | 646155 |
|  | WCAL-1000 SST                          | 11418 | 646155 |
|  | WCAL-1100 LR                           | 11418 | 646155 |
|  | WCAL-1100 SR                           | 11418 | 646155 |
|  | WCAL-1100 SRLP                         | 11418 | 646155 |
|  | WCAL-1100 SSR                          | 11418 | 646155 |
|  | WCHL-1100 FL                           | 11418 | 646155 |
|  | WCHL-1100 HI-LIFT                      | 11418 | 646155 |

**WESTPORT AXLE CORP**

|  |                             |                       |                  |
|--|-----------------------------|-----------------------|------------------|
|  | Self - Steering Axle Shocks | 143699-0185<br>646124 | 646177<br>646177 |
|--|-----------------------------|-----------------------|------------------|

## APPLICATION GUIDE - TRUCKS, TRAILERS, AND BUSES

| Year<br>Año<br>Année | Model<br>Modelo<br>Modèle | OEM # | Front |  |  | Rear |           |        |
|----------------------|---------------------------|-------|-------|--|--|------|-----------|--------|
|                      |                           |       |       |  |  |      |           |        |
|                      |                           |       |       |  |  |      | Fleetline | GasSLX |

### ABC BUS

|  |  |            |     |        |     |     |       |     |
|--|--|------------|-----|--------|-----|-----|-------|-----|
|  | Drive Axle   | 12J-5-10   |     | ...    | ... | 0 - | 85733 | ... |
|  | T2100 Van Hool Buses with O.E.M. Number (Front & Tag Axle) | 10685703   | - - | 695406 | ... |     | ...   | ... |
|  |  | 624314570  | - - | 695406 | ... |     | ...   | ... |
|  |  | 90-2291    | - - | 695406 | ... |     | ...   | ... |
|  | Models with O.E.M. Number                                  | 050134513  | 0 0 | 85732  | ... |     | ...   | ... |
|  |  | 12L-5-88   |     | ...    | ... | 0 - | 85729 | ... |
|  |  | 6243-13790 | - - | 85708  | ... |     | ...   | ... |
|  |  | 6243-14040 | - - | 85708  | ... |     | ...   | ... |
|  | Additional O.E.M. Interchanges                             | 12B-5-1    | 0 0 | 85735  |     |     |       |     |
|  |  | 12L-5-114  | - - | 85727  |     |     |       |     |
|  |  | 12L-5-72   | - - | 85709  |     |     |       |     |
|  |  | 3166657    | 0 0 | 85700  |     |     |       |     |
|  |  | 680323     | 0 0 | 85700  |     |     |       |     |

### ACF BRILL BUS

|  |   |        |     |                |     |     |       |       |
|--|---|--------|-----|----------------|-----|-----|-------|-------|
|  | 37R Models                              | .....  | 0 0 | 85736          | ... |     | ...   | ...   |
|  | C-27 and C-31 City Bus                  | .....  | 0 0 | 85736          | ... | 0 0 | 85702 | ...   |
|  | C-36 City Bus Serial #1051 and on       | .....  | 0 0 | 85736          | ... | 0 0 | 85702 | ...   |
|  | C-37M Models                            | .....  | 0 0 | 85736          | ... | 0 0 | 85702 | ...   |
|  | C-44 City Bus and T-44 Trolley Bus      | .....  |     | 85308          | ... | 0 0 | 85308 | 89422 |
|  | IC-41 Intercity Bus Serial #1088 and on | .....  |     | 85308          | ... | 0 0 | 85308 | 89422 |
|  | IC-41 Intercity Bus to Serial #1088     | .....  | 0 0 | 85736          | ... | 0 0 | 85702 | ...   |
|  | Additional O.E.M. Interchanges          | 610513 | 0 0 | 85307          |     |     |       |       |
|  |   | 631237 | 0 0 | 85308 or 89422 |     |     |       |       |
|  |   | 641521 | 0 0 | 85308 or 89422 |     |     |       |       |
|  |   | 649648 | 0 0 | 85308 or 89422 |     |     |       |       |
|  |   | 659129 | 0 0 | 85303 or 89422 |     |     |       |       |
|  |   | 661732 | 0 0 | 83215          |     |     |       |       |
|  |   | 661733 | 0 0 | 83225          |     |     |       |       |
|  |   | 995891 | 0 0 | 85307          |     |     |       |       |

### ADVANCE MIXER

|  |                                  |           |     |       |     |     |       |       |
|--|----------------------------------|-----------|-----|-------|-----|-----|-------|-------|
|  | Advance Mixer part number        | 13424 ADV |     | ...   | ... | 0 0 | 83207 | 89407 |
|  |                                  | 14626 ADV |     | ...   | ... | 0 0 | 83209 | ...   |
|  |                                  | 23458 ADV |     | ...   | ... | 0 - | 83112 | ...   |
|  | Models with 20,000 lb Front Axle | 13883     | 0 0 | 85334 | ... |     | ...   | ...   |
|  |                                  | 13883 ADV | 0 0 | 85334 | ... |     | ...   | ...   |
|  |                                  | 680087    | 0 0 | 85334 | ... |     | ...   | ...   |

### ALLCO TRAILER

|  |   |        |  |     |     |     |       |       |
|--|---|--------|--|-----|-----|-----|-------|-------|
|  | Dump Trailers with Watson & Chalin TA-5000-DB-19 Air Suspension | 727602 |  | ... | ... | 0 0 | 83122 | 89406 |
|--|---|--------|--|-----|-----|-----|-------|-------|





### AM GENERAL

|  |                                |         |     |       |     |     |       |       |
|--|--------------------------------|---------|-----|-------|-----|-----|-------|-------|
|  | Small Bus                      | 5979484 |     | ...   | ... | 0 0 | 85302 | 89420 |
|  | Additional O.E.M. Interchanges | 3166657 | 0 0 | 85700 |     |     |       |       |
|  |                                | 4975501 | 0 0 | 85700 |     |     |       |       |
|  |                                | 5565748 | 0 0 | 85700 |     |     |       |       |
|  |                                | 5957136 | 0 0 | 85700 |     |     |       |       |
|  |                                | 5969438 | 0 0 | 85700 |     |     |       |       |
|  |                                | 5978712 | 0 0 | 85700 |     |     |       |       |
|  |                                | 5979574 | 0 0 | 85700 |     |     |       |       |
|  |                                | 5982537 | 0 0 | 85700 |     |     |       |       |

### ARVIN MERITOR

|  |   |             |     |       |     |  |     |     |
|--|---|-------------|-----|-------|-----|--|-----|-----|
|  | Blue Bird Motor Home with IFS (37 Foot) | 7805-N-1002 | 0 0 | 85329 | ... |  | ... | ... |
|--|---|-------------|-----|-------|-----|--|-----|-----|





**APPLICATION GUIDE - TRUCKS, TRAILERS, AND BUSES**

| Year<br>Año<br>Année | Model<br>Modelo<br>Modèle | OEM # | Front   |  | Rear  |   |
|----------------------|---------------------------|-------|---|--|---|---|
|                      |                           |       |  |  |  |  |
|                      |                           |       | Fleetline   | GasSLX   | Fleetline   | GasSLX  |

**ARVIN MERITOR(Cont'd.)**

|  |   |             |     |                       |              |     |              |              |
|--|---|-------------|-----|-----------------------|--------------|-----|--------------|--------------|
|  | Blue Bird Motor Home with IFS (37 Foot) | 7805-S-1007 | 010 | <b>85329</b>          | ...          |     | ...          | ...          |
|  | Models with Manufacturing Number        | 085009      | -10 | <b>85009</b>          | ...          |     | ...          | ...          |
|  |   | 085014      |     | ...                   | ...          | 010 | <b>85014</b> | ...          |
|  |   | 085321      |     | ...                   | ...          | 010 | <b>85321</b> | ...          |
|  |   | 654907      |     | ...                   | ...          | 010 | <b>85000</b> | <b>89436</b> |
|  |   | 654958      | 010 | <b>83164</b>          | ...          |     | ...          | ...          |
|  |   | 659016      | 010 | <b>83064</b>          |              |     |              |              |
|  |   | 659222      | 010 | <b>83171</b>          | ...          |     | ...          | ...          |
|  |   | 665044      |     | ...                   | ...          | 010 | <b>83209</b> | ...          |
|  |   | 665724      |     | ...                   | ...          | 010 | <b>85000</b> | <b>89436</b> |
|  |   | 665746      |     | ...                   | ...          | 010 | <b>85000</b> | <b>89436</b> |
|  |   | 665760      |     | ...                   | ...          | 010 | <b>85045</b> | ...          |
|  |   | 665769      |     | ...                   | ...          | 010 | <b>85052</b> | ...          |
|  |   | 665804      |     | ...                   | ...          | 010 | <b>85939</b> | ...          |
|  |   | 671091      |     | ...                   | ...          | -1- | <b>85069</b> | <b>89455</b> |
|  |   | 671092      | 010 | <b>85012</b>          | <b>89413</b> |     | ...          | ...          |
|  |   | 671507      |     | ...                   | ...          | 010 | <b>87015</b> | ...          |
|  |   | 671707      |     | ...                   | ...          | 010 | <b>85323</b> | <b>89436</b> |
|  |   | 680102      | 010 | <b>85712</b>          |              |     |              |              |
|  |   | 680322      | 010 | <b>85704</b>          |              |     |              |              |
|  |   | 680331      | 010 | <b>85702</b>          |              |     |              |              |
|  |   | 680337      | -1- | <b>85708</b>          |              |     |              |              |
|  |   | 680347      | 010 | <b>85732</b>          |              |     |              |              |
|  |   | 680464      | 010 | <b>85005</b>          |              |     |              |              |
|  |   | 680518      | 010 | <b>85700</b>          |              |     |              |              |
|  |   | 680584      |     | ...                   | ...          | 010 | <b>85938</b> | ...          |
|  |   | 680671      |     | ...                   | ...          | -1- | <b>85708</b> | ...          |
|  |   | 695172      | -1- | <b>85707</b>          |              |     |              |              |
|  |   | 695180      | -1- | <b>85705</b>          |              |     |              |              |
|  |   | 695181      | -1- | <b>85707</b>          |              |     |              |              |
|  |   | 695214      | -1- | <b>85722</b>          |              |     |              |              |
|  |   | 695348      | 010 | <b>87018</b>          |              |     |              |              |
|  |   | 695406      | -1- | <b>695406</b>         |              |     |              |              |
|  |   | 727600      | 010 | <b>83200</b>          |              |     |              |              |
|  |   | 727607      | 010 | <b>83207 or 89407</b> |              |     |              |              |
|  |   | 727609      | 010 | <b>83209</b>          |              |     |              |              |
|  |   | 727614      | 010 | <b>83214</b>          |              |     |              |              |
|  |   | 727615      | 010 | <b>83215</b>          |              |     |              |              |
|  |   | 727616      | 010 | <b>83216</b>          |              |     |              |              |
|  |   | 727619      | 010 | <b>83219</b>          |              |     |              |              |
|  |   | 727625      | 010 | <b>83225</b>          |              |     |              |              |
|  |   | 727628      | -10 | <b>83301</b>          |              |     |              |              |
|  |   | 727630      | 010 | <b>83303</b>          |              |     |              |              |
|  |   | 727631      | 010 | <b>83304</b>          |              |     |              |              |
|  |   | 727635      | 010 | <b>83308</b>          |              |     |              |              |
|  |   | 727636      | 010 | <b>83309 or 89446</b> |              |     |              |              |
|  |   | 727639      | 010 | <b>83312 or 89409</b> |              |     |              |              |
|  |   | 727641      | 010 | <b>83314</b>          |              |     |              |              |
|  |   | 727645      | -10 | <b>83318</b>          |              |     |              |              |
|  |   | 727671      | -1- | <b>83613</b>          |              |     |              |              |
|  |   | 727672      | 010 | <b>83242</b>          |              |     |              |              |
|  |   | 728601      | 010 | <b>85001 or 89410</b> |              |     |              |              |
|  |   | 728603      | 010 | <b>85003 or 89411</b> |              |     |              |              |
|  |   | 728604      | 010 | <b>85300</b>          |              |     |              |              |
|  |   | 728606      | 010 | <b>85302 or 89420</b> |              |     |              |              |

**APPLICATION GUIDE - TRUCKS, TRAILERS, AND BUSES**

| Year<br>Año<br>Année | Model<br>Modelo<br>Modèle | OEM # | Front   |   | Rear  |   |
|----------------------|---------------------------|-------|---|---|---|---|
|                      |                           |       |  |  |  |  |
|                      |                           |       | Fleetline   | GasSLX  | Fleetline   | GasSLX  |

**ARVIN MERITOR(Cont'd.)**

|                                  |        |     |                |     |     |     |
|----------------------------------|--------|-----|----------------|-----|-----|-----|
| Models with Manufacturing Number | 728608 | 010 | 85304          |     |     |     |
|                                  | 728609 | 010 | 85305          |     |     |     |
|                                  | 728611 | 010 | 85307          |     |     |     |
|                                  | 728612 | 010 | 85308 or 89422 |     |     |     |
|                                  | 728614 | -1- | 85310 or 89423 |     |     |     |
|                                  | 728615 | -10 | 85311 or 89424 |     |     |     |
|                                  | 728616 | 010 | 85004          |     |     |     |
|                                  | 728617 | 010 | 85005          |     |     |     |
|                                  | 728618 | 010 | 85006          |     |     |     |
|                                  | 728619 | 010 | 85007 or 89412 |     |     |     |
|                                  | 728621 | -10 | 85009          | ... | ... | ... |
|                                  | 728622 | 010 | 85010          |     |     |     |
|                                  | 728623 | 010 | 85011          |     |     |     |
|                                  | 728624 | 010 | 85012 or 89413 |     |     |     |
|                                  | 728625 | 010 | 85013 or 89414 |     |     |     |
|                                  | 728626 | 01- | 85733          |     |     |     |
|                                  | 728627 | 010 | 85313          |     |     |     |
|                                  | 728628 | 010 | 85314 or 89425 |     |     |     |
|                                  | 728631 | 010 | 85029          |     |     |     |
|                                  | 728632 | 010 | 85030 or 89440 |     |     |     |
|                                  | 728635 | -1- | 85318          |     |     |     |
|                                  | 728639 | 01- | 85026 or 89417 |     |     |     |
|                                  | 728640 | -1- | 85027 or 89418 |     |     |     |
|                                  | 728800 | -10 | 85711          |     |     |     |
|                                  | 728806 | 010 | 85736          |     |     |     |
|                                  | 728811 | -1- | 85707          |     |     |     |
|                                  | 728812 | -1- | 85705          |     |     |     |

**AUTOCAR**

**XPEDITOR**

|         |  |            |     |     |     |       |       |
|---------|--|------------|-----|-----|-----|-------|-------|
| 08 - 19 | 4 X 2 Models with Hendrickson Primaax EX 232 Air Suspensions<br>Standard with 8 1/2" to 10" Ride Height  | 60657-003  | ... | ... | 010 | 85072 | ...   |
|         |  | 60657-003L | ... | ... | 010 | 85072 | ...   |
| 08 - 19 | 6 X 4 Models with Hendrickson HMX 400/460 Haulmax with 16.5" Saddle  | 60680-004  | ... | ... | 01- | 83143 | ...   |
|         |  | 60680-004L | ... | ... | 01- | 83143 | ...   |
| 08 - 19 | 6 X 4 Models with Hendrickson HMX 400/460 Haulmax with 17.5" & 18.5" Saddle  | 60680-005  | ... | ... | 01- | 83142 | ...   |
|         |  | 60680-005L | ... | ... | 01- | 83142 | ...   |
| 08 - 19 | 6 X 4 Models with Hendrickson HN - 522   | 60680-003  | ... | ... | 01- | 83112 | ...   |
|         |  | 60680-003L | ... | ... | 01- | 83112 | ...   |
| 08 - 19 | 6 X 4 Models with Hendrickson Primaax EX 462 Air Suspensions<br>Standard with 12 1/2" - 14 3/8" - 15 1/2" Ride Height<br>Standard with 8 1/2" to 10" Ride Height | 60665-011  | ... | ... | 010 | 85967 | ...   |
|         |  | 60657-003  | ... | ... | 010 | 85072 | ...   |
|         |  | 60657-003L | ... | ... | 010 | 85072 | ...   |
| 08 - 19 | 8 X 4 Models with Chalmers 800 Series - 46K Tandem Truck Suspensions ( HD Shock Kit with High Mounts)  | 800670     | ... | ... | 010 | 85060 | ...   |
| 08 - 19 | 8 X 4 Models with Chalmers 800 Series - 46K Tandem Truck Suspensions ( HD Shock Kit with Low Mounts)   | 800781     | ... | ... | 010 | 85314 | 89425 |
| 08 - 19 | 8 X 4 Models with Hendrickson Primaax EX 462 Air Suspensions<br>Standard with 12 1/2" - 14 3/8" - 15 1/2" Ride Height<br>Standard with 8 1/2" to 10" Ride Height | 60665-011  | ... | ... | 010 | 85967 | ...   |
|         |  | 60657-003  | ... | ... | 010 | 85072 | ...   |
|         |  | 60657-003L | ... | ... | 010 | 85072 | ...   |



## APPLICATION GUIDE - TRUCKS, TRAILERS, AND BUSES

| Year<br>Año<br>Année | Model<br>Modelo<br>Modèle | OEM # | Front     |        |  | Rear |  |  |
|----------------------|---------------------------|-------|-----------|--------|--|------|--|--|
|                      |                           |       |           |        |  |      |  |  |
|                      |                           |       | Fleetline | GasSLX |  |      |  |  |

### AUTOCAR(Cont'd.)

#### XPERT(Cont'd.)

|                |  |            |     |     |     |              |     |
|----------------|--|------------|-----|-----|-----|--------------|-----|
|                | 4 X 2 Models (CLASS 7 & 8) with Hendrickson HAS-210 or HAS-230 Air Suspensions<br>With O.E.M. Number   | 60670-005  | ... | ... | OIO | <b>83137</b> | ... |
|                |  | 60675-003  | ... | ... | OIO | <b>85976</b> | ... |
|                |  | 60675-003L | ... | ... | OIO | <b>85976</b> | ... |
| <b>08 - 19</b> | 4 X 2 Models (CLASS 8) with Hendrickson EX-262 Air Suspensions   | 60665-013  | ... | ... | OIO | <b>85965</b> | ... |
| <b>08 - 19</b> | 6 X 4 Models with Hendrickson HMX 400 Haulmax with 16.5" Saddle  | 60680-004  | ... | ... | OI- | <b>83143</b> | ... |
|                |  | 60680-004L | ... | ... | OI- | <b>83143</b> | ... |
| <b>08 - 19</b> | 6 X 4 Models with Hendrickson HMX 400 Haulmax with 17.5" & 18.5" Saddle  | 60680-005  | ... | ... | OI- | <b>83142</b> | ... |
|                |  | 60680-005L | ... | ... | OI- | <b>83142</b> | ... |
| <b>08 - 19</b> | 6 X 4 Models with Hendrickson Primaax EX 462 Air Suspensions<br>Standard with 12 1/2" - 14 3/8" - 15 1/2" Ride Height<br>Standard with 8 1/2" to 10" Ride Height | 60665-011  | ... | ... | OIO | <b>85967</b> | ... |
|                |  | 60657-003  | ... | ... | OIO | <b>85072</b> | ... |
|                |  | 60657-003L | ... | ... | OIO | <b>85072</b> | ... |

#### XSPOTTER

|                |  |            |     |     |     |              |     |
|----------------|--|------------|-----|-----|-----|--------------|-----|
| <b>08 - 18</b> | 6 X 4 Off-Road Terminal Tractors with Hendrickson HN - 462 | 60680-003  | ... | ... | OI- | <b>83112</b> | ... |
|                |  | 60680-003L | ... | ... | OI- | <b>83112</b> | ... |

#### Additional Applications

|  |  |            |     |              |              |     |                           |
|--|--|------------|-----|--------------|--------------|-----|---------------------------|
|  | A42B, A42F, A64B A64F Models<br>From Feb. 1971<br>Thru Jan. 1971   | 03-1106460 | OIO | <b>85005</b> | <b>89430</b> | ... | ...                       |
|  |  | 28R010     | OIO | <b>83216</b> | ...          | ... | ...                       |
|  | ACM, ACL Models  | 35901-3201 | -   | ...          | ...          | OIO | <b>85024</b>              |
|  |  | 37301-3201 | -I- | <b>85027</b> | <b>89418</b> | ... | ...                       |
|  | C65T, C70T, C70TS, C90, C75, C90T, DC74, DC75, DC102, DC104 Models | .....      | OIO | <b>83216</b> | ...          | ... | ...                       |
|  | DC87T, DC9364 From Feb. 1971                                       | .....      | OIO | <b>83122</b> | <b>89406</b> | ... | ...                       |
|  | Models with Air Suspension and O.E.M. Number                       | 8026658    | -   | ...          | ...          | OIO | <b>85046</b> <b>89434</b> |
|  |  | 8071524    | -   | ...          | ...          | OIO | <b>85024</b> ...          |
|  | Models with Hendrickson HTS 210, HTS 230 and HTS 260 Suspensions   | 60665-025  | -   | ...          | ...          | OIO | <b>85036</b> <b>89405</b> |
|  |  | 60665-025L | -   | ...          | ...          | OIO | <b>85036</b> <b>89405</b> |
|  | Models with O.E.M. Number  | 1011839    | OIO | <b>83216</b> | ...          | ... | ...                       |
|  |  | 28CFG-910  | OIO | <b>83216</b> | ...          | ... | ...                       |
|  |  | 37301-3202 | OI- | <b>85026</b> | <b>89417</b> | ... | ...                       |
|  |  | 660186     | OIO | <b>83216</b> | ...          | ... | ...                       |
|  |  | 849246     | OIO | <b>83216</b> | ...          | ... | ...                       |

### BECK BUS

|  |                                      |           |     |              |     |     |              |     |
|--|--------------------------------------|-----------|-----|--------------|-----|-----|--------------|-----|
|  | Deck and 1/2 Bus - Spring Suspension | .....     | -   | <b>85307</b> | ... | OIO | <b>85307</b> | ... |
|  | Deck and 1/2 Bus - Trailing Wheel    | .....     | -   | ...          | ... | OIO | <b>85301</b> | ... |
|  | Deck and 1/2 Bus with Air Suspension | .....     | -   | <b>85304</b> | ... | OIO | <b>85304</b> | ... |
|  | Luxury Liner Bus - Spring Suspension | .....     | -   | <b>85307</b> | ... | OIO | <b>85307</b> | ... |
|  | Mainliner with Air Suspension        | .....     | -   | <b>85304</b> | ... | OIO | <b>85304</b> | ... |
|  | Models with O.E.M. Number            | 14QK-140  | OIO | <b>85304</b> | ... | ... | ...          |     |
|  |                                      | 14QK-2102 | -   | ...          | ... | OIO | <b>85304</b> |     |





### BENSON TRUCK BODIES INC.

|  |   |          |   |     |     |     |              |              |
|--|---|----------|---|-----|-----|-----|--------------|--------------|
|  | Models with Hendrickson Intrax Air Suspension | A-20002  | - | ... | ... | OIO | <b>85000</b> | <b>89436</b> |
|  | Models with Neway Air Suspension              | 90044089 | - | ... | ... | OIO | <b>83124</b> | <b>89407</b> |

### BERING TRUCK CORP.

|  |   |          |   |     |     |     |              |     |
|--|---|----------|---|-----|-----|-----|--------------|-----|
|  | HD80TT Models with Hendrickson HAS-400 Air Suspension | 47902-24 | - | ... | ... | OIO | <b>83137</b> | ... |
|  | Models with Hendrickson HAS-230 Air Suspension        | 47902-24 | - | ... | ... | OIO | <b>83137</b> | ... |

**APPLICATION GUIDE - TRUCKS, TRAILERS, AND BUSES**

| Year<br>Año<br>Année | Model<br>Modelo<br>Modèle | OEM # | Front   |   | Rear  |   |
|----------------------|---------------------------|-------|---|---|---|---|
|                      |                           |       |  |  |  |  |
|                      |                           |       | Fleetline   | GasSLX  | Fleetline   | GasSLX  |

**BERKSHIRE COACH**

|        |   |          |     |       |     |     |       |     |
|--------|---|----------|-----|-------|-----|-----|-------|-----|
| - 2019 | Ultra 28 Coaches with Ford E450 Chassis | ASH-1136 |     | ...   | ... | -10 | 83178 | ... |
|        |   | ASH-1154 | -10 | 83177 | ... |     | ...   | ... |

**BLUEBIRD SCHOOL BUS**









**All American Series (FE & RE Models)**

|             |  |              |                                    |          |       |     |       |       |
|-------------|--|--------------|------------------------------------|----------|-------|-----|-------|-------|
|             | Buses with 13,200 lb, 2-Leaf Parabolic Springs                                     | 1658525      | 010                                | 85971    | ...   |     | ...   | ...   |
|             |  | AMS65109     | 010                                | 85058    | 89431 |     | ...   | ...   |
|             | Buses with 19,000 lb - 21,000 lb - 2 Stage Leaf Springs                            | AMS65110     |                                    | ...      | ...   | 010 | 85005 | 89430 |
|             |  | 06 - 19      | Buses with Comfort Air Suspensions | 00085991 |       | ... | ...   | 010   |
| 47170000428 |  |              |                                    | ...      | ...   | 010 | 85006 | ...   |
| 60998-001   |  |              |                                    | ...      | ...   | 010 | 85006 | ...   |
| 60998-003   |  |              |                                    | ...      | ...   | 010 | 85006 | ...   |
| 06 - 19     | Buses with Hendrickson Airtek Front Air Suspension (10,000 lb Capacity)            | 58913-009    | 010                                | 85959    | ...   |     | ...   | ...   |
|             |  | 58913-009L   | 010                                | 85959    | ...   |     | ...   | ...   |
| - 2019      | Buses with Hendrickson Airtek Front Air Suspension (13, 200 to 14,600 lb Capacity) | 58913-011    | 010                                | 85959    | ...   |     | ...   | ...   |
|             |  | 58913-011L   | 010                                | 85959    | ...   |     | ...   | ...   |
| 98 - 15     | Buses with Hendrickson Parasteer Suspensions                                       | 0015222      | 010                                | 85919    | ...   |     | ...   | ...   |
|             |  | 0040015      | 010                                | 85919    | ...   |     | ...   | ...   |
|             |  | 481700131438 | 010                                | 85919    | ...   |     | ...   | ...   |
|             |  | 59483-000    | 010                                | 85919    | ...   |     | ...   | ...   |
|             |  | 60665-005    | 010                                | 85919    | ...   |     | ...   | ...   |
|             |  | 60665-005L   | 010                                | 85919    | ...   |     | ...   | ...   |
|             |  | 60998-002    | 010                                | 85919    | ...   |     | ...   | ...   |
|             |  | 60998-002L   | 010                                | 85919    | ...   |     | ...   | ...   |
| - 2019      | Buses with Hendrickson Softek Suspension (13,200 lb - 14,600 lb Capacity)          | 0106303      | 010                                | 85106    | ...   |     | ...   | ...   |
|             |  | 471700002919 | 010                                | 85106    | ...   |     | ...   | ...   |
|             |  | 58913-010    | 010                                | 85106    | ...   |     | ...   | ...   |
|             |  | 58913-010L   | 010                                | 85106    | ...   |     | ...   | ...   |
| 06 - 19     | Buses with Hendrickson Softek Suspension (8,500 lb - 10,000 lb Capacity)           | 58913-009    | 010                                | 85959    | ...   |     | ...   | ...   |
|             |  | 58913-009L   | 010                                | 85959    | ...   |     | ...   | ...   |
| 05 - 16     | Buses with Leaf Spring Rear Suspension   | 0088035      |                                    | ...      | ...   | 010 | 85090 | ...   |
|             |  | 47170000464  |                                    | ...      | ...   | 010 | 85090 | ...   |
|             | Buses with O.E.M. Number   | 0110808      | 010                                | 83124    | 89407 |     | ...   | ...   |
|             |  | 0823054      | 010                                | 85304    | ...   |     | ...   | ...   |
|             | FE Models School Bus (Front Engine)  | 0014605      |                                    | ...      | ...   | 010 | 85036 | 89405 |
|             |  | 0014985      |                                    | ...      | ...   | 010 | 83137 | ...   |
|             |  | 59057-001    |                                    | ...      | ...   | 010 | 83137 | ...   |
|             |  | 59057-002    |                                    | ...      | ...   | 010 | 85036 | 89405 |
|             | RE (Rear Engine) Models with Ridewell RAS - 227 Steer Axle Air Suspension          | 1260008      |                                    | ...      | ...   | 010 | 87017 | ...   |
|             |  | 90-2610 SP1  |                                    | ...      | ...   | 010 | 87017 | ...   |
|             | RE Models School Bus (Rear Engine) with 1 " Mounting Pins                          | 300-0614966  | 010                                | 85307    | ...   |     | ...   | ...   |
|             |  | 300-0614974  |                                    | ...      | ...   | 010 | 85304 | ...   |
|             |  | 609180       |                                    | ...      | ...   | 010 | 85304 | ...   |
|             |  | 614958       | 010                                | 85307    | ...   |     | ...   | ...   |

**D3 Series (FE & RE Models)**

|         |  |             |     |       |       |     |       |     |
|---------|--|-------------|-----|-------|-------|-----|-------|-----|
| 10 - 13 | Buses with Comfort Air Suspensions   | 00085991    |     | ...   | ...   | 010 | 85006 | ... |
|         |  | 47170000428 |     | ...   | ...   | 010 | 85006 | ... |
|         |  | 60998-001   |     | ...   | ...   | 010 | 85006 | ... |
|         |  | 60998-003   |     | ...   | ...   | 010 | 85006 | ... |
| 10 - 13 | Buses with Hendrickson Airtek Front Air Suspension                                 | 0110808     | 010 | 83124 | 89407 |     | ...   | ... |
| 10 - 13 | Buses with Hendrickson Airtek Front Air Suspension (13, 200 to 14,600 lb Capacity) | 58913-011   | 010 | 85959 | ...   |     | ...   | ... |

## APPLICATION GUIDE - TRUCKS, TRAILERS, AND BUSES

| Year<br>Año<br>Année | Model<br>Modelo<br>Modèle | OEM # | Front  |   | Rear   |   |
|----------------------|---------------------------|-------|--|---|--|---|
|                      |                           |       |  |  |  |  |
|                      |                           |       |   |  |   |  |
|                      |                           |       | Fleetline  | GasSLX  | Fleetline  | GasSLX  |

### BLUEBIRD SCHOOL BUS(Cont'd.)

#### D3 Series (FE & RE Models)(Cont'd.)

|         |  |              |     |       |     |     |       |
|---------|--|--------------|-----|-------|-----|-----|-------|
| 10 - 13 | Buses with Hendrickson Airtek Front Air Suspension (13, 200 to 14,600 lb Capacity) | 58913-011L   | OIO | 85959 | ... | ... | ...   |
| 10 - 13 | Buses with Hendrickson Softek Suspension (13,200 lb - 14,600 lb Capacity)          | 0106303      | OIO | 85106 | ... | ... | ...   |
|         |  | 471700002919 | OIO | 85106 | ... | ... | ...   |
|         |  | 58913-010    | OIO | 85106 | ... | ... | ...   |
|         |  | 58913-010L   | OIO | 85106 | ... | ... | ...   |
| 10 - 13 | Buses with Leaf Spring Rear Suspension   | 0088035      |     | ...   | ... | OIO | 85090 |
|         |  | 471700000464 |     | ...   | ... | OIO | 85090 |

#### TC 2000 Bus, TC/2000 FE Series

|  |   |             |     |       |     |     |       |
|--|---|-------------|-----|-------|-----|-----|-------|
|  | Buses with Neway Rear Air Suspension              | 90045050    |     | ...   | ... | OIO | 85914 |
|  | Buses with Ridewell Front Suspension Option #4540 | 1004167     | OIO | 85712 | ... |     | ...   |
|  |   | 1317767     | OIO | 85029 | ... |     | ...   |
|  |   | 1667831     | OIO | 85029 | ... |     | ...   |
|  |   | 300-1317767 | OIO | 85029 | ... |     | ...   |
|  |   | AMS65119    | OIO | 85029 | ... |     | ...   |
|  | Buses with Ridewell Rear Suspension Option #4540  | 1316546     |     | ...   | ... | OIO | 85006 |
|  |   | 1658533     |     | ...   | ... | OIO | 85010 |
|  |   | 305-0961284 |     | ...   | ... | OIO | 85734 |
|  | Buses with Standard Flat Leaf Rear Springs        | 1746163     |     | ...   | ... | OIO | 85006 |
|  | Buses with Standard Parabolic Front Springs       | 1658525     | OIO | 85971 | ... |     | ...   |

#### Type A School Bus

|         |  |               |     |       |     |     |       |
|---------|--|---------------|-----|-------|-----|-----|-------|
| 92 - 19 | MicroBird Type A School bus with Ford E350 Chassis | 8C24-18045-DA | -IO | 83177 | ... | ... | ...   |
|         |  | 8C2Z-18124-D  | -IO | 83177 | ... | ... | ...   |
|         |  | ASH-1154      | -IO | 83177 | ... | ... | ...   |
|         |  | AT-163G       | -IO | 83177 | ... | ... | ...   |
|         |  | 8C24-18080-DB |     | ...   | ... | -IO | 83178 |
|         |  | 8C2Z-18125-D  |     | ...   | ... | -IO | 83178 |
|         |  | ASH-1136      |     | ...   | ... | -IO | 83178 |
|         |  | AT-164G       |     | ...   | ... | -IO | 83178 |
| 00 - 19 | MicroBird Type A School bus with Ford E450 Chassis | 8C24-18045-DA | -IO | 83177 | ... | ... | ...   |
|         |  | 8C2Z-18124-D  | -IO | 83177 | ... | ... | ...   |
|         |  | ASH-1154      | -IO | 83177 | ... | ... | ...   |
|         |  | AT-163G       | -IO | 83177 | ... | ... | ...   |
|         |  | 8C24-18080-DB |     | ...   | ... | -IO | 83178 |
|         |  | 8C2Z-18125-D  |     | ...   | ... | -IO | 83178 |
|         |  | ASH-1136      |     | ...   | ... | -IO | 83178 |
|         |  | AT-164G       |     | ...   | ... | -IO | 83178 |

#### Vision Series

|         |  |              |     |       |     |     |       |
|---------|--|--------------|-----|-------|-----|-----|-------|
| 06 - 19 | Buses with Comfort Air Suspensions   | 00085991     |     | ...   | ... | OIO | 85006 |
|         |  | 471700000428 |     | ...   | ... | OIO | 85006 |
|         |  | 471700131545 |     | ...   | ... | OIO | 85006 |
|         |  | 60998-001    |     | ...   | ... | OIO | 85006 |
|         |  | 60998-003    |     | ...   | ... | OIO | 85006 |
|         | Buses with Hendrickson Airtek Front Air Suspension                                 | 00119797     | OIO | 85959 | ... |     | ...   |
|         |  | 65992-003    | OIO | 85959 | ... |     | ...   |
| 06 - 19 | Buses with Hendrickson Airtek Front Air Suspension (10,000 lb Capacity)            | 0055017      | OIO | 85959 | ... |     | ...   |
|         |  | 0085990      | OIO | 85959 | ... |     | ...   |
|         |  | 471700000456 | OIO | 85959 | ... |     | ...   |
|         |  | 58913-008    | OIO | 85959 | ... |     | ...   |
|         |  | 58913-008L   | OIO | 85959 | ... |     | ...   |
|         |  | 58913-009    | OIO | 85959 | ... |     | ...   |
|         |  | 58913-009L   | OIO | 85959 | ... |     | ...   |
| 12 - 19 | Buses with Hendrickson Airtek Front Air Suspension (13, 200 to 14,600 lb Capacity) | 58913-011    | OIO | 85959 | ... |     | ...   |

## APPLICATION GUIDE - TRUCKS, TRAILERS, AND BUSES

| Year<br>Año<br>Année | Model<br>Modelo<br>Modèle | OEM # | Front     |        | Rear      |        |
|----------------------|---------------------------|-------|-----------|--------|-----------|--------|
|                      |                           |       |           |        |           |        |
|                      |                           |       | Fleetline | GasSLX | Fleetline | GasSLX |

### BLUEBIRD SCHOOL BUS(Cont'd.)

#### Vision Series(Cont'd.)

|         |  |              |     |       |     |     |       |     |
|---------|--|--------------|-----|-------|-----|-----|-------|-----|
| 12 - 19 | Buses with Hendrickson Airtek Front Air Suspension (13, 200 to 14,600 lb Capacity) | 58913-011L   | OIO | 85959 | ... | ... | ...   | ... |
| - 2019  | Buses with Hendrickson Softek Suspension (13,200 lb - 14,600 lb Capacity)          | 0106303      | OIO | 85106 | ... | ... | ...   | ... |
|         |  | 471700002919 | OIO | 85106 | ... | ... | ...   | ... |
|         |  | 58913-010    | OIO | 85106 | ... | ... | ...   | ... |
|         |  | 58913-010L   | OIO | 85106 | ... | ... | ...   | ... |
| 06 - 19 | Buses with Hendrickson Softek Suspension (8,500 lb - 10,000 lb Capacity)           | 0055008      | OIO | 85959 | ... | ... | ...   | ... |
|         |  | 0085990      | OIO | 85959 | ... | ... | ...   | ... |
|         |  | 471700000456 | OIO | 85959 | ... | ... | ...   | ... |
|         |  | 58913-007    | OIO | 85959 | ... | ... | ...   | ... |
|         |  | 58913-007L   | OIO | 85959 | ... | ... | ...   | ... |
|         |  | 58913-009    | OIO | 85959 | ... | ... | ...   | ... |
| 05 - 16 | Buses with Leaf Spring Rear Suspension   | 0088035      |     | ...   | ... | OIO | 85090 | ... |
|         |  | 471700000464 |     | ...   | ... | OIO | 85090 | ... |

#### Additional Applications









|  |  |             |       |       |       |     |       |       |
|--|--|-------------|-------|-------|-------|-----|-------|-------|
|  | Buses with 3/4" Mounting Pins  | 2021459     |       | 85012 | ...   | OIO | 85012 | 89413 |
|  | Buses with 35" Chassis   | 303-1350628 | OIO   | 85712 | ...   |     | ...   | ...   |
|  |  | 90-1968     | OIO   | 85712 | ...   |     | ...   | ...   |
|  | Buses with Flat Leaf Rear Spring Suspensions (8,200 lb to 10,400 lb) | 1707405     |       | ...   | ...   | OIO | 85005 | 89430 |
|  | Buses with Neway Air Suspensions with O.E.M. Number                  | 1526417     |       | ...   | ...   | OIO | 85052 | ...   |
|  |  | 90044448    |       | ...   | ...   | OIO | 85051 | ...   |
|  |  | 90044915    |       | ...   | ...   | OIO | 83127 | ...   |
|  |  | 90045083    |       | ...   | ...   | OIO | 85910 | ...   |
|  | Buses with Reyco Air Suspension                                      | 1668722     | OIO   | 85030 | 89440 |     | ...   | ...   |
|  |  | 1668730     |       | ...   | ...   | OIO | 85013 | 89414 |
|  |  | 1722222     |       | ...   | ...   | OIO | 85013 | 89414 |
|  | City Bird Buses with 1 " Mounting Pins                               | 300-0614966 | OIO   | 85307 | ...   |     | ...   | ...   |
|  |  | 300-0614974 |       | ...   | ...   | OIO | 85304 | ...   |
|  |  | 609180      |       | ...   | ...   | OIO | 85304 | ...   |
|  |  | 614958      | OIO   | 85307 | ...   |     | ...   | ...   |
|  | Low Floor Bus Models with O.E.M. Number                              | 0075916     | OIO   | 85086 | ...   |     | ...   | ...   |
|  |  | 4759272     |       | ...   | ...   | - - | ...   | 89447 |
|  |  | 4760958     | OIO   | 85086 | ...   |     | ...   | ...   |
|  |  | 680667      |       | ...   | ...   | - - | ...   | 89447 |
|  | Motor Home with IFS (37 Foot)  | 7805-N-1002 | OIO   | 85329 | ...   |     | ...   | ...   |
|  |  | 7805-S-1007 | OIO   | 85329 | ...   |     | ...   | ...   |
|  | WanderLodge<br>Drive Axle<br>Front<br>with Reyco Air Suspension      | 1750793     |       | ...   | ...   | OIO | 85712 | ...   |
|  |  | 90-1968-SP1 | OIO   | 85712 | ...   |     | ...   | ...   |
|  |  | 1722214     |       | ...   | ...   | OIO | 85030 | 89440 |
|  | WanderLodge LX, LXI - Models<br>Front<br>Rear                        | 90-2497-SP1 |       | ....  | ...   |     | ...   | ...   |
|  |  | 90-1951-SP1 |       | ...   | ...   | OIO | 85734 | ...   |
|  | Models with O.E.M. Number  | 00119798    | OIO   | 85106 | ...   |     | ...   | ...   |
|  |  | 0020326     |       | ...   | ...   | OIO | 85976 | ...   |
|  |  | 300-1316546 |       | ...   | ...   | OIO | 85006 | ...   |
|  |  | 614974      | OIO   | 85304 | ...   |     | ...   | ...   |
|  |  | 65992-004   | OIO   | 85106 | ...   |     | ...   | ...   |
|  | 680783   | OIO         | 85304 | ...   |       | ... | ...   |       |

#### Additional O.E.M. Interchanges

|  |                                |         |     |       |  |  |  |  |
|--|--------------------------------|---------|-----|-------|--|--|--|--|
|  | Additional O.E.M. Interchanges | 0523047 | OIO | 85736 |  |  |  |  |
|--|--------------------------------|---------|-----|-------|--|--|--|--|



## APPLICATION GUIDE - TRUCKS, TRAILERS, AND BUSES

| Year<br>Año<br>Année | Model<br>Modelo<br>Modèle | OEM # | Front   |   | Rear  |   |
|----------------------|---------------------------|-------|---|---|---|---|
|                      |                           |       |  |  |  |  |
|                      |                           |       |  |  |  |  |
|                      |                           |       | Fleetline   | GasSLX  | Fleetline   | GasSLX  |

### CARPENTER BUS

|                           |          |     |              |     |     |              |     |
|---------------------------|----------|-----|--------------|-----|-----|--------------|-----|
| Models with O.E.M. Number | 0272-SS5 | OIO | <b>85712</b> | ... | OIO | ...          | ... |
|                           | 63-0001  |     | ...          | ... | OIO | <b>85713</b> | ... |

### CASCADE TRAILER

|                            |       |  |     |     |     |              |     |
|----------------------------|-------|--|-----|-----|-----|--------------|-----|
| Models with Air Suspension | 120-1 |  | ... | ... | OIO | <b>83125</b> | ... |
|----------------------------|-------|--|-----|-----|-----|--------------|-----|

### CATERPILLAR

|         |   |            |  |     |     |     |              |     |
|---------|---|------------|--|-----|-----|-----|--------------|-----|
| 12 - 17 | CT660 Models with Hendrickson HMX 460 Haulmax with 16.5" Saddle         | 60680-004  |  | ... | ... | OIO | <b>83143</b> | ... |
|         |   | 60680-004L |  | ... | ... | OIO | <b>83143</b> | ... |
| 12 - 17 | CT660 Models with Hendrickson HMX 460 Haulmax with 17.5" & 18.5" Saddle | 60680-005  |  | ... | ... | OIO | <b>83142</b> | ... |
|         |   | 60680-005L |  | ... | ... | OIO | <b>83142</b> | ... |

### CHALLENGE COOK

#### Cement Truck

|  |         |     |               |  |  |  |  |
|--|---------|-----|---------------|--|--|--|--|
| Cement Trucks with 1/2" Bearing mount          | 632147  | OIO | <b>632147</b> |  |  |  |  |
| Cement Trucks with 3/4" Bushing & Sleeve mount | 1540212 | OIO | <b>646155</b> |  |  |  |  |
|  | 1540459 | OIO | <b>646155</b> |  |  |  |  |
|  | 632155  | OIO | <b>646177</b> |  |  |  |  |

### CHALMERS SUSPENSION

|   |         |  |     |     |     |               |              |
|---|---------|--|-----|-----|-----|---------------|--------------|
| K800199 Model Shock Kit (Stanard)   | K800199 |  | ... | ... | OIO | <b>85060</b>  | ...          |
| K880233 Model Shock Kit (Standard 50K Suspension)                         | K880233 |  | ... | ... | OIO | <b>85060</b>  | ...          |
| K880247 Model Shock Kit   | K880247 |  | ... | ... | OIO | <b>85060</b>  | ...          |
| K880248 Model Shock Kit   | K880248 |  | ... | ... | OIO | <b>85314</b>  | <b>89425</b> |
| K880642 Model Shock Kit (Used on Western Star only)                       | K880642 |  | ... | ... | OIO | <b>85060</b>  | ...          |
| Single Axle Truck Suspension (1023-23K, 1030 -30K, 1040-40K)              | 665174  |  | ... | ... | OIO | <b>85060</b>  | ...          |
| 800 Series - 46K Tandem Truck Suspensins ( HD Shock Kit with High Mounts) | 800670  |  | ... | ... | OIO | <b>85060</b>  | ...          |
| 800 Series - 46K Tandem Truck Suspensins ( HD Shock Kit with Low Mounts)  | 800781  |  | ... | ... | OIO | <b>85314</b>  | <b>89425</b> |
| Models with O.E.M. Number   | 21335   |  | ... | ... | OIO | <b>G63355</b> | ...          |

### CHAMPION BUS INC

|        |  |          |     |              |     |     |              |     |
|--------|--|----------|-----|--------------|-----|-----|--------------|-----|
| - 2019 | American Coach Series Shuttle buses with Ford E350 and E450 Chassis                                  | ASH-1136 |     | ...          | ... | -IO | <b>83178</b> | ... |
|        |  | ASH-1154 | -IO | <b>83177</b> | ... | ... | ...          | ... |
| - 2019 | American Crusader Series Shuttle buses with Ford E350 Chassis  | ASH-1136 |     | ...          | ... | -IO | <b>83178</b> | ... |
|        |  | ASH-1154 | -IO | <b>83177</b> | ... | ... | ...          | ... |
| - 2019 | Challenger Series Shuttle buses with Ford E350 and E450 Chassis                                      | ASH-1136 |     | ...          | ... | -IO | <b>83178</b> | ... |
|        |  | ASH-1154 | -IO | <b>83177</b> | ... | ... | ...          | ... |
| - 2019 | Crusader Series Shuttle buses with Ford E350 Chassis   | ASH-1136 |     | ...          | ... | -IO | <b>83178</b> | ... |
|        |  | ASH-1154 | -IO | <b>83177</b> | ... | ... | ...          | ... |
| - 2019 | FL Transport Series Shuttle buses with Ford E450 Chassis   | ASH-1136 |     | ...          | ... | -IO | <b>83178</b> | ... |
|        |  | ASH-1154 | -IO | <b>83177</b> | ... | ... | ...          | ... |
|        | GMC P6000 Chassis  | 22064230 | -IO | <b>83136</b> | ... | ... | ...          | ... |
|        |  | 22064231 | -IO | ...          | ... | -IO | <b>85324</b> | ... |
|        | Models with Ford F650 and F750 Chassis - See Ford section for proper year and model information      | .....    |     | .....        |     |     |              |     |
|        | Models with Freightliner M2 Chassis - See Freightliner section for proper year and model information | .....    |     | .....        |     |     |              |     |

### CHANCE COACH

|                               |         |  |              |     |     |              |              |
|-------------------------------|---------|--|--------------|-----|-----|--------------|--------------|
| Buses with 3/4" Mounting Pins | 2021459 |  | <b>85012</b> | ... | OIO | <b>85012</b> | <b>89413</b> |
| Models with O.E.M. Number     | 59039   |  | <b>83207</b> | ... | OIO | <b>83207</b> | <b>89407</b> |



## APPLICATION GUIDE - TRUCKS, TRAILERS, AND BUSES

| Year<br>Año<br>Année | Model<br>Modelo<br>Modèle | OEM # | Front     |        |     | Rear |  |     |
|----------------------|---------------------------|-------|-----------|--------|-----|------|--|-----|
|                      |                           |       |           |        | ○ ○ |      |  | ○ ○ |
|                      |                           |       | Fleetline | GasSLX |     |      |  |     |

### CHANCE COACH(Cont'd.)

|                                |        |          |                  |              |     |              |              |     |
|--------------------------------|--------|----------|------------------|--------------|-----|--------------|--------------|-----|
| Models with O.E.M. Number      | 665017 | ○ ○      | ...              | ...          | ○ ○ | <b>85014</b> | ...          |     |
|                                | 6892   |          | <b>83207</b>     | ...          | ○ ○ | <b>83207</b> | <b>89407</b> |     |
|                                | 6893   |          | <b>83203</b>     | <b>89436</b> |     |              | ...          | ... |
|                                | 728600 |          | <b>83203</b>     | ...          | ○ ○ | <b>83203</b> | <b>89436</b> |     |
|                                | AS789B |          | <b>85014</b>     | ...          | ○ ○ | <b>85014</b> | ...          |     |
| Additional O.E.M. Interchanges |        | 270-6708 | ○ ○ <b>85014</b> |              |     |              |              |     |

### CHEVROLET TRUCK (ALSO SEE GMC TRUCK)

#### 4, 40, 4000 & 4500 Series

|         |  |                     |     |              |              |     |              |     |
|---------|--|---------------------|-----|--------------|--------------|-----|--------------|-----|
| 69 - 72 | All - Exc. Tilt Cab  | 22012096<br>3192892 |     | <b>83221</b> | ...          | ○ ○ | <b>83221</b> | ... |
|         |  |                     |     | <b>83221</b> | ...          | ○ ○ | <b>83221</b> | ... |
| 60 - 68 | C-40 , P-40, SS-40 Models                                      | .....               | ○ ○ | <b>85005</b> | <b>89430</b> |     | ...          | ... |
| 1968    | Cowl - Exc. School Bus   | 22012096            | ○ ○ | <b>83221</b> | ...          |     | ...          | ... |
|         |  | 3192892             | ○ ○ | <b>83221</b> | ...          |     | ...          | ... |
| 69 - 70 | D-D Forward Control with 9000 & 11000 lb Axles - Exc. Tilt Cab | 22012096            | ○ ○ | <b>83221</b> | ...          |     | ...          | ... |
|         |  | 3192892             | ○ ○ | <b>83221</b> | ...          |     | ...          | ... |
| 69 - 70 | D-D Forward Control with Tilt Cab                              | 22012095            | ○ ○ | <b>83126</b> | <b>89430</b> |     | ...          | ... |
|         |  | 4940606             | ○ ○ | <b>83126</b> | <b>89430</b> |     | ...          | ... |
| 67 - 72 | S-40 School Bus  | 22012096            |     | <b>83221</b> | ...          | ○ ○ | <b>83221</b> | ... |
|         |  | 3192892             |     | <b>83221</b> | ...          | ○ ○ | <b>83221</b> | ... |
| 67 - 68 | TDM 4 Cycle Detroit Diesel with Tandem Axle - Exc. Tilt Cab    | 22012096            |     | ...          | ...          | ○ ○ | <b>83221</b> | ... |
|         |  | 3192892             |     | ...          | ...          | ○ ○ | <b>83221</b> | ... |





#### 5, 50, 5000 & 5500 Series

|         |  |                     |     |              |              |     |              |              |
|---------|--|---------------------|-----|--------------|--------------|-----|--------------|--------------|
| 69 - 72 | All - Exc. Tilt Cab  | 22012096<br>3192892 |     | <b>83221</b> | ...          | ○ ○ | <b>83221</b> | ...          |
|         |  |                     |     | <b>83221</b> | ...          | ○ ○ | <b>83221</b> | ...          |
| 73 - 80 | C, M, S Chassis - Conventional Cab                             | 22007750            | ○ ○ | <b>83207</b> | <b>89407</b> |     | ...          | ...          |
|         |  | 4975467             | ○ ○ | <b>83207</b> | <b>89407</b> |     | ...          | ...          |
|         |  | 4975494             | ○ ○ | <b>83207</b> | <b>89407</b> |     | ...          | ...          |
| 75 - 80 | C, M, S Chassis - Conventional Cab                             | 4975510             | ○ ○ | <b>83221</b> | ...          |     | ...          | ...          |
| 76 - 89 | C, M, S Chassis - Conventional Cab                             | 22002294            | ○ ○ | <b>83304</b> | ...          |     | ...          | ...          |
|         |  | 22007752            | ○ ○ | <b>83304</b> | ...          |     | ...          | ...          |
|         |  | 22012096            |     | ...          | ...          | ○ ○ | <b>83221</b> | ...          |
|         |  | 22012169            |     | ...          | ...          | ○ ○ | <b>83221</b> | ...          |
| 73 - 80 | C, S Chassis - Conventional Cab and School Bus                 | 22012096            |     | ...          | ...          | ○ ○ | <b>83221</b> | ...          |
|         |  | 3192892             |     | ...          | ...          | ○ ○ | <b>83221</b> | ...          |
| 73 - 89 | C, S Chassis - Conventional Cab and School Bus                 | 22012095            |     | ...          | ...          | ○ ○ | <b>83126</b> | <b>89430</b> |
|         |  | 22012166            |     | ...          | ...          | ○ ○ | <b>83126</b> | <b>89430</b> |
| 63 - 69 | C-50, M-50, S-50, SE-50, T-50 Models                           | .....               | ○ ○ | <b>85005</b> | <b>89430</b> | ○ ○ | <b>83221</b> | ...          |
| 1968    | Cowl - Exc. School Bus   | 22012096            | ○ ○ | <b>83221</b> | ...          |     | ...          | ...          |
|         |  | 3192892             | ○ ○ | <b>83221</b> | ...          |     | ...          | ...          |
| 69 - 70 | D-D Forward Control with 9000 & 11000 lb Axles - Exc. Tilt Cab | 22012096            | ○ ○ | <b>83221</b> | ...          |     | ...          | ...          |
|         |  | 3192892             | ○ ○ | <b>83221</b> | ...          |     | ...          | ...          |
| 69 - 70 | D-D Forward Control with Tilt Cab                              | 22012095            | ○ ○ | <b>83126</b> | <b>89430</b> |     | ...          | ...          |
|         |  | 4940606             | ○ ○ | <b>83126</b> | <b>89430</b> |     | ...          | ...          |
| 69 - 72 | S-50 School Bus  | 3192892             |     | <b>83221</b> | ...          | ○ ○ | <b>83221</b> | ...          |
| 73 - 78 | S-50 School Bus  | 22012166            |     | ...          | ...          | ○ ○ | <b>83126</b> | <b>89430</b> |
|         |  | 3192892             |     | ...          | ...          | ○ ○ | <b>83221</b> | ...          |
| 67 - 68 | TDM 4 Cycle Detroit Diesel with Tandem Axle - Exc. Tilt Cab    | 22012096            |     | ...          | ...          | ○ ○ | <b>83221</b> | ...          |
|         |  | 3192892             |     | ...          | ...          | ○ ○ | <b>83221</b> | ...          |
| 71 - 72 | TDM 4 Cycle Detroit Diesel with Tandem Axle - Exc. Tilt Cab    | 22012095            |     | ...          | ...          | ○ ○ | <b>83126</b> | <b>89430</b> |
|         |  | 4940606             |     | ...          | ...          | ○ ○ | <b>83126</b> | <b>89430</b> |

#### 6, 60, 6000 & 6500 Series

|         |  |                     |     |              |              |     |              |     |
|---------|--|---------------------|-----|--------------|--------------|-----|--------------|-----|
| 69 - 72 | All - Exc. Tilt Cab                            | 22012096<br>3192892 |     | <b>83221</b> | ...          | ○ ○ | <b>83221</b> | ... |
|         |  |                     |     | <b>83221</b> | ...          | ○ ○ | <b>83221</b> | ... |
| 68 - 69 | All with 9000 & 11000 lb Axles - Exc. Tilt Cab | 22012095            | ○ ○ | <b>83126</b> | <b>89430</b> |     | ...          | ... |

**APPLICATION GUIDE - TRUCKS, TRAILERS, AND BUSES**





| Year<br>Año<br>Année | Model<br>Modelo<br>Modèle | OEM # | Front   |   | Rear  |   |
|----------------------|---------------------------|-------|---|---|---|---|
|                      |                           |       |  |  |  |  |
|                      |                           |       | Fleetline   | GasSLX  | Fleetline   | GasSLX  |

**CHEVROLET TRUCK (ALSO SEE GMC TRUCK)(Cont'd.)**

**6, 60, 6000 & 6500 Series(Cont'd.)**

|         |   |          |     |       |       |     |       |       |
|---------|---|----------|-----|-------|-------|-----|-------|-------|
| 68 - 69 | All with 9000 & 11000 lb Axles - Exc. Tilt Cab  | 4940606  | 010 | 83126 | 89430 |     | ...   | ...   |
| 79 - 89 | B6P042 School Bus (Axle codes F070, F070D)  | 22002294 | 010 | 83304 | ...   |     | ...   | ...   |
|         |   | 22007752 | 010 | 83304 | ...   |     | ...   | ...   |
| 79 - 89 | B6P042 School Bus (Axle codes F090, F120D)  | 22002295 | 010 | 83303 | ...   |     | ...   | ...   |
|         |   | 22007753 | 010 | 83303 | ...   |     | ...   | ...   |
|         |   | 22017531 | 010 | 83303 | ...   |     | ...   | ...   |
| 79 - 89 | B6P042 School Bus w/15000 lb or 17000 lb Rear Springs                                 | 22012096 |     | ...   | ...   | 010 | 83221 | ...   |
|         |   | 22012169 |     | ...   | ...   | 010 | 83221 | ...   |
| 79 - 89 | B6P042 School Bus w/18500 or 20800 lb Rear Springs                                    | 22012095 |     | ...   | ...   | 010 | 83126 | 89430 |
|         |   | 22012166 |     | ...   | ...   | 010 | 83126 | 89430 |
| 76 - 89 | C, M Chassis - Conventional Cab   | 22002294 | 010 | 83304 | ...   |     | ...   | ...   |
|         |   | 22007752 | 010 | 83304 | ...   |     | ...   | ...   |
| 75 - 80 | C, M, S Chassis - Conventional Cab and School Bus                                     | 4975510  | 010 | 83221 | ...   |     | ...   | ...   |
| 73 - 75 | C, M, S Chassis - Conventional Cab and School Bus with 5000 & 7000 lb Axle            | 22007750 | 010 | 83207 | 89407 |     | ...   | ...   |
|         |   | 4975467  | 010 | 83207 | 89407 |     | ...   | ...   |
|         |   | 4975494  | 010 | 83207 | 89407 |     | ...   | ...   |
| 73 - 89 | C, S Chassis - Conventional Cab and School Bus - Exc. with 20800 & 23000 lb Rear Axle | 22012096 |     | ...   | ...   | 010 | 83221 | ...   |
|         |   | 22012169 |     | ...   | ...   | 010 | 83221 | ...   |
|         |   | 3192892  |     | ...   | ...   | 010 | 83221 | ...   |
| 73 - 89 | C, S Chassis - Conventional Cab and School Bus with 20800 & 23000 lb Rear Axles       | 22012095 |     | ...   | ...   | 010 | 83126 | 89430 |
|         |   | 22012166 |     | ...   | ...   | 010 | 83126 | 89430 |
|         |   | 4940606  |     | ...   | ...   | 010 | 83126 | 89430 |
| 79 - 89 | C, S Chassis - Conventional Cab and School Bus  | 22002295 | 010 | 83303 | ...   |     | ...   | ...   |
|         |   | 22007753 | 010 | 83303 | ...   |     | ...   | ...   |
|         |   | 22017530 | 010 | 83303 | ...   |     | ...   | ...   |
|         |   | 22017531 | 010 | 83303 | ...   |     | ...   | ...   |
| 73 - 80 | C, S, T Chassis - Conventional & Tilt Cab and School Bus with 5000 & 7000 lb Axle     | 22002293 | 010 | 83126 | 89430 |     | ...   | ...   |
|         |   | 22007701 | 010 | 83126 | 89430 |     | ...   | ...   |
|         |   | 22007751 | 010 | 83303 | ...   |     | ...   | ...   |
|         |   | 22012095 | 010 | 83126 | 89430 |     | ...   | ...   |
|         |   | 3192890  | 010 | 83126 | 89430 |     | ...   | ...   |
|         |   | 4940606  | 010 | 83126 | 89430 |     | ...   | ...   |
|         |   | 4940662  | 010 | 83126 | 89430 |     | ...   | ...   |
|         |   | 4975497  | 010 | 83126 | 89430 |     | ...   | ...   |
| 71 - 72 | Conventional Cab & Tilt Cab with 9000 & 11000 lb Axles                                | 22012095 |     | ...   | ...   | 010 | 83126 | 89430 |
|         |   | 4940606  |     | ...   | ...   | 010 | 83126 | 89430 |
| 1968    | Cowl - Exc. School Bus  | 22012096 | 010 | 83221 | ...   |     | ...   | ...   |
|         |   | 3192892  | 010 | 83221 | ...   |     | ...   | ...   |
| 69 - 70 | D - D Forward Control with 9000 & 11000 lb Axles - Exc. Tilt Cab                      | 22012096 | 010 | 83221 | ...   |     | ...   | ...   |
|         |   | 3192892  | 010 | 83221 | ...   |     | ...   | ...   |
| 76 - 89 | S Chassis - School Bus  | 22002294 | 010 | 83304 | ...   |     | ...   | ...   |
|         |   | 22007702 | 010 | 83304 | ...   |     | ...   | ...   |
|         |   | 22007752 | 010 | 83304 | ...   |     | ...   | ...   |
| 69 - 78 | S-60  | 3192892  |     | 83221 | ...   | 010 | 83221 | ...   |
|         |   | 4975510  |     | 83221 | ...   | 010 | 83221 | ...   |
| 73 - 78 | S-60 w/Air Brakes   | 22007701 |     | ...   | ...   | 010 | 83126 | 89430 |
|         |   | 22007751 |     | ...   | ...   | 010 | 83303 | ...   |
|         |   | 22012095 |     | ...   | ...   | 010 | 83126 | 89430 |
|         |   | 22012166 |     | ...   | ...   | 010 | 83126 | 89430 |
|         |   | 3171069  |     | ...   | ...   | 010 | 85304 | ...   |
|         |   | 4940606  |     | ...   | ...   | 010 | 83126 | 89430 |

**APPLICATION GUIDE - TRUCKS, TRAILERS, AND BUSES**

| Year<br>Año<br>Année | Model<br>Modelo<br>Modèle | OEM # | Front   |   | Rear  |  |
|----------------------|---------------------------|-------|---|---|---|--|
|                      |                           |       |  Fleetline |  GasSLX |  Fleetline |  GasSLX |

**CHEVROLET TRUCK (ALSO SEE GMC TRUCK)(Cont'd.)**





**6, 60, 6000 & 6500 Series(Cont'd.)**

|         |   |          |     |       |       |     |       |       |
|---------|---|----------|-----|-------|-------|-----|-------|-------|
| 73 - 75 | SE, SS-60 thru Serial # 134487 (1975 1st Design)                | 22007700 | 010 | 83207 | 89407 |     | ...   | ...   |
|         |   | 22007750 | 010 | 83207 | 89407 |     | ...   | ...   |
|         |   | 4975467  | 010 | 83207 | 89407 |     | ...   | ...   |
|         |   | 4975494  | 010 | 83207 | 89407 |     | ...   | ...   |
| 76 - 78 | SE-60 From Serial # 120000 (1976 2nd Design)                    | 22002294 | 010 | 83304 | ...   |     | ...   | ...   |
|         |   | 22007752 | 010 | 83304 | ...   |     | ...   | ...   |
| 76 - 78 | SE-60 w/Hydraulic Brakes from Serial # 120000 (1975 2nd Design) | 22012169 |     | ...   | ...   | 010 | 83221 | ...   |
|         |   | 3192892  |     | ...   | ...   | 010 | 83221 | ...   |
| 73 - 74 | SG, SM-60   | 3192890  | 010 | 83126 | 89430 |     | ...   | ...   |
| 73 - 74 | SG, SM-61   | 4940606  | 010 | 83126 | 89430 |     | ...   | ...   |
| 73 - 74 | SG, SM-62   | 22002293 | 010 | 83126 | 89430 |     | ...   | ...   |
| 73 - 74 | SG, SM-63   | 22007701 | 010 | 83126 | 89430 |     | ...   | ...   |
| 73 - 74 | SG, SM-64   | 22007751 | 010 | 83303 | ...   |     | ...   | ...   |
| 60 - 62 | Standard and Heavy Duty Truck and School Bus (2 Ton)            | .....    |     | ...   | ...   | 010 | 83221 | ...   |
| 71 - 72 | TDM 4 Cycle Detroit Diesel with Tandem Axle                     | 22012095 |     | ...   | ...   | 010 | 83126 | 89430 |
|         |   | 4940606  |     | ...   | ...   | 010 | 83126 | 89430 |
| 67 - 68 | TDM 4 Cycle Detroit Diesel with Tandem Axle - Exc. Tilt Cab     | 22012096 |     | ...   | ...   | 010 | 83221 | ...   |
|         |   | 3192892  |     | ...   | ...   | 010 | 83221 | ...   |
| 79 - 80 | W Chassis - 72" BBC Steel Tilt Cab                              | 22002293 | 010 | 83126 | 89430 |     | ...   | ...   |
|         |   | 22007751 | 010 | 83303 | ...   |     | ...   | ...   |

**7, 70 & 7000 Series**

|         |   |          |     |       |       |     |       |       |
|---------|---|----------|-----|-------|-------|-----|-------|-------|
| 66 - 72 | 72" BBC Steel Tilt Cab with V-6 2 Cycle Diesel Engine   | 22012095 | 010 | 83126 | 89430 |     | ...   | ...   |
|         |   | 3171462  | 010 | 83126 | 89430 |     | ...   | ...   |
|         |   | 3192890  | 010 | 83126 | 89430 |     | ...   | ...   |
| 66 - 72 | 72" BBC Steel Tilt Cab with V-6 2 Cycle Diesel Engine with 17201 and 17221 Axle                                       | 22012096 |     | ...   | ...   | 010 | 83221 | ...   |
|         |   | 3192892  |     | ...   | ...   | 010 | 83221 | ...   |
| 66 - 72 | 72" BBC Steel Tilt Cab with V-6 2 Cycle Diesel Engine with 19101 and 19201 Axle                                       | 4940600  |     | ...   | ...   | 010 | 83209 | 89414 |
| 66 - 72 | 92" BBC Conventional Cab  | 3192657  | 010 | 83216 | ...   |     | ...   | ...   |
|         |   | 4940614  | 010 | 83216 | ...   |     | ...   | ...   |
|         |   | 4963854  | 010 | 83216 | ...   |     | ...   | ...   |
| 79 - 89 | C, M Chassis - 97" BBC Conventional Cab   | 22002294 | 010 | 83304 | ...   |     | ...   | ...   |
|         |   | 22002295 | 010 | 83303 | ...   |     | ...   | ...   |
|         |   | 22007752 | 010 | 83304 | ...   |     | ...   | ...   |
|         |   | 22007753 | 010 | 83303 | ...   |     | ...   | ...   |
|         |   | 22012095 |     | ...   | ...   | 010 | 83126 | 89430 |
|         |   | 22012166 |     | ...   | ...   | 010 | 83126 | 89430 |
|         |   | 22017530 | 010 | 83303 | ...   |     | ...   | ...   |
|         |   | 22017531 | 010 | 83303 | ...   |     | ...   | ...   |
| 66 - 72 | Conventional Cab with Tapered 2-Leaf Softride 11000 lb Rating and F120 Axle (12000 lb)                                | 22046483 | 010 | 85304 | ...   |     | ...   | ...   |
|         |   | 22052336 | 010 | 85304 | ...   |     | ...   | ...   |
|         |   | 3171069  | 010 | 85304 | ...   |     | ...   | ...   |
| 66 - 72 | Conventional Cab With Tapered 2-Leaf Softride 7000 & 9000 lb Rating and F070, F090, F120 Axle (7000, 9000 & 12000 lb) | 3171068  | 010 | 83216 | ...   |     | ...   | ...   |
|         |   | 3192657  | 010 | 83216 | ...   |     | ...   | ...   |
|         |   | 4940614  | 010 | 83216 | ...   |     | ...   | ...   |
|         |   | 4963853  | 010 | 83216 | ...   |     | ...   | ...   |
|         |   | 4963854  | 010 | 83216 | ...   |     | ...   | ...   |
| 77 - 80 | H, J Chassis - 92" BBC Conventional Cab   | 4963854  | 010 | 83216 | ...   |     | ...   | ...   |
|         |   | 4984526  | 010 | 83216 | ...   |     | ...   | ...   |
| 73 - 80 | H, J Chassis - 92" BBC Conventional Cab with V-6, V8 Diesel Engines   | 4940614  | 010 | 83216 | ...   |     | ...   | ...   |
|         |   | 4963854  | 010 | 83216 | ...   |     | ...   | ...   |
| 73 - 80 | H, J, M Chassis - 92" & 114" BBC Conventional Cab   | 2204683  | 010 | 85304 | ...   |     | ...   | ...   |

**APPLICATION GUIDE - TRUCKS, TRAILERS, AND BUSES**

| Year<br>Año<br>Année | Model<br>Modelo<br>Modèle | OEM # | Front   |   | Rear  |   |
|----------------------|---------------------------|-------|---|---|---|---|
|                      |                           |       |  |  |  |  |
|                      |                           |       | Fleetline   | GasSLX  | Fleetline   | GasSLX  |

**CHEVROLET TRUCK (ALSO SEE GMC TRUCK)(Cont'd.)**

**7, 70 & 7000 Series(Cont'd.)**

|         |  |          |     |       |       |     |       |       |
|---------|--|----------|-----|-------|-------|-----|-------|-------|
| 73 - 80 | H, J, M Chassis - 92" & 114" BBC Conventional Cab                        | 3171069  | 010 | 85304 | ...   |     | ...   | ...   |
| 73 - 80 | R Chassis - Rear Engine Bus  | 22012090 | 010 | 85308 | 89422 |     | ...   | ...   |
|         |  | 5552451  | 010 | 85308 | 89422 |     | ...   | ...   |
|         |  | 5552456  |     | ...   | ...   | 010 | 85307 | ...   |
|         |  | 5552552  |     | ...   | ...   | 010 | 85303 | 89422 |
| 83 - 84 | S7T042 Forward Control Chassis w/17000, 18500, 21000, 23000 lb Rear Axle | 22012095 |     | ...   | ...   | 010 | 83126 | 89430 |
|         |  | 22012166 |     | ...   | ...   | 010 | 83126 | 89430 |
| 83 - 84 | STT042 Forward Control Chassis   | 22012065 | 010 | 85304 | ...   |     | ...   | ...   |
|         |  | 3171069  | 010 | 85304 | ...   |     | ...   | ...   |
| 73 - 80 | T, W Chassis - 72" BBC Steel Tilt Cab (4 x 2) with V-6 Diesel Engine     | 22007751 | 010 | 83303 | ...   |     | ...   | ...   |
|         |  | 22012095 | 010 | 83126 | 89430 |     | ...   | ...   |
|         |  | 4940606  | 010 | 83126 | 89430 |     | ...   | ...   |
|         |  | 4975497  | 010 | 83126 | 89430 |     | ...   | ...   |
| 73 - 80 | T, W Chassis - 72" BBC Steel Tilt Cab with V-6 Gas Engine                | 22012091 | 010 | 85303 | 89422 |     | ...   | ...   |
|         |  | 5552452  | 010 | 85303 | 89422 |     | ...   | ...   |





**8, 80 & 8000 Series**

|         |   |          |     |       |       |     |       |       |
|---------|---|----------|-----|-------|-------|-----|-------|-------|
| 66 - 69 | 72" BBC Steel Tilt Cab  | 5544060  | 010 | 85302 | 89420 |     | ...   | ...   |
| 66 - 72 | 92" BBC Conventional Cab  | 3171068  | 010 | 83216 | ...   |     | ...   | ...   |
|         |   | 3192657  | 010 | 83216 | ...   |     | ...   | ...   |
|         |   | 4940614  | 010 | 83216 | ...   |     | ...   | ...   |
|         |   | 4963853  | 010 | 83216 | ...   |     | ...   | ...   |
|         |   | 4963854  | 010 | 83216 | ...   |     | ...   | ...   |
| 66 - 72 | 92" BBC Conventional Cab with 7000 & 9000 lb Axles - Exc. 2-Leaf Softride | 22046483 | 010 | 85304 | ...   |     | ...   | ...   |
|         |   | 22052336 | 010 | 85304 | ...   |     | ...   | ...   |
|         |   | 3171069  | 010 | 85304 | ...   |     | ...   | ...   |
| 79 - 82 | H, J Chassis - 92" BBC Conventional Cab 4 x 2 with Air Suspension         | 22012065 |     | ...   | ...   | 010 | 85304 | ...   |
|         |   | 22046483 |     | ...   | ...   | 010 | 85304 | ...   |
|         |   | 22052336 |     | ...   | ...   | 010 | 85304 | ...   |
|         |   | 3171069  |     | ...   | ...   | 010 | 85304 | ...   |
| 73 - 81 | H, J Chassis - 92" BBC Conventional Cab                                   | 4940614  | 010 | 83216 | ...   |     | ...   | ...   |
|         |   | 4963854  | 010 | 83216 | ...   |     | ...   | ...   |
|         |   | 4984526  | 010 | 83216 | ...   |     | ...   | ...   |
| 73 - 86 | H, J, M Chassis - 92" & 114" BBC Conventional Cab                         | 22046483 | 010 | 85304 | ...   |     | ...   | ...   |
|         |   | 22052336 | 010 | 85304 | ...   |     | ...   | ...   |
|         |   | 3171069  | 010 | 85304 | ...   |     | ...   | ...   |
| 73 - 80 | R Chassis - Rear Engine Bus   | 22012090 | 010 | 85308 | 89422 |     | ...   | ...   |
|         |   | 22012091 |     | ...   | ...   | 010 | 85303 | 89422 |
|         |   | 5552451  | 010 | 85308 | 89422 |     | ...   | ...   |
|         |   | 5552452  |     | ...   | ...   | 010 | 85303 | 89422 |
|         |   | 5552456  |     | ...   | ...   | 010 | 85307 | ...   |
| 70 - 80 | T, W Chassis - 72" BBC Steel Tilt Cab with V-6 Gas Engine                 | 22012091 | 010 | 85303 | 89422 |     | ...   | ...   |
|         |   | 5552452  | 010 | 85303 | 89422 |     | ...   | ...   |

**9000 Series**

|         |  |          |     |       |     |     |       |     |
|---------|--|----------|-----|-------|-----|-----|-------|-----|
| 70 - 72 | 54" BBC Aluminum Tilt Cab 6 x 4              | 22046483 |     | 85304 | ... | 010 | 85304 | ... |
|         |  | 22052336 |     | 85304 | ... | 010 | 85304 | ... |
|         |  | 3171069  |     | 85304 | ... | 010 | 85304 | ... |
| 70 - 72 | 92" & 114" BBC Conventional Cab - Exc. 6 x 4 | 4940614  | 010 | 83216 | ... |     | ...   | ... |
|         |  | 4963854  | 010 | 83216 | ... |     | ...   | ... |
| 70 - 72 | 92" & 114" BBC Conventional Cab 6 x 4        | 22046483 |     | 85304 | ... | 010 | 85304 | ... |
|         |  | 22052336 |     | 85304 | ... | 010 | 85304 | ... |
|         |  | 3171069  |     | 85304 | ... | 010 | 85304 | ... |

**APPLICATION GUIDE - TRUCKS, TRAILERS, AND BUSES**

| Year<br>Año<br>Année | Model<br>Modelo<br>Modèle | OEM # | Front   |  |   | Rear  |           |        |
|----------------------|---------------------------|-------|---|--|---|---|-----------|--------|
|                      |                           |       |  |  |  |  | Fleetline | GasSLX |

**CHEVROLET TRUCK (ALSO SEE GMC TRUCK)(Cont'd.)**

**9000 Series(Cont'd.)**

|         |  |          |     |       |       |     |       |     |
|---------|--|----------|-----|-------|-------|-----|-------|-----|
| 70 - 86 | D, F Chassis - 54" BBC Aluminum Tilt Cab with Rear GM Air Ride Suspension (4 Req'd)                                  | 22012065 |     | 85304 | ...   | 010 | 85304 | ... |
|         |  | 22046483 |     | 85304 | ...   | 010 | 85304 | ... |
|         |  | 22052336 |     | 85304 | ...   | 010 | 85304 | ... |
|         |  | 3171069  |     | 85304 | ...   | 010 | 85304 | ... |
| 70 - 86 | H, J Chassis - 92" BBC Conventional Cab  | 22046483 | 010 | 85304 | ...   |     | ...   | ... |
|         |  | 22052336 | 010 | 85304 | ...   |     | ...   | ... |
|         |  | 3171069  | 010 | 85304 | ...   |     | ...   | ... |
| 77 - 86 | M, N Chassis - 114" BBC Conventional & 108" BBC Aluminum Conventional Cab with Rear GM Air-Ride Suspension (4 Req'd) | 22012065 |     | 85304 | ...   | 010 | 85304 | ... |
|         |  | 22046483 |     | 85304 | ...   | 010 | 85304 | ... |
|         |  | 22052336 |     | 85304 | ...   | 010 | 85304 | ... |
|         |  | 3171069  |     | 85304 | ...   | 010 | 85304 | ... |
| 70 - 80 | T, W Chassis - 72" BBC Steel Tilt Cab  | 22012091 | 010 | 85303 | 89422 |     | ...   | ... |
|         |  | 5552452  | 010 | 85303 | 89422 |     | ...   | ... |

**B - Series - School Bus**

|         |   |          |     |       |     |     |       |     |
|---------|---|----------|-----|-------|-----|-----|-------|-----|
| 90 - 98 | B6, B7 Model School Bus Chassis<br>With 11000, 13500, 15000 lb Taperleaf Springs<br>With 15000, 19000, 21000 lb Multileaf Springs | 22064231 |     | ...   | ... | - - | 85324 | ... |
|         |   | 15174902 |     | ...   | ... | - - | 85071 | ... |
|         |   | 22064232 |     | ...   | ... | - - | 85071 | ... |
|         | Models with O.E.M. Number   | 15123676 | - - | 83136 | ... |     | ...   | ... |
|         |   | 15588554 | - - | 83136 | ... |     | ...   | ... |
|         |   | 22064230 | - - | 83136 | ... |     | ...   | ... |
|         |   | 88982682 | - - | 83136 | ... |     | ...   | ... |





**C - Series (C4500, C5500) Kodiak**

|         |   |          |     |       |     |     |       |     |
|---------|---|----------|-----|-------|-----|-----|-------|-----|
| 90 - 09 | C Chassis - Conventional Cab<br>Front Shock with O.E.M. Number<br><br>With 15000, 19000, 21000 lb Multileaf Springs | 15123676 | - - | 83136 | ... |     | ...   | ... |
|         |   | 15588554 | - - | 83136 | ... |     | ...   | ... |
|         |   | 15887728 | - - | 83136 | ... |     | ...   | ... |
|         |   | 19152843 | - - | 83136 | ... |     | ...   | ... |
|         |   | 22064230 | - - | 83136 | ... |     | ...   | ... |
|         |   | 88982682 | - - | 83136 | ... |     | ...   | ... |
|         |   | 15174902 |     | ...   | ... | - - | 85071 | ... |
|         |   | 22064232 |     | ...   | ... | - - | 85071 | ... |
|         |   | 88982686 |     | ...   | ... | - - | 85071 | ... |
| 04 - 09 | C Chassis - Conventional Cab (Non 4x4 Option) with 13,500 Multi-leaf Spring   | 15185644 |     | ...   | ... | 010 | 83155 | ... |
|         |   | 508-89   |     | ...   | ... | 010 | 83155 | ... |
|         |   | L-12706  |     | ...   | ... | 010 | 83155 | ... |
| 1990 -  | C Chassis - Conventional Cab w/11000, 13500, 15000 lb Taperleaf Springs   | 22064231 |     | ...   | ... | - - | 85324 | ... |
| 90 - 06 | C Chassis - Conventional Cab w/16900 or 17850 lb Taperleaf Springs  | 21998392 |     | ...   | ... | - - | 85336 | ... |
|         |   | 22064489 |     | ...   | ... | - - | 85336 | ... |
|         |   | 88963409 |     | ...   | ... | - - | 85336 | ... |
| 1990 -  | C Chassis - Conventional Cab w/19000, 21000, 23000 lb Taperleaf Springs (EXC Low Profile Vehicle)                   | 22064233 |     | ...   | ... | - - | 83136 | ... |
| 83 - 99 | C Chassis - Conventional Cab with 9100 to 17500 lb Rear Axle  | 22064432 |     | ...   | ... | 010 | 85050 | ... |
| 03 - 09 | C Chassis - Conventional Cab with Taperleaf Rear Suspension<br>Models with O.E.M. Number                            | 15185643 |     | ...   | ... | 010 | 83153 | ... |
|         |   | 88982684 | - - | 83136 | ... |     | ...   | ... |
|         |   | 88982688 |     | ...   | ... | - - | 85336 | ... |

**C - Series (C6500, C7500, C8500) Kodiak**

|         |  |          |     |       |     |     |       |     |
|---------|--|----------|-----|-------|-----|-----|-------|-----|
| 04 - 08 | Conventional Cab (Low Profile) with 12000, 15000, & 17000 lb Leaf Spring | 15174901 |     | ...   | ... | - - | 85342 | ... |
|         |  | 507-22   |     | ...   | ... | - - | 85342 | ... |
|         |  | 88982685 |     | ...   | ... | - - | 85342 | ... |
| 90 - 09 | Conventional Cab w/ Front Shock with O.E.M. Number                       | 15123676 | - - | 83136 | ... |     | ...   | ... |

**APPLICATION GUIDE - TRUCKS, TRAILERS, AND BUSES**

| Year<br>Año<br>Année | Model<br>Modelo<br>Modèle | OEM # | Front   |   | Rear  |   |
|----------------------|---------------------------|-------|---|---|---|---|
|                      |                           |       |  |  |  |  |
|                      |                           |       | Fleetline   | GasSLX  | Fleetline   | GasSLX  |

**CHEVROLET TRUCK (ALSO SEE GMC TRUCK)(Cont'd.)**

**C - Series (C6500, C7500, C8500) Kodiak(Cont'd.)**

|         |   |          |     |       |     |     |       |       |
|---------|---|----------|-----|-------|-----|-----|-------|-------|
| 90 - 09 | Conventional Cab w/ Front Shock with O.E.M. Number                                    | 15174898 | - - | 83136 | ... |     | ...   | ...   |
|         |   | 15588554 | - - | 83136 | ... |     | ...   | ...   |
|         |   | 15887728 | - - | 83136 | ... |     | ...   | ...   |
|         |   | 19152843 | - - | 83136 | ... |     | ...   | ...   |
|         |   | 22064230 | - - | 83136 | ... |     | ...   | ...   |
|         |   | 88982682 | - - | 83136 | ... |     | ...   | ...   |
| 1990 -  | Conventional Cab w/11000, 13500, 15000 lb Taperleaf Springs                           | 22064231 |     | ...   | ... | - - | 85324 | ...   |
| 90 - 09 | Conventional Cab w/15000, 19000, 21000 lb Multileaf Springs                           | 15174902 |     | ...   | ... | - - | 85071 | ...   |
|         |   | 22064232 |     | ...   | ... | - - | 85071 | ...   |
|         |   | 88982686 |     | ...   | ... | - - | 85071 | ...   |
| 90 - 06 | Conventional Cab w/16900 or 17850 lb Taperleaf Springs                                | 21998392 |     | ...   | ... | - - | 85336 | ...   |
|         |   | 22064489 |     | ...   | ... | - - | 85336 | ...   |
|         |   | 88963409 |     | ...   | ... | - - | 85336 | ...   |
| 1990 -  | Conventional Cab w/19000, 21000, 23000 lb Taperleaf Springs (EXC Low Profile Vehicle) | 22064233 |     | ...   | ... | - - | 83136 | ...   |
| 04 - 08 | Conventional Cab with 19000 lb Leaf Spring  | 15174903 |     | ...   | ... | - - | 85342 | ...   |
|         |   | 507-23   |     | ...   | ... | - - | 85342 | ...   |
|         |   | 88982687 |     | ...   | ... | - - | 85342 | ...   |
| 83 - 99 | Conventional Cab with 9100 to 17500 lb Rear Axle                                      | 22064432 |     | ...   | ... | 0 0 | 85050 | ...   |
| 95 - 02 | Models with Hendrickson Air Suspension (Stamping number 47902-13)                     | 12474915 |     | ...   | ... | 0 0 | 83122 | 89406 |
|         |   | 15963161 |     | ...   | ... | 0 0 | 83122 | 89406 |
| 96 - 02 | Models with Hendrickson Air Suspension (Stamping number 47902-29)                     | 12474917 |     | ...   | ... | 0 0 | 83137 | ...   |
|         |   | 15740554 |     | ...   | ... | 0 0 | 83137 | ...   |
|         | Models with O.E.M. Number   | 88982684 | - - | 83136 | ... |     | ...   | ...   |
|         |   | 88982688 |     | ...   | ... | - - | 85336 | ...   |

**P - Series**





|         |                   |          |  |     |     |     |       |     |
|---------|-------------------|----------|--|-----|-----|-----|-------|-----|
| 92 - 96 | Motorhome Chassis | 22064231 |  | ... | ... | - - | 85324 | ... |
|         |                   | 22064233 |  | ... | ... | - - | 83136 | ... |

**T - Series (T5500, T6500, T7500, T8500)**

|         |  |          |     |       |     |     |       |       |
|---------|--|----------|-----|-------|-----|-----|-------|-------|
| 1997 -  | FL1 Tilt Cab with 8100 lb Axle   | 22064804 | - - | 83136 | ... |     | ...   | ...   |
|         |  | 22064805 | - - | 83136 | ... |     | ...   | ...   |
|         |  | 22165187 | - - | 83136 | ... |     | ...   | ...   |
|         |  | 22165188 | - - | 83136 | ... |     | ...   | ...   |
| 1997 -  | FL2 Tilt Cab with 5000 to 11000 lb Axle                                    | 22064807 | - - | 83136 | ... |     | ...   | ...   |
|         |  | 22166442 | - - | 83136 | ... |     | ...   | ...   |
| 1997 -  | FL3 Tilt Cab with 14575 lb Axle  | 22064806 | - - | 83136 | ... |     | ...   | ...   |
|         |  | 22165189 | - - | 83136 | ... |     | ...   | ...   |
| 1999    | Models with Hendrickson Air Suspension (Stamping number 47902-13)          | 12474915 |     | ...   | ... | 0 0 | 83122 | 89406 |
|         |  | 15963161 |     | ...   | ... | 0 0 | 83122 | 89406 |
| 90 - 99 | Tilt Cab w/11000, 13500, 15000 lb Taperleaf Springs                        | 22064231 |     | ...   | ... | - - | 85324 | ...   |
| 90 - 06 | Tilt Cab w/15000, 19000, 21000 lb Multileaf Springs                        | 15174902 |     | ...   | ... | - - | 85071 | ...   |
|         |  | 22064232 |     | ...   | ... | - - | 85071 | ...   |
| 92 - 06 | Tilt Cab w/16900 lb Taperleaf Springs                                      | 21998392 |     | ...   | ... | - - | 85336 | ...   |
|         |  | 22064489 |     | ...   | ... | - - | 85336 | ...   |
|         |  | 88963409 |     | ...   | ... | - - | 85336 | ...   |
| 92 - 99 | Tilt Cab w/19000, 21000, 23000 lb Taperleaf Springs (EXC Low Profile Veh.) | 22064233 |     | ...   | ... | - - | 83136 | ...   |
| 06 - 09 | Tilt Cab Models with O.E.M. Number   | 15174901 |     | ...   | ... | - - | 85342 | ...   |
|         |  | 15174903 |     | ...   | ... | - - | 85342 | ...   |
|         |  | 507-22   |     | ...   | ... | - - | 85342 | ...   |
|         |  | 507-23   |     | ...   | ... | - - | 85342 | ...   |
|         |  | 88982685 |     | ...   | ... | - - | 85342 | ...   |
|         |  | 88982687 |     | ...   | ... | - - | 85342 | ...   |



## APPLICATION GUIDE - TRUCKS, TRAILERS, AND BUSES

| Year<br>Año<br>Année | Model<br>Modelo<br>Modèle | OEM # | Front  |   | Rear  |   |
|----------------------|---------------------------|-------|--|---|---|---|
|                      |                           |       |  |  |  |  |
|                      |                           |       | Fleetline  | GasSLX  | Fleetline   | GasSLX  |

### CHEVROLET TRUCK (ALSO SEE GMC TRUCK)(Cont'd.)





#### W - Series (Isuzu)(Cont'd.)

|         |                                    |  |     |       |     |     |       |       |
|---------|------------------------------------|--|-----|-------|-----|-----|-------|-------|
| 83 - 95 | W4 Models                          | 9-51630-666-0<br>9-51630-666-2   |     | ...   | ... | OIO | 85012 | 89413 |
|         |                                    |  |     | ...   | ... | OIO | 85012 | 89413 |
| 86 - 90 | W4 Models                          | 8-94454-986-0<br>8-94454-987-0<br>9-51630-647-1                                | -IO | 83515 | ... |     | ...   | ...   |
|         |                                    |  |     | 83515 | ... |     | ...   | ...   |
|         |                                    |  |     | 83515 | ... |     | ...   | ...   |
| 89 - 90 | W4 Models Flatlow                  | 9-51630-647-1  | -IO | 83515 | ... |     | ...   | ...   |
| 89 - 92 | W4 Models Flatlow                  | 9-51630-666-0<br>9-51630-666-2   |     | ...   | ... | OIO | 85012 | 89413 |
|         |                                    |  |     | ...   | ... | OIO | 85012 | 89413 |
| 86 - 95 | W4 Models with 11000 lb Suspension | 97083027   | -IO | 83515 | ... |     | ...   | ...   |
| 87 - 95 | W4 Models with 13000 lb Suspension | 94454987<br>97083029   | -IO | 83515 | ... |     | ...   | ...   |
|         |                                    |  |     | 83515 | ... |     | ...   | ...   |
| 88 - 97 | W5 Models                          | 1-51630-217-0<br>1-51630-217-1<br>1-51630-219-1                                | -IO | 83114 | ... |     | ...   | ...   |
|         |                                    |  |     | 83114 | ... |     | ...   | ...   |
|         |                                    |  |     | 83114 | ... |     | ...   | ...   |
| 86 - 91 | W6 Models                          | 1-51630-168-1<br>1-51630-217-0<br>1-51630-217-1                                | -IO | 83515 | ... |     | ...   | ...   |
|         |                                    |  |     | 83114 | ... |     | ...   | ...   |
|         |                                    |  |     | 83114 | ... |     | ...   | ...   |
|         | Models with O.E.M. Number          | 8-94057-593-0<br>8-97201-960-0<br>94033786<br>94051090<br>94057593<br>97201960 | -IO | 83114 | ... |     | ...   | ...   |
|         |                                    |  |     | 83515 | ... |     | ...   | ...   |
|         |                                    |  |     | 83114 | ... |     | ...   | ...   |
|         |                                    |  |     | 83114 | ... |     | ...   | ...   |
|         |                                    |  |     | 83114 | ... |     | ...   | ...   |
|         |                                    |  |     | 83515 | ... |     | ...   | ...   |

#### Additional O.E.M. Interchanges

|     |                                |   |     |                |       |     |       |     |
|-----|--------------------------------|---|-----|----------------|-------|-----|-------|-----|
|     | Models with O.E.M. Number      | 15642943<br>22046489<br>22065218<br>22065251<br>22099889<br>507-24<br>508-86<br>508-88  | OIO | ...            | ...   | - - | 83136 | ... |
|     |                                |   |     | 85303          | 89422 |     | ...   | ... |
|     |                                |   |     | G63347         | ...   |     | ...   | ... |
|     |                                |   |     | 85030          | 89440 |     | ...   | ... |
|     |                                |   |     | ...            | ...   | - - | 85336 | ... |
|     |                                |   |     | ...            | ...   | - - | 85336 | ... |
|     |                                |   |     | ...            | ...   | - - | 83136 | ... |
|     |                                |   |     | ...            | ...   | OIO | 83153 | ... |
|     | Additional O.E.M. Interchanges | 22007703<br>22012067<br>22012082<br>22012083<br>22012114<br>22012131<br>22024673<br>22045526<br>22046481<br>22046485<br>22046499<br>22052014<br>22052424<br>3171696<br>3172948<br>3175509<br>3178157<br>3178233<br>3178507<br>3178995<br>3188626<br>3188729 | OIO | 83303          |       |     |       |     |
|     |                                |   | OIO | 85700          |       |     |       |     |
|     |                                |   | OIO | 85702          |       |     |       |     |
|     |                                |   | -IO | 85711          |       |     |       |     |
|     |                                |   | OIO | 85700          |       |     |       |     |
|     |                                |   | -IO | 85711          |       |     |       |     |
|     |                                |   | -IO | 85710          |       |     |       |     |
|     |                                |   | OIO | 85702          |       |     |       |     |
|     |                                |   | OIO | 85702          |       |     |       |     |
|     |                                |   | -IO | 85710          |       |     |       |     |
|     |                                |   | -IO | 85710          |       |     |       |     |
|     |                                |   | OIO | 85702          |       |     |       |     |
|     |                                |   | -IO | 85710          |       |     |       |     |
|     |                                |   | OIO | 85307          |       |     |       |     |
|     |                                |   | OIO | 85303 or 89422 |       |     |       |     |
|     |                                |   | OIO | 85735          |       |     |       |     |
|     |                                |   | OIO | 85700          |       |     |       |     |
|     |                                |   | OIO | 85734          |       |     |       |     |
|     |                                |   | OIO | 85700          |       |     |       |     |
|     |                                |   | OIO | 85700          |       |     |       |     |
|     |                                |   | OIO | 85300 or 89419 |       |     |       |     |
| OIO | 85303 or 89422                 |   |     |                |       |     |       |     |

**APPLICATION GUIDE - TRUCKS, TRAILERS, AND BUSES**





| Year<br>Año<br>Année | Model<br>Modelo<br>Modèle | OEM # | Front   |   | Rear  |   |
|----------------------|---------------------------|-------|---|---|---|---|
|                      |                           |       |  |  |  |  |
|                      |                           |       | Fleetline   | GasSLX  | Fleetline   | GasSLX  |

**CHEVROLET TRUCK (ALSO SEE GMC TRUCK)(Cont'd.)**

**Additional O.E.M. Interchanges(Cont'd.)**

| Additional O.E.M. Interchanges |         |     |                |
|--------------------------------|---------|-----|----------------|
|                                | 4939852 | 010 | 85308 or 89422 |
|                                | 4939967 | 010 | 85308 or 89422 |
|                                | 4940601 | 010 | 83216          |
|                                | 4940627 | 010 | 83203 or 89436 |
|                                | 4940640 | 010 | 83216          |
|                                | 4940650 | 010 | 83207 or 89407 |
|                                | 4940654 | 010 | 83216          |
|                                | 4940660 | 010 | 83207 or 89407 |
|                                | 4963844 | 010 | 85307          |
|                                | 4964853 | 010 | 83217          |
|                                | 4974401 | 010 | 85700          |
|                                | 4975429 | 010 | 85300 or 89419 |
|                                | 4975479 | -1- | 83400          |
|                                | 4975480 | -1- | 83400          |
|                                | 4975516 | 010 | 85702          |
|                                | 4975518 | 010 | 85704          |
|                                | 4975538 | 010 | 85700          |
|                                | 4975549 | 010 | 83216          |
|                                | 4975550 | 010 | 85702          |
|                                | 507-3   | 010 | 85307          |
|                                | 5171068 | 010 | 83216          |
|                                | 5316784 | 010 | 85700          |
|                                | 5316791 | 010 | 83219          |
|                                | 5316792 | 010 | 85305          |
|                                | 5316793 | 010 | 85305          |
|                                | 5321920 | 010 | 85307          |
|                                | 5321929 | 010 | 85307          |
|                                | 5348631 | 010 | 83203 or 89436 |
|                                | 5352858 | 010 | 85305          |
|                                | 5353054 | 010 | 85303 or 89422 |
|                                | 5355798 | 010 | 85307          |
|                                | 5357955 | 010 | 85300 or 89419 |
|                                | 5357956 | 010 | 85734          |
|                                | 5357959 | 010 | 85300 or 89419 |
|                                | 5361994 | 010 | 85734          |
|                                | 5374779 | 010 | 85308 or 89422 |
|                                | 5374999 | 010 | 85307          |
|                                | 5385939 | 010 | 85307          |
|                                | 5392387 | 010 | 85303 or 89422 |
|                                | 5394448 | 010 | 85305          |
|                                | 5394467 | 010 | 85305          |
|                                | 5394468 | 010 | 85735          |
|                                | 5455798 | 010 | 85307          |
|                                | 5513489 | 010 | 83216          |
|                                | 5513716 | 010 | 85304          |
|                                | 5516459 | 010 | 85305          |
|                                | 5522781 | 010 | 85735          |
|                                | 5522794 | 010 | 85308 or 89422 |
|                                | 5522818 | 010 | 85305          |
|                                | 5527001 | 010 | 85300 or 89419 |
|                                | 5527271 | 010 | 85700          |
|                                | 5527272 | 010 | 85700          |
|                                | 5527606 | 010 | 85305          |
|                                | 5531027 | 010 | 85301          |
|                                | 5531435 | 010 | 85307          |

**APPLICATION GUIDE - TRUCKS, TRAILERS, AND BUSES**

| Year<br>Año<br>Année | Model<br>Modelo<br>Modèle | OEM # | Front   |  | Rear  |   |
|----------------------|---------------------------|-------|---|--|---|---|
|                      |                           |       |  |  |  |  |
|                      |                           |       | Fleetline   | GasSLX   | Fleetline   | GasSLX  |

**CHEVROLET TRUCK (ALSO SEE GMC TRUCK)(Cont'd.)**









**Additional O.E.M. Interchanges(Cont'd.)**

|                                |         |                |                |
|--------------------------------|---------|----------------|----------------|
| Additional O.E.M. Interchanges | 5531436 | 010            | 85307          |
|                                | 5531437 | 010            | 85307          |
|                                | 5532026 | 010            | 85304          |
|                                | 5532425 | 010            | 83207 or 89407 |
|                                | 5532433 | 010            | 83207 or 89407 |
|                                | 5532675 | 010            | 85307          |
|                                | 5534430 | 010            | 85303 or 89422 |
|                                | 5534439 | 010            | 85304          |
|                                | 5534447 | 010            | 85303 or 89422 |
|                                | 5544112 | 010            | 83216          |
|                                | 5544581 | 010            | 85302 or 89420 |
|                                | 5544716 | 010            | 85304          |
|                                | 5544717 | 010            | 85304          |
|                                | 5544812 | 010            | 83308          |
|                                | 5544818 | 010            | 85735          |
|                                | 5549899 | 010            | 83207 or 89407 |
|                                | 5549924 | 010            | 85700          |
|                                | 5549925 | 010            | 85304          |
|                                | 5552111 | 010            | 85304          |
|                                | 5552112 | 010            | 85307          |
|                                | 5552114 | 010            | 83216          |
|                                | 5552205 | 010            | 83217          |
|                                | 5552206 | 010            | 83214          |
|                                | 5552207 | 010            | 83217          |
|                                | 5552208 | 010            | 83217          |
|                                | 5552209 | 010            | 83215          |
|                                | 5552210 | 010            | 85308 or 89422 |
|                                | 5552244 | 010            | 85308 or 89422 |
|                                | 5552285 | 010            | 83214          |
|                                | 5552286 | 010            | 83217          |
|                                | 5552287 | 010            | 83217          |
|                                | 5552288 | 010            | 83217          |
|                                | 5552453 | 010            | 85301          |
| 5552527                        | 010     | 85735          |                |
| 5554184                        | 010     | 85302 or 89420 |                |
| 5554589                        | 010     | 85307          |                |
| 5554596                        | 010     | 85303 or 89422 |                |
| 5554814                        | 010     | 85302 or 89420 |                |
| 5554959                        | 010     | 83401          |                |
| 5554995                        | 010     | 85305          |                |
| 5559363                        | 010     | 83203 or 89436 |                |
| 5585939                        | 010     | 85307          |                |
| 684280                         | 010     | 83209 or 89414 |                |
| 97-2210-00164                  | 01-     | 85708          |                |
| 97-2210-00170                  | 01-     | 85733          |                |

**CHEVROLET TRUCK CAB SHOCKS**

|               |   |           |     |       |
|---------------|---|-----------|-----|-------|
|               | Bruin Tractors with J9 Cabs with Link Cabmate Model GMC92J9                   | 1202-0012 | 010 | 83023 |
| <b>1990 -</b> | Kodiak Truck Cabs with Link Cabmate Model GMC104TK                            | 1202-0054 | 010 | 83021 |
| <b>- 1989</b> | Kodiak Truck Cabs with Link Cabmate Model GMC92TK                             | 1202-0012 | 010 | 83023 |
|               | Titan Cabover (Sleeper & Non-Sleeper Trucks) with Link Cabmate Model GMC-2P-A | 1202-0032 | 010 | 83016 |

## APPLICATION GUIDE - TRUCKS, TRAILERS, AND BUSES

| Year<br>Año<br>Année | Model<br>Modelo<br>Modèle | OEM # | Front   |   | Rear  |   |
|----------------------|---------------------------|-------|---|---|---|---|
|                      |                           |       |  |  |  |  |
|                      |                           |       |  |  |  |  |
|                      |                           |       | Fleetline   | GasSLX  | Fleetline   | GasSLX  |

### CHRYSLER

#### Motorhome Chassis

|         |  |         |  |     |     |     |               |     |
|---------|--|---------|--|-----|-----|-----|---------------|-----|
| 73 - 81 | M & R-300, 400, 500 Motorhome Chassis  | 3638112 |  | ... | ... | 010 | <b>G63183</b> | ... |
| 63 - 72 | M-300, M-375 & R-375 Motorhome Chassis | 2961043 |  | ... | ... | 010 | <b>G63183</b> | ... |
|         |  | 3633744 |  | ... | ... | 010 | <b>G63183</b> | ... |

### CLARK EQUIPMENT

|  |                               |         |  |              |     |     |              |     |
|--|-------------------------------|---------|--|--------------|-----|-----|--------------|-----|
|  | Model 130885 (Air Suspension) | 5532675 |  | ...          | ... | 010 | <b>85307</b> | ... |
|  | Ross Carrier                  | 355778  |  | <b>85315</b> | ... | 010 | <b>85315</b> | ... |
|  |                               | 680042  |  | <b>85301</b> | ... | 010 | <b>85301</b> | ... |

### CNH GLOBAL N V

|  |                           |          |     |              |  |  |  |  |
|--|---------------------------|----------|-----|--------------|--|--|--|--|
|  | Models with O.E.M. Number | 87019546 | 010 | <b>83022</b> |  |  |  |  |
|  |                           | 87268250 | 010 | <b>83021</b> |  |  |  |  |

### COACH HOUSE RV

#### Class C MotorHomes





|         |   |          |     |              |     |     |              |     |
|---------|---|----------|-----|--------------|-----|-----|--------------|-----|
| 04 - 19 | Platinum Series MotorHomes with Ford E450 Chassis | ASH-1136 |     | ...          | ... | -10 | <b>83178</b> | ... |
|         |   | ASH-1154 | -10 | <b>83177</b> | ... |     | ...          | ... |

### COACHMEN RV

#### Class A MotorHomes

|           |  |               |              |              |              |              |              |              |
|-----------|--|---------------|--------------|--------------|--------------|--------------|--------------|--------------|
| 01 - 09   | Aurora Series MotorHomes with Ford F53 Chassis with 16,000 lb GVW to 22,000 lb GVW   | 1C34-18045-AA | 010          | <b>83209</b> | <b>89414</b> |              | ...          | ...          |
|           |  | 1C34-18045-JA | 010          | <b>83209</b> | <b>89414</b> |              | ...          | ...          |
|           |  | 9U94-18045-AA | 010          | <b>83209</b> | <b>89414</b> |              | ...          | ...          |
|           |  | 9U94-18080-AA |              | ...          | ...          | 010          | <b>83122</b> | <b>89406</b> |
|           |  | 9U9Z-18124-A  | 010          | <b>83209</b> | <b>89414</b> |              | ...          | ...          |
|           |  | 9U9Z-18125-A  |              | ...          | ...          | 010          | <b>83122</b> | <b>89406</b> |
|           |  | ASH-1022      | 010          | <b>83209</b> | <b>89414</b> |              | ...          | ...          |
|           |  | ASH-1023      |              | ...          | ...          | 010          | <b>83122</b> | <b>89406</b> |
|           |  | ASH-1205      | 010          | <b>83209</b> | <b>89414</b> |              | ...          | ...          |
|           |  | ASH-1206      |              | ...          | ...          | 010          | <b>83122</b> | <b>89406</b> |
|           |  | ASH-1228      | 010          | <b>83209</b> | <b>89414</b> |              | ...          | ...          |
|           |  | ASH-1229      | 010          | <b>83209</b> | <b>89414</b> |              | ...          | ...          |
|           |  | ASH-1230      |              | ...          | ...          | 010          | <b>83122</b> | <b>89406</b> |
|           |  | ASH-137       |              | ...          | ...          | 010          | <b>83122</b> | <b>89406</b> |
|           |  | ASH-25822     | 010          | <b>83209</b> | <b>89414</b> |              | ...          | ...          |
|           |  | ASH-25823     | 010          | <b>83209</b> | <b>89414</b> |              | ...          | ...          |
| ASH-25824 |  | ...           | ...          | 010          | <b>83122</b> | <b>89406</b> |              |              |
| ASH-294   | 010  | <b>83209</b>  | <b>89414</b> |              | ...          | ...          |              |              |
| AT-620    | 010  | <b>83209</b>  | <b>89414</b> |              | ...          | ...          |              |              |
| AT-621    |  | ...           | ...          | 010          | <b>83122</b> | <b>89406</b> |              |              |
| AT-766    | 010  | <b>83209</b>  | <b>89414</b> |              | ...          | ...          |              |              |
| 03 - 05   | Cross Country Elite & SE Series MotorHomes with Freightliner XC Chassis<br><br>ADL200 Suspension w/ 20K Rear<br>AS120 Front Suspension<br><br>Rear Shock with O.E.M. Number<br><br>ZF - IFS Front Suspension with 23,000 lb GVW or Greater | 16-16873-000  |              | ...          | ...          | 010          | <b>85029</b> | ...          |
|           |  | 141700131810  | 010          | <b>83160</b> | ...          |              | ...          | ...          |
|           |  | 16-16737-000  | 010          | <b>83160</b> | ...          |              | ...          | ...          |
|           |  | 16-16874-000  | 010          | <b>83160</b> | ...          |              | ...          | ...          |
|           |  | 141700131809  |              | ...          | ...          | 010          | <b>85029</b> | ...          |
|           |  | 16-16736-000  |              | ...          | ...          | 010          | <b>85029</b> | ...          |
| 2006      | Cross Country Series MotorHomes with Freightliner XC Chassis<br><br>ADL200 Suspension w/ 20K Rear  | 16-16873-000  |              | ...          | ...          | 010          | <b>85029</b> | ...          |
|           |  |               |              | ...          | ...          |              | ...          | ...          |

## APPLICATION GUIDE - TRUCKS, TRAILERS, AND BUSES









| Year<br>Año<br>Année | Model<br>Modelo<br>Modèle | OEM # | Front  |   | Rear   |   |
|----------------------|---------------------------|-------|--|---|--|---|
|                      |                           |       |  |  |  |  |
|                      |                           |       | Fleetline  | GasSLX  | Fleetline  | GasSLX  |

### COACHMEN RV(Cont'd.)

#### Class A MotorHomes(Cont'd.)

|                |  |                |       |       |       |     |       |       |
|----------------|--|----------------|-------|-------|-------|-----|-------|-------|
|                | AS120 Front Suspension<br><br>Rear Shock with O.E.M. Number<br><br>ZF - IFS Front Suspension with 23,000 lb GVW or Greater | 141700131810   | 010   | 83160 | ...   |     | ...   | ...   |
|                |  | 16-16737-000   | 010   | 83160 | ...   |     | ...   | ...   |
|                |  | 16-16874-000   | 010   | 83160 | ...   |     | ...   | ...   |
|                |  | 141700131809   |       | ...   | ...   | 010 | 85029 | ...   |
|                |  | 16-16736-000   |       | ...   | ...   | 010 | 85029 | ...   |
|                |  | 16-18103-000   | -1-   | 85900 | ...   |     | ...   | ...   |
|                |  | 481700000493   | -1-   | 85900 | ...   |     | ...   | ...   |
| <b>11 - 15</b> | Encounter Series MotorHomes with Ford F53 Chassis with 16,000 lb GVW to 22,000 lb GVW                                      | ASH-1229       | 010   | 83209 | 89414 |     | ...   | ...   |
|                |  | ASH-25822      | 010   | 83209 | 89414 |     | ...   | ...   |
|                |  | ASH-25823      | 010   | 83209 | 89414 |     | ...   | ...   |
|                |  | ASH-25824      |       | ...   | ...   | 010 | 83122 | 89406 |
| <b>99 - 19</b> | Mirada Series MotorHomes with Ford F53 Chassis with 16,000 lb GVW to 22,000 lb GVW   | 1C34-18045-AA  | 010   | 83209 | 89414 |     | ...   | ...   |
|                |  | 1C34-18045-JA  | 010   | 83209 | 89414 |     | ...   | ...   |
|                |  | 9U94-18045-AA  | 010   | 83209 | 89414 |     | ...   | ...   |
|                |  | 9U94-18080-AA  |       | ...   | ...   | 010 | 83122 | 89406 |
|                |  | 9U9Z-18124-A   | 010   | 83209 | 89414 |     | ...   | ...   |
|                |  | 9U9Z-18125-A   |       | ...   | ...   | 010 | 83122 | 89406 |
|                |  | ASH-1022       | 010   | 83209 | 89414 |     | ...   | ...   |
|                |  | ASH-1023       |       | ...   | ...   | 010 | 83122 | 89406 |
|                |  | ASH-1205       | 010   | 83209 | 89414 |     | ...   | ...   |
|                |  | ASH-1206       |       | ...   | ...   | 010 | 83122 | 89406 |
|                |  | ASH-1228       | 010   | 83209 | 89414 |     | ...   | ...   |
|                |  | ASH-1229       | 010   | 83209 | 89414 |     | ...   | ...   |
|                |  | ASH-1230       |       | ...   | ...   | 010 | 83122 | 89406 |
|                |  | ASH-137        |       | ...   | ...   | 010 | 83122 | 89406 |
|                |  | ASH-25822      | 010   | 83209 | 89414 |     | ...   | ...   |
|                |  | ASH-25823      | 010   | 83209 | 89414 |     | ...   | ...   |
|                |  | ASH-25824      |       | ...   | ...   | 010 | 83122 | 89406 |
|                |  | ASH-294        | 010   | 83209 | 89414 |     | ...   | ...   |
|                |  | AT-620         | 010   | 83209 | 89414 |     | ...   | ...   |
|                |  | AT-621         |       | ...   | ...   | 010 | 83122 | 89406 |
| AT-766         | 010  | 83209          | 89414 |       | ...   | ... |       |       |
|                | Models with Workhorse UFO Chassis with Hendrickson Softek Front Suspension   | 66153-002      | 010   | 83124 | 89407 |     | ...   | ...   |
|                |  | F4-BE5-C832-MO | 010   | 83124 | 89407 |     | ...   | ...   |
| <b>04 - 19</b> | Pursuit Series MotorHomes with Ford F53 Chassis with 16,000 lb GVW to 22,000 lb GVW  | 1C34-18045-AA  | 010   | 83209 | 89414 |     | ...   | ...   |
|                |  | 1C34-18045-JA  | 010   | 83209 | 89414 |     | ...   | ...   |
|                |  | 9U94-18045-AA  | 010   | 83209 | 89414 |     | ...   | ...   |
|                |  | 9U94-18080-AA  |       | ...   | ...   | 010 | 83122 | 89406 |
|                |  | 9U9Z-18124-A   | 010   | 83209 | 89414 |     | ...   | ...   |
|                |  | 9U9Z-18125-A   |       | ...   | ...   | 010 | 83122 | 89406 |
|                |  | ASH-1022       | 010   | 83209 | 89414 |     | ...   | ...   |
|                |  | ASH-1023       |       | ...   | ...   | 010 | 83122 | 89406 |
|                |  | ASH-1205       | 010   | 83209 | 89414 |     | ...   | ...   |
|                |  | ASH-1206       |       | ...   | ...   | 010 | 83122 | 89406 |
|                |  | ASH-1228       | 010   | 83209 | 89414 |     | ...   | ...   |
|                |  | ASH-1229       | 010   | 83209 | 89414 |     | ...   | ...   |
|                |  | ASH-1230       |       | ...   | ...   | 010 | 83122 | 89406 |
|                |  | ASH-137        |       | ...   | ...   | 010 | 83122 | 89406 |
|                |  | ASH-25822      | 010   | 83209 | 89414 |     | ...   | ...   |
|                |  | ASH-25823      | 010   | 83209 | 89414 |     | ...   | ...   |
|                |  | ASH-25824      |       | ...   | ...   | 010 | 83122 | 89406 |
| ASH-294        | 010  | 83209          | 89414 |       | ...   | ... |       |       |

## APPLICATION GUIDE - TRUCKS, TRAILERS, AND BUSES

| Year<br>Año<br>Année | Model<br>Modelo<br>Modèle | OEM # | Front   |   | Rear  |   |
|----------------------|---------------------------|-------|---|---|---|---|
|                      |                           |       |  |  |  |  |
|                      |                           |       |  |  |  |  |
|                      |                           |       | Fleetline   | GasSLX  | Fleetline   | GasSLX  |

### COACHMEN RV(Cont'd.)

#### Class A MotorHomes(Cont'd.)

|         |   |        |     |       |       |     |       |       |
|---------|---|--------|-----|-------|-------|-----|-------|-------|
| 04 - 19 | Pursuit Series MotorHomes with Ford F53 Chassis with 16,000 lb GVW to 22,000 lb GVW | AT-620 | ○ ○ | 83209 | 89414 |     | ...   | ...   |
|         |   |        |     | ...   | ...   | ○ ○ | 83122 | 89406 |
|         |   |        | ○ ○ | 83209 | 89414 |     | ...   | ...   |

#### Class C MotorHomes

|         |  |          |     |       |     |     |       |     |
|---------|--|----------|-----|-------|-----|-----|-------|-----|
|         | Catalina Series MotorHomes with Ford E350 & E450 Chassis         | ASH-1136 |     | ...   | ... | - ○ | 83178 | ... |
|         |  | ASH-1154 | - ○ | 83177 | ... |     | ...   | ... |
| 04 - 19 | Concord Series MotorHomes with Ford E350 & E450 Chassis          | ASH-1136 |     | ...   | ... | - ○ | 83178 | ... |
|         |  | ASH-1154 | - ○ | 83177 | ... |     | ...   | ... |
| 08 - 09 | Freedom Express Series MotorHomes with Ford E350 & E450 Chassis  | ASH-1136 |     | ...   | ... | - ○ | 83178 | ... |
|         |  | ASH-1154 | - ○ | 83177 | ... |     | ...   | ... |
| 03 - 19 | Freelander Series MotorHomes with Ford E350 & E450 Chassis       | ASH-1136 |     | ...   | ... | - ○ | 83178 | ... |
|         |  | ASH-1154 | - ○ | 83177 | ... |     | ...   | ... |
| 03 - 19 | Leprechaun Series MotorHomes with Ford E350 & E450 Chassis       | ASH-1136 |     | ...   | ... | - ○ | 83178 | ... |
|         |  | ASH-1154 | - ○ | 83177 | ... |     | ...   | ... |
| 00 - 03 | Pathfinder Sport Series MotorHomes with Ford E350 & E450 Chassis | ASH-1136 |     | ...   | ... | - ○ | 83178 | ... |
|         |  | ASH-1154 | - ○ | 83177 | ... |     | ...   | ... |
| 99 - 06 | Santara Series MotorHomes with Ford E350 & E450 Chassis          | ASH-1136 |     | ...   | ... | - ○ | 83178 | ... |
|         |  | ASH-1154 | - ○ | 83177 | ... |     | ...   | ... |

### COLLINS BUS CORP

|        |  |          |     |       |     |     |       |     |
|--------|--|----------|-----|-------|-----|-----|-------|-----|
| - 2019 | Type A School Bus models with Ford E350 & E450 Chassis | ASH-1136 | -   | ...   | ... | - ○ | 83178 | ... |
|        |  |          | - ○ | 83177 | ... |     | ...   | ... |

### CONTINENTAL TRAILWAYS-EAGLE INT'L

|  |                          |             |  |       |     |     |       |       |
|--|--------------------------|-------------|--|-------|-----|-----|-------|-------|
|  | Buses with O.E.M. Number | 01-0100-020 |  | 85307 | ... | ○ ○ | 85307 | ...   |
|  |                          | 5532026     |  | 85304 | ... | ○ ○ | 85304 | ...   |
|  |                          | 6-05-5      |  | 85307 | ... | ○ ○ | 85307 | ...   |
|  | Silver Eagle             | 01-0100-905 |  | 85303 | ... | ○ ○ | 85303 | 89422 |
|  |                          | 5394467     |  | 85305 | ... | ○ ○ | 85305 | ...   |
|  |                          | 680091      |  | 85303 | ... | ○ ○ | 85303 | 89422 |
|  |                          | 70039       |  | 85303 | ... | ○ ○ | 85303 | 89422 |
|  |                          | 70041       |  | 85305 | ... | ○ ○ | 85305 | ...   |
|  |                          |             |  | 85305 | ... | ○ ○ | 85305 | ...   |

### COUNTRY COACH



|  |                           |       |     |     |       |     |     |       |
|--|---------------------------|-------|-----|-----|-------|-----|-----|-------|
|  | Models with O.E.M. Number | 89406 | ○ ○ | ... | 89406 |     | ... | ...   |
|  |                           | 89414 |     | ... | ...   | ○ ○ | ... | 89414 |

### CRANE CARRIER

|  |   |             |     |       |       |     |        |     |
|--|---|-------------|-----|-------|-------|-----|--------|-----|
|  | Models with Hendrickson HMX 400 Haulmax (with 16.5" Saddle)       | 60680-004   |     | ...   | ...   | ○ - | 83143  | ... |
|  |   | 60680-004L  |     | ...   | ...   | ○ - | 83143  | ... |
|  |   | 64178-001   |     | ...   | ...   | ○ - | 83143  | ... |
|  | Models with Ridewell RDS-209 Tandem Air Drive Suspension          | 1310002     |     | ...   | ...   | ○ ○ | 665937 | ... |
|  | Models with Ridewell Truck Air-Ride Suspension with O.E.M. Number | 1265157B000 |     | ...   | ...   | ○ ○ | 85712  | ... |
|  | Models with O.E.M. Number   | 227A-14     | ○ ○ | 85716 | ...   |     | ...    | ... |
|  |   | 277A-1      | ○ ○ | 85307 | ...   |     | ...    | ... |
|  |   | 277A-13     | ○ ○ | 85302 | 89420 |     | ...    | ... |
|  |   | 277A-14     | ○ ○ | 85304 | ...   |     | ...    | ... |
|  |   | 277A-8      | ○ ○ | 85303 | 89422 |     | ...    | ... |
|  |   | 277A-9      | ○ ○ | 85307 | ...   |     | ...    | ... |
|  |   | 680091      | ○ ○ | 85303 | 89422 |     | ...    | ... |

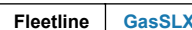

**APPLICATION GUIDE - TRUCKS, TRAILERS, AND BUSES**

| Year<br>Año<br>Année | Model<br>Modelo<br>Modèle | OEM # | Front  |   | Rear   |   |
|----------------------|---------------------------|-------|--|---|--|---|
|                      |                           |       |  |  |  |  |
|                      |                           |       | Fleetline  | GasSLX  | Fleetline  | GasSLX  |

**CRANE CARRIER(Cont'd.)**

|                                |         |     |              |  |  |  |
|--------------------------------|---------|-----|--------------|--|--|--|
| Additional O.E.M. Interchanges | 277A-12 | 010 | <b>85304</b> |  |  |  |
|                                | 680088  | 010 | <b>85713</b> |  |  |  |

**CROWN COACH**

|                                  |         |     |              |              |     |              |     |
|----------------------------------|---------|-----|--------------|--------------|-----|--------------|-----|
| All with Steel Spring Suspension | 3188729 | 010 | <b>85303</b> | <b>89422</b> |     | ...          | ... |
|                                  | 5532026 |     | <b>85304</b> | ...          | 010 | <b>85304</b> | ... |
| Models with O.E.M. Number        | 5532036 |     | <b>85734</b> | ...          | 010 | <b>85734</b> | ... |

**CUNHA PRODUCTS OHD**

|               |         |  |     |     |     |              |     |
|---------------|---------|--|-----|-----|-----|--------------|-----|
| Truck Dollies | CP-5222 |  | ... | ... | 010 | <b>85315</b> | ... |
|---------------|---------|--|-----|-----|-----|--------------|-----|

**CUSH CORPORATION**

|                           |       |  |     |     |     |              |     |
|---------------------------|-------|--|-----|-----|-----|--------------|-----|
| Models with O.E.M. Number | C0227 |  | ... | ... | 010 | <b>85014</b> | ... |
|                           | C0228 |  | ... | ... | 010 | <b>85005</b> | ... |

**Trailer Suspensions - Low Mount**

|   |         |  |     |     |     |              |              |
|---|---------|--|-----|-----|-----|--------------|--------------|
| 25k UnderMount Econo 6/9                        | C0078   |  | ... | ... | 010 | <b>85000</b> | <b>89436</b> |
| CompacTrac 4.5/7 RH                             | C0078   |  | ... | ... | 010 | <b>85000</b> | <b>89436</b> |
| CP Competitor Series (U-Bolted) 25K & 3K        | C0226   |  | ... | ... | 010 | <b>85064</b> | ...          |
| DiscMATE LowMount 25K Disc Brake                | C0062-D |  | ... | ... | 010 | <b>85000</b> | <b>89436</b> |
| Performance Yoke-8in 25K Undermount             | C0062-D |  | ... | ... | 010 | <b>85000</b> | <b>89436</b> |
| RideBest 25KHD 6                                | C0062-D |  | ... | ... | 010 | <b>85000</b> | <b>89436</b> |
| RideBest 25KHD 8                                | C0062-D |  | ... | ... | 010 | <b>85000</b> | <b>89436</b> |
| RideBest Yoke 25KHD 9                           | C0062-D |  | ... | ... | 010 | <b>85000</b> | <b>89436</b> |
| RoughNeck Series, Cush Integrated, LowMount 30k | C0226   |  | ... | ... | 010 | <b>85064</b> | ...          |
| RoughNeck, Cush Integrated, LowMount 25K        | C0062-D |  | ... | ... | 010 | <b>85000</b> | <b>89436</b> |

**Trailer Suspensions - Top Mount**





|   |        |  |     |     |     |              |              |
|---|--------|--|-----|-----|-----|--------------|--------------|
| CLT-25 CushLITE BigFOOT (245 Style)             | C0078  |  | ... | ... | 010 | <b>85000</b> | <b>89436</b> |
| CLX25-317 CushLITE BigFOOT (317 style)          | C0078  |  | ... | ... | 010 | <b>85000</b> | <b>89436</b> |
| CP Performance Top Mount                        | C0226  |  | ... | ... | 010 | <b>85064</b> | ...          |
| CT250TB Top Mount High Travel (U-Bolted)        | C0226  |  | ... | ... | 010 | <b>85064</b> | ...          |
| DiscMATE 25K Roughneck Topmount                 | C0226  |  | ... | ... | 010 | <b>85064</b> | ...          |
| RideBest 25K TopMount                           | C0226  |  | ... | ... | 010 | <b>85064</b> | ...          |
| RideBest 25KHD TopMount 14-19                   | C0226  |  | ... | ... | 010 | <b>85064</b> | ...          |
| RoughNeck Series, Cush Integrated, TopMount 25K | C04045 |  | ... | ... | 010 | <b>85045</b> | ...          |
| RoughNeck Series, Cush Integrated, TopMount 30K | C0226  |  | ... | ... | 010 | <b>85064</b> | ...          |

**DAMON MOTOR COACH**

**Class A MotorHomes**

|                |  |                |     |              |              |     |              |              |
|----------------|--|----------------|-----|--------------|--------------|-----|--------------|--------------|
| <b>01 - 15</b> | Challenger Series MotorHomes with Ford F53 Chassis with 16,000 lb GVW to 22,000 lb GVW | ASH-1229       | 010 | <b>83209</b> | <b>89414</b> |     | ...          | ...          |
|                |  | ASH-25822      | 010 | <b>83209</b> | <b>89414</b> |     | ...          | ...          |
|                |  | ASH-25823      | 010 | <b>83209</b> | <b>89414</b> |     | ...          | ...          |
|                |  | ASH-25824      |     | ...          | ...          | 010 | <b>83122</b> | <b>89406</b> |
| <b>99 - 13</b> | Daybreak Series MotorHomes with Ford F53 Chassis with 16,000 lb GVW to 22,000 lb GVW   | ASH-1229       | 010 | <b>83209</b> | <b>89414</b> |     | ...          | ...          |
|                |  | ASH-25822      | 010 | <b>83209</b> | <b>89414</b> |     | ...          | ...          |
|                |  | ASH-25823      | 010 | <b>83209</b> | <b>89414</b> |     | ...          | ...          |
|                |  | ASH-25824      |     | ...          | ...          | 010 | <b>83122</b> | <b>89406</b> |
| <b>99 - 06</b> | Intruder Series MotorHomes with Ford F53 Chassis with 16,000 lb GVW to 22,000 lb GVW   | ASH-1229       | 010 | <b>83209</b> | <b>89414</b> |     | ...          | ...          |
|                |  | ASH-25822      | 010 | <b>83209</b> | <b>89414</b> |     | ...          | ...          |
|                |  | ASH-25823      | 010 | <b>83209</b> | <b>89414</b> |     | ...          | ...          |
|                |  | ASH-25824      |     | ...          | ...          | 010 | <b>83122</b> | <b>89406</b> |
| <b>05 - 14</b> | Models with Workhorse W20 , W22, & W24 MotorHome Chassis with O.E.M. Number            | 24-153256      |     | ...          | ...          | -1- | <b>85124</b> | ...          |
|                |  | F4-BE5-F325-HO |     | ...          | ...          | -1- | <b>85124</b> | ...          |
|                |  | W0005663       |     | ...          | ...          | -1- | <b>85124</b> | ...          |

## APPLICATION GUIDE - TRUCKS, TRAILERS, AND BUSES

| Year<br>Año<br>Année | Model<br>Modelo<br>Modèle | OEM # | Front   |   | Rear  |   |
|----------------------|---------------------------|-------|---|---|---|---|
|                      |                           |       |  |  |  |  |
|                      |                           |       | Fleetline   | GasSLX  | Fleetline   | GasSLX  |

### DAMON MOTOR COACH(Cont'd.)

#### Class A MotorHomes(Cont'd.)

|         |  |                |     |       |       |     |       |       |
|---------|--|----------------|-----|-------|-------|-----|-------|-------|
| 98 - 04 | Models with Workhorse W20 , W22, & W24 MotorHome Chassis with O.E.M. Number        | 24-186537      |     | ...   | ...   | 0 - | 85126 | ...   |
|         |  | F4-BE5-A011-HO |     | ...   | ...   | 0 - | 85126 | ...   |
| 98 - 14 | Models with Workhorse W20 , W22, & W24 MotorHome Chassis with O.E.M. Number        | 24-153249      | 0 0 | 85125 | ...   |     | ...   | ...   |
|         |  | 24-186629      | 0 0 | 85125 | ...   |     | ...   | ...   |
|         |  | F4-BE5-A832-MO | 0 0 | 85125 | ...   |     | ...   | ...   |
|         |  | F4-BE5-B492-HO | 0 0 | 85125 | ...   |     | ...   | ...   |
|         |  | F4-BE5-F324-HO | 0 0 | 85125 | ...   |     | ...   | ...   |
|         |  | W0005662       | 0 0 | 85125 | ...   |     | ...   | ...   |
|         |  | W0006254       | 0 0 | 85125 | ...   |     | ...   | ...   |
| 07 - 14 | Outlaw Series MotorHomes with Ford F53 Chassis with 16,000 lb GVW to 22,000 lb GVW | ASH-1229       | 0 0 | 83209 | 89414 |     | ...   | ...   |
|         |  | ASH-25822      | 0 0 | 83209 | 89414 |     | ...   | ...   |
|         |  | ASH-25823      | 0 0 | 83209 | 89414 |     | ...   | ...   |
|         |  | ASH-25824      |     | ...   | ...   | 0 0 | 83122 | 89406 |

### DANA

|  |  |          |  |     |     |     |       |     |
|--|--|----------|--|-----|-----|-----|-------|-----|
|  | Dana Smart Ride - RF and RS Models - 20,000 lb and 23,000 lb | SR1VJ100 |  | ... | ... | 0 0 | 85078 | ... |
|--|--|----------|--|-----|-----|-----|-------|-----|

### DEXTER AXLE

#### Trailer

|  |   |          |  |     |     |     |       |     |
|--|---|----------|--|-----|-----|-----|-------|-----|
|  | 86 AR / RS 1015, 1035, 3015, 3035 Slider Air Suspension | 18165-01 |  | ... | ... | 0 0 | 85006 | ... |
|--|---|----------|--|-----|-----|-----|-------|-----|

### DIAMOND COACH

|        |   |          |     |       |     |     |       |     |
|--------|---|----------|-----|-------|-----|-----|-------|-----|
| - 2019 | All Shuttle buses with Ford E350 and E450 Chassis | ASH-1136 |     | ...   | ... | - 0 | 83178 | ... |
|        |   | ASH-1154 | - 0 | 83177 | ... |     | ...   | ... |

### DIAMOND T

|  |                           |         |     |       |     |  |     |     |
|--|---------------------------|---------|-----|-------|-----|--|-----|-----|
|  | Models with O.E.M. Number | 5549925 | 0 0 | 85304 | ... |  | ... | ... |
|--|---------------------------|---------|-----|-------|-----|--|-----|-----|



### DIAMOND-REO

|  |                                  |           |     |       |     |     |       |     |
|--|----------------------------------|-----------|-----|-------|-----|-----|-------|-----|
|  | All w/Velvet Ride Suspension     | .....     |     | ...   | ... | 0 0 | 85307 | ... |
|  | C054, C088 w/FH or FL Axle       | .....     | 0 0 | 85307 | ... |     | ...   | ... |
|  | C054, C088, C114, C116 w/FF Axle | 220-55-1  | 0 0 | 83214 | ... |     | ...   | ... |
|  |                                  | 220-55-6  | 0 0 | 83214 | ... |     | ...   | ... |
|  | C090, C090D, C101                | 220-55-2  | 0 0 | 85304 | ... |     | ...   | ... |
|  |                                  | 220-55-7  | 0 0 | 85304 | ... |     | ...   | ... |
|  | C114, C116 w/FH or FL Axle       | 220-55-2  | 0 0 | 85304 | ... |     | ...   | ... |
|  |                                  | 220-55-7  | 0 0 | 85304 | ... |     | ...   | ... |
|  | CF Models                        | 220-55-8  | 0 0 | 83217 | ... |     | ...   | ... |
|  | DC101                            | 220-55-2  | 0 0 | 85304 | ... |     | ...   | ... |
|  |                                  | 220-55-7  | 0 0 | 85304 | ... |     | ...   | ... |
|  | Additional O.E.M. Interchanges   | 220-S5-10 |     | ...   | ... | 0 0 | 85712 | ... |

### DINA BUS

|         |   |            |     |       |     |     |       |     |
|---------|---|------------|-----|-------|-----|-----|-------|-----|
|         | F Models Coaches with O.E.M. Number (Drive Axle)      | 39390339-6 |     | ...   | ... | 0 0 | 85307 | ... |
|         | Marco Polo Viaggio GV 1000<br>Front Shock<br>Tag Axle | 39380353-6 | 0 0 | 85716 | ... |     | ...   | ... |
|         |   | 39390340-4 |     | ...   | ... | 0 0 | 85716 | ... |
| 11 - 13 | Outsider Buses  | 1520030010 |     | ...   | ... | - 0 | 83317 | ... |
|         |   | 152E030030 | 0 0 | 85014 | ... |     | ...   | ... |
|         | P Chassis with O.E.M. Number (Drive Axle)             | 39390339-6 |     | ...   | ... | 0 0 | 85307 | ... |
| 11 - 13 | Picker Buses  | 1520030010 |     | ...   | ... | - 0 | 83317 | ... |
|         |   | 152E030030 | 0 0 | 85014 | ... |     | ...   | ... |

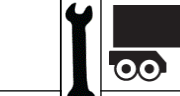
## APPLICATION GUIDE - TRUCKS, TRAILERS, AND BUSES

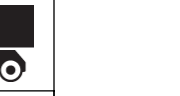
| Year<br>Año<br>Année | Model<br>Modelo<br>Modèle | OEM # | Front  |   | Rear  |   |
|----------------------|---------------------------|-------|--|---|---|---|
|                      |                           |       |  |  |  |  |
|                      |                           |       | Fleetline  | GasSLX  | Fleetline   | GasSLX  |

### DINA BUS(Cont'd.)

|         |                        |                          |     |              |     |     |              |     |
|---------|------------------------|--------------------------|-----|--------------|-----|-----|--------------|-----|
| 11 - 13 | Runner 10E Buses       | 1520030010<br>152E030030 | OIO | ...          | ... | -IO | <b>83317</b> | ... |
|         |                        |                          |     | <b>85014</b> | ... | ... |              | ... |
| 11 - 13 | Runner 8, 9 & 10 Buses | 1520030010<br>152E030030 | OIO | ...          | ... | -IO | <b>83317</b> | ... |
|         |                        |                          |     | <b>85014</b> | ... | ... |              | ... |

### DODGE TRUCK

#### D Series- Conventional Cab 4 x 2

|         |                            |         |  |     |     |     |               |     |
|---------|----------------------------|---------|--|-----|-----|-----|---------------|-----|
| 74 - 78 | D-500, D-600, D-700, D-800 | 3633643 |  | ... | ... | OIO | <b>G63183</b> | ... |
| 1973    | D-500, D-600, D-800        | 2516009 |  | ... | ... | OIO | <b>G63183</b> | ... |

#### LN & LNT - Conventional Cab

|         |               |         |  |     |     |     |               |     |
|---------|---------------|---------|--|-----|-----|-----|---------------|-----|
| 64 - 72 | LN, LV Models | 2516009 |  | ... | ... | OIO | <b>G63183</b> | ... |
|---------|---------------|---------|--|-----|-----|-----|---------------|-----|

#### LNT, LVT, NLT, VLT- Tilt Cab 6 x 4

|         |                 |         |  |     |     |     |               |     |
|---------|-----------------|---------|--|-----|-----|-----|---------------|-----|
| 64 - 73 | LNT, LVT Models | 2516009 |  | ... | ... | OIO | <b>G63183</b> | ... |
|---------|-----------------|---------|--|-----|-----|-----|---------------|-----|

#### LS & LT-Steel Tilt Cab

|         |                  |         |  |     |     |     |               |     |
|---------|------------------|---------|--|-----|-----|-----|---------------|-----|
| 73 - 75 | LS-1000, LT-1000 | 2516009 |  | ... | ... | OIO | <b>G63183</b> | ... |
|---------|------------------|---------|--|-----|-----|-----|---------------|-----|

#### Motorhome Chassis

|         |  |                    |     |               |     |     |               |     |
|---------|--|--------------------|-----|---------------|-----|-----|---------------|-----|
| 73 - 81 | M & R-300, 400, 500 Motorhome Chassis  | 3638112<br>3638631 | OIO | ...           | ... | OIO | <b>G63183</b> | ... |
|         |  |                    |     | <b>G63605</b> | ... | ... |               | ... |
| 63 - 72 | M-300, M-375 & R-375 Motorhome Chassis | 2961043<br>3633744 |     | ...           | ... | OIO | <b>G63183</b> | ... |
|         |  |                    |     | ...           | ... | OIO | <b>G63183</b> | ... |
| 77 - 81 | M-6 Motorhome Chassis                  | 3638112<br>4036892 | OIO | ...           | ... | OIO | <b>G63183</b> | ... |
|         |  |                    |     | <b>G63605</b> | ... | ... |               | ... |

#### P Series - Forward Control

|         |                                      |       |  |     |     |     |               |     |
|---------|--------------------------------------|-------|--|-----|-----|-----|---------------|-----|
| 72 - 82 | P-300                                | ..... |  | ... | ... | OIO | <b>G63183</b> | ... |
| 63 - 78 | P-400                                | ..... |  | ... | ... | OIO | <b>G63183</b> | ... |
| 63 - 71 | PC-500 and PC-600, PD-500 and PD-600 | ..... |  | ... | ... | OIO | <b>G63183</b> | ... |

#### School Buses

|         |                     |         |  |     |     |     |               |     |
|---------|---------------------|---------|--|-----|-----|-----|---------------|-----|
| 61 - 71 | S-400, S-500, S-600 | .....   |  | ... | ... | OIO | <b>G63183</b> | ... |
| 72 - 73 | S-500, S-600        | 2516009 |  | ... | ... | OIO | <b>G63183</b> | ... |
| 74 - 78 | S-600, S-700        | 3633643 |  | ... | ... | OIO | <b>G63183</b> | ... |

#### W-Series And Power Wagons

|         |                      |                    |     |               |     |     |               |     |
|---------|----------------------|--------------------|-----|---------------|-----|-----|---------------|-----|
| 61 - 72 | W-500, WT-500 Models | .....              |     | ...           | ... | OIO | <b>G63183</b> | ... |
| 1973    | W-600 Models         | 2516009<br>2960707 | OIO | ...           | ... | OIO | <b>G63183</b> | ... |
|         |                      |                    |     | <b>G63183</b> | ... | ... |               | ... |
| 74 - 78 | W-600 Models         | 3633643            |     | ...           | ... | OIO | <b>G63183</b> | ... |

### DUPLEX TRUCK

|  |                           |                    |  |              |     |     |              |     |
|--|---------------------------|--------------------|--|--------------|-----|-----|--------------|-----|
|  | Models with O.E.M. Number | 59024<br>7604-3371 |  | <b>83204</b> | ... | OIO | <b>83204</b> | ... |
|  |                           |                    |  | <b>83204</b> | ... | OIO | <b>83204</b> | ... |

### DURA SUSPENSION









|  |                           |   |  |     |     |     |              |              |
|--|---------------------------|---|--|-----|-----|-----|--------------|--------------|
|  | Models with O.E.M. Number | 1080099<br>12866<br>59024<br>59030<br>665133<br>665267<br>7604-3371<br>A-2212 |  | ... | ... | OIO | <b>83203</b> | <b>89436</b> |
|  |                           |   |  | ... | ... | OIO | <b>83207</b> | <b>89407</b> |
|  |                           |   |  | ... | ... | OIO | <b>83204</b> | ...          |
|  |                           |   |  | ... | ... | OIO | <b>83203</b> | <b>89436</b> |
|  |                           |   |  | ... | ... | OIO | <b>83203</b> | <b>89436</b> |
|  |                           |   |  | ... | ... | OIO | <b>85029</b> | ...          |
|  |                           |   |  | ... | ... | OIO | <b>83204</b> | ...          |
|  |                           |   |  | ... | ... | OIO | <b>85029</b> | ...          |

### DUTCHMEN RV

#### Class C MotorHomes

|         |   |   |     |              |     |  |     |     |
|---------|---|---|-----|--------------|-----|--|-----|-----|
| 92 - 09 | All Type C Motorhomes with Ford E350 & E450 Chassis | 8C24-18045-DA<br>8C2Z-18124-D<br>ASH-1154 | -IO | <b>83177</b> | ... |  | ... | ... |
|         |   |   |     | <b>83177</b> | ... |  | ... | ... |
|         |   |   |     | <b>83177</b> | ... |  | ... | ... |

## APPLICATION GUIDE - TRUCKS, TRAILERS, AND BUSES

| Year<br>Año<br>Année | Model<br>Modelo<br>Modèle | OEM # | Front   |   | Rear  |   |
|----------------------|---------------------------|-------|---|---|---|---|
|                      |                           |       |  |  |  |  |
|                      |                           |       |  |  |  |  |
|                      |                           |       | Fleetline   | GasSLX  | Fleetline   | GasSLX  |

### DUTCHMEN RV(Cont'd.)

#### Class C MotorHomes(Cont'd.)

|         |   |   |     |       |     |     |       |     |
|---------|---|---|-----|-------|-----|-----|-------|-----|
| 92 - 09 | All Type C Motorhomes with Ford E350 & E450 Chassis | AT-163G<br>8C24-18080-DB<br>8C2Z-18125-D<br>ASH-1136<br>AT-164G | -10 | 83177 | ... |     | ...   | ... |
|         |   |   |     | ...   | ... | -10 | 83178 | ... |
|         |   |   |     | ...   | ... | -10 | 83178 | ... |
|         |   |   |     | ...   | ... | -10 | 83178 | ... |
|         |   |   |     | ...   | ... | -10 | 83178 | ... |

### DYNAMAX CORP (COUNTRY COACH)

#### Class C MotorHomes

|         |   |  |     |       |       |     |       |       |
|---------|---|--|-----|-------|-------|-----|-------|-------|
| - 2019  | All Models with Freightliner FAS II Rear Air Suspension | 16-18708-000<br>471700002809   |     | ...   | ...   | 010 | 85724 | 89443 |
|         |   |  |     | ...   | ...   | 010 | 85724 | 89443 |
| 14 - 19 | DX3 Series Motorhomes with M2-106 Chassis               | 10-13760-000<br>471700002991<br>SDA471700002991  | 010 | 85959 | 89503 |     | ...   | ...   |
|         |   |  | 010 | 85959 | 89503 |     | ...   | ...   |
|         |   |  | 010 | 85959 | 89503 |     | ...   | ...   |
| 06 - 08 | Dyna Quest XL Series Motorhomes with M2-112 Chassis     | 10-13634-000<br>471700000449   | 010 | 85918 | 89449 |     | ...   | ...   |
|         |   |  | 010 | 85918 | 89449 |     | ...   | ...   |
| 09 - 19 | Dyna Quest XL Series Motorhomes with M2-112 Chassis     | 10-13809-000<br>471700003920   | 010 | 85958 | ...   |     | ...   | ...   |
|         |   |  | 010 | 85958 | ...   |     | ...   | ...   |
| 15 - 19 | Force Series Motorhomes with M2-106 Chassis             | 10-13760-000<br>471700002991<br>SDA471700002991  | 010 | 85959 | 89503 |     | ...   | ...   |
|         |   |  | 010 | 85959 | 89503 |     | ...   | ...   |
|         |   |  | 010 | 85959 | 89503 |     | ...   | ...   |
| 99 - 19 | Isata 4 Series Motorhomes with Ford E350 & E450 Chassis | 8C24-18045-DA<br>8C2Z-18124-D<br>ASH-1154<br>AT-163G<br>8C24-18080-DB<br>8C2Z-18125-D<br>ASH-1136<br>AT-164G | -10 | 83177 | ...   |     | ...   | ...   |
|         |   |  | -10 | 83177 | ...   |     | ...   | ...   |
|         |   |  | -10 | 83177 | ...   |     | ...   | ...   |
|         |   |  | -10 | 83177 | ...   |     | ...   | ...   |
|         |   |  |     | ...   | ...   | -10 | 83178 | ...   |
|         |   |  |     | ...   | ...   | -10 | 83178 | ...   |
|         |   |  |     | ...   | ...   | -10 | 83178 | ...   |













### EAGLE MOTOR COACH

|  |                                      |   |     |                |       |     |       |       |
|--|--------------------------------------|---|-----|----------------|-------|-----|-------|-------|
|  | Buses with Rubber Torsion Suspension | 6-05-5  |     | ...            | ...   | 010 | 85307 | ...   |
|  | Buses with Steel Spring Suspension   | 5532026   |     | 85304          | ...   | 010 | 85304 | ...   |
|  | Models with O.E.M. Number            | 01-0100-020<br>01-0100-905<br>014-0100-905<br>101364<br>154-0100-514<br>5394467<br>680091<br>70039<br>70041 | 010 | 85307          | ...   | 010 | 85307 | ...   |
|  |                                      |   | 010 | 85308          | 89422 |     | 85303 | 89422 |
|  |                                      |   | 010 | 85305          | ...   | 010 | 85305 | ...   |
|  |                                      |   | 010 | 85314          | 89425 |     | ...   | ...   |
|  |                                      |   | 010 | 85305          | ...   | 010 | 85305 | ...   |
|  |                                      |   | 010 | 85303          | ...   | 010 | 85303 | 89422 |
|  |                                      |   | 010 | 85303          | ...   | 010 | 85303 | 89422 |
|  |                                      |   | 010 | 85305          | ...   | 010 | 85305 | ...   |
|  | Additional O.E.M. Interchanges       | 0140100-905<br>12B-5-1<br>12J-5-10<br>690060  | 010 | 85308 or 89422 |       |     |       |       |
|  |                                      |   | 010 | 85735          |       |     |       |       |
|  |                                      |   | 01- | 85733          |       |     |       |       |
|  |                                      |   | 010 | 85713          |       |     |       |       |

### EAST MANUFACTURING CORP.

| Identification of the trailer suspension is necessary to determine what section of the catalog to refer to. Some possible options can be Chalmers, Hendrickson, Neway, Ridewell, Reyco. |  |  |  |     |     |     |       |       |
|---|--|--|--|-----|-----|-----|-------|-------|
|   | Shocks with stamping number            | A-20002<br>A-20126   |  | ... | ... | 010 | 85000 | 89436 |
|   |  |  |  | ... | ... | 010 | 85323 | 89436 |
|   | Trailers with East Trailer part number | 517-05001-18<br>517-05001-23<br>517-05006-20<br>517-05009-14 |  | ... | ... | 010 | 87015 | ...   |
|   |  |  |  | ... | ... | 010 | 85005 | 89430 |
|   |  |  |  | ... | ... | 010 | 85030 | 89440 |
|   |  |  |  | ... | ... | 010 | 83125 | ...   |

## APPLICATION GUIDE - TRUCKS, TRAILERS, AND BUSES

| Year<br>Año<br>Année | Model<br>Modelo<br>Modèle | OEM # | Front  |  |  | Rear  |   |   |
|----------------------|---------------------------|-------|--|--|--|---|---|---|
|                      |                           |       |  |  |  |  |  |  |
|                      |                           |       |   |   |   |  |  |  |
|                      |                           |       | Fleetline  | GasSLX   | GasSLX   | Fleetline   | GasSLX  | GasSLX  |

### EAST MANUFACTURING CORP.(Cont'd.)

|  |  |              |              |     |     |     |              |              |              |
|--|--|--------------|--------------|-----|-----|-----|--------------|--------------|--------------|
|  | Trailers with East Trailer part number | 517-05010-07 |              | ... | ... | OIO | <b>83214</b> | ...          |              |
|  |  |              | 517-05022-07 |     | ... | ... | OIO          | <b>83217</b> | ...          |
|  |  |              | 517-05110-20 |     | ... | ... | OIO          | <b>85000</b> | <b>89436</b> |
|  |  |              | 517-05511-14 |     | ... | ... | OIO          | <b>83128</b> | ...          |
|  |  |              | 517-05805-20 |     | ... | ... | OIO          | <b>85000</b> | <b>89436</b> |
|  |  |              | 517-05806-20 |     | ... | ... | OIO          | <b>85029</b> | ...          |
|  |  |              | 517-05808-20 |     | ... | ... | OIO          | <b>85738</b> | ...          |
|  |  |              | 517-05809-20 |     | ... | ... | OIO          | ...          | <b>89437</b> |
|  |  |              | 517-05916-14 |     | ... | ... | OIO          | <b>83124</b> | <b>89407</b> |

### ELDORADO NATIONAL

|         |  |          |          |              |              |     |              |     |
|---------|--|----------|----------|--------------|--------------|-----|--------------|-----|
| 02 - 13 | 40 Foot Low Floor Buses with O.E.M                           | 13208701 |          | ...          | ...          | -I- | <b>85746</b> | ... |
|         |  |          | 13208801 | -I-          | <b>85745</b> | ... | ...          | ... |
| - 2019  | Advantage Series Shuttle buses with Ford E350 & E450 Chassis | ASH-1136 |          | ...          | ...          | -IO | <b>83178</b> | ... |
|         |  | ASH-1154 | -IO      | <b>83177</b> | ...          | ... | ...          | ... |
| - 2019  | Aerolite Series Shuttle buses with Ford E350 Chassis         | ASH-1136 |          | ...          | ...          | -IO | <b>83178</b> | ... |
|         |  | ASH-1154 | -IO      | <b>83177</b> | ...          | ... | ...          | ... |
| - 2019  | Aerotech Series Shuttle buses with Ford E350 & E450 Chassis  | ASH-1136 |          | ...          | ...          | -IO | <b>83178</b> | ... |
|         |  | ASH-1154 | -IO      | <b>83177</b> | ...          | ... | ...          | ... |

### ELKHART COACH

|        |   |          |          |     |              |     |              |     |
|--------|---|----------|----------|-----|--------------|-----|--------------|-----|
| - 2019 | Coaches with Ford E350 and E450 Chassis | ASH-1136 |          | ... | ...          | -IO | <b>83178</b> | ... |
|        |   |          | ASH-1154 | -IO | <b>83177</b> | ... | ...          | ... |

### ENTEGRA COACH

#### Class A MotorHomes

|      |  |           |     |              |              |     |              |              |
|------|--|-----------|-----|--------------|--------------|-----|--------------|--------------|
| 2019 | Emblem Series MotorHomes with Ford F53 Chassis with 16,000 lb GVW to 22,000 lb GVW | ASH-1229  | OIO | <b>83209</b> | <b>89414</b> |     | ...          | ...          |
|      |  | ASH-25822 | OIO | <b>83209</b> | <b>89414</b> | ... | ...          | ...          |
|      |  | ASH-25823 | OIO | <b>83209</b> | <b>89414</b> | ... | ...          | ...          |
|      |  | ASH-25824 | OIO | ...          | ...          | OIO | <b>83122</b> | <b>89406</b> |
| 2019 | Vision Series MotorHomes with Ford F53 Chassis with 16,000 lb GVW to 22,000 lb GVW | ASH-1229  | OIO | <b>83209</b> | <b>89414</b> | ... | ...          | ...          |
|      |  | ASH-25822 | OIO | <b>83209</b> | <b>89414</b> | ... | ...          | ...          |
|      |  | ASH-25823 | OIO | <b>83209</b> | <b>89414</b> | ... | ...          | ...          |
|      |  | ASH-25824 | OIO | ...          | ...          | OIO | <b>83122</b> | <b>89406</b> |





#### Class C MotorHomes

|         |   |          |     |              |     |     |              |     |
|---------|---|----------|-----|--------------|-----|-----|--------------|-----|
| 17 - 19 | Esteem Series MotorHomes with Ford E350 & E450 Chassis  | ASH-1136 |     | ...          | ... | -IO | <b>83178</b> | ... |
|         |   | ASH-1154 | -IO | <b>83177</b> | ... | ... | ...          | ... |
| 17 - 19 | Odyssey Series MotorHomes with Ford E350 & E450 Chassis | ASH-1136 |     | ...          | ... | -IO | <b>83178</b> | ... |
|         |   | ASH-1154 | -IO | <b>83177</b> | ... | ... | ...          | ... |

### FEDERAL COACH

|         |  |                 |     |              |              |     |              |              |
|---------|--|-----------------|-----|--------------|--------------|-----|--------------|--------------|
| - 2019  | Shuttle buses with Freightliner M2-106 Chassis     | 16-18708-000    |     | ...          | ...          | OIO | <b>85724</b> | <b>89443</b> |
|         |  | 471700002809    |     | ...          | ...          | OIO | <b>85724</b> | <b>89443</b> |
| 02 - 08 | Shuttle buses with Freightliner M2-106 Chassis     | 10-12388-000    | OIO | <b>85920</b> | <b>89503</b> | ... | ...          | ...          |
|         |  | 10-12390-000    | OIO | <b>85920</b> | <b>89503</b> | ... | ...          | ...          |
| 09 - 19 | Shuttle buses with Freightliner M2-106 Chassis     | 10-13760-000    | OIO | <b>85959</b> | <b>89503</b> | ... | ...          | ...          |
|         |  | 471700002991    | OIO | <b>85959</b> | <b>89503</b> | ... | ...          | ...          |
|         |  | SDA471700002991 | OIO | <b>85959</b> | <b>89503</b> | ... | ...          | ...          |
| - 2019  | Spirit Series Shuttle buses with Ford E450 Chassis | ASH-1136        |     | ...          | ...          | -IO | <b>83178</b> | ...          |
|         |  | ASH-1154        | -IO | <b>83177</b> | ...          | ... | ...          | ...          |

## APPLICATION GUIDE - TRUCKS, TRAILERS, AND BUSES





| Year<br>Año<br>Année | Model<br>Modelo<br>Modèle | OEM # | Front   |   | Rear  |   |
|----------------------|---------------------------|-------|---|---|---|---|
|                      |                           |       |  |  |  |  |
|                      |                           |       | Fleetline   | GasSLX  | Fleetline   | GasSLX  |

### FLEETWOOD RV

#### Class A MotorHomes

|               |   |                |   |               |       |       |       |       |     |
|---------------|---|----------------|---|---------------|-------|-------|-------|-------|-----|
| 2018          | Axon Series MotorHomes with Ford F53 Chassis with 16,000 lb GVW to 22,000 lb GVW  | ASH-1229       | OIO   | 83209         | 89414 | ...   | ...   |       |     |
|               |   | ASH-25822      | OIO   | 83209         | 89414 | ...   | ...   |       |     |
|               |   | ASH-25823      | OIO   | 83209         | 89414 | ...   | ...   |       |     |
|               |   | ASH-25824      |   | ...           | ...   | OIO   | 83122 | 89406 |     |
| 02 - 06       | Boulder / Discovery & Expedition MotorHomes with Freightliner XC Chassis<br><br>ADL200 Suspension w/ 20K Rear<br>AS120 Front Suspension<br><br>Rear Shock with O.E.M. Number<br><br>ZF - IFS Front Suspension with 23,000 lb GVW or Greater | 16-16873-000   |   | ...           | ...   | OIO   | 85029 | ...   |     |
|               |   | 141700131810   | OIO   | 83160         | ...   | ...   | ...   | ...   |     |
|               |   | 16-16737-000   | OIO   | 83160         | ...   | ...   | ...   | ...   |     |
|               |   | 16-16874-000   | OIO   | 83160         | ...   | ...   | ...   | ...   |     |
|               |   | 141700131809   |   | ...           | ...   | OIO   | 85029 | ...   |     |
|               |   | 16-16736-000   |   | ...           | ...   | OIO   | 85029 | ...   |     |
|               |   | 16-18103-000   | -I-   | 85900         | ...   | ...   | ...   | ...   |     |
|               |   | 481700000493   | -I-   | 85900         | ...   | ...   | ...   | ...   |     |
|               |   | 01 - 19        | Boulder Series MotorHomes with Ford F53 Chassis with 16,000 lb GVW to 22,000 lb GVW | 1C34-18045-AA | OIO   | 83209 | 89414 | ...   | ... |
|               |   |                |   | 1C34-18045-JA | OIO   | 83209 | 89414 | ...   | ... |
| 9U94-18045-AA | OIO   |                |   | 83209         | 89414 | ...   | ...   |       |     |
| 9U94-18080-AA |   |                |   | ...           | ...   | OIO   | 83122 | 89406 |     |
| 9U9Z-18124-A  | OIO   |                |   | 83209         | 89414 | ...   | ...   |       |     |
| 9U9Z-18125-A  |   |                |   | ...           | ...   | OIO   | 83122 | 89406 |     |
| ASH-1022      | OIO   |                |   | 83209         | 89414 | ...   | ...   |       |     |
| ASH-1023      |   |                |   | ...           | ...   | OIO   | 83122 | 89406 |     |
| ASH-1205      | OIO   |                |   | 83209         | 89414 | ...   | ...   |       |     |
| ASH-1206      |   |                |   | ...           | ...   | OIO   | 83122 | 89406 |     |
| ASH-1228      | OIO   |                |   | 83209         | 89414 | ...   | ...   |       |     |
| ASH-1229      | OIO   |                |   | 83209         | 89414 | ...   | ...   |       |     |
| ASH-1230      |   |                |   | ...           | ...   | OIO   | 83122 | 89406 |     |
| ASH-137       |   |                |   | ...           | ...   | OIO   | 83122 | 89406 |     |
| ASH-25822     | OIO   |                |   | 83209         | 89414 | ...   | ...   |       |     |
| ASH-25823     | OIO   |                |   | 83209         | 89414 | ...   | ...   |       |     |
| ASH-25824     |   |                |   | ...           | ...   | OIO   | 83122 | 89406 |     |
| ASH-294       | OIO   |                |   | 83209         | 89414 | ...   | ...   |       |     |
| AT-620        | OIO   |                |   | 83209         | 89414 | ...   | ...   |       |     |
| AT-621        |   |                |   | ...           | ...   | OIO   | 83122 | 89406 |     |
| AT-766        | OIO   | 83209          | 89414   | ...           | ...   |       |       |       |     |
| 03 - 06       | Excursion & Providence MotorHomes with Freightliner XC Chassis<br><br>ADL200 Suspension w/ 20K Rear<br>AS120 Front Suspension<br><br>Rear Shock with O.E.M. Number<br><br>ZF - IFS Front Suspension with 23,000 lb GVW or Greater           | 16-16873-000   |   | ...           | ...   | OIO   | 85029 | ...   |     |
|               |   | 141700131810   | OIO   | 83160         | ...   | ...   | ...   | ...   |     |
|               |   | 16-16737-000   | OIO   | 83160         | ...   | ...   | ...   | ...   |     |
|               |   | 16-16874-000   | OIO   | 83160         | ...   | ...   | ...   | ...   |     |
|               |   | 141700131809   |   | ...           | ...   | OIO   | 85029 | ...   |     |
|               |   | 16-16736-000   |   | ...           | ...   | OIO   | 85029 | ...   |     |
|               |   | 16-18103-000   | -I-   | 85900         | ...   | ...   | ...   | ...   |     |
|               |   | 481700000493   | -I-   | 85900         | ...   | ...   | ...   | ...   |     |
| 06 - 19       | Flair Series MotorHomes with Ford F53 Chassis with 16,000 lb GVW to 22,000 lb GVW   | ASH-1229       | OIO   | 83209         | 89414 | ...   | ...   |       |     |
|               |   | ASH-25822      | OIO   | 83209         | 89414 | ...   | ...   |       |     |
|               |   | ASH-25823      | OIO   | 83209         | 89414 | ...   | ...   |       |     |
|               |   | ASH-25824      |   | ...           | ...   | OIO   | 83122 | 89406 |     |
| 05 - 14       | Models with Workhorse W20 , W22, & W24 MotorHome Chassis with O.E.M. Number   | 24-153256      |   | ...           | ...   | -I-   | 85124 | ...   |     |
|               |   | F4-BE5-F325-HO |   | ...           | ...   | -I-   | 85124 | ...   |     |
|               |   | W0005663       |   | ...           | ...   | -I-   | 85124 | ...   |     |

**APPLICATION GUIDE - TRUCKS, TRAILERS, AND BUSES**

| Year<br>Año<br>Année | Model<br>Modelo<br>Modèle | OEM # | Front  |  | Rear  |   |
|----------------------|---------------------------|-------|--|--|---|---|
|                      |                           |       |  |  |  |  |
|                      |                           |       | Fleetline  | GasSLX   | Fleetline   | GasSLX  |

**FLEETWOOD RV(Cont'd.)**

**Class A MotorHomes(Cont'd.)**

|         |   |                |       |       |       |       |       |       |
|---------|---|----------------|-------|-------|-------|-------|-------|-------|
| 98 - 04 | Models with Workhorse W20 , W22, & W24 MotorHome Chassis with O.E.M. Number           | 24-186537      |       | ...   | ...   | 01-   | 85126 | ...   |
|         |   | F4-BE5-A011-HO |       | ...   | ...   | 01-   | 85126 | ...   |
| 98 - 14 | Models with Workhorse W20 , W22, & W24 MotorHome Chassis with O.E.M. Number           | 24-153249      | 010   | 85125 | ...   |       | ...   | ...   |
|         |   | 24-186629      | 010   | 85125 | ...   |       | ...   | ...   |
|         |   | F4-BE5-A832-MO | 010   | 85125 | ...   |       | ...   | ...   |
|         |   | F4-BE5-B492-HO | 010   | 85125 | ...   |       | ...   | ...   |
|         |   | F4-BE5-F324-HO | 010   | 85125 | ...   |       | ...   | ...   |
|         |   | W0005662       | 010   | 85125 | ...   |       | ...   | ...   |
|         |   | W0006254       | 010   | 85125 | ...   |       | ...   | ...   |
| 99 - 19 | SouthWind Series MotorHomes with Ford F53 Chassis with 16,000 lb GVW to 22,000 lb GVW | 1C34-18045-AA  | 010   | 83209 | 89414 |       | ...   | ...   |
|         |   | 1C34-18045-JA  | 010   | 83209 | 89414 |       | ...   | ...   |
|         |   | 9U94-18045-AA  | 010   | 83209 | 89414 |       | ...   | ...   |
|         |   | 9U94-18080-AA  |       | ...   | ...   | 010   | 83122 | 89406 |
|         |   | 9U9Z-18124-A   | 010   | 83209 | 89414 |       | ...   | ...   |
|         |   | 9U9Z-18125-A   |       | ...   | ...   | 010   | 83122 | 89406 |
|         |   | ASH-1022       | 010   | 83209 | 89414 |       | ...   | ...   |
|         |   | ASH-1023       |       | ...   | ...   | 010   | 83122 | 89406 |
|         |   | ASH-1205       | 010   | 83209 | 89414 |       | ...   | ...   |
|         |   | ASH-1206       |       | ...   | ...   | 010   | 83122 | 89406 |
|         |   | ASH-1228       | 010   | 83209 | 89414 |       | ...   | ...   |
|         |   | ASH-1229       | 010   | 83209 | 89414 |       | ...   | ...   |
|         |   | ASH-1230       |       | ...   | ...   | 010   | 83122 | 89406 |
|         |   | ASH-137        |       | ...   | ...   | 010   | 83122 | 89406 |
|         |   | ASH-25822      | 010   | 83209 | 89414 |       | ...   | ...   |
|         |   | ASH-25823      | 010   | 83209 | 89414 |       | ...   | ...   |
|         |   | ASH-25824      |       | ...   | ...   | 010   | 83122 | 89406 |
|         |   | ASH-294        | 010   | 83209 | 89414 |       | ...   | ...   |
|         |   | AT-620         | 010   | 83209 | 89414 |       | ...   | ...   |
| AT-621  |   | ...            | ...   | 010   | 83122 | 89406 |       |       |
| AT-766  | 010   | 83209          | 89414 |       | ...   | ...   |       |       |
| 05 - 18 | Storm Series MotorHomes with Ford F53 Chassis with 16,000 lb GVW to 22,000 lb GVW     | ASH-1229       | 010   | 83209 | 89414 |       | ...   | ...   |
|         |   | ASH-25822      | 010   | 83209 | 89414 |       | ...   | ...   |
|         |   | ASH-25823      | 010   | 83209 | 89414 |       | ...   | ...   |
|         |   | ASH-25824      |       | ...   | ...   | 010   | 83122 | 89406 |

**Class C MotorHomes**

|         |  |          |     |       |     |     |       |     |
|---------|--|----------|-----|-------|-----|-----|-------|-----|
| 99 - 19 | Jamboree Series MotorHomes with Ford E350 & E450 Chassis | ASH-1136 |     | ...   | ... | -10 | 83178 | ... |
|         |  | ASH-1154 | -10 | 83177 | ... |     | ...   | ... |
| 2018    | Surge Series MotorHomes with Ford E350 & E450 Chassis    | ASH-1136 |     | ...   | ... | -10 | 83178 | ... |
|         |  | ASH-1154 | -10 | 83177 | ... |     | ...   | ... |
| 99 - 16 | Tioga Series MotorHomes with Ford E350 & E450 Chassis    | ASH-1136 |     | ...   | ... | -10 | 83178 | ... |
|         |  | ASH-1154 | -10 | 83177 | ... |     | ...   | ... |

**FLUIDRIVE**

|  |                                |      |  |     |     |     |       |     |
|--|--------------------------------|------|--|-----|-----|-----|-------|-----|
|  | Models T950-1200, -1400, -1700 | 2697 |  | ... | ... | 010 | 85712 | ... |
|--|--------------------------------|------|--|-----|-----|-----|-------|-----|

**FLXIBLE BUS**

|  |                            |        |     |       |     |     |       |     |
|--|----------------------------|--------|-----|-------|-----|-----|-------|-----|
|  | 29 Passenger & Vista Coach | ....   |     | 83217 | ... | 010 | 83217 | ... |
|  | 2-Level Intercity Bus      | ....   |     | 85736 | ... | 010 | 85736 | ... |
|  | City Bus - 51 Passenger    | 6-05-1 | 010 | 85736 | ... |     | ...   | ... |
|  |                            | 6-05-2 | 010 | 85736 | ... |     | ...   | ... |
|  |                            | 6-05-3 | 010 | 85736 | ... |     | ...   | ... |
|  |                            | 6-05-4 | 010 | 85736 | ... |     | ...   | ... |







## APPLICATION GUIDE - TRUCKS, TRAILERS, AND BUSES

| Year<br>Año<br>Année | Model<br>Modelo<br>Modèle | OEM # | Front     |        | Rear      |        |
|----------------------|---------------------------|-------|-----------|--------|-----------|--------|
|                      |                           |       |           |        |           |        |
|                      |                           |       | Fleetline | GasSLX | Fleetline | GasSLX |

### FLXIBLE BUS(Cont'd.)

|               |  |               |     |       |       |     |       |     |
|---------------|--|---------------|-----|-------|-------|-----|-------|-----|
|               | City Bus - 51 Passenger                                | 6-05-5        | 010 | 85307 | ...   |     | ...   | ... |
|               |  | 6-05-6        | 010 | 85736 | ...   |     | ...   | ... |
|               |  | 6-05-7        | 010 | 85736 | ...   |     | ...   | ... |
|               |  | 6-05-8        | 010 | 85736 | ...   |     | ...   | ... |
|               | City Bus - 51 Passenger with Rubber Torsion Suspension | 6-05-1        |     | 85736 | ...   | 010 | 85736 | ... |
|               |  | 6-05-2        |     | ...   | ...   | 010 | 85736 | ... |
|               |  | 6-05-3        |     | ...   | ...   | 010 | 85736 | ... |
|               |  | 6-05-4        |     | ...   | ...   | 010 | 85736 | ... |
|               |  | 6-05-5        |     | ...   | ...   | 010 | 85307 | ... |
|               |  | 6-05-6        |     | ...   | ...   | 010 | 85736 | ... |
|               |  | 6-05-7        |     | ...   | ...   | 010 | 85736 | ... |
|               |  | 6-05-8        |     | ...   | ...   | 010 | 85736 | ... |
|               | CNG Bus (Natural Gas)                                  | 87-2519-00002 | -10 | 85731 | ...   |     | ...   | ... |
|               |  | 87-2519-00004 | -10 | 85731 | ...   |     | ...   | ... |
|               |  | 87-2520-00002 |     | ...   | ...   | 010 | ...   | ... |
|               |  | 87-2520-00004 |     | ...   | ...   | 010 | ...   | ... |
|               |  | 97-2201-00008 | -10 | 85731 | ...   |     | ...   | ... |
|               |  | 97-2210-00010 |     | ...   | ...   | 010 | ...   | ... |
|               | Model 870 Flex Bus, Metro                              | 22024506      | -10 | 85703 | ...   |     | ...   | ... |
|               |  | 22025066      | -10 | 85703 | ...   |     | ...   | ... |
|               |  | 4975518       |     | ...   | ...   | 010 | 85704 | ... |
|               |  | 680320        | -10 | 85703 | ...   |     | ...   | ... |
|               |  | 74412         |     | ...   | ...   | 010 | 85704 | ... |
|               |  | 87-2519-00001 | -10 | 85703 | ...   |     | ...   | ... |
|               |  | 87-2519-00003 | -10 | 85703 | ...   |     | ...   | ... |
|               |  | 87-2520-00001 |     | ...   | ...   | 010 | 85704 | ... |
|               |  | 87-2520-00003 |     | ...   | ...   | 010 | 85704 | ... |
|               |  | 97-2201-00003 | -10 | 85703 | ...   |     | ...   | ... |
|               |  | 97-2201-00005 | -10 | 85703 | ...   |     | ...   | ... |
|               |  | 97-2201-00006 | -10 | 85703 | ...   |     | ...   | ... |
|               |  | 97-2201-00007 | -10 | 85703 | ...   |     | ...   | ... |
|               |  | 97-2201-00009 | -10 | 85703 | ...   |     | ...   | ... |
|               |  | 97-2210-00001 |     | ...   | ...   | 010 | 85704 | ... |
|               |  | 97-2210-00002 |     | ...   | ...   | 010 | 85704 | ... |
|               |  | 97-2210-00003 |     | ...   | ...   | 010 | 85704 | ... |
|               |  | 97-2210-00004 |     | ...   | ...   | 010 | 85704 | ... |
| 97-2210-00005 |  | ...           | ... | 010   | 85704 | ... |       |     |
| 97-2210-00006 |  | ...           | ... | 010   | 85704 | ... |       |     |
| 97-2210-00009 |  | ...           | ... | 010   | 85704 | ... |       |     |
| 97-2210-00011 |  | ...           | ... | 010   | 85704 | ... |       |     |
|               | Models with O.E.M. Number                              | 22012067      |     | 85700 | ...   | 010 | 85700 | ... |
|               |  | 22012114      |     | 85700 | ...   | 010 | 85700 | ... |
|               |  | 22024061      |     | ...   | ...   | 010 | 85704 | ... |
|               |  | 22025067      |     | ...   | ...   | 010 | 85704 | ... |
|               |  | 22025305      |     | ...   | ...   | 010 | 85704 | ... |
|               |  | 3166657       |     | 85700 | ...   | 010 | 85700 | ... |
|               |  | 3192333       |     | 85700 | ...   | 010 | 85700 | ... |
|               |  | 6-05-13       |     | ...   | ...   | 010 | 85304 | ... |
|               |  | 6-05-9        | 010 | 85304 | ...   |     | ...   | ... |
|               |  | 6-367-12      |     | 85700 | ...   | 010 | 85700 | ... |
|               |  | 6-367-14      |     | 85700 | ...   | 010 | 85700 | ... |
|               |  | 6-367-16      |     | 85700 | ...   | 010 | 85700 | ... |
|               |  | 6-367-8       |     | 85700 | ...   | 010 | 85700 | ... |
|               |  | 695125        |     | ...   | ...   | 010 | 85704 | ... |
|               |  | 97-2201-00001 | -10 | 85703 | ...   |     | ...   | ... |

## APPLICATION GUIDE - TRUCKS, TRAILERS, AND BUSES

| Year<br>Año<br>Année | Model<br>Modelo<br>Modèle | OEM # | Front  |  | Rear  |   |
|----------------------|---------------------------|-------|--|--|---|---|
|                      |                           |       |  |  |  |  |
|                      |                           |       | Fleetline  | GasSLX   | Fleetline   | GasSLX  |

### FLXIBLE BUS(Cont'd.)

|               |                                |               |     |              |                       |     |                       |     |
|---------------|--------------------------------|---------------|-----|--------------|-----------------------|-----|-----------------------|-----|
|               | Models with O.E.M. Number      | 97-2201-0002  | - 0 | <b>85703</b> | ...                   |     | ...                   | ... |
|               |                                | 97-2201-0004  | - 0 | <b>85703</b> | ...                   |     | ...                   | ... |
|               |                                | 97-2201-00151 |     | <b>85700</b> | ...                   | 0 0 | <b>85700</b>          | ... |
|               |                                | 97-2210-00170 |     | <b>85733</b> | ...                   | 0 - | <b>85733</b>          | ... |
|               |                                | 97-9999-02592 | - 0 | <b>85710</b> | ...                   |     | ...                   | ... |
|               | Additional O.E.M. Interchanges | 015813        | - - |              |                       |     | <b>85708</b>          |     |
|               |                                | 06-0367-00151 | 0 0 |              |                       |     | <b>85700</b>          |     |
|               |                                | 06-0367-00156 | 0 0 |              |                       |     | <b>85702</b>          |     |
|               |                                | 48-1-239      | 0 0 |              |                       |     | <b>85736</b>          |     |
|               |                                | 48-1-241      | 0 0 |              |                       |     | <b>85712</b>          |     |
|               |                                | 6-05-10       | 0 0 |              |                       |     | <b>85734</b>          |     |
|               |                                | 6-367-1       | - 0 |              |                       |     | <b>85711</b>          |     |
|               |                                | 6-367-11      | - 0 |              |                       |     | <b>85711</b>          |     |
|               |                                | 6-367-17      | 0 0 |              |                       |     | <b>85700</b>          |     |
|               |                                | 6-367-2       | 0 0 |              |                       |     | <b>85736</b>          |     |
|               |                                | 6-367-3       | 0 0 |              |                       |     | <b>85304</b>          |     |
|               |                                | 6-367-4       | 0 0 |              |                       |     | <b>83217</b>          |     |
|               |                                | 6-367-6       | - 0 |              |                       |     | <b>85711</b>          |     |
|               |                                | 6-367-7       | 0 0 |              |                       |     | <b>85305</b>          |     |
|               |                                | 6-367-9       | - 0 |              |                       |     | <b>85711</b>          |     |
|               |                                | 680029        | 0 0 |              |                       |     | <b>85301</b>          |     |
|               |                                | 680155        | 0 0 |              |                       |     | <b>85712</b>          |     |
|               |                                | 97-2210-00156 | 0 0 |              |                       |     | <b>85702</b>          |     |
|               |                                | 97-2210-00157 | - - |              |                       |     | <b>85708</b>          |     |
|               |                                | 97-2210-00160 | - - |              |                       |     | <b>85705 or 89447</b> |     |
|               |                                | 97-2210-00164 | - - |              |                       |     | <b>85708</b>          |     |
|               |                                | 97-9999-00732 | - - |              |                       |     | <b>85707</b>          |     |
|               |                                | 97-9999-00807 | 0 0 |              |                       |     | <b>85307</b>          |     |
|               |                                | 97-9999-02514 | 0 0 |              |                       |     | <b>85700</b>          |     |
|               |                                | 97-9999-02515 | 0 0 |              |                       |     | <b>85702</b>          |     |
|               |                                | 97-9999-02519 | - - |              |                       |     | <b>85707</b>          |     |
|               |                                | 97-9999-02595 | 0 0 |              |                       |     | <b>85313</b>          |     |
| 97-9999-02632 | - 0                            |               |     |              | <b>85711</b>          |     |                       |     |
| 97-9999-02633 | - 0                            |               |     |              | <b>85311 or 89424</b> |     |                       |     |
| 97-9999-02634 | 0 -                            |               |     |              | <b>85733</b>          |     |                       |     |
| 97-9999-02635 | 0 0                            |               |     |              | <b>85732</b>          |     |                       |     |
| 97-9999-02636 | 0 0                            |               |     |              | <b>85716</b>          |     |                       |     |

### FLYER INDUSTRIES





|               |                                |          |     |              |              |     |              |     |
|---------------|--------------------------------|----------|-----|--------------|--------------|-----|--------------|-----|
|               | Coaches with Low Floor         | 15813    |     | ...          | ...          | - - | <b>85708</b> | ... |
| <b>1991 -</b> | Coaches with Low Floor         | 009863   | - - | <b>85722</b> | ...          |     | ...          | ... |
|               | Additional O.E.M. Interchanges | 015915   | - 0 |              |              |     | <b>85711</b> |     |
|               |                                | 22012067 | 0 0 |              |              |     | <b>85700</b> |     |
|               |                                | 22012114 | 0 0 |              |              |     | <b>85700</b> |     |
|               |                                | 3166657  | 0 0 |              |              |     | <b>85700</b> |     |
|               |                                | 3192333  | 0 0 |              |              |     | <b>85700</b> |     |
|               |                                | 4975501  | 0 0 |              |              |     | <b>85700</b> |     |
|               |                                | 4975552  | - 0 |              |              |     | <b>85711</b> |     |
|               |                                | 592-6568 | 0 0 |              |              |     | <b>85700</b> |     |
| 5979574       | 0 0                            |          |     |              | <b>85700</b> |     |              |     |

### FORD

#### AeroMax (A, AT, AAT, 8500, 9500) Series

|             |   |               |     |              |              |  |     |     |
|-------------|---|---------------|-----|--------------|--------------|--|-----|-----|
| <b>1996</b> | 8000 Models with 12000 or 13000 lb Axles    | F6HT-18045-LA | 0 0 | <b>85376</b> | ...          |  | ... | ... |
| <b>1996</b> | 8000 Models with 16000 lb. Multileaf Spring | F6HT-18045-AA | 0 0 | <b>85054</b> | <b>89438</b> |  | ... | ... |

**APPLICATION GUIDE - TRUCKS, TRAILERS, AND BUSES**

| Year<br>Año<br>Année | Model<br>Modelo<br>Modèle | OEM # | Front   |   | Rear  |   |
|----------------------|---------------------------|-------|---|---|---|---|
|                      |                           |       |  |  |  |  |
|                      |                           |       | Fleetline   | GasSLX  | Fleetline   | GasSLX  |

**FORD(Cont'd.)**

**AeroMax (A, AT, AAT, 8500, 9500) Series(Cont'd.)**

|         |  |               |     |       |       |     |       |       |
|---------|--|---------------|-----|-------|-------|-----|-------|-------|
| 96 - 97 | 9500 (113" & 122" BBC) Models with 10000 lb Axle and 54" Multileaf Spring          | F6HT-18045-KA | 010 | 83200 | 89402 |     | ...   | ...   |
| 1996 -  | 9500 (113" & 122" BBC) Models with 12000 or 13200 lb Axle and 54" Multileaf Spring | F6HT-18045-BC | 010 | 85047 | 89435 |     | ...   | ...   |
| 96 - 97 | 9500 (113" & 122" BBC) Models with 8500 or 9000 lb Axle and 54" Taperleaf Spring   | F6HT-18045-HC | 010 | 85054 | 89438 |     | ...   | ...   |
| 1996 -  | All Models with 10000 lb or 12000 lb Axle and 54" Taperleaf Spring                 | F6HT-18045-AC | 010 | 85054 | 89438 |     | ...   | ...   |
|         |  | F6HZ-18124-A  | 010 | 85054 | 89438 |     | ...   | ...   |
|         |  | F6HZ-18124-G  | 010 | 85054 | 89438 |     | ...   | ...   |
| 1996 -  | All with 12000 lb, 13000 lb or 14600 lb Axle and 60" Taperleaf Spring              | F6HT-18045-EB | 010 | 85055 | 89439 |     | ...   | ...   |
|         |  | F6HT-18045-EC | 010 | 85055 | 89439 |     | ...   | ...   |
|         |  | F6HZ-18124-D  | 010 | 85055 | 89439 |     | ...   | ...   |
|         |  | F6HZ-18124-E  | 010 | 85055 | 89439 |     | ...   | ...   |
|         |  | F6HZ-18124-F  | 010 | 85055 | 89439 |     | ...   | ...   |
| 1996 -  | All with 13200 lb or 14600 lb Axle and 54" Taperleaf Spring                        | F6HT-18045-GB | 010 | 85030 | 89440 |     | ...   | ...   |
|         |  | F6HT-18045-GC | 010 | 85030 | 89440 |     | ...   | ...   |
| 1996 -  | All with 21000 lb or 23000 lb Axle and 46" Taperleaf spring                        | F5HZ-18125-B  |     | ...   | ...   | 010 | 85001 | 89410 |
| 1996 -  | All with 23000 lb Axle and 52" Taperleaf spring                                    | F5HZ-18125-A  |     | ...   | ...   | 010 | 85314 | 89425 |
| 96 - 97 | All with Hendrickson 40LH Model Tandem Axle  | 57241-2       |     | ...   | ...   | 01- | 83109 | ...   |
|         |  | F6HT-18080-B  |     | ...   | ...   | 01- | 83109 | ...   |
|         |  | F6HT-18080-DA |     | ...   | ...   | 01- | 83109 | ...   |
|         |  | F6HZ-18125-B  |     | ...   | ...   | 01- | 83109 | ...   |
|         |  |               |     | ...   | ...   | 010 | 85013 | 89414 |
| 96 - 97 | All with Hendrickson HAS-400, HA-210 or HA-230 Air Suspension                      | 47902-28      |     | ...   | ...   | 010 | 85013 | 89414 |
|         |  | F6HZ-18080-FC |     | ...   | ...   | 010 | 85013 | 89414 |
|         |  | F6HZ-18125-D  |     | ...   | ...   | 010 | 85013 | 89414 |
| 96 - 97 | All with Neway AD-123 Air Suspension   | 90045068      |     | ...   | ...   | -10 | ...   | 89441 |
|         |  | F6HZ-18125-C  |     | ...   | ...   | -10 | ...   | 89441 |
| 96 - 97 | All with Neway AD-246 Air Suspension   | 90045099      |     | ...   | ...   | 010 | 85906 | 89407 |
|         |  | 90045132      |     | ...   | ...   | 010 | 85909 | ...   |









**B - Series - Bus Cowl Chassis**

|         |   |               |     |       |       |     |       |       |
|---------|---|---------------|-----|-------|-------|-----|-------|-------|
| 61 - 79 | B - 500, B - 600, B - 700, B - 750 Models                           | D2TF-18080-HA |     | ...   | ...   | 010 | 83225 | ...   |
|         |   | D7HT-18080-BA |     | ...   | ...   | 010 | 83225 | ...   |
| 70 - 79 | B - 500, B - 600, B - 700, B - 750 Models                           | D2TF-18045-GA | 010 | 83308 | ...   |     | ...   | ...   |
|         |   | D7HT-18045-GA | 010 | 83308 | ...   |     | ...   | ...   |
| 61 - 69 | B - 500, B - 600, B - 700, B - 750 with 4000, 4700 and 5000 lb Axle | .....         | -1- | 83400 | ...   |     | ...   | ...   |
| 61 - 69 | B - 500, B - 600, B - 700, B - 750 with 6000 & 7000 lb Axle         | C2TA-18045-A  | 010 | 83216 | ...   |     | ...   | ...   |
| 77 - 96 | B - 600, B - 700, B - 750, B - 800, B - 7000 with 18500 lb Axle     | ASH-24446     |     | ...   | ...   | 010 | 83215 | ...   |
|         |   | AX-310        |     | ...   | ...   | 010 | 83215 | ...   |
|         |   | D7HT-18080-AA |     | ...   | ...   | 010 | 83215 | ...   |
|         |   | D7HT-18080-DA |     | ...   | ...   | 010 | 83215 | ...   |
|         |   | D7HT-18080-DA |     | ...   | ...   | 010 | 83215 | ...   |
|         |   | E0HT-18080-AA |     | ...   | ...   | 010 | 83215 | ...   |
| 80 - 96 | B - 600, B - 700, B - 800, B - 7000 Models                          | E0HT-18045-AA | 010 | 83309 | 89446 |     | ...   | ...   |
|         |   | E0HT-18045-AB | 010 | 83309 | 89446 |     | ...   | ...   |
|         |   | F1HT-18045-AA | 010 | 83309 | 89446 |     | ...   | ...   |
| 94 - 97 | B - 700, B - 800 with 14600 lb Multileaf Spring                     | F4HT-18045-EA | 010 | 83125 | ...   |     | ...   | ...   |
| 94 - 97 | B - 700, B - 800 with 15000, 17500, 19000 lb Taperleaf Springs      | F4HT-18080-AA |     | ...   | ...   | 010 | 85314 | 89425 |
|         |   | F4HT-18080-AB |     | ...   | ...   | 010 | 85314 | 89425 |
| 94 - 97 | B - 700, B - 800 with 21000 lb Taperleaf Springs                    | F4HT-18080-BA |     | ...   | ...   | 010 | 85001 | 89410 |
| 94 - 97 | B - 700, B - 800 with 52" Multileaf Spring                          | F4HT-18045-CB | 010 | 83107 | ...   |     | ...   | ...   |

**C & CT Series - Tilt Cab**

|         |   |               |     |       |       |  |     |     |
|---------|---|---------------|-----|-------|-------|--|-----|-----|
| 71 - 73 | C-500, C-550, C-600, C-650, C-700, C-750 with 6000 & 7000 lb Axle | D1TF-18045-LA | 010 | 83312 | 89409 |  | ... | ... |
|---------|---|---------------|-----|-------|-------|--|-----|-----|

## APPLICATION GUIDE - TRUCKS, TRAILERS, AND BUSES

| Year<br>Año<br>Année | Model<br>Modelo<br>Modèle | OEM # | Front  |  | Rear  |   |
|----------------------|---------------------------|-------|--|--|---|---|
|                      |                           |       |  |  |  |  |
|                      |                           |       |   |   |  |  |
|                      |                           |       | Fleetline  | GasSLX   | Fleetline   | GasSLX  |

### FORD(Cont'd.)

#### C & CT Series - Tilt Cab(Cont'd.)

|         |  |               |     |        |       |     |       |     |
|---------|--|---------------|-----|--------|-------|-----|-------|-----|
| 64 - 67 | C-550, C-600 with 6000 lb Axle - and Power Steering  | C2TA-18045-A  | 010 | 83216  | ...   |     | ...   | ... |
| 64 - 67 | C-550, C-600 with 6000 lb Axle - Exc. with Power Steering  | C6PF-18077-A  | 010 | G63306 | ...   |     | ...   | ... |
| 64 - 67 | C-550, C-600, C-650, C-700, C-750 Models   | C6PF-18077-F  |     | ...    | ...   | 010 | 83225 | ... |
| 67 - 69 | C-600, C-650, C-700, C-750, C-800, C-850, C-1000 with 7000, 9000, 11000, 12000, 15000 lb Axles - Exc. with 175" Wheel Base | D2HF-18045-CA | 010 | 83308  | ...   |     | ...   | ... |
| 67 - 71 | C-600, C-650, C-700, C-750, C-800, C-850, C-1000 with 7000, 9000, 11000, 12000, 15000 lb Axles and 175" Wheel Base         | C8HA-18045-A  | 010 | 83312  | 89409 |     | ...   | ... |
| 80 - 90 | C-600, C-700, C-7000, C-800, C-8000, CT-800, CT-8000 with 3100 lb Spring and 7000 lb Axle                                  | D7HT-18045-JA | 010 | 83308  | ...   |     | ...   | ... |
| 76 - 79 | C-600, C-700, C-750, C-800, C-900, CT-800, CT-900 Models   | D2EF-18045-AA | 010 | 83312  | 89409 |     | ...   | ... |
|         |  | D7KF-18045-EA | 010 | 83312  | 89409 |     | ...   | ... |
| 80 - 90 | C-600, C-700, C-800, C-7000, CT-800, CT-8000 with 4040, 5040 lb Springs and 7000, 9000, 12000 lb Axles                     | D2EF-18045-AA | 010 | 83312  | 89409 |     | ...   | ... |
| 64 - 66 | C700/1100, CT-700/1100 with 7000, 9000, 11000, 15000 lb Axles  | D2HF-18045-CA | 010 | 83308  | ...   |     | ...   | ... |
| 69 - 79 | C-750, C-800, C-850, C-900, CT-750, CT-800, CT-850, CT-900, CT-950 with 9000 lb to 15000 lb Axles                          | C8HA-18045-A  | 010 | 83312  | 89409 |     | ...   | ... |
|         |  | D1TF-18045-LA | 010 | 83312  | 89409 |     | ...   | ... |
|         |  | D2KF-18045-AA | 010 | 83312  | 89409 |     | ...   | ... |

#### CF Series (Brazilian Built)

|         |   |               |     |       |       |     |       |       |
|---------|---|---------------|-----|-------|-------|-----|-------|-------|
| 86 - 89 | CF - 600, CF - 700 Models   | E5HT-18045-AA | 010 | 85301 | ...   |     | ...   | ...   |
|         |   | E5HT-18080-DA |     | ...   | ...   | 010 | 85315 | ...   |
|         |   | E5HT-18080-EA |     | ...   | ...   | 010 | 85315 | ...   |
| 96 - 97 | CF-7000, CF-8000 or CFT-8000 Models with 16000 lb. Multileaf Spring | F6HT-18045-AA | 010 | 85054 | 89438 |     | ...   | ...   |
| 92 - 97 | CF-7000, CF-8000 or CFT-8000 Models with 9000 lb Axle               | F2HT-18045-BA | 010 | 85376 | ...   |     | ...   | ...   |
|         |   | F2HT-18045-CA | 010 | 85376 | ...   |     | ...   | ...   |
|         |   | F2HZ-18124-A  | 010 | 85376 | ...   |     | ...   | ...   |
|         |   | F6HT-18045-LA | 010 | 85376 | ...   |     | ...   | ...   |
| 86 - 97 | CF-7000, CF-8000 with 12000 lb or 13000 lb Axle                     | .....         |     | ...   | ...   | 010 | 85302 | 89420 |
|         |   | 87HU-18045-AA | 010 | 85301 | ...   |     | ...   | ...   |
|         |   | E5HT-18045-AA | 010 | 85301 | ...   |     | ...   | ...   |
|         |   | E6HZ-18124-A  | 010 | 85301 | ...   |     | ...   | ...   |
|         |   | E7HZ-18124-A  | 010 | 85301 | ...   |     | ...   | ...   |





#### CL & CLT Series - Highway Tractor Tilt Cab

|         |   |               |     |       |     |     |       |       |
|---------|---|---------------|-----|-------|-----|-----|-------|-------|
| 78 - 89 | CL-9000, CLT-9000 Models                                      | D7HT-18045-NA | 010 | 85301 | ... |     | ...   | ...   |
| 90 - 91 | CL-9000, CLT-9000 with Multileaf Spring                       | F1HT-18045-NA | 010 | 85040 | ... |     | ...   | ...   |
| 78 - 89 | CL-9000, CLT-9000 with Rear Tandem Axle with Neway Suspension | D7HA-18080-AA |     | ...   | ... | 010 | 83123 | 89405 |
| 78 - 89 | CL-9000, CLT-9000 with Single Rear Axle Suspension            | D4HA-18080-AA |     | ...   | ... | 010 | 83209 | 89414 |
|         | Models with Hendrickson Rear Air Suspension                   | 47902-13      |     | ...   | ... | 010 | 83122 | 89406 |

#### E Series - E350, E450 Models

|         |   |               |     |       |     |     |       |     |
|---------|---|---------------|-----|-------|-----|-----|-------|-----|
| 92 - 19 | Type A School bus with Ford E350 & E450 Chassis | 8C24-18045-DA | -10 | 83177 | ... |     | ...   | ... |
|         |   | 8C2Z-18124-D  | -10 | 83177 | ... |     | ...   | ... |
|         |   | ASH-1154      | -10 | 83177 | ... |     | ...   | ... |
|         |   | AT-163G       | -10 | 83177 | ... |     | ...   | ... |
|         |   | 8C24-18080-DB |     | ...   | ... | -10 | 83178 | ... |
|         |   | 8C2Z-18125-D  |     | ...   | ... | -10 | 83178 | ... |
|         |   | ASH-1136      |     | ...   | ... | -10 | 83178 | ... |
|         |   | AT-164G       |     | ...   | ... | -10 | 83178 | ... |
| 92 - 19 | Type C Motorhomes with Ford E350 & E450 Chassis | 8C24-18045-DA | -10 | 83177 | ... |     | ...   | ... |
|         |   | 8C2Z-18124-D  | -10 | 83177 | ... |     | ...   | ... |
|         |   | ASH-1154      | -10 | 83177 | ... |     | ...   | ... |
|         |   | AT-163G       | -10 | 83177 | ... |     | ...   | ... |
|         |   | 8C24-18080-DB |     | ...   | ... | -10 | 83178 | ... |
|         |   | 8C2Z-18125-D  |     | ...   | ... | -10 | 83178 | ... |
|         |   | ASH-1136      |     | ...   | ... | -10 | 83178 | ... |
|         |   |               |     | ...   | ... | -10 | 83178 | ... |

**APPLICATION GUIDE - TRUCKS, TRAILERS, AND BUSES**

| Year<br>Año<br>Année | Model<br>Modelo<br>Modèle | OEM # | Front   |   | Rear  |   |
|----------------------|---------------------------|-------|---|---|---|---|
|                      |                           |       |  |  |  |  |
|                      |                           |       | Fleetline   | GasSLX  | Fleetline   | GasSLX  |

**FORD(Cont'd.)**





**E Series - E350, E450 Models(Cont'd.)**

|         |   |         |  |     |     |     |       |     |
|---------|---|---------|--|-----|-----|-----|-------|-----|
| 92 - 19 | Type C Motorhomes with Ford E350 & E450 Chassis | AT-164G |  | ... | ... | -10 | 83178 | ... |
|---------|---|---------|--|-----|-----|-----|-------|-----|

**F Series - Conventional Cab**

|         |   |               |     |        |       |     |       |       |
|---------|---|---------------|-----|--------|-------|-----|-------|-------|
| 64 - 66 | F-1000 Models with 11000 lb to 15000 lb Axles   | C1TT-18045-D  | 010 | G63406 | ...   |     | ...   | ...   |
| 64 - 79 | F-500, F-600 (2 x 4), F-650, F-700, F-750   | C7PF-18077-A  |     | ...    | ...   | 010 | 83225 | ...   |
|         |   | D2TF-18080-HA |     | ...    | ...   | 010 | 83225 | ...   |
| 67 - 69 | F-500, F-600, F-650, F-700, F-750 with 5500, 6000, 7000 & 9000 lb Axles   | C8TA-18045-AA | -10 | G63386 | ...   |     | ...   | ...   |
| 70 - 79 | F-500, F-600, F-650, F-700, F-750 with 5500, 6000, 7000 & 9000 lb Axles   | D2HT-18045-GA | 010 | 83308  | ...   |     | ...   | ...   |
| 70 - 79 | F-500, F-600, F-650, F-700, F-750, F-800 with 5500, 6000, 7000 & 9000 lb Axles  | D2TF-18045-GA | 010 | 83308  | ...   |     | ...   | ...   |
| 64 - 69 | F-500, F-600, F-700, F-750 with 6000 & 7000 Axle  | C2TA-18045-A  | 010 | 83216  | ...   |     | ...   | ...   |
| 86 - 90 | F-600   | E6HT-18080-AA |     | ...    | ...   | 010 | 83215 | ...   |
|         |   | E6HZ-18125-D  |     | ...    | ...   | 010 | 83215 | ...   |
| 80 - 94 | F-600, F-6000, F-700, F-7000, F-800, F-8000, FT-700, FT-800, FT-8000 - Exc. 9000 lb Axle with H.D. Suspension & 12000 lb Axle | E0HT-18045-AA | 010 | 83309  | 89446 |     | ...   | ...   |
|         |   | E0HT-18045-AB | 010 | 83309  | 89446 |     | ...   | ...   |
| 83 - 89 | F-600, F-6000, F-700, F-7000, F-800, F-8000, FT-700, FT-800, FT-8000 with 9000 lb Axle with H.D. Suspension & 12000 lb Axle   | D2HF-18045-AA | 010 | 83314  | ...   |     | ...   | ...   |
|         |   | D7HT-18045-CA | 010 | 83314  | ...   |     | ...   | ...   |
| 64 - 90 | F-600, F-650, F-700, F-750, F-800 with 13000 & 15000 lb Rear Axle   | D7HT-18080-BA |     | ...    | ...   | 010 | 83225 | ...   |
| 86 - 90 | F-600, F-700, F-800   | ASH-24446     |     | ...    | ...   | 010 | 83215 | ...   |
|         |   | AX-310        |     | ...    | ...   | 010 | 83215 | ...   |
| 80 - 90 | F-600, F-700, F-800 with 17000 & 18000 lb Rear Axle   | D7HF-18080-AA |     | ...    | ...   | 010 | 83215 | ...   |
|         |   | D7HT-18080-DA |     | ...    | ...   | 010 | 83215 | ...   |
| 1990    | F-600, F-700, F-800, FT-800, FT-900, with Multileaf Spring  | F1HT-18045-AA | 010 | 83309  | 89446 |     | ...   | ...   |
| 89 - 94 | F-600, F-700, LPO (Low Profile Vehicle)   | E9HS-18045-AA | 010 | 83309  | 89446 |     | ...   | ...   |
|         |   | E9HS-18080-AA |     | ...    | ...   | 010 | 85716 | ...   |
| 70 - 72 | F-700 (Diesel), F-750 with 9000 lb Axle   | D2HF-18045-CA | 010 | 83308  | ...   |     | ...   | ...   |
| 73 - 79 | F-700 (Diesel), F-750, F-800 with 9000 lb Axle  | D2EF-18045-AA | 010 | 83312  | 89409 |     | ...   | ...   |
|         |   | D2TF-18045-AA | 010 | 83312  | 89409 |     | ...   | ...   |
|         |   | D7HT-18045-BA | 010 | 83312  | 89409 |     | ...   | ...   |
| 86 - 97 | F-700, F-800  | ASH-24446     |     | ...    | ...   | 010 | 83215 | ...   |
|         |   | AX-310        |     | ...    | ...   | 010 | 83215 | ...   |
|         |   | E6HT-18080-AA |     | ...    | ...   | 010 | 83215 | ...   |
|         |   | E6HZ-18125-D  |     | ...    | ...   | 010 | 83215 | ...   |
| 94 - 98 | F-700, F-800 with 15000, 17500, 19000 lb Taperleaf Springs  | F4HT-18080-AA |     | ...    | ...   | 010 | 85314 | 89425 |
|         |   | F4HT-18080-AB |     | ...    | ...   | 010 | 85314 | 89425 |
|         |   | F5HZ-18125-A  |     | ...    | ...   | 010 | 85314 | 89425 |
| 94 - 97 | F-700, F-800 with 21000 lb Taperleaf Springs  | F4HT-18080-BA |     | ...    | ...   | 010 | 85001 | 89410 |
| 94 - 97 | F-700, F-800 with 52" or 54" Taperleaf Springs and with 10000 or 12000 lb Axle  | F4HT-18045-DA | 010 | 85063  | ...   |     | ...   | ...   |
|         |   | F5HZ-18124-C  | 010 | 85063  | ...   |     | ...   | ...   |
| 94 - 97 | F-700, F-800 with Multileaf Spring and 14600 lb Axle  | F4HT-18045-EA | 010 | 83125  | ...   |     | ...   | ...   |
|         |   | F5HZ-18124-D  | 010 | 83125  | ...   |     | ...   | ...   |
| 94 - 97 | F-700, F-800 with Multileaf Spring and with 10000, 12000 or 13200 lb Axle   | F4HT-18045-CB | 010 | 83107  | ...   |     | ...   | ...   |
|         |   | F5HZ-18124-B  | 010 | 83107  | ...   |     | ...   | ...   |
| 94 - 98 | F-700, F-800 with Taperleaf Springs and with 6000, 7000, 8500, 9000 lb Axle   | F4HT-18045-AB | 010 | 83314  | ...   |     | ...   | ...   |
|         |   | F4HT-18045-AC | 010 | 83314  | ...   |     | ...   | ...   |
|         |   | F5HZ-18124-A  | 010 | 83314  | ...   |     | ...   | ...   |
| 76 - 79 | F-800   | D2HT-18080-HA |     | ...    | ...   | 010 | 83225 | ...   |
|         |   | D7HT-18045-GA | 010 | 83308  | ...   |     | ...   | ...   |
| 64 - 66 | F-800, F-850, F-900, F-950, F-1000 - Exc. Diesel with 11000 CP Axle   | C1TT-18045-D  | 010 | G63406 | ...   |     | ...   | ...   |

**APPLICATION GUIDE - TRUCKS, TRAILERS, AND BUSES**

| Year<br>Año<br>Année | Model<br>Modelo<br>Modèle | OEM # | Front   |  | Rear  |   |
|----------------------|---------------------------|-------|---|--|---|---|
|                      |                           |       |  |  |  |  |
|                      |                           |       | Fleetline   | GasSLX   | Fleetline   | GasSLX  |

**FORD(Cont'd.)**





**F Series - Conventional Cab(Cont'd.)**

|         |   |               |     |       |       |  |     |     |
|---------|---|---------------|-----|-------|-------|--|-----|-----|
| 64 - 69 | F-800, F-850-,F-900, F-950, F-1000 with 6000, 7000, 9000, 11000, 12000, 15000, 18000 lb Axles (Exc. Diesel with 6000 and 7000 lb Axles) | C1TT-18045-C  | 010 | 83312 | 89409 |  | ... | ... |
|         |   | C6PF-18077-DL | 010 | 83312 | 89409 |  | ... | ... |
| 64 - 69 | F-950, F-1000, F-1100 Diesel with 7000 lb Axle  | C6PF-18077-DN | 010 | 83314 | ...   |  | ... | ... |

**F Series - F450, F550, F650, F750 Models**

|                |  |                |     |       |     |     |        |     |
|----------------|--|----------------|-----|-------|-----|-----|--------|-----|
| 99 - 04        | F-450 , F-550 Superduty with single or dual rear wheels with 165" or 201" wheel base | ASH-23486      |     | ...   | ... | 010 | G63461 | ... |
|                |  | ASH-247        |     | ...   | ... | 010 | G63461 | ... |
|                |  | AT-610         |     | ...   | ... | 010 | G63461 | ... |
|                |  | AT-611         |     | ...   | ... | 010 | G63461 | ... |
|                |  | F81A-18080-DCA |     | ...   | ... | 010 | G63461 | ... |
|                |  | F81Z-18125-DC  |     | ...   | ... | 010 | G63461 | ... |
| 00 - 15        | F-650 with 10,000 lb Front Suspension  | 3584116C1      | 010 | 83175 | ... |     | ...    | ... |
|                |  | 3584116C2      | 010 | 83175 | ... |     | ...    | ... |
|                |  | 4C4Z-18124-QA  | 010 | 83175 | ... |     | ...    | ... |
|                |  | AA-616         | 010 | 83175 | ... |     | ...    | ... |
| 00 - 15        | F-650 with 12,000 & 13,200 lb Front Springs  | 3584118C2      | 010 | 85928 | ... |     | ...    | ... |
|                |  | 4C4Z-18124-JB  | 010 | 85928 | ... |     | ...    | ... |
|                |  | 4C4Z-18124-RA  | 010 | 85928 | ... |     | ...    | ... |
|                |  | AA-617         | 010 | 85928 | ... |     | ...    | ... |
|                |  | AT-812         | 010 | 85928 | ... |     | ...    | ... |
| July/2015 - 19 | F-650 with 13,500, 15,500 & 19,000 lb Multi-leaf Rear Springs                        | 471700011531   |     | ...   | ... | 010 | 85180  | ... |
|                |  | ASH-24660      |     | ...   | ... | 010 | 85180  | ... |
|                |  | FC44-18080-AB  |     | ...   | ... | 010 | 85180  | ... |
|                |  | FC4Z-18125-A   |     | ...   | ... | 010 | 85180  | ... |
| July/2015 - 19 | F-650 with 19.5" or 22.5" Wheels (22,000 lb GVW)                                     | 471700011530   | 010 | 85181 | ... |     | ...    | ... |
|                |  | ASH-24658      | 010 | 85181 | ... |     | ...    | ... |
|                |  | ASH-24659      | 010 | 85181 | ... |     | ...    | ... |
|                |  | FC44-18045-BB  | 010 | 85181 | ... |     | ...    | ... |
|                |  | FC4Z-18124-A   | 010 | 85181 | ... |     | ...    | ... |
|                |  | FC4Z-18124-B   | 010 | 85181 | ... |     | ...    | ... |
| - 2015         | F-650 with 21,000 lb Rear Air Suspension   | 3578858C1      |     | ...   | ... | 010 | 85926  | ... |
|                |  | 3578858C2      |     | ...   | ... | 010 | 85926  | ... |
|                |  | 4C4Z-18125-DA  |     | ...   | ... | 010 | 85926  | ... |
| 04 - 11        | F-650 with 22,000 lb Multi-leaf Rear Springs   | 4C4Z-18125-B   |     | ...   | ... | -10 | 83317  | ... |
|                |  | 501906C92      |     | ...   | ... | -10 | 83317  | ... |
| 00 - 03        | F-650 with 23,000 lb Multi-leaf Rear Springs   | ASH-2447       |     | ...   | ... | 010 | 83140  | ... |
|                |  | AT-696         |     | ...   | ... | 010 | 83140  | ... |
|                |  | F81A-18080-ZC  |     | ...   | ... | 010 | 83140  | ... |
|                |  | F81Z-18125-ZA  |     | ...   | ... | 010 | 83140  | ... |
|                |  |                |     | ...   | ... | 010 | 83140  | ... |
| 00 - 15        | F-650 with 8,500 lb Front Suspension   | 3584117C2      | 010 | 83135 | ... |     | ...    | ... |
|                |  | 4C4Z-18124-HB  | 010 | 83135 | ... |     | ...    | ... |
|                |  | 4C4Z-18124-P   | 010 | 83135 | ... |     | ...    | ... |
|                |  | AA-615         | 010 | 83135 | ... |     | ...    | ... |
|                |  | AT-811         | 010 | 83135 | ... |     | ...    | ... |
|                |  | FC4Z-18124-HB  | 010 | 83135 | ... |     | ...    | ... |
| 00 - 01/23/02  | F-650 with 8500 or 9000 lb Front Axle  | 3U2Z-18124-MAA | 010 | 83131 | ... |     | ...    | ... |
|                |  | AA-494         | 010 | 83131 | ... |     | ...    | ... |
|                |  | ASH-397        | 010 | 83131 | ... |     | ...    | ... |
|                |  | XC35-18045-AB  | 010 | 83131 | ... |     | ...    | ... |
|                |  | XC35-18045-AD  | 010 | 83131 | ... |     | ...    | ... |
|                |  | XC35-18045-JA  | 010 | 83131 | ... |     | ...    | ... |
|                |  | XC3Z-18124-JA  | 010 | 83131 | ... |     | ...    | ... |
|                |  |                | 010 | 83131 | ... |     | ...    | ... |

**APPLICATION GUIDE - TRUCKS, TRAILERS, AND BUSES**

| Year<br>Año<br>Année | Model<br>Modelo<br>Modèle | OEM # | Front   |   | Rear  |   |
|----------------------|---------------------------|-------|---|---|---|---|
|                      |                           |       |  |  |  |  |
|                      |                           |       | Fleetline   | GasSLX  | Fleetline   | GasSLX  |





**FORD(Cont'd.)**

**F Series - F450, F550, F650, F750 Models(Cont'd.)**

|                |   |                |     |       |     |     |       |       |
|----------------|---|----------------|-----|-------|-----|-----|-------|-------|
| 00 - 03        | F-650 with Hendrickson HAS - 190 Rear Air Suspension          | 1C44-18080-AA  |     | ...   | ... | 010 | 83123 | 89405 |
|                |   | 60670-008      |     | ...   | ... | 010 | 83123 | 89405 |
|                |   | 60670-008L     |     | ...   | ... | 010 | 83123 | 89405 |
| 04 - 09        | F-650 with Hendrickson HAS - 230 Rear Air Suspension          | 4C4Z-18125-CA  |     | ...   | ... | 010 | 85976 | ...   |
|                |   | 60675-003      |     | ...   | ... | 010 | 85976 | ...   |
|                |   | 60675-003L     |     | ...   | ... | 010 | 85976 | ...   |
|                |   | ASH-1105       |     | ...   | ... | 010 | 85976 | ...   |
|                |   | ASH-722        |     | ...   | ... | 010 | 85976 | ...   |
| 05 - 07        | F-650 with O.E.M. Number                                      | 3553628C1      | 010 | 85927 | ... |     | ...   | ...   |
|                |   | 3553628C2      | 010 | 85927 | ... |     | ...   | ...   |
| 00 - 15        | F-750 with 10,000 lb Front Suspension                         | 3584116C1      | 010 | 83175 | ... |     | ...   | ...   |
|                |   | 3584116C2      | 010 | 83175 | ... |     | ...   | ...   |
|                |   | 4C4Z-18124-QA  | 010 | 83175 | ... |     | ...   | ...   |
|                |   | AA-616         | 010 | 83175 | ... |     | ...   | ...   |
| 00 - 15        | F-750 with 12,000 & 13,200 lb Front Springs                   | 3584118C2      | 010 | 85928 | ... |     | ...   | ...   |
|                |   | 4C4Z-18124-JB  | 010 | 85928 | ... |     | ...   | ...   |
|                |   | 4C4Z-18124-RA  | 010 | 85928 | ... |     | ...   | ...   |
|                |   | AA-617         | 010 | 85928 | ... |     | ...   | ...   |
|                |   | AT-812         | 010 | 85928 | ... |     | ...   | ...   |
| July/2015 - 19 | F-750 with 13,500, 15,500 & 19,000 lb Multi-leaf Rear Springs | 471700011531   |     | ...   | ... | 010 | 85180 | ...   |
|                |   | ASH-24660      |     | ...   | ... | 010 | 85180 | ...   |
|                |   | FC44-18080-AB  |     | ...   | ... | 010 | 85180 | ...   |
|                |   | FC4Z-18125-A   |     | ...   | ... | 010 | 85180 | ...   |
| July/2015 - 19 | F-750 with 19.5" or 22.5" Wheels (22,000 lb GVW)              | 471700011530   | 010 | 85181 | ... |     | ...   | ...   |
|                |   | ASH-24658      | 010 | 85181 | ... |     | ...   | ...   |
|                |   | ASH-24659      | 010 | 85181 | ... |     | ...   | ...   |
|                |   | FC44-18045-BB  | 010 | 85181 | ... |     | ...   | ...   |
|                |   | FC4Z-18124-A   | 010 | 85181 | ... |     | ...   | ...   |
|                |   | FC4Z-18124-B   | 010 | 85181 | ... |     | ...   | ...   |
| - 2015         | F-750 with 21,000 lb Rear Air Suspension                      | 3578858C1      |     | ...   | ... | 010 | 85926 | ...   |
|                |   | 3578858C2      |     | ...   | ... | 010 | 85926 | ...   |
|                |   | 4C4Z-18125-DA  |     | ...   | ... | 010 | 85926 | ...   |
| 04 - 11        | F-750 with 22,000 lb Rear Spring Suspension                   | 4C4Z-18125-B   |     | ...   | ... | -10 | 83317 | ...   |
|                |   | 501906C92      |     | ...   | ... | -10 | 83317 | ...   |
| 00 - 03        | F-750 with 23000 lb Multi-leaf Rear Springs                   | ASH-2447       |     | ...   | ... | 010 | 83140 | ...   |
|                |   | AT-696         |     | ...   | ... | 010 | 83140 | ...   |
|                |   | F81A-18080-ZC  |     | ...   | ... | 010 | 83140 | ...   |
|                |   | F81Z-18125-ZA  |     | ...   | ... | 010 | 83140 | ...   |
| 00 - 15        | F-750 with 8,500 lb Front Suspension                          | 3584117C2      | 010 | 83135 | ... |     | ...   | ...   |
|                |   | 4C4Z-18124-HB  | 010 | 83135 | ... |     | ...   | ...   |
|                |   | 4C4Z-18124-P   | 010 | 83135 | ... |     | ...   | ...   |
|                |   | AA-615         | 010 | 83135 | ... |     | ...   | ...   |
|                |   | AT-811         | 010 | 83135 | ... |     | ...   | ...   |
|                |   | FC4Z-18124-HB  | 010 | 83135 | ... |     | ...   | ...   |
| 00 - 01/23/02  | F-750 with 8500 or 9000 lb Front Axle                         | 3U2Z-18124-MAA | 010 | 83131 | ... |     | ...   | ...   |
|                |   | AA-494         | 010 | 83131 | ... |     | ...   | ...   |
|                |   | ASH-397        | 010 | 83131 | ... |     | ...   | ...   |
|                |   | XC35-18045-AB  | 010 | 83131 | ... |     | ...   | ...   |
|                |   | XC35-18045-AD  | 010 | 83131 | ... |     | ...   | ...   |
|                |   | XC35-18045-JA  | 010 | 83131 | ... |     | ...   | ...   |
|                |   | XC3Z-18124-JA  | 010 | 83131 | ... |     | ...   | ...   |
| 00 - 03        | F-750 with Hendrickson HAS - 190 Rear Air Suspension          | 1C44-18080-AA  |     | ...   | ... | 010 | 83123 | 89405 |
|                |   | 60670-008      |     | ...   | ... | 010 | 83123 | 89405 |



**APPLICATION GUIDE - TRUCKS, TRAILERS, AND BUSES**

| Year<br>Año<br>Année | Model<br>Modelo<br>Modèle | OEM # | Front   |   | Rear  |  |
|----------------------|---------------------------|-------|---|---|---|--|
|                      |                           |       |  Fleetline |  GasSLX |  Fleetline |  GasSLX |

**FORD(Cont'd.)**

**F Series - F450, F550, F650, F750 Models(Cont'd.)**

|         |  |               |     |       |     |     |       |       |
|---------|--|---------------|-----|-------|-----|-----|-------|-------|
| 00 - 03 | F-750 with Hendrickson HAS - 190 Rear Air Suspension | 60670-008L    |     | ...   | ... | 010 | 83123 | 89405 |
| 04 - 09 | F-750 with Hendrickson HAS - 230 Rear Air Suspension | 4C4Z-18125-CA |     | ...   | ... | 010 | 85976 | ...   |
|         |  | 60675-003     |     | ...   | ... | 010 | 85976 | ...   |
|         |  | 60675-003L    |     | ...   | ... | 010 | 85976 | ...   |
|         |  | ASH-1105      |     | ...   | ... | 010 | 85976 | ...   |
|         |  | ASH-722       |     | ...   | ... | 010 | 85976 | ...   |
| 05 - 07 | F-750 with O.E.M. Number                             | 3553628C1     | 010 | 85927 | ... |     | ...   | ...   |
|         |  | 3553628C2     | 010 | 85927 | ... |     | ...   | ...   |

**FT Series - Conventional Cab**

|         |  |               |     |       |       |     |       |       |
|---------|--|---------------|-----|-------|-------|-----|-------|-------|
| 90 - 92 | FT-900 (Low Profile Vehicle)   | E9HS-18080-AA |     | ...   | ...   | 010 | 85716 | ...   |
| 90 - 94 | FT-900 (Low Profile Vehicle)   | E9HZ-18124-A  | 010 | 83309 | 89446 |     | ...   | ...   |
| 94 - 97 | FT-900 with 46" Taperleaf Spring and 15000, 17500 or 19000 lb Axle                         | F4HT-18080-AA |     | ...   | ...   | 010 | 85314 | 89425 |
|         |  | F4HT-18080-AB |     | ...   | ...   | 010 | 85314 | 89425 |
|         |  | F5HZ-18125-DA |     | ...   | ...   | 010 | 85314 | 89425 |
| 94 - 97 | FT-900 with 46" Taperleaf Springs and 21000 lb Axle  | F4HT-18080-BA |     | ...   | ...   | 010 | 85001 | 89410 |
| 94 - 97 | FT-900 with 52 or 54" Taperleaf Springs and with 10000 or 12000 lb Axle                    | F4HT-18045-DA | 010 | 85063 | ...   |     | ...   | ...   |
|         |  | F5HZ-18124-C  | 010 | 85063 | ...   |     | ...   | ...   |
| 90 - 94 | FT-900 with 9000 lb Axle with H.D. Suspension or 10000, 11000, or 12000 lb Axles           | C4HZ-18124-E  | 010 | 83309 | 89446 |     | ...   | ...   |
|         |  | F1HT-18045-AA | 010 | 83309 | 89446 |     | ...   | ...   |
|         |  | F1HZ-18124-A  | 010 | 83309 | 89446 |     | ...   | ...   |
| 94 - 97 | FT-900 with Multileaf Spring and 14600 lb Axle   | F4HT-18045-EA | 010 | 83125 | ...   |     | ...   | ...   |
|         |  | F5HZ-18124-D  | 010 | 83125 | ...   |     | ...   | ...   |
| 94 - 97 | FT-900 with Multileaf Spring and with 10000, 12000 or 13200 lb Axle                        | F4HT-18045-CB | 010 | 83107 | ...   |     | ...   | ...   |
|         |  | F5HZ-18124-B  | 010 | 83107 | ...   |     | ...   | ...   |
| 90 - 97 | FT-900 with shock located forward of rear axle   | ASH-24446     |     | ...   | ...   | 010 | 83215 | ...   |
|         |  | AX-310        |     | ...   | ...   | 010 | 83215 | ...   |
|         |  | E6HT-18080-AA |     | ...   | ...   | 010 | 83215 | ...   |
|         |  | E6HZ-18125-D  |     | ...   | ...   | 010 | 83215 | ...   |
| 90 - 94 | FT-900, FT-900LP with 9000 lb Axle with H.D. Suspension or 10000, 11000, or 12000 lb Axles | E9HS-18045-AA | 010 | 83309 | 89446 |     | ...   | ...   |
| 94 - 97 | FT-900, with Taperleaf Springs and with 6000, 7000, 8500 or 9000 lb Axles                  | F4HT-18045-AB | 010 | 83314 | ...   |     | ...   | ...   |
|         |  | F5HZ-18124-A  | 010 | 83314 | ...   |     | ...   | ...   |







**H and HT Series - Hi Tilt Cab**

|         |                                   |       |     |       |     |  |     |     |
|---------|-----------------------------------|-------|-----|-------|-----|--|-----|-----|
| 61 - 63 | HT-950 with 11000 lb Axle         | ..... | 010 | 83314 | ... |  | ... | ... |
| 61 - 66 | HT-950 with 12000 & 15000 lb Axle | ..... | 010 | 83314 | ... |  | ... | ... |

**L, LT & LTS - Conventional Cab**

|         |   |               |     |       |       |     |       |       |
|---------|---|---------------|-----|-------|-------|-----|-------|-------|
| 73 - 90 | L-800, L8000, L-900, L-9000, LT-800, LT-880, LT8000, LT-900, LT-9000 with 7000, 9000, 12000 lb Axles                                    | D2EF-18045-AA | 010 | 83312 | 89409 |     | ...   | ...   |
|         |   | D2KF-18045-AA | 010 | 83312 | 89409 |     | ...   | ...   |
|         |   | D7HF-18045-FA | 010 | 83312 | 89409 |     | ...   | ...   |
|         |   | D7HT-18045-BA | 010 | 83312 | 89409 |     | ...   | ...   |
| 73 - 85 | L-800, L8000, L-900,L-9000, LT-800, LT-880, LT8000, LT-900, LT-9000, LTS-8000, LTS-900, LTS-9000 with 7000, 9000, 12000, 16000 lb Axles | D2HF-18045-AA | 010 | 83314 | ...   |     | ...   | ...   |
|         |   | D2HT-18045-CA | 010 | 83314 | ...   |     | ...   | ...   |
| 73 - 90 | L-800, L850, L-900,L-9000, LT-800, LT-850, LT880, LT-900, LT-9000, LTS-800, LTS-850, LTS-900 with 7000, 9000, 12000, 16000 lb Axles     | D2HF-18045-BA | 010 | 83309 | 89446 |     | ...   | ...   |
|         |   | D7HT-18045-DA | 010 | 83309 | 89446 |     | ...   | ...   |
| 94 - 97 | L-8000, L-9000, LT-8000 or LT-9000 Models with 21000 or 23000 lb. with 46" Taperleaf Spring   | F4HT-18080-BA |     | ...   | ...   | 010 | 85001 | 89410 |
| 90 - 97 | L-8000, L-9000, LT-8000, LT-9000 with 52" Taperleaf Spring  | F1HT-18045-GA | 010 | 85006 | 89401 |     | ...   | ...   |
|         |   | F1HT-18045-GB | 010 | 85006 | 89401 |     | ...   | ...   |

## APPLICATION GUIDE - TRUCKS, TRAILERS, AND BUSES

| Year<br>Año<br>Année | Model<br>Modelo<br>Modèle | OEM # | Front   |   | Rear  |   |
|----------------------|---------------------------|-------|---|---|---|---|
|                      |                           |       |  |  |   |   |
|                      |                           |       |  |  |  |  |

### FORD(Cont'd.)

#### L, LT & LTS - Conventional Cab(Cont'd.)

|         |   |               |     |       |       |     |       |       |
|---------|---|---------------|-----|-------|-------|-----|-------|-------|
| 90 - 97 | L-8000, L-9000, LT-8000, LT-9000 with 58" Parabolic Taperleaf Spring  | F1HT-18045-RA | OIO | ...   | 89402 |     | ...   | ...   |
|         |   | F1HT-18045-RB | OIO | ...   | 89402 |     | ...   | ...   |
|         | L-8000, L-9000, LT-8000, LT-9000 with Hendrickson Rear Air Suspension   | 47902-13      |     | ...   | ...   | OIO | 83122 | 89406 |
| 91 - 97 | L-8000, L-9000, LT-8000, LT-9000 with Multileaf Spring  | F1HT-18045-DA | OIO | 83312 | 89409 |     | ...   | ...   |
| 91 - 97 | L-8000, L-9000, LT-8000, LT-9000 with 4000, 4500, 5400, 6000, 7200 lb Multileaf Springs and with 9000, 10000, 12000 or 16000 lb Axles | F1HT-18045-CB | OIO | 83216 | ...   |     | ...   | ...   |
| 91 - 97 | L-8000, L-9000, LT-8000, LT-9000 with 4500, 5400, 6000, 7200, 10000 lb Multileaf Springs and with 10000, 12000, 13200, 16000 lb Axles | F1HT-18045-DB | OIO | 83308 | ...   |     | ...   | ...   |
| 73 - 89 | LTS-800, LTS-850, LTS-900, LTS-9000 with 16000 lb Axle  | D0HA-18045-E  | OIO | 83312 | 89409 |     | ...   | ...   |
|         |   | D2HF-18045-DA | OIO | 83312 | 89409 |     | ...   | ...   |
|         |   | D7HT-18045-EA | OIO | 83312 | 89409 |     | ...   | ...   |

#### LA, LS & LST - Conventional Cab

|         |   |               |     |       |       |     |       |       |
|---------|---|---------------|-----|-------|-------|-----|-------|-------|
| 1996    | LA-8000 Models with 12000 or 13000 lb Axles                                       | F6HT-18045-LA | OIO | 85376 | ...   |     | ...   | ...   |
| 1996    | LA-8000 Models with 16000 lb. Multileaf Spring                                    | F6HT-18045-AA | OIO | 85054 | 89438 |     | ...   | ...   |
| 91 - 96 | LA-8000, LA-9000 Models with 4000, 4500, 5400, 6000, or 7200 lb. Multileaf Spring | F1HT-18045-CB | OIO | 83216 | ...   |     | ...   | ...   |
| 91 - 96 | LA-8000, LA-9000 Models with Hendrickson Rear Air Suspension                      | 47902-28      |     | ...   | ...   | OIO | 85013 | 89414 |
| 90 - 97 | LA-8000, LA-9000, LS-8000, LST-8000 with 4500 lb to 10000 lb Multileaf Spring     | F1HT-18045-CA | OIO | 83308 | ...   |     | ...   | ...   |
| 90 - 97 | LA-8000, LS-8000, LST-8000 with 52" Taperleaf Spring                              | F1HT-18045-EA | OIO | ...   | 89402 |     | ...   | ...   |
| 91 - 96 | LA-8000, LS-8000, LST-8000 with 58" Taperleaf Spring                              | F1HT-18045-EB | OIO | ...   | 89402 |     | ...   | ...   |









#### LL, LLA, LTA, LTL, LTLA - Conventional Cab

|         |  |               |     |       |       |     |       |       |
|---------|--|---------------|-----|-------|-------|-----|-------|-------|
| 91 - 95 | LL-9000 with 4500, 5000, 6000 lb Springs and with 10000, 11000, 12000 lb Axles   | F1HT-18045-DB | OIO | 83308 | ...   |     | ...   | ...   |
| 91 - 96 | LL-9000, LLA-9000, LTA-9000, LTLA-9000, with 4000, 4500, 5400, 6000 or 7200 lb Multileaf Springs and with 9000, 10000, 12000 or 16000 lb Axles | F1HT-18045-CB | OIO | 83216 | ...   |     | ...   | ...   |
| 91 - 96 | LLA-9000, LTLA-9000 with 4500, 5400, 6500 lb 58" Parabolic Taperleaf Spring  | F0HT-18045-CA | OIO | 85006 | 89401 |     | ...   | ...   |
|         |  | F1HT-18045-HB | OIO | 85006 | 89401 |     | ...   | ...   |
| 91 - 96 | LTA-9000, LLA-9000 or LTLA-9000 Models<br>With 4500, 5400, 6000, 7200 or 10000 lb. Multileaf Spring<br>With Hendrickson Rear Air Suspension    | F1HT-18045-CA | OIO | 83308 | ...   |     | ...   | ...   |
|         |  | 47902-28      |     | ...   | ...   | OIO | 85013 | 89414 |
| 80 - 85 | LTL-900, LTL-9000 with 7000, 9000, 12000 lb Axle   | D2HF-18045-AA | OIO | 83314 | ...   |     | ...   | ...   |

#### LN & LNT - Conventional Cab

|         |   |               |     |       |       |     |       |       |
|---------|---|---------------|-----|-------|-------|-----|-------|-------|
| 1972    | LN-500, LN-550 with 11000, 13000, 15000, 17000 lb Axles   | D2TF-18080-HA |     | ...   | ...   | OIO | 83225 | ...   |
| 70 - 72 | LN-500, LN-550 with 5000, 5500, 6000 & 7000 lb Axles  | D2TF-18045-GA | OIO | 83308 | ...   |     | ...   | ...   |
| 72 - 79 | LN-600, LN-650, LN-700, LN-750 with 11000, 13000, 15000, 17000 lb Axles   | D2TF-18080-HA |     | ...   | ...   | OIO | 83225 | ...   |
| 70 - 89 | LN-600, LN-650, LN-700, LN-750, LN-7000, LN-800, LN-8000, LNT-800, LNT-8000 with 3000, 3300 lb Springs and 5000, 5500, 6000, 7000 lb Axles                      | D7HT-18045-GA | OIO | 83308 | ...   |     | ...   | ...   |
| 76 - 79 | LN-600, LN-650, LN-700, LN-800  | D7HT-18045-BA | OIO | 83312 | 89409 |     | ...   | ...   |
| 70 - 89 | LN-600, LN-700, LN-7000, LN-800, LN-8000, LNT-800, LNT-8000 with 4400 lb Spring and 7000, 9000 lb Axles   | D2EF-18045-AA | OIO | 83312 | 89409 |     | ...   | ...   |
| 80 - 89 | LN-600, LN-700, LN-750 with 11000, 13000, 15000, 17000 lb Axles   | D7HT-18080-BA |     | ...   | ...   | OIO | 83225 | ...   |
| 70 - 75 | LN-700, LN-750 Diesel with 9000 lb Axle   | C1TT-18045-C  | OIO | 83312 | 89409 |     | ...   | ...   |
| 94 - 97 | LN-7000, LN-8000, LN-9000, LNT-8000 or LNT-9000 Models with 21000 or 23000 lb. with 46" Taperleaf Spring  | F4HT-18080-BA |     | ...   | ...   | OIO | 85001 | 89410 |
| 91 - 97 | LN-7000, LN-8000, LN-9000, LNT-8000 or LNT-9000 Models with 4000, 4500, 5400, 6000 or 7200 lb. Multileaf Springs and with 9000, 10000, 12000 or 16000 lb. Axles | F1HT-18045-CB | OIO | 83216 | ...   |     | ...   | ...   |
| 90 - 97 | LN-7000, LN-8000, LN-9000, LNT-8000, LNT-9000 with 52" Taperleaf Spring   | F1HT-18045-GA | OIO | 85006 | 89401 |     | ...   | ...   |
|         |   | F1HT-18045-GB | OIO | 85006 | 89401 |     | ...   | ...   |
| 90 - 97 | LN-7000, LN-8000, LN-9000, LNT-8000, LNT-9000 with 58" Parabolic Taperleaf Spring   | F1HT-18045-RA | OIO | ...   | 89402 |     | ...   | ...   |

## APPLICATION GUIDE - TRUCKS, TRAILERS, AND BUSES

| Year<br>Año<br>Année | Model<br>Modelo<br>Modèle | OEM # | Front  |  | Rear  |   |
|----------------------|---------------------------|-------|--|--|---|---|
|                      |                           |       |  |  |  |  |
|                      |                           |       |   |   |  |  |
|                      |                           |       | Fleetline  | GasSLX   | Fleetline   | GasSLX  |

### FORD(Cont'd.)

#### LN & LNT - Conventional Cab(Cont'd.)

|         |   |                               |     |       |       |     |       |       |
|---------|---|-------------------------------|-----|-------|-------|-----|-------|-------|
| 90 - 97 | LN-7000, LN-8000, LN-9000, LNT-8000, LNT-9000 with 58" Parabolic Taperleaf Spring   | F1HT-18045-RB                 | OIO | ...   | 89402 | OIO | ...   | ...   |
|         | LN-7000, LN-8000, LN-9000, LNT-8000, LNT-9000 with Hendrickson Rear Air Suspension  | 47902-13                      |     | ...   | ...   | OIO | 83122 | 89406 |
|         |   | F0HT-18080-AA<br>F0HZ-18125-A |     | ...   | ...   | OIO | 83122 | 89406 |
| 90 - 97 | LN-7000, LN-8000, LN-9000, LNT-8000, LNT-9000 with Multileaf Spring   | F1HT-18045-DA                 | OIO | 83312 | 89409 |     | ...   | ...   |
| 91 - 97 | LN-7000, LN-8000, LN-9000, LNT-8000, LNT-9000 with 4500, 5400, 6000, 7200, 10000 lb Springs and with 10000, 12000, 13200, 16000 lb Axles      | F1HT-18045-DB                 | OIO | 83308 | ...   |     | ...   | ...   |
| 76 - 77 | LN-800, LN-8000, LN-900, LN-9000, LNT-800, LNT-8000, LNT-900, LNT-9000  | D2KF-18045-AA                 | OIO | 83312 | 89409 |     | ...   | ...   |
| 76 - 81 | LN-800, LN-8000, LN-900, LN-9000, LNT-800, LNT-8000, LNT-900, LNT-9000  | D2HF-18045-AA                 | OIO | 83314 | ...   |     | ...   | ...   |
|         |   | D7HT-18045-CA                 | OIO | 83314 | ...   |     | ...   | ...   |
| 70 - 71 | LN-800, LN-850, LNT-900, with 7000, 9000, 12000 lb Axles  | D2TF-18045-GA                 | OIO | 83308 | ...   |     | ...   | ...   |
| 70 - 89 | LN-800, LN-850, LN-8000, LN-900, LN-9000, LNT-800, LNT-850, LNT-880, LNT-8000, LNT-900, LNT-9000 with 6000, 7000, 9000, 12000, 16000 lb Axles | D2HF-18045-BA                 | OIO | 83309 | 89446 |     | ...   | ...   |
|         |   | D7HT-18045-DA                 | OIO | 83309 | 89446 |     | ...   | ...   |









#### Louisville Series - Conventional Cab

|         |   |               |     |       |       |     |       |       |
|---------|---|---------------|-----|-------|-------|-----|-------|-------|
| 96 - 97 | All Models with 10000 lb or 12000 lb Axle and 54" Taperleaf Spring    | F6HT-18045-AC | OIO | 85054 | 89438 |     | ...   | ...   |
|         |   | F6HZ-18124-A  | OIO | 85054 | 89438 |     | ...   | ...   |
|         |   | F6HZ-18124-G  | OIO | 85054 | 89438 |     | ...   | ...   |
| 96 - 97 | All with 12000 lb, 13000 lb or 14600 lb Axle and 60" Taperleaf Spring | F6HT-18045-EB | OIO | 85055 | 89439 |     | ...   | ...   |
|         |   | F6HT-18045-EC | OIO | 85055 | 89439 |     | ...   | ...   |
|         |   | F6HZ-18124-D  | OIO | 85055 | 89439 |     | ...   | ...   |
|         |   | F6HZ-18124-E  | OIO | 85055 | 89439 |     | ...   | ...   |
|         |   | F6HZ-18124-F  | OIO | 85055 | 89439 |     | ...   | ...   |
| 1996 -  | All with 13200 lb or 14600 lb Axle and 54" Taperleaf Spring           | F6HT-18045-GB | OIO | 85030 | 89440 |     | ...   | ...   |
|         |   | F6HT-18045-GC | OIO | 85030 | 89440 |     | ...   | ...   |
| 1996 -  | All with 54" Multi-leaf Spring and 14600 or 16000 lb Axle             | F6HT-18045-CC | OIO | 85055 | 89439 |     | ...   | ...   |
|         |   | F6HZ-18124-C  | OIO | 85055 | 89439 |     | ...   | ...   |
|         | All with 54" Multileaf Spring and with 12000 or 13200 lb Axle         | F6HT-18045-BC | OIO | 85047 | 89435 |     | ...   | ...   |
| 96 - 97 | All with 54" Multileaf Spring and with 8500 or 9000 lb Axle           | F6HT-18045-JB | OIO | 83200 | 89402 |     | ...   | ...   |
|         |   | F6HT-18045-JC | OIO | 83200 | 89402 |     | ...   | ...   |
|         |   | F6HZ-18124-J  | OIO | 83200 | 89402 |     | ...   | ...   |
| 96 - 97 | All with 8500 lb or 9000 lb Axle with 54" Taperleaf Spring            | F6HT-18045-HB | OIO | 85054 | 89438 |     | ...   | ...   |
|         |   | F6HT-18045-HC | OIO | 85054 | 89438 |     | ...   | ...   |
|         |   | F6HZ-18124-H  | OIO | 85054 | 89438 |     | ...   | ...   |
|         | All with Hendrickson HAS-400 Air Suspension                           | 47902-28      |     | ...   | ...   | OIO | 85013 | 89414 |
|         |   | F6HZ-18080-FC |     | ...   | ...   | OIO | 85013 | 89414 |
|         |   | F6HZ-18125-D  |     | ...   | ...   | OIO | 85013 | 89414 |
|         | All with Neway AD-123 Air Suspension                                  | 90045068      |     | ...   | ...   | -IO | ...   | 89441 |
|         |   | F6HZ-18125-C  |     | ...   | ...   | -IO | ...   | 89441 |
|         | All with Neway AD-246 Air Suspension                                  | 90045099      |     | ...   | ...   | OIO | 85906 | 89407 |
|         |   | 90045132      |     | ...   | ...   | OIO | 85909 | ...   |

#### Motorhome Chassis

|         |   |               |     |       |       |  |     |     |
|---------|---|---------------|-----|-------|-------|--|-----|-----|
| 99 - 19 | F53 Motorhome Chassis with 16,000 lb GVW to 22,000 lb GVW | 1C34-18045-AA | OIO | 83209 | 89414 |  | ... | ... |
|         |   | 1C34-18045-JA | OIO | 83209 | 89414 |  | ... | ... |
|         |   | 9U94-18045-AA | OIO | 83209 | 89414 |  | ... | ... |
|         |   | 9U9Z-18124-A  | OIO | 83209 | 89414 |  | ... | ... |
|         |   | ASH-1022      | OIO | 83209 | 89414 |  | ... | ... |
|         |   | ASH-1205      | OIO | 83209 | 89414 |  | ... | ... |
|         |   | ASH-1228      | OIO | 83209 | 89414 |  | ... | ... |

**APPLICATION GUIDE - TRUCKS, TRAILERS, AND BUSES**

| Year<br>Año<br>Année | Model<br>Modelo<br>Modèle | OEM # | Front   |   | Rear  |   |
|----------------------|---------------------------|-------|---|---|---|---|
|                      |                           |       |  |  |  |  |
|                      |                           |       |  |  |  |  |
|                      |                           |       | Fleetline   | GasSLX  | Fleetline   | GasSLX  |

**FORD(Cont'd.)**

**Motorhome Chassis(Cont'd.)**

|         |   |               |     |       |       |     |       |       |
|---------|---|---------------|-----|-------|-------|-----|-------|-------|
| 99 - 19 | F53 Motorhome Chassis with 16,000 lb GVW to 22,000 lb GVW | ASH-1229      | 010 | 83209 | 89414 |     | ...   | ...   |
|         |   | ASH-25822     | 010 | 83209 | 89414 |     | ...   | ...   |
|         |   | ASH-25823     | 010 | 83209 | 89414 |     | ...   | ...   |
|         |   | ASH-294       | 010 | 83209 | 89414 |     | ...   | ...   |
|         |   | AT-620        | 010 | 83209 | 89414 |     | ...   | ...   |
|         |   | AT-766        | 010 | 83209 | 89414 |     | ...   | ...   |
| 99 - 19 | F53 Motorhome Chassis with 20,500 lb GVW to 22,000 lb GVW | 9U94-18080-AA |     | ...   | ...   | 010 | 83122 | 89406 |
|         |   | 9U9Z-18125-A  |     | ...   | ...   | 010 | 83122 | 89406 |
|         |   | ASH-1023      |     | ...   | ...   | 010 | 83122 | 89406 |
|         |   | ASH-1206      |     | ...   | ...   | 010 | 83122 | 89406 |
|         |   | ASH-1230      |     | ...   | ...   | 010 | 83122 | 89406 |
|         |   | ASH-137       |     | ...   | ...   | 010 | 83122 | 89406 |
|         |   | ASH-25824     |     | ...   | ...   | 010 | 83122 | 89406 |
|         |   | AT-621        |     | ...   | ...   | 010 | 83122 | 89406 |
| 73 - 76 | M-400 & M-500 Motorhome Chassis                           | .....         | 010 | 85012 | 89413 | 010 | 83225 | ...   |
| 57 - 76 | P-400 & 4000 Motorhome Chassis with H.D. Springs          | .....         | 010 | 85012 | 89413 |     | ...   | ...   |

**N and NT 89" BBC Conventional Cab**

|         |   |               |     |        |       |     |       |     |
|---------|---|---------------|-----|--------|-------|-----|-------|-----|
| 64 - 69 | M-750, N-800, N-850, N-900, N-950 with 6000, 7000, 9000, 11000, 12000 lb Axles  | C1TT-18045-C  | 010 | 83312  | 89409 |     | ...   | ... |
| 64 - 69 | N-1100 with 11000 thru 15000 lb Axles   | C6PF-18077-DN | 010 | 83314  | ...   |     | ...   | ... |
| 64 - 69 | N-500, N-550, N-600, N-650, N-700 with 5000, 6000, 7000 & 9000 lb Axles   | D2TF-18045-GA | 010 | 83308  | ...   |     | ...   | ... |
| 64 - 69 | N-500, N-550, N-600, N-650, N-700, N-750  | C7PF-18077-A  |     | ...    | ...   | 010 | 83225 | ... |
|         |   | D2TF-18080-HA |     | ...    | ...   | 010 | 83225 | ... |
| 64 - 69 | N-600, N-650, N-700, N-750, N-800, N-850, N-900, N-950 with 6000, 7000, 9000, 11000, 12000 lb Axles                     | C6PF-18077-DL | 010 | 83312  | 89409 |     | ...   | ... |
| 67 - 69 | N-850, N-900, N-950, N-1000, NT-850, NT-900, NT-950, NT-1000 with 6000, 7000, 9000, 11000, 12000, 15000, 18000 lb Axles | C1TT-18045-D  | 010 | G63406 | ...   |     | ...   | ... |

**P-Series - Parcel Delivery**

|         |                               |               |     |       |       |     |       |     |
|---------|-------------------------------|---------------|-----|-------|-------|-----|-------|-----|
| 57 - 76 | P-400 & 4000 w/ H. D. Springs | .....         | 010 | 85012 | 89413 |     | ...   | ... |
| 57 - 76 | P500, P-5000                  | .....         | 010 | 85012 | 89413 | 010 | 83225 | ... |
| 78 - 79 | P-600                         | D7HT-18045-HA | 010 | 85012 | 89413 |     | ...   | ... |
|         |                               | D7HT-18080-CA |     | ...   | ...   | 010 | 83225 | ... |

**T-Series - Conventional Tandem**

|         |  |               |     |        |     |  |     |     |
|---------|--|---------------|-----|--------|-----|--|-----|-----|
| 64 - 69 | T-750, T-800, T-850, T-900, T-950 with 6000, 7000, 9000, 11000, 12000, 15000, 18000 lb Axles | C1TT-18045-D  | 010 | G63406 | ... |  | ... | ... |
| 64 - 69 | T-750, T-800, T-850, T-900, T-950 with 9000 thru 15000 lb Axles                              | C1TT-18045-E  | 010 | 83314  | ... |  | ... | ... |
|         |  | C6PF-18077-DN | 010 | 83314  | ... |  | ... | ... |





**W and WT Series - Hi Tilt Cab Highway Tractor**

|         |  |                |     |       |     |     |       |       |
|---------|--|----------------|-----|-------|-----|-----|-------|-------|
| 66 - 71 | W-900, W-950, W-1000, WT-900, WT-950, WT-1000 with 11000 lb Axle         | D2HA-18045-E1A | 010 | 85304 | ... |     | ...   | ...   |
|         |  | D2HA-18045-E1B | 010 | 85304 | ... |     | ...   | ...   |
|         |  | D2HA-18045-E2A | 010 | 85304 | ... |     | ...   | ...   |
|         |  | D2HA-18045-E2B | 010 | 85304 | ... |     | ...   | ...   |
| 66 - 77 | W-900, W-950, W-1000, WT-900, WT-950, WT-1000 with 12000 & 15000 lb Axle | C6TA-18045-Y   | 010 | 85301 | ... |     | ...   | ...   |
|         |  | C6TA-18045-Z   | 010 | 85301 | ... |     | ...   | ...   |
| 73 - 77 | W-900, WT-900 with Air Suspension  | D2HZ-18080-A   |     | ...   | ... | 010 | 83209 | 89414 |
|         |  | D4HA-18080-AA  |     | ...   | ... | 010 | 83209 | 89414 |

**Additional O.E.M. Interchanges**

|  |   |                |     |       |     |     |        |     |
|--|---|----------------|-----|-------|-----|-----|--------|-----|
|  | HN-80 with 21000 lb or 23000 lb Axle & 52" Taper leaf Rear Suspension | F6HT-18080-JA  |     | ...   | ... | 010 | 85305  | ... |
|  | Models with O.E.M. Number   | 0017LA-18080-G |     | ...   | ... | -10 | 83161  | ... |
|  |   | 2C4Z-18124-BA  | 010 | 83175 | ... |     | ...    | ... |
|  |   | 2C7Z-18125-AA  |     | ...   | ... | 010 | G63837 | ... |
|  |   | 2C7Z-18125-CA  |     | ...   | ... | 010 | G63607 | ... |

**APPLICATION GUIDE - TRUCKS, TRAILERS, AND BUSES**





| Year<br>Año<br>Année | Model<br>Modelo<br>Modèle | OEM # | Front  |   | Rear      |        |
|----------------------|---------------------------|-------|--|---|-----------|--------|
|                      |                           |       |  |  |           |        |
|                      |                           |       |   |  | Fleetline | GasSLX |

**FORD(Cont'd.)**

**Additional O.E.M. Interchanges(Cont'd.)**

| Models with O.E.M. Number |     |        |       |     |        |       |
|---------------------------|-----|--------|-------|-----|--------|-------|
| 3U2Z-18124-BAA            | 010 | G63809 | ...   |     | ...    | ...   |
| 3U2Z-18124-BV             | -10 | G63614 | ...   |     | ...    | ...   |
| 3U2Z-18124-BW             | -10 | G63614 | ...   |     | ...    | ...   |
| 3U2Z-18124-EA             | -10 | G63772 | ...   |     | ...    | ...   |
| 3U2Z-18124-FA             | -10 | G63608 | ...   |     | ...    | ...   |
| 3U2Z-18124-FAA            | -10 | G63809 | ...   |     | ...    | ...   |
| 3U2Z-18124-JAA            | -10 | G63614 | ...   |     | ...    | ...   |
| 3U2Z-18124-YAA            | 010 | G63809 | ...   |     | ...    | ...   |
| 3U2Z-18125-AD             |     | ...    | ...   | -10 | 69575  | ...   |
| 3U2Z-18125-CA             |     | ...    | ...   | 010 | G63607 | ...   |
| 3U2Z-18125-DA             |     | ...    | ...   | 010 | G63525 | ...   |
| 3U2Z-18125-EA             |     | ...    | ...   | 010 | G63524 | ...   |
| 3U2Z-18125-RA             |     | ...    | ...   | -10 | G63623 | ...   |
| 47902-8                   |     | ...    | ...   | 010 | 83122  | 89406 |
| 4U2Z-18V124-AA            | -10 | G63678 | ...   |     | ...    | ...   |
| 57365-111                 | 010 | 85006  | 89401 |     | ...    | ...   |
| 5C3Z-18124-JA             | -10 | G63969 | ...   |     | ...    | ...   |
| 5C3Z-18125-CF             |     | ...    | ...   | 010 | 77969  | ...   |
| 5C3Z-18125-DA             |     | ...    | ...   | 010 | 77968  | ...   |
| 5U2Z-18V124-AA            | -10 | G63714 | ...   |     | ...    | ...   |
| 5U2Z-18V124-AHA           | 01- | G63622 | ...   |     | ...    | ...   |
| 5U2Z-18V124-AU            | -10 | G63772 | ...   |     | ...    | ...   |
| 5U2Z-18V124-BA            | -10 | G63716 | ...   |     | ...    | ...   |
| 5U2Z-18V124-CAA           | 010 | G63809 | ...   |     | ...    | ...   |
| 5U2Z-18V124-DB            | 010 | G63455 | ...   |     | ...    | ...   |
| 5U2Z-18V124-GA            | -10 | G63809 | ...   |     | ...    | ...   |
| 5U2Z-18V124-LA            | -10 | G63929 | ...   |     | ...    | ...   |
| 5U2Z-18V125-AE            |     | ...    | ...   | 010 | G63808 | ...   |
| 5U2Z-18V125-AF            |     | ...    | ...   | 010 | G63810 | ...   |
| 5U2Z-18V125-BDA           |     | ...    | ...   | -10 | G63623 | ...   |
| 5U2Z-18V125-BGA           |     | ...    | ...   | -10 | G63778 | ...   |
| 5U2Z-18V125-BS            |     | ...    | ...   | 010 | G63607 | ...   |
| 5U2Z-18V125-BT            |     | ...    | ...   | 010 | G63525 | ...   |
| 5U2Z-18V125-BU            |     | ...    | ...   | 010 | G63524 | ...   |
| 5U2Z-18V125-F             |     | ...    | ...   | 010 | G63676 | ...   |
| 5U2Z-18V125-G             |     | ...    | ...   | 010 | G63837 | ...   |
| 5U2Z-18V125-H             |     | ...    | ...   | 010 | G63406 | ...   |
| 6C2Z-18124-B              | -10 | G63929 | ...   |     | ...    | ...   |
| 6ETZ-18124-AA             | 010 | 83145  | ...   |     | ...    | ...   |
| 6ETZ-18125-A              |     | ...    | ...   | 010 | 83146  | ...   |
| 6U2Z18V125A               |     | ...    | ...   | 010 | G63837 | ...   |
| 6U2Z-18V125-B             |     | ...    | ...   | 010 | G63607 | ...   |
| 70127                     | 010 | 85006  | 89401 |     | ...    | ...   |
| 70128                     | 010 | 85006  | 89401 |     | ...    | ...   |
| 7C34-18045-HB             | -10 | G63969 | ...   |     | ...    | ...   |
| 7C34-18080-DCB            |     | ...    | ...   | 010 | 77968  | ...   |
| 7W7Z-18125-B              |     | ...    | ...   | -10 | 69574  | ...   |
| 90044769                  |     | ...    | ...   | 010 | 83207  | 89407 |
| 90044770                  |     | ...    | ...   | 010 | 83207  | 89407 |
| AX-267A                   | 010 | 83309  | 89446 |     | ...    | ...   |
| B3Q-18124-A               | 010 | 83219  | ...   |     | ...    | ...   |
| B3Q-18125-A               |     | ...    | ...   | 010 | 83217  | ...   |
| B3TZ-18125-A              |     | ...    | ...   | 010 | 83217  | ...   |
| B6TZ-18124-A              | 010 | 83219  | ...   |     | ...    | ...   |
| B6TZ-18125-B              |     | ...    | ...   | -10 | 83161  | ...   |

**APPLICATION GUIDE - TRUCKS, TRAILERS, AND BUSES**





| Year<br>Año<br>Année | Model<br>Modelo<br>Modèle | OEM # | Front   |   | Rear  |   |
|----------------------|---------------------------|-------|---|---|---|---|
|                      |                           |       |  |  |  |  |
|                      |                           |       | Fleetline   | GasSLX  | Fleetline   | GasSLX  |

**FORD(Cont'd.)**

**Additional O.E.M. Interchanges(Cont'd.)**

| Models with O.E.M. Number |     |       |       |       |     |  |
|---------------------------|-----|-------|-------|-------|-----|--|
| B6TZ-18125-C              | ... | ...   | -10   | 83161 | ... |  |
| B6TZ-18125-E              | ... | ...   | -10   | 83161 | ... |  |
| B7C-18125-A               | ... | ...   | 010   | 83217 | ... |  |
| B7T-18124-C               | 010 | 83225 | ...   | ...   | ... |  |
| B7TZ-18124-B              | 010 | 83216 | ...   | ...   | ... |  |
| B7TZ-18124-C              | 010 | 83216 | ...   | ...   | ... |  |
| B7TZ-18124-D              | 010 | 83219 | ...   | ...   | ... |  |
| B7TZ-18124-E              | 010 | 83217 | ...   | ...   | ... |  |
| B7TZ-18125-C              | ... | ...   | 010   | 83217 | ... |  |
| B8Q-18125-A               | ... | ...   | 010   | 85307 | ... |  |
| B8QZ-18124-A              | 010 | 83312 | 89409 | ...   | ... |  |
| B8TZ-18124-A              | 010 | 83219 | ...   | ...   | ... |  |
| B9TT-18045-C              | 010 | 83219 | ...   | ...   | ... |  |
| B9TT-18045-D              | 010 | 83219 | ...   | ...   | ... |  |
| B9TT-18080-B              | ... | ...   | -10   | 83161 | ... |  |
| B9TZ-18125-B              | ... | ...   | -10   | 83161 | ... |  |
| C0TT-18045-A              | 010 | 83219 | ...   | ...   | ... |  |
| C0TT-18045-D              | 010 | 83216 | ...   | ...   | ... |  |
| C0TZ-18124-A              | 010 | 83216 | ...   | ...   | ... |  |
| C1TT-18045-G              | 010 | 83216 | ...   | ...   | ... |  |
| C1TT-18080-B              | ... | ...   | 010   | 83217 | ... |  |
| C1TZ-18045-C              | 010 | 83312 | 89409 | ...   | ... |  |
| C1TZ-18124-A              | 010 | 83217 | ...   | ...   | ... |  |
| C1TZ-18124-B              | 010 | 83216 | ...   | ...   | ... |  |
| C1TZ-18124-C              | 010 | 83312 | 89409 | ...   | ... |  |
| C1TZ-18124-D              | 010 | 83309 | 89446 | ...   | ... |  |
| C1TZ-18124-E              | 010 | 83312 | 89409 | ...   | ... |  |
| C1TZ-18124-F              | 010 | 83312 | 89409 | ...   | ... |  |
| C1TZ-18124-N              | 010 | 83314 | ...   | ...   | ... |  |
| C1TZ-18124-P              | 010 | 83312 | 89409 | ...   | ... |  |
| C1TZ-18125-B              | ... | ...   | 010   | 83217 | ... |  |
| C1VT-18080-B              | ... | ...   | 010   | 83217 | ... |  |
| C2TA-18045-B              | 010 | 83308 | ...   | ...   | ... |  |
| C2TZ-18124-A              | 010 | 83308 | ...   | ...   | ... |  |
| C3TA-18045-A              | 010 | 83216 | ...   | ...   | ... |  |
| C3TZ-18124-A              | 010 | 83308 | ...   | ...   | ... |  |
| C4HZ-18124-A              | 010 | 83312 | 89409 | ...   | ... |  |
| C4HZ-18124-B              | 010 | 83309 | 89446 | ...   | ... |  |
| C4HZ-18124-C              | 010 | 83314 | ...   | ...   | ... |  |
| C4HZ-18124-D              | 010 | 83312 | 89409 | ...   | ... |  |
| C4HZ-18124-F              | 010 | 83308 | ...   | ...   | ... |  |
| C4PF-18045-H              | 010 | 83216 | ...   | ...   | ... |  |
| C4TZ-18124-AA             | 010 | 83308 | ...   | ...   | ... |  |
| C4TZ-18124-AB             | 010 | 83308 | ...   | ...   | ... |  |
| C4TZ-18124-B              | 010 | 83308 | ...   | ...   | ... |  |
| C5TZ-18124-A              | 010 | 83308 | ...   | ...   | ... |  |
| C6PF-18077-AC             | ... | ...   | -10   | 83161 | ... |  |
| C6TA-18045-U              | 010 | 85301 | ...   | ...   | ... |  |
| C6TA-18045-V              | 010 | 85301 | ...   | ...   | ... |  |
| C6TS-18080-A              | ... | ...   | 010   | 83217 | ... |  |
| C6TZ-18124-D              | 010 | 85301 | ...   | ...   | ... |  |
| C6TZ-18124-E              | 010 | 85301 | ...   | ...   | ... |  |
| C6TZ-18124-H              | 010 | 85301 | ...   | ...   | ... |  |
| C6TZ-18124-J              | 010 | 85301 | ...   | ...   | ... |  |
| C7HZ-18124-A              | 010 | 83312 | 89409 | ...   | ... |  |

## APPLICATION GUIDE - TRUCKS, TRAILERS, AND BUSES

| Year<br>Año<br>Année | Model<br>Modelo<br>Modèle | OEM # | Front  |   | Rear   |   |
|----------------------|---------------------------|-------|--|---|--|---|
|                      |                           |       |  |  |  |  |
|                      |                           |       | Fleetline  | GasSLX  | Fleetline  | GasSLX  |





### FORD(Cont'd.)

#### Additional O.E.M. Interchanges(Cont'd.)

| Year | Model                     | OEM #          | Front     | Rear   | Front     | Rear   |
|------|---------------------------|----------------|-----------|--------|-----------|--------|
| Year | Model                     | OEM #          | Fleetline | GasSLX | Fleetline | GasSLX |
|      | Models with O.E.M. Number | C7TA-18045-R   | 010       | 83216  | ...       | ...    |
|      |                           | C7TA-18045-Z   | 010       | 85301  | ...       | ...    |
|      |                           | C8PF-18045-CM  | 010       | 83216  | ...       | ...    |
|      |                           | C8PF-18045-S   | -10       | 83161  | ...       | ...    |
|      |                           | C8PF-18045-T   | -10       | 83161  | ...       | ...    |
|      |                           | C8TA-18080-Y   |           | ...    | -10       | 83161  |
|      |                           | C8TA-18080-Z   |           | ...    | -10       | 83161  |
|      |                           | C8TZ-18125-D   |           | ...    | -10       | 83161  |
|      |                           | D0HA-18045-D   | 010       | 83309  | 89446     | ...    |
|      |                           | D0HZ-18124-A   | 010       | 83309  | 89446     | ...    |
|      |                           | D0HZ-18124-B   | 010       | 83312  | 89409     | ...    |
|      |                           | D0HZ-18124-C   | 010       | 83314  | ...       | ...    |
|      |                           | D1TZ-18124-D   | 010       | 83308  | ...       | ...    |
|      |                           | D1TZ-18124-E   | 010       | 83216  | ...       | ...    |
|      |                           | D1TZ-18124-F   | 010       | 83312  | 89409     | ...    |
|      |                           | D1TZ-18125-E   |           | ...    | 010       | 83217  |
|      |                           | D2EF-18124-AA  | 010       | 83312  | 89409     | ...    |
|      |                           | D2HA-18045-EB  | 010       | 85301  | ...       | ...    |
|      |                           | D2HA-18045-F1A | 010       | 85301  | ...       | ...    |
|      |                           | D2HA-18045-F1B | 010       | 85301  | ...       | ...    |
|      |                           | D2HA-18045-F2A | 010       | 85301  | ...       | ...    |
|      |                           | D2HA-18045-F2B | 010       | 85301  | ...       | ...    |
|      |                           | D2HF-18045-A   | 010       | 83314  | ...       | ...    |
|      |                           | D2HF-18124-AA  | 010       | 83314  | ...       | ...    |
|      |                           | D2HT-18045-EA  | 010       | 83312  | 89409     | ...    |
|      |                           | D2HZ-18125-A   |           | ...    | 010       | 83209  |
|      |                           | D2HZ-18125-B   |           | ...    | 010       | 83209  |
|      |                           | D2KF-18124-AA  | 010       | 83312  | 89409     | ...    |
|      |                           | D2TA-18045-AAA | 010       | 83219  | ...       | ...    |
|      |                           | D2TA-18045-ZA  | 010       | 83219  | ...       | ...    |
|      |                           | D2TF-18045-FA  | 010       | 83312  | 89409     | ...    |
|      |                           | D2TF-18080-NA  |           | ...    | 010       | 83217  |
|      |                           | D2TF-18124-F   | 010       | 83309  | 89446     | ...    |
|      |                           | D2TZ-18124-A   | 010       | 83308  | ...       | ...    |
|      |                           | D2TZ-18124-E   | 010       | 83312  | 89409     | ...    |
|      |                           | D2TZ-18124-F   | 010       | 83309  | 89446     | ...    |
|      |                           | D2TZ-18124-G   | 010       | 83314  | ...       | ...    |
|      |                           | D2TZ-18124-H   | 010       | 83308  | ...       | ...    |
|      |                           | D2TZ-18124-J   | 010       | 83312  | 89409     | ...    |
|      |                           | D3TA-18045-BA  | 010       | 83219  | ...       | ...    |
|      |                           | D3TZ-18124-B   | 010       | 83219  | ...       | ...    |
|      |                           | D3TZ-18125-C   |           | ...    | 010       | 83217  |
|      |                           | D3TZ-18125-D   |           | ...    | 010       | 83217  |
|      |                           | D4HA-18080-A   |           | ...    | 010       | 83209  |
|      |                           | D4TF-18045-AA  | 010       | 83312  | 89409     | ...    |
|      |                           | D4TZ-18124-J   | 010       | 83308  | ...       | ...    |
|      |                           | D5TZ-18124-B   | 010       | 83308  | ...       | ...    |
|      |                           | D5TZ-18124-C   | 010       | 83312  | 89409     | ...    |
|      |                           | D7HF-18125-AA  |           | ...    | 010       | 83215  |
|      |                           | D7HT-18124-BA  | 010       | 83312  | 89409     | ...    |
|      |                           | D7HT-18124-CA  | 010       | 83314  | ...       | ...    |
|      |                           | D7HT-18124-DA  | 010       | 83309  | 89446     | ...    |
|      |                           | D7HT-18124-EA  | 010       | 83312  | 89409     | ...    |
|      |                           | D7HT-18124-FA  | 010       | 83312  | 89409     | ...    |
|      |                           | D7HT-18124-GA  | 010       | 83308  | ...       | ...    |



**APPLICATION GUIDE - TRUCKS, TRAILERS, AND BUSES**





| Year<br>Año<br>Année | Model<br>Modelo<br>Modèle | OEM # | Front   |   | Rear  |   |
|----------------------|---------------------------|-------|---|---|---|---|
|                      |                           |       |  |  |  |  |
|                      |                           |       | Fleetline   | GasSLX  | Fleetline   | GasSLX  |

**FORD(Cont'd.)**

**Additional O.E.M. Interchanges(Cont'd.)**

| Models with O.E.M. Number |     |        |       |     |        |       |  |
|---------------------------|-----|--------|-------|-----|--------|-------|--|
| D7HT-18124-HA             | 010 | 83219  | ...   |     | ...    | ...   |  |
| D7HT-18124-JA             | 010 | 83308  | ...   |     | ...    | ...   |  |
| D7HT-18124-KA             | 010 | 85301  | ...   |     | ...    | ...   |  |
| D7HT-18125-BA             |     | ...    | ...   | 010 | 83217  | ...   |  |
| D7HT-18125-CA             |     | ...    | ...   | 010 | 83217  | ...   |  |
| D7HT-18125-DA             |     | ...    | ...   | 010 | 83215  | ...   |  |
| D7HT-18125-FA             |     | ...    | ...   | 010 | 83123  | 89405 |  |
| D7HZ-18125-A              |     | ...    | ...   | 010 | 83215  | ...   |  |
| D7TA-18124-GA             | 010 | 83314  | ...   |     | ...    | ...   |  |
| D7TZ-18125-C              |     | ...    | ...   | 010 | 83217  | ...   |  |
| D8HZ-18124-A              | 010 | 85301  | ...   |     | ...    | ...   |  |
| D8HZ-18125-A              |     | ...    | ...   | 010 | 83209  | 89414 |  |
| D8HZ-18125-B              |     | ...    | ...   | 010 | 83123  | 89405 |  |
| E0HZ-18124-A              | 010 | 83309  | 89446 |     | ...    | ...   |  |
| E1TA-18045-AA             | 010 | 83309  | 89446 |     | ...    | ...   |  |
| E1TD-18045-AA             | 010 | 83309  | 89446 |     | ...    | ...   |  |
| E5HT-18045-DA             | 010 | 85301  | ...   |     | ...    | ...   |  |
| E5HT-18045-EA             | 010 | 85301  | ...   |     | ...    | ...   |  |
| E6HZ-18124-D              | 010 | 85301  | ...   |     | ...    | ...   |  |
| E6HZ-18125-E              |     | ...    | ...   | 010 | 85315  | ...   |  |
| E6HZ-18125-F              |     | ...    | ...   | 010 | 85315  | ...   |  |
| E7XZ-18124-A              | -10 | G63386 | ...   |     | ...    | ...   |  |
| E7XZ-18124-B              | -10 | G63500 | ...   |     | ...    | ...   |  |
| E7XZ-18124-C              | -10 | G63511 | ...   |     | ...    | ...   |  |
| E7XZ-18124-D              | -10 | G63396 | ...   |     | ...    | ...   |  |
| E7XZ-18124-F              | -1- | G63398 | ...   |     | ...    | ...   |  |
| E7XZ-18124-G              | -1- | G63398 | ...   |     | ...    | ...   |  |
| E7XZ-18125-A              |     | ...    | ...   | -10 | G63350 | ...   |  |
| E7XZ-18125-B              |     | ...    | ...   | -10 | G63387 | ...   |  |
| E7XZ-18125-C              |     | ...    | ...   | 010 | G63409 | ...   |  |
| E7XZ-18125-D              |     | ...    | ...   | 010 | G63406 | ...   |  |
| E7XZ-18125-E              |     | ...    | ...   | 010 | G63406 | ...   |  |
| E7XZ-18125-G              |     | ...    | ...   | 010 | G63811 | ...   |  |
| E7XZ-18125-J              |     | ...    | ...   | 010 | G63299 | ...   |  |
| E9HZ-18125-A              |     | ...    | ...   | 010 | 85716  | ...   |  |
| E9HZ-18125-AA             |     | ...    | ...   | 010 | 85716  | ...   |  |
| F0HS-18045-AA             | 010 | 85006  | 89401 |     | ...    | ...   |  |
| F0HT-18045-AA             | 010 | 85006  | 89401 |     | ...    | ...   |  |
| F0HZ-18124-A              | 010 | 85006  | 89401 |     | ...    | ...   |  |
| F0HZ-18124-B              | 010 | 85006  | ...   |     | ...    | ...   |  |
| F1HT-18045-KB             | 010 | 85006  | 89401 |     | ...    | ...   |  |
| F1HT-18045-LB             | 010 | 85006  | 89401 |     | ...    | ...   |  |
| F1HZ-18124-AA             | 010 | 83309  | 89446 |     | ...    | ...   |  |
| F1HZ-18124-B              | 010 | 83308  | ...   |     | ...    | ...   |  |
| F1HZ-18124-C              | 010 | ...    | 89402 |     | ...    | ...   |  |
| F1HZ-18124-D              | 010 | 85006  | 89401 |     | ...    | ...   |  |
| F1HZ-18124-E              | 010 | 85006  | 89401 |     | ...    | ...   |  |
| F1HZ-18124-F              | 010 | 85006  | 89401 |     | ...    | ...   |  |
| F1HZ-18124-G              | 010 | 85006  | 89401 |     | ...    | ...   |  |
| F1HZ-18124-H              | 010 | 85040  | ...   |     | ...    | ...   |  |
| F1HZ-18124-J              | 010 | 83308  | ...   |     | ...    | ...   |  |
| F1HZ-18124-K              | 010 | ...    | 89402 |     | ...    | ...   |  |
| F2HT-18045-DA             | 010 | 85006  | 89401 |     | ...    | ...   |  |
| F2HT-18080-DA             |     | ...    | ...   | 010 | 85712  | ...   |  |
| F2HZ-18124-B              | 010 | 85301  | ...   |     | ...    | ...   |  |

**APPLICATION GUIDE - TRUCKS, TRAILERS, AND BUSES**









| Year<br>Año<br>Année | Model<br>Modelo<br>Modèle | OEM # | Front  |  | Rear  |  |
|----------------------|---------------------------|-------|--|--|---|--|
|                      |                           |       |  Fleetline |  GasSLX |  Fleetline |  GasSLX |

**FORD(Cont'd.)**

**Additional O.E.M. Interchanges(Cont'd.)**

| Models with O.E.M. Number |     |        |       |     |        |
|---------------------------|-----|--------|-------|-----|--------|
| F2HZ-18124-C              | 010 | 85006  | 89401 | ... | ...    |
| F2HZ-18125-A              |     | ...    | ...   | 010 | 85712  |
| F4TA-18045-TA             | 010 | G63455 | ...   | ... | ...    |
| F4TA-18080-PA             |     | ...    | ...   | 010 | G63461 |
| F4TZ-18124-D              | -10 | G63414 | ...   | ... | ...    |
| F4TZ-18124-K              | 010 | G63455 | ...   | ... | ...    |
| F4TZ-18125-E              |     | ...    | ...   | 010 | G63461 |
| F4TZ-18125-L              |     | ...    | ...   | 010 | G63406 |
| F57Z-18125-BB             |     | ...    | ...   | 010 | G63679 |
| F5HZ-18124-AA             | 010 | 83314  | ...   | ... | ...    |
| F5HZ-18124-C              | 010 | 85063  | ...   | ... | ...    |
| F5HZ-18124-DA             | 010 | 83125  | ...   | ... | ...    |
| F5HZ-18125-A              |     | ...    | ...   | 010 | 85314  |
| F5HZ-18125-AA             |     | ...    | ...   | 010 | 85314  |
| F5HZ-18125-B              |     | ...    | ...   | 010 | 85001  |
| F5HZ-18125-BA             |     | ...    | ...   | 010 | 85001  |
| F5TZ-18124-B              | -10 | G63608 | ...   | ... | ...    |
| F5TZ-18125-BC             |     | ...    | ...   | 010 | G63607 |
| F5UZ-18124-A              | 01- | G63622 | ...   | ... | ...    |
| F5UZ-18124-B              | 01- | G63622 | ...   | ... | ...    |
| F5UZ-18125-A              |     | ...    | ...   | -10 | G63623 |
| F5UZ-18125-C              |     | ...    | ...   | -10 | G63624 |
| F6HT-18045-KA             | 010 | 83200  | 89402 | ... | ...    |
| F6HT-18045-MA             | 010 | 85006  | 89401 | ... | ...    |
| F6HT-18080-CA             |     | ...    | ...   | 010 | 85314  |
| F6HT-18080-EA             |     | ...    | ...   | 010 | 85906  |
| F6HT-18080-FC             |     | ...    | ...   | 010 | 85013  |
| F6HZ-18124-B              | 010 | 83308  | ...   | ... | ...    |
| F6HZ-18124-KA             | 010 | 83200  | 89402 | ... | ...    |
| F6HZ-18124-MA             | 010 | 85006  | 89401 | ... | ...    |
| F6HZ-18125-A              |     | ...    | ...   | 010 | 85314  |
| F6HZ-18125-JA             |     | ...    | ...   | 010 | 85305  |
| F7C2Z-18124-BR            | -10 | G63929 | ...   | ... | ...    |
| F7TA-18045-AA             | -10 | G63608 | ...   | ... | ...    |
| F7TA-18080-BA             |     | ...    | ...   | 010 | G63607 |
| F81Z-18124-AL             | 01- | G63622 | ...   | ... | ...    |
| F81Z-18124-BK             | 010 | G63809 | ...   | ... | ...    |
| F81Z-18124-PA             | 010 | 85928  | ...   | ... | ...    |
| F87Z-18125-CA             |     | ...    | ...   | 010 | G63773 |
| F87Z-18125-RA             |     | ...    | ...   | 010 | G63775 |
| LA-18080                  |     | ...    | ...   | -10 | 83161  |
| LA-18080-A                |     | ...    | ...   | -10 | 83161  |
| LA-18080-B                |     | ...    | ...   | -10 | 83161  |
| LA-18080-C                |     | ...    | ...   | -10 | 83161  |
| LA-18080-F                |     | ...    | ...   | -10 | 83161  |
| LA-18080-J                |     | ...    | ...   | -10 | 83161  |
| TAAH-18080-A              |     | ...    | ...   | -10 | 83161  |
| TAAH-18080-A2             |     | ...    | ...   | -10 | 83161  |
| TAAH-18080-A3             |     | ...    | ...   | -10 | 83161  |
| TAAK-18080-A              |     | ...    | ...   | -10 | 83161  |
| TAAK-18080-A1             |     | ...    | ...   | -10 | 83161  |
| TAAK-18080-A2             |     | ...    | ...   | -10 | 83161  |
| TACAA-18045-A             | 010 | 83216  | ...   | ... | ...    |
| TANNA-18045-A             | 010 | 83312  | 89409 | ... | ...    |
| TBAK-18080-A              |     | ...    | ...   | -10 | 83161  |

## APPLICATION GUIDE - TRUCKS, TRAILERS, AND BUSES

| Year<br>Año<br>Année | Model<br>Modelo<br>Modèle | OEM # | Front   |   | Rear  |   |
|----------------------|---------------------------|-------|---|---|---|---|
|                      |                           |       |  |  |  |  |
|                      |                           |       |  |  |  |  |
|                      |                           |       | Fleetline   | GasSLX  | Fleetline   | GasSLX  |

### FORD(Cont'd.)

#### Additional O.E.M. Interchanges(Cont'd.)

|                                |               |               |               |               |               |     |
|--------------------------------|---------------|---------------|---------------|---------------|---------------|-----|
| Models with O.E.M. Number      | TBDA-18080-A  | ...           | ...           | 010           | <b>83217</b>  | ... |
|                                | TBDA-18080-B  | ...           | ...           | 010           | <b>83217</b>  | ... |
|                                | TDAA-18080-A  | ...           | ...           | -10           | <b>83161</b>  | ... |
|                                | TDAA-18080-B  | ...           | ...           | 010           | <b>83217</b>  | ... |
|                                | TDBA-18045-A  | 010           | <b>83219</b>  | ...           |               | ... |
|                                | TDBA-18045-B  | 010           | <b>83219</b>  | ...           |               | ... |
|                                | TDBA-18080-A  | ...           | ...           | 010           | <b>83217</b>  | ... |
|                                | TDBA-18080-B  | ...           | ...           | 010           | <b>83217</b>  | ... |
|                                | TDBA-18080-C  | ...           | ...           | 010           | <b>83217</b>  | ... |
|                                | TDBE-18045-A  | 010           | <b>83219</b>  | ...           |               | ... |
|                                | TFAA-18045-B  | 010           | <b>83219</b>  | ...           |               | ... |
|                                | TFAA-18045-C  | 010           | <b>83219</b>  | ...           |               | ... |
|                                | TFAA-18080-A  | ...           | ...           | 010           | <b>85307</b>  | ... |
|                                | THAB-18045-A  | 010           | <b>83219</b>  | ...           |               | ... |
|                                | THAB-18045-B  | 010           | <b>83219</b>  | ...           |               | ... |
|                                | TQSH-18045-A  | 010           | <b>83309</b>  | 89446         |               | ... |
|                                | XC45-18045-AA | 010           | <b>83216</b>  | ...           |               | ... |
|                                | XL2Z-18124-EA | -10           | <b>G63678</b> | ...           |               | ... |
|                                | XL2Z-18125-BA | ...           | ...           | 010           | <b>G63679</b> | ... |
|                                | XL2Z-18125-CA | ...           | ...           | 010           | <b>G63679</b> | ... |
| XL2Z-18125-EA                  | ...           | ...           | 010           | <b>G63679</b> | ...           |     |
| YL5Z-18124-AA                  | -10           | <b>G63772</b> | ...           |               | ...           |     |
| Additional O.E.M. Interchanges | 680029        | 010           |               |               | <b>85301</b>  |     |
|                                | C6PF-18077-DD | 010           |               |               | <b>83216</b>  |     |
|                                | C6PF-18077-DE | 010           |               |               | <b>83219</b>  |     |
|                                | C7PF-18077-Z  | 010           |               |               | <b>83217</b>  |     |

### FORD CAB SHOCKS

#### 8500 Series

|   |           |     |              |
|---|-----------|-----|--------------|
| Models with 101", 113" & 122" BBC Conventional Tractors with Link Cabmate Models FH101, FH1322 & FH1322-A | 1201-1043 | 010 | <b>83025</b> |
|   | 1202-1043 | 010 | <b>83025</b> |

#### 9500 Series

|   |               |     |              |
|---|---------------|-----|--------------|
| Models with 101", 113" & 122" BBC Conventional Tractors with Link Cabmate Models FH101, FH1322 & FH1322-A | 1201-1043     | 010 | <b>83025</b> |
|   | 1202-1043     | 010 | <b>83025</b> |
| Models with O.E.M. Number   | F6HZ-5K407-AB | 010 | <b>83034</b> |
|   | F6HZ-5K407-BA | 010 | <b>83033</b> |
|   | F8HT-5K407-AA | 010 | <b>83033</b> |

#### Additional Applications

|   |           |     |              |
|---|-----------|-----|--------------|
| CL9000 & CLT9000 Cabover Tractors (Sleeper & Non-Sleeper) with Link Cabmate Model FCL110-2P | 1202-0032 | 010 | <b>83016</b> |
| Models with Link Cab Suspension   | 1202-0042 | 010 | <b>83025</b> |

#### L-Series Conventional





|  |           |     |              |
|--|-----------|-----|--------------|
| All with 60" Able Body Sleepers with Link Bunkmate Models FAS60-A & FAS60-AS   | 1201-1044 | 010 | <b>83025</b> |
|  | 1202-1044 | 010 | <b>83025</b> |
| L, LT, LN, LNT 800, 8000, 9000 Models, LTS, LS 8000, 9000 Models, & LTL, LL 9000 Models with Link Cabmate Model FN89-A | 1201-0012 | 010 | <b>83023</b> |
|  | 1202-0012 | 010 | <b>83023</b> |

### FOREST RIVER INC

#### Class A MotorHomes

|         |  |               |     |              |       |     |     |
|---------|--|---------------|-----|--------------|-------|-----|-----|
| 01 - 19 | Georgetown Series MotorHomes with Ford F53 Chassis with 16,000 lb GVW to 22,000 lb GVW | 1C34-18045-AA | 010 | <b>83209</b> | 89414 | ... | ... |
|         |  |               |     | <b>83209</b> | 89414 | ... | ... |

## APPLICATION GUIDE - TRUCKS, TRAILERS, AND BUSES

| Year<br>Año<br>Année | Model<br>Modelo<br>Modèle | OEM # | Front  |  | Rear  |   |
|----------------------|---------------------------|-------|--|--|---|---|
|                      |                           |       |  |  |  |  |
|                      |                           |       | Wrench   | Wrench   | Wrench  | Wrench  |
|                      |                           |       | Fleetline  | GasSLX   | Fleetline   | GasSLX  |

### FOREST RIVER INC(Cont'd.)





#### Class A MotorHomes(Cont'd.)

|              |  |                |       |       |       |       |       |       |
|--------------|--|----------------|-------|-------|-------|-------|-------|-------|
| 01 - 19      | Georgetown Series MotorHomes with Ford F53 Chassis with 16,000 lb GVW to 22,000 lb GVW   | 9U94-18045-AA  | 010   | 83209 | 89414 | ...   | ...   |       |
|              |  | 9U94-18080-AA  |       | ...   | ...   | 010   | 83122 | 89406 |
|              |  | 9U9Z-18124-A   | 010   | 83209 | 89414 | ...   | ...   |       |
|              |  | 9U9Z-18125-A   |       | ...   | ...   | 010   | 83122 | 89406 |
|              |  | ASH-1022       | 010   | 83209 | 89414 | ...   | ...   |       |
|              |  | ASH-1023       |       | ...   | ...   | 010   | 83122 | 89406 |
|              |  | ASH-1205       | 010   | 83209 | 89414 | ...   | ...   |       |
|              |  | ASH-1206       |       | ...   | ...   | 010   | 83122 | 89406 |
|              |  | ASH-1228       | 010   | 83209 | 89414 | ...   | ...   |       |
|              |  | ASH-1229       | 010   | 83209 | 89414 | ...   | ...   |       |
|              |  | ASH-1230       |       | ...   | ...   | 010   | 83122 | 89406 |
|              |  | ASH-137        |       | ...   | ...   | 010   | 83122 | 89406 |
|              |  | ASH-25822      | 010   | 83209 | 89414 | ...   | ...   |       |
|              |  | ASH-25823      | 010   | 83209 | 89414 | ...   | ...   |       |
|              |  | ASH-25824      |       | ...   | ...   | 010   | 83122 | 89406 |
|              |  | ASH-294        | 010   | 83209 | 89414 | ...   | ...   |       |
| AT-620       | 010  | 83209          | 89414 | ...   | ...   |       |       |       |
| AT-621       |  | ...            | ...   | 010   | 83122 | 89406 |       |       |
| AT-766       | 010  | 83209          | 89414 | ...   | ...   |       |       |       |
|              | Models with Workhorse UFO Chassis with Hendrickson Softek Front Suspension   | 66153-002      | 010   | 83124 | 89407 | ...   | ...   |       |
|              |  | F4-BE5-C832-MO | 010   | 83124 | 89407 | ...   | ...   |       |
| 02 - 04      | Reflection Series MotorHomes with Freightliner XC Chassis<br>ADL200 Suspension w/ 20K Rear<br>AS120 Front Suspension<br><br>Rear Shock with O.E.M. Number<br><br>ZF - IFS Front Suspension with 23,000 lb GVW or Greater | 16-16873-000   |       | ...   | ...   | 010   | 85029 | ...   |
|              |  | 141700131810   | 010   | 83160 | ...   | ...   | ...   | ...   |
|              |  | 16-16737-000   | 010   | 83160 | ...   | ...   | ...   | ...   |
|              |  | 16-16874-000   | 010   | 83160 | ...   | ...   | ...   | ...   |
|              |  | 141700131809   |       | ...   | ...   | 010   | 85029 | ...   |
|              |  | 16-16736-000   |       | ...   | ...   | 010   | 85029 | ...   |
|              |  | 16-18103-000   | -1-   | 85900 | ...   | ...   | ...   | ...   |
| 481700000493 | -1-  | 85900          | ...   | ...   | ...   | ...   |       |       |
| 02 - 06      | Tsunami Series MotorHomes with Freightliner XC Chassis<br>ADL200 Suspension w/ 20K Rear<br>AS120 Front Suspension<br><br>Rear Shock with O.E.M. Number<br><br>ZF - IFS Front Suspension with 23,000 lb GVW or Greater    | 16-16873-000   |       | ...   | ...   | 010   | 85029 | ...   |
|              |  | 141700131810   | 010   | 83160 | ...   | ...   | ...   | ...   |
|              |  | 16-16737-000   | 010   | 83160 | ...   | ...   | ...   | ...   |
|              |  | 16-16874-000   | 010   | 83160 | ...   | ...   | ...   | ...   |
|              |  | 141700131809   |       | ...   | ...   | 010   | 85029 | ...   |
|              |  | 16-16736-000   |       | ...   | ...   | 010   | 85029 | ...   |
|              |  | 16-18103-000   | -1-   | 85900 | ...   | ...   | ...   | ...   |
| 481700000493 | -1-  | 85900          | ...   | ...   | ...   | ...   |       |       |

#### Class C MotorHomes

|         |   |          |     |       |     |     |       |     |
|---------|---|----------|-----|-------|-----|-----|-------|-----|
| 2017    | All American Series MotorHomes with Ford E350 & E450 Chassis            | ASH-1136 |     | ...   | ... | -10 | 83178 | ... |
|         |   | ASH-1154 | -10 | 83177 | ... | ... | ...   | ... |
| 17 - 19 | Forester GTS Series MotorHomes with Ford E350 & E450 Chassis            | ASH-1136 |     | ...   | ... | -10 | 83178 | ... |
|         |   | ASH-1154 | -10 | 83177 | ... | ... | ...   | ... |
| 04 - 19 | Forester Series MotorHomes with Ford E350 & E450 Chassis                | ASH-1136 |     | ...   | ... | -10 | 83178 | ... |
|         |   | ASH-1154 | -10 | 83177 | ... | ... | ...   | ... |
| 04 - 15 | Lexington Series MotorHomes with Ford E350 & E450 Chassis               | ASH-1136 |     | ...   | ... | -10 | 83178 | ... |
|         |   | ASH-1154 | -10 | 83177 | ... | ... | ...   | ... |
| 15 - 19 | Sunseeker Grand Touring Series MotorHomes with Ford E350 & E450 Chassis | ASH-1136 |     | ...   | ... | -10 | 83178 | ... |
|         |   | ASH-1154 | -10 | 83177 | ... | ... | ...   | ... |
| 16 - 19 | Sunseeker GTS Series MotorHomes with Ford E350 & E450 Chassis           | ASH-1136 |     | ...   | ... | -10 | 83178 | ... |

**APPLICATION GUIDE - TRUCKS, TRAILERS, AND BUSES**

| Year<br>Año<br>Année | Model<br>Modelo<br>Modèle | OEM # | Front   |   | Rear  |   |
|----------------------|---------------------------|-------|---|---|---|---|
|                      |                           |       |  |  |  |  |
|                      |                           |       | Fleetline   | GasSLX  | Fleetline   | GasSLX  |

**FOREST RIVER INC(Cont'd.)**

**Class C MotorHomes(Cont'd.)**

|         |   |          |     |       |     |     |       |     |
|---------|---|----------|-----|-------|-----|-----|-------|-----|
| 16 - 19 | Sunseeker GTS Series MotorHomes with Ford E350 & E450 Chassis | ASH-1154 | - O | 83177 | ... |     | ...   | ... |
| 99 - 19 | Sunseeker Series MotorHomes with Ford E350 & E450 Chassis     | ASH-1136 |     | ...   | ... | - O | 83178 | ... |
|         |   | ASH-1154 | - O | 83177 | ... |     | ...   | ... |

**FREIGHTLINER**

**Argosy**

|         |  |              |     |       |       |     |       |       |
|---------|--|--------------|-----|-------|-------|-----|-------|-------|
| 99 - 07 | Models with 12000 lb Taperleaf Front Suspension                                | 10-12703-000 | O O | 85918 | 89449 |     | ...   | ...   |
|         |  | 10-13634-000 | O O | 85918 | 89449 |     | ...   | ...   |
|         |  | 471700000449 | O O | 85918 | 89449 |     | ...   | ...   |
| 99 - 07 | Models with Freightliner FAS II Rear Air Suspension                            | 16-13957-000 |     | ...   | ...   | O O | 85724 | 89443 |
|         |  | 16-15817-000 |     | ...   | ...   | O O | 85724 | 89443 |
|         |  | 680339       |     | ...   | ...   | O O | 85724 | 89443 |
|         |  | 680611       |     | ...   | ...   | O O | 85724 | 89443 |
| 99 - 07 | Models with Freightliner Low Profile Rear Air Suspension (18,000 to 40,000 lb) | 16-14259-000 |     | ...   | ...   | O O | 85331 | ...   |
|         |  | 16-18706-000 |     | ...   | ...   | O O | 85331 | ...   |
|         |  | 471700002992 |     | ...   | ...   | O O | 85331 | ...   |
|         |  | 680511       |     | ...   | ...   | O O | 85331 | ...   |
| 99 - 07 | Models with Rear 10000 lb - 15000 lb Low Profile AirLiner                      | 16-16577-000 |     | ...   | ...   | O O | 85335 | ...   |
|         |  | 16-18711-000 |     | ...   | ...   | O O | 85335 | ...   |
|         |  | 471700002996 |     | ...   | ...   | O O | 85335 | ...   |

**Cargo - FC70 & FC80**

|         |  |              |     |       |     |     |       |       |
|---------|--|--------------|-----|-------|-----|-----|-------|-------|
| 99 - 07 | FC70 & FC80 Models with 10,000 to 18,000 lb Suspension | 10-13759-000 | O O | 85006 | ... |     | ...   | ...   |
|         |  | 471700003009 | O O | 85006 | ... |     | ...   | ...   |
|         |  | 6803230300   | O O | 85006 | ... |     | ...   | ...   |
|         |  | GBL665538    | O O | 85006 | ... |     | ...   | ...   |
| 99 - 07 | FC70 & FC80 Models with 6000 to 9000 lb Front Axle     | 654654       | O O | 85043 | ... |     | ...   | ...   |
|         |  | 6803230200   | O O | 85043 | ... |     | ...   | ...   |
| 99 - 07 | FC70 & FC80 Models with FAS II Rear Air Suspension     | 16-13957-000 |     | ...   | ... | O O | 85724 | 89443 |
|         |  | 16-15817-000 |     | ...   | ... | O O | 85724 | 89443 |
|         |  | 680339       |     | ...   | ... | O O | 85724 | 89443 |
|         |  | 680611       |     | ...   | ... | O O | 85724 | 89443 |





**Cascadia**

|         |  |                 |     |       |       |     |       |       |
|---------|--|-----------------|-----|-------|-------|-----|-------|-------|
| 09 - 18 | Models with 12000 to 13300 lb Taperleaf Front Suspension | 10-13809-000    | O O | 85958 | ...   |     | ...   | ...   |
|         |  | SDA471400003920 | O O | 85958 | ...   |     | ...   | ...   |
| 2008    | Models with 12000 to 13300 lb Taperleaf Front Suspension | 10-13211-000    | O O | 85918 | 89449 |     | ...   | ...   |
|         |  | 10-13634-000    | O O | 85918 | 89449 |     | ...   | ...   |
|         |  | 471700000449    | O O | 85918 | 89449 |     | ...   | ...   |
|         |  | 471700131155    | O O | 85918 | 89449 |     | ...   | ...   |
| 09 - 19 | Models with Hendrickson Front Airtek                     | 471700006269    | O O | 85932 | 89453 |     | ...   | ...   |
|         |  | 471700131331    | O O | 85932 | 89453 |     | ...   | ...   |
|         |  | 58913-003       | O O | 85932 | 89453 |     | ...   | ...   |
|         |  | 58913-003L      | O O | 85932 | 89453 |     | ...   | ...   |
|         |  | 58913-012       | O O | 85932 | 89453 |     | ...   | ...   |
|         |  | 58913-012L      | O O | 85932 | 89453 |     | ...   | ...   |
| 09 - 19 | Models with FAS II (40,000 lb) Rear Air Suspension       | 16-15817-000    |     | ...   | ...   | O O | 85724 | 89443 |
|         |  | 16-18708-000    |     | ...   | ...   | O O | 85724 | 89443 |
|         |  | 471700002809    |     | ...   | ...   | O O | 85724 | 89443 |
|         |  | 481700006848    |     | ...   | ...   | O O | 85724 | 89443 |
|         |  | 680611          |     | ...   | ...   | O O | 85724 | 89443 |
|         |  | SDA471700002809 |     | ...   | ...   | O O | 85724 | 89443 |

**Century Class - C112, C120, CST112 & CST120**

|         |   |              |     |       |       |  |     |     |
|---------|---|--------------|-----|-------|-------|--|-----|-----|
| 00 - 11 | Models with 12000 lb Taperleaf Front Suspension | 10-13021-000 | O O | 85918 | 89449 |  | ... | ... |
|---------|---|--------------|-----|-------|-------|--|-----|-----|

## APPLICATION GUIDE - TRUCKS, TRAILERS, AND BUSES

| Year<br>Año<br>Année | Model<br>Modelo<br>Modèle | OEM # | Front  |  | Rear  |   |
|----------------------|---------------------------|-------|--|--|---|---|
|                      |                           |       |  |  |  |  |
|                      |                           |       | Wrench   | Wrench   | Wrench  | Wrench  |
|                      |                           |       | Fleetline  | GasSLX   | Fleetline   | GasSLX  |

### FREIGHTLINER(Cont'd.)

#### Century Class - C112, C120, CST112 & CST120(Cont'd.)

|                 |  |              |     |              |              |              |              |              |
|-----------------|--|--------------|-----|--------------|--------------|--------------|--------------|--------------|
| 00 - 11         | Models with 12000 lb Taperleaf Front Suspension                                | 10-13063-000 | O1O | <b>85918</b> | <b>89449</b> |              | ...          | ...          |
|                 |  | 10-13211-000 | O1O | <b>85918</b> | <b>89449</b> |              | ...          | ...          |
|                 |  | 10-13634-000 | O1O | <b>85918</b> | <b>89449</b> |              | ...          | ...          |
|                 |  | 47170000449  | O1O | <b>85918</b> | <b>89449</b> |              | ...          | ...          |
|                 |  | 47170000449  | O1O | <b>85918</b> | <b>89449</b> |              | ...          | ...          |
|                 |  | 471700131155 | O1O | <b>85918</b> | <b>89449</b> |              | ...          | ...          |
| 97 - 99         | Models with 12000 lb Taperleaf Front Suspension                                | 10-12542-000 | O1O | <b>85901</b> | ...          |              | ...          | ...          |
| 97 - 11         | Models with FAS II Rear Air Suspension   | 16-13957-000 |     | ...          | ...          | O1O          | <b>85724</b> | <b>89443</b> |
|                 |  | 16-15817-000 |     | ...          | ...          | O1O          | <b>85724</b> | <b>89443</b> |
|                 |  | 16-18708-000 |     | ...          | ...          | O1O          | <b>85724</b> | <b>89443</b> |
|                 |  | 471700002809 |     | ...          | ...          | O1O          | <b>85724</b> | <b>89443</b> |
|                 |  | 481700006848 |     | ...          | ...          | O1O          | <b>85724</b> | <b>89443</b> |
|                 |  | 680339       |     | ...          | ...          | O1O          | <b>85724</b> | <b>89443</b> |
|                 |  | 680611       |     | ...          | ...          | O1O          | <b>85724</b> | <b>89443</b> |
| SDA471700002809 |  | ...          | ... | O1O          | <b>85724</b> | <b>89443</b> |              |              |
| 97 - 11         | Models with Freightliner Low Profile Rear Air Suspension (18,000 to 40,000 lb) | 16-14259-000 |     | ...          | ...          | O1O          | <b>85331</b> | ...          |
|                 |  | 16-18706-000 |     | ...          | ...          | O1O          | <b>85331</b> | ...          |
|                 |  | 471700002992 |     | ...          | ...          | O1O          | <b>85331</b> | ...          |
|                 |  | 680511       |     | ...          | ...          | O1O          | <b>85331</b> | ...          |
| 02 - 11         | Models with Hendrickson Front Airtek   | 471700131331 | O1O | <b>85932</b> | <b>89453</b> |              | ...          | ...          |
|                 |  | 58913-003    | O1O | <b>85932</b> | <b>89453</b> |              | ...          | ...          |
|                 |  | 58913-003L   | O1O | <b>85932</b> | <b>89453</b> |              | ...          | ...          |
|                 | Models with Low Profile Front  | 10-12703-000 | O1O | <b>85918</b> | <b>89449</b> |              | ...          | ...          |





#### Classic/ClassicXL

|                 |   |              |              |              |              |              |              |              |
|-----------------|---|--------------|--------------|--------------|--------------|--------------|--------------|--------------|
| 03 - 11         | Models with 12000 lb Taperleaf Front Suspension | 10-13021-000 | O1O          | <b>85918</b> | <b>89449</b> |              | ...          | ...          |
|                 |   | 10-13063-000 | O1O          | <b>85918</b> | <b>89449</b> |              | ...          | ...          |
|                 |   | 10-13211-000 | O1O          | <b>85918</b> | <b>89449</b> |              | ...          | ...          |
|                 |   | 10-13634-000 | O1O          | <b>85918</b> | <b>89449</b> |              | ...          | ...          |
|                 |   | 47170000449  | O1O          | <b>85918</b> | <b>89449</b> |              | ...          | ...          |
|                 |   | 47170000449  | O1O          | <b>85918</b> | <b>89449</b> |              | ...          | ...          |
| 471700131155    | O1O   | <b>85918</b> | <b>89449</b> |              | ...          | ...          |              |              |
| 03 - 11         | Models with FAS II Rear Air Suspension          | 16-15817-000 |              | ...          | ...          | O1O          | <b>85724</b> | <b>89443</b> |
|                 |   | 16-18708-000 |              | ...          | ...          | O1O          | <b>85724</b> | <b>89443</b> |
|                 |   | 471700002809 |              | ...          | ...          | O1O          | <b>85724</b> | <b>89443</b> |
|                 |   | 481700006848 |              | ...          | ...          | O1O          | <b>85724</b> | <b>89443</b> |
|                 |   | 680611       |              | ...          | ...          | O1O          | <b>85724</b> | <b>89443</b> |
| SDA471700002809 |   | ...          | ...          | O1O          | <b>85724</b> | <b>89443</b> |              |              |
| 03 - 11         | Models with Hendrickson Front Airtek            | 471700131331 | O1O          | <b>85932</b> | <b>89453</b> |              | ...          | ...          |
|                 |   | 58913-003    | O1O          | <b>85932</b> | <b>89453</b> |              | ...          | ...          |
|                 |   | 58913-003L   | O1O          | <b>85932</b> | <b>89453</b> |              | ...          | ...          |
|                 | Models with O.E.M. Number                       | 10-12032-002 | O1O          | <b>85320</b> | <b>89429</b> |              | ...          | ...          |
|                 |   | 10-12032-004 | O1O          | <b>85320</b> | <b>89429</b> |              | ...          | ...          |
|                 |   | 680009       | O1O          | <b>85302</b> | <b>89420</b> |              | ...          | ...          |
|                 |   | 70029        | O1O          | <b>85308</b> | <b>89422</b> |              | ...          | ...          |

#### Columbia

|         |   |                 |     |              |              |  |     |     |
|---------|---|-----------------|-----|--------------|--------------|--|-----|-----|
| 03 - 08 | Models with 12000 lb Taperleaf Front Suspension | 10-13021-000    | O1O | <b>85918</b> | <b>89449</b> |  | ... | ... |
|         |   | 10-13063-000    | O1O | <b>85918</b> | <b>89449</b> |  | ... | ... |
|         |   | 10-13211-000    | O1O | <b>85918</b> | <b>89449</b> |  | ... | ... |
|         |   | 10-13634-000    | O1O | <b>85918</b> | <b>89449</b> |  | ... | ... |
|         |   | 47170000449     | O1O | <b>85918</b> | <b>89449</b> |  | ... | ... |
|         |   | 471700131155    | O1O | <b>85918</b> | <b>89449</b> |  | ... | ... |
| 09 - 18 | Models with 12000 lb Taperleaf Front Suspension | 10-13809-000    | O1O | <b>85958</b> | ...          |  | ... | ... |
|         |   | SDA471400003920 | O1O | <b>85958</b> | ...          |  | ... | ... |
| 03 - 17 | Models with Hendrickson Front Airtek            | 471700006269    | O1O | <b>85932</b> | <b>89453</b> |  | ... | ... |

**APPLICATION GUIDE - TRUCKS, TRAILERS, AND BUSES**

| Year<br>Año<br>Année | Model<br>Modelo<br>Modèle | OEM # | Front   |   | Rear  |   |
|----------------------|---------------------------|-------|---|---|---|---|
|                      |                           |       |  |  |  |  |
|                      |                           |       | Fleetline   | GasSLX  | Fleetline   | GasSLX  |

**FREIGHTLINER(Cont'd.)**

**Columbia(Cont'd.)**

|         |  |                 |     |       |       |     |       |       |
|---------|--|-----------------|-----|-------|-------|-----|-------|-------|
| 03 - 17 | Models with Hendrickson Front Airtek                     | 471700131331    | 010 | 85932 | 89453 |     | ...   | ...   |
|         |  | 58913-003       | 010 | 85932 | 89453 |     | ...   | ...   |
|         |  | 58913-003L      | 010 | 85932 | 89453 |     | ...   | ...   |
|         |  | 58913-012       | 010 | 85932 | 89453 |     | ...   | ...   |
|         |  | 58913-012L      | 010 | 85932 | 89453 |     | ...   | ...   |
|         | Models with O.E.M. Number                                | 10-13684-000    | 010 | 85918 | 89449 |     | ...   | ...   |
|         |  | 471700000470    | 010 | 85918 | 89449 |     | ...   | ...   |
| 03 - 18 | All Models with Freightliner TufTrac Rear Air Suspension | 16-15770-000    |     | ...   | ...   | 010 | 85956 | ...   |
|         |  | 481700125969    |     | ...   | ...   | 010 | 85956 | ...   |
| 03 - 18 | Models with FAS II Rear Air Suspension                   | 16-15817-000    |     | ...   | ...   | 010 | 85724 | 89443 |
|         |  | 16-18708-000    |     | ...   | ...   | 010 | 85724 | 89443 |
|         |  | 471700002808    |     | ...   | ...   | 010 | 85724 | 89443 |
|         |  | 471700002809    |     | ...   | ...   | 010 | 85724 | 89443 |
|         |  | 481700006848    |     | ...   | ...   | 010 | 85724 | 89443 |
|         |  | 680611          |     | ...   | ...   | 010 | 85724 | 89443 |
|         |  | SDA471700002809 |     | ...   | ...   | 010 | 85724 | 89443 |

**Condor**

|                 |   |              |     |       |       |       |       |       |
|-----------------|---|--------------|-----|-------|-------|-------|-------|-------|
| 01 - 07         | Models with 14,600 to 20,000 lb Front Suspension                              | 10-13211-000 | 010 | 85918 | 89449 |       | ...   | ...   |
|                 |   | 10-13634-000 | 010 | 85918 | 89449 |       | ...   | ...   |
|                 |   | 471700000449 | 010 | 85918 | 89449 |       | ...   | ...   |
|                 |   | 471700131155 | 010 | 85918 | 89449 |       | ...   | ...   |
| 01 - 07         | Models with Chalmers 46,000 lb Rear Suspension                                | 665174       |     | ...   | ...   | 010   | 85060 | ...   |
| 01 - 07         | Models with FAS II Rear Air Suspension  | 16-13957-000 |     | ...   | ...   | 010   | 85724 | 89443 |
|                 |   | 16-15817-000 |     | ...   | ...   | 010   | 85724 | 89443 |
|                 |   | 16-18708-000 |     | ...   | ...   | 010   | 85724 | 89443 |
|                 |   | 471700002809 |     | ...   | ...   | 010   | 85724 | 89443 |
|                 |   | 481700006848 |     | ...   | ...   | 010   | 85724 | 89443 |
|                 |   | 680339       |     | ...   | ...   | 010   | 85724 | 89443 |
| SDA471700002809 |   | ...          | ... | 010   | 85724 | 89443 |       |       |
| 01 - 07         | Models with Freightliner TufTrac Rear Air Suspension                          | 16-15770-000 |     | ...   | ...   | 010   | 85956 | ...   |
|                 |   | 481700125969 |     | ...   | ...   | 010   | 85956 | ...   |
| 02 - 07         | Models with Hendrickson HMX 400/460 Haulmax with 16.5" Saddle                 | 60680-004    |     | ...   | ...   | 01-   | 83143 | ...   |
|                 |   | 60680-004L   |     | ...   | ...   | 01-   | 83143 | ...   |
|                 |   | H60680004    |     | ...   | ...   | 01-   | 83143 | ...   |
| 02 - 07         | Models with Hendrickson HMX 400/460 Haulmax with 17.5" or 18.5" Saddle Height | 60680-005    |     | ...   | ...   | 01-   | 83142 | ...   |
|                 |   | 60680-005L   |     | ...   | ...   | 01-   | 83142 | ...   |
|                 |   | H60680005    |     | ...   | ...   | 01-   | 83142 | ...   |

**Coronado**

|         |  |              |     |       |       |     |       |       |
|---------|--|--------------|-----|-------|-------|-----|-------|-------|
| 10 - 19 | Models with 12,000 lb to 20,000 Front Axle         | 10-13809-000 | 010 | 85958 | ...   |     | ...   | ...   |
|         |  | 471700003920 | 010 | 85958 | ...   |     | ...   | ...   |
|         | Models with 12000 lb Taperleaf Front Suspension    | 10-13211-000 | 010 | 85918 | 89449 |     | ...   | ...   |
| 10 - 16 | Models with Hendrickson Front Airtek               | 471700006269 | 010 | 85932 | 89453 |     | ...   | ...   |
|         |  | 471700131331 | 010 | 85932 | 89453 |     | ...   | ...   |
|         |  | 58913-003    | 010 | 85932 | 89453 |     | ...   | ...   |
|         |  | 58913-003L   | 010 | 85932 | 89453 |     | ...   | ...   |
|         |  | 58913-012    | 010 | 85932 | 89453 |     | ...   | ...   |
|         |  | 58913-012L   | 010 | 85932 | 89453 |     | ...   | ...   |
| 10 - 14 | Models with Chalmers 46,000 lb Rear Suspension     | 665174       |     | ...   | ...   | 010 | 85060 | ...   |
| 10 - 19 | Models with FAS II (40,000 lb) Rear Air Suspension | 16-15817-000 |     | ...   | ...   | 010 | 85724 | 89443 |
|         |  | 16-18708-000 |     | ...   | ...   | 010 | 85724 | 89443 |
|         |  | 471700002809 |     | ...   | ...   | 010 | 85724 | 89443 |
|         |  | 481700006848 |     | ...   | ...   | 010 | 85724 | 89443 |
|         |  | 680611       |     | ...   | ...   | 010 | 85724 | 89443 |



## APPLICATION GUIDE - TRUCKS, TRAILERS, AND BUSES

| Year<br>Año<br>Année | Model<br>Modelo<br>Modèle | OEM # | Front     |        | Rear      |        |
|----------------------|---------------------------|-------|-----------|--------|-----------|--------|
|                      |                           |       |           |        |           |        |
|                      |                           |       | Fleetline | GasSLX | Fleetline | GasSLX |

### FREIGHTLINER(Cont'd.)

#### Coronado(Cont'd.)

|         |  |                 |  |     |     |     |       |       |
|---------|--|-----------------|--|-----|-----|-----|-------|-------|
| 10 - 19 | Models with FAS II (40,000 lb) Rear Air Suspension   | SDA471700002809 |  | ... | ... | OIO | 85724 | 89443 |
| 10 - 18 | Models with Freightliner TufTrac Rear Air Suspension | 16-15770-000    |  | ... | ... | OIO | 85956 | ...   |
|         |  | 481700125969    |  | ... | ... | OIO | 85956 | ...   |

#### FL50, 60, 70, 80 - Business Class

|         |   |              |     |       |     |     |       |       |
|---------|---|--------------|-----|-------|-----|-----|-------|-------|
|         | FAS Airliner, Single / Tandem Past Production | 16-11133-000 |     | ...   | ... | OIO | 85007 | 89412 |
| 92 - 06 | FL Models with 15000 lb Rear Suspension       | 6803260000   |     | ...   | ... | OI- | 83120 | ...   |
|         |   | GBL654725    |     | ...   | ... | OI- | 83120 | ...   |
| 92 - 06 | FL Models with 10,000 to 18,000 lb Suspension | 10-13759-000 | OIO | 85006 | ... |     | ...   | ...   |
|         |   | 471700003009 | OIO | 85006 | ... |     | ...   | ...   |
|         |   | 6803230300   | OIO | 85006 | ... |     | ...   | ...   |
|         |   | GBL665538    | OIO | 85006 | ... |     | ...   | ...   |
| 92 - 06 | FL Models with 6000 to 9000 lb Front axle     | 654654       | OIO | 85043 | ... |     | ...   | ...   |
|         |   | 6803230200   | OIO | 85043 | ... |     | ...   | ...   |
| 92 - 06 | FL Models with FAS II Rear Air Suspension     | 16-13957-000 |     | ...   | ... | OIO | 85724 | 89443 |
|         |   | 16-15817-000 |     | ...   | ... | OIO | 85724 | 89443 |
|         |   | 680339       |     | ...   | ... | OIO | 85724 | 89443 |
|         |   | 680611       |     | ...   | ... | OIO | 85724 | 89443 |





#### FLA & FLB Series - COE Truck & Tractor

|         |   |              |     |       |       |     |       |       |
|---------|---|--------------|-----|-------|-------|-----|-------|-------|
| 89 - 02 | COE Models  | 10-12030-002 | OIO | 85320 | 89429 |     | ...   | ...   |
|         |   | 10-12032-000 | OIO | 85320 | 89429 |     | ...   | ...   |
|         |   | 10-12032-001 | OIO | 85320 | 89429 |     | ...   | ...   |
|         |   | 10-12032-002 | OIO | 85320 | 89429 |     | ...   | ...   |
|         |   | 10-12032-003 | OIO | 85320 | 89429 |     | ...   | ...   |
|         |   | 10-12032-004 | OIO | 85320 | 89429 |     | ...   | ...   |
| 89 - 02 | COE Models with Airliner Rolling Lobe Spring Air Suspension | 16-13947-000 |     | ...   | ...   | -IO | 85319 | 89428 |
|         |   | 681-326-0400 |     | ...   | ...   | -IO | 85319 | 89428 |
| 89 - 02 | COE Models with Convolute Spring Air Suspension             | 16-12117-000 |     | ...   | ...   | OIO | 85007 | 89412 |
|         |   | 16-18705-000 |     | ...   | ...   | OIO | 85007 | 89412 |
|         |   | 471700002990 |     | ...   | ...   | OIO | 85007 | 89412 |
|         |   | 665236       |     | ...   | ...   | OIO | 85007 | 89412 |
| 89 - 02 | COE Models with FAS II Rear Air Suspension                  | 16-13957-000 |     | ...   | ...   | OIO | 85724 | 89443 |
|         |   | 16-15817-000 |     | ...   | ...   | OIO | 85724 | 89443 |
|         |   | 680339       |     | ...   | ...   | OIO | 85724 | 89443 |
|         |   | 680611       |     | ...   | ...   | OIO | 85724 | 89443 |
|         | COE Models with Neway Tag Axle Air Suspension               | 90044162     |     | ...   | ...   | OIO | 83128 | 89436 |

#### FLC & FLD Series - 112 & 120 Conventional Truck & Tractor

|         |  |              |     |       |       |     |       |       |
|---------|--|--------------|-----|-------|-------|-----|-------|-------|
| 00 - 11 | Conventional Models with 12000 lb Taperleaf Front Suspension         | 10-13021-000 | OIO | 85918 | 89449 |     | ...   | ...   |
|         |  | 10-13063-000 | OIO | 85918 | 89449 |     | ...   | ...   |
|         |  | 10-13211-000 | OIO | 85918 | 89449 |     | ...   | ...   |
|         |  | 10-13634-000 | OIO | 85918 | 89449 |     | ...   | ...   |
|         |  | 471700000449 | OIO | 85918 | 89449 |     | ...   | ...   |
|         |  | 471700000449 | OIO | 85918 | 89449 |     | ...   | ...   |
| - 1994  | Conventional Models with Airliner Rolling Lobe Spring Air Suspension | 16-13947-000 |     | ...   | ...   | -IO | 85319 | 89428 |
|         |  | 681-326-0400 |     | ...   | ...   | -IO | 85319 | 89428 |
| - 2008  | Conventional Models with Convolute Spring Air Suspension             | 16-12117-000 |     | ...   | ...   | OIO | 85007 | 89412 |
|         |  | 16-18705-000 |     | ...   | ...   | OIO | 85007 | 89412 |
|         |  | 471700002990 |     | ...   | ...   | OIO | 85007 | 89412 |
|         |  | 665236       |     | ...   | ...   | OIO | 85007 | 89412 |
| - 2011  | Conventional Models with FAS II Rear Air Suspension                  | 16-13957-000 |     | ...   | ...   | OIO | 85724 | 89443 |
|         |  | 16-15817-000 |     | ...   | ...   | OIO | 85724 | 89443 |
|         |  | 16-18708-000 |     | ...   | ...   | OIO | 85724 | 89443 |
|         |  | 471700002809 |     | ...   | ...   | OIO | 85724 | 89443 |
|         |  | 481700006848 |     | ...   | ...   | OIO | 85724 | 89443 |

**APPLICATION GUIDE - TRUCKS, TRAILERS, AND BUSES**

| Year<br>Año<br>Année | Model<br>Modelo<br>Modèle | OEM # | Front   |   | Rear  |   |
|----------------------|---------------------------|-------|---|---|---|---|
|                      |                           |       |  |  |  |  |
|                      |                           |       | Fleetline   | GasSLX  | Fleetline   | GasSLX  |

**FREIGHTLINER(Cont'd.)**

**FLC & FLD Series - 112 & 120 Conventional Truck & Tractor(Cont'd.)**

|         |  |                 |     |       |       |     |       |       |
|---------|--|-----------------|-----|-------|-------|-----|-------|-------|
| - 2011  | Conventional Models with FAS II Rear Air Suspension    | 680339          |     | ...   | ...   | 010 | 85724 | 89443 |
|         |  | 680611          |     | ...   | ...   | 010 | 85724 | 89443 |
|         |  | SDA471700002809 |     | ...   | ...   | 010 | 85724 | 89443 |
| 02 - 11 | Conventional Models with Hendrickson Front Airtek      | 471700131331    | 010 | 85932 | 89453 |     | ...   | ...   |
|         |  | 58913-003       | 010 | 85932 | 89453 |     | ...   | ...   |
|         |  | 58913-003L      | 010 | 85932 | 89453 |     | ...   | ...   |
|         | Conventional Models with Neway Tag Axle Air Suspension | 90044162        |     | ...   | ...   | 010 | 83128 | 89436 |
|         | Conventional Models with O.E.M. Number                 | 10-12030-002    | 010 | 85320 | 89429 |     | ...   | ...   |
|         |  | 10-12032-000    | 010 | 85320 | 89429 |     | ...   | ...   |
|         |  | 10-12032-001    | 010 | 85320 | 89429 |     | ...   | ...   |
|         |  | 10-12032-002    | 010 | 85320 | 89429 |     | ...   | ...   |
|         |  | 10-12032-003    | 010 | 85320 | 89429 |     | ...   | ...   |
|         |  | 10-12032-004    | 010 | 85320 | 89429 |     | ...   | ...   |
| 09 - 11 | Models with 12000 lb Taperleaf Front Suspension        | 10-13809-000    | 010 | 85958 | ...   |     | ...   | ...   |
|         |  | SDA471400003920 | 010 | 85958 | ...   |     | ...   | ...   |
| 08 - 11 | Models with Freightliner TufTrac Rear Air Suspension   | 16-15770-000    |     | ...   | ...   | 010 | 85956 | ...   |
|         |  | 481700125969    |     | ...   | ...   | 010 | 85956 | ...   |
|         |  | SDA481700125969 |     | ...   | ...   | 010 | 85956 | ...   |

**L - Line 8500 Series - Conventional Cab**

|  |  |              |  |     |     |     |       |     |
|--|--|--------------|--|-----|-----|-----|-------|-----|
|  | LT 8500 Models with Freightliner TufTrac Rear Air Suspension | 16-15770-000 |  | ... | ... | 010 | 85956 | ... |
|  |  | 481700125969 |  | ... | ... | 010 | 85956 | ... |

**L - Line 9500 Series - Conventional Cab**

|  |  |              |  |     |     |     |       |     |
|--|--|--------------|--|-----|-----|-----|-------|-----|
|  | LT 9500 Models with Freightliner TufTrac Rear Air Suspension | 16-15770-000 |  | ... | ... | 010 | 85956 | ... |
|  |  | 481700125969 |  | ... | ... | 010 | 85956 | ... |





**Legacy**

|        |  |              |     |       |     |     |       |       |
|--------|--|--------------|-----|-------|-----|-----|-------|-------|
| - 1998 | Models with FAS II Rear Air Suspension | 16-13957-000 |     | ...   | ... | 010 | 85724 | 89443 |
|        |  | 680339       |     | ...   | ... | 010 | 85724 | 89443 |
| 1999 - | Models with FAS II Rear Air Suspension | 16-15817-000 |     | ...   | ... | 010 | 85724 | 89443 |
|        |  | 680611       |     | ...   | ... | 010 | 85724 | 89443 |
|        | Models with O.E.M. Number              | 681-323-0900 | -10 | 85009 | ... |     | ...   | ...   |

**M2 - Business Class**

|         |  |                 |     |       |       |     |       |       |
|---------|--|-----------------|-----|-------|-------|-----|-------|-------|
| 02 - 08 | M2-106 Models with 10000 to 12000 lb. Taper-leaf Spring Suspension             | 10-12390-000    | 010 | 85920 | 89503 |     | ...   | ...   |
| 02 - 08 | M2-106 Models with 6000 to 9000 lb Front axle                                  | 10-12388-000    | 010 | 85920 | 89503 |     | ...   | ...   |
| 09 - 19 | M2-106 Models with 8000 to 16000 lb Front Axle and Taperleaf Spring            | 10-13760-000    | 010 | 85959 | 89503 |     | ...   | ...   |
|         |  | 471700002991    | 010 | 85959 | 89503 |     | ...   | ...   |
|         |  | SDA471700002991 | 010 | 85959 | 89503 |     | ...   | ...   |
| 04 - 08 | M2-112 Models with 12000 lb to 20000 Front Axle                                | 10-13211-000    | 010 | 85918 | 89449 |     | ...   | ...   |
|         |  | 10-13634-000    | 010 | 85918 | 89449 |     | ...   | ...   |
|         |  | 471700000449    | 010 | 85918 | 89449 |     | ...   | ...   |
|         |  | 471700131155    | 010 | 85918 | 89449 |     | ...   | ...   |
| 09 - 19 | M2-112 Models with 12000 lb to 20000 Front Axle                                | 10-13809-000    | 010 | 85958 | ...   |     | ...   | ...   |
|         |  | 471700003920    | 010 | 85958 | ...   |     | ...   | ...   |
|         | Models O.E.M. Number   | 10-13592-000    | 010 | 85959 | 89503 |     | ...   | ...   |
|         |  | 471700000440    | 010 | 85959 | 89503 |     | ...   | ...   |
| 02 - 19 | Models with FAS II Rear Air Suspension   | 16-15817-000    |     | ...   | ...   | 010 | 85724 | 89443 |
|         |  | 16-18708-000    |     | ...   | ...   | 010 | 85724 | 89443 |
|         |  | 471700002809    |     | ...   | ...   | 010 | 85724 | 89443 |
|         |  | 481700006848    |     | ...   | ...   | 010 | 85724 | 89443 |
|         |  | 680611          |     | ...   | ...   | 010 | 85724 | 89443 |
|         |  | SDA471700002809 |     | ...   | ...   | 010 | 85724 | 89443 |
| 02 - 15 | Models with Freightliner Low Profile Rear Air Suspension (18,000 to 40,000 lb) | 16-14259-000    |     | ...   | ...   | 010 | 85331 | ...   |
|         |  | 16-18706-000    |     | ...   | ...   | 010 | 85331 | ...   |

**APPLICATION GUIDE - TRUCKS, TRAILERS, AND BUSES**

| Year<br>Año<br>Année | Model<br>Modelo<br>Modèle | OEM # | Front   |  | Rear  |   |
|----------------------|---------------------------|-------|---|--|---|---|
|                      |                           |       |  |  |  |  |
|                      |                           |       | Fleetline   | GasSLX   | Fleetline   | GasSLX  |

**FREIGHTLINER(Cont'd.)**

**M2 - Business Class(Cont'd.)**

|         |  |              |     |     |     |       |     |
|---------|--|--------------|-----|-----|-----|-------|-----|
| 02 - 15 | Models with Freightliner Low Profile Rear Air Suspension (18,000 to 40,000 lb) | 47170002992  | ... | ... | 010 | 85331 | ... |
|         |  | 680511       | ... | ... | 010 | 85331 | ... |
| 01 - 19 | Models with Freightliner TufTrac Rear Air Suspension                           | 16-15770-000 | ... | ... | 010 | 85956 | ... |
|         |  | 481700125969 | ... | ... | 010 | 85956 | ... |
|         | Models with Hendrickson HMX 400/460 Haulmax with 16.5" Saddle                  | 60680-004    | ... | ... | 01- | 83143 | ... |
|         |  | 60680-004L   | ... | ... | 01- | 83143 | ... |
|         |  | H60680004    | ... | ... | 01- | 83143 | ... |
|         | Models with Hendrickson HMX 400/460 Haulmax with 17.5" or 18.5" Saddle Height  | 60680-005    | ... | ... | 01- | 83142 | ... |
|         |  | 60680-005L   | ... | ... | 01- | 83142 | ... |
|         |  | H60680005    | ... | ... | 01- | 83142 | ... |
| 2002 -  | Models with Rear 10000 lb - 15000 lb Low Profile AirLiner                      | 16-16577-000 | ... | ... | 010 | 85335 | ... |
|         |  | 16-18711-000 | ... | ... | 010 | 85335 | ... |
|         |  | 47170002996  | ... | ... | 010 | 85335 | ... |
| 02 - 14 | Models with Rear 52" Spring ,10000 lb - 15000 lb                               | 16-16486-000 | ... | ... | -10 | 83134 | ... |
|         |  | 16-18710-000 | ... | ... | -10 | 83134 | ... |
|         |  | 47170002995  | ... | ... | -10 | 83134 | ... |
| 02 - 14 | Models with Rear 52" Spring ,18000 lb - 23000 lb                               | 16-16442-000 | ... | ... | -10 | 83134 | ... |
|         |  | 16-18709-000 | ... | ... | -10 | 83134 | ... |
|         |  | 47170002994  | ... | ... | -10 | 83134 | ... |
| 2002 -  | Models with Rear 60" Spring ,18000 lb - 23000 lb                               | 16-15765-000 | ... | ... | -10 | 85921 | ... |
|         |  | 16-18707-000 | ... | ... | -10 | 85921 | ... |
|         |  | 47170002993  | ... | ... | -10 | 85921 | ... |

**Severe Duty Series - 108SD, 114SD & 122SD**

|         |  |                 |     |       |       |       |       |
|---------|--|-----------------|-----|-------|-------|-------|-------|
| 12 - 19 | All Models with 12,000 to 16,000 lb. Front Axle and Taperleaf Spring   | 10-13760-000    | 010 | 85959 | 89503 | ...   | ...   |
|         |  | 47170002991     | 010 | 85959 | 89503 | ...   | ...   |
| 12 - 17 | All Models with 18,000 lb Flat Leaf Spring                             | 10-13684-000    | 010 | 85918 | 89449 | ...   | ...   |
|         |  | 47170000470     | 010 | 85918 | 89449 | ...   | ...   |
| 12 - 19 | All Models with 20,000 lb Flat Leaf Spring                             | 10-13809-000    | 010 | 85958 | ...   | ...   | ...   |
|         |  | 471700003920    | 010 | 85958 | ...   | ...   | ...   |
| 12 - 14 | All Models with O.E.M. Number  | 10-13934-000    | 01- | 85123 | ...   | ...   | ...   |
|         |  | 471700006929    | 01- | 85123 | ...   | ...   | ...   |
| 12 - 19 | All Models with FAS II (40,000 lb) Rear Air Suspension                 | 16-15817-000    | ... | ...   | 010   | 85724 | 89443 |
|         |  | 16-18708-000    | ... | ...   | 010   | 85724 | 89443 |
|         |  | 47170002809     | ... | ...   | 010   | 85724 | 89443 |
|         |  | 481700006848    | ... | ...   | 010   | 85724 | 89443 |
|         |  | 680611          | ... | ...   | 010   | 85724 | 89443 |
|         |  | SDA471700002809 | ... | ...   | 010   | 85724 | 89443 |
| 12 - 19 | All Models with Freightliner TufTrac Rear Air Suspension               | 16-15770-000    | ... | ...   | 010   | 85956 | ...   |
|         |  | 481700125969    | ... | ...   | 010   | 85956 | ...   |
| 12 - 19 | All Models with Hendrickson HMX 400/460 Haulmax<br>- with 16.5" Saddle | 60680-004       | ... | ...   | 01-   | 83143 | ...   |
|         |  | 60680-004L      | ... | ...   | 01-   | 83143 | ...   |
|         |  | 60680-005       | ... | ...   | 01-   | 83142 | ...   |
|         |  | 60680-005L      | ... | ...   | 01-   | 83142 | ...   |

**Additional O.E.M. Interchanges**

|  |  |              |     |       |       |     |       |
|--|--|--------------|-----|-------|-------|-----|-------|
|  | Models with 7000 lb Front Suspension                 | 10-13776-000 | 010 | 85005 | 89430 | ... | ...   |
|  | Models with Neway Air Suspension with shock stamping | 90045083     |     | ...   | ...   | 010 | 85910 |
|  | Models with O.E.M. Number                            | 10-12046-000 | 010 | 85320 | 89429 | ... | ...   |
|  |  | 10-12396-000 | 010 | 85918 | 89449 | ... | ...   |
|  |  | 10-12594-000 | 010 | 85984 | ...   | ... | ...   |
|  |  | 10-13051-001 | 010 | 85005 | 89430 | ... | ...   |
|  |  | 10-13859-000 | 010 | 85005 | 89430 | ... | ...   |

## APPLICATION GUIDE - TRUCKS, TRAILERS, AND BUSES

| Year<br>Año<br>Année | Model<br>Modelo<br>Modèle | OEM # | Front     |        | Rear      |        |
|----------------------|---------------------------|-------|-----------|--------|-----------|--------|
|                      |                           |       |           |        |           |        |
|                      |                           |       |           |        |           |        |
|                      |                           |       | Fleetline | GasSLX | Fleetline | GasSLX |

### FREIGHTLINER(Cont'd.)

#### Additional O.E.M. Interchanges(Cont'd.)

|                 |                                |              |              |                       |              |     |               |              |
|-----------------|--------------------------------|--------------|--------------|-----------------------|--------------|-----|---------------|--------------|
|                 | Models with O.E.M. Number      | 16-10688-000 |              | ...                   | ...          | OIO | <b>85042</b>  | ...          |
|                 |                                | 16-14577-000 | OIO          | <b>85043</b>          | ...          |     |               | ...          |
|                 |                                | 16-14667-000 |              | ...                   | ...          | OIO | <b>85005</b>  | <b>89430</b> |
|                 |                                | 16-14668-000 |              | ...                   | ...          | OIO | <b>83127</b>  | ...          |
|                 |                                | 16-14669-000 | OIO          | <b>G63403</b>         | ...          |     |               | ...          |
|                 |                                | 16-14759-000 | OIO          | <b>85000</b>          | <b>89436</b> |     |               | ...          |
|                 |                                | 16-15591-000 |              | ...                   | ...          | OIO | <b>85043</b>  | ...          |
|                 |                                | 16-16765-000 |              | ...                   | ...          | OIO | <b>85006</b>  | ...          |
|                 |                                | 16-16826-000 | OIO          | <b>85904</b>          | ...          |     |               | ...          |
|                 |                                | 16-17211-000 |              | ...                   | ...          | OIO | <b>85909</b>  | ...          |
|                 |                                | 16-17759-000 |              | ...                   | ...          | OIO | <b>85919</b>  | ...          |
|                 |                                | 16-19138-000 | OIO          | <b>85058</b>          | <b>89431</b> |     |               | ...          |
|                 |                                | 3638112      |              | ...                   | ...          | OIO | <b>G63183</b> | ...          |
|                 |                                | 4036892      | OIO          | <b>G63605</b>         | ...          |     |               | ...          |
|                 |                                | 47902-13     |              | ...                   | ...          | OIO | <b>83122</b>  | <b>89406</b> |
|                 |                                | 535228       | OIO          | <b>85302</b>          | <b>89420</b> |     |               | ...          |
|                 |                                | 61300224     | OIO          | <b>85918</b>          | <b>89449</b> |     |               | ...          |
|                 |                                | 61300240     | OIO          | <b>85918</b>          | <b>89449</b> |     |               | ...          |
|                 |                                | 650224       |              | ...                   | ...          | OIO | <b>83225</b>  | ...          |
|                 |                                | 651352       |              | ...                   | ...          | OIO | <b>85042</b>  | ...          |
|                 |                                | 654875       |              | ...                   | ...          | OIO | <b>83117</b>  | ...          |
|                 |                                | 654918       | OIO          | <b>83118</b>          | ...          |     |               | ...          |
|                 |                                | 659060       | OIO          | <b>85920</b>          | <b>89503</b> |     |               | ...          |
|                 |                                | 659062       |              | ...                   | ...          | -IO | <b>83134</b>  | ...          |
|                 |                                | 659063       |              | ...                   | ...          | -IO | <b>83134</b>  | ...          |
|                 |                                | 659300       | OIO          | <b>85005</b>          | <b>89430</b> |     |               | ...          |
|                 |                                | 660235       |              | ...                   | ...          | OIO | <b>85042</b>  | ...          |
|                 |                                | 665409       | -IO          | <b>85009</b>          | ...          |     |               | ...          |
|                 |                                | 671908       | OIO          | <b>85918</b>          | <b>89449</b> |     |               | ...          |
|                 |                                | 671945       | OIO          | <b>85920</b>          | <b>89503</b> |     |               | ...          |
|                 |                                | 671946       |              | ...                   | ...          | -IO | <b>85921</b>  | ...          |
|                 |                                | 680009       | OIO          | <b>85302</b>          | <b>89420</b> |     |               | ...          |
|                 |                                | 680442       |              | ...                   | ...          | -IO | <b>85319</b>  | <b>89428</b> |
|                 |                                | 680651       |              | ...                   | ...          | OIO | <b>85335</b>  | ...          |
|                 |                                | 680782       | OIO          | <b>85302</b>          | <b>89420</b> |     |               | ...          |
| 6813230900      | -IO                            | <b>85009</b> | ...          |                       |              | ... |               |              |
| 6813260200      |                                | ...          | ...          | OIO                   | <b>85011</b> | ... |               |              |
| 70042           | OIO                            | <b>85302</b> | <b>89420</b> |                       |              | ... |               |              |
| SDA471700000440 | OIO                            | <b>85959</b> | <b>89503</b> |                       |              | ... |               |              |
|                 | Additional O.E.M. Interchanges | 10-13205-000 | OIO          | <b>85918</b>          | <b>89449</b> |     | ...           | ...          |
|                 |                                | 471700131646 | OIO          | <b>85918</b>          | <b>89449</b> |     | ...           | ...          |
|                 |                                | 680008       | OIO          | <b>85300 or 89419</b> |              |     |               |              |
|                 |                                | 680017       | OIO          | <b>85302 or 89420</b> |              |     |               |              |
|                 |                                | 681-323-1100 | OIO          | <b>85301</b>          |              |     |               |              |

### FREIGHTLINER CAB SHOCKS





#### Argosy

|         |                           |              |     |              |
|---------|---------------------------|--------------|-----|--------------|
| 00 - 06 | Models with O.E.M. Number | 18-37813-000 | OIO | <b>83044</b> |
|---------|---------------------------|--------------|-----|--------------|

#### Cascadia

|         |   |              |     |              |
|---------|---|--------------|-----|--------------|
| 17 - 19 | Day Cab and Sleeper cabs w/OEM Number and 12 mm Top mounting bolt | 18-67845-000 | OIO | <b>83906</b> |
|         |   | 18-69674-000 | OIO | <b>83906</b> |
|         |   | 814903012666 | OIO | <b>83906</b> |
|         |   | 814903015188 | OIO | <b>83906</b> |
| 09 - 17 | Models with 72" High-Roof Sleeper and 1/2" Top mounting bolt      | 18-41762-000 | OIO | <b>83038</b> |

**APPLICATION GUIDE - TRUCKS, TRAILERS, AND BUSES**

| Year<br>Año<br>Année | Model<br>Modelo<br>Modèle | OEM # | Front   |  | Rear  |   |
|----------------------|---------------------------|-------|---|--|---|---|
|                      |                           |       |  |  |  |  |
|                      |                           |       | Fleetline   | GasSLX   | Fleetline   | GasSLX  |

**FREIGHTLINER CAB SHOCKS(Cont'd.)**

**Cascadia(Cont'd.)**

|         |  |              |     |       |
|---------|--|--------------|-----|-------|
| 09 - 17 | Models with 72" High-Roof Sleeper and 1/2" Top mounting bolt | 18-60764-000 | 010 | 83038 |
|         |  | 814903003528 | 010 | 83038 |

**Century Class**

|  |  |              |     |       |
|--|--|--------------|-----|-------|
|  | Day Cab Suspensions with O.E.M. Number | 18-32999-001 | 010 | 83006 |
|  | Models with O.E.M. Number              | 18-41762-000 | 010 | 83038 |
|  |  | 18-41762-001 | 010 | 83047 |
|  |  | 18-41762-002 | 010 | 83038 |
|  | Sleeper-Cabs with O.E. Number          | 18-30378-000 | 010 | 83001 |
|  |  | 18-32999-000 | 010 | 83001 |

**Classic**

|  |                           |              |     |       |
|--|---------------------------|--------------|-----|-------|
|  | Models with O.E.M. Number | 18-29846-000 | 010 | 83009 |
|--|---------------------------|--------------|-----|-------|

**Columbia**

|         |   |              |     |       |
|---------|---|--------------|-----|-------|
|         | Models with O.E.M. Number                 | 18-29846-000 | 010 | 83009 |
| 03 - 17 | Models with Sleeper Cabs w/O.E.M. Numbers | 18-41762-000 | 010 | 83038 |
|         |   | 18-60764-000 | 010 | 83038 |
|         |   | 814903003528 | 010 | 83038 |
| 17 - 18 | Models with Sleeper Cabs w/O.E.M. Numbers | 18-69674-000 | 010 | 83906 |
|         |   | 814903015188 | 010 | 83906 |

**Coronado**

|         |   |              |     |       |
|---------|---|--------------|-----|-------|
| 17 - 19 | Day Cab and Sleeper Cabs w/O.E.M. Numbers | 18-69674-000 | 010 | 83906 |
|         |   | 814903015188 | 010 | 83906 |
| 10 - 17 | Models with Sleeper Cabs w/O.E.M. Numbers | 18-41762-000 | 010 | 83038 |
|         |   | 18-41762-002 | 010 | 83038 |
|         |   | 18-60764-000 | 010 | 83038 |
|         |   | 18-60765-002 | 010 | 83038 |
|         |   | 814903003528 | 010 | 83038 |

**FL 60, 70, 80 & 106 Series - Business Class Conventional**

|        |   |           |     |       |
|--------|---|-----------|-----|-------|
|        | Models with O.E.M. Number   | 18-30378  | 010 | 83006 |
| 1991 - | Trucks with Link Cabmate Models FRT153BC-A , FRT106BC or FRT106HD-A | 1201-0054 | 010 | 83021 |
|        |   | 1202-0054 | 010 | 83021 |

**FL112 Conventional**

|        |  |           |     |       |
|--------|--|-----------|-----|-------|
| 1997 - | FL112 Business Class Day Cab Tractors with Link Cabmate Model FRT112DC | 1202-1044 | 010 | 83025 |
|--------|--|-----------|-----|-------|

**FLA - COE Truck & Tractors**

|        |   |                           |               |       |
|--------|---|---------------------------|---------------|-------|
| 1989 - | Cabover Tractors with 86", 96" & 104" Cabs with Link Cabmate Model FRT285 | 1202-0032                 | 010           | 83016 |
|        |   | Models with O.E.M. Number | 681-891-02-05 | 010   |

**FLB - COE Truck & Tractors**

|        |   |   |           |       |
|--------|---|---|-----------|-------|
| 1993 - | 90", 100", & 110" Cabs with Link Cabmate Models FRT46-2P-A or FRT46-2P-B  | 1201-0054   | 010       | 83021 |
| 1984 - | Cabover Tractors with 86", 96" & 104" Cabs with Link Cabmate Model FRT285 | 1202-0032   | 010       | 83016 |
|        |   | Cabover Tractors with the rear cab mounts having a center to center measurement of 50" or 54" & with Link Cabmate Models FRT50-2P-C | 1202-0054 | 010   |





**FLC - 112 & 120 Conventional Tractors**

|         |   |           |     |       |
|---------|---|-----------|-----|-------|
| 1989 -  | Conventional Tractors with Link Cabmate Model FRTE120-A                     | 1201-1043 | 010 | 83025 |
|         |   | 1202-1043 | 010 | 83025 |
| 1997 -  | FL112 Models Business Class Day Cab Models with Link Cabmate Model FRT112DC | 1201-1044 | 010 | 83025 |
| - 03/88 | Models with Link Cabmate FRTC120-A or FRTC120-AW Air Suspension             | 1201-0012 | 010 | 83023 |
|         |   | 1202-0012 | 010 | 83023 |

**FLD 112 & 120 Conventional Truck & Tractor**

|  |                                 |              |     |       |
|--|---------------------------------|--------------|-----|-------|
|  | FLD Sleeper with Air Suspension | 18-29846-000 | 010 | 83009 |
|--|---------------------------------|--------------|-----|-------|

**APPLICATION GUIDE - TRUCKS, TRAILERS, AND BUSES**

| Year<br>Año<br>Année | Model<br>Modelo<br>Modèle | OEM # | Front   |   | Rear  |   |
|----------------------|---------------------------|-------|---|---|---|---|
|                      |                           |       |  |  |  |  |
|                      |                           |       | Fleetline   | GasSLX  | Fleetline   | GasSLX  |

**FREIGHTLINER CAB SHOCKS(Cont'd.)**

**FLD Series - 112 & 120 Conventional Truck & Tractor(Cont'd.)**

|         |  |              |     |       |
|---------|--|--------------|-----|-------|
| 09/93 - | 64" Able Body Sleepers with Link Bunkmate Models FRTA64 or FRTAS64-A | 1202-1044    | 010 | 83025 |
| 1989 -  | Conventional Tractors with Link Cabmate Model FRTE120-A              | 1202-1043    | 010 | 83025 |
|         | D2 Cab   | 18-41762-001 | 010 | 83047 |
|         |  | 18-60765-001 | 010 | 83047 |
|         |  | 814903003486 | 010 | 83047 |
| 01 - 12 | FLD Sleeper with Air Suspension                                      | 18-29846-001 | 010 | 83064 |
|         | FLD112 Daycab with Air Suspension                                    | 18-31476-000 | 010 | 83020 |

**M2 - Business Class**

|         |  |              |     |       |
|---------|--|--------------|-----|-------|
| 03 - 10 | Crew Cab Models with O.E.M. Number                 | 18-43504-000 | 010 | 83057 |
|         |  | 18-60768-000 | 010 | 83057 |
|         |  | 814903003484 | 010 | 83057 |
| 02 - 19 | M2-106 Models with Spring Suspension               | 18-47350-000 | 010 | 83040 |
|         |  | 18-60766-000 | 010 | 83040 |
|         |  | 814903003482 | 010 | 83040 |
| 03 - 16 | M2-112 Crew Cab Models with O.E.M. Number          | 18-41762-000 | 010 | 83038 |
|         |  | 18-60764-000 | 010 | 83038 |
|         |  | 814903003528 | 010 | 83038 |
| 03 - 18 | M2-112 Day Cab Models with Leaf Spring Suspensions | 18-47349-000 | 010 | 83039 |
|         |  | 18-60767-000 | 010 | 83039 |
|         |  | 814903003483 | 010 | 83039 |

**Severe Duty Series - 108SD, 114SD & 122SD**

|         |   |              |     |       |
|---------|---|--------------|-----|-------|
| 12 - 19 | 108 SD Models with O.E.M. Number          | 18-60766-000 | 010 | 83040 |
|         |   | 814903003482 | 010 | 83040 |
| 12 - 19 | 114 SD Models with O.E.M. Number          | 18-60766-000 | 010 | 83040 |
|         |   | 814903003482 | 010 | 83040 |
| 12 - 16 | 122 SD Crew Cab Models with O.E.M. Number | 18-60764-000 | 010 | 83038 |
|         |   | 814903003528 | 010 | 83038 |
| 17 - 18 | Models with O.E.M. Numbers                | 18-69674-000 | 010 | 83906 |
|         |   | 814903015188 | 010 | 83906 |

**Additional Applications**

|  |   |              |     |       |
|--|---|--------------|-----|-------|
|  | Models with 60" Sleeper w/ Link Bunkmate Model FRTS60-A | 1202-1043    | 010 | 83025 |
|  | Models with Link Cab Suspension                         | 1202-0042    | 010 | 83025 |
|  |   | 1202-0043    | 010 | 83032 |
|  |   | 1202-0044    | 010 | 83025 |
|  | Models with O.E.M. Number                               | 18-42613-000 | 010 | 83033 |
|  |   | 18-44321-000 | 010 | 83009 |
|  |   | 18-45067-000 | 010 | 83034 |
|  |   | 18-60295-000 | 010 | 83006 |
|  |   | 18-60765-000 | 010 | 83038 |
|  |   | 18-60769-000 | 010 | 83009 |
|  |   | 18-60772-000 | 010 | 83026 |
|  |   | 18-60773-000 | 01- | 83027 |
|  |   | 654739       | 010 | 83009 |
|  |   | 654819       | 010 | 83001 |
|  |   | 654831       | 010 | 83006 |
|  |   | 654841       | 010 | 83020 |
|  |   | 654990       | 010 | 83038 |
|  |   | 659079       | 010 | 83040 |
|  |   | 659080       | 010 | 83039 |
|  |   | 659125       | 010 | 83047 |
|  |   | 659178       | 010 | 83038 |
|  |   | 659288       | 010 | 83006 |
|  |   | 814903003496 | 010 | 83009 |
|  |   | GBL 650361   | 010 | 83017 |

## APPLICATION GUIDE - TRUCKS, TRAILERS, AND BUSES









| Year<br>Año<br>Année | Model<br>Modelo<br>Modèle | OEM # | Front         |            | Rear          |            |
|----------------------|---------------------------|-------|---------------|------------|---------------|------------|
|                      |                           |       | <br>Fleetline | <br>GasSLX | <br>Fleetline | <br>GasSLX |

### FREIGHTLINER CUSTOM CHASSIS

|                |   |              |     |              |              |     |              |              |
|----------------|---|--------------|-----|--------------|--------------|-----|--------------|--------------|
| <b>06 - 18</b> | B2 Bus Chassis  | 10-13211-000 | 010 | <b>85918</b> | <b>89449</b> |     | ...          | ...          |
|                |   | 10-13634-000 | 010 | <b>85918</b> | <b>89449</b> |     | ...          | ...          |
| <b>06 - 18</b> | B2 Bus Chassis With FAS II Rear Air Suspension                          | 16-15817-000 |     | ...          | ...          | 010 | <b>85724</b> | <b>89443</b> |
|                |   | 16-18708-000 |     | ...          | ...          | 010 | <b>85724</b> | <b>89443</b> |
|                | F65 School bus chassis with 10,000 to 18,000 lb Suspension              | 10-13759-000 | 010 | <b>85006</b> | ...          |     | ...          | ...          |
|                |   | 47170003009  | 010 | <b>85006</b> | ...          |     | ...          | ...          |
|                |   | 6803230300   | 010 | <b>85006</b> | ...          |     | ...          | ...          |
|                |   | GBL665538    | 010 | <b>85006</b> | ...          |     | ...          | ...          |
|                | F65 School bus chassis with Taperleaf Spring                            | 6803260000   |     | ...          | ...          | 01- | <b>83120</b> | ...          |
|                |   | GBL654725    |     | ...          | ...          | 01- | <b>83120</b> | ...          |
|                | FB 65 Models with O.E.M. Number   | 10-13358-000 | 010 | <b>85097</b> | ...          |     | ...          | ...          |
|                | FB Shuttle bus chassis with O.E.M. Number                               | 16-16765-000 | 010 | <b>85006</b> | ...          |     | ...          | ...          |
|                |   | 471700131775 | 010 | <b>85006</b> | ...          |     | ...          | ...          |
|                | FedEx Trucks with O.E.M. Number   | MAE16950     | 010 | <b>83118</b> | ...          |     | ...          | ...          |
|                |   | P117146      | 010 | <b>83118</b> | ...          |     | ...          | ...          |
|                | Fleetwood Motor Home with O.E.M. Number                                 | GBL 651375   | 010 | <b>83119</b> | ...          |     | ...          | ...          |
|                |   | RW24285      | 010 | <b>83119</b> | ...          |     | ...          | ...          |
| <b>06 - 08</b> | Front - Engine Diesel Chassis (FRED Chassis)                            | 16-18095-000 |     | ...          | ...          | 01- | <b>85092</b> | ...          |
|                |   | 16-18455-000 | 010 | <b>85918</b> | <b>89449</b> |     | ...          | ...          |
|                |   | 471700000467 |     | ...          | ...          | 01- | <b>85092</b> | ...          |
|                |   | 471700002726 | 010 | <b>85918</b> | <b>89449</b> |     | ...          | ...          |
|                | MB Chassis (VIP bus)  | 16-16827-000 |     | ...          | ...          | 010 | <b>85331</b> | ...          |
|                |   | 16-17760-000 |     | ...          | ...          | 010 | <b>85331</b> | ...          |
|                |   | 471700131778 |     | ...          | ...          | 010 | <b>85331</b> | ...          |
|                | MB55 & MT55 Models  | 16-17684-000 | 010 | <b>85058</b> | <b>89431</b> |     | ...          | ...          |
|                | MB55 Chassis  | 16-17759-000 | 010 | <b>85919</b> | ...          |     | ...          | ...          |
|                |   | 471700000447 | 010 | <b>85919</b> | ...          |     | ...          | ...          |
|                | MB55 Shuttle bus w/8000 lb. flat leaf front suspension                  | 16-15676-000 | 010 | <b>85058</b> | <b>89431</b> |     | ...          | ...          |
| <b>96 - 99</b> | MC Chassis for Class A Motorhomes                                       | 654918       | 010 | <b>83118</b> | ...          |     | ...          | ...          |
|                |   | P117099      |     | ...          | ...          | 01- | <b>83120</b> | ...          |
|                |   | P117146      | 010 | <b>83118</b> | ...          |     | ...          | ...          |
|                | MC Chassis with Hendrickson Softek Front Suspension                     | 16-18094-000 | 010 | <b>85959</b> | ...          |     | ...          | ...          |
|                |   | 471700000466 | 010 | <b>85959</b> | ...          |     | ...          | ...          |
|                | MC Chassis with O.E.M. Number   | 16-18456-000 |     | ...          | ...          | 010 | <b>85959</b> | ...          |
|                |   | 471700002727 |     | ...          | ...          | 010 | <b>85959</b> | ...          |
|                | MC-L Chassis with 9,000 lb Suspension                                   | 16-18455-000 | 010 | <b>85918</b> | <b>89449</b> |     | ...          | ...          |
|                |   | 471700002726 | 010 | <b>85918</b> | <b>89449</b> |     | ...          | ...          |
|                | M-Line Walk in Van with O.E.M. Number                                   | MAE 16949    |     | ...          | ...          | 01- | <b>83120</b> | ...          |
|                |   | MAE 16950    | 010 | <b>83118</b> | ...          |     | ...          | ...          |
|                |   | P117099      |     | ...          | ...          | 01- | <b>83120</b> | ...          |
|                |   | P117146      | 010 | <b>83118</b> | ...          |     | ...          | ...          |
| <b>- 2018</b>  | Models with B2 Bus Chassis & 15000 lb Rear Suspension                   | 6803260000   |     | ...          | ...          | 01- | <b>83120</b> | ...          |
|                | Motor Homes with O.E.M. Number  | P116168      |     | ...          | ...          | 010 | <b>83117</b> | ...          |
|                | MP 14 and MP 19 Chassis   | 16-15475-000 | 010 | <b>83164</b> | ...          |     | ...          | ...          |
|                | MP14 and 19 (UPS)   | P117253      | 010 | <b>83116</b> | ...          |     | ...          | ...          |
|                | MT135   | GBL654875    |     | ...          | ...          | 010 | <b>83117</b> | ...          |
|                | MT45 Step Van   | 16-15064-000 |     | ...          | ...          | 01- | <b>83154</b> | ...          |
|                | MT45 Step Van<br>- Rear<br>- w/35" Front Spring<br>- w/38" Front Spring | 16-15394-000 |     | ...          | ...          | 01- | <b>83120</b> | ...          |
|                |   | 16-15473-000 | 010 | <b>83157</b> | ...          |     | ...          | ...          |
|                |   | 16-15474-000 | 010 | <b>83157</b> | ...          |     | ...          | ...          |
|                |   | 16-15089-000 | 010 | <b>83164</b> | ...          |     | ...          | ...          |
|                | MT55 Step Van   | 16-15436-000 |     | ...          | ...          | 01- | <b>83154</b> | ...          |
|                |   | 16-15705-000 |     | ...          | ...          | 01- | <b>83120</b> | ...          |
|                |   | 16-15934-000 |     | ...          | ...          | 01- | <b>83120</b> | ...          |











**APPLICATION GUIDE - TRUCKS, TRAILERS, AND BUSES**

| Year<br>Año<br>Année | Model<br>Modelo<br>Modèle | OEM # | Front   |   | Rear  |   |
|----------------------|---------------------------|-------|---|---|---|---|
|                      |                           |       |  |  |  |  |
|                      |                           |       |  |  |  |  |
|                      |                           |       | Fleetline   | GasSLX  | Fleetline   | GasSLX  |

**FREIGHTLINER CUSTOM CHASSIS(Cont'd.)**

|         |   |              |     |       |       |     |       |     |
|---------|---|--------------|-----|-------|-------|-----|-------|-----|
|         | MT55 Step Van   | 16-16262-000 |     | ...   | ...   | 01- | 83120 | ... |
|         |   | 16-16542-000 |     | ...   | ...   | 01- | 83154 | ... |
|         | MT55 Step Van<br>- w/35" Front Spring                                       | 16-15473-000 | 010 | 83157 | ...   |     | ...   | ... |
|         |   | 16-15474-000 | 010 | 83157 | ...   |     | ...   | ... |
|         | - w/38" Front Spring  | 16-15089-000 | 010 | 83164 | ...   |     | ...   | ... |
|         | MT55 Utility Van w/8000 lb. flat leaf front suspension                      | 16-15676-000 | 010 | 85058 | 89431 |     | ...   | ... |
|         | Oshkosh Motor Home with O.E.M. Number                                       | 1398980      |     | 83127 | ...   | 010 | 83127 | ... |
|         |   | GBL654875    |     | ...   | ...   | 010 | 83117 | ... |
|         | School Bus Chassis with 7,000 lb Suspension                                 | 10-13859-000 | 010 | 85005 | 89430 |     | ...   | ... |
|         |   | 471700005079 | 010 | 85005 | 89430 |     | ...   | ... |
|         | Shuttle Bus Chassis   | 16-16082-000 | 010 | 85043 | ...   |     | ...   | ... |
|         | Step Van and Motorhome chassis with O.E.M. Number                           | 16-15475-000 | 010 | 83164 | ...   |     | ...   | ... |
|         | Step Van Models with O.E.M. Number  | 16-19138-000 | 010 | 85058 | 89431 |     | ...   | ... |
|         |   | 471700003011 | 010 | 85058 | 89431 |     | ...   | ... |
| 09-12   | Type C School bus chassis with O.E.M. Number                                | 16-18713-000 |     | ...   | ...   | 01- | 85122 | ... |
|         |   | 471700003070 |     | ...   | ...   | 01- | 85122 | ... |
| 03 - 07 | VC Chassis  |              |     |       |       |     |       |     |
|         | ADL200 Suspension w/ 20K Rear   | 16-16873-000 |     | ...   | ...   | 010 | 85029 | ... |
|         |   | 471700131974 |     | ...   | ...   | 010 | 85029 | ... |
|         | Rear Shock with O.E.M. Number   | 141700131809 |     | ...   | ...   | 010 | 85029 | ... |
|         |   | 16-16736-000 |     | ...   | ...   | 010 | 85029 | ... |
|         | ZF - IFS Front Suspension with 23,000 lb GVW or Greater                     | 16-18103-000 | -1- | 85900 | ...   |     | ...   | ... |
|         |   | 481700000493 | -1- | 85900 | ...   |     | ...   | ... |
| 93 - 07 | VC Chassis (Up To 22000 lb GVW)   |              |     |       |       |     |       |     |
|         | AS120 Front Suspension  | 16-16737-000 | 010 | 83160 | ...   |     | ...   | ... |
|         | XC & XB MotorHome Chassis with Neway AS-120, 10,500 lb Front Air Suspension | 141700000377 | 010 | 83174 | ...   |     | ...   | ... |
|         |   | 16-18075-000 | 010 | 83174 | ...   |     | ...   | ... |
|         | XC & XB MotorHome Chassis with Neway AS-120, 12,000 lb Front Air Suspension | 141700000378 | 010 | 83160 | ...   |     | ...   | ... |
|         |   | 141700131975 | 010 | 83160 | ...   |     | ...   | ... |
|         |   | 16-16874-000 | 010 | 83160 | ...   |     | ...   | ... |
|         |   | 16-18076-000 | 010 | 83160 | ...   |     | ...   | ... |
| 03 - 07 | XC Chassis  |              |     |       |       |     |       |     |
|         | ADL200 Suspension w/ 20K Rear   | 16-16873-000 |     | ...   | ...   | 010 | 85029 | ... |
|         | AS120 Front Suspension  | 141700131810 | 010 | 83160 | ...   |     | ...   | ... |
|         |   | 16-16737-000 | 010 | 83160 | ...   |     | ...   | ... |
|         |   | 16-16874-000 | 010 | 83160 | ...   |     | ...   | ... |
|         | Rear Shock with O.E.M. Number   | 141700131809 |     | ...   | ...   | 010 | 85029 | ... |
|         |   | 16-16736-000 |     | ...   | ...   | 010 | 85029 | ... |
|         | ZF - IFS Front Suspension with 23,000 lb GVW or Greater                     | 16-18103-000 | -1- | 85900 | ...   |     | ...   | ... |
|         |   | 481700000493 | -1- | 85900 | ...   |     | ...   | ... |
| 93 - 07 | XC Chassis (Up To 22000 lb GVW)   |              |     |       |       |     |       |     |
|         | AS120 Front Suspension  | 16-16737-000 | 010 | 83160 | ...   |     | ...   | ... |
|         | XC MotorHome Chassis with ZF- IFS, 12,000 lb Front Air Suspension           | 16-17144-000 | -1- | 85900 | ...   |     | ...   | ... |
|         |   | 16-17361-000 | -1- | 85900 | ...   |     | ...   | ... |
|         |   | 481700000477 | -1- | 85900 | ...   |     | ...   | ... |
|         |   | 481700131919 | -1- | 85900 | ...   |     | ...   | ... |
| 00 - 02 | XCS Chassis (22000 lb GVW) w/ O.E.M. Number                                 | 16-15592-000 | 01- | 83154 | ...   |     | ...   | ... |
|         |   | 16-15755-000 | 010 | 85043 | ...   |     | ...   | ... |
|         |   | 16-16043-000 | 010 | 85043 | ...   |     | ...   | ... |
| 01 - 02 | XCS Chassis with Freightliner Rear Air Suspension                           | 16-16093-000 | 010 | 83160 | ...   |     | ...   | ... |
|         | Models with O.E.M. Number   | 16-14794-000 |     | ...   | ...   | 01- | 83154 | ... |
|         |   | 16-16083-000 |     | ...   | ...   | 010 | 85331 | ... |

## APPLICATION GUIDE - TRUCKS, TRAILERS, AND BUSES

| Year<br>Año<br>Année | Model<br>Modelo<br>Modèle | OEM # | Front  |   | Rear   |   |
|----------------------|---------------------------|-------|--|---|--|---|
|                      |                           |       |  |  |  |  |
|                      |                           |       |   |  |   |  |
|                      |                           |       | Fleetline  | GasSLX  | Fleetline  | GasSLX  |

### FREIGHTLINER CUSTOM CHASSIS(Cont'd.)

|                                |              |     |       |       |     |       |     |
|--------------------------------|--------------|-----|-------|-------|-----|-------|-----|
| Models with O.E.M. Number      | 16-16836-000 |     | ...   | ...   | O1- | 83154 | ... |
|                                | 654953       | O1O | 85058 | 89431 |     | ...   | ... |
|                                | 659227       | O1O | 85058 | 89431 |     | ...   | ... |
|                                | GBL 654870   | O1O | 83116 | ...   |     | ...   | ... |
|                                | GBL654918    | O1O | 83118 | ...   |     | ...   | ... |
| Additional O.E.M. Interchanges | 1745500      | O1O | 89430 |       |     |       |     |
|                                | 659104       | O1O | 85097 |       |     |       |     |
|                                | 66554540I    | O1O | 89430 |       |     |       |     |
| Models with O.E.M. Number      | 16-15805-000 |     | ...   | ...   | O1- | 83120 | ... |

### FRUEHAUF

|   |                |  |     |     |     |       |       |
|---|----------------|--|-----|-----|-----|-------|-------|
| "L" Suspensions                                     | UCD-006216-001 |  | ... | ... | O1O | 83203 | 89436 |
| "T" Suspensions                                     | UCE-1295-901   |  | ... | ... | O1O | 85300 | 89419 |
| "T" Suspensions With Drop Frame ( NT Construction ) | UCF-8339-001   |  | ... | ... | O1O | 85321 | ...   |
|   | UCF-8339-002   |  | ... | ... | O1O | 85321 | ...   |
| All with Air Suspension and O.E.M. Number           | UCE-1295-1     |  | ... | ... | O1O | 85300 | 89419 |
| All with Lift Axle                                  | UCE-9399-1     |  | ... | ... | O1O | 83122 | 89406 |
| Model "T" Low Mount with 48 ft drop-deck trailer    | .....          |  | ... | ... | O1O | 85327 | ...   |
| Model UCA-5431                                      | 5352858        |  | ... | ... | O1O | 85305 | ...   |
| Model W24T1 Air Ride                                | UCE-2983-000   |  | ... | ... | O1O | 85322 | ...   |
|   | UCE-2983-001   |  | ... | ... | O1O | 85322 | ...   |
| Tractor & Trailer Lift Axle with O.E.M. Number      | 5116-117       |  | ... | ... | O1O | 83122 | 89406 |
| Models with O.E.M. Number                           | 144-5910       |  | ... | ... | O1O | 85300 | 89419 |
|   | 680117         |  | ... | ... | O1O | 85300 | 89419 |
|   | 680298         |  | ... | ... | O1O | 85321 | ...   |
|   | UCA-01113      |  | ... | ... | O1O | 85304 | ...   |
|   | UCA-5431       |  | ... | ... | O1O | 85305 | ...   |
|   | UCD-6216-1     |  | ... | ... | O1O | 83203 | 89436 |
|   | UCE-2983-1     |  | ... | ... | O1O | 85322 | ...   |
|   | UEY 1124-001   |  | ... | ... | O1O | 85030 | 89440 |

### FWD TRUCK

|                           |        |  |     |       |       |     |     |
|---------------------------|--------|--|-----|-------|-------|-----|-----|
| Models with O.E.M. Number | 450739 |  | O1O | 85302 | 89420 | ... | ... |
|---------------------------|--------|--|-----|-------|-------|-----|-----|

### GENERAL TRAILER CO

|                                |       |  |     |       |     |       |     |
|--------------------------------|-------|--|-----|-------|-----|-------|-----|
| Models with Air Suspension     | 120-1 |  | ... | ...   | O1O | 83125 | ... |
| Additional O.E.M. Interchanges | 12608 |  | O1O | 83125 |     |       |     |





### GEORGIE BOY MANUFACTURING

|  |                |  |     |       |       |     |     |
|--|----------------|--|-----|-------|-------|-----|-----|
| Models with Workhorse UFO Chassis with Hendrickson Softek Front Suspension | 66153-002      |  | O1O | 83124 | 89407 | ... | ... |
|  | F4-BE5-C832-MO |  | O1O | 83124 | 89407 | ... | ... |

### Class A MotorHomes

|         |   |               |  |     |       |       |     |       |       |
|---------|---|---------------|--|-----|-------|-------|-----|-------|-------|
| 99 - 09 | All Series MotorHomes with Ford F53 Chassis with 16,000 lb GVW to 22,000 lb GVW | 1C34-18045-AA |  | O1O | 83209 | 89414 | ... | ...   |       |
|         |   | 1C34-18045-JA |  | O1O | 83209 | 89414 | ... | ...   |       |
|         |   | 9U94-18045-AA |  | O1O | 83209 | 89414 | ... | ...   |       |
|         |   | 9U94-18080-AA |  | O1O | ...   | ...   | O1O | 83122 | 89406 |
|         |   | 9U9Z-18124-A  |  | O1O | 83209 | 89414 |     | ...   | ...   |
|         |   | 9U9Z-18125-A  |  | O1O | ...   | ...   | O1O | 83122 | 89406 |
|         |   | ASH-1022      |  | O1O | 83209 | 89414 |     | ...   | ...   |
|         |   | ASH-1023      |  | O1O | ...   | ...   | O1O | 83122 | 89406 |
|         |   | ASH-1205      |  | O1O | 83209 | 89414 |     | ...   | ...   |
|         |   | ASH-1206      |  | O1O | ...   | ...   | O1O | 83122 | 89406 |
|         |   | ASH-1228      |  | O1O | 83209 | 89414 |     | ...   | ...   |
|         |   | ASH-1229      |  | O1O | 83209 | 89414 |     | ...   | ...   |

**APPLICATION GUIDE - TRUCKS, TRAILERS, AND BUSES**

| Year<br>Año<br>Année | Model<br>Modelo<br>Modèle | OEM # | Front   |   | Rear  |   |
|----------------------|---------------------------|-------|---|---|---|---|
|                      |                           |       |  |  |  |  |
|                      |                           |       | Fleetline   | GasSLX  | Fleetline   | GasSLX  |

**GEORGIE BOY MANUFACTURING(Cont'd.)**

**Class A MotorHomes(Cont'd.)**

|         |   |           |     |       |       |     |       |       |
|---------|---|-----------|-----|-------|-------|-----|-------|-------|
| 99 - 09 | All Series MotorHomes with Ford F53 Chassis with 16,000 lb GVW to 22,000 lb GVW | ASH-1230  |     | ...   | ...   | 010 | 83122 | 89406 |
|         |   | ASH-137   |     | ...   | ...   | 010 | 83122 | 89406 |
|         |   | ASH-25822 | 010 | 83209 | 89414 |     | ...   | ...   |
|         |   | ASH-25823 | 010 | 83209 | 89414 |     | ...   | ...   |
|         |   | ASH-25824 |     | ...   | ...   | 010 | 83122 | 89406 |
|         |   | ASH-294   | 010 | 83209 | 89414 |     | ...   | ...   |
|         |   | AT-620    | 010 | 83209 | 89414 |     | ...   | ...   |
|         |   | AT-621    |     | ...   | ...   | 010 | 83122 | 89406 |
|         |   | AT-766    | 010 | 83209 | 89414 |     | ...   | ...   |

**Class C MotorHomes**

|         |   |          |     |       |     |     |       |     |
|---------|---|----------|-----|-------|-----|-----|-------|-----|
| 99 - 09 | Maverick Series MotorHomes with Ford E450 Chassis | ASH-1136 |     | ...   | ... | -10 | 83178 | ... |
|         |   | ASH-1154 | -10 | 83177 | ... |     | ...   | ... |

**GILLIG BROS.**





|         |   |                 |     |       |     |     |                |       |
|---------|---|-----------------|-----|-------|-----|-----|----------------|-------|
|         | Models with Neway Air Suspension with shock stamping                        | 90045084        |     | ...   | ... | 010 | 85968          | ...   |
|         | Models with Neway ARD-234 Models Truck & Tractor Air Suspension (ARD-234-6) | 90044046        |     | ...   | ... | 010 | 83123          | 89405 |
|         | Phantom Models (30 Foot) with O.E.M. Number                                 | 90-2164 SP1     | 01- | 85723 | ... |     | ...            | ...   |
| 00 - 11 | Phantom Models with O.E.M. Number   | 90-2627         |     | ...   | ... | 010 | ...            | 89461 |
|         | School Bus w/1" Mounting Pins   | 200-171         |     | 85304 | ... | 010 | 85304          | ...   |
|         |   | 53-176          |     | 85304 | ... | 010 | 85304          | ...   |
|         | School Bus w/3/4" Mounting Pins   | 57113           | 010 | 83219 | ... |     | ...            | ...   |
|         |   | 57131           |     | ...   | ... | 010 | 83216          | ...   |
|         | Transit Bus, Phantom 55, 40, TB40   | 53-14010        |     | ...   | ... | -1- | 85318          | ...   |
|         |   | 53-24685        | 01- | 85723 | ... |     | ...            | ...   |
|         |   | 695110          |     | ...   | ... | -1- | 85318          | ...   |
|         |   | 90F-1912        |     | ...   | ... | -1- | 85318          | ...   |
|         | Models with O.E.M. Number   | 1583470         |     | ...   | ... | 010 | 85051          | ...   |
|         |   | 695109          | 01- | 85723 | ... |     | ...            | ...   |
|         |   | 82-01878        |     | 83122 | ... | 010 | 83122          | 89406 |
|         |   | 90044683        |     | ...   | ... | 010 | 83122          | 89406 |
|         |   | 90044769        |     | ...   | ... | 010 | 83207          | 89407 |
|         |   | 90044770        |     | ...   | ... | 010 | 83207          | 89407 |
|         |   | 90-1951-SP1     |     | ...   | ... | 010 | 85734          | ...   |
|         |   | 90-1968         | 010 | 85712 | ... |     | ...            | ...   |
|         |   | 90-2423         | 01- | 85723 | ... |     | ...            | ...   |
|         |   | H53-02132-14005 | 01- | 85723 | ... |     | ...            | ...   |
|         |   | H53-20415-006   |     | ...   | ... | 010 | 85051          | ...   |
|         |   | MR6394          | 01- | 85723 | ... |     | ...            | ...   |
|         | Additional O.E.M. Interchanges  | 53-02132        | 01- |       |     |     | 85723          |       |
|         |   | 53-02133-000    | -1- |       |     |     | 85318          |       |
|         |   | 53-13952-000    | -1- |       |     |     | 85722          |       |
|         |   | 53-14005-000    | 01- |       |     |     | 85723          |       |
|         |   | 665568          | 010 |       |     |     | 85051          |       |
|         |   | 680009          | 010 |       |     |     | 85302 or 89420 |       |
|         |   | 680333          | -1- |       |     |     | 85708          |       |
|         |   | 70034           | 010 |       |     |     | 85302 or 89420 |       |
|         |   | 82-21542-000    | 010 |       |     |     | 85716          |       |
|         |   | 82-30159-000    | -1- |       |     |     | 85708          |       |
|         |   | 90-1908         | 01- |       |     |     | 85723          |       |

**GLAVAL BUS CO.**

**Concorde II - Series**

|         |   |           |     |       |     |  |     |     |
|---------|---|-----------|-----|-------|-----|--|-----|-----|
| 00 - 15 | Models with F-650 chassis with 10,000 lb Front Suspension | 3584116C1 | 010 | 83175 | ... |  | ... | ... |
|---------|---|-----------|-----|-------|-----|--|-----|-----|

## APPLICATION GUIDE - TRUCKS, TRAILERS, AND BUSES

| Year<br>Año<br>Année | Model<br>Modelo<br>Modèle | OEM # | Front  |   | Rear   |   |
|----------------------|---------------------------|-------|--|---|--|---|
|                      |                           |       |  |  |  |  |
|                      |                           |       | Fleetline  | GasSLX  | Fleetline  | GasSLX  |

### GLAVAL BUS CO.(Cont'd.)

#### Concorde II - Series(Cont'd.)

|                |   |   |     |       |     |       |     |
|----------------|---|---|-----|-------|-----|-------|-----|
| 00 - 15        | Models with F-650 chassis with 10,000 lb Front Suspension                         | 3584116C2<br>4C4Z-18124-QA<br>AA-616  | 010 | 83175 | ... | ...   | ... |
|                |   |   | 010 | 83175 | ... | ...   | ... |
|                |   |   | 010 | 83175 | ... | ...   | ... |
| 00 - 15        | Models with F-650 chassis with 12,000 & 13,200 lb Front Springs                   | 3584118C2<br>4C4Z-18124-JB<br>4C4Z-18124-RA<br>AA-617<br>AT-812                         | 010 | 85928 | ... | ...   | ... |
|                |   |   | 010 | 85928 | ... | ...   | ... |
|                |   |   | 010 | 85928 | ... | ...   | ... |
|                |   |   | 010 | 85928 | ... | ...   | ... |
|                |   |   | 010 | 85928 | ... | ...   | ... |
| July/2015 - 19 | Models with F-650 chassis with 13,500, 15,500 & 19,000 lb Multi-leaf Rear Springs | 471700011531<br>ASH-24660<br>FC44-18080-AB<br>FC4Z-18125-A                              | ... | ...   | 010 | 85180 | ... |
|                |   |   | ... | ...   | 010 | 85180 | ... |
|                |   |   | ... | ...   | 010 | 85180 | ... |
|                |   |   | ... | ...   | 010 | 85180 | ... |
| July/2015 - 19 | Models with F-650 chassis with 19.5" or 22.5" Wheels (22,000 lb GVW)              | 471700011530<br>ASH-24658<br>ASH-24659<br>FC44-18045-BB<br>FC4Z-18124-A<br>FC4Z-18124-B | 010 | 85181 | ... | ...   | ... |
|                |   |   | 010 | 85181 | ... | ...   | ... |
|                |   |   | 010 | 85181 | ... | ...   | ... |
|                |   |   | 010 | 85181 | ... | ...   | ... |
|                |   |   | 010 | 85181 | ... | ...   | ... |
|                |   |   | 010 | 85181 | ... | ...   | ... |
| - 2015         | Models with F-650 chassis with 21,000 lb Rear Air Suspension                      | 3578858C1<br>3578858C2<br>4C4Z-18125-DA   | ... | ...   | 010 | 85926 | ... |
|                |   |   | ... | ...   | 010 | 85926 | ... |
|                |   |   | ... | ...   | 010 | 85926 | ... |
| 04 - 11        | Models with F-650 chassis with 22,000 lb Multi-leaf Rear Springs                  | 4C4Z-18125-B<br>501906C92   | ... | ...   | -10 | 83317 | ... |
|                |   |   | ... | ...   | -10 | 83317 | ... |

#### E350 & E450 Ford Chassis Models

|        |  |                      |     |       |     |       |     |
|--------|--|----------------------|-----|-------|-----|-------|-----|
| - 2019 | Primetime Series Shuttle buses with Ford E350 Chassis        | ASH-1136<br>ASH-1154 | ... | ...   | -10 | 83178 | ... |
|        |  |                      | -10 | 83177 | ... | ...   | ... |
| - 2019 | Sport Series Shuttle buses with Ford E350 Chassis            | ASH-1136<br>ASH-1154 | ... | ...   | -10 | 83178 | ... |
|        |  |                      | -10 | 83177 | ... | ...   | ... |
| - 2019 | Universal Series Shuttle buses with Ford E350 & E450 Chassis | ASH-1136<br>ASH-1154 | ... | ...   | -10 | 83178 | ... |
|        |  |                      | -10 | 83177 | ... | ...   | ... |

### GMC TRUCK

|  |  |         |     |     |     |       |     |
|--|--|---------|-----|-----|-----|-------|-----|
|  |  | 1591501 | ... | ... | -1- | 85722 | ... |
|--|--|---------|-----|-----|-----|-------|-----|





#### 3500 & 4000 Series

|         |  |      |     |       |       |       |       |
|---------|--|------|-----|-------|-------|-------|-------|
| 60 - 62 | 3500, 4000, B-4000, L-4000, S-4000 with H-130, H-150 and 13800 Axles | .... | ... | ...   | 010   | 83221 | ...   |
| 63 - 66 | Truck and School Bus   | .... | 010 | 85005 | 89430 | 010   | 83221 |

#### 4500 Series

|         |  |   |     |       |       |       |       |
|---------|--|---|-----|-------|-------|-------|-------|
| 66 - 72 | CE-4500, CS-4500 Conventional Cab with V-8 Gas or In-line 6 Gas Engines            | 22012096<br>3192892   | ... | ...   | 010   | 83221 | ...   |
|         |  |   | ... | ...   | 010   | 83221 | ...   |
| 66 - 72 | EG-4500, EM-4500, ES-4500 Cab/Cowl with V-6 Gas or Diesel or In-line 6 Gas Engines | 3171068<br>3192657<br>4940614<br>4963853<br>4963854<br>22012095<br>3171462<br>3192890 | 010 | 83216 | ...   | ...   | ...   |
|         |  |   | 010 | 83216 | ...   | ...   | ...   |
|         |  |   | 010 | 83216 | ...   | ...   | ...   |
|         |  |   | 010 | 83216 | ...   | ...   | ...   |
|         |  |   | 010 | 83216 | ...   | ...   | ...   |
|         |  |   | ... | ...   | 010   | 83126 | 89430 |
|         |  |   | ... | ...   | 010   | 83126 | 89430 |
| 72 - 80 | PS4620 P, 4650P Step Van (Walk-in) 3/4" Upper bolt                                 | 22002293<br>22007701<br>22012095  | 010 | 83126 | 89430 | ...   | ...   |
|         |  |   | 010 | 83126 | 89430 | ...   | ...   |
|         |  |   | 010 | 83126 | 89430 | ...   | ...   |

**APPLICATION GUIDE - TRUCKS, TRAILERS, AND BUSES**

| Year<br>Año<br>Année | Model<br>Modelo<br>Modèle | OEM # | Front   |   | Rear  |   |
|----------------------|---------------------------|-------|---|---|---|---|
|                      |                           |       |  |  |  |  |
|                      |                           |       | Fleetline   | GasSLX  | Fleetline   | GasSLX  |

**GMC TRUCK(Cont'd.)**

**4500 Series(Cont'd.)**

|         |  |          |     |       |       |     |       |     |
|---------|--|----------|-----|-------|-------|-----|-------|-----|
| 72 - 80 | PS4620 P, 4650P Step Van (Walk-in) 3/4" Upper bolt | 22012166 | 010 | 83126 | 89430 |     | ...   | ... |
|         |  | 3192890  | 010 | 83126 | 89430 |     | ...   | ... |
|         |  | 4940606  | 010 | 83126 | 89430 |     | ...   | ... |
|         |  | 4975497  | 010 | 83126 | 89430 |     | ...   | ... |
| 72 - 80 | PS4620 P, 4650P Step Van (Walk-in) 5/8" Upper bolt | 22007751 | 010 | 83303 | ...   |     | ...   | ... |
| 72 - 80 | PS4620 P, 4650P Step Van (Walk-in)                 | 22012096 |     | ...   | ...   | 010 | 83221 | ... |
|         |  | 3192892  |     | ...   | ...   | 010 | 83221 | ... |

**5000 Series**

|         |  |          |     |       |       |     |       |       |
|---------|--|----------|-----|-------|-------|-----|-------|-------|
| 60 - 62 | 5000, B-5000, L-5000, S-5000 with 1618 or 16802 Axle | .....    |     | ...   | ...   | 010 | 83221 | ...   |
| 75 - 80 | C Chassis - Conventional Cab                         | 4975510  | 010 | 83221 | ...   |     | ...   | ...   |
| 76 - 89 | C Chassis - Conventional Cab                         | 22002294 | 010 | 83304 | ...   |     | ...   | ...   |
|         |  | 22007752 | 010 | 83304 | ...   |     | ...   | ...   |
|         |  | 22007757 | 010 | 83304 | ...   |     | ...   | ...   |
|         |  | 22012096 |     | ...   | ...   | 010 | 83221 | ...   |
|         |  | 22012196 |     | ...   | ...   | 010 | 83221 | ...   |
| 73 - 80 | C, S Chassis - Conventional Cab                      | 22007750 | 010 | 83207 | 89407 |     | ...   | ...   |
|         |  | 4975467  | 010 | 83207 | 89407 |     | ...   | ...   |
|         |  | 4975494  | 010 | 83207 | 89407 |     | ...   | ...   |
| 73 - 80 | C,S Chassis - Conventional Cab and School Bus        | 22012096 |     | ...   | ...   | 010 | 83221 | ...   |
|         |  | 3192892  |     | ...   | ...   | 010 | 83221 | ...   |
| 73 - 89 | C,S Chassis - Conventional Cab and School Bus        | 22012095 |     | ...   | ...   | 010 | 83126 | 89430 |
|         |  | 22012166 |     | ...   | ...   | 010 | 83126 | 89430 |
| 60 - 68 | SP-5000, DSP-5000 School Bus                         | .....    | 010 | 85302 | 89420 | 010 | 85307 | ...   |
| 63 - 66 | Truck and School Bus                                 | .....    | 010 | 85005 | 89430 |     | ...   | ...   |
| 63 - 68 | W-5000, BW-5000, DW-5000                             | .....    | 010 | 85005 | 89430 |     | ...   | ...   |





**5500 Series**

|         |   |          |     |       |       |       |       |       |
|---------|---|----------|-----|-------|-------|-------|-------|-------|
| 66 - 72 | CE-5500, CS-5500 Conventional Cab with V-8 Gas or In-line 6 Gas Engines         | 22012096 |     | 83221 | ...   | 010   | 83221 | ...   |
|         |   | 3192891  |     | 83221 | ...   | 010   | 83221 | ...   |
|         |   | 3192892  |     | 83221 | ...   | 010   | 83221 | ...   |
| 66 - 72 | CG-5500, CM-5500, T-5500 Conventional & Tilt Cab with V-6 Gas or Diesel Engines | 22012095 | 010 | 83126 | 89430 |       | ...   | ...   |
|         |   | 3192890  | 010 | 83126 | 89430 |       | ...   | ...   |
|         |   | 4940606  | 010 | 83126 | 89430 |       | ...   | ...   |
| 66 - 72 | EG-5500, EM-5500, ES-5500 Cab/Cowl with 6 Cyl. Engines                          | 3171068  | 010 | 83216 | ...   |       | ...   | ...   |
|         |   | 3192657  | 010 | 83216 | ...   |       | ...   | ...   |
|         |   | 4940614  | 010 | 83216 | ...   |       | ...   | ...   |
|         |   | 4963853  | 010 | 83216 | ...   |       | ...   | ...   |
|         |   | 4963854  | 010 | 83216 | ...   |       | ...   | ...   |
|         |   | 22012095 |     | ...   | ...   | 010   | 83126 | 89430 |
|         |   | 3171462  |     | ...   | ...   | 010   | 83126 | 89430 |
| 3192890 |   | ...      | ... | 010   | 83126 | 89430 |       |       |
| 60 - 68 | LW-5500   | .....    | 010 | 85307 | ...   |       | ...   | ...   |
| 67 - 68 | Truck and School Bus  | .....    | 010 | 85005 | 89430 | 010   | 83221 | ...   |
| 63 - 68 | W-5500  | .....    | 010 | 85005 | 89430 |       | ...   | ...   |

**6000 Series**

|         |  |          |     |       |     |  |     |     |
|---------|--|----------|-----|-------|-----|--|-----|-----|
| 76 - 89 | C Chassis - Conventional Cab                   | 22002294 | 010 | 83304 | ... |  | ... | ... |
|         |  | 22007752 | 010 | 83304 | ... |  | ... | ... |
|         |  | 22007757 | 010 | 83304 | ... |  | ... | ... |
| 75 - 80 | C, S Chassis - Conventional Cab and School Bus | 4975510  | 010 | 83221 | ... |  | ... | ... |
| 79 - 89 | C, S Chassis - Conventional Cab and School Bus | 22002295 | 010 | 83303 | ... |  | ... | ... |
|         |  | 22007753 | 010 | 83303 | ... |  | ... | ... |
|         |  | 22017530 | 010 | 83303 | ... |  | ... | ... |
|         |  | 22017531 | 010 | 83303 | ... |  | ... | ... |

**APPLICATION GUIDE - TRUCKS, TRAILERS, AND BUSES**

| Year<br>Año<br>Année | Model<br>Modelo<br>Modèle | OEM # | Front   |   | Rear  |  |
|----------------------|---------------------------|-------|---|---|---|--|
|                      |                           |       |  Fleetline |  GasSLX |  Fleetline |  GasSLX |

**GMC TRUCK(Cont'd.)**

**6000 Series(Cont'd.)**

|         |  |          |       |       |       |     |       |       |
|---------|--|----------|-------|-------|-------|-----|-------|-------|
| 73 - 75 | C, S Chassis - Conventional Cab and School Bus - Exc. with 18500, 20800 & 23000 lb Rear Axle | 22007750 | 010   | 83207 | 89407 |     | ...   | ...   |
|         |  | 4975467  | 010   | 83207 | 89407 |     | ...   | ...   |
|         |  | 4975494  | 010   | 83207 | 89407 |     | ...   | ...   |
| 73 - 89 | C, S Chassis - Conventional Cab and School Bus - Exc. with 18500, 20800 & 23000 lb Rear Axle | 22012096 |       | ...   | ...   | 010 | 83221 | ...   |
|         |  | 22012169 |       | ...   | ...   | 010 | 83221 | ...   |
|         |  | 3192892  |       | ...   | ...   | 010 | 83221 | ...   |
| 73 - 89 | C, S Chassis - Conventional Cab and School Bus with 18500, 20800 & 23000 lb Rear Axle        | 22012095 |       | ...   | ...   | 010 | 83126 | 89430 |
|         |  | 22012166 |       | ...   | ...   | 010 | 83126 | 89430 |
|         |  | 4940606  |       | ...   | ...   | 010 | 83126 | 89430 |
| 73 - 80 | C, S, T Chassis - Conventional & Tilt Cab and School Bus with 5000 & 7000 lb Axle            | 22002293 | 010   | 83126 | 89430 |     | ...   | ...   |
|         |  | 22007701 | 010   | 83126 | 89430 |     | ...   | ...   |
|         |  | 22007751 | 010   | 83303 | ...   |     | ...   | ...   |
|         |  | 22012095 | 010   | 83126 | 89430 |     | ...   | ...   |
|         |  | 3192890  | 010   | 83126 | 89430 |     | ...   | ...   |
|         |  | 4940606  | 010   | 83126 | 89430 |     | ...   | ...   |
|         |  | 4940662  | 010   | 83126 | 89430 |     | ...   | ...   |
| 4975497 | 010  | 83126    | 89430 |       | ...   | ... |       |       |
| 63 - 68 | DW - 6000  | .....    | 010   | 85005 | 89430 |     | ...   | ...   |
| 60 - 68 | L - 6000   | .....    | 010   | 85307 | ...   |     | ...   | ...   |
| 79 - 89 | S Chassis - School Bus   | 22002294 | 010   | 83304 | ...   |     | ...   | ...   |
|         |  | 22007702 | 010   | 83304 | ...   |     | ...   | ...   |
|         |  | 22007752 | 010   | 83304 | ...   |     | ...   | ...   |
|         |  | 22007757 | 010   | 83304 | ...   |     | ...   | ...   |
| 79 - 80 | W Chassis - 72" BBC Steel Tilt Cab   | 22002293 | 010   | 83126 | 89430 |     | ...   | ...   |
|         |  | 22007751 | 010   | 83303 | ...   |     | ...   | ...   |

**6500 Series**

|         |   |          |     |       |       |     |       |       |
|---------|---|----------|-----|-------|-------|-----|-------|-------|
| 75 - 76 | C, M Chassis - Conventional Cab   | 4975510  | 010 | 83221 | ...   |     | ...   | ...   |
| 76 - 89 | C, M Chassis - Conventional Cab   | 22002294 | 010 | 83304 | ...   |     | ...   | ...   |
|         |   | 22007752 | 010 | 83304 | ...   |     | ...   | ...   |
|         |   | 22007757 | 010 | 83304 | ...   |     | ...   | ...   |
| 73 - 75 | C, M Chassis - Conventional Cab with 9000 & 12000 lb Axle                                 | 22012095 | 010 | 83126 | 89430 |     | ...   | ...   |
|         |   | 3192890  | 010 | 83126 | 89430 |     | ...   | ...   |
|         |   | 4940606  | 010 | 83126 | 89430 |     | ...   | ...   |
|         |   | 4940614  | 010 | 83216 | ...   |     | ...   | ...   |
|         |   | 4963854  | 010 | 83216 | ...   |     | ...   | ...   |
|         |   | 4975497  | 010 | 83126 | 89430 |     | ...   | ...   |
| 75 - 89 | C, M Chassis - Conventional Cab with 9000 & 12000 lb Axle                                 | 22002295 | 010 | 83303 | ...   |     | ...   | ...   |
|         |   | 22007751 | 010 | 83303 | ...   |     | ...   | ...   |
|         |   | 22017530 | 010 | 83303 | ...   |     | ...   | ...   |
|         |   | 22017531 | 010 | 83303 | ...   |     | ...   | ...   |
|         |   | 4975511  | 010 | 83303 | ...   |     | ...   | ...   |
| 73 - 75 | C, M, S Chassis - Conventional Cab and School Bus   | 22007750 | 010 | 83207 | 89407 |     | ...   | ...   |
|         |   | 4975467  | 010 | 83207 | 89407 |     | ...   | ...   |
|         |   | 4975494  | 010 | 83207 | 89407 |     | ...   | ...   |
| 73 - 80 | C, M, S Chassis - Conventional Cab and School Bus - Exc. with 20800 or 23000 lb Rear Axle | 22012096 |     | ...   | ...   | 010 | 83221 | ...   |
|         |   | 22012169 |     | ...   | ...   | 010 | 83221 | ...   |
|         |   | 3192892  |     | ...   | ...   | 010 | 83221 | ...   |
| 73 - 80 | C, M, S Chassis - Conventional Cab and School Bus with 20800 or 23000 lb Rear Axle        | 22012095 |     | ...   | ...   | 010 | 83126 | 89430 |
|         |   | 22012166 |     | ...   | ...   | 010 | 83126 | 89430 |
|         |   | 4940606  |     | ...   | ...   | 010 | 83126 | 89430 |
| 73 - 80 | C, S, T Chassis - Conventional & Tilt Cab and School Bus                                  | 22002293 | 010 | 83126 | 89430 |     | ...   | ...   |

## APPLICATION GUIDE - TRUCKS, TRAILERS, AND BUSES

| Year<br>Año<br>Année | Model<br>Modelo<br>Modèle | OEM # | Front     |        | Rear      |        |
|----------------------|---------------------------|-------|-----------|--------|-----------|--------|
|                      |                           |       | Fleetline | GasSLX | Fleetline | GasSLX |

### GMC TRUCK(Cont'd.)

#### 6500 Series(Cont'd.)

|         |  |          |     |       |       |       |       |
|---------|--|----------|-----|-------|-------|-------|-------|
| 73 - 80 | C, S, T Chassis - Conventional & Tilt Cab and School Bus                           | 22012095 | O1O | 83126 | 89430 | ...   | ...   |
|         |  | 3192890  | O1O | 83126 | 89430 | ...   | ...   |
|         |  | 4940606  | O1O | 83126 | 89430 | ...   | ...   |
|         |  | 4975497  | O1O | 83126 | 89430 | ...   | ...   |
| 66 - 72 | CE-6500, CM-6500 Conventional Cab with V-6 Diesel or V-8 Gas Engine                | 3192892  | O1O | ...   | ...   | 83221 | ...   |
| 66 - 72 | CE-6500, ME-6500 Conventional Cab with V-8 Gas Engine - Exc. 11000 lb Axle         | 22012096 | O1O | 83221 | ...   | ...   | ...   |
|         |  | 3192891  | O1O | 83221 | ...   | ...   | ...   |
|         |  | 3192892  | O1O | 83221 | ...   | ...   | ...   |
| 66 - 72 | CE-6500, ME-6500 Conventional Cab with V-8 Gas Engine with 11000 lb Axle           | 22012095 | O1O | 83126 | 89430 | ...   | ...   |
|         |  | 3192890  | O1O | 83126 | 89430 | ...   | ...   |
|         |  | 4940606  | O1O | 83126 | 89430 | ...   | ...   |
| 66 - 72 | CM-6500, TE-6500, TM-6500 Conventional Cab with V-6 Diesel or V-8 Gas Engine       | 22012095 | O1O | 83126 | 89430 | ...   | ...   |
|         |  | 22012096 | O1O | ...   | ...   | 83221 | ...   |
|         |  | 3192890  | O1O | 83126 | 89430 | ...   | ...   |
|         |  | 4940606  | O1O | 83126 | 89430 | ...   | ...   |
| 66 - 72 | EG-6500, DM-6500, ES-6500 Cab/Cowl with V-6 Gas or Diesel or In-line 6 Gas Engines | 3171068  | O1O | 83216 | ...   | ...   | ...   |
|         |  | 3192657  | O1O | 83216 | ...   | ...   | ...   |
|         |  | 4963853  | O1O | 83216 | ...   | ...   | ...   |
|         |  | 22012095 | O1O | ...   | ...   | 83126 | 89430 |
|         |  | 3171462  | O1O | ...   | ...   | 83126 | 89430 |
|         |  | 3192890  | O1O | ...   | ...   | 83126 | 89430 |

#### 7000 Series





|         |   |          |     |       |       |       |       |
|---------|---|----------|-----|-------|-------|-------|-------|
| 79 - 89 | C, M Chassis - 97" BBC Conventional Cab   | 22002294 | O1O | 83304 | ...   | ...   | ...   |
|         |   | 22002295 | O1O | 83303 | ...   | ...   | ...   |
|         |   | 22007752 | O1O | 83304 | ...   | ...   | ...   |
|         |   | 22007753 | O1O | 83303 | ...   | ...   | ...   |
|         |   | 22007757 | O1O | 83304 | ...   | ...   | ...   |
|         |   | 22017530 | O1O | 83303 | ...   | ...   | ...   |
|         |   | 22017531 | O1O | 83303 | ...   | ...   | ...   |
| 79 - 81 | C, M Chassis - 97" BBC Conventional Cab - Exc. with 18500, 20800 & 23000 lb Rear Axle | 22012096 | O1O | ...   | ...   | 83221 | ...   |
|         |   | 2212169  | O1O | ...   | ...   | 83221 | ...   |
| 79 - 89 | C, M Chassis - 97" BBC Conventional Cab with 18500, 20800 & 23000 lb Rear Axle        | 22012095 | O1O | ...   | ...   | 83126 | 89430 |
|         |   | 22012166 | O1O | ...   | ...   | 83126 | 89430 |
| 79 - 80 | W Chassis - 72" BBC Steel Tilt Cab  | 22002293 | O1O | 83126 | 89430 | ...   | ...   |
|         |   | 22007751 | O1O | 83303 | ...   | ...   | ...   |

#### 7500 Series

|         |  |          |     |       |       |       |       |
|---------|--|----------|-----|-------|-------|-------|-------|
| 66 - 69 | 72" BBC Tilt Cab   | 22012095 | O1O | 83126 | 89430 | ...   | ...   |
|         |  | 3171462  | O1O | 83126 | 89430 | ...   | ...   |
|         |  | 4940606  | O1O | 83126 | 89430 | ...   | ...   |
| 66 - 72 | 72" BBC Tilt Cab with V-6 2 Cycle Diesel Engine with 17221 Axle                                | 22012096 | O1O | ...   | ...   | 83221 | ...   |
|         |  | 3192892  | O1O | ...   | ...   | 83221 | ...   |
| 66 - 72 | 72" BBC Tilt Cab with V-6 2 Cycle Diesel Engine with 19101 and 19201 Axle                      | 4940600  | O1O | ...   | ...   | 83209 | 89414 |
| 70 - 72 | 72" BBC Tilt Cab with Air Brakes - Exc. Gas Engine   | 22012095 | O1O | 83126 | 89430 | ...   | ...   |
|         |  | 3171462  | O1O | 83126 | 89430 | ...   | ...   |
|         |  | 4940606  | O1O | 83126 | 89430 | ...   | ...   |
| 70 - 72 | 72" BBC Tilt Cab with Air Brakes & Gas Engine  | 22012091 | O1O | 85303 | 89422 | ...   | ...   |
|         |  | 5552452  | O1O | 85303 | 89422 | ...   | ...   |
| 66 - 72 | 92" BBC Conventional Cab with Tapered 2-Leaf Softride 11000 lb Rating and F120 Axle (12000 lb) | 22046483 | O1O | 85304 | ...   | ...   | ...   |



**APPLICATION GUIDE - TRUCKS, TRAILERS, AND BUSES**

| Year<br>Año<br>Année | Model<br>Modelo<br>Modèle | OEM # | Front   |   | Rear  |  |
|----------------------|---------------------------|-------|---|---|---|--|
|                      |                           |       |  Fleetline |  GasSLX |  Fleetline |  GasSLX |

**GMC TRUCK(Cont'd.)**





**7500 Series(Cont'd.)**

|         |   |          |     |       |       |     |       |       |
|---------|---|----------|-----|-------|-------|-----|-------|-------|
| 66 - 72 | 92" BBC Conventional Cab with Tapered 2-Leaf Softride 11000 lb Rating and F120 Axle (12000 lb)                                | 22052336 | 010 | 85304 | ...   |     | ...   | ...   |
|         |   | 3171069  | 010 | 85304 | ...   |     | ...   | ...   |
| 66 - 72 | 92" BBC Conventional Cab with Tapered 2-Leaf Softride 7000 & 9000 lb Rating and F070, F090, F120 Axle (7000, 9000 & 12000 lb) | 3171068  | 010 | 83216 | ...   |     | ...   | ...   |
|         |   | 3192657  | 010 | 83216 | ...   |     | ...   | ...   |
|         |   | 4940614  | 010 | 83216 | ...   |     | ...   | ...   |
|         |   | 4963853  | 010 | 83216 | ...   |     | ...   | ...   |
|         |   | 4963854  | 010 | 83216 | ...   |     | ...   | ...   |
| 77 - 80 | H, J Chassis - 92" BBC Conventional Cab   | 4963854  | 010 | 83216 | ...   |     | ...   | ...   |
|         |   | 4984526  | 010 | 83216 | ...   |     | ...   | ...   |
| 73 - 80 | H, J, M Chassis - 92" & 114" BBC Conventional Cab   | 22046483 | 010 | 85304 | ...   |     | ...   | ...   |
|         |   | 22052336 | 010 | 85304 | ...   |     | ...   | ...   |
|         |   | 3171069  | 010 | 85304 | ...   |     | ...   | ...   |
| 73 - 80 | H, J, M Chassis - 92" & 114" BBC Conventional Cab with V-6, V-8 Gas or V-6 Diesel Engines                                     | 4940614  | 010 | 83216 | ...   |     | ...   | ...   |
|         |   | 4963854  | 010 | 83216 | ...   |     | ...   | ...   |
| 73 - 80 | R Chassis - Rear Engine Bus   | 22012090 | 010 | 85308 | 89422 |     | ...   | ...   |
|         |   | 22012091 |     | ...   | ...   | 010 | 85303 | 89422 |
|         |   | 5552451  | 010 | 85308 | 89422 |     | ...   | ...   |
|         |   | 5552452  |     | ...   | ...   | 010 | 85303 | 89422 |
|         |   | 5552456  |     | ...   | ...   | 010 | 85307 | ...   |
| 73 - 80 | T, W Chassis - 72" BBC Steel Tilt Cab with V-6 Diesel Engine  | 22007751 | 010 | 83303 | ...   |     | ...   | ...   |
|         |   | 22012095 | 010 | 83126 | 89430 |     | ...   | ...   |
|         |   | 4940606  | 010 | 83126 | 89430 |     | ...   | ...   |
|         |   | 4975497  | 010 | 83126 | 89430 |     | ...   | ...   |
| 73 - 80 | T, W Chassis - 72" BBC Steel Tilt Cab with V-6 Gas Engine   | 22012091 | 010 | 85303 | 89422 |     | ...   | ...   |
|         |   | 5552452  | 010 | 85303 | 89422 |     | ...   | ...   |

**8500 Series**

|         |   |          |     |       |       |     |       |       |
|---------|---|----------|-----|-------|-------|-----|-------|-------|
| 66 - 72 | 72" BBC Tilt Cab  | 5544060  | 010 | 85302 | 89420 |     | ...   | ...   |
| 1967    | 92" BBC Conventional Cab  | 3171068  | 010 | 83216 | ...   |     | ...   | ...   |
|         |   | 3192657  | 010 | 83216 | ...   |     | ...   | ...   |
|         |   | 4940614  | 010 | 83216 | ...   |     | ...   | ...   |
|         |   | 4963853  | 010 | 83216 | ...   |     | ...   | ...   |
|         |   | 4963854  | 010 | 83216 | ...   |     | ...   | ...   |
| 66 - 72 | 92" BBC Conventional Cab with 7000 & 9000 lb Axles                | 22046483 | 010 | 85304 | ...   |     | ...   | ...   |
|         |   | 22052336 | 010 | 85304 | ...   |     | ...   | ...   |
|         |   | 3171069  | 010 | 85304 | ...   |     | ...   | ...   |
| 79 - 80 | D, F Chassis - 54" BBC Aluminum Tilt Cab                          | 22046483 | 010 | 85304 | ...   |     | ...   | ...   |
|         |   | 22052336 | 010 | 85304 | ...   |     | ...   | ...   |
|         |   | 3171069  | 010 | 85304 | ...   |     | ...   | ...   |
| 79 - 82 | H, J Chassis - 92" BBC Conventional Cab 4 x 2 with Air Suspension | 22012065 |     | ...   | ...   | 010 | 85304 | ...   |
|         |   | 22046483 |     | ...   | ...   | 010 | 85304 | ...   |
|         |   | 22052336 |     | ...   | ...   | 010 | 85304 | ...   |
|         |   | 3171069  |     | ...   | ...   | 010 | 85304 | ...   |
| 73 - 81 | H, J Chassis - 92" BBC Conventional Cab with V-6, V-8 Gas Engine  | 4940614  | 010 | 83216 | ...   |     | ...   | ...   |
|         |   | 4963854  | 010 | 83216 | ...   |     | ...   | ...   |
|         |   | 4984526  | 010 | 83216 | ...   |     | ...   | ...   |
| 73 - 86 | H, J, M Chassis - 92" & 114" BBC Conventional Cab                 | 22046483 | 010 | 85304 | ...   |     | ...   | ...   |
|         |   | 22052336 | 010 | 85304 | ...   |     | ...   | ...   |
|         |   | 3171069  | 010 | 85304 | ...   |     | ...   | ...   |
| 73 - 80 | R Chassis - Rear Engine Bus                                       | 22012090 | 010 | 85308 | 89422 |     | ...   | ...   |
|         |   | 22012091 |     | ...   | ...   | 010 | 85303 | 89422 |
|         |   | 5552451  | 010 | 85308 | 89422 |     | ...   | ...   |

**APPLICATION GUIDE - TRUCKS, TRAILERS, AND BUSES**

| Year<br>Año<br>Année | Model<br>Modelo<br>Modèle | OEM # | Front   |   | Rear  |   |
|----------------------|---------------------------|-------|---|---|---|---|
|                      |                           |       |  |  |  |  |
|                      |                           |       | Fleetline   | GasSLX  | Fleetline   | GasSLX  |

**GMC TRUCK(Cont'd.)**

**8500 Series(Cont'd.)**

|         |   |          |     |       |       |     |       |       |
|---------|---|----------|-----|-------|-------|-----|-------|-------|
| 73 - 80 | R Chassis - Rear Engine Bus                               | 5552452  |     | ...   | ...   | ○ ○ | 85303 | 89422 |
|         |   | 5552456  |     | ...   | ...   | ○ ○ | 85307 | ...   |
| 73 - 80 | T, W Chassis - 72" BBC Steel Tilt Cab with V-6 Gas Engine | 22012091 | ○ ○ | 85303 | 89422 |     | ...   | ...   |
|         |   | 5552452  | ○ ○ | 85303 | 89422 |     | ...   | ...   |

**9500 Series**

|         |  |          |     |       |       |     |       |     |
|---------|--|----------|-----|-------|-------|-----|-------|-----|
| 66 - 72 | 48" BBC Aluminum Tilt Cab  | 5552454  | ○ ○ | 85302 | 89420 |     | ...   | ... |
| 66 - 72 | 72" BBC Steel Tilt Cab   | 22012091 | ○ ○ | 85303 | 89422 |     | ...   | ... |
|         |  | 5552452  | ○ ○ | 85303 | 89422 |     | ...   | ... |
| 67 - 72 | 92" & 114" BBC Conventional Cab  | 3171068  | ○ ○ | 83216 | ...   |     | ...   | ... |
|         |  | 3192657  | ○ ○ | 83216 | ...   |     | ...   | ... |
|         |  | 4940614  | ○ ○ | 83216 | ...   |     | ...   | ... |
|         |  | 4963853  | ○ ○ | 83216 | ...   |     | ...   | ... |
|         |  | 4963854  | ○ ○ | 83216 | ...   |     | ...   | ... |
| 73 - 89 | D, F Chassis - 54" BBC Aluminum Tilt Cab with Rear GM Air Ride Suspension (4 Req'd)                                  | 22012065 |     | 85304 | ...   | ○ ○ | 85304 | ... |
|         |  | 22046483 |     | 85304 | ...   | ○ ○ | 85304 | ... |
|         |  | 22052336 |     | 85304 | ...   | ○ ○ | 85304 | ... |
|         |  | 3171069  |     | 85304 | ...   | ○ ○ | 85304 | ... |
| 73 - 89 | H, J Chassis - 92" BBC Conventional Cab with Rear GM Air-Ride Suspension (4 req'd)                                   | 22012065 |     | 85304 | ...   | ○ ○ | 85304 | ... |
|         |  | 22046483 |     | 85304 | ...   | ○ ○ | 85304 | ... |
|         |  | 22052336 |     | 85304 | ...   | ○ ○ | 85304 | ... |
|         |  | 3171069  |     | 85304 | ...   | ○ ○ | 85304 | ... |
| 77 - 89 | M, N Chassis - 114" BBC Conventional & 108" BBC Aluminum Conventional Cab with Rear GM Air-Ride Suspension (4 req'd) | 22046483 |     | 85304 | ...   | ○ ○ | 85304 | ... |
|         |  | 22052336 |     | 85304 | ...   | ○ ○ | 85304 | ... |
|         |  | 3171069  |     | 85304 | ...   | ○ ○ | 85304 | ... |
| 73 - 80 | T, W Chassis - 72" BBC Steel Tilt Cab  | 22012091 | ○ ○ | 85303 | 89422 |     | ...   | ... |
|         |  | 5552452  | ○ ○ | 85303 | 89422 |     | ...   | ... |









**B - Series - School Bus**

|         |  |          |     |       |     |     |       |     |
|---------|--|----------|-----|-------|-----|-----|-------|-----|
| 90 - 98 | B7 Model School Bus Chassis w/11000, 13500, 15000 lb Taperleaf Springs | 22064231 |     | ...   | ... | - - | 85324 | ... |
| 90 - 06 | B7 Model School Bus Chassis w/15000, 19000, 21000 lb Multileaf Springs | 15174902 |     | ...   | ... | - - | 85071 | ... |
|         |  | 22064232 |     | ...   | ... | - - | 85071 | ... |
| - 2009  | B6 , B7 Models with O.E.M. Number                                      | 15123676 | - - | 83136 | ... |     | ...   | ... |
|         |  | 15588554 | - - | 83136 | ... |     | ...   | ... |
|         |  | 22064230 | - - | 83136 | ... |     | ...   | ... |
|         |  | 88982682 | - - | 83136 | ... |     | ...   | ... |

**C - Series (C4500, C5500) Topkick**

|         |  |          |  |     |     |     |       |     |
|---------|--|----------|--|-----|-----|-----|-------|-----|
| 04 - 09 | C Chassis - Conventional Cab (Non 4x4 Option) with 13,500 Multi-leaf Spring                          | 15185644 |  | ... | ... | ○ ○ | 83155 | ... |
|         |  | 508-89   |  | ... | ... | ○ ○ | 83155 | ... |
|         |  | L-12706  |  | ... | ... | ○ ○ | 83155 | ... |
| 1990 -  | C Chassis - Conventional Cab with 11000, 13500, 15000 lb Taperleaf Springs                           | 22064231 |  | ... | ... | - - | 85324 | ... |
| 90 - 09 | C Chassis - Conventional Cab with 15000, 19000, 21000 lb Multileaf Springs                           | 15174902 |  | ... | ... | - - | 85071 | ... |
|         |  | 22064232 |  | ... | ... | - - | 85071 | ... |
|         |  | 88982686 |  | ... | ... | - - | 85071 | ... |
| 90 - 06 | C Chassis - Conventional Cab with 16900 or 17850 lb Taperleaf Springs                                | 21998392 |  | ... | ... | - - | 85336 | ... |
|         |  | 22064489 |  | ... | ... | - - | 85336 | ... |
|         |  | 88963409 |  | ... | ... | - - | 85336 | ... |
| 1990 -  | C Chassis - Conventional Cab with 19000, 21000, 23000 lb Taperleaf Springs (EXC Low Profile Vehicle) | 22064233 |  | ... | ... | - - | 83136 | ... |
| 83 - 99 | C Chassis - Conventional Cab with 9100 to 17500 lb Rear Axle   | 22064432 |  | ... | ... | ○ ○ | 85050 | ... |

## APPLICATION GUIDE - TRUCKS, TRAILERS, AND BUSES

| Year<br>Año<br>Année | Model<br>Modelo<br>Modèle | OEM # | Front  |   | Rear   |   |
|----------------------|---------------------------|-------|--|---|--|---|
|                      |                           |       |  |  |  |  |
|                      |                           |       |   |  |   |  |
|                      |                           |       | Fleetline  | GasSLX  | Fleetline  | GasSLX  |

### GMC TRUCK(Cont'd.)

#### C - Series (C4500, C5500) Topkick(Cont'd.)

|         |  |          |     |       |     |     |       |     |
|---------|--|----------|-----|-------|-----|-----|-------|-----|
| 90 - 09 | C Chassis - Conventional Cab with Front Shock with O.E.M. Number | 15123676 | - - | 83136 | ... | ... | ...   |     |
|         |  |          | - - | 83136 | ... | ... | ...   |     |
|         |  |          | - - | 83136 | ... | ... | ...   |     |
|         |  |          | - - | 83136 | ... | ... | ...   |     |
|         |  |          | - - | 83136 | ... | ... | ...   |     |
|         |  |          | - - | 83136 | ... | ... | ...   |     |
| 03 - 09 | C Chassis - Conventional Cab with Taperleaf Rear Suspension      | 15185643 |     | ...   | ... | 0 0 | 83153 | ... |
|         | Models with O.E.M. Number  | 88982684 | - - | 83136 | ... |     | ...   | ... |
|         |  | 88982688 |     | ...   | ... | - - | 85336 | ... |





#### C - Series (C6500, C7500, C8500) Topkick

|         |   |          |     |       |     |     |       |       |
|---------|---|----------|-----|-------|-----|-----|-------|-------|
| 90 - 09 | Conventional Cab<br>Front Shock with O.E.M. Number                                    | 15123676 | - - | 83136 | ... | ... | ...   |       |
|         |   |          | - - | 83136 | ... | ... | ...   |       |
|         |   |          | - - | 83136 | ... | ... | ...   |       |
|         |   |          | - - | 83136 | ... | ... | ...   |       |
|         |   |          | - - | 83136 | ... | ... | ...   |       |
|         |   |          | - - | 83136 | ... | ... | ...   |       |
|         |   |          | - - | 83136 | ... | ... | ...   |       |
|         |   |          | - - | 83136 | ... | ... | ...   |       |
|         |   |          | - - | 83136 | ... | ... | ...   |       |
|         |   |          | - - | 83136 | ... | ... | ...   |       |
|         | With 15000, 19000, 21000 lb Multileaf Springs   | 15174902 |     | ...   | ... | - - | 85071 | ...   |
|         |   | 22064232 |     | ...   | ... | - - | 85071 | ...   |
|         |   | 88982686 |     | ...   | ... | - - | 85071 | ...   |
| 04 - 08 | Conventional Cab (Low Profile) with 12000, 15000, & 17000 lb Leaf Spring              | 15174901 |     | ...   | ... | - - | 85342 | ...   |
|         |   | 507-22   |     | ...   | ... | - - | 85342 | ...   |
|         |   | 88982685 |     | ...   | ... | - - | 85342 | ...   |
| 1990 -  | Conventional Cab w/11000, 13500, 15000 lb Taperleaf Springs                           | 22064231 |     | ...   | ... | - - | 85324 | ...   |
| 90 - 06 | Conventional Cab w/16900 or 17850 lb Taperleaf Springs                                | 21998392 |     | ...   | ... | - - | 85336 | ...   |
|         |   | 22064489 |     | ...   | ... | - - | 85336 | ...   |
|         |   | 88963409 |     | ...   | ... | - - | 85336 | ...   |
| 1990 -  | Conventional Cab w/19000, 21000, 23000 lb Taperleaf Springs (EXC Low Profile Vehicle) | 22064233 |     | ...   | ... | - - | 83136 | ...   |
| 04 - 08 | Conventional Cab with 19000 lb Leaf Spring  | 15174903 |     | ...   | ... | - - | 85342 | ...   |
|         |   | 507-23   |     | ...   | ... | - - | 85342 | ...   |
|         |   | 88982687 |     | ...   | ... | - - | 85342 | ...   |
| 83 - 99 | Conventional Cab with 9100 to 17500 lb Rear Axle                                      | 22064432 |     | ...   | ... | 0 0 | 85050 | ...   |
| 95 - 02 | Models with Hendrickson Air Suspension (Stamping number 47902-13)                     | 12474915 |     | ...   | ... | 0 0 | 83122 | 89406 |
|         |   | 15963161 |     | ...   | ... | 0 0 | 83122 | 89406 |
| 96 - 02 | Models with Hendrickson Air Suspension (Stamping number 47902-29)                     | 12474917 |     | ...   | ... | 0 0 | 83137 | ...   |
|         |   | 15740554 |     | ...   | ... | 0 0 | 83137 | ...   |
|         | Models with O.E.M. Number   | 88982684 | - - | 83136 | ... |     | ...   | ...   |
|         |   | 88982688 |     | ...   | ... | - - | 85336 | ...   |

#### Coaches

|                           |         |         |       |     |       |       |     |
|---------------------------|---------|---------|-------|-----|-------|-------|-----|
| 4100, 4900 Models         | 3182842 | 85711   | ...   | - 0 | 85711 | ...   |     |
|                           |         | 3188599 | 85711 | ... | - 0   | 85711 | ... |
|                           |         | 3192416 | 85711 | ... | - 0   | 85711 | ... |
|                           |         | 4975552 | 85711 | ... | - 0   | 85711 | ... |
| 4500, 5300 Models         | 3166657 | 85700   | ...   | 0 0 | 85700 | ...   |     |
|                           |         | 3192333 | 85700 | ... | 0 0   | 85700 | ... |
| Models with O.E.M. Number | 3175509 | 85735   | ...   | 0 0 | 85735 | ...   |     |
|                           |         | 3178106 | 85700 | ... | 0 0   | 85700 | ... |
|                           |         | 3178507 | 85700 | ... | 0 0   | 85700 | ... |
|                           |         | 3178995 | 85700 | ... | 0 0   | 85700 | ... |
|                           |         | 3189265 | 85700 | ... | 0 0   | 85700 | ... |

**APPLICATION GUIDE - TRUCKS, TRAILERS, AND BUSES**

| Year<br>Año<br>Année | Model<br>Modelo<br>Modèle | OEM # | Front   |   | Rear  |   |
|----------------------|---------------------------|-------|---|---|---|---|
|                      |                           |       |  |  |  |  |
|                      |                           |       | Fleetline   | GasSLX  | Fleetline   | GasSLX  |

**GMC TRUCK(Cont'd.)**

**Coaches(Cont'd.)**

| Year | Model                     | OEM #   | Fleetline | GasSLX | Fleetline | GasSLX |     |
|------|---------------------------|---------|-----------|--------|-----------|--------|-----|
|      | Models with O.E.M. Number | 5304059 | 85700     | ...    | 010       | 85700  | ... |
|      |                           | 5316784 | 85700     | ...    | 010       | 85700  | ... |
|      |                           | 5316794 | 85700     | ...    | 010       | 85700  | ... |
|      |                           | 5316984 | 85313     | ...    | 010       | 85313  | ... |
|      |                           | 5352857 | 85700     | ...    | 010       | 85700  | ... |
|      |                           | 5527271 | 85700     | ...    | 010       | 85700  | ... |
|      |                           | 5527272 | 85700     | ...    | 010       | 85700  | ... |
|      |                           | 5549924 | 85700     | ...    | 010       | 85700  | ... |

**P - Series**

|         |                   |          |     |     |     |       |     |
|---------|-------------------|----------|-----|-----|-----|-------|-----|
| 92 - 96 | Motorhome Chassis | 22064231 | ... | ... | -1- | 85324 | ... |
|         |                   | 22064233 | ... | ... | -1- | 83136 | ... |

**T - Series (T5500, T6500, T7500, T8500)**

|         |   |          |     |       |     |     |       |       |
|---------|---|----------|-----|-------|-----|-----|-------|-------|
| 1997 -  | FL1 Tilt Cab with 8100 lb Axle  | 22064804 | -1- | 83136 | ... | ... | ...   |       |
|         |   | 22064805 | -1- | 83136 | ... | ... | ...   |       |
|         |   | 22165187 | -1- | 83136 | ... | ... | ...   |       |
|         |   | 22165188 | -1- | 83136 | ... | ... | ...   |       |
| 1997 -  | FL2 Tilt Cab with 5000 to 11000 lb Axle                                       | 22064807 | -1- | 83136 | ... | ... | ...   |       |
|         |   | 22166442 | -1- | 83136 | ... | ... | ...   |       |
| 1997 -  | FL3 Tilt Cab with 14575 lb Axle   | 22064806 | -1- | 83136 | ... | ... | ...   |       |
|         |   | 22165189 | -1- | 83136 | ... | ... | ...   |       |
| 1999    | Models with Hendrickson Air Suspension (Stamping number 47902-13)             | 12474915 |     | ...   | ... | 010 | 83122 | 89406 |
|         |   | 15963161 |     | ...   | ... | 010 | 83122 | 89406 |
| 06 - 09 | Tilt Cab Models with O.E.M. Number  | 15174901 |     | ...   | ... | -1- | 85342 | ...   |
|         |   | 15174903 |     | ...   | ... | -1- | 85342 | ...   |
|         |   | 507-22   |     | ...   | ... | -1- | 85342 | ...   |
|         |   | 507-23   |     | ...   | ... | -1- | 85342 | ...   |
|         |   | 88982685 |     | ...   | ... | -1- | 85342 | ...   |
|         |   | 88982687 |     | ...   | ... | -1- | 85342 | ...   |
| 90 - 99 | Tilt Cab with 11000, 13500, 15000 lb Taperleaf Springs                        | 22064231 |     | ...   | ... | -1- | 85324 | ...   |
| 90 - 06 | Tilt Cab with 15000, 19000, 21000 lb Multileaf Springs                        | 15174902 |     | ...   | ... | -1- | 85071 | ...   |
|         |   | 22064232 |     | ...   | ... | -1- | 85071 | ...   |
| 92 - 06 | Tilt Cab with 16900 lb Taperleaf Springs RR SUSP(GZH) Heavy Duty              | 21998392 |     | ...   | ... | -1- | 85336 | ...   |
|         |   | 22064489 |     | ...   | ... | -1- | 85336 | ...   |
|         |   | 88963409 |     | ...   | ... | -1- | 85336 | ...   |
| 92 - 99 | Tilt Cab with 19000, 21000, 23000 lb Taperleaf Springs (EXC Low Profile Veh.) | 22064233 |     | ...   | ... | -1- | 83136 | ...   |

**W - Series (Isuzu)**

|         |   |               |     |       |     |     |       |       |
|---------|---|---------------|-----|-------|-----|-----|-------|-------|
|         | Models with O.E.M. Number                     | 8-97253664-0  |     | ...   | ... | 010 | 83159 | ...   |
|         |   | 97253664      |     | ...   | ... | 010 | 83159 | ...   |
| 83 - 95 | W4 Models                                     | 8-51630-666-0 |     | ...   | ... | 010 | 85012 | 89413 |
|         |   | 9-51630-666-0 |     | ...   | ... | 010 | 85012 | 89413 |
| 89 - 90 | W4 Models Flatlow                             | 9-51630-647-1 | -10 | 83515 | ... |     | ...   | ...   |
| 89 - 92 | W4 Models Flatlow                             | 8-51630-666-0 |     | ...   | ... | 010 | 85012 | 89413 |
| 86 - 09 | W4 Models with 11000 lb & 13000 lb Suspension | 8-94454-986-0 | -10 | 83515 | ... |     | ...   | ...   |
|         |   | 8-94454-987-0 | -10 | 83515 | ... |     | ...   | ...   |
|         |   | 8-97253-620-0 | -10 | 83515 | ... |     | ...   | ...   |
|         |   | 94454987      | -10 | 83515 | ... |     | ...   | ...   |
|         |   | 9-51630-647-1 | -10 | 83515 | ... |     | ...   | ...   |
|         |   | 97083027      | -10 | 83515 | ... |     | ...   | ...   |
|         |   | 97083029      | -10 | 83515 | ... |     | ...   | ...   |
|         |   | 97253620      | -10 | 83515 | ... |     | ...   | ...   |
|         |   | 98232671      | -10 | 83515 | ... |     | ...   | ...   |
| 01 - 08 | W4 Models with O.E.M. Number                  | 97253651      |     | ...   | ... | 010 | 83404 | ...   |

## APPLICATION GUIDE - TRUCKS, TRAILERS, AND BUSES

| Year<br>Año<br>Année | Model<br>Modelo<br>Modèle | OEM # | Front     |        |  | Rear |  |  |
|----------------------|---------------------------|-------|-----------|--------|--|------|--|--|
|                      |                           |       |           |        |  |      |  |  |
|                      |                           |       | Fleetline | GasSLX |  |      |  |  |

### GMC TRUCK(Cont'd.)

#### W - Series (Isuzu)(Cont'd.)

|         |   |  |     |       |     |     |       |       |
|---------|---|--|-----|-------|-----|-----|-------|-------|
| 02 - 14 | W4 Models with O.E.M. Number                  | 8-97253665-0<br>898098-0580<br>898098-0581<br>898098-0590<br>97253665<br>98098058<br>98098059  |     | ...   | ... | OIO | 83159 | ...   |
|         |   |  |     | ...   | ... | OIO | 83159 | ...   |
|         |   |  |     | ...   | ... | OIO | 83159 | ...   |
|         |   |  |     | ...   | ... | OIO | 83159 | ...   |
|         |   |  |     | ...   | ... | OIO | 83159 | ...   |
|         |   |  |     | ...   | ... | OIO | 83159 | ...   |
|         |   |  |     | ...   | ... | OIO | 83159 | ...   |
|         |   |  |     | ...   | ... | OIO | 83159 | ...   |
| 88 - 99 | W5 Models                                     | 1-51630-217-0<br>1-51630-217-1<br>1-51630-219-1  | -IO | 83114 | ... |     | ...   | ...   |
|         |   |  |     | 83114 | ... | ... | ...   | ...   |
|         |   |  |     | 83114 | ... | ... | ...   | ...   |
| 03 - 09 | W5 Models with 11000 lb & 13000 lb Suspension | 97253620   | -IO | 83515 | ... |     | ...   | ...   |
| 03 - 09 | W5 Models with O.E.M. Number                  | 97253665   |     | ...   | ... | OIO | 83159 | ...   |
| 86 - 91 | W6 Models                                     | 1-51630-168-1<br>1-51630-217-1   | -IO | 83515 | ... |     | ...   | ...   |
|         |   |  |     | 83114 | ... | ... | ...   | ...   |
|         | Models with O.E.M. Number                     | 8-94057-593-0<br>8-97083-029-0<br>8-97201-960-0<br>898098-1250<br>898098-1270<br>90044769<br>90044770<br>94033786<br>94051090<br>94057593<br>94454987<br>9-51630-666-2<br>97201960<br>97253616<br>97253621<br>97253623<br>98098125<br>98098127 | -IO | 83114 | ... |     | ...   | ...   |
|         |   |  |     | 83515 | ... | ... | ...   | ...   |
|         |   |  |     | 83515 | ... | ... | ...   | ...   |
|         |   |  |     | 83515 | ... | ... | ...   | ...   |
|         |   |  |     | 83515 | ... | ... | ...   | ...   |
|         |   |  |     | ...   | ... | OIO | 83207 | 89407 |
|         |   |  |     | ...   | ... | OIO | 83207 | 89407 |
|         |   |  |     | ...   | ... | -IO | 83114 | ...   |
|         |   |  |     | 83114 | ... | ... | ...   | ...   |
|         |   |  |     | 83114 | ... | ... | ...   | ...   |
|         |   |  |     | 83515 | ... | ... | ...   | ...   |
|         |   |  |     | ...   | ... | OIO | 85012 | 89413 |
|         |   |  |     | 83515 | ... | ... | ...   | ...   |
|         |   |  |     | 83515 | ... | ... | ...   | ...   |
|         |   |  |     | 83515 | ... | ... | ...   | ...   |
|         |   |  |     | 83515 | ... | ... | ...   | ...   |

#### WCA & WIA Series

|  |                           |  |     |       |       |     |     |     |
|--|---------------------------|--|-----|-------|-------|-----|-----|-----|
|  | Models with O.E.M. Number | 37301-0016<br>37301-0021<br>37301-3202 | OIO | 85026 | 89417 |     | ... | ... |
|  |                           |  |     | 85026 | 89417 | ... | ... |     |
|  |                           |  |     | 85026 | 89417 | ... | ... |     |

#### WH Series

|  |  |         |     |       |     |  |     |     |
|--|--|---------|-----|-------|-----|--|-----|-----|
|  | WHS, WHR, WHL or WHE Models with Front Dual Shocks | 3082284 | -IO | 83400 | ... |  | ... | ... |
|--|--|---------|-----|-------|-----|--|-----|-----|





#### Additional Applications

|  |  |            |  |     |     |     |       |       |
|--|--|------------|--|-----|-----|-----|-------|-------|
|  | 1500 Models<br>Models with Rear Suspension | 35901-0005 |  | ... | ... | OIO | 83219 | ...   |
|  |  |            |  | ... | ... | OIO | 83209 | 89414 |
|  | Models with O.E.M. Number                  | 35901-0001 |  | ... | ... | OIO | 83209 | 89414 |

#### Additional O.E.M. Interchanges

|  |                           |   |  |        |       |     |       |     |
|--|---------------------------|---|--|--------|-------|-----|-------|-----|
|  | Models with O.E.M. Number | 15642943<br>22024061<br>22025067<br>22025305<br>22046489<br>22065218<br>22065251<br>22099889<br>507-24<br>508-88<br>87-2520-00003 |  | ...    | ...   | -IO | 83136 | ... |
|  |                           |   |  | ...    | ...   | OIO | 85704 | ... |
|  |                           |   |  | ...    | ...   | OIO | 85704 | ... |
|  |                           |   |  | ...    | ...   | OIO | 85704 | ... |
|  |                           |   |  | 85303  | 89422 | ... | ...   | ... |
|  |                           |   |  | G63347 | ...   | ... | ...   | ... |
|  |                           |   |  | 85030  | 89440 | ... | ...   | ... |
|  |                           |   |  | ...    | ...   | -IO | 85336 | ... |
|  |                           |   |  | ...    | ...   | -IO | 85336 | ... |
|  |                           |   |  | ...    | ...   | OIO | 83153 | ... |
|  |                           |   |  | ...    | ...   | OIO | 85704 | ... |

**APPLICATION GUIDE - TRUCKS, TRAILERS, AND BUSES**





| Year<br>Año<br>Année | Model<br>Modelo<br>Modèle | OEM # | Front   |   | Rear  |   |
|----------------------|---------------------------|-------|---|---|---|---|
|                      |                           |       |  |  |  |  |
|                      |                           |       | Fleetline   | GasSLX  | Fleetline   | GasSLX  |

**GMC TRUCK(Cont'd.)**

**Additional O.E.M. Interchanges(Cont'd.)**

| Models with O.E.M. Number      | U0109-014  |     | ... | ... | - - | 83400          | ... |
|--------------------------------|------------|-----|-----|-----|-----|----------------|-----|
| Additional O.E.M. Interchanges | 22007703   | 010 |     |     |     | 83303          |     |
|                                | 22012067   | 010 |     |     |     | 85700          |     |
|                                | 22012082   | 010 |     |     |     | 85702          |     |
|                                | 22012083   | -10 |     |     |     | 85711          |     |
|                                | 22012083GS | -10 |     |     |     | 85711          |     |
|                                | 22012114   | 010 |     |     |     | 85700          |     |
|                                | 22012131   | -10 |     |     |     | 85711          |     |
|                                | 22024673   | -10 |     |     |     | 85710          |     |
|                                | 22045526   | 010 |     |     |     | 85702          |     |
|                                | 22046481   | 010 |     |     |     | 85702          |     |
|                                | 22046485   | -10 |     |     |     | 85710          |     |
|                                | 22046499   | -10 |     |     |     | 85710          |     |
|                                | 22052014   | 010 |     |     |     | 85702          |     |
|                                | 22052424   | -10 |     |     |     | 85710          |     |
|                                | 3171696    | 010 |     |     |     | 85307          |     |
|                                | 3172948    | 010 |     |     |     | 85303 or 89422 |     |
|                                | 3178157    | 010 |     |     |     | 85700          |     |
|                                | 3178233    | 010 |     |     |     | 85734          |     |
|                                | 3188626    | 010 |     |     |     | 85300 or 89419 |     |
|                                | 3188729    | 010 |     |     |     | 85303 or 89422 |     |
|                                | 35901-0003 | 010 |     |     |     | 85301          |     |
|                                | 35901-0004 | 010 |     |     |     | 83219          |     |
|                                | 35901-0017 | 010 |     |     |     | 83314          |     |
|                                | 4939852    | 010 |     |     |     | 85308 or 89422 |     |
|                                | 4939967    | 010 |     |     |     | 85308 or 89422 |     |
|                                | 4940601    | 010 |     |     |     | 83216          |     |
|                                | 4940627    | 010 |     |     |     | 83203 or 89436 |     |
|                                | 4940640    | 010 |     |     |     | 83216          |     |
|                                | 4940650    | 010 |     |     |     | 83207 or 89407 |     |
|                                | 4940654    | 010 |     |     |     | 83216          |     |
|                                | 4940660    | 010 |     |     |     | 83207 or 89407 |     |
|                                | 4963844    | 010 |     |     |     | 85307          |     |
|                                | 4964853    | 010 |     |     |     | 83217          |     |
|                                | 4974401    | 010 |     |     |     | 85700          |     |
|                                | 4975429    | 010 |     |     |     | 85300 or 89419 |     |
|                                | 4975472    | -10 |     |     |     | 83161          |     |
|                                | 4975479    | -1- |     |     |     | 83400          |     |
|                                | 4975480    | -1- |     |     |     | 83400          |     |
|                                | 4975501    | 010 |     |     |     | 85700          |     |
|                                | 4975516    | 010 |     |     |     | 85702          |     |
|                                | 4975518    | 010 |     |     |     | 85704          |     |
|                                | 4975538    | 010 |     |     |     | 85700          |     |
|                                | 4975549    | 010 |     |     |     | 83216          |     |
|                                | 4975550    | 010 |     |     |     | 85702          |     |
|                                | 507-16     | 010 |     |     |     | 85700          |     |
|                                | 507-19     | 010 |     |     |     | 85700          |     |
|                                | 5171068    | 010 |     |     |     | 83216          |     |
|                                | 5316791    | 010 |     |     |     | 83219          |     |
|                                | 5316792    | 010 |     |     |     | 85305          |     |
|                                | 5316793    | 010 |     |     |     | 85305          |     |
|                                | 5321920    | 010 |     |     |     | 85307          |     |
|                                | 5321929    | 010 |     |     |     | 85307          |     |
|                                | 5348631    | 010 |     |     |     | 83203 or 89436 |     |
|                                | 5352858    | 010 |     |     |     | 85305          |     |

**APPLICATION GUIDE - TRUCKS, TRAILERS, AND BUSES**

| Year<br>Año<br>Année | Model<br>Modelo<br>Modèle | OEM # | Front   |  | Rear  |   |
|----------------------|---------------------------|-------|---|--|---|---|
|                      |                           |       |  |  |  |  |
|                      |                           |       | Fleetline   | GasSLX   | Fleetline   | GasSLX  |

**GMC TRUCK(Cont'd.)**

**Additional O.E.M. Interchanges(Cont'd.)**

|                                |         |                |                |
|--------------------------------|---------|----------------|----------------|
| Additional O.E.M. Interchanges | 5353054 | 010            | 85303 or 89422 |
|                                | 5355798 | 010            | 85307          |
|                                | 5357955 | 010            | 85300 or 89419 |
|                                | 5357956 | 010            | 85734          |
|                                | 5357959 | 010            | 85300 or 89419 |
|                                | 5361994 | 010            | 85734          |
|                                | 5374779 | 010            | 85308 or 89422 |
|                                | 5374999 | 010            | 85307          |
|                                | 5385939 | 010            | 85307          |
|                                | 5392387 | 010            | 85303 or 89422 |
|                                | 5394448 | 010            | 85305          |
|                                | 5394467 | 010            | 85305          |
|                                | 5394468 | 010            | 85735          |
|                                | 5455798 | 010            | 85307          |
|                                | 5513489 | 010            | 83216          |
|                                | 5513716 | 010            | 85304          |
|                                | 5516459 | 010            | 85305          |
|                                | 5522781 | 010            | 85735          |
|                                | 5522794 | 010            | 85308 or 89422 |
|                                | 5522818 | 010            | 85305          |
|                                | 5527001 | 010            | 85300 or 89419 |
|                                | 5527606 | 010            | 85305          |
|                                | 5531027 | 010            | 85301          |
|                                | 5531435 | 010            | 85307          |
|                                | 5531436 | 010            | 85307          |
|                                | 5531437 | 010            | 85307          |
|                                | 5532026 | 010            | 85304          |
|                                | 5532425 | 010            | 83207 or 89407 |
|                                | 5532433 | 010            | 83207 or 89407 |
|                                | 5532675 | 010            | 85307          |
|                                | 5533699 | 010            | 85302 or 89420 |
|                                | 5534430 | 010            | 85303 or 89422 |
|                                | 5534439 | 010            | 85304          |
|                                | 5534447 | 010            | 85303 or 89422 |
|                                | 5544112 | 010            | 83216          |
|                                | 5544581 | 010            | 85302 or 89420 |
|                                | 5544716 | 010            | 85304          |
|                                | 5544717 | 010            | 85304          |
|                                | 5544812 | 010            | 83308          |
|                                | 5544818 | 010            | 85735          |
|                                | 5549899 | 010            | 83207 or 89407 |
|                                | 5549925 | 010            | 85304          |
|                                | 5552111 | 010            | 85304          |
|                                | 5552112 | 010            | 85307          |
|                                | 5552114 | 010            | 83216          |
| 5552205                        | 010     | 83217          |                |
| 5552206                        | 010     | 83214          |                |
| 5552207                        | 010     | 83217          |                |
| 5552208                        | 010     | 83217          |                |
| 5552209                        | 010     | 83215          |                |
| 5552210                        | 010     | 85308 or 89422 |                |
| 5552244                        | 010     | 85308 or 89422 |                |
| 5552285                        | 010     | 83214          |                |
| 5552286                        | 010     | 83217          |                |
| 5552287                        | 010     | 83217          |                |



## APPLICATION GUIDE - TRUCKS, TRAILERS, AND BUSES

| Year<br>Año<br>Année | Model<br>Modelo<br>Modèle | OEM # | Front     |        | Rear      |        |
|----------------------|---------------------------|-------|-----------|--------|-----------|--------|
|                      |                           |       |           |        |           |        |
|                      |                           |       | Fleetline | GasSLX | Fleetline | GasSLX |

### GMC TRUCK(Cont'd.)

#### Additional O.E.M. Interchanges(Cont'd.)

| Additional O.E.M. Interchanges | OEM #         | OEM # | Fleetline | GasSLX         |
|--------------------------------|---------------|-------|-----------|----------------|
|                                | 5552288       | 010   |           | 83217          |
|                                | 5552453       | 010   |           | 85301          |
|                                | 5552527       | 010   |           | 85735          |
|                                | 5554184       | 010   |           | 85302 or 89420 |
|                                | 5554589       | 010   |           | 85307          |
|                                | 5554596       | 010   |           | 85303 or 89422 |
|                                | 5554814       | 010   |           | 85302 or 89420 |
|                                | 5554959       | 010   |           | 83401          |
|                                | 5554995       | 010   |           | 85305          |
|                                | 5559363       | 010   |           | 83203 or 89436 |
|                                | 5585939       | 010   |           | 85307          |
|                                | 684280        | 010   |           | 83209 or 89414 |
|                                | 97-2210-00156 | 010   |           | 85702          |
|                                | 97-2210-00164 | -1-   |           | 85708          |
|                                | 97-2210-00170 | 01-   |           | 85733          |

### GMC TRUCK CAB SHOCKS

| Year   | Description   | OEM #     | OEM # | Fleetline | GasSLX |
|--------|---|-----------|-------|-----------|--------|
|        | Astro Cabover (Sleeper & Non-Sleeper Trucks) with Link Cabmate Model GMC-2P-A     | 1202-0032 | 010   |           | 83016  |
|        | Brigadier Tractors with J9 Cabs with Link Cabmate Model GMC92J9                   | 1202-0012 | 010   |           | 83023  |
| 2003 - | C4500 , C5500 Models Models with Link Cabmate Model GMT560                        | 1201-1043 | 010   |           | 83025  |
|        |   | 1202-1043 | 010   |           | 83025  |
| 1979 - | Conventional Trucks measuring 108" BBC or 116" BBC with Link Cabmate Model GMC816 | 1202-0012 | 010   |           | 83023  |
| 1990 - | TopKick Truck Cabs with Link Cabmate Model GMC104TK                               | 1202-0054 | 010   |           | 83021  |
| - 1989 | TopKick Truck Cabs with Link Cabmate Model GMC92TK                                | 1202-0012 | 010   |           | 83023  |

### GOSHEN COACH

| Year   | Description   | OEM #    | OEM # | Fleetline | GasSLX |
|--------|---|----------|-------|-----------|--------|
| - 2019 | Impule Series Shuttle buses with Ford E350 & E450 Chassis | ASH-1136 |       | ...       | ...    |
|        |   | ASH-1154 | -10   | 83177     | ...    |
| - 2019 | Pacer II Series Shuttle buses with Ford E350 Chassis      | ASH-1136 |       | ...       | ...    |
|        |   | ASH-1154 | -10   | 83177     | ...    |

### GRANNING SUSPENSION

| Year | Description                    | OEM #   | OEM # | Fleetline | GasSLX |
|------|--------------------------------|---------|-------|-----------|--------|
|      | Models T950-1200, -1400, -1700 | 2697    |       | ...       | ...    |
|      | Models with O.E.M. Number      | 1085    |       | ...       | ...    |
|      |                                | 680162  |       | ...       | ...    |
|      |                                | OE12425 |       | ...       | ...    |

### GREAT DANE TRAILER

| Year  | Description   | OEM #       | OEM # | Fleetline | GasSLX |
|---|---|-------------|-------|-----------|--------|
| Identification of the trailer suspension is necessary to determine what section of the catalog to refer to. Some possible options can be Chalmers, Hendrickson, Neway, Ridewell, Reyco. |   |             |       |           |        |
|   | Trailers with Great Dane part number  | HENS-20001  |       | ...       | ...    |
|   |   | HENS-20002  |       | ...       | ...    |
|   |   | HENS-20126  |       | ...       | ...    |
|   |   | HENS-21292  |       | ...       | ...    |
|   |   | HENS-23566  |       | ...       | ...    |
|   |   | HENS-23649  |       | ...       | ...    |
|   |   | MER202447   |       | ...       | ...    |
|   |   | REY18165-01 |       | ...       | ...    |
|   | Trailers with Great Dane part number<br>Heavy Duty<br>Standard              | HENS-24088  |       | ...       | ...    |
|   |   | HENS-24088  |       | ...       | ...    |
|   | Trailers with Reyco 86 AR / RS 1015, 1035, 3015, 3035 Slider Air Suspension | 18165-01    |       | ...       | ...    |

## APPLICATION GUIDE - TRUCKS, TRAILERS, AND BUSES

| Year<br>Año<br>Année | Model<br>Modelo<br>Modèle | OEM # | Front     |        |  | Rear |  |  |
|----------------------|---------------------------|-------|-----------|--------|--|------|--|--|
|                      |                           |       |           |        |  |      |  |  |
|                      |                           |       | Fleetline | GasSLX |  |      |  |  |

### GREAT DANE TRAILER(Cont'd.)

|  |                                   |          |  |     |     |     |       |       |
|--|-----------------------------------|----------|--|-----|-----|-----|-------|-------|
|  | Trailers with Reyco Suspension 87 | 18163-01 |  | ... | ... | 010 | 83207 | 89407 |
|  | Trailers with Reyco Suspension 88 | 18164-01 |  | ... | ... | 010 | 83122 | 89406 |

### GRECH MOTORS

|        |  |          |     |       |     |     |       |     |
|--------|--|----------|-----|-------|-----|-----|-------|-----|
|        | Models with Freightliner M2 Chassis - See Freightliner section for proper year and model information | .....    |     | ..... |     |     |       |     |
| - 2019 | Shuttle buses with Ford E450 Chassis   | ASH-1136 |     | ...   | ... | -10 | 83178 | ... |
|        |  | ASH-1154 | -10 | 83177 | ... |     | ...   | ... |

### GREYHOUND BUS

|  |                                |             |     |       |     |     |       |       |
|--|--------------------------------|-------------|-----|-------|-----|-----|-------|-------|
|  | City Cruiser                   | 12TA-01-013 |     | 85303 | ... | 010 | 85303 | 89422 |
|  | MC5, MC7, MC8                  | 12B-5-1     |     | 85735 | ... | 010 | 85735 | ...   |
|  |                                | 3178157     |     | 85700 | ... | 010 | 85700 | ...   |
|  | Additional O.E.M. Interchanges | 3166657     | 010 | 85700 |     |     |       |       |
|  |                                | 3178154     | 010 | 85735 |     |     |       |       |
|  |                                | 3192333     | 010 | 85700 |     |     |       |       |
|  |                                | 690029      | 010 | 85700 |     |     |       |       |
|  |                                | 74413       | 010 | 85313 |     |     |       |       |

### GRUMMAN BUS









|  |                                |               |     |       |     |     |       |     |
|--|--------------------------------|---------------|-----|-------|-----|-----|-------|-----|
|  | Model 870 Flex Bus             | 22024506      | -10 | 85703 | ... |     | ...   | ... |
|  |                                | 22025066      | -10 | 85703 | ... |     | ...   | ... |
|  |                                | 22025067      |     | ...   | ... | 010 | 85704 | ... |
|  |                                | 22025305      |     | ...   | ... | 010 | 85704 | ... |
|  |                                | 97-2201-00001 | -10 | 85703 | ... |     | ...   | ... |
|  |                                | 97-2201-00002 | -10 | 85703 | ... |     | ...   | ... |
|  |                                | 97-2201-00003 | -10 | 85703 | ... |     | ...   | ... |
|  |                                | 97-2201-00004 | -10 | 85703 | ... |     | ...   | ... |
|  |                                | 97-2201-00005 | -10 | 85703 | ... |     | ...   | ... |
|  |                                | 97-2210-00001 |     | ...   | ... | 010 | 85704 | ... |
|  |                                | 97-2210-00002 |     | ...   | ... | 010 | 85704 | ... |
|  |                                | 97-2210-00003 |     | ...   | ... | 010 | 85704 | ... |
|  |                                | 97-2210-00004 |     | ...   | ... | 010 | 85704 | ... |
|  |                                | 97-2210-00005 |     | ...   | ... | 010 | 85704 | ... |
|  | Additional O.E.M. Interchanges | 690029        | 010 | 85700 |     |     |       |     |

### GULF STREAM COACH

#### Class A MotorHomes

|         |  |              |     |       |     |     |       |     |
|---------|--|--------------|-----|-------|-----|-----|-------|-----|
| 03 - 06 | Atrium Series MotorHomes with Freightliner XC Chassis                      |              |     |       |     |     |       |     |
|         | ADL200 Suspension w/ 20K Rear  | 16-16873-000 |     | ...   | ... | 010 | 85029 | ... |
|         | AS120 Front Suspension   | 141700131810 | 010 | 83160 | ... |     | ...   | ... |
|         |  | 16-16737-000 | 010 | 83160 | ... |     | ...   | ... |
|         |  | 16-16874-000 | 010 | 83160 | ... |     | ...   | ... |
|         | Rear Shock with O.E.M. Number  | 141700131809 |     | ...   | ... | 010 | 85029 | ... |
|         |  | 16-16736-000 |     | ...   | ... | 010 | 85029 | ... |
|         | ZF - IFS Front Suspension with 23,000 lb GVW or Greater                    | 16-18103-000 | -1- | 85900 | ... |     | ...   | ... |
|         |  | 481700000493 | -1- | 85900 | ... |     | ...   | ... |
| 02 - 06 | Friendship & Scenic Cruiser Series MotorHomes with Freightliner XC Chassis |              |     |       |     |     |       |     |
|         | ADL200 Suspension w/ 20K Rear  | 16-16873-000 |     | ...   | ... | 010 | 85029 | ... |
|         | AS120 Front Suspension   | 141700131810 | 010 | 83160 | ... |     | ...   | ... |
|         |  | 16-16737-000 | 010 | 83160 | ... |     | ...   | ... |
|         |  | 16-16874-000 | 010 | 83160 | ... |     | ...   | ... |
|         | Rear Shock with O.E.M. Number  | 141700131809 |     | ...   | ... | 010 | 85029 | ... |
|         |  | 16-16736-000 |     | ...   | ... | 010 | 85029 | ... |
|         | ZF - IFS Front Suspension with 23,000 lb GVW or Greater                    | 16-18103-000 | -1- | 85900 | ... |     | ...   | ... |

## APPLICATION GUIDE - TRUCKS, TRAILERS, AND BUSES

| Year<br>Año<br>Année | Model<br>Modelo<br>Modèle | OEM # | Front   |   | Rear  |   |
|----------------------|---------------------------|-------|---|---|---|---|
|                      |                           |       |  |  |  |  |
|                      |                           |       |  |  |  |  |
|                      |                           |       | Fleetline   | GasSLX  | Fleetline   | GasSLX  |

### GULF STREAM COACH(Cont'd.)

#### Class A MotorHomes(Cont'd.)

|         |  |   |     |       |     |     |       |     |
|---------|--|---|-----|-------|-----|-----|-------|-----|
| 02 - 06 | ADL200 Suspension w/ 20K Rear  | 48170000493   | - - | 85900 | ... | ... | ...   | ... |
| 2002    | Independence Series MotorHomes with Freightliner XC Chassis<br>ADL200 Suspension w/ 20K Rear<br>AS120 Front Suspension<br><br>Rear Shock with O.E.M. Number<br><br>ZF - IFS Front Suspension with 23,000 lb GVW or Greater | 16-16873-000<br>141700131810<br>16-16737-000<br>16-16874-000<br>141700131809<br>16-16736-000<br>16-18103-000<br>48170000493 |     |       |     |     |       |     |
|         |  |   |     |       |     | O O | 85029 | ... |
|         |  |   | O O | 83160 | ... | ... | ...   |     |
|         |  |   | O O | 83160 | ... | ... | ...   |     |
|         |  |   | O O | 83160 | ... | ... | ...   |     |
|         |  |   |     |       |     | O O | 85029 | ... |
|         |  |   |     |       |     | O O | 85029 | ... |
|         |  |   | - - | 85900 | ... | ... | ...   |     |
| - -     | 85900  | ...   | ... | ...   |     |     |       |     |
| 02 - 04 | Yellowstone Series MotorHomes with Freightliner XC Chassis<br>ADL200 Suspension w/ 20K Rear<br>AS120 Front Suspension<br><br>Rear Shock with O.E.M. Number<br><br>ZF - IFS Front Suspension with 23,000 lb GVW or Greater  | 16-16873-000<br>141700131810<br>16-16737-000<br>16-16874-000<br>141700131809<br>16-16736-000<br>16-18103-000<br>48170000493 |     |       |     |     |       |     |
|         |  |   |     |       |     | O O | 85029 | ... |
|         |  |   | O O | 83160 | ... | ... | ...   |     |
|         |  |   | O O | 83160 | ... | ... | ...   |     |
|         |  |   | O O | 83160 | ... | ... | ...   |     |
|         |  |   |     |       |     | O O | 85029 | ... |
|         |  |   |     |       |     | O O | 85029 | ... |
|         |  |   | - - | 85900 | ... | ... | ...   |     |
| - -     | 85900  | ...   | ... | ...   |     |     |       |     |

#### Class C MotorHomes

|         |  |          |     |       |     |     |       |     |
|---------|--|----------|-----|-------|-----|-----|-------|-----|
| 02 - 19 | BT Cruiser Series MotorHomes with Ford E350 & E450 Chassis   | ASH-1136 |     | ...   | ... | - O | 83178 | ... |
|         |  | ASH-1154 | - O | 83177 | ... | ... | ...   |     |
| 2004    | Cavalier Series MotorHomes with Ford E350 & E450 Chassis     | ASH-1136 |     | ...   | ... | - O | 83178 | ... |
|         |  | ASH-1154 | - O | 83177 | ... | ... | ...   |     |
| 93 - 19 | Conquest Series MotorHomes with Ford E350 & E450 Chassis     | ASH-1136 |     | ...   | ... | - O | 83178 | ... |
|         |  | ASH-1154 | - O | 83177 | ... | ... | ...   |     |
| 04 - 08 | Endura Series MotorHomes with Chevy Kodiak Chassis           | .....    | - - | 83136 | ... | ... | ...   |     |
| 03 - 08 | Independence Series MotorHomes with Ford E350 & E450 Chassis | ASH-1136 |     | ...   | ... | - O | 83178 | ... |
|         |  | ASH-1154 | - O | 83177 | ... | ... | ...   |     |
| 00 - 08 | Ultra Series MotorHomes with Ford E350 & E450 Chassis        | ASH-1136 |     | ...   | ... | - O | 83178 | ... |
|         |  | ASH-1154 | - O | 83177 | ... | ... | ...   |     |
| 02 - 09 | Yellowstone Series MotorHomes with Ford E350 & E450 Chassis  | ASH-1136 |     | ...   | ... | - O | 83178 | ... |
|         |  | ASH-1154 | - O | 83177 | ... | ... | ...   |     |

### HARDEE MFG

|  |                           |         |  |     |     |     |       |       |
|--|---------------------------|---------|--|-----|-----|-----|-------|-------|
|  | Models with O.E.M. Number | 8030223 |  | ... | ... | O O | 83207 | 89407 |
|  |                           | AS789B  |  | ... | ... | O O | 85014 | ...   |

### HAUSMAN





|  |                           |        |  |     |     |     |       |     |
|--|---------------------------|--------|--|-----|-----|-----|-------|-----|
|  | Models with O.E.M. Number | 695110 |  | ... | ... | - - | 85318 | ... |
|  |                           | 695119 |  | ... | ... | O O | 85702 | ... |
|  |                           | 695198 |  | ... | ... | - - | 85706 | ... |

### HENDRICKSON TRAILER SUSPENSION SYSTEMS

#### Intraax

|  |   |         |  |     |     |     |       |       |
|--|---|---------|--|-----|-----|-----|-------|-------|
|  | AA230T & AA250T Models with O.E.M. Number   | A-20002 |  | ... | ... | O O | 85000 | 89436 |
|  |   | A-20126 |  | ... | ... | O O | 85323 | 89436 |
|  |   | A-20889 |  | ... | ... | O O | 85323 | 89436 |
|  |   | B-22345 |  | ... | ... | O O | 85911 | ...   |
|  | AAEDL Models<br>For Models with 12" Ride Height<br>For Models with 14" to 19" Ride Height | B-24023 |  | ... | ... | O O | 85738 | ...   |
|  |   | B-23316 |  | ... | ... | O O | 85382 | ...   |
|  |   |         |  | ... | ... | O O | 85382 | ...   |

**APPLICATION GUIDE - TRUCKS, TRAILERS, AND BUSES**

| Year<br>Año<br>Année | Model<br>Modelo<br>Modèle | OEM # | Front   |  | Rear  |   |
|----------------------|---------------------------|-------|---|--|---|---|
|                      |                           |       |  |  |  |  |
|                      |                           |       | Fleetline   | GasSLX   | Fleetline   | GasSLX  |

**HENDRICKSON TRAILER SUSPENSION SYSTEMS(Cont'd.)**





**Intraax(Cont'd.)**

|  |  |         |     |     |     |       |       |
|--|--|---------|-----|-----|-----|-------|-------|
|  | For Models with 9" Ride Height   | B-24579 | ... | ... | 010 | 85939 | ...   |
|  | AAEDT 30K Models<br>( w/14" and 15" Ride Height- High Damping)             | B-25436 | ... | ... | 010 | 85916 | 89430 |
|  | ( w/14" Ride Height)   | B-23361 | ... | ... | 010 | 85911 | ...   |
|  | ( w/15", 16" & 17" Ride Height)  | B-25515 | ... | ... | 010 | 85338 | ...   |
|  | AAL 23K, 25K & 30K Models<br>Front shocks with 12" Ride Height             | B-23566 | ... | ... | 010 | 85000 | 89436 |
|  | Front shocks with 14" to 19" Ride Height                                   | A-2212  | ... | ... | 010 | 85029 | ...   |
|  | Front shocks with 6.5" to 9" Ride Height                                   | B-23651 | ... | ... | 010 | 85045 | ...   |
|  | Rear shocks with 14" to 17" Ride Height                                    | B-25437 | ... | ... | 010 | 85337 | ...   |
|  | Rear shocks with 6.5" to 7.5" Ride Height                                  | B-20345 | ... | ... | 010 | 85345 | ...   |
|  | Rear shocks with 9" to 12" Ride Height                                     | B-25436 | ... | ... | 010 | 85916 | 89430 |
|  | AANL 23K Models<br>with 12" to 17" Ride Height - High Damping              | B-25515 | ... | ... | 010 | 85338 | ...   |
|  | with 6.5" to 9" Ride Height - High Damping                                 | B-24579 | ... | ... | 010 | 85939 | ...   |
|  | with 6.5" to 9" Ride Height - Standard                                     | B-23651 | ... | ... | 010 | 85045 | ...   |
|  | AANLS - 20K with Rear shocks with 9" Ride Height                           | B-23316 | ... | ... | 010 | 85382 | ...   |
|  | AANT 23K Models<br>(High Damping)  | B-24023 | ... | ... | 010 | 85738 | ...   |
|  | (Hvy Duty)   | B-24125 | ... | ... | 010 | 85323 | 89436 |
|  | (Limited Rebound)  | B-23361 | ... | ... | 010 | 85911 | ...   |
|  | (Standard)   | B-23566 | ... | ... | 010 | 85000 | 89436 |
|  | AAT 23K Models<br>(High Damping)   | B-24023 | ... | ... | 010 | 85738 | ...   |
|  | (Hvy Duty)   | B-24125 | ... | ... | 010 | 85323 | 89436 |
|  | (Limited Rebound)  | B-23361 | ... | ... | 010 | 85911 | ...   |
|  | (Standard)   | B-23566 | ... | ... | 010 | 85000 | 89436 |
|  | AAT 25K Models<br>(High Damping)   | B-24023 | ... | ... | 010 | 85738 | ...   |
|  | (Hvy Duty)   | B-24125 | ... | ... | 010 | 85323 | 89436 |
|  | (Limited Rebound)  | B-23361 | ... | ... | 010 | 85911 | ...   |
|  | (Standard)   | B-23566 | ... | ... | 010 | 85000 | 89436 |
|  | AAT 30K Models   | B-24023 | ... | ... | 010 | 85738 | ...   |
|  | AAZL 23K / 46K Models<br>with 12" Ride Height - High Damping               | B-24023 | ... | ... | 010 | 85738 | ...   |
|  | with 12" Ride Height - Standard  | B-23566 | ... | ... | 010 | 85000 | 89436 |
|  | with 6.5" to 9" Ride Height - High Damping                                 | B-24579 | ... | ... | 010 | 85939 | ...   |
|  | with 6.5" to 9" Ride Height - Standard                                     | B-23651 | ... | ... | 010 | 85045 | ...   |
|  | AAZNT 23K / 46K / 69K Models<br>with 12" to 17" Ride Height - High Damping | B-24023 | ... | ... | 010 | 85738 | ...   |
|  | with 12" to 17" Ride Height - Standard                                     | B-23566 | ... | ... | 010 | 85000 | 89436 |
|  | Low Ride Height Models with<br>(10.5" to 15" Ride Height)                  | B-23013 | ... | ... | 010 | 85000 | 89436 |
|  | (15.5" to 21" Ride Height - High Damping)                                  | B-23316 | ... | ... | 010 | 85382 | ...   |
|  | (15.5" to 21" Ride Height - Std Damping)                                   | B-23315 | ... | ... | 010 | 85029 | ...   |
|  | (6.5" to 8" Ride Height - High Damping)                                    | B-22312 | ... | ... | 010 | 85939 | ...   |
|  | (6.5" to 8" Ride Height)   | B-22311 | ... | ... | 010 | 85045 | ...   |

**Top Mount Style**

|  |  |         |     |     |     |       |       |
|--|--|---------|-----|-----|-----|-------|-------|
|  | HT190T (All Models)                      | A-20001 | ... | ... | 010 | 83128 | 89436 |
|  | HT230T<br>All except Models listed below | A-20002 | ... | ... | 010 | 85000 | 89436 |
|  | ( TA14-020)                              | B-22345 | ... | ... | 010 | 85911 | ...   |
|  | ( TA15-521, TA17-521)                    | B-21553 | ... | ... | 010 | 85738 | ...   |
|  | ( TA15-522, TA17-522)                    | B-21699 | ... | ... | 010 | 87018 | ...   |

## APPLICATION GUIDE - TRUCKS, TRAILERS, AND BUSES

| Year<br>Año<br>Année | Model<br>Modelo<br>Modèle | OEM # | Front  |   | Rear   |   |
|----------------------|---------------------------|-------|--|---|--|---|
|                      |                           |       | <br>Fleetline | <br>GasSLX | <br>Fleetline | <br>GasSLX |

### HENDRICKSON TRAILER SUSPENSION SYSTEMS(Cont'd.)





#### Top Mount Style(Cont'd.)

|  |   |         |     |     |     |              |              |
|--|---|---------|-----|-----|-----|--------------|--------------|
|  | (-14-020, -14-021, TA14-021)  | A-2212  | ... | ... | 010 | <b>85029</b> | ...          |
|  | (-14-17, -15-17,-15-517,-17-517,TA15-517,TA15-520,TA17-517)   | A-20126 | ... | ... | 010 | <b>85323</b> | <b>89436</b> |
|  | (-14-7,-14-11, -15-7,-15-11,-15-12,-15-28,TA14-7,TA15-7,TA16-7,TA17-7,TB14-33,TB15-28)  | A-2160  | ... | ... | 010 | <b>85014</b> | ...          |
|  | HT250T (All Models)   | A-2212  | ... | ... | 010 | <b>85029</b> | ...          |
|  | HT300T & N-HT300T<br>(All except Models listed below)<br>(-15-007, -15-011, -15-021,-17-007,-17-011, -17-012, TB19-007,TB19-020)<br>(-15-017, -15-518, -17-518,-17-520)<br>( TB15-027 )<br>( TB15-518 ) | A-20126 | ... | ... | 010 | <b>85323</b> | <b>89436</b> |
|  |   | A-2160  | ... | ... | 010 | <b>85014</b> | ...          |
|  |   | B-21553 | ... | ... | 010 | <b>85738</b> | ...          |
|  |   | B-24579 | ... | ... | 010 | <b>85939</b> | ...          |
|  | T-15-140, -155, -172, 244, -376   | A-2218  | ... | ... | 010 | <b>85030</b> | <b>89440</b> |
|  | T-15-324  | A-2160  | ... | ... | 010 | <b>85014</b> | ...          |
|  | T-17-141, -174, -284  | A-2218  | ... | ... | 010 | <b>85030</b> | <b>89440</b> |
|  | TMB-14-120  | A-2213  | ... | ... | 010 | <b>85010</b> | ...          |
|  | TMB-17-135  | A-4084  | ... | ... | 010 | <b>85005</b> | <b>89430</b> |

#### UnderSlung Style

|  |  |         |     |     |     |              |              |
|--|--|---------|-----|-----|-----|--------------|--------------|
|  | HT190U<br>(-6.75-001 / -6.75-002 / -6.75-003 / -6.75-020 )<br>( U-7.5-517 )<br>( U-9-022 / UB7-021 )<br>(All except Models listed above)   | A-2212  | ... | ... | 010 | <b>85029</b> | ...          |
|  |  | A-20002 | ... | ... | 010 | <b>85000</b> | <b>89436</b> |
|  |  | B-23649 | ... | ... | 010 | <b>85064</b> | ...          |
|  |  | A-20001 | ... | ... | 010 | <b>83128</b> | <b>89436</b> |
|  | HT250U & N-HT250U<br>(All except Models listed below)<br>(U-6.5-030, U-6.5-031)<br>(U-6.5-27,U-9-27 & -28,U-14-28,UB6.5-522,UB7.5-27 & -522,UB9-522,UB12-27 & -28,UB14-27 & -28)<br>(U-6.5-517, U-7.5-17, U-7.5-517, U-9-517, U-12-517, U-14-514, UB6.5-517, UB7.5-517)<br>(U-7.5-021, U-7.5-022)<br>(U-9-20 & -21 & -23, U-9.5-26, U-15-22, UB9-22, UB15-22)      | A-20002 | ... | ... | 010 | <b>85000</b> | <b>89436</b> |
|  |  | A-2160  | ... | ... | 010 | <b>85014</b> | ...          |
|  |  | B-21553 | ... | ... | 010 | <b>85738</b> | ...          |
|  |  | A-20126 | ... | ... | 010 | <b>85323</b> | <b>89436</b> |
|  |  | A-1667  | ... | ... | 010 | <b>85000</b> | <b>89436</b> |
|  |  | A-2212  | ... | ... | 010 | <b>85029</b> | ...          |
|  | HT250US - 5.5 to 6.5" Ride Height (High Damping)   | B-23744 | ... | ... | 010 | <b>85344</b> | ...          |
|  |  | S-23744 | ... | ... | 010 | <b>85344</b> | ...          |
|  | HT250US (Models with Angled and Frame Clearance Mount)<br>(Standard Travel w/ 6.5", 7.5" & 14" Ride Height -High Damping)<br>(Standard Travel w/ 6.5", 7.5" & 14" Ride Height)   | B-24579 | ... | ... | 010 | <b>85939</b> | ...          |
|  |  | B-23651 | ... | ... | 010 | <b>85045</b> | ...          |
|  | HT250US (Models with O.E.M. Number)  | B-21936 | ... | ... | 010 | <b>85064</b> | ...          |
|  |  | B-21947 | ... | ... | 010 | <b>85052</b> | ...          |
|  |  | B-22862 | ... | ... | 010 | <b>85045</b> | ...          |
|  | HT250US (Models with Remote Shock Mount)<br>(Extended Rebound w/ 6.5" to 9" Ride Height -High Damping)<br>(Extended Rebound w/ 6.5" to 9" Ride Height)<br>(Standard Travel w/ 12" to 14" Ride Height)<br>(Standard Travel w/ 5.5" to 6.5" Ride Height)<br>(Standard Travel w/ 7.5" to 9" Ride Height -High Damping)<br>(Standard Travel w/ 7.5" to 9" Ride Height) | B-23316 | ... | ... | 010 | <b>85382</b> | ...          |
|  |  | A-2212  | ... | ... | 010 | <b>85029</b> | ...          |
|  |  | A-2212  | ... | ... | 010 | <b>85029</b> | ...          |
|  |  | B-23650 | ... | ... | 010 | <b>85052</b> | ...          |
|  |  | B-23743 | ... | ... | 010 | <b>85938</b> | ...          |
|  |  | B-23649 | ... | ... | 010 | <b>85064</b> | ...          |
|  | HT250US (Models with Standard Shock Mount)<br>(Extended Rebound w/ 6.5" Ride Height -High Damping)<br>(Extended Rebound w/ 6.5" Ride Height)<br>(Standard Travel w/ 3.5" to 4" Ride Height)<br>(Standard Travel w/ 5.5" to 6.5" Ride Height)<br>(Standard Travel w/ 7.5" to 14" Ride Height -High Damping)<br>(Standard Travel w/ 7.5" to 14" Ride Height)         | B-24579 | ... | ... | 010 | <b>85939</b> | ...          |
|  |  | B-23651 | ... | ... | 010 | <b>85045</b> | ...          |
|  |  | B-23548 | ... | ... | 010 | <b>85079</b> | ...          |
|  |  | B-23650 | ... | ... | 010 | <b>85052</b> | ...          |
|  |  | B-23743 | ... | ... | 010 | <b>85938</b> | ...          |
|  |  | B-23649 | ... | ... | 010 | <b>85064</b> | ...          |

**APPLICATION GUIDE - TRUCKS, TRAILERS, AND BUSES**

| Year<br>Año<br>Année | Model<br>Modelo<br>Modèle | OEM # | Front  |  | Rear  |   |
|----------------------|---------------------------|-------|--|--|---|---|
|                      |                           |       |  |  |  |  |
|                      |                           |       | Fleetline  | GasSLX   | Fleetline   | GasSLX  |

**HENDRICKSON TRAILER SUSPENSION SYSTEMS(Cont'd.)**

**UnderSlung Style(Cont'd.)**

|   |         |     |     |     |       |       |
|---|---------|-----|-----|-----|-------|-------|
| HT250U-Y (All Models)   | A-20002 | ... | ... | 010 | 85000 | 89436 |
| HT300U & N-HT300U<br>(All except Models listed below)<br>(U-7.5-519,U-9-011,U-9-519,U-12-011,U-12-015,U-14-011,U-14-015,U-17-011) | A-20126 | ... | ... | 010 | 85323 | 89436 |
|   | B-21699 | ... | ... | 010 | 87018 | ...   |
| T-12-139  | A-2213  | ... | ... | 010 | 85010 | ...   |
| T-23-US-9-011   | A-2213  | ... | ... | 010 | 85010 | ...   |
| T30-US-9, -17   | A-10348 | ... | ... | 010 | 85043 | ...   |
| T-4-392   | A-2160  | ... | ... | 010 | 85014 | ...   |
| T-6-062, -295, -370, -422   | A-1667  | ... | ... | 010 | 85000 | 89436 |
| T-6-071   | A-2212  | ... | ... | 010 | 85029 | ...   |
| T-9-084   | A-2240  | ... | ... | 010 | 85013 | 89414 |
| T-9-106, -278, -313   | A-4084  | ... | ... | 010 | 85005 | 89430 |
| T-9-175   | A-2160  | ... | ... | 010 | 85014 | ...   |
| T-9-325   | A-2218  | ... | ... | 010 | 85030 | 89440 |
| T-9-390   | A-2213  | ... | ... | 010 | 85010 | ...   |





**Vantraax**

|                                      |                         |         |     |     |       |       |       |
|--------------------------------------|-------------------------|---------|-----|-----|-------|-------|-------|
| HKA180<br>Heavy Duty                 | B-24088                 | ...     | ... | 010 | 85000 | 89436 |       |
|                                      | S-24088                 | ...     | ... | 010 | 85000 | 89436 |       |
|                                      | Standard                | B-24088 | ... | ... | 010   | 83128 | 89436 |
|                                      |                         | S-24088 | ... | ... | 010   | 83128 | 89436 |
| HKA200                               | B-23566                 | ...     | ... | 010 | 85000 | 89436 |       |
|                                      | S-23566                 | ...     | ... | 010 | 85000 | 89436 |       |
| HKA250<br>(Standard)                 | B-24023                 | ...     | ... | 010 | 85738 | ...   |       |
| HKAL 46K Models                      | B-23566                 | ...     | ... | 010 | 85000 | 89436 |       |
| HKANT 40K<br>Heavy Duty              | B-24088                 | ...     | ... | 010 | 85000 | 89436 |       |
|                                      | S-24088                 | ...     | ... | 010 | 85000 | 89436 |       |
|                                      | Standard                | B-24088 | ... | ... | 010   | 83128 | 89436 |
|                                      |                         | S-24088 | ... | ... | 010   | 83128 | 89436 |
| HKANT 46K                            | B-23566                 | ...     | ... | 010 | 85000 | 89436 |       |
|                                      | S-23566                 | ...     | ... | 010 | 85000 | 89436 |       |
| HKANT 69K23                          | S-23566                 | ...     | ... | 010 | 85000 | 89436 |       |
|                                      | S-23566                 | ...     | ... | 010 | 85000 | 89436 |       |
| HKARL 46K<br>Disc Brake Applications | B-25436                 | ...     | ... | 010 | 85916 | 89430 |       |
|                                      | S-25436                 | ...     | ... | 010 | 85916 | 89430 |       |
|                                      | Drum Brake Applications | B-23566 | ... | ... | 010   | 85000 | 89436 |
|                                      |                         | S-23566 | ... | ... | 010   | 85000 | 89436 |
| HKAT 46K                             | B-23566                 | ...     | ... | 010 | 85000 | 89436 |       |
|                                      | S-23566                 | ...     | ... | 010 | 85000 | 89436 |       |
| HKAT 50K                             | B-24023                 | ...     | ... | 010 | 85738 | ...   |       |
|                                      | S-24023                 | ...     | ... | 010 | 85738 | ...   |       |
| HKAT 69K                             | B-24023                 | ...     | ... | 010 | 85738 | ...   |       |
|                                      | S-24023                 | ...     | ... | 010 | 85738 | ...   |       |

**Additional Applications**

|                                |         |     |     |     |       |       |
|--------------------------------|---------|-----|-----|-----|-------|-------|
| AB-32-001 Models               | A-1667  | ... | ... | 010 | 85000 | 89436 |
| HK190T (Slider Air Suspension) | A-21292 | ... | ... | 010 | 85052 | ...   |
| HK230 (Slider Air Suspension)  | A-21292 | ... | ... | 010 | 85052 | ...   |
| HS190T (Slider Air Suspension) | A-20001 | ... | ... | 010 | 83128 | 89436 |
| HS230 (Slider Air Suspension)  | A-20002 | ... | ... | 010 | 85000 | 89436 |
| MT-45,MTL45,MTL-50             | S-1667  | ... | ... | 010 | 85000 | 89436 |
| TDC-014                        | 665267  | ... | ... | 010 | 85029 | ...   |

**APPLICATION GUIDE - TRUCKS, TRAILERS, AND BUSES**

| Year<br>Año<br>Année | Model<br>Modelo<br>Modèle | OEM # | Front   |  | Rear  |  |
|----------------------|---------------------------|-------|---|--|---|--|
|                      |                           |       |  Fleetline |  GasSLX |  Fleetline |  GasSLX |

**HENDRICKSON TRAILER SUSPENSION SYSTEMS(Cont'd.)**

**Additional Applications(Cont'd.)**

|         |        |  |     |     |     |       |     |
|---------|--------|--|-----|-----|-----|-------|-----|
| TDC-014 | A-2212 |  | ... | ... | 010 | 85029 | ... |
|---------|--------|--|-----|-----|-----|-------|-----|

**Additional O.E.M. Interchanges**

|                           |           |     |     |       |       |       |
|---------------------------|-----------|-----|-----|-------|-------|-------|
| Models with O.E.M. Number | 57905-2   | ... | ... | 010   | 85006 | ...   |
|                           | 60675-004 | ... | ... | 010   | 85006 | ...   |
|                           | 654951    | ... | ... | 010   | 85000 | 89436 |
|                           | 659024    | ... | ... | 010   | 85052 | ...   |
|                           | 665190    | ... | ... | 010   | 85006 | ...   |
|                           | 665246    | ... | ... | 010   | 85043 | ...   |
|                           | 665405    | ... | ... | 010   | 85030 | 89440 |
|                           | 665406    | ... | ... | 010   | 85010 | ...   |
|                           | 665531    | ... | ... | 010   | 85000 | 89436 |
|                           | 665532    | ... | ... | 010   | 85013 | 89414 |
|                           | 665533    | ... | ... | 010   | 85005 | 89430 |
|                           | 665536    | ... | ... | 010   | 85000 | 89436 |
|                           | 665693    | ... | ... | 010   | 85064 | ...   |
|                           | 665694    | ... | ... | 010   | 85052 | ...   |
|                           | 665698    | ... | ... | 010   | 85911 | ...   |
|                           | 665733    | ... | ... | 010   | 85045 | ...   |
|                           | 665756    | ... | ... | 010   | 85000 | 89436 |
|                           | 665758    | ... | ... | 010   | 85064 | ...   |
|                           | 665759    | ... | ... | 010   | 85052 | ...   |
|                           | 665760    | ... | ... | 010   | 85045 | ...   |
|                           | 665761    | ... | ... | 010   | 85911 | ...   |
|                           | 665763    | ... | ... | 010   | 85079 | ...   |
|                           | 665764    | ... | ... | 010   | 85029 | ...   |
|                           | 665765    | ... | ... | 010   | 83150 | ...   |
|                           | 665766    | ... | ... | 010   | 85000 | 89436 |
|                           | 665767    | ... | ... | 010   | 85045 | ...   |
|                           | 671779    | ... | ... | 010   | ...   | 89414 |
|                           | 671948    | ... | ... | 010   | 85000 | 89436 |
|                           | 680102    | ... | ... | 010   | 85712 | ...   |
|                           | 680341    | ... | ... | 010   | 85323 | 89436 |
|                           | 680463    | ... | ... | 010   | ...   | 89440 |
|                           | 680467    | ... | ... | 010   | 85323 | 89436 |
|                           | 680509    | ... | ... | 010   | 85738 | ...   |
|                           | 680565    | ... | ... | 010   | 85738 | ...   |
|                           | 680566    | ... | ... | 010   | 85938 | ...   |
|                           | 680568    | ... | ... | 010   | 85323 | 89436 |
|                           | 680570    | ... | ... | 010   | ...   | 89437 |
|                           | 680571    | ... | ... | 010   | 85738 | ...   |
|                           | 680573    | ... | ... | 010   | 85939 | ...   |
|                           | 680579    | ... | ... | 010   | 85939 | ...   |
|                           | 680614    | ... | ... | 010   | 85338 | ...   |
|                           | 680616    | ... | ... | 010   | ...   | 89430 |
|                           | 680617    | ... | ... | 010   | 85337 | ...   |
|                           | 680702    | ... | ... | 010   | 85323 | 89436 |
|                           | 680756    | ... | ... | 010   | 85323 | 89436 |
| 680769                    | ...       | ... | 010 | 85911 | ...   |       |
| 680776                    | ...       | ... | 010 | 85338 | ...   |       |
| 98583-019                 | ...       | ... | 010 | 85323 | 89436 |       |
| 98583-020                 | ...       | ... | 010 | ...   | 89414 |       |
| A-10023                   | ...       | ... | 010 | 85000 | 89436 |       |
| A-11931                   | ...       | ... | 010 | 85000 | 89436 |       |
| A-14583                   | ...       | ... | 010 | 85000 | 89436 |       |



## APPLICATION GUIDE - TRUCKS, TRAILERS, AND BUSES





| Year<br>Año<br>Année | Model<br>Modelo<br>Modèle | OEM # | Front     |        | Rear      |        |
|----------------------|---------------------------|-------|-----------|--------|-----------|--------|
|                      |                           |       |           |        |           |        |
|                      |                           |       | Fleetline | GasSLX | Fleetline | GasSLX |

### HENDRICKSON TRAILER SUSPENSION SYSTEMS(Cont'd.)

#### Additional O.E.M. Interchanges(Cont'd.)

| Models with O.E.M. Number | Fleetline | GasSLX | OEM # | Fleetline | GasSLX |
|---------------------------|-----------|--------|-------|-----------|--------|
| A-1668                    | ...       | ...    | 010   | 85000     | 89436  |
| A-20345                   | ...       | ...    | 010   | 85345     | ...    |
| A-20886                   | ...       | ...    | 010   | 85030     | 89440  |
| A-20887                   | ...       | ...    | 010   | 85005     | 89430  |
| A-2230                    | ...       | ...    | 010   | 85005     | 89430  |
| A-2232                    | ...       | ...    | 010   | 85005     | 89430  |
| A-2240-1                  | ...       | ...    | 010   | 85043     | ...    |
| A-2471                    | ...       | ...    | 010   | 85006     | ...    |
| A-4089                    | ...       | ...    | 010   | 83209     | 89414  |
| A-4890                    | ...       | ...    | 010   | 85712     | ...    |
| A-6156                    | ...       | ...    | 010   | 85301     | ...    |
| B-21832                   | ...       | ...    | 010   | 85323     | 89436  |
| B-21936                   | ...       | ...    | 010   | 85064     | ...    |
| B-21994                   | ...       | ...    | 010   | 85938     | ...    |
| B-21995                   | ...       | ...    | 010   | 85344     | ...    |
| B-22715                   | ...       | ...    | 010   | 85000     | 89436  |
| B-23014                   | ...       | ...    | 010   | 85738     | ...    |
| B-23290                   | ...       | ...    | 010   | 83150     | ...    |
| B-23362                   | ...       | ...    | 010   | ...       | 89437  |
| B-25174                   | ...       | ...    | 010   | 85029     | ...    |
| B-26652                   | ...       | ...    | 010   | 85000     | 89436  |
| B-27058                   | ...       | ...    | 010   | 83128     | 89436  |
| B-27747                   | ...       | ...    | 010   | 85911     | ...    |
| B-29432                   | ...       | ...    | 010   | 85323     | 89436  |
| B-29678                   | ...       | ...    | 010   | 85911     | ...    |
| B-29826                   | ...       | ...    | 010   | 85338     | ...    |
| B-33312                   | ...       | ...    | 010   | 85338     | ...    |
| B-33313                   | ...       | ...    | 010   | 85338     | ...    |
| NS500699                  | ...       | ...    | 010   | 85005     | 89430  |
| S-10348                   | ...       | ...    | 010   | 85043     | ...    |
| S-14583                   | ...       | ...    | 010   | 85000     | 89436  |
| S-1668                    | ...       | ...    | 010   | 85000     | 89436  |
| S-20001                   | ...       | ...    | 010   | 83128     | 89436  |
| S-20002                   | ...       | ...    | 010   | 85000     | 89436  |
| S-20126                   | ...       | ...    | 010   | 85323     | 89436  |
| S-20345                   | ...       | ...    | 010   | 85345     | ...    |
| S-20886                   | ...       | ...    | 010   | 85030     | 89440  |
| S-20887                   | ...       | ...    | 010   | 85005     | 89430  |
| S-20889                   | ...       | ...    | 010   | 85323     | 89436  |
| S-21292                   | ...       | ...    | 010   | 85052     | ...    |
| S-21553                   | ...       | ...    | 010   | 85738     | ...    |
| S-2160                    | ...       | ...    | 010   | 85014     | ...    |
| S-21699                   | ...       | ...    | 010   | 87018     | ...    |
| S-21832                   | ...       | ...    | 010   | 85323     | 89436  |
| S-21936                   | ...       | ...    | 010   | 85064     | ...    |
| S-21947                   | ...       | ...    | 010   | 85052     | ...    |
| S-2212                    | ...       | ...    | 010   | 85029     | ...    |
| S-2213                    | ...       | ...    | 010   | 85010     | ...    |
| S-2218                    | ...       | ...    | 010   | 85030     | 89440  |
| S-2230                    | ...       | ...    | 010   | 85005     | 89430  |
| S-22311                   | ...       | ...    | 010   | 85045     | ...    |
| S-22312                   | ...       | ...    | 010   | 85939     | ...    |
| S-2232                    | ...       | ...    | 010   | 85005     | 89430  |
| S-22345                   | ...       | ...    | 010   | 85911     | ...    |
| S-2240                    | ...       | ...    | 010   | 85013     | 89414  |

**APPLICATION GUIDE - TRUCKS, TRAILERS, AND BUSES**

| Year<br>Año<br>Année | Model<br>Modelo<br>Modèle | OEM # | Front   |   | Rear  |   |
|----------------------|---------------------------|-------|---|---|---|---|
|                      |                           |       |  |  |  |  |
|                      |                           |       | Fleetline   | GasSLX  | Fleetline   | GasSLX  |

**HENDRICKSON TRAILER SUSPENSION SYSTEMS(Cont'd.)**

**Additional O.E.M. Interchanges(Cont'd.)**





|                           |                           |         |     |     |              |              |              |
|---------------------------|---------------------------|---------|-----|-----|--------------|--------------|--------------|
| Models with O.E.M. Number | S-22715                   | ...     | ... | 010 | <b>85000</b> | <b>89436</b> |              |
|                           | S-22862                   | ...     | ... | 010 | <b>85045</b> | ...          |              |
|                           | S-23013                   | ...     | ... | 010 | <b>85000</b> | <b>89436</b> |              |
|                           | S-23014                   | ...     | ... | 010 | <b>85738</b> | ...          |              |
|                           | S-23290                   | ...     | ... | 010 | <b>83150</b> | ...          |              |
|                           | S-23315                   | ...     | ... | 010 | <b>85029</b> | ...          |              |
|                           | S-23316                   | ...     | ... | 010 | <b>85382</b> | ...          |              |
|                           | S-23361                   | ...     | ... | 010 | <b>85911</b> | ...          |              |
|                           | S-23362                   | ...     | ... | 010 | ...          | <b>89437</b> |              |
|                           | S-23548                   | ...     | ... | 010 | <b>85079</b> | ...          |              |
|                           | S-23649                   | ...     | ... | 010 | <b>85064</b> | ...          |              |
|                           | S-23650                   | ...     | ... | 010 | <b>85052</b> | ...          |              |
|                           | S-23651                   | ...     | ... | 010 | <b>85045</b> | ...          |              |
|                           | S-23743                   | ...     | ... | 010 | <b>85938</b> | ...          |              |
|                           | S-24023                   | ...     | ... | 010 | <b>85738</b> | ...          |              |
|                           | S-24125                   | ...     | ... | 010 | <b>85323</b> | <b>89436</b> |              |
|                           | S-24579                   | ...     | ... | 010 | <b>85939</b> | ...          |              |
|                           | S-2471                    | ...     | ... | 010 | <b>85006</b> | ...          |              |
|                           | S-25437                   | ...     | ... | 010 | <b>85337</b> | ...          |              |
|                           | S-25515                   | ...     | ... | 010 | <b>85338</b> | ...          |              |
|                           | S-26652                   | ...     | ... | 010 | <b>85000</b> | <b>89436</b> |              |
|                           | S-29432                   | ...     | ... | 010 | <b>85323</b> | <b>89436</b> |              |
|                           | S-29678                   | ...     | ... | 010 | <b>85911</b> | ...          |              |
|                           | S-29826                   | ...     | ... | 010 | <b>85338</b> | ...          |              |
|                           | S-33312                   | ...     | ... | 010 | <b>85338</b> | ...          |              |
|                           | S-33313                   | ...     | ... | 010 | <b>85338</b> | ...          |              |
|                           | S-33313L                  | ...     | ... | 010 | <b>85338</b> | ...          |              |
|                           | S-4084                    | ...     | ... | 010 | <b>85005</b> | <b>89430</b> |              |
|                           | S-4089                    | ...     | ... | 010 | <b>83209</b> | <b>89414</b> |              |
|                           | S-4890                    | ...     | ... | 010 | <b>85712</b> | ...          |              |
|                           | Models with O.E.M. Number |         |     |     |              |              |              |
|                           | Heavy Duty                | S-24088 | ... | ... | 010          | <b>85000</b> | <b>89436</b> |
|                           | Standard                  | S-24088 | ... | ... | 010          | <b>83128</b> | <b>89436</b> |

**HENDRICKSON TRUCK SUSPENSION SYSTEMS**

**Airtek - Series**

|                                  |                                     |              |              |              |              |     |     |
|----------------------------------|-------------------------------------|--------------|--------------|--------------|--------------|-----|-----|
| Airtek Front<br>Used on BlueBird | 47170000456                         | 010          | <b>85959</b> | ...          | ...          | ... |     |
|                                  | 58913-007                           | 010          | <b>85959</b> | ...          | ...          | ... |     |
|                                  | 58913-007L                          | 010          | <b>85959</b> | ...          | ...          | ... |     |
|                                  | 58913-008                           | 010          | <b>85959</b> | ...          | ...          | ... |     |
|                                  | 58913-008L                          | 010          | <b>85959</b> | ...          | ...          | ... |     |
|                                  | 58913-009                           | 010          | <b>85959</b> | ...          | ...          | ... |     |
|                                  | 58913-009L                          | 010          | <b>85959</b> | ...          | ...          | ... |     |
|                                  | 65992-003                           | 010          | <b>85959</b> | ...          | ...          | ... |     |
|                                  | Used on Freightliner / Western Star | 471700006269 | 010          | <b>85932</b> | <b>89453</b> | ... | ... |
|                                  |                                     | 58913-003    | 010          | <b>85932</b> | <b>89453</b> | ... | ... |
|                                  |                                     | 58913-003L   | 010          | <b>85932</b> | <b>89453</b> | ... | ... |
|                                  |                                     | 58913-012    | 010          | <b>85932</b> | <b>89453</b> | ... | ... |
|                                  | Used on International               | 58913-012L   | 010          | <b>85932</b> | <b>89453</b> | ... | ... |
|                                  |                                     | 65992-001    | 010          | <b>85955</b> | ...          | ... | ... |
|                                  |                                     | 65992-002    | 010          | <b>85955</b> | ...          | ... | ... |
|                                  |                                     | 65992-002L   | 010          | <b>85955</b> | ...          | ... | ... |
|                                  |                                     | 65992-006    | 010          | <b>85986</b> | ...          | ... | ... |

**APPLICATION GUIDE - TRUCKS, TRAILERS, AND BUSES**

| Year<br>Año<br>Année | Model<br>Modelo<br>Modèle | OEM # | Front   |  | Rear  |   |
|----------------------|---------------------------|-------|---|--|---|---|
|                      |                           |       |  |  |  |  |
|                      |                           |       | Fleetline   | GasSLX   | Fleetline   | GasSLX  |

**HENDRICKSON TRUCK SUSPENSION SYSTEMS(Cont'd.)**

**Airtek - Series(Cont'd.)**

|                      |            |     |              |              |  |     |     |
|----------------------|------------|-----|--------------|--------------|--|-----|-----|
| Used on Volvo / Mack | 64838-001  | 010 | <b>85933</b> | <b>89454</b> |  | ... | ... |
|                      | 64838-001L | 010 | <b>85933</b> | <b>89454</b> |  | ... | ... |
|                      | 64838-002  | 010 | <b>85933</b> | <b>89454</b> |  | ... | ... |
|                      | 64838-002L | 010 | <b>85933</b> | <b>89454</b> |  | ... | ... |
|                      | 64838-003  | 010 | <b>85933</b> | <b>89454</b> |  | ... | ... |
|                      | 64838-003L | 010 | <b>85933</b> | <b>89454</b> |  | ... | ... |

**All American Series (FE & RE Models)**

|   |            |     |              |     |  |     |     |
|---|------------|-----|--------------|-----|--|-----|-----|
| Buses with Hendrickson 14,600 lb Capacity-Left Hand Drive Steertek Axle | 58913-011  | 010 | <b>85959</b> | ... |  | ... | ... |
|   | 58913-011L | 010 | <b>85959</b> | ... |  | ... | ... |

**Comfort Air - Series**

|  |              |  |     |     |     |              |     |
|--|--------------|--|-----|-----|-----|--------------|-----|
| Conventional Hino Models with Single Axle Air Suspension | 60670-013    |  | ... | ... | 010 | <b>83148</b> | ... |
|  | 60670-017    |  | ... | ... | 010 | <b>83148</b> | ... |
| Models with O.E.M. Number                                | 471700131545 |  | ... | ... | 010 | <b>85006</b> | ... |
|  | 60998-001    |  | ... | ... | 010 | <b>85006</b> | ... |
|  | 60998-003    |  | ... | ... | 010 | <b>85006</b> | ... |





**Firemaax - Series**

|   |   |           |     |     |     |              |              |     |
|---|---|-----------|-----|-----|-----|--------------|--------------|-----|
| Firemaax 240 Air Suspensions<br>Disc Brake Applications with 8 1/2" to 10" Ride Height<br>Drum Brake Applications with 8 1/2" to 10" Ride Height    | 60665-014   |           | ... | ... | 010 | <b>85962</b> | ...          |     |
|   | 60665-018   |           | ... | ... | 010 | <b>85961</b> | ...          |     |
|   | 60665-018L  |           | ... | ... | 010 | <b>85961</b> | ...          |     |
|   | Standard with 12 1/2" - 14 3/8" - 15 1/2" Ride Height | 60665-011 |     | ... | ... | 010          | <b>85967</b> | ... |
|   | Standard with 8 1/2" to 10" Ride Height               | 60657-003 |     | ... | ... | 010          | <b>85072</b> | ... |
|   | 60657-003L  |           | ... | ... | 010 | <b>85072</b> | ...          |     |
| Firemaax 270 Air Suspensions<br>Disc Brake Applications with 8 1/2" to 10" Ride Height<br>Drum Brake Applications with 8 1/2" to 10" Ride Height    | 60665-015   |           | ... | ... | 010 | <b>85966</b> | ...          |     |
|   | 60665-013   |           | ... | ... | 010 | <b>85965</b> | ...          |     |
| Firemaax 480 Air Suspensions<br>Disc Brake Applications with 8 1/2" to 10" Ride Height<br>Drum Brake Applications with 8 1/2" to 10" Ride Height    | 60665-014   |           | ... | ... | 010 | <b>85962</b> | ...          |     |
|   | 60665-018   |           | ... | ... | 010 | <b>85961</b> | ...          |     |
|   | 60665-018L  |           | ... | ... | 010 | <b>85961</b> | ...          |     |
|   | Standard with 12 1/2" - 14 3/8" - 15 1/2" Ride Height | 60665-011 |     | ... | ... | 010          | <b>85967</b> | ... |
|   | Standard with 8 1/2" to 10" Ride Height               | 60657-003 |     | ... | ... | 010          | <b>85072</b> | ... |
|   | 60657-003L  |           | ... | ... | 010 | <b>85072</b> | ...          |     |
| Firemaax 540 Air Suspensions<br>Disc Brake Applications with 8 1/2" to 10" Ride Height<br>Drum Brake Applications with 8 1/2" to 10" Ride Height    | 60665-015   |           | ... | ... | 010 | <b>85966</b> | ...          |     |
|   | 60665-013   |           | ... | ... | 010 | <b>85965</b> | ...          |     |
| Firemaax EX 242 Air Suspensions<br>Standard with 12 1/2" - 14 3/8" - 15 1/2" Ride Height<br>Standard with 8 1/2" to 10" Ride Height                 | 60665-011   |           | ... | ... | 010 | <b>85967</b> | ...          |     |
|   | 60657-003   |           | ... | ... | 010 | <b>85072</b> | ...          |     |
|   | 60657-003L  |           | ... | ... | 010 | <b>85072</b> | ...          |     |
| Firemaax EX 272 Air Suspensions<br>Disc Brake Applications with 8 1/2" to 10" Ride Height<br>Drum Brake Applications with 8 1/2" to 10" Ride Height | 60665-015   |           | ... | ... | 010 | <b>85966</b> | ...          |     |
|   | 60665-013   |           | ... | ... | 010 | <b>85965</b> | ...          |     |
| Firemaax EX 482 Air Suspensions<br>Standard with 12 1/2" - 14 3/8" - 15 1/2" Ride Height<br>Standard with 8 1/2" to 10" Ride Height                 | 60665-011   |           | ... | ... | 010 | <b>85967</b> | ...          |     |
|   | 60657-003   |           | ... | ... | 010 | <b>85072</b> | ...          |     |
|   | 60657-003L  |           | ... | ... | 010 | <b>85072</b> | ...          |     |
| Firemaax EX 542 Air Suspensions<br>Disc Brake Applications with 8 1/2" to 10" Ride Height<br>Drum Brake Applications with 8 1/2" to 10" Ride Height | 60665-015   |           | ... | ... | 010 | <b>85966</b> | ...          |     |
|   | 60665-013   |           | ... | ... | 010 | <b>85965</b> | ...          |     |

**HA - Series**

|                                    |          |  |     |     |     |              |              |
|------------------------------------|----------|--|-----|-----|-----|--------------|--------------|
| HA - 180 (Used on all except Mack) | 47902-13 |  | ... | ... | 010 | <b>83122</b> | <b>89406</b> |
|                                    | 47902-8  |  | ... | ... | 010 | <b>83122</b> | <b>89406</b> |
| HA - 200 (Used on all except Mack) | 47902-13 |  | ... | ... | 010 | <b>83122</b> | <b>89406</b> |

## APPLICATION GUIDE - TRUCKS, TRAILERS, AND BUSES

| Year<br>Año<br>Année | Model<br>Modelo<br>Modèle | OEM # | Front   |   | Rear  |   |
|----------------------|---------------------------|-------|---|---|---|---|
|                      |                           |       |  |  |  |  |
|                      |                           |       | Wrench  | Fleetline   | GasSLX  | Wrench  |

### HENDRICKSON TRUCK SUSPENSION SYSTEMS(Cont'd.)





#### HA - Series(Cont'd.)

|  |            |  |     |     |     |              |              |
|--|------------|--|-----|-----|-----|--------------|--------------|
| HA - 200 (Used on all except Mack)                 | 47902-8    |  | ... | ... | 010 | <b>83122</b> | <b>89406</b> |
| HA - 230 (Used on all except Mack)                 | 47902-13   |  | ... | ... | 010 | <b>83122</b> | <b>89406</b> |
|  | 47902-8    |  | ... | ... | 010 | <b>83122</b> | <b>89406</b> |
| HA - 360 (Used on all except Mack)                 | 47902-13   |  | ... | ... | 010 | <b>83122</b> | <b>89406</b> |
|  | 47902-8    |  | ... | ... | 010 | <b>83122</b> | <b>89406</b> |
| HA - 400 (Used on all except Mack)                 | 47902-13   |  | ... | ... | 010 | <b>83122</b> | <b>89406</b> |
|  | 47902-8    |  | ... | ... | 010 | <b>83122</b> | <b>89406</b> |
| HA - 460 (Used on all except Mack)                 | 47902-13   |  | ... | ... | 010 | <b>83122</b> | <b>89406</b> |
|  | 47902-8    |  | ... | ... | 010 | <b>83122</b> | <b>89406</b> |
| HA Series Air Suspension (All Models used on Mack) | 47902-19   |  | ... | ... | 010 | <b>83123</b> | <b>89405</b> |
|  | 47902-9    |  | ... | ... | 010 | <b>83123</b> | <b>89405</b> |
| HA-360/400/460 Edge System High Torque Rise        | 60675-003  |  | ... | ... | 010 | <b>85976</b> | ...          |
|  | 60675-003L |  | ... | ... | 010 | <b>85976</b> | ...          |

#### HAS - Series

|   |            |     |     |     |              |              |              |
|---|------------|-----|-----|-----|--------------|--------------|--------------|
| HAS - 120L  | 60670-010  |     | ... | ... | 010          | <b>83149</b> | ...          |
| HAS - 150L  | 60670-003  |     | ... | ... | 010          | <b>83149</b> | ...          |
| HAS - 190<br>With O.E.M. Number   | 60670-005  |     | ... | ... | 010          | <b>83137</b> | ...          |
|   | 60675-003  |     | ... | ... | 010          | <b>85976</b> | ...          |
|   | 60675-003L |     | ... | ... | 010          | <b>85976</b> | ...          |
| HAS - 190L  | 60670-008  |     | ... | ... | 010          | <b>83123</b> | <b>89405</b> |
|   | 60670-008L |     | ... | ... | 010          | <b>83123</b> | <b>89405</b> |
| HAS - 210<br>With O.E.M. Number   | 60670-005  |     | ... | ... | 010          | <b>83137</b> | ...          |
|   | 60675-003  |     | ... | ... | 010          | <b>85976</b> | ...          |
|   | 60675-003L |     | ... | ... | 010          | <b>85976</b> | ...          |
| HAS - 210L  | 60670-008  |     | ... | ... | 010          | <b>83123</b> | <b>89405</b> |
|   | 60670-008L |     | ... | ... | 010          | <b>83123</b> | <b>89405</b> |
| HAS - 230<br>With O.E.M. Number   | 60670-005  |     | ... | ... | 010          | <b>83137</b> | ...          |
|   | 60675-003  |     | ... | ... | 010          | <b>85976</b> | ...          |
|   | 60675-003L |     | ... | ... | 010          | <b>85976</b> | ...          |
| HAS - 230L  | 60670-008  |     | ... | ... | 010          | <b>83123</b> | <b>89405</b> |
|   | 60670-008L |     | ... | ... | 010          | <b>83123</b> | <b>89405</b> |
| HAS - 360<br>With O.E.M. Number   | 60670-005  |     | ... | ... | 010          | <b>83137</b> | ...          |
|   | 60675-003  |     | ... | ... | 010          | <b>85976</b> | ...          |
|   | 60675-003L |     | ... | ... | 010          | <b>85976</b> | ...          |
| HAS - 400<br>Mack & Kenworth Air Suspensions<br>Standard Inboard Rear<br><br>With O.E.M. Number | 47902-25   |     | ... | ... | 010          | <b>83125</b> | ...          |
|   | 60670-007  |     | ... | ... | 010          | <b>83144</b> | ...          |
|   | 60670-007L |     | ... | ... | 010          | <b>83144</b> | ...          |
|   | 60670-005  |     | ... | ... | 010          | <b>83137</b> | ...          |
|   | 60675-003  |     | ... | ... | 010          | <b>85976</b> | ...          |
|   | 60675-003L |     | ... | ... | 010          | <b>85976</b> | ...          |
|   | 60675-006  |     | ... | ... | 010          | <b>85909</b> | ...          |
| 60675-006L  |            | ... | ... | 010 | <b>85909</b> | ...          |              |
| HAS - 400L  | 60670-008  |     | ... | ... | 010          | <b>83123</b> | <b>89405</b> |
|   | 60670-008L |     | ... | ... | 010          | <b>83123</b> | <b>89405</b> |
| HAS - 402<br>Standard Inboard Rear<br><br>With O.E.M. Number                                    | 60670-007  |     | ... | ... | 010          | <b>83144</b> | ...          |
|   | 60670-007L |     | ... | ... | 010          | <b>83144</b> | ...          |
|   | 60670-005  |     | ... | ... | 010          | <b>83137</b> | ...          |
|   | 60675-003  |     | ... | ... | 010          | <b>85976</b> | ...          |

**APPLICATION GUIDE - TRUCKS, TRAILERS, AND BUSES**

| Year<br>Año<br>Année | Model<br>Modelo<br>Modèle | OEM # | Front   |  | Rear  |   |
|----------------------|---------------------------|-------|---|--|---|---|
|                      |                           |       |  |  |  |  |
|                      |                           |       | Fleetline   | GasSLX   | Fleetline   | GasSLX  |

**HENDRICKSON TRUCK SUSPENSION SYSTEMS(Cont'd.)**

**HAS - Series(Cont'd.)**

|  |  |            |     |     |     |              |              |
|--|--|------------|-----|-----|-----|--------------|--------------|
|  | Standard Inboard Rear  | 60675-003L | ... | ... | 010 | <b>85976</b> | ...          |
|  |  | 60675-006  | ... | ... | 010 | <b>85909</b> | ...          |
|  |  | 60675-006L | ... | ... | 010 | <b>85909</b> | ...          |
|  | HAS - 402L   | 60670-008  | ... | ... | 010 | <b>83123</b> | <b>89405</b> |
|  |  | 60670-008L | ... | ... | 010 | <b>83123</b> | <b>89405</b> |
|  | HAS - 40LH<br>With O.E.M. Number                             | 60680-001  | ... | ... | 01- | <b>83111</b> | ...          |
|  |  | 60680-001L | ... | ... | 01- | <b>83111</b> | ...          |
|  |  | 60685-001  | ... | ... | 01- | <b>85977</b> | ...          |
|  | HAS - 460<br>Standard Inboard Rear<br><br>With O.E.M. Number | 60670-007  | ... | ... | 010 | <b>83144</b> | ...          |
|  |  | 60670-007L | ... | ... | 010 | <b>83144</b> | ...          |
|  |  | 60670-005  | ... | ... | 010 | <b>83137</b> | ...          |
|  |  | 60675-003  | ... | ... | 010 | <b>85976</b> | ...          |
|  |  | 60675-003L | ... | ... | 010 | <b>85976</b> | ...          |
|  |  | 60675-006  | ... | ... | 010 | <b>85909</b> | ...          |
|  |  | 60675-006L | ... | ... | 010 | <b>85909</b> | ...          |
|  | HAS - 460L   | 60670-008  | ... | ... | 010 | <b>83123</b> | <b>89405</b> |
|  |  | 60670-008L | ... | ... | 010 | <b>83123</b> | <b>89405</b> |
|  | Models with O.E.M. Number                                    | 60675-014  | ... | ... | 010 | <b>85978</b> | ...          |
|  |  | 60675-8Q   | ... | ... | 010 | <b>85976</b> | ...          |

**HN - Series**

|                |   |            |     |     |     |              |              |
|----------------|---|------------|-----|-----|-----|--------------|--------------|
|                | HN - 400<br>Models built between Mar/96 - Sept/97<br><br>Models built between Nov/88 - Feb/96 | 60680-003  | ... | ... | 01- | <b>83112</b> | ...          |
|                |   | 60680-003L | ... | ... | 01- | <b>83112</b> | ...          |
|                |   | 60670-002  | ... | ... | 010 | <b>83207</b> | <b>89407</b> |
|                |   | 60670-002L | ... | ... | 010 | <b>83207</b> | <b>89407</b> |
|                | HN - 402<br>Models built between Apr/96 - Dec/04  | 57241-003  | ... | ... | 01- | <b>83112</b> | ...          |
|                |   | 60680-003  | ... | ... | 01- | <b>83112</b> | ...          |
|                |   | 60680-003L | ... | ... | 01- | <b>83112</b> | ...          |
|                | HN - 460<br>Models built between Mar/96 - Sept/97<br><br>Models built between Nov/88 - Feb/96 | 57241-003  | ... | ... | 01- | <b>83112</b> | ...          |
|                |   | 60680-003  | ... | ... | 01- | <b>83112</b> | ...          |
|                |   | 60680-003L | ... | ... | 01- | <b>83112</b> | ...          |
|                |   | 60670-002  | ... | ... | 010 | <b>83207</b> | <b>89407</b> |
|                |   | 60670-002L | ... | ... | 010 | <b>83207</b> | <b>89407</b> |
|                | HN - 462<br>Models built between Apr/96 - 2015  | 57241-003  | ... | ... | 01- | <b>83112</b> | ...          |
|                |   | 60680-003  | ... | ... | 01- | <b>83112</b> | ...          |
|                |   | 60680-003L | ... | ... | 01- | <b>83112</b> | ...          |
| <b>96 - 15</b> | HN - 522  | 60680-003  | ... | ... | 01- | <b>83112</b> | ...          |
|                |   | 60680-003L | ... | ... | 01- | <b>83112</b> | ...          |
|                | HNT - 460   | 47902-18   | ... | ... | 010 | <b>85030</b> | <b>89440</b> |





**HTB 400 LT - Series**

|  |                                |           |     |     |     |              |     |
|--|--------------------------------|-----------|-----|-----|-----|--------------|-----|
|  | HTB 400LT Rear Air Suspensions | 60657-006 | ... | ... | 010 | <b>85102</b> | ... |
|  |                                | 60657-010 | ... | ... | 010 | <b>85102</b> | ... |
|  |                                | 60657-011 | ... | ... | 010 | <b>85102</b> | ... |

**Primaax - Series**

|  |   |            |     |     |     |              |     |
|--|---|------------|-----|-----|-----|--------------|-----|
|  | 230 Air Suspensions<br>For International Models with 9" Ride Height<br><br>Standard with 12 1/2" - 14 3/8" - 15 1/2" Ride Height<br>Standard with 8 1/2" to 10" Ride Height | 60657-003  | ... | ... | 010 | <b>85072</b> | ... |
|  |   | 60657-003L | ... | ... | 010 | <b>85072</b> | ... |
|  |   | 60665-011  | ... | ... | 010 | <b>85967</b> | ... |
|  |   | 60657-003  | ... | ... | 010 | <b>85072</b> | ... |

**APPLICATION GUIDE - TRUCKS, TRAILERS, AND BUSES**

| Year<br>Año<br>Année | Model<br>Modelo<br>Modèle | OEM # | Front   |   | Rear  |   |
|----------------------|---------------------------|-------|---|---|---|---|
|                      |                           |       |  |  |  |  |
|                      |                           |       | Fleetline   | GasSLX  | Fleetline   | GasSLX  |

**HENDRICKSON TRUCK SUSPENSION SYSTEMS(Cont'd.)**





**Primaax - Series(Cont'd.)**

|  |  |            |     |     |     |              |     |
|--|--|------------|-----|-----|-----|--------------|-----|
|  | For International Models with 9" Ride Height           | 60657-003L | ... | ... | 010 | <b>85072</b> | ... |
|  | 260 Air Suspensions                                    |            |     |     |     |              |     |
|  | Disc Brake Applications with 8 1/2" to 10" Ride Height | 60665-015  | ... | ... | 010 | <b>85966</b> | ... |
|  | Drum Brake Applications with 8 1/2" to 10" Ride Height | 60665-013  | ... | ... | 010 | <b>85965</b> | ... |
|  | 460 Air Suspensions                                    |            |     |     |     |              |     |
|  | For International Models with 9" Ride Height           | 60657-003  | ... | ... | 010 | <b>85072</b> | ... |
|  |  | 60657-003L | ... | ... | 010 | <b>85072</b> | ... |
|  | Standard with 12 1/2" - 14 3/8" - 15 1/2" Ride Height  | 60665-011  | ... | ... | 010 | <b>85967</b> | ... |
|  | Standard with 8 1/2" to 10" Ride Height                | 60657-003  | ... | ... | 010 | <b>85072</b> | ... |
|  |  | 60657-003L | ... | ... | 010 | <b>85072</b> | ... |
|  | 520 Air Suspensions                                    |            |     |     |     |              |     |
|  | Disc Brake Applications with 8 1/2" to 10" Ride Height | 60665-015  | ... | ... | 010 | <b>85966</b> | ... |
|  | Drum Brake Applications with 8 1/2" to 10" Ride Height | 60665-013  | ... | ... | 010 | <b>85965</b> | ... |
|  | 690 Air Suspensions                                    |            |     |     |     |              |     |
|  | For International Models with 9" Ride Height           | 60657-003  | ... | ... | 010 | <b>85072</b> | ... |
|  |  | 60657-003L | ... | ... | 010 | <b>85072</b> | ... |
|  | Standard with 12 1/2" - 14 3/8" - 15 1/2" Ride Height  | 60665-011  | ... | ... | 010 | <b>85967</b> | ... |
|  | Standard with 8 1/2" to 10" Ride Height                | 60657-003  | ... | ... | 010 | <b>85072</b> | ... |
|  |  | 60657-003L | ... | ... | 010 | <b>85072</b> | ... |
|  | 780 Air Suspensions                                    |            |     |     |     |              |     |
|  | Disc Brake Applications with 8 1/2" to 10" Ride Height | 60665-015  | ... | ... | 010 | <b>85966</b> | ... |
|  | Drum Brake Applications with 8 1/2" to 10" Ride Height | 60665-013  | ... | ... | 010 | <b>85965</b> | ... |
|  | EX 232 Air Suspensions                                 |            |     |     |     |              |     |
|  | Standard with 12 1/2" - 14 3/8" - 15 1/2" Ride Height  | 60665-011  | ... | ... | 010 | <b>85967</b> | ... |
|  | Standard with 8 1/2" to 10" Ride Height                | 60657-003  | ... | ... | 010 | <b>85072</b> | ... |
|  |  | 60657-003L | ... | ... | 010 | <b>85072</b> | ... |
|  | EX 262 Air Suspensions                                 |            |     |     |     |              |     |
|  | Disc Brake Applications with 8 1/2" to 10" Ride Height | 60665-015  | ... | ... | 010 | <b>85966</b> | ... |
|  | Drum Brake Applications with 8 1/2" to 10" Ride Height | 60665-013  | ... | ... | 010 | <b>85965</b> | ... |
|  | EX 462 Air Suspensions                                 |            |     |     |     |              |     |
|  | Standard with 12 1/2" - 14 3/8" - 15 1/2" Ride Height  | 60665-011  | ... | ... | 010 | <b>85967</b> | ... |
|  | Standard with 8 1/2" to 10" Ride Height                | 60657-003  | ... | ... | 010 | <b>85072</b> | ... |
|  |  | 60657-003L | ... | ... | 010 | <b>85072</b> | ... |
|  | EX 522 Air Suspensions                                 |            |     |     |     |              |     |
|  | Disc Brake Applications with 8 1/2" to 10" Ride Height | 60665-015  | ... | ... | 010 | <b>85966</b> | ... |
|  | Drum Brake Applications with 8 1/2" to 10" Ride Height | 60665-013  | ... | ... | 010 | <b>85965</b> | ... |
|  | EX 692 Air Suspensions                                 |            |     |     |     |              |     |
|  | Standard with 12 1/2" - 14 3/8" - 15 1/2" Ride Height  | 60665-011  | ... | ... | 010 | <b>85967</b> | ... |
|  | Standard with 8 1/2" to 10" Ride Height                | 60657-003  | ... | ... | 010 | <b>85072</b> | ... |
|  |  | 60657-003L | ... | ... | 010 | <b>85072</b> | ... |
|  | EX 782 Air Suspensions                                 |            |     |     |     |              |     |
|  | Disc Brake Applications with 8 1/2" to 10" Ride Height | 60665-015  | ... | ... | 010 | <b>85966</b> | ... |
|  | Drum Brake Applications with 8 1/2" to 10" Ride Height | 60665-013  | ... | ... | 010 | <b>85965</b> | ... |
|  | Models with O.E.M. Number                              | 60657-005  | ... | ... | 010 | <b>85087</b> | ... |
|  |  | 60657-005L | ... | ... | 010 | <b>85087</b> | ... |

**Additional Applications**

|  |  |            |     |     |     |              |     |
|--|--|------------|-----|-----|-----|--------------|-----|
|  | Conventional Hino Models with Hendrickson Comfort Air Suspension                       | 60670-020  | ... | ... | 010 | <b>83148</b> | ... |
|  | HAS 400 / 460 Suspensions with O.E.M. Number   | 60675-005  | ... | ... | 010 | <b>85980</b> | ... |
|  |  | 60675-005L | ... | ... | 010 | <b>85980</b> | ... |
|  | HAS 460 Suspensions with O.E.M. Number   | 60675-12   | ... | ... | 010 | <b>85638</b> | ... |
|  | Hendrickson Rear Air Suspension used on Conventional Hino Models ( 23,000 lb Capacity) | 60670-018  | ... | ... | 010 | <b>83166</b> | ... |
|  | HMX 400/460 Haulmax with 16.5" Saddle Height   | 60680-004  | ... | ... | 01- | <b>83143</b> | ... |
|  |  | 60680-004L | ... | ... | 01- | <b>83143</b> | ... |

**APPLICATION GUIDE - TRUCKS, TRAILERS, AND BUSES**

| Year<br>Año<br>Année | Model<br>Modelo<br>Modèle | OEM # | Front   |   | Rear  |  |
|----------------------|---------------------------|-------|---|---|---|--|
|                      |                           |       |  Fleetline |  GasSLX |  Fleetline |  GasSLX |

**HENDRICKSON TRUCK SUSPENSION SYSTEMS(Cont'd.)**

**Additional Applications(Cont'd.)**

|   |            |     |              |     |     |              |              |
|---|------------|-----|--------------|-----|-----|--------------|--------------|
| HMX 400/460 Haulmax with 17.5" or 18.5" Saddle Height   | 60680-005  |     | ...          | ... | 01- | <b>83142</b> | ...          |
|   | 60680-005L |     | ...          | ... | 01- | <b>83142</b> | ...          |
| HTS 210 For Spartan Chassis (Type C School Bus Applications)  | 60665-025  |     | ...          | ... | 010 | <b>85036</b> | <b>89405</b> |
|   | 60665-025L |     | ...          | ... | 010 | <b>85036</b> | <b>89405</b> |
| MaxAir / AL-405 Models  | 57241-006  |     | ...          | ... | 01- | <b>83111</b> | ...          |
|   | 57241-006L |     | ...          | ... | 01- | <b>83111</b> | ...          |
| Parasteer Suspensions<br>Models with O.E.M. Number  | 59483-000  | 010 | <b>85919</b> | ... |     | ...          | ...          |
|   | 60665-005  | 010 | <b>85919</b> | ... |     | ...          | ...          |
|   | 60665-005L | 010 | <b>85919</b> | ... |     | ...          | ...          |
|   | 60998-002  | 010 | <b>85919</b> | ... |     | ...          | ...          |
|   | 60998-002L | 010 | <b>85919</b> | ... |     | ...          | ...          |
| RT2 & RTE2 (400 / 520) Models Air Suspension (Note: For Ride Height of 10.41" to 12.27" with 52" & 54" Beams and 8.52" to 10.37" with 60" Beams.) | 57324-6    |     | ...          | ... | 010 | <b>85904</b> | ...          |

**Additional O.E.M. Interchanges**

|   |            |     |     |     |              |              |              |
|---|------------|-----|-----|-----|--------------|--------------|--------------|
| Hendrickson Comfort Air Rear Air Suspension | 60670-006  |     | ... | ... | 010          | <b>83147</b> | ...          |
|   | 60670-006L |     | ... | ... | 010          | <b>83147</b> | ...          |
| Models with O.E.M. Number                   | 12738      |     | ... | ... | 010          | <b>83225</b> | ...          |
|   | 47902-11   |     | ... | ... | 010          | <b>83207</b> | <b>89407</b> |
|   | 47902-15   |     | ... | ... | 010          | <b>83137</b> | ...          |
|   | 47902-20   |     | ... | ... | 010          | <b>85036</b> | <b>89405</b> |
|   | 47902-21   |     | ... | ... | 010          | <b>85976</b> | ...          |
|   | 47902-22   |     | ... | ... | 010          | <b>85916</b> | <b>89430</b> |
|   | 47902-24   |     | ... | ... | 010          | <b>83137</b> | ...          |
|   | 47902-26   |     | ... | ... | 010          | <b>83144</b> | ...          |
|   | 47902-27   |     | ... | ... | 010          | <b>83123</b> | <b>89405</b> |
|   | 47902-28   |     | ... | ... | 010          | <b>85013</b> | <b>89414</b> |
|   | 47902-29   |     | ... | ... | 010          | <b>83149</b> | ...          |
|   | 47902-3    |     | ... | ... | 010          | <b>85005</b> | <b>89430</b> |
|   | 503610C2   |     | ... | ... | 010          | <b>83207</b> | <b>89407</b> |
|   | 5554596    |     | ... | ... | 010          | <b>85303</b> | <b>89422</b> |
|   | 57241-001  |     | ... | ... | 01-          | <b>83111</b> | ...          |
|   | 57241-002  |     | ... | ... | 01-          | <b>83109</b> | ...          |
|   | 57241-004  |     | ... | ... | 01-          | <b>83110</b> | ...          |
|   | 57324-1    |     | ... | ... | 010          | <b>85036</b> | <b>89405</b> |
|   | 57324-11   |     | ... | ... | 010          | <b>85305</b> | ...          |
|   | 57324-2    |     | ... | ... | 010          | <b>85976</b> | ...          |
|   | 57324-3    |     | ... | ... | 010          | <b>85916</b> | <b>89430</b> |
|   | 57324-5    |     | ... | ... | 010          | <b>85903</b> | ...          |
|   | 57905-1    |     | ... | ... | 010          | <b>85976</b> | ...          |
|   | 58623-1    |     | ... | ... | 010          | <b>85978</b> | ...          |
|   | 59048-001  |     | ... | ... | 010          | <b>83148</b> | ...          |
|   | 59057-001  |     | ... | ... | 010          | <b>83137</b> | ...          |
|   | 59057-002  |     | ... | ... | 010          | <b>85036</b> | <b>89405</b> |
|   | 59305-1    |     | ... | ... | 010          | <b>85979</b> | ...          |
|   | 59851-1    |     | ... | ... | 010          | <b>85976</b> | ...          |
|   | 59852-1    |     | ... | ... | 01-          | <b>85977</b> | ...          |
|   | 59852-2    |     | ... | ... | 01-          | <b>85977</b> | ...          |
|   | 60657-007  |     | ... | ... | 010          | <b>85072</b> | ...          |
| 60665-003                                   |            | ... | ... | 010 | <b>83137</b> | ...          |              |
| 60665-004                                   |            | ... | ... | 010 | <b>85036</b> | <b>89405</b> |              |
| 60665-004L                                  |            | ... | ... | 010 | <b>85036</b> | <b>89405</b> |              |
| 60665-008                                   |            | ... | ... | 010 | <b>85978</b> | ...          |              |
| 60665-009                                   |            | ... | ... | 010 | <b>85904</b> | ...          |              |



## APPLICATION GUIDE - TRUCKS, TRAILERS, AND BUSES





| Year<br>Año<br>Année | Model<br>Modelo<br>Modèle | OEM # | Front     |        | Rear      |        |
|----------------------|---------------------------|-------|-----------|--------|-----------|--------|
|                      |                           |       |           |        |           |        |
|                      |                           |       | Fleetline | GasSLX | Fleetline | GasSLX |

### HENDRICKSON TRUCK SUSPENSION SYSTEMS(Cont'd.)

#### Additional O.E.M. Interchanges(Cont'd.)

| Models with O.E.M. Number | OEM # | Front | Rear | Front | Rear  |
|---------------------------|-------|-------|------|-------|-------|
| 60665-020                 | ...   | ...   | 010  | 85919 | ...   |
| 60665-024                 | ...   | ...   | 010  | 85903 | ...   |
| 60670-001                 | ...   | ...   | 010  | 83123 | 89405 |
| 60670-004                 | ...   | ...   | 010  | 83123 | 89405 |
| 60670-009                 | ...   | ...   | 010  | 85013 | 89414 |
| 60670-011                 | ...   | ...   | 010  | 83148 | ...   |
| 60670-012                 | ...   | ...   | 010  | 83168 | ...   |
| 60670-014                 | ...   | ...   | 010  | 83166 | ...   |
| 60670-019                 | ...   | ...   | 010  | 83166 | ...   |
| 60670-12                  | ...   | ...   | 010  | 83168 | ...   |
| 60675-001                 | ...   | ...   | 010  | 85978 | ...   |
| 60675-001L                | ...   | ...   | 010  | 85978 | ...   |
| 60675-002                 | ...   | ...   | 010  | 85979 | ...   |
| 60675-002L                | ...   | ...   | 010  | 85979 | ...   |
| 60680-002                 | ...   | ...   | 01-  | 83109 | ...   |
| 60680-009                 | ...   | ...   | 01-  | 85083 | ...   |
| 60680-012                 | ...   | ...   | 01-  | 85083 | ...   |
| 60680-012L                | ...   | ...   | 01-  | 85083 | ...   |
| 654890                    | ...   | ...   | 010  | 83207 | 89407 |
| 654891                    | ...   | ...   | 010  | 83149 | ...   |
| 654894                    | ...   | ...   | 010  | 83123 | 89405 |
| 654895                    | ...   | ...   | 010  | 83137 | ...   |
| 654896                    | ...   | ...   | 010  | 83147 | ...   |
| 654897                    | ...   | ...   | 010  | 83144 | ...   |
| 654897                    | ...   | ...   | 010  | 83144 | ...   |
| 654898                    | ...   | ...   | 010  | 83123 | 89405 |
| 654899                    | ...   | ...   | 010  | 85013 | 89414 |
| 654900                    | ...   | ...   | 010  | 83149 | ...   |
| 654903                    | ...   | ...   | 01-  | 83111 | ...   |
| 654904                    | ...   | ...   | 01-  | 83109 | ...   |
| 654905                    | ...   | ...   | 01-  | 83112 | ...   |
| 659000                    | ...   | ...   | 010  | 83148 | ...   |
| 659004                    | ...   | ...   | 010  | 83123 | 89405 |
| 659048                    | ...   | ...   | 01-  | 83143 | ...   |
| 659049                    | ...   | ...   | 01-  | 83142 | ...   |
| 659155                    | ...   | ...   | 010  | 83147 | ...   |
| 659202                    | ...   | ...   | 010  | 83148 | ...   |
| 659292                    | ...   | ...   | 010  | 83148 | ...   |
| 665816                    | ...   | ...   | 010  | 85072 | ...   |
| 665892                    | ...   | ...   | 010  | 85072 | ...   |
| 671006                    | ...   | ...   | 010  | 85036 | 89405 |
| 671007                    | ...   | ...   | 010  | 83137 | ...   |
| 671009                    | ...   | ...   | 010  | 85919 | ...   |
| 671030                    | ...   | ...   | 01-  | 85083 | ...   |
| 671063                    | ...   | ...   | 01-  | 85083 | ...   |
| 671105                    | ...   | ...   | 010  | 85072 | ...   |
| 671603                    | ...   | ...   | 010  | 85919 | ...   |
| 671606                    | 010   | 85955 | ...  | ...   | ...   |
| 671611                    | 010   | 85955 | ...  | ...   | ...   |
| 671704                    | ...   | ...   | 010  | 85904 | ...   |
| 671764                    | ...   | ...   | 010  | 85967 | ...   |
| 671792                    | ...   | ...   | 010  | 85965 | ...   |
| 671793                    | ...   | ...   | 010  | 85966 | ...   |
| 671798                    | ...   | ...   | 010  | 85962 | ...   |
| 672009                    | ...   | ...   | 010  | 85903 | ...   |

## APPLICATION GUIDE - TRUCKS, TRAILERS, AND BUSES

| Year<br>Año<br>Année | Model<br>Modelo<br>Modèle | OEM # | Front   |  | Rear  |   |
|----------------------|---------------------------|-------|---|--|---|---|
|                      |                           |       |  |  |  |  |
|                      |                           |       | Fleetline   | GasSLX   | Fleetline   | GasSLX  |

### HENDRICKSON TRUCK SUSPENSION SYSTEMS(Cont'd.)

#### Additional O.E.M. Interchanges(Cont'd.)

|  |                           |           |  |     |     |     |              |              |
|--|---------------------------|-----------|--|-----|-----|-----|--------------|--------------|
|  | Models with O.E.M. Number | 680091    |  | ... | ... | OIO | <b>85303</b> | <b>89422</b> |
|  |                           | 680600    |  | ... | ... | OIO | <b>85305</b> | ...          |
|  |                           | 70018     |  | ... | ... | OIO | <b>85303</b> | <b>89422</b> |
|  |                           | 70021     |  | ... | ... | OIO | <b>85303</b> | <b>89422</b> |
|  |                           | 70088     |  | ... | ... | OIO | <b>85307</b> | ...          |
|  |                           | 98583-005 |  | ... | ... | OIO | <b>83168</b> | ...          |
|  |                           | 98583-006 |  | ... | ... | OIO | <b>83148</b> | ...          |
|  |                           | 98583-016 |  | ... | ... | OIO | <b>83147</b> | ...          |
|  |                           | 98583-032 |  | ... | ... | OIO | <b>85072</b> | ...          |
|  |                           | AE76164-3 |  | ... | ... | OIO | <b>85307</b> | ...          |
|  |                           | AE76164-4 |  | ... | ... | OIO | <b>83225</b> | ...          |
|  |                           | BE76164-2 |  | ... | ... | OIO | <b>85303</b> | <b>89422</b> |
|  |                           | BE76164-3 |  | ... | ... | OIO | <b>85307</b> | ...          |
|  |                           | BE76164-4 |  | ... | ... | OIO | <b>83225</b> | ...          |

### HIGHWAY PRODUCT

|  |   |          |  |     |              |              |     |              |              |
|--|---|----------|--|-----|--------------|--------------|-----|--------------|--------------|
|  | Transit Bus with Air Suspension         | .....    |  | OIO | <b>83203</b> | <b>89436</b> | ... | ...          |              |
|  | Transit Bus with Leaf Spring Suspension | .....    |  |     | <b>83203</b> | ...          | OIO | <b>83203</b> | <b>89436</b> |
|  |   | A1-6-134 |  |     | ...          | ...          | OIO | <b>83207</b> | <b>89407</b> |
|  |   | A1-6-135 |  | OIO | <b>83203</b> | <b>89436</b> |     | ...          | ...          |

### HINO

#### 145 Series

|         |                           |             |  |     |              |              |     |               |     |
|---------|---------------------------|-------------|--|-----|--------------|--------------|-----|---------------|-----|
| 05 - 10 | Models with O.E.M. Number | 48500-3710  |  | OIO | <b>83126</b> | <b>89430</b> | ... | ...           |     |
|         |                           | 485003710A  |  | OIO | <b>83126</b> | <b>89430</b> | ... | ...           |     |
|         |                           | S4850-03710 |  | OIO | <b>83126</b> | <b>89430</b> | ... | ...           |     |
|         |                           | 48530-3280  |  |     | ...          | ...          | OIO | <b>G63440</b> | ... |
|         |                           | S4853-03280 |  |     | ...          | ...          | OIO | <b>G63440</b> | ... |

#### 155 Series

|         |                           |             |  |     |              |     |     |     |
|---------|---------------------------|-------------|--|-----|--------------|-----|-----|-----|
| 13 - 17 | Models with O.E.M. Number | 48511-37320 |  | -IO | <b>83518</b> | ... | ... | ... |
| 13 - 18 | Models with O.E.M. Number | 48511-80162 |  | -IO | <b>83518</b> | ... | ... | ... |

#### 165 Series

|         |                           |             |  |     |              |              |     |               |     |
|---------|---------------------------|-------------|--|-----|--------------|--------------|-----|---------------|-----|
| 05 - 10 | Models with O.E.M. Number | 48500-3710  |  | OIO | <b>83126</b> | <b>89430</b> | ... | ...           |     |
|         |                           | 485003710A  |  | OIO | <b>83126</b> | <b>89430</b> | ... | ...           |     |
|         |                           | S4850-03710 |  | OIO | <b>83126</b> | <b>89430</b> | ... | ...           |     |
|         |                           | 48530-3280  |  |     | ...          | ...          | OIO | <b>G63440</b> | ... |
|         |                           | S4853-03280 |  |     | ...          | ...          | OIO | <b>G63440</b> | ... |

#### 185 Series

|         |                           |             |  |     |              |              |     |               |     |
|---------|---------------------------|-------------|--|-----|--------------|--------------|-----|---------------|-----|
| 05 - 10 | Models with O.E.M. Number | 48500-3710  |  | OIO | <b>83126</b> | <b>89430</b> | ... | ...           |     |
|         |                           | 485003710A  |  | OIO | <b>83126</b> | <b>89430</b> | ... | ...           |     |
|         |                           | 48500-3720  |  | OIO | <b>83140</b> | ...          | ... | ...           |     |
|         |                           | S4850-03710 |  | OIO | <b>83126</b> | <b>89430</b> | ... | ...           |     |
|         |                           | S4850-03720 |  | OIO | <b>83140</b> | ...          | ... | ...           |     |
|         |                           | 48530-3280  |  |     | ...          | ...          | OIO | <b>G63440</b> | ... |
|         |                           | S4853-03280 |  |     | ...          | ...          | OIO | <b>G63440</b> | ... |





#### 195 Series

|         |  |             |  |     |              |     |     |              |     |
|---------|--|-------------|--|-----|--------------|-----|-----|--------------|-----|
| 12 - 17 | Models with Hendrickson Comfort Air Suspension ( 23,000 lb Capacity) | 60670-018   |  |     | ...          | ... | OIO | <b>83166</b> | ... |
| 13 - 17 | Models with O.E.M. Number  | 48511-37320 |  | -IO | <b>83518</b> | ... | ... | ...          | ... |
| 13 - 18 | Models with O.E.M. Number  | 48511-80162 |  | -IO | <b>83518</b> | ... | ... | ...          | ... |
|         |  | 48531-37361 |  |     | ...          | ... | OIO | <b>83519</b> | ... |
|         |  | 48531-37362 |  |     | ...          | ... | OIO | <b>83519</b> | ... |

#### 238 Series

|         |                           |            |  |     |              |     |     |     |
|---------|---------------------------|------------|--|-----|--------------|-----|-----|-----|
| 05 - 14 | Models with O.E.M. Number | 48500-3720 |  | OIO | <b>83140</b> | ... | ... | ... |
|---------|---------------------------|------------|--|-----|--------------|-----|-----|-----|

## APPLICATION GUIDE - TRUCKS, TRAILERS, AND BUSES

| Year<br>Año<br>Année | Model<br>Modelo<br>Modèle | OEM # | Front  |   | Rear   |   |
|----------------------|---------------------------|-------|--|---|--|---|
|                      |                           |       | <br>Fleetline | <br>GasSLX | <br>Fleetline | <br>GasSLX |

### HINO(Cont'd.)

#### 238 Series(Cont'd.)

|         |                           |             |     |       |     |     |     |
|---------|---------------------------|-------------|-----|-------|-----|-----|-----|
| 05 - 14 | Models with O.E.M. Number | S4850-03720 | OIO | 83140 | ... | ... | ... |
| 15 - 16 | Models with O.E.M. Number | 48500-E0420 | OIO | 83391 | ... | ... | ... |

#### 258 Series

|         |  |             |     |       |     |     |       |     |
|---------|--|-------------|-----|-------|-----|-----|-------|-----|
| 08 - 18 | 258 ALP Models with Hendrickson Rear Air Suspension            | 60670-014   |     | ...   | ... | OIO | 83166 | ... |
|         |  | 60670-019   |     | ...   | ... | OIO | 83166 | ... |
| 08 - 18 | 258 LP Car Carrier Models with Hendrickson Rear Air Suspension | 48530E0100  |     | ...   | ... | OIO | 83166 | ... |
|         |  | 60670-014   |     | ...   | ... | OIO | 83166 | ... |
| 08 - 18 | 258 Models with Hendrickson Rear Air Suspension                | 60670-014   |     | ...   | ... | OIO | 83166 | ... |
|         |  | 60670-019   |     | ...   | ... | OIO | 83166 | ... |
| 05 - 14 | Models with O.E.M. Number                                      | 48500-3720  | OIO | 83140 | ... | ... | ...   | ... |
|         |  | S4850-03720 | OIO | 83140 | ... | ... | ...   | ... |
| 15 - 18 | Models with O.E.M. Number                                      | 48500-E0420 | OIO | 83391 | ... | ... | ...   |     |

#### 268, 268A Series

|         |  |             |     |       |     |     |       |     |
|---------|--|-------------|-----|-------|-----|-----|-------|-----|
|         | Models with Hendrickson Rear Air Suspension (Shock stamping #) | 60670-012   |     | ...   | ... | OIO | 83168 | ... |
| 05 - 14 | Models with O.E.M. Number                                      | 48500-3720  | OIO | 83140 | ... | ... | ...   | ... |
|         |  | S4850-03720 | OIO | 83140 | ... | ... | ...   | ... |
| 15 - 18 | Models with O.E.M. Number                                      | 48500-E0420 | OIO | 83391 | ... | ... | ...   |     |

#### 308 Series

|         |                           |             |     |       |     |     |     |     |
|---------|---------------------------|-------------|-----|-------|-----|-----|-----|-----|
| 07 - 10 | Models with O.E.M. Number | 48500-3720  | OIO | 83140 | ... | ... | ... | ... |
|         |                           | S4850-03720 | OIO | 83140 | ... | ... | ... | ... |

#### 338 Series

|         |   |             |     |       |     |     |       |     |
|---------|---|-------------|-----|-------|-----|-----|-------|-----|
| 08 - 17 | Models with Hendrickson Rear Air Suspension | 48530E0100  |     | ...   | ... | OIO | 83166 | ... |
|         |   | 60670-014   |     | ...   | ... | OIO | 83166 | ... |
| 05 - 14 | Models with O.E.M. Number                   | 48500-3720  | OIO | 83140 | ... | ... | ...   | ... |
|         |   | S4850-03720 | OIO | 83140 | ... | ... | ...   | ... |
| 15 - 17 | Models with O.E.M. Number                   | 48500-E0420 | OIO | 83391 | ... | ... | ...   |     |





#### 358 Series

|         |   |             |     |       |     |     |       |     |
|---------|---|-------------|-----|-------|-----|-----|-------|-----|
|         | Models with Hendrickson Rear Air Suspension | 48530E0100  |     | ...   | ... | OIO | 83166 | ... |
|         |   | 60670-014   |     | ...   | ... | OIO | 83166 | ... |
| 07 - 14 | Models with O.E.M. Number                   | 48500-3720  | OIO | 83140 | ... | ... | ...   | ... |
|         |   | S4850-03720 | OIO | 83140 | ... | ... | ...   | ... |
| 15 - 17 | Models with O.E.M. Number                   | 48500-E0420 | OIO | 83391 | ... | ... | ...   |     |

#### FA, FB Series

|         |  |             |     |        |     |     |        |     |
|---------|--|-------------|-----|--------|-----|-----|--------|-----|
| 89 - 04 | FA, FB Models Trucks with:<br>Front Shock with O.E.M. Number | 48500-1950  | -IO | G63610 | ... | ... | ...    | ... |
|         |  | 48500-2750  | -IO | G63610 | ... | ... | ...    |     |
|         |  | 66639       | -IO | G63610 | ... | ... | ...    |     |
|         |  | S4850-01950 | -IO | G63610 | ... | ... | ...    |     |
|         |  | S4850-02750 | -IO | G63610 | ... | ... | ...    |     |
|         | Rear Shock with O.E.M. Number                                | 34802       |     | ...    | ... | OIO | 83216  | ... |
|         |  | 48530-1910  |     | ...    | ... | OIO | 83216  | ... |
|         |  | 48530-2510  |     | ...    | ... | OIO | 83216  | ... |
|         |  | S4853-01910 |     | ...    | ... | OIO | 83216  | ... |
|         |  | S4853-02510 |     | ...    | ... | OIO | 83216  | ... |
| 89 - 96 | FA14, FB14   | 48500-1950  | -IO | G63610 | ... | ... | ...    | ... |
|         |  | 48530-1910  |     | ...    | ... | OIO | 83216  | ... |
| 93 - 97 | FA1415 (FA15), FB1715 (FB15)                                 | 48500-1950  | -IO | G63610 | ... | ... | ...    | ... |
|         |  | 48530-1910  |     | ...    | ... | OIO | 83216  | ... |
| 92 - 96 | FA15, FB15   | 48500-1950  | -IO | G63610 | ... | ... | ...    | ... |
|         |  | 48530-1910  |     | ...    | ... | OIO | 83216  | ... |
| 1998    | FA1517, FA1817, FB1817                                       | .....       |     | ...    | ... | OIO | G63419 | ... |
|         |  | 48530-2510  |     | ...    | ... | OIO | 83216  | ... |

## APPLICATION GUIDE - TRUCKS, TRAILERS, AND BUSES

| Year<br>Año<br>Année | Model<br>Modelo<br>Modèle | OEM # | Front  |   |   | Rear  |   |  |
|----------------------|---------------------------|-------|--|---|---|---|---|--|
|                      |                           |       |  |  |  |  |  |  |

### HINO(Cont'd.)

#### FD Series(Cont'd.)

|         |                                     |            |     |       |     |     |       |
|---------|-------------------------------------|------------|-----|-------|-----|-----|-------|
| 98 - 03 | FD Models Trucks with O.E.M. Number | 48500-1801 | 010 | 83216 | ... | ... | ...   |
|         |                                     | 48530-1880 |     | ...   | ... | 010 | 83362 |
| 86 - 87 | FD16                                | 48500-1801 | 010 | 83216 | ... | ... | ...   |
|         |                                     | 48530-1880 |     | ...   | ... | 010 | 83362 |
| 88 - 91 | FD17                                | 48500-1801 | 010 | 83216 | ... | ... | ...   |
|         |                                     | 48530-1880 |     | ...   | ... | 010 | 83362 |
| 1992    | FD20                                | 48500-1801 | 010 | 83216 | ... | ... | ...   |
| 93 - 97 | FD2218, FD2218LD (FD5H). FE5H, FF5H | 48500-1801 | 010 | 83216 | ... | ... | ...   |
|         |                                     | 48530-1880 |     | ...   | ... | 010 | 83362 |
| 1998    | FD2220, FD2220 Lo Pro               | 48500-1801 | 010 | 83216 | ... | ... | ...   |

#### FE Series

|         |   |             |     |       |     |     |        |     |
|---------|---|-------------|-----|-------|-----|-----|--------|-----|
| 86 - 87 | FE16  | 48500-1801  | 010 | 83216 | ... | ... | ...    |     |
|         |   | 48530-1890  |     | ...   | ... | 010 | 83104  | ... |
| 84 - 91 | FE17, FE19  | 48530-1900  |     | ...   | ... | 010 | 83104  | ... |
| 1992    | FE20  | 48530-1900  |     | ...   | ... | 010 | 83104  | ... |
| 93 - 97 | FE2618 (FE5H)   | 48530-1900  |     | ...   | ... | 010 | 83104  | ... |
| 1998    | FE2620  | 48530-1880  |     | ...   | ... | 010 | 83362  | ... |
| 98 - 04 | FE Models Trucks with:<br>Front Shock with O.E.M. Number<br><br>Rear Shock with O.E.M. Number | 48500-1941  | 010 | 83141 | ... | ... | ...    |     |
|         |   | S4850-01941 | 010 | 83141 | ... | ... | ...    |     |
|         |   | 48530-1900  |     | ...   | ... | 010 | 83104  | ... |
|         |   | S4853-01900 |     | ...   | ... | 010 | 83104  | ... |
|         |   | 48530-3280  |     | ...   | ... | 010 | G63440 | ... |
|         |   | S4853-03280 |     | ...   | ... | 010 | G63440 | ... |

#### FF Series

|         |                                     |            |     |       |     |     |       |     |
|---------|-------------------------------------|------------|-----|-------|-----|-----|-------|-----|
| 98 - 03 | FF Models Trucks with O.E.M. Number | 48500-1941 | 010 | 83141 | ... | ... | ...   |     |
|         |                                     | 48530-1900 |     | ...   | ... | 010 | 83104 | ... |
| 84 - 91 | FF17, FF19                          | 48530-1900 |     | ...   | ... | 010 | 83104 | ... |
| 1992    | FF20, FF23                          | 48530-1900 |     | ...   | ... | 010 | 83104 | ... |
| 93 - 97 | FF3018 (FF5H)                       | 48530-1900 |     | ...   | ... | 010 | 83104 | ... |
| 93 - 97 | FF3020 (FF4H)                       | 48530-1900 |     | ...   | ... | 010 | 83104 | ... |
| 1998    | FF3320                              | 48530-1880 |     | ...   | ... | 010 | 83362 | ... |
| 87 - 88 | FFC1                                | 48530-1900 |     | ...   | ... | 010 | 83104 | ... |

#### FG Series

|         |            |            |  |     |     |     |       |     |
|---------|------------|------------|--|-----|-----|-----|-------|-----|
| 84 - 85 | FG19, FG22 | 48530-1900 |  | ... | ... | 010 | 83104 | ... |
|---------|------------|------------|--|-----|-----|-----|-------|-----|





#### GC Series

|         |      |            |     |       |     |     |       |
|---------|------|------------|-----|-------|-----|-----|-------|
| 90 - 91 | GC17 | 48500-1801 | 010 | 83216 | ... | ... | ...   |
|         |      | 48530-2050 |     | ...   | ... | 010 | 83217 |
| 1992    | GC20 | 48500-1801 | 010 | 83216 | ... | ... | ...   |
|         |      | 48530-2050 |     | ...   | ... | 010 | 83217 |

#### SG Series

|         |                                     |             |     |       |     |     |     |
|---------|-------------------------------------|-------------|-----|-------|-----|-----|-----|
| 98 - 03 | SG Models Trucks with O.E.M. Number | 48500-1941  | 010 | 83141 | ... | ... | ... |
|         |                                     | S4850-01941 | 010 | 83141 | ... | ... | ... |
| 86 - 91 | SG19                                | 48500-1941  | 010 | 83141 | ... | ... | ... |
| 1992    | SG20                                | 48500-1941  | 010 | 83141 | ... | ... | ... |
| 1986    | SG22 Straight Truck                 | 48500-1941  | 010 | 83141 | ... | ... | ... |
| 1986    | SG221 Tractor                       | 48500-1941  | 010 | 83141 | ... | ... | ... |
| 87 - 92 | SG23 Straight Truck                 | 48500-1941  | 010 | 83141 | ... | ... | ... |
| 87 - 92 | SG231 Tractor                       | 48500-1941  | 010 | 83141 | ... | ... | ... |
| 93 - 97 | SG3320 (SG4H)                       | 48500-1941  | 010 | 83141 | ... | ... | ... |
| 93 - 97 | SG3323 (SG1H) Straight Truck        | 48500-1941  | 010 | 83141 | ... | ... | ... |
| 93 - 97 | SG5523 (SG1HD) Tractor              | 48500-1941  | 010 | 83141 | ... | ... | ... |

## APPLICATION GUIDE - TRUCKS, TRAILERS, AND BUSES

| Year<br>Año<br>Année | Model<br>Modelo<br>Modèle | OEM # | Front   |   | Rear  |   |
|----------------------|---------------------------|-------|---|---|---|---|
|                      |                           |       |  |  |  |  |
|                      |                           |       | Fleetline   | GasSLX  | Fleetline   | GasSLX  |

### HINO(Cont'd.)

#### Additional Applications(Cont'd.)

|  |   |            |     |       |     |     |       |     |
|--|---|------------|-----|-------|-----|-----|-------|-----|
|  | Conventional Hino Models with Hendrickson Comfort Air Suspension                                  | 60670-020  |     | ...   | ... | 010 | 83148 | ... |
|  | Conventional Hino Models with Hendrickson Comfort Air Suspension ( 23,000 lb Capacity)            | 60670-018  |     | ...   | ... | 010 | 83166 | ... |
|  | Conventional Hino Models with Hendrickson Comfort Air Suspension (19,000 lb & 21,000 lb Capacity) | 60670-013  |     | ...   | ... | 010 | 83148 | ... |
|  | Conventional Hino Models with Hendrickson Rear Air Suspension                                     | 60670-014  |     | ...   | ... | 010 | 83166 | ... |
|  |   | 60670-019  |     | ...   | ... | 010 | 83166 | ... |
|  | Models with O.E.M. Number   | 48500-1800 | 010 | 83216 | ... |     | ...   | ... |
|  |   | 48500-1940 | 010 | 83141 | ... |     | ...   | ... |
|  |   | 48530-1120 |     | ...   | ... | 010 | 83104 | ... |
|  |   | 48530-1460 |     | ...   | ... | 010 | 83215 | ... |
|  |   | 48530-1620 |     | ...   | ... | 010 | 83104 | ... |
|  |   | 48530-1770 |     | ...   | ... | 010 | 83215 | ... |

### HOBBS TRAILERS

|  |                           |        |  |     |     |     |       |       |
|--|---------------------------|--------|--|-----|-----|-----|-------|-------|
|  | Models with O.E.M. Number | 680117 |  | ... | ... | 010 | 85300 | 89419 |
|--|---------------------------|--------|--|-----|-----|-----|-------|-------|





### HOLIDAY RAMBLER

|  |  |           |  |     |     |     |        |     |
|--|--|-----------|--|-----|-----|-----|--------|-----|
|  | Models with Mor-Ryde Suspension          | U0109-007 |  | ... | ... | 010 | G63183 | ... |
|  | Models with Neway Trailer Air Suspension | 90044794  |  | ... | ... | 010 | 83127  | ... |

#### Class A MotorHomes

|         |  |                |       |       |       |       |       |       |
|---------|--|----------------|-------|-------|-------|-------|-------|-------|
| 90 - 97 | Admiral, Endeavor Gas and Vacationer Models with F53 Motorhome Chassis (7.5 L, Gas V8)                   | .....          |       | ...   | ...   | 010   | 85097 | ...   |
| 99 - 19 | Admiral, Endeavor Gas and Vacationer Models with Ford F53 Motorhome Chassis (16,000 lb to 22,000 lb GVW) | 1C34-18045-AA  | 010   | 83209 | 89414 |       | ...   | ...   |
|         |  | 1C34-18045-JA  | 010   | 83209 | 89414 |       | ...   | ...   |
|         |  | 9U94-18045-AA  | 010   | 83209 | 89414 |       | ...   | ...   |
|         |  | 9U94-18080-AA  |       | ...   | ...   | 010   | 83122 | 89406 |
|         |  | 9U9Z-18124-A   | 010   | 83209 | 89414 |       | ...   | ...   |
|         |  | 9U9Z-18125-A   |       | ...   | ...   | 010   | 83122 | 89406 |
|         |  | ASH-1022       | 010   | 83209 | 89414 |       | ...   | ...   |
|         |  | ASH-1023       |       | ...   | ...   | 010   | 83122 | 89406 |
|         |  | ASH-1205       | 010   | 83209 | 89414 |       | ...   | ...   |
|         |  | ASH-1206       |       | ...   | ...   | 010   | 83122 | 89406 |
|         |  | ASH-1228       | 010   | 83209 | 89414 |       | ...   | ...   |
|         |  | ASH-1229       | 010   | 83209 | 89414 |       | ...   | ...   |
|         |  | ASH-1230       |       | ...   | ...   | 010   | 83122 | 89406 |
|         |  | ASH-137        |       | ...   | ...   | 010   | 83122 | 89406 |
|         |  | ASH-25822      | 010   | 83209 | 89414 |       | ...   | ...   |
|         |  | ASH-25823      | 010   | 83209 | 89414 |       | ...   | ...   |
|         |  | ASH-25824      |       | ...   | ...   | 010   | 83122 | 89406 |
|         |  | ASH-294        | 010   | 83209 | 89414 |       | ...   | ...   |
| AT-620  | 010  | 83209          | 89414 |       | ...   | ...   |       |       |
| AT-621  |  | ...            | ...   | 010   | 83122 | 89406 |       |       |
| AT-766  | 010  | 83209          | 89414 |       | ...   | ...   |       |       |
| 05 - 14 | Models with Workhorse W20 , W22, & W24 MotorHome Chassis with O.E.M. Number                              | 24-153256      |       | ...   | ...   | - -   | 85124 | ...   |
|         |  | F4-BE5-F325-HO |       | ...   | ...   | - -   | 85124 | ...   |
|         |  | W0005663       |       | ...   | ...   | - -   | 85124 | ...   |
| 98 - 04 | Models with Workhorse W20 , W22, & W24 MotorHome Chassis with O.E.M. Number                              | 24-186537      |       | ...   | ...   | 01-   | 85126 | ...   |
|         |  | F4-BE5-A011-HO |       | ...   | ...   | 01-   | 85126 | ...   |
| 98 - 14 | Models with Workhorse W20 , W22, & W24 MotorHome Chassis with O.E.M. Number                              | 24-153249      | 010   | 85125 | ...   |       | ...   | ...   |
|         |  | 24-186629      | 010   | 85125 | ...   |       | ...   | ...   |
|         |  | F4-BE5-A832-MO | 010   | 85125 | ...   |       | ...   | ...   |

**APPLICATION GUIDE - TRUCKS, TRAILERS, AND BUSES**

| Year<br>Año<br>Année | Model<br>Modelo<br>Modèle | OEM # | Front   |  | Rear  |   |
|----------------------|---------------------------|-------|---|--|---|---|
|                      |                           |       |  |  |  |  |
|                      |                           |       | Fleetline   | GasSLX   | Fleetline   | GasSLX  |

**HOLIDAY RAMBLER(Cont'd.)**

**Class A MotorHomes(Cont'd.)**

|         |   |                |     |       |     |     |       |     |
|---------|---|----------------|-----|-------|-----|-----|-------|-----|
| 98 - 14 | Models with Workhorse W20 , W22, & W24 MotorHome Chassis with O.E.M. Number | F4-BE5-B492-HO | 010 | 85125 | ... |     | ...   | ... |
|         |   | F4-BE5-F324-HO | 010 | 85125 | ... |     | ...   | ... |
|         |   | W0005662       | 010 | 85125 | ... |     | ...   | ... |
|         |   | W0006254       | 010 | 85125 | ... |     | ...   | ... |
| 95 - 99 | MotorHomes with Freightliner XC Chassis (22,000 to 26,000 lb GVW)           | .....          | 010 | 83160 | ... | 010 | 85029 | ... |

**Class C MotorHomes**

|         |  |          |     |       |     |     |       |     |
|---------|--|----------|-----|-------|-----|-----|-------|-----|
| 18 - 19 | Altera Series MotorHomes with Ford E450 Chassis  | ASH-1136 |     | ...   | ... | -10 | 83178 | ... |
|         |  | ASH-1154 | -10 | 83177 | ... |     | ...   | ... |
| 99 - 06 | Atlantis Models with Ford E450 Chassis           | ASH-1136 |     | ...   | ... | -10 | 83178 | ... |
|         |  | ASH-1154 | -10 | 83177 | ... |     | ...   | ... |
| 07 - 18 | Augusta Series MotorHomes with Ford E450 Chassis | ASH-1136 |     | ...   | ... | -10 | 83178 | ... |
|         |  | ASH-1154 | -10 | 83177 | ... |     | ...   | ... |
| 17 - 19 | Vesta Series MotorHomes with Ford E450 Chassis   | ASH-1136 |     | ...   | ... | -10 | 83178 | ... |
|         |  | ASH-1154 | -10 | 83177 | ... |     | ...   | ... |

**HOLLAND - BINKLEY**

|  |  |        |  |     |     |     |       |     |
|--|--|--------|--|-----|-----|-----|-------|-----|
|  | Air Plus Integrated Air Susp. with ProPar Parallel Spindle Axles | 6898   |  | ... | ... | 010 | 83125 | ... |
|  | Holland ProPar NT2 Air Suspension                                | 680298 |  | ... | ... | 010 | 85321 | ... |

**HOLLAND (SEE NEWAY)**

|  |  |  |  |  |  |  |  |  |
|--|--|--|--|--|--|--|--|--|
| Refer to SAF Holland Section for application information |  |  |  |  |  |  |  |  |
|--|--|--|--|--|--|--|--|--|

**HUTCHENS SUSPENSION**

|  |                           |         |  |     |     |     |       |       |
|--|---------------------------|---------|--|-----|-----|-----|-------|-------|
|  | Models with O.E.M. Number | 9423-00 |  | ... | ... | 010 | 83203 | 89436 |
|--|---------------------------|---------|--|-----|-----|-----|-------|-------|

**HYSTER**

|  |                  |        |  |       |     |     |       |     |
|--|------------------|--------|--|-------|-----|-----|-------|-----|
|  | Straddle Carrier | 650150 |  | 83217 | ... | 010 | 83217 | ... |
|  |                  | 73516  |  | 83217 | ... | 010 | 83217 | ... |

**IC CORPORATION**

**AE Series School Bus**

|  |  |           |     |       |     |  |     |     |
|--|--|-----------|-----|-------|-----|--|-----|-----|
|  | AE Model School Buses with O.E.M. Number | 3902993C1 | 010 | 83135 | ... |  | ... | ... |
|  |  | 3902993C2 | 010 | 83135 | ... |  | ... | ... |
|  |  | 3902993C3 | 010 | 83135 | ... |  | ... | ... |

**BE Series School Bus**

|        |  |           |     |       |     |  |     |     |
|--------|--|-----------|-----|-------|-----|--|-----|-----|
| - 2012 | BE200 Model School Buses with 7000 lb Front Axle | 3605735C1 | 010 | 83156 | ... |  | ... | ... |
|        |  | 3605735C2 | 010 | 83156 | ... |  | ... | ... |





**CE Series School Bus**

|         |  |           |     |       |     |     |       |     |
|---------|--|-----------|-----|-------|-----|-----|-------|-----|
| 06 - 18 | CE Model School Buses (71 Capacity) with 9,000 to 10,000 lb Front Suspension | 3578105C1 | 010 | 83163 | ... |     | ...   | ... |
|         |  | 3578105C2 | 010 | 83163 | ... |     | ...   | ... |
|         |  | 6127088C1 | 010 | 83163 | ... |     | ...   | ... |
|         |  | OE13402S  | 010 | 83163 | ... |     | ...   | ... |
| 10 - 15 | CE Model School Buses with 20,000 lb International IROS Air Suspension       | 3578858C2 |     | ...   | ... | 010 | 85926 | ... |
| 16 - 17 | CE Model School Buses with 20,000 lb Rear Air Suspension                     | 3601600C3 |     | ...   | ... | 010 | 85082 | ... |
| 05 - 13 | CE Model School Buses with 22,000 lb Rear Spring Suspension                  | 501906C91 |     | ...   | ... | -10 | 83317 | ... |
|         |  | 501906C92 |     | ...   | ... | -10 | 83317 | ... |
|         |  | OE13424S  |     | ...   | ... | -10 | 83317 | ... |
| 13 - 18 | CE Model School Buses with 6,000 to 8,000 lb Front Axles                     | 3533356C3 | 010 | 83169 | ... |     | ...   | ... |

**RE Series School Bus**

|  |                                       |            |  |     |     |     |       |     |
|--|---------------------------------------|------------|--|-----|-----|-----|-------|-----|
|  | Low-Profile models with O.E.M. Number | 1660846C92 |  | ... | ... | 010 | 83101 | ... |
|--|---------------------------------------|------------|--|-----|-----|-----|-------|-----|

**APPLICATION GUIDE - TRUCKS, TRAILERS, AND BUSES**

| Year<br>Año<br>Année | Model<br>Modelo<br>Modèle | OEM # | Front   |   | Rear  |   |
|----------------------|---------------------------|-------|---|---|---|---|
|                      |                           |       |  |  |  |  |
|                      |                           |       | Fleetline   | GasSLX  | Fleetline   | GasSLX  |

**IC CORPORATION(Cont'd.)**

**RE Series School Bus(Cont'd.)**

|         |  |            |     |       |       |     |       |       |
|---------|--|------------|-----|-------|-------|-----|-------|-------|
|         | RE Model School Buses with 12,000 to 14,000 lb Front Axles     | 2200327C1  | -10 | 85332 | ...   |     | ...   | ...   |
| 03 - 17 | RE Model School Buses with Hendrickson AirTek Front Suspension | 65992-006  | 010 | 85986 | ...   |     | ...   | ...   |
|         |  | H65992-006 | 010 | 85986 | ...   |     | ...   | ...   |
|         | RE Model School Buses with O.E.M. Number                       | 1675455C1  |     | ...   | ...   | 010 | 85003 | 89411 |
|         |  | 2018987C1  |     | ...   | ...   | 010 | 85003 | 89411 |
|         |  | 3604282C1  | -10 | 85351 | ...   |     | ...   | ...   |
|         |  | 472412C91  | -1- | 83456 | 89447 |     | ...   | ...   |
|         |  | 501553C91  |     | ...   | ...   | 010 | 85003 | 89411 |
|         |  | 537524C91  |     | ...   | ...   | 010 | 83123 | 89405 |
|         |  |            |     |       |       |     |       |       |

**INGERSOLL AXLES**

|  |                       |           |  |     |     |     |       |       |
|--|-----------------------|-----------|--|-----|-----|-----|-------|-------|
|  | Ingersoll part number | 653511-01 |  | ... | ... | 010 | 85323 | 89436 |
|  |                       | 653511-02 |  | ... | ... | 010 | 85938 | ...   |
|  |                       | 653511-03 |  | ... | ... | 010 | 85045 | ...   |
|  |                       | 653511-04 |  | ... | ... | 010 | 85052 | ...   |

**INTERNATIONAL (NAVISTAR)**

**A, B, AC and BC Conventional**

|  |   |           |     |        |       |     |        |       |
|--|---|-----------|-----|--------|-------|-----|--------|-------|
|  | A-140 (4 x 4) Models  | ....      |     | ...    | ...   | 010 | 83216  | ...   |
|  | A-160, A-170, A-180, AC-160, AC-170, AC-180, B-160, B-170, B-180, BC-160, BC-170, BC-180 Models | 308649C91 |     | ...    | ...   | 010 | 83216  | ...   |
|  |   | 308650C91 |     | ...    | ...   | 010 | 83216  | ...   |
|  |   | 453567C91 |     | ...    | ...   | 010 | 83216  | ...   |
|  | A-170, B-170, AC-170, ACF-170, BC-170, A-180, B-180, AC-180, BC-180, BCF-170 Models             | 308646C91 | 010 | 85012  | 89413 |     | ...    | ...   |
|  | AB-140 Models   | ....      |     | G63306 | ...   | 010 | G63306 | ...   |
|  | AC-170 & BC-170 (4 x 4) Models  | ....      |     | ...    | ...   | 010 | 83216  | ...   |
|  | AC-180 & BC-180 (4 x 4) Models  | ....      |     | ...    | ...   | 010 | 83216  | ...   |
|  | BCF-195-D Models  | ....      |     | ...    | ...   | 010 | 83225  | ...   |
|  | C-150 Models  | ....      | 010 | G63306 | ...   |     | ...    | ...   |
|  |   | 308649C91 |     | ...    | ...   | 010 | 83216  | ...   |
|  |   | 308668C91 |     | ...    | ...   | 010 | 85012  | 89413 |
|  |   | 453556C91 |     | ...    | ...   | 010 | 85012  | 89413 |
|  |   | 453567C91 |     | ...    | ...   | 010 | 83216  | ...   |

**BE Series School Bus**

|        |  |           |     |       |     |     |       |     |
|--------|--|-----------|-----|-------|-----|-----|-------|-----|
| - 2012 | BE200 Model School Bus Chassis with 7000 lb Front Axle | 3605735C1 | 010 | 83156 | ... |     | ...   | ... |
|        |  | 3605735C2 | 010 | 83156 | ... |     | ...   | ... |
|        | with 9000 lb Rear Suspension                           | 3609400C1 |     | ...   | ... | -10 | 83317 | ... |
|        |  | 3609400C2 |     | ...   | ... | -10 | 83317 | ... |

**Binder**





|  |                 |           |     |       |       |     |       |     |
|--|-----------------|-----------|-----|-------|-------|-----|-------|-----|
|  | Binder          | 453556C91 | 010 | 85012 | 89413 |     | ...   | ... |
|  |                 | 453571C91 |     | ...   | ...   | 010 | 83216 | ... |
|  |                 | 467983C91 | 010 | 85012 | 89413 |     | ...   | ... |
|  |                 | 467985C91 | 010 | 85012 | 89413 |     | ...   | ... |
|  |                 | 471201C91 | 010 | 85012 | 89413 |     | ...   | ... |
|  | S Models Binder | 472367C91 | -1- | 83318 | ...   |     | ...   | ... |

**Cargostar**

|  |   |            |  |     |     |     |       |     |
|--|---|------------|--|-----|-----|-----|-------|-----|
|  | CO-1600, CO-1610A & B, CO-1630A & B, CO-1700, CO-1710A & B, CO-1730A & B, CO-1750, CO-1750A & B, CO-1800, CO-1810A & B, CO-1830A & B, CO-1850, and CO-1850A & B | 206620R91  |  | ... | ... | 010 | 83216 | ... |
|  |   | 206621R92  |  | ... | ... | 010 | 83216 | ... |
|  |   | 294334C91  |  | ... | ... | 010 | 83216 | ... |
|  |   | 3085640C92 |  | ... | ... | 010 | 83216 | ... |
|  |   |            |  |     |     |     |       |     |



**APPLICATION GUIDE - TRUCKS, TRAILERS, AND BUSES**

| Year<br>Año<br>Année | Model<br>Modelo<br>Modèle | OEM # | Front   |  |   | Rear  |           |        |
|----------------------|---------------------------|-------|---|--|---|---|-----------|--------|
|                      |                           |       |  |  |  |  | Fleetline | GasSLX |

**INTERNATIONAL (NAVISTAR)(Cont'd.)**









**Cargostar(Cont'd.)**

|   |           |              |              |              |     |              |              |
|---|-----------|--------------|--------------|--------------|-----|--------------|--------------|
| CO-1600, CO-1610A & B, CO-1630A & B, CO-1700, CO-1710A & B, CO-1730A & B, CO-1750, CO-1750A & B, CO-1800, CO-1810A & B, CO-1830A & B, CO-1850, and CO-1850A & B | 308646C91 |              | ...          | ...          | 010 | <b>85012</b> | <b>89413</b> |
|   | 308649C91 |              | ...          | ...          | 010 | <b>83216</b> | ...          |
|   | 308650C92 |              | ...          | ...          | 010 | <b>83216</b> | ...          |
|   | 360444C91 |              | ...          | ...          | 010 | <b>85012</b> | <b>89413</b> |
|   | 453564C91 |              | ...          | ...          | 010 | <b>85012</b> | <b>89413</b> |
|   | 453567C91 |              | ...          | ...          | 010 | <b>83216</b> | ...          |
|   | 453570C91 |              | ...          | ...          | 010 | <b>83216</b> | ...          |
|   | 467983C91 |              | ...          | ...          | 010 | <b>85012</b> | <b>89413</b> |
|   | 467984C91 |              | ...          | ...          | 010 | <b>83216</b> | ...          |
| CO-1610A & B, CO-1630A & B, CO-1710A & B, CO-1730A & B, CO-1750A & B, CO-1810A & B, CO-1830A & B, COF-1810A & B - Exc. with 9000, 10800, or 12000 lb Front Axle | 453572C91 | 010          | <b>83309</b> | <b>89446</b> |     | ...          | ...          |
| CO-1610A & B, CO-1630A & B, CO-1710A & B, CO-1730A & B, CO-1750A & B, CO-1810A & B, CO-1830A & B, COF-1810A & B - With 9000, 10800, or 12000 lb Front Axle      | 873619C92 | 010          | <b>83314</b> | ...          |     | ...          | ...          |
|   | 873619C93 | 010          | <b>83314</b> | ...          |     | ...          | ...          |
| CO-190, VCO-190, CO-200, DCO-200, VCO-200, CO-220, VCO-220 With Air Ride Suspension After Chassis No G-387453   | 350425C1  |              | ...          | ...          | 010 | <b>85300</b> | <b>89419</b> |
|   | 462557C91 |              | ...          | ...          | 010 | <b>85300</b> | <b>89419</b> |
| CO-190, VCO-190, CO-200, DCO-200, VCO-200, CO-220, VCO-220 With Air Ride Suspension before Chassis No G-387453  | 350426C91 |              | ...          | ...          | 010 | <b>85734</b> | ...          |
|   | 204994R91 | 010          | <b>83225</b> | ...          |     | ...          | ...          |
| CO-190, COF-190, VCO-190, VCOF-190 & CO-200, DCO-200, VCO-200 & CO-220, VCO-220 & VCO-190 (4 man cab)   | 210534R92 | 010          | <b>83225</b> | ...          |     | ...          | ...          |
|   | 288920C91 | 010          | <b>83225</b> | ...          |     | ...          | ...          |
|   | 288921R92 | 010          | <b>83225</b> | ...          |     | ...          | ...          |
|   | 308648C91 | 010          | <b>83225</b> | ...          |     | ...          | ...          |
|   | 452566C91 | 010          | <b>83225</b> | ...          |     | ...          | ...          |
|   | 453561C91 | 010          | <b>83225</b> | ...          |     | ...          | ...          |
|   | 453562C91 | 010          | <b>83225</b> | ...          |     | ...          | ...          |
|   | 453565C91 | 010          | <b>83225</b> | ...          |     | ...          | ...          |
|   | 453569C91 | 010          | <b>83225</b> | ...          |     | ...          | ...          |
|   | 467371C91 | 010          | <b>83225</b> | ...          |     | ...          | ...          |
| 467372C91   | 010       | <b>83225</b> | ...          |              | ... | ...          |              |
| CO-1910A & B, CO-1950A & B, COF-1910A & B, COF-1950A & B  | 453572C91 | 010          | <b>83309</b> | <b>89446</b> |     | ...          | ...          |
|   | 873619C92 | 010          | <b>83314</b> | ...          |     | ...          | ...          |
| CO-1950, COF-1950 & COT-1950  | 288920C91 | 010          | <b>83225</b> | ...          |     | ...          | ...          |
|   | 288921C91 | 010          | <b>83225</b> | ...          |     | ...          | ...          |
|   | 308648C91 | 010          | <b>83225</b> | ...          |     | ...          | ...          |
|   | 453561C91 | 010          | <b>83225</b> | ...          |     | ...          | ...          |
|   | 453565C91 | 010          | <b>83225</b> | ...          |     | ...          | ...          |
|   | 453566C91 | 010          | <b>83225</b> | ...          |     | ...          | ...          |
|   | 453569C91 | 010          | <b>83225</b> | ...          |     | ...          | ...          |
|   | 467371C91 | 010          | <b>83225</b> | ...          |     | ...          | ...          |
|   | 467372C91 | 010          | <b>83225</b> | ...          |     | ...          | ...          |
| CO-1950 with Air Ride Suspension After Chassis No. G-387453   | 350425C1  |              | ...          | ...          | 010 | <b>85300</b> | <b>89419</b> |
|   | 462557C91 |              | ...          | ...          | 010 | <b>85300</b> | <b>89419</b> |
| CO-1950 with Air Ride Suspension Before Chassis No. G-387453  | 350426C1  |              | ...          | ...          | 010 | <b>85734</b> | ...          |

**CE Series School Bus**

|                |  |           |     |              |     |  |     |     |
|----------------|--|-----------|-----|--------------|-----|--|-----|-----|
| <b>06 - 18</b> | CE Model School Buses (71 Capacity) with 9,000 to 10,000 lb Front Suspension | 3578105C1 | 010 | <b>83163</b> | ... |  | ... | ... |
|                |  | 3578105C2 | 010 | <b>83163</b> | ... |  | ... | ... |

**APPLICATION GUIDE - TRUCKS, TRAILERS, AND BUSES**

| Year<br>Año<br>Année | Model<br>Modelo<br>Modèle | OEM # | Front   |   | Rear  |   |
|----------------------|---------------------------|-------|---|---|---|---|
|                      |                           |       |  |  |  |  |
|                      |                           |       |  |  |  |  |
|                      |                           |       | Fleetline   | GasSLX  | Fleetline   | GasSLX  |

**INTERNATIONAL (NAVISTAR)(Cont'd.)**

**CE Series School Bus(Cont'd.)**

|         |  |           |     |       |     |     |       |     |
|---------|--|-----------|-----|-------|-----|-----|-------|-----|
| 06 - 18 | CE Model School Buses (71 Capacity) with 9,000 to 10,000 lb Front Suspension | 6127088C1 | 010 | 83163 | ... |     | ...   | ... |
|         |  | OE13402S  | 010 | 83163 | ... |     | ...   | ... |
| 10 - 18 | CE Model School Buses with 20,000 lb International IROS Air Suspension       | 3578858C2 |     | ...   | ... | 010 | 85926 | ... |
|         |  | 6127713C1 |     | ...   | ... | 010 | 85926 | ... |
| 05 - 13 | CE Model School Buses with 22,000 lb Rear Spring Suspension                  | 501906C92 |     | ...   | ... | -10 | 83317 | ... |
|         |  | OE13424S  |     | ...   | ... | -10 | 83317 | ... |
| 13 - 18 | CE Model School Buses with 6,000 to 8,000 lb Front Axles                     | 6127688C1 | 010 | 83169 | ... |     | ...   | ... |

**Co-Transtar and Transtar II**

|   |  |     |       |       |     |       |       |
|---|--|-----|-------|-------|-----|-------|-------|
| 7070B, F-7070B, CO-7070B & COF-7070B Models   | 426744R91<br>426744R92<br>453576C91<br>453576C92<br>477132C1 | 010 | 85303 | 89422 |     | ...   | ...   |
|   |  | 010 | 85303 | 89422 |     | ...   | ...   |
|   |  | 010 | 85303 | 89422 |     | ...   | ...   |
|   |  | 010 | 85303 | 89422 |     | ...   | ...   |
|   |  | 010 | 85303 | 89422 |     | ...   | ...   |
| CO-4010, COF-4010, COT-4010, COT-4010D, CO-4050, COF-4050, COT-4050, CO-4040A & B, CO-4070D, COF-4070B, COF-4070D, COT-4070D, COF-4077, COF-4077A, COF-4080D, CO-4090A, COF-4090A | 426744R91<br>426744R92<br>453576C91<br>453576C92<br>477132C1 | 010 | 85303 | 89422 |     | ...   | ...   |
|   |  | 010 | 85303 | 89422 |     | ...   | ...   |
|   |  | 010 | 85303 | 89422 |     | ...   | ...   |
|   |  | 010 | 85303 | 89422 |     | ...   | ...   |
| CO-4070A, COF-4070A, COF-4090A with Rear Suspension   | 462557C91  |     | ...   | ...   | 010 | 85300 | 89419 |

**CXT Series**

|   |           |     |       |     |  |     |     |
|---|-----------|-----|-------|-----|--|-----|-----|
| CXT Models with 9,000 to 10,000 lb Front Suspension | 3606770C1 | 010 | 83163 | ... |  | ... | ... |
|   | 3606770C2 | 010 | 83163 | ... |  | ... | ... |





**DuraStar - 1000 Series**

|             |                                     |     |        |     |  |     |     |
|-------------|-------------------------------------|-----|--------|-----|--|-----|-----|
| 1300 Models | 56110-T8123<br>56110-T8129<br>66400 | -10 | G63432 | ... |  | ... | ... |
|             |                                     | -10 | G63432 | ... |  | ... | ... |
|             |                                     | -10 | G63432 | ... |  | ... | ... |

**DuraStar - 4300, 4400 Series**

|         |  |            |     |       |     |     |       |       |
|---------|--|------------|-----|-------|-----|-----|-------|-------|
| 2013    | Low-Profile models with O.E.M. Number                            | 1660846C92 |     | ...   | ... | 010 | 83101 | ...   |
| 2016 -  | Models with 10,500 or 13,500 lb Vari-Rate Rear Spring Suspension | 6127087C1  |     | ...   | ... | 010 | 83364 | ...   |
| 16 - 19 | Models with 11,000 lb to 14,000 lb Front axle                    | 6127714C1  | 010 | 85928 | ... |     | ...   | ...   |
| 02 - 15 | Models with 12,000 lb Front axle                                 | 3533357C1  | 010 | 85957 | ... |     | ...   | ...   |
|         |  | 3533357C2  | 010 | 85957 | ... |     | ...   | ...   |
|         |  | 3533357C3  | 010 | 85957 | ... |     | ...   | ...   |
| - 2015  | Models with 20,000 lb International IROS Air Suspension          | 3578858C1  |     | ...   | ... | 010 | 85926 | ...   |
|         |  | 3578858C2  |     | ...   | ... | 010 | 85926 | ...   |
| 16 - 19 | Models with 20,000 lb International IROS Air Suspension          | 6127713C1  |     | ...   | ... | 010 | 85926 | ...   |
| 02 - 13 | Models with 22,000 lb Rear Spring Suspension                     | 501906C91  |     | ...   | ... | -10 | 83317 | ...   |
|         |  | 501906C92  |     | ...   | ... | -10 | 83317 | ...   |
| - 2011  | Models with 40,000 lb Rear Air Suspension                        | 3549099C2  |     | ...   | ... | 010 | 85923 | 89458 |
| 02 - 12 | Models with 6,000 to 8,000 lb Front Suspension                   | 3533356C1  | 010 | 83135 | ... |     | ...   | ...   |
|         |  | 3533356C2  | 010 | 83135 | ... |     | ...   | ...   |
| 13 - 18 | Models with 6,000 to 8,000 lb Front Suspension                   | 3533356C3  | 010 | 83169 | ... |     | ...   | ...   |
|         |  | 6127688C1  | 010 | 83169 | ... |     | ...   | ...   |
| - 2015  | Models with 9,000 to 10,000 lb Front Suspension                  | 3578105C2  | 010 | 83163 | ... |     | ...   | ...   |
| 16 - 19 | Models with 9,000 to 10,000 lb Front Suspension                  | 6127088C1  | 010 | 83163 | ... |     | ...   | ...   |
| - 2019  | Models with Hendrickson HAS - 230 or 460 Rear Air Suspension     | 3514952C1  |     | ...   | ... | 010 | 85976 | ...   |
|         |  | 57905-001  |     | ...   | ... | 010 | 85976 | ...   |
|         |  | 60675-003  |     | ...   | ... | 010 | 85976 | ...   |
|         |  | 60675-003L |     | ...   | ... | 010 | 85976 | ...   |

**APPLICATION GUIDE - TRUCKS, TRAILERS, AND BUSES**

| Year<br>Año<br>Année | Model<br>Modelo<br>Modèle | OEM # | Front   |  | Rear  |   |        |
|----------------------|---------------------------|-------|---|--|---|---|--------|
|                      |                           |       |  |  |  |  |        |
|                      |                           |       |   | Fleetline  | GasSLX  | Fleetline   | GasSLX |

**INTERNATIONAL (NAVISTAR)(Cont'd.)**

**DuraStar - 4300, 4400 Series(Cont'd.)**

|         |  |            |     |       |     |     |       |       |
|---------|--|------------|-----|-------|-----|-----|-------|-------|
| - 2019  | Models with Hendrickson HAS - 230 or 460 Rear Air Suspension | H60675-003 |     | ...   | ... | 010 | 85976 | ...   |
|         | Models with International IROS Air Suspension                | 3553628C1  |     | ...   | ... | 010 | 85927 | ...   |
|         |  | 3553628C2  |     | ...   | ... | 010 | 85927 | ...   |
|         |  | 3553628C3  |     | ...   | ... | 010 | 85927 | ...   |
|         |  | 3553628C4  |     | ...   | ... | 010 | 85927 | ...   |
|         | Models with O.E.M. Number                                    | 6127690C1  |     | ...   | ... | 010 | 85923 | 89458 |
| 16 - 17 | Models with Vari-Rate Rear Spring Suspension                 | 6127700C1  |     | ...   | ... | -10 | 83395 | ...   |
| 02 - 12 | School Bus models with 6,000 to 8,000 lb Front Suspension    | 3533356C1  | 010 | 83135 | ... |     | ...   | ...   |
|         |  | 3533356C2  | 010 | 83135 | ... |     | ...   | ...   |



**F & S Series**

|  |  |            |     |       |       |     |       |       |
|--|--|------------|-----|-------|-------|-----|-------|-------|
|  | 1600, 1700, 1800, 1900, 2100 Models  | 3000070C91 | -1- | 83456 | 89447 |     | ...   | ...   |
|  |  | 453576C92  | 010 | 85303 | 89422 |     | ...   | ...   |
|  | 1600, 1700, 1800, 1900, 2100 Models with International Air Suspension  | 1675455C1  |     | ...   | ...   | 010 | 85003 | 89411 |
|  |  | 1690035C1  |     | ...   | ...   | 010 | 85003 | 89411 |
|  |  | 2018987C1  |     | ...   | ...   | 010 | 85003 | 89411 |
|  |  | 2018987C2  |     | ...   | ...   | 010 | 85003 | 89411 |
|  |  | 501553C91  |     | ...   | ...   | 010 | 85003 | 89411 |
|  | 1600, 1700, 1800, 1900, 2100 Models with Neway ARD-234 Air Suspension  | 537524C91  |     | ...   | ...   | 010 | 83123 | 89405 |
|  | 1624, 1654, 1724, 1754, 1824, 1854, 1924, F1924, 1925, 1954, F1954, 1955, 2124, 2125, F2125, 2154, 2155 Models Exc. with Rear Axle Codes 14029, 14030, 14187   | 501905C91  |     | ...   | ...   | -10 | 83301 | ...   |
|  |  | 501906C91  |     | ...   | ...   | -10 | 83317 | ...   |
|  | 1624, 1654, 1724, 1754, 1824, 1854, 1924, F1924, 1925, 1954, F1954, 1955, 2124, 2125, F2125, 2154, 2155 Models with 5000, 6000 or 7500 lb Front Axle   | 472367C91  | -1- | 83318 | ...   |     | ...   | ...   |
|  | 1624, 1654, 1724, 1754, 1824, 1854, 1924, F1924, 1925, 1954, F1954, 1955, 2124, 2125, F2125, 2154, 2155 Models with Rear Axle Codes 14029, 14030, 14187  | 501905C91  |     | ...   | ...   | -10 | 83301 | ...   |
|  | 1624, 1654, 1724, 1754, 1824, 1854, 1924, F1924, 1925, 1954, F1954, 1955, 2124, 2125, F2125, 2154, 2155, 2275, F2275, 2524, F2524, 2554, F2554, 2574, F2574, 2575, F2575, F2624, F2654, F2674 Models with 9000, 10800 or 12000 lb Front Axle | 472411C91  | -1- | 83456 | 89447 |     | ...   | ...   |
|  |  | 472412C91  | -1- | 83456 | 89447 |     | ...   | ...   |
|  |  | 586724C91  | -1- | 83456 | 89447 |     | ...   | ...   |
|  | 1924, 1954 (6 x 6) Models  | 472367C91  | -1- | 83318 | ...   |     | ...   | ...   |
|  |  | 472414C91  | -1- | 83318 | ...   |     | ...   | ...   |
|  | 2275, F2275, 2524, F2524, 2554, F2554, 2574, F2574, 2575, F2575, F2624, F2654, F2674 Models with International Corporate Air Suspension  | 1675455C1  |     | ...   | ...   | 010 | 85003 | 89411 |
|  |  | 1690035C1  |     | ...   | ...   | 010 | 85003 | 89411 |
|  |  | 2018987C1  |     | ...   | ...   | 010 | 85003 | 89411 |
|  |  | 2018987C2  |     | ...   | ...   | 010 | 85003 | 89411 |
|  |  | 501553C91  |     | ...   | ...   | 010 | 85003 | 89411 |
|  | 2275, F2275, 2524, F2524, 2554, F2554, 2574, F2574, 2575, F2575, F2624, F2654, F2674 Models with Neway ARD-125/244 Air Suspension  | 790335C91  |     | ...   | ...   | 010 | 83209 | 89414 |
|  | 2275, F2275, 2524, F2524, 2554, F2554, 2574, F2574, 2575, F2575, F2624, F2654, F2674 Models with Neway ARD-234 Air Suspension  | 537524C91  |     | ...   | ...   | 010 | 83123 | 89405 |
|  | 2275, F2275, 2524, F2524, 2554, F2554, 2574, F2574, 2575, F2575, F2624, F2654, F2674 Models with Ridwell Rear Suspension   | 534464C1   |     | ...   | ...   | 010 | 85734 | ...   |

**Firetruck**

|  |         |           |     |       |     |  |     |     |
|--|---------|-----------|-----|-------|-----|--|-----|-----|
|  | CO-8190 | 204994R91 | 010 | 83225 | ... |  | ... | ... |
|  |         | 308648C91 | 010 | 83225 | ... |  | ... | ... |
|  |         | 453561C91 | 010 | 83225 | ... |  | ... | ... |
|  |         | 453565C91 | 010 | 83225 | ... |  | ... | ... |
|  |         | 467371C91 | 010 | 83225 | ... |  | ... | ... |

**APPLICATION GUIDE - TRUCKS, TRAILERS, AND BUSES**

| Year<br>Año<br>Année | Model<br>Modelo<br>Modèle | OEM # | Front   |   | Rear      |        |
|----------------------|---------------------------|-------|---|---|-----------|--------|
|                      |                           |       |  |  |           |        |
|                      |                           |       | Fleetline   | GasSLX  | Fleetline | GasSLX |

**INTERNATIONAL (NAVISTAR)(Cont'd.)**

**Firetruck(Cont'd.)**

|                           |           |  |     |     |     |              |     |
|---------------------------|-----------|--|-----|-----|-----|--------------|-----|
| Models with O.E.M. Number | 210919R91 |  | ... | ... | 0 0 | <b>85307</b> | ... |
|---------------------------|-----------|--|-----|-----|-----|--------------|-----|

**Fleetstar - Conventional**

|  |           |              |              |     |     |              |              |
|--|-----------|--------------|--------------|-----|-----|--------------|--------------|
| 1900, F-1900, T-1900, 1950, F-1950, T-1950, 2000, 2000D, F-2000D & T-2000D Models            | 210535R91 | 0 0          | <b>83225</b> | ... |     | ...          | ...          |
|  | 453568C91 | 0 0          | <b>83225</b> | ... |     | ...          | ...          |
|  | 467372C91 | 0 0          | <b>83225</b> | ... |     | ...          | ...          |
| 1910A, F-1910A, 2010A, F-2010A, 2050A, F-2050A, 2070A, F-2070A, 2110A & 2150A Models         | 206621R92 | 0 0          | <b>83216</b> | ... |     | ...          | ...          |
|  | 308650C92 | 0 0          | <b>83216</b> | ... |     | ...          | ...          |
|  | 453570C91 | 0 0          | <b>83216</b> | ... |     | ...          | ...          |
| 2000D, 2010A, 2050A, 2070A, 2110A, 2150A with Air Ride Suspension After Chassis No G-387453  | 350425C1  |              | ...          | ... | 0 0 | <b>85300</b> | <b>89419</b> |
|  | 462557C91 |              | ...          | ... | 0 0 | <b>85300</b> | <b>89419</b> |
| 2000D, 2010A, 2050A, 2070A, 2110A, 2150A with Air Ride Suspension Before Chassis No G-387453 | 350426C1  |              | ...          | ... | 0 0 | <b>85734</b> | ...          |
|  |           |              | ...          | ... | 0 0 | <b>85300</b> | <b>89419</b> |
| F-2010A, F-2050A, F-2000D with Air Ride Suspension   | 350425C1  |              | ...          | ... | 0 0 | <b>85300</b> | <b>89419</b> |
|  | 462557C91 |              | ...          | ... | 0 0 | <b>85300</b> | <b>89419</b> |
| R-185, R-190, RD-190, R-200, RD-200, RF-200, RDF-200, R-220, RD-220, R210 & RF-210           | 210533R91 | 0 0          | <b>83225</b> | ... |     | ...          | ...          |
|  | 210534R92 | 0 0          | <b>83225</b> | ... |     | ...          | ...          |
|  | 210535R91 | 0 0          | <b>83225</b> | ... |     | ...          | ...          |
|  | 210536R91 | 0 0          | <b>83225</b> | ... |     | ...          | ...          |
|  | 210537R91 | 0 0          | <b>83225</b> | ... |     | ...          | ...          |
|  | 210538R91 | 0 0          | <b>83225</b> | ... |     | ...          | ...          |
|  | 453562C91 | 0 0          | <b>83225</b> | ... |     | ...          | ...          |
|  | 453568C91 | 0 0          | <b>83225</b> | ... |     | ...          | ...          |
|  | 467371C91 | 0 0          | <b>83225</b> | ... |     | ...          | ...          |
| 467372C91  | 0 0       | <b>83225</b> | ...          |     | ... | ...          |              |





**HV - Series**

|             |   |            |     |     |      |              |     |
|-------------|---|------------|-----|-----|------|--------------|-----|
| <b>2019</b> | Models with Hendrickson HMX 400/460 Haulmax with 16.5" Saddle                 | 60680-004  | ... | ... | 0 1- | <b>83143</b> | ... |
|             |   | 60680-004L | ... | ... | 0 1- | <b>83143</b> | ... |
|             |   | H60680004  | ... | ... | 0 1- | <b>83143</b> | ... |
| <b>2019</b> | Models with Hendrickson HMX 400/460 Haulmax with 17.5" or 18.5" Saddle Height | 60680-005  | ... | ... | 0 1- | <b>83142</b> | ... |
|             |   | 60680-005L | ... | ... | 0 1- | <b>83142</b> | ... |
|             |   | H60680005  | ... | ... | 0 1- | <b>83142</b> | ... |
| <b>2019</b> | Models with Hendrickson Primaax 230/460 Air Suspension with 9" Ride Height    | 60657-003  | ... | ... | 0 0  | <b>85072</b> | ... |
|             |   | 60657-003L | ... | ... | 0 0  | <b>85072</b> | ... |
|             |   | H60657003  | ... | ... | 0 0  | <b>85072</b> | ... |

**HX - Series**

|                |  |            |     |     |      |              |     |
|----------------|--|------------|-----|-----|------|--------------|-----|
| <b>18 - 19</b> | Models with Hendrickson HAS - 230 or 460 Rear Air Suspension                               | 60675-003  | ... | ... | 0 0  | <b>85976</b> | ... |
|                |  | 60675-003L | ... | ... | 0 0  | <b>85976</b> | ... |
|                |  | H60675003  | ... | ... | 0 0  | <b>85976</b> | ... |
| <b>18 - 19</b> | Models with Hendrickson HMX 400/460 Haulmax with 16.5" Saddle                              | 60680-004  | ... | ... | 0 1- | <b>83143</b> | ... |
|                |  | 60680-004L | ... | ... | 0 1- | <b>83143</b> | ... |
|                |  | H60680004  | ... | ... | 0 1- | <b>83143</b> | ... |
| <b>18 - 19</b> | Models with Hendrickson HMX 400/460 Haulmax with 17.5" or 18.5" Saddle Height              | 60680-005  | ... | ... | 0 1- | <b>83142</b> | ... |
|                |  | 60680-005L | ... | ... | 0 1- | <b>83142</b> | ... |
|                |  | H60680005  | ... | ... | 0 1- | <b>83142</b> | ... |
| <b>18 - 19</b> | Models with Hendrickson Primaax 520 Rear Air Suspension (10" Ride Height-Disc Brakes only) | 60665-015  | ... | ... | 0 0  | <b>85966</b> | ... |
|                |  | H60665015  | ... | ... | 0 0  | <b>85966</b> | ... |

**APPLICATION GUIDE - TRUCKS, TRAILERS, AND BUSES**

| Year<br>Año<br>Année | Model<br>Modelo<br>Modèle | OEM # | Front   |   | Rear  |  |
|----------------------|---------------------------|-------|---|---|---|--|
|                      |                           |       |  Fleetline |  GasSLX |  Fleetline |  GasSLX |

**INTERNATIONAL (NAVISTAR)(Cont'd.)**

**HX - Series(Cont'd.)**

|         |  |           |     |     |     |       |     |
|---------|--|-----------|-----|-----|-----|-------|-----|
| 18 - 19 | Models with Hendrickson Primaax 520 Rear Air Suspension (10" Ride Height-Drum Brakes only) | 60665-013 | ... | ... | 010 | 85965 | ... |
|         |  | H60665013 | ... | ... | 010 | 85965 | ... |





**Loadstar - Conventional**

|           |   |           |     |       |       |     |       |       |
|-----------|---|-----------|-----|-------|-------|-----|-------|-------|
|           | 1600, 1600 (4x4), 1610, 1610 (4x4), 1610FC, 1700, 1700 (4x4), 1710, 1710 (4x4), F-1700, 1750, 1800, 1810, F-1800, F-1800-D, 1850, F-1850, 1890 & 1890-D with 9000, 10800 or 12000 lb Front Axle   | 329316C92 | 010 | 85012 | 89413 | ... | ...   |       |
|           |   | 360444C91 | 010 | 85012 | 89413 | ... | ...   |       |
|           |   | 453564C91 | 010 | 85012 | 89413 | ... | ...   |       |
|           |   | 467983C91 | 010 | 85012 | 89413 | ... | ...   |       |
|           |   | 471201C91 | 010 | 85012 | 89413 | ... | ...   |       |
|           | 1600, 1600 (4x4), 1610, 1610 (4x4), 1610FC, 1700, 1700 (4x4), 1710, 1710 (4x4), F-1700, 1750, 1800, 1810, F-1800, F-1800-D, 1850, F-1850, 1890 & 1890-D with Axle Codes 02089, 02091  | 206620R91 | 010 | 83216 | ...   | ... | ...   |       |
|           |   | 308649C91 | 010 | 83216 | ...   | ... | ...   |       |
|           |   | 453567C91 | 010 | 83216 | ...   | ... | ...   |       |
|           | 1600, 1600 (4x4), 1610, 1610 (4x4), 1700, 1700 (4x4), 1710, 1710 (4x4), 1750, 1800, 1810, 1850, 1890 & 1890-D Models  | 206620R91 |     | ...   | ...   | 010 | 83216 | ...   |
|           |   | 206621R91 |     | ...   | ...   | 010 | 83216 | ...   |
|           |   | 308649C91 |     | ...   | ...   | 010 | 83216 | ...   |
|           |   | 308650C92 |     | ...   | ...   | 010 | 83216 | ...   |
|           |   | 329316C92 |     | ...   | ...   | 010 | 85012 | 89413 |
|           |   | 360444C91 |     | ...   | ...   | 010 | 85012 | 89413 |
|           |   | 383379C91 |     | ...   | ...   | 010 | 83308 | ...   |
|           |   | 453564C91 |     | ...   | ...   | 010 | 85012 | 89413 |
|           |   | 453567C91 |     | ...   | ...   | 010 | 83216 | ...   |
|           |   | 453570C91 |     | ...   | ...   | 010 | 83216 | ...   |
|           |   | 453575C91 |     | ...   | ...   | 010 | 83308 | ...   |
|           |   | 467983C91 |     | ...   | ...   | 010 | 85012 | 89413 |
|           |   | 467984C91 |     | ...   | ...   | 010 | 83216 | ...   |
|           |   | 471203C91 |     | ...   | ...   | 010 | 83308 | ...   |
|           |   | 474002C91 |     | ...   | ...   | 010 | 83308 | ...   |
| 873622C91 |   | ...       | ... | 010   | 83308 | ... |       |       |
|           | 1600, 1600 (4x4), 1610, 1610 (4x4), 1700, 1700 (4x4), 1710, 1710 (4x4), F-1700, 1750, 1800, 1810, F-1800, F-1800-D, 1850, F-1850, 1890 & 1890-D Exc. Axle Codes 02054, 02057, 02059, 02089, 02091, 02098, 02101, 02109, 02139, 02208, 02218, 02228, 02309, 0232 | 308668C92 | 010 | 85012 | 89413 | ... | ...   |       |
|           |   | 453556C91 | 010 | 85012 | 89413 | ... | ...   |       |
|           |   | 467985C91 | 010 | 85012 | 89413 | ... | ...   |       |
|           |   | 874695R91 | 010 | 85012 | 89413 | ... | ...   |       |
|           |   | 874695R92 | 010 | 85012 | 89413 | ... | ...   |       |
|           | 1600, 1610FC, 1700, 1700 (4x4), 1800, 1890, 1890D Models  | 384435C91 |     | ...   | ...   | 010 | 83216 | ...   |
|           |   | 453571C91 |     | ...   | ...   | 010 | 83216 | ...   |
|           |   | 462753C91 |     | ...   | ...   | 010 | 83216 | ...   |
|           | 1700, 1750, 1800, 1850 Models with Air Ride Suspension  | 462557C91 |     | ...   | ...   | 010 | 85300 | 89419 |
|           | M1600, M1700, M1800, M1900, M2100 Models  | 453576C92 | 010 | 85303 | 89422 | ... | ...   |       |

**LoneStar - Series**

|         |  |           |     |       |     |     |       |       |
|---------|--|-----------|-----|-------|-----|-----|-------|-------|
| 09 - 15 | All models with 40,000 lb Rear Air Suspension                | 3620395C1 |     | ...   | ... | 010 | 85931 | 89458 |
| 08 - 10 | Models with 12,000 lb Mono-leaf Front Spring                 | 3819277C1 | 010 | 85969 | ... |     | ...   | ...   |
|         |  | 3819279C1 | 010 | 85969 | ... |     | ...   | ...   |
| 09 - 18 | Models with 12,350 lb Front Mono Leaf Spring Suspension      | 3813341C1 | 010 | 85963 | ... |     | ...   | ...   |
|         |  | 3813341C2 | 010 | 85963 | ... |     | ...   | ...   |
|         |  | 3813341C3 | 010 | 85963 | ... |     | ...   | ...   |
|         |  | 3813341C4 | 010 | 85963 | ... |     | ...   | ...   |
| - 2017  | Models with Hendrickson HAS - 230 or 460 Rear Air Suspension | 3514952C1 |     | ...   | ... | 010 | 85976 | ...   |

## APPLICATION GUIDE - TRUCKS, TRAILERS, AND BUSES

| Year<br>Año<br>Année | Model<br>Modelo<br>Modèle | OEM # | Front   |   | Rear  |   |
|----------------------|---------------------------|-------|---|---|---|---|
|                      |                           |       |  |  |  |  |
|                      |                           |       | Fleetline   | GasSLX  | Fleetline   | GasSLX  |

### INTERNATIONAL (NAVISTAR)(Cont'd.)

#### LoneStar - Series(Cont'd.)

|         |  |            |     |              |     |     |              |              |
|---------|--|------------|-----|--------------|-----|-----|--------------|--------------|
| - 2017  | Models with Hendrickson HAS - 230 or 460 Rear Air Suspension                           | 57905-001  |     | ...          | ... | 010 | <b>85976</b> | ...          |
|         |  | 60675-003  |     | ...          | ... | 010 | <b>85976</b> | ...          |
|         |  | 60675-003L |     | ...          | ... | 010 | <b>85976</b> | ...          |
|         |  | H60675-003 |     | ...          | ... | 010 | <b>85976</b> | ...          |
| 12 - 16 | Models with International 40,000 lb Rear Air Suspension (52" Spacing- Heavy Duty Rear) | 3688614C1  |     | ...          | ... | 010 | <b>85923</b> | <b>89458</b> |
|         |  | 3688616C1  |     | ...          | ... | 010 | <b>85923</b> | <b>89458</b> |
| 2013 -  | Models with O.E.M. Number  | 3810581C3  | 010 | <b>85995</b> | ... |     | ...          | ...          |
|         |  | 3810581C4  | 010 | <b>85995</b> | ... |     | ...          | ...          |
| 09 - 19 | Sleeper Cab models with 14,000 lb Parabolic Taperleaf Front Spring                     | 3813340C1  | 010 | <b>85964</b> | ... |     | ...          | ...          |
|         |  | 3813340C2  | 010 | <b>85964</b> | ... |     | ...          | ...          |
|         |  | 3813340C3  | 010 | <b>85964</b> | ... |     | ...          | ...          |
|         |  | 3813340C4  | 010 | <b>85964</b> | ... |     | ...          | ...          |









#### LT - Series

|           |  |            |     |              |     |     |              |     |
|-----------|--|------------|-----|--------------|-----|-----|--------------|-----|
| 2018 - 19 | LT-625 Models with 12,000 - 14,000 lb Taperleaf Spring Suspension    | 4050444C2  | 010 | <b>85994</b> | ... |     | ...          | ... |
| 2018 - 19 | LT-625 Models with 12,000 lb - 13,200 lb Mono-Leaf Spring Suspension | 4050443C2  | 010 | <b>85994</b> | ... |     | ...          | ... |
| 2018      | Models with Hendrickson HTB 400LT Rear Air Suspension                | 3684524C1  |     | ...          | ... | 010 | <b>85102</b> | ... |
|           |  | 60657-010  |     | ...          | ... | 010 | <b>85102</b> | ... |
|           |  | H60657-010 |     | ...          | ... | 010 | <b>85102</b> | ... |

#### Metro & Multi-Shop Series

|         |  |           |     |               |              |     |               |              |
|---------|--|-----------|-----|---------------|--------------|-----|---------------|--------------|
|         | AM and AMC-160, AMC-164  | 308649C91 | 010 | <b>83216</b>  | ...          |     | ...           | ...          |
|         |  | 453567C91 | 010 | <b>83216</b>  | ...          |     | ...           | ...          |
|         | M1600, M1700, M1800, M1900, M2100 Models   | 453576C92 | 010 | <b>85303</b>  | <b>89422</b> |     | ...           | ...          |
|         | M1600, M1700, M1800, M1900, M2100 Models - Exc. with Rear Axle Codes 14029, 14030, 14187                       | 501905C91 |     | ...           | ...          | -10 | <b>83301</b>  | ...          |
|         |  | 501906C91 |     | ...           | ...          | -10 | <b>83317</b>  | ...          |
|         | M1600, M1700, M1800, M1900, M2100 Models with 5000, 6000 or 7500 lb Front Axle                                 | 472367C91 | -1- | <b>83318</b>  | ...          |     | ...           | ...          |
|         | M1600, M1700, M1800, M1900, M2100 Models with 9000, 10800 or 12000 Front Axle                                  | 472411C91 | -1- | <b>83456</b>  | <b>89447</b> |     | ...           | ...          |
|         | M1600, M1700, M1800, M1900, M2100 Models with Front Axle Codes 02109, 02118, 02309, 02127, 02139, 02329, 02339 | 472412C91 | -1- | <b>83456</b>  | <b>89447</b> |     | ...           | ...          |
|         |  | 586724C91 | -1- | <b>83456</b>  | <b>89447</b> |     | ...           | ...          |
|         | M1600, MC1600, M1700 & MC1700  | 206620R91 |     | ...           | ...          | 010 | <b>83216</b>  | ...          |
|         |  | 308649C91 |     | ...           | ...          | 010 | <b>83216</b>  | ...          |
|         |  | 308668C91 | 010 | <b>85012</b>  | <b>89413</b> |     | ...           | ...          |
|         |  | 308669C91 | 010 | <b>85012</b>  | <b>89413</b> |     | ...           | ...          |
|         |  | 453556C91 | 010 | <b>85012</b>  | <b>89413</b> |     | ...           | ...          |
|         |  | 453597C91 |     | ...           | ...          | 010 | <b>83216</b>  | ...          |
|         |  | 874695R91 | 010 | <b>85012</b>  | <b>89413</b> |     | ...           | ...          |
|         |  | 874696R91 | 010 | <b>85012</b>  | <b>89413</b> |     | ...           | ...          |
|         | MA1200, M1400, M1500, MA1500   | 287318C91 |     | <b>G63306</b> | ...          | 010 | <b>G63306</b> | ...          |
|         |  | 308649C91 |     | ...           | ...          | 010 | <b>83216</b>  | ...          |
|         |  | 308669C91 |     | ...           | ...          | 010 | <b>85012</b>  | <b>89413</b> |
|         |  | 453531C91 |     | ...           | ...          | 010 | <b>G63306</b> | ...          |
|         |  | 453556C91 |     | ...           | ...          | 010 | <b>85012</b>  | <b>89413</b> |
|         |  | 453557C91 |     | ...           | ...          | 010 | <b>G63306</b> | ...          |
|         |  | 453567C91 |     | ...           | ...          | 010 | <b>83216</b>  | ...          |
|         |  | 467980C91 |     | <b>G63306</b> | ...          | 010 | <b>G63306</b> | ...          |
| 66 - 72 | Metro Models M1200 - Exc. Frame Code 01000.0962  | .....     | 010 | <b>G63299</b> | ...          |     | ...           | ...          |
| 66 - 72 | Metro Models M1200 with 14016 Reg. Rear Springs & with 14020 Rear Axle Code                                    | .....     |     | <b>G63306</b> | ...          | 010 | <b>G63306</b> | ...          |
| 66 - 72 | Metro Models M1200 with Axle Code 0208 & Frame Code 01000.0962   | .....     |     | <b>G63306</b> | ...          | 010 | <b>G63306</b> | ...          |

## APPLICATION GUIDE - TRUCKS, TRAILERS, AND BUSES

| Year<br>Año<br>Année | Model<br>Modelo<br>Modèle | OEM # | Front  |   | Rear   |   |
|----------------------|---------------------------|-------|--|---|--|---|
|                      |                           |       |  |  |  |  |
|                      |                           |       |   |  |   |  |
|                      |                           |       | Fleetline  | GasSLX  | Fleetline  | GasSLX  |

### INTERNATIONAL (NAVISTAR)(Cont'd.)

#### Metro & Multi-Shop Series(Cont'd.)

|         |   |       |  |               |     |     |               |     |  |
|---------|---|-------|--|---------------|-----|-----|---------------|-----|--|
| 66 - 72 | Metro Models M1200 with Code 03204 Aux. Springs | ..... |  |               |     |     |               |     |  |
| 66 - 72 | Metro Models M700, 800, 900-U, 1000, 1100,      | ..... |  | <b>G63306</b> | ... | 010 | <b>G63306</b> | ... |  |
| 73 - 75 | Multi-Stop Models MS-1210 & 1510                | ..... |  | ...           | ... | 010 | <b>G63306</b> | ... |  |

#### MV Series

|      |  |           |  |  |  |  |  |  |  |
|------|--|-----------|--|--|--|--|--|--|--|
| 2019 | MV 607 Models with 9,000 to 10,000 lb Front Suspension | 6127088C1 |  |  |  |  |  |  |  |
|------|--|-----------|--|--|--|--|--|--|--|

#### Paystar - 5000 Series





|         |  |            |     |              |              |     |              |              |  |
|---------|--|------------|-----|--------------|--------------|-----|--------------|--------------|--|
|         | 5010, F-5010, F-5050, F-5050SF, 5070, F-5070, F-5070SF Models  | 426744R91  |     |              |              |     |              |              |  |
|         |  | 426744R92  | 010 | <b>85303</b> | <b>89422</b> |     | ...          | ...          |  |
|         |  | 453576C91  | 010 | <b>85303</b> | <b>89422</b> |     | ...          | ...          |  |
|         |  | 453576C92  | 010 | <b>85303</b> | <b>89422</b> |     | ...          | ...          |  |
|         |  | 477132C1   | 010 | <b>85303</b> | <b>89422</b> |     | ...          | ...          |  |
| - 2012  | 5600i Models with 16,000 lb Front axle   | 1667520C1  | 010 | <b>85058</b> | <b>89431</b> |     | ...          | ...          |  |
|         |  | 4070336C1  | 010 | <b>85058</b> | <b>89431</b> |     | ...          | ...          |  |
| 04 - 12 | 5900 SB Models with 18,000 lb Front axle   | 1667520C1  | 010 | <b>85058</b> | <b>89431</b> |     | ...          | ...          |  |
| 04 - 15 | 5900 SB Models with 46,000 lb Hendrickson Rear Air Suspension  | 3626571C1  |     | ...          | ...          | 010 | <b>85072</b> | ...          |  |
|         |  | H60657-003 |     | ...          | ...          | 010 | <b>85072</b> | ...          |  |
| - 2018  | 5900 SB Models with Hendrickson Primaax 230, 460 and 690 Air Suspension (8-1/2" to 10" Ride Height)    | 60657-003  |     | ...          | ...          | 010 | <b>85072</b> | ...          |  |
|         |  | 60657-003L |     | ...          | ...          | 010 | <b>85072</b> | ...          |  |
| - 2018  | 5900 SB Models with Hendrickson Primaax EX 232, 462 and 692 Air Suspension (8-1/2" to 10" Ride Height) | 60657-003  |     | ...          | ...          | 010 | <b>85072</b> | ...          |  |
|         |  | 60657-003L |     | ...          | ...          | 010 | <b>85072</b> | ...          |  |
| 09 - 11 | 5900i Models with 12,000 lb - 14,000 lb Front axle   | 2015556C1  | -10 | <b>85316</b> | <b>89426</b> |     | ...          | ...          |  |
| 04 - 12 | 5900i SFA Models with 16,000 lb Front axle   | 1667520C1  | 010 | <b>85058</b> | <b>89431</b> |     | ...          | ...          |  |
| 04 - 09 | 5900i SFA Models with 46,000 lb Neway Rear Air Suspension  | 2029200C91 |     | ...          | ...          | 010 | <b>83126</b> | <b>89430</b> |  |
|         |  | 90044626   |     | ...          | ...          | 010 | <b>83126</b> | <b>89430</b> |  |
|         | Models with 10,000 to 16,000 lb Front Suspension   | 3576465C2  | 010 | <b>85999</b> | ...          |     | ...          | ...          |  |
|         |  | 3816234C1  | 010 | <b>85999</b> | ...          |     | ...          | ...          |  |
| 10 - 13 | Models with 12,000 to 14,000 lb Front Taperleaf Suspension   | 3868264C1  | 010 | <b>85998</b> | ...          |     | ...          | ...          |  |
| - 2013  | Models with Hendrickson HMX 400/460 Haulmax with 16.5" Saddle  | 60680-004  |     | ...          | ...          | 01- | <b>83143</b> | ...          |  |
|         |  | 60680-004L |     | ...          | ...          | 01- | <b>83143</b> | ...          |  |
|         | Models with O.E.M. Number  | 6127690C1  |     | ...          | ...          | 010 | <b>85923</b> | <b>89458</b> |  |

#### ProStar - Series

|         |   |           |     |              |     |     |              |              |  |
|---------|---|-----------|-----|--------------|-----|-----|--------------|--------------|--|
| 09 - 17 | All models with 40,000 lb Rear Air Suspension                                 | 3620395C1 |     |              |     |     |              |              |  |
|         |   | 4050340C1 |     | ...          | ... | 010 | <b>85931</b> | <b>89458</b> |  |
|         |   | 4050340C2 |     | ...          | ... | 010 | <b>85931</b> | <b>89458</b> |  |
|         | Day Models with O.E.M. Number   | 3737576C1 |     | ...          | ... | 010 | <b>85931</b> | <b>89458</b> |  |
| 2013 -  | Models with 113" Sleeper Cab  | 3806341C3 | 010 | <b>85995</b> | ... |     | ...          | ...          |  |
|         |   | 3806341C4 | 010 | <b>85995</b> | ... |     | ...          | ...          |  |
|         |   | 3810581C3 | 010 | <b>85995</b> | ... |     | ...          | ...          |  |
|         |   | 3810581C3 | 010 | <b>85995</b> | ... |     | ...          | ...          |  |
|         |   | 3810581C4 | 010 | <b>85995</b> | ... |     | ...          | ...          |  |
| - 2013  | Models with 12,350 lb Front Mono Leaf Spring Suspension                       | 3610198C1 | 010 | <b>85963</b> | ... |     | ...          | ...          |  |
| 09 - 18 | Models with 12,350 lb Front Mono Leaf Spring Suspension                       | 3813341C3 | 010 | <b>85963</b> | ... |     | ...          | ...          |  |
|         |   | 3813341C4 | 010 | <b>85963</b> | ... |     | ...          | ...          |  |
| 16 - 17 | Models with Day Cab and 12,000 - 14,000 lb Taperleaf Front Spring Suspension  | 4050444C1 | 010 | <b>85994</b> | ... |     | ...          | ...          |  |
|         |   | 4050444C2 | 010 | <b>85994</b> | ... |     | ...          | ...          |  |
| -2015   | Models with Day Cab and 12,000 to 14,000 lb Taperleaf Front Spring Suspension | 3606859C1 | 010 | <b>85954</b> | ... |     | ...          | ...          |  |
|         |   | 3606859C2 | 010 | <b>85954</b> | ... |     | ...          | ...          |  |
|         |   | 3606859C3 | 010 | <b>85994</b> | ... |     | ...          | ...          |  |
|         |   | 3737574C1 | 010 | <b>85954</b> | ... |     | ...          | ...          |  |
|         |   | 3812837C1 | 010 | <b>85954</b> | ... |     | ...          | ...          |  |



## APPLICATION GUIDE - TRUCKS, TRAILERS, AND BUSES

| Year<br>Año<br>Année | Model<br>Modelo<br>Modèle | OEM # | Front   |   | Rear  |   |
|----------------------|---------------------------|-------|---|---|---|---|
|                      |                           |       |  |  |  |  |
|                      |                           |       | Fleetline   | GasSLX  | Fleetline   | GasSLX  |

### INTERNATIONAL (NAVISTAR)(Cont'd.)

#### ProStar - Series(Cont'd.)

|         |   |            |     |              |     |     |              |              |
|---------|---|------------|-----|--------------|-----|-----|--------------|--------------|
|         | Models with Day Cab and Air Suspension                              | 3610199C1  | 010 | <b>85964</b> | ... |     | ...          | ...          |
| - 2017  | Models with Hendrickson HAS - 230 or 460 Rear Air Suspension        | 3514952C1  |     | ...          | ... | 010 | <b>85976</b> | ...          |
|         |   | 57905-001  |     | ...          | ... | 010 | <b>85976</b> | ...          |
|         |   | 60675-003  |     | ...          | ... | 010 | <b>85976</b> | ...          |
|         |   | 60675-003L |     | ...          | ... | 010 | <b>85976</b> | ...          |
|         |   | H60675-003 |     | ...          | ... | 010 | <b>85976</b> | ...          |
|         | Models with Hendrickson HTB 400LT Rear Air Suspension               | 60657-006  |     | ...          | ... | 010 | <b>85102</b> | ...          |
|         |   | 60657-010  |     | ...          | ... | 010 | <b>85102</b> | ...          |
|         |   | 60657-011  |     | ...          | ... | 010 | <b>85102</b> | ...          |
|         |   | H60657-006 |     | ...          | ... | 010 | <b>85102</b> | ...          |
|         |   | H60657-010 |     | ...          | ... | 010 | <b>85102</b> | ...          |
|         |   | H60657-011 |     | ...          | ... | 010 | <b>85102</b> | ...          |
|         | Models with O.E.M. Number   | 3668566C1  | 010 | <b>85954</b> | ... |     | ...          | ...          |
|         |   | 3688729C1  |     | ...          | ... | 010 | <b>85931</b> | <b>89458</b> |
|         |   | 3688732C1  |     | ...          | ... | 010 | <b>85931</b> | <b>89458</b> |
|         |   | 3821760C1  |     | ...          | ... | 010 | <b>85931</b> | <b>89458</b> |
| - 2014  | Models with Sleeper Cab and 12,350 lb Leaf Spring Suspension        | 3606857C1  | 010 | <b>85954</b> | ... |     | ...          | ...          |
|         |   | 3606857C2  | 010 | <b>85954</b> | ... |     | ...          | ...          |
| 14 - 15 | Models with Sleeper Cab and 12,350 lb Leaf Spring Suspension        | 3606857C3  | 010 | <b>85994</b> | ... |     | ...          | ...          |
|         | Models with Sleeper Cab with O.E.M. Number                          | 3737575C1  | 010 | <b>85954</b> | ... |     | ...          | ...          |
| 2016 -  | Sleeper Cabs with 12,000 lb - 13,200 lb Mono-Leaf Spring Suspension | 4050443C1  | 010 | <b>85994</b> | ... |     | ...          | ...          |
|         |   | 4050443C2  | 010 | <b>85994</b> | ... |     | ...          | ...          |





#### RH - Series

|           |  |           |     |              |     |  |     |     |
|-----------|--|-----------|-----|--------------|-----|--|-----|-----|
| 2018 - 19 | RH-613 Models with 12,000 lb - 13,200 lb Mono-Leaf Spring Suspension | 4050443C2 | 010 | <b>85994</b> | ... |  | ... | ... |
|-----------|--|-----------|-----|--------------|-----|--|-----|-----|

#### S Series School Bus

|           |   |           |     |              |              |     |              |              |
|-----------|---|-----------|-----|--------------|--------------|-----|--------------|--------------|
|           | 1603, 1703, 1803 & 1853   | 206620R91 | 010 | ...          | ...          | 010 | <b>83216</b> | ...          |
|           |   | 206621R91 |     | ...          | ...          | 010 | <b>83216</b> | ...          |
|           |   | 306444C91 |     | ...          | ...          | 010 | <b>85012</b> | <b>89413</b> |
|           |   | 308649C91 |     | ...          | ...          | 010 | <b>83216</b> | ...          |
|           |   | 308650C92 |     | ...          | ...          | 010 | <b>83216</b> | ...          |
|           |   | 329316C92 |     | ...          | ...          | 010 | <b>85012</b> | <b>89413</b> |
|           |   | 383379C91 |     | ...          | ...          | 010 | <b>83308</b> | ...          |
|           |   | 453564C91 |     | ...          | ...          | 010 | <b>85012</b> | <b>89413</b> |
|           |   | 453567C91 |     | ...          | ...          | 010 | <b>83216</b> | ...          |
|           |   | 453570C91 |     | ...          | ...          | 010 | <b>83216</b> | ...          |
|           |   | 453575C91 |     | ...          | ...          | 010 | <b>83308</b> | ...          |
|           |   | 467983C91 |     | ...          | ...          | 010 | <b>85012</b> | <b>89413</b> |
|           |   | 471201C91 |     | ...          | ...          | 010 | <b>85012</b> | <b>89413</b> |
|           |   | 471203C91 |     | ...          | ...          | 010 | <b>83308</b> | ...          |
|           |   | 474002C91 |     | ...          | ...          | 010 | <b>83308</b> | ...          |
| 873622C91 | ...   | ...       | 010 | <b>83308</b> | ...          |     |              |              |
|           | 1603, 1703, 1803 & 1853 - Exc. Axle Codes 02054, 02057, 02059, 02089, 02091, 02098, 02101, 02109, 02139, 02208, 02218, 02228, 02309, 02329, 02339 | 308668C92 | 010 | <b>85012</b> | <b>89413</b> |     | ...          | ...          |
|           |   | 453556C91 | 010 | <b>85012</b> | <b>89413</b> |     | ...          | ...          |
|           |   | 467985C91 | 010 | <b>85012</b> | <b>89413</b> |     | ...          | ...          |
|           |   | 874695R91 | 010 | <b>85012</b> | <b>89413</b> |     | ...          | ...          |
|           | 1603, 1703, 1803 & 1853 with Axle Codes 02089, 02091  | 206620R91 | 010 | <b>83216</b> | ...          |     | ...          | ...          |
|           |   | 308649C91 | 010 | <b>83216</b> | ...          |     | ...          | ...          |
|           |   | 453567C91 | 010 | <b>83216</b> | ...          |     | ...          | ...          |
|           |   | 467984C91 | 010 | <b>83216</b> | ...          |     | ...          | ...          |

**APPLICATION GUIDE - TRUCKS, TRAILERS, AND BUSES**

| Year<br>Año<br>Année | Model<br>Modelo<br>Modèle | OEM # | Front   |   | Rear  |  |
|----------------------|---------------------------|-------|---|---|---|--|
|                      |                           |       |  Fleetline |  GasSLX |  Fleetline |  GasSLX |

**INTERNATIONAL (NAVISTAR)(Cont'd.)**





**S Series School Bus(Cont'd.)**

|  |           |     |       |       |     |       |       |
|--|-----------|-----|-------|-------|-----|-------|-------|
| 1603, 1703, 1803 & 1853 with 9000, 10800 or 12000 lb Front Axle                                    | 329316C92 | 010 | 85012 | 89413 |     | ...   | ...   |
|  | 453564C91 | 010 | 85012 | 89413 |     | ...   | ...   |
|  | 467983C91 | 010 | 85012 | 89413 |     | ...   | ...   |
|  | 467983C91 | 010 | 85012 | 89413 |     | ...   | ...   |
| 1723 S Models with 5000, 6000 or 7500 lb Front Axle  | 472367C91 | -1- | 83318 | ...   |     | ...   | ...   |
| 1723, 1823, 1853 Models with International Air Suspension  | 1675455C1 |     | ...   | ...   | 010 | 85003 | 89411 |
|  | 1690035C1 |     | ...   | ...   | 010 | 85003 | 89411 |
|  | 2018987C1 |     | ...   | ...   | 010 | 85003 | 89411 |
|  | 2018987C2 |     | ...   | ...   | 010 | 85003 | 89411 |
|  | 501553C91 |     | ...   | ...   | 010 | 85003 | 89411 |
| 1723, 1823, 1853 Models with Neway ARD-234 Air Suspension  | 537524C91 |     | ...   | ...   | 010 | 83123 | 89405 |
| 173 FC & 183 FC - Exc. Axle Codes 14149 & 14189  | 210918R91 |     | ...   | ...   | 010 | 83215 | ...   |
|  | 453574C91 |     | ...   | ...   | 010 | 85307 | ...   |
| 173 FC & 183 FC with Axle Codes 14149 & 14189  | 210535R91 |     | ...   | ...   | 010 | 83225 | ...   |
|  | 453568C91 |     | ...   | ...   | 010 | 83225 | ...   |
|  | 467372C91 |     | ...   | ...   | 010 | 83225 | ...   |
| 173 FC, 183 FC, 183RE, 193 RE, 1853 FC & 1853 DFC  | 204994R91 | 010 | 83225 | ...   |     | ...   | ...   |
|  | 308648C91 | 010 | 83225 | ...   |     | ...   | ...   |
|  | 453561C91 | 010 | 83225 | ...   |     | ...   | ...   |
|  | 453565C91 | 010 | 83225 | ...   |     | ...   | ...   |
|  | 467371C91 | 010 | 83225 | ...   |     | ...   | ...   |
| 1823 S Models - Exc. with Rear Axle Codes 14029,14030, 14187                                       | 501906C91 |     | ...   | ...   | -10 | 83317 | ...   |
| 1823, 1853 S Models with 9000, 10800 or 12000 lb Front Axle  | 472411C91 | -1- | 83456 | 89447 |     | ...   | ...   |
|  | 472412C91 | -1- | 83456 | 89447 |     | ...   | ...   |
|  | 586724C91 | -1- | 83456 | 89447 |     | ...   | ...   |
| 183 RE Models with Axle Codes 14043, 14147 & 14186   | 210533R91 |     | ...   | ...   | 010 | 83225 | ...   |
|  | 210534R92 |     | ...   | ...   | 010 | 83225 | ...   |
|  | 453562C91 |     | ...   | ...   | 010 | 83225 | ...   |
|  | 467371C91 |     | ...   | ...   | 010 | 83225 | ...   |
| 1853 DFC3  | 210920R91 | 010 | 85308 | 89422 |     | ...   | ...   |
|  | 453579C91 | 010 | 85308 | 89422 |     | ...   | ...   |
| 1853 FC & 1853 DFC with Axle Code 14136  | 210919R91 |     | ...   | ...   | 010 | 85307 | ...   |
|  | 308664C91 |     | ...   | ...   | 010 | 85307 | ...   |
|  | 453574C91 |     | ...   | ...   | 010 | 85307 | ...   |
| 1853 FC & 1853 DFC with Axle Code 14149 with FD Serial Numbers                                     | 453567C91 |     | ...   | ...   | 010 | 83216 | ...   |
| 1853 FC & 1853 DFC with Axle Codes 14039, 14139, 14149 & 14189 - Exc. 14149 with FD Serial Numbers | 210533R91 |     | ...   | ...   | 010 | 83225 | ...   |
|  | 210534R92 |     | ...   | ...   | 010 | 83225 | ...   |
|  | 453562C91 |     | ...   | ...   | 010 | 83225 | ...   |
|  | 467371C91 |     | ...   | ...   | 010 | 83225 | ...   |
| 1853 FC & 1853 DFC with Axle Codes 14044, 14045, 14060, 14145, 14146, 14150 and 14186              | 208664C91 |     | ...   | ...   | 010 | 85307 | ...   |
|  | 210919R91 |     | ...   | ...   | 010 | 85307 | ...   |
|  | 453574C91 |     | ...   | ...   | 010 | 85307 | ...   |
| 193 RE Models  | 210920R91 | 010 | 85308 | 89422 |     | ...   | ...   |
|  | 453579C91 | 010 | 85308 | 89422 |     | ...   | ...   |
| 193 RE Models - Exc. Axle Codes 14039 & 14189  | 210533R91 |     | ...   | ...   | 010 | 83225 | ...   |
|  | 210534R92 |     | ...   | ...   | 010 | 83225 | ...   |
|  | 453562C91 |     | ...   | ...   | 010 | 83225 | ...   |
|  | 467371C91 |     | ...   | ...   | 010 | 83225 | ...   |
| RE Models  | 3604282C1 | -10 | 85351 | ...   |     | ...   | ...   |

**Series 1000 Forward Control Chassis**

|                   |           |     |       |       |  |     |     |
|-------------------|-----------|-----|-------|-------|--|-----|-----|
| 1452, 1652 Models | 453576C92 | 010 | 85303 | 89422 |  | ... | ... |
|-------------------|-----------|-----|-------|-------|--|-----|-----|

**APPLICATION GUIDE - TRUCKS, TRAILERS, AND BUSES**

| Year<br>Año<br>Année | Model<br>Modelo<br>Modèle | OEM # | Front   |   | Rear  |   |
|----------------------|---------------------------|-------|---|---|---|---|
|                      |                           |       |  |  |  |  |
|                      |                           |       | Fleetline   | GasSLX  | Fleetline   | GasSLX  |

**INTERNATIONAL (NAVISTAR)(Cont'd.)**

**Series 1000 Forward Control Chassis(Cont'd.)**

|   |            |     |       |       |     |       |       |
|---|------------|-----|-------|-------|-----|-------|-------|
| 1452, 1652 Models                                   | 472412C91  | - - | 83456 | 89447 |     | ...   | ...   |
|   | 586724C91  | - - | 83456 | 89447 |     | ...   | ...   |
| 1452, 1652 Models with International Air Suspension | 1675455C1  |     | ...   | ...   | o o | 85003 | 89411 |
|   | 1690035C1  |     | ...   | ...   | o o | 85003 | 89411 |
|   | 2018987C1  |     | ...   | ...   | o o | 85003 | 89411 |
|   | 2018987C2  |     | ...   | ...   | o o | 85003 | 89411 |
|   | 501553C91  |     | ...   | ...   | o o | 85003 | 89411 |
| 1452, 1652 Models with MOR-RYDE Rear Suspension     | 548532C1   |     | ...   | ...   | - - | 83103 | ...   |
| 1654 LP Models (Low Profile Vehicle)                | 1660846C91 |     | ...   | ...   | o o | 83101 | ...   |
|   | 1660846C92 |     | ...   | ...   | o o | 83101 | ...   |
|   | 1663471C1  | - - | 83103 | ...   |     | ...   | ...   |
|   | 2039565C1  |     | ...   | ...   | o o | 83100 | ...   |
| M1400, M1600 Models                                 | 472412C91  | - - | 83456 | 89447 |     | ...   | ...   |
|   | 501905C91  |     | ...   | ...   | - o | 83301 | ...   |
|   | 586724C91  | - - | 83456 | 89447 |     | ...   | ...   |

**Series 2000 - Conventional Truck (Severe Service)**

|  |           |     |       |       |     |       |       |
|--|-----------|-----|-------|-------|-----|-------|-------|
| 2554, 2574, 2654, 2674 Models with International Air Suspension  | 1675455C1 |     | ...   | ...   | o o | 85003 | 89411 |
|  | 1690035C1 |     | ...   | ...   | o o | 85003 | 89411 |
|  | 2018987C1 |     | ...   | ...   | o o | 85003 | 89411 |
|  | 2018987C2 |     | ...   | ...   | o o | 85003 | 89411 |
|  | 501553C91 |     | ...   | ...   | o o | 85003 | 89411 |
| 2554, 2574, 2654, 2674 Models with International Vari-Rate Rear Suspension   | 501506C91 |     | ...   | ...   | - o | 83317 | ...   |
| All 2000 Models<br>With 12000 lb Front Axle<br>With 16000 or 18000 lb Springs<br>Without 16000 or 18000 lb Springs | 472412C91 | - - | 83456 | 89447 |     | ...   | ...   |
|  | 1667520C1 | o o | 85058 | 89431 |     | ...   | ...   |
|  | 2015556C1 | - o | 85316 | 89426 |     | ...   | ...   |





**Series 3000 - School Bus Chassis**

|   |           |     |       |       |     |       |       |
|---|-----------|-----|-------|-------|-----|-------|-------|
| 3000, 3400 Models with 10,000 to 14,000 lb Front axle | 3533357C1 | o o | 85957 | ...   |     | ...   | ...   |
|   | 3533357C2 | o o | 85957 | ...   |     | ...   | ...   |
|   | 3533357C3 | o o | 85957 | ...   |     | ...   | ...   |
| 3000, 3400 Models with 6,000 to 8,000 lb Front axle   | 3533356C1 | o o | 83135 | ...   |     | ...   | ...   |
|   | 3533356C2 | o o | 83135 | ...   |     | ...   | ...   |
| 3700, 3800 Models                                     | 472412C91 | - - | 83456 | 89447 |     | ...   | ...   |
|   | 501905C91 |     | ...   | ...   | - o | 83301 | ...   |
|   | 501906C91 |     | ...   | ...   | - o | 83317 | ...   |
|   | 586724C91 | - - | 83456 | 89447 |     | ...   | ...   |
| 3700, 3800 Models with International Air Suspension   | 1675455C1 |     | ...   | ...   | o o | 85003 | 89411 |
|   | 1690035C1 |     | ...   | ...   | o o | 85003 | 89411 |
|   | 2018987C1 |     | ...   | ...   | o o | 85003 | 89411 |
|   | 2018987C2 |     | ...   | ...   | o o | 85003 | 89411 |
|   | 501553C91 |     | ...   | ...   | o o | 85003 | 89411 |
| 3700, 3800 Models with MOR-RYDE Rear Suspension       | 548532C1  |     | ...   | ...   | - - | 83103 | ...   |
| 3700, 3800 Models with Neway ARD-234 Air Suspension   | 537524C91 |     | ...   | ...   | o o | 83123 | 89405 |
|   | 537525C91 |     | ...   | ...   | o o | 83123 | 89405 |
| 3900FC Models   | 1677707C1 | o o | 85030 | 89440 |     | ...   | ...   |
|   | 2015557C1 | o o | 85030 | 89440 |     | ...   | ...   |
|   | 467371C91 |     | 83225 | ...   | o o | 83225 | ...   |
| 3900FC Models (Genesis - Front Engine)                | 2200327C1 | - o | 85332 | ...   |     | ...   | ...   |
| 3900FC Models (Genesis - Rear Engine)                 | 2039549C1 | - o | 85333 | ...   |     | ...   | ...   |

**Series 400, 500, 600, 700, & 900 - Medium Cabover Truck & Tractor ( Nissan)**

|            |             |     |        |     |  |     |     |
|------------|-------------|-----|--------|-----|--|-----|-----|
| 400 Models | 56101 Z5008 | - o | 83114  | ... |  | ... | ... |
|            | 56101 Z5011 | - o | G63610 | ... |  | ... | ... |
| 500 Models | 56101 Z5011 | - o | G63610 | ... |  | ... | ... |

**APPLICATION GUIDE - TRUCKS, TRAILERS, AND BUSES**

| Year<br>Año<br>Année | Model<br>Modelo<br>Modèle | OEM # | Front   |   | Rear  |  |
|----------------------|---------------------------|-------|---|---|---|--|
|                      |                           |       |  Fleetline |  GasSLX |  Fleetline |  GasSLX |

**INTERNATIONAL (NAVISTAR)(Cont'd.)**

**Series 400, 500, 600, 700, & 900 - Medium Cabover Truck & Tractor ( Nissan)(Cont'd.)**

|                      |             |     |              |              |  |     |     |
|----------------------|-------------|-----|--------------|--------------|--|-----|-----|
| 600, 700, 900 Models | 56101 Z1030 | -10 | <b>85311</b> | <b>89424</b> |  | ... | ... |
|                      | 56101 Z2000 | -10 | <b>85311</b> | <b>89424</b> |  | ... | ... |

**Series 4000 - Short Conventional Medium Truck & Tractor**

|  |  |     |              |              |     |              |              |
|--|--|-----|--------------|--------------|-----|--------------|--------------|
| 4000 Models with Hendrickson HAS-230 Rear Air Suspension                           | AMS650420  |     | ...          | ...          | 010 | <b>85013</b> | <b>89414</b> |
| 4600, 4700, 4800, 4900 Models  | 1663606C91   | -1- | <b>85027</b> | <b>89418</b> |     | ...          | ...          |
|  | 1667520C1  | 010 | <b>85058</b> | <b>89431</b> |     | ...          | ...          |
|  | 586724C91  | -1- | <b>83456</b> | <b>89447</b> |     | ...          | ...          |
| 4600, 4700, 4800, 4900 Models with 10000 lb Front Axle                             | 472412C91  | -1- | <b>83456</b> | <b>89447</b> |     | ...          | ...          |
| 4600, 4700, 4800, 4900 Models with International Air Suspension (Exc. Low Profile) | 1675455C1  |     | ...          | ...          | 010 | <b>85003</b> | <b>89411</b> |
|  | 1690035C1  |     | ...          | ...          | 010 | <b>85003</b> | <b>89411</b> |
|  | 2018987C1  |     | ...          | ...          | 010 | <b>85003</b> | <b>89411</b> |
|  | 2018987C2  |     | ...          | ...          | 010 | <b>85003</b> | <b>89411</b> |
|  | 501553C91  |     | ...          | ...          | 010 | <b>85003</b> | <b>89411</b> |
| 4600LP, 4700LP Models (Low Profile Vehicle) U-Haul                                 | 540395C91  | -1- | <b>83613</b> | ...          |     | ...          | ...          |
|  | 540395C92  | -1- | <b>83613</b> | ...          |     | ...          | ...          |
| 02/95-   | 4600LP, 4700LP Models (Low Profile Vehicle) U-Haul |     | ...          | ...          | 010 | <b>83100</b> | ...          |
| 4600LP, 4700LP Models (Low Profile Vehicle) with Air Suspension                    | 1660846C91   |     | ...          | ...          | 010 | <b>83101</b> | ...          |
|  | 1660846C92   |     | ...          | ...          | 010 | <b>83101</b> | ...          |
| F-4900 & 4600LP Models (Low Profile Vehicle)                                       | 501906C91  |     | ...          | ...          | -10 | <b>83317</b> | ...          |
|  | 501906C92  |     | ...          | ...          | -10 | <b>83317</b> | ...          |
| 90 - 02  | F-4900 Models with 10000 lb Front Axle             | -1- | <b>83456</b> | <b>89447</b> |     | ...          | ...          |
| 90 - 02  | F-4900 Models with Dual Doors                      | -10 | <b>85316</b> | <b>89426</b> |     | ...          | ...          |
| F-4900 Models with Hendrickson HN - 400 Models Rear suspension                     | 60680-003  |     | ...          | ...          | 01- | <b>83112</b> | ...          |
|  | 60680-003L   |     | ...          | ...          | 01- | <b>83112</b> | ...          |

**Series 405**

|                           |           |     |              |              |  |     |     |
|---------------------------|-----------|-----|--------------|--------------|--|-----|-----|
| Models with O.E.M. Number | 293009C91 | 010 | <b>85308</b> | <b>89422</b> |  | ... | ... |
|                           | 426744R91 | 010 | <b>85303</b> | <b>89422</b> |  | ... | ... |
|                           | 453576C91 | 010 | <b>85303</b> | <b>89422</b> |  | ... | ... |
|                           | 453577C91 | 010 | <b>85308</b> | <b>89422</b> |  | ... | ... |

**Series 417**

|                    |           |     |              |              |  |     |     |
|--------------------|-----------|-----|--------------|--------------|--|-----|-----|
| DCO-417 & DCOF-417 | 426744R91 | 010 | <b>85303</b> | <b>89422</b> |  | ... | ... |
|                    | 453576C91 | 010 | <b>85303</b> | <b>89422</b> |  | ... | ... |





**Series 5000, 5000i - Severe Service Conventional Truck & Tractor**

|   |            |            |     |     |     |              |              |
|---|------------|------------|-----|-----|-----|--------------|--------------|
| 6 X 4 Models with Neway AD-246-10 Air Suspension and 60" Axle Spacing | Heavy Duty | 2029200C91 | ... | ... | 010 | <b>85030</b> | <b>89440</b> |
|   |            | AMS 600172 | ... | ... | 010 | <b>85030</b> | <b>89440</b> |
|   | Standard   | 2029200C91 | ... | ... | 010 | <b>83126</b> | <b>89430</b> |
|   |            | AMS 600172 | ... | ... | 010 | <b>83126</b> | <b>89430</b> |

**Series 7000 - Short Conventional Medium Truck & Tractor**

|   |            |     |              |              |     |              |              |
|---|------------|-----|--------------|--------------|-----|--------------|--------------|
| 7000 Models School Bus with O.E.M. Number                           | 3609400C1  |     | ...          | ...          | -10 | <b>83317</b> | ...          |
|   | 3609400C2  |     | ...          | ...          | -10 | <b>83317</b> | ...          |
| 7100 Models   | 1663606C91 | -1- | <b>85027</b> | <b>89418</b> |     | ...          | ...          |
|   | 472412C91  | -1- | <b>83456</b> | <b>89447</b> |     | ...          | ...          |
|   | 586724C91  | -1- | <b>83456</b> | <b>89447</b> |     | ...          | ...          |
| 7100 Models with International Air Suspension                       | 1675455C1  |     | ...          | ...          | 010 | <b>85003</b> | <b>89411</b> |
|   | 1690035C1  |     | ...          | ...          | 010 | <b>85003</b> | <b>89411</b> |
|   | 2018987C1  |     | ...          | ...          | 010 | <b>85003</b> | <b>89411</b> |
|   | 2018987C2  |     | ...          | ...          | 010 | <b>85003</b> | <b>89411</b> |
|   | 501553C91  |     | ...          | ...          | 010 | <b>85003</b> | <b>89411</b> |
| 7300, 7400, 7500, 7600 Models w/ IAS Suspension w/ 5.3" Ride Height | 3544766C1  |     | ...          | ...          | 010 | <b>85930</b> | ...          |

**APPLICATION GUIDE - TRUCKS, TRAILERS, AND BUSES**

| Year<br>Año<br>Année | Model<br>Modelo<br>Modèle | OEM # | Front   |   | Rear  |   |
|----------------------|---------------------------|-------|---|---|---|---|
|                      |                           |       |  |  |  |  |
|                      |                           |       | Fleetline   | GasSLX  | Fleetline   | GasSLX  |

**INTERNATIONAL (NAVISTAR)(Cont'd.)**

**Series 8000 - Conventional Heavy Duty Tractor(Cont'd.)**

|                |  |            |            |       |       |     |       |       |       |
|----------------|--|------------|------------|-------|-------|-----|-------|-------|-------|
|                | 8100 Models Car Hauler   | 1664524C1  |            | ...   | ...   | - O | 85935 | ...   |       |
|                |  | 472412C91  | - -        | 83456 | 89447 |     | ...   | ...   |       |
|                | 8100, 8200, 8300 Models  | 3000070C91 | - -        | 83456 | 89447 |     | ...   | ...   |       |
|                |  | 501906C91  |            | ...   | ...   | - O | 83317 | ...   |       |
|                | 8100, 8200, 8300 Models - with Hendrickson HA-460 Air Suspension with 55" & 60" axle spacing and 40000 & 46000 lb capacity | AMS 600102 |            | ...   | ...   | O O | 85005 | 89430 |       |
|                | 8100, 8200, 8300 Models with 12000 - 14000 lb Suspension   | 1664788C2  | - O        | 85316 | 89426 |     | ...   | ...   |       |
|                |  | 2015556C1  | - O        | 85316 | 89426 |     | ...   | ...   |       |
|                | 8100, 8200, 8300 Models with 15000 - 18000 lb Suspension   | 1667520C1  | O O        | 85058 | 89431 |     | ...   | ...   |       |
|                | 8100, 8200, 8300 Models with Hendrickson HA-230 Rear Air Suspension  | AMS 600102 |            | ...   | ...   | O O | 85005 | 89430 |       |
|                | 8100, 8200, 8300 Models with International Air Suspension (Except Lo-Profile and Carhauler)                                | 1675455C1  |            | ...   | ...   | O O | 85003 | 89411 |       |
|                |  | 1690035C1  |            | ...   | ...   | O O | 85003 | 89411 |       |
|                |  | 2018987C1  |            | ...   | ...   | O O | 85003 | 89411 |       |
|                |  | 2018987C2  |            | ...   | ...   | O O | 85003 | 89411 |       |
|                |  | 501553C91  |            | ...   | ...   | O O | 85003 | 89411 |       |
|                | 8100LP, 8200LP & 8300LP Models - 6 X 4 & 4 X 2 Models with International Air Suspension for Lo-Profile and Carhauler       | 1660846C91 |            | ...   | ...   | O O | 83101 | ...   |       |
|                |  | 1660846C92 |            | ...   | ...   | O O | 83101 | ...   |       |
| <b>07 - 08</b> | 8600 Models with Taperleaf Front Spring Suspension   | 3670156C1  | O O        | 85954 | ...   |     | ...   | ...   |       |
|                | Models with Neway AD-246-10 Air Suspension and 60" Axle Spacing  | Heavy Duty | 2029200C91 |       | ...   | ... | O O   | 85030 | 89440 |
|                |  |            | AMS 600172 |       | ...   | ... | O O   | 85030 | 89440 |
|                |  | Standard   | 2029200C91 |       | ...   | ... | O O   | 83126 | 89430 |
|                |  |            | AMS 600172 |       | ...   | ... | O O   | 83126 | 89430 |





**Series 9100, 9100i - Tractor & Straight Truck**

|  |   |            |            |       |       |     |       |       |       |
|--|---|------------|------------|-------|-------|-----|-------|-------|-------|
|  | 6 X 4 Models with International Air Suspension For Lo-Profile         | 1660846C91 |            | ...   | ...   | O O | 83101 | ...   |       |
|  |   | 1660846C92 |            | ...   | ...   | O O | 83101 | ...   |       |
|  | 6 X 4 Models with Neway AD-246-10 Air Suspension and 60" Axle Spacing | Heavy Duty | 2029200C91 |       | ...   | ... | O O   | 85030 | 89440 |
|  |   |            | AMS 600172 |       | ...   | ... | O O   | 85030 | 89440 |
|  |   | Standard   | 2029200C91 |       | ...   | ... | O O   | 83126 | 89430 |
|  |   |            | AMS 600172 |       | ...   | ... | O O   | 83126 | 89430 |
|  | 9100 Models - with Hendrickson HA-460 Models Air Suspension           | AMS 600102 |            | ...   | ...   | O O | 85005 | 89430 |       |
|  | 9100 Models with 12000 - 14000 lb Suspension                          | 1664788C2  | - O        | 85316 | 89426 |     | ...   | ...   |       |
|  |   | 2015556C1  | - O        | 85316 | 89426 |     | ...   | ...   |       |
|  |   | 2032533C1  | - O        | 85316 | 89426 |     | ...   | ...   |       |
|  | Models with International Air Suspension (Except Lo-Profile)          | 2018987C1  |            | ...   | ...   | O O | 85003 | 89411 |       |
|  |   | 2018987C2  |            | ...   | ...   | O O | 85003 | 89411 |       |

**Series 9200, 9200i - Tractor & Straight Truck**

|  |   |            |            |       |       |     |       |       |       |
|--|---|------------|------------|-------|-------|-----|-------|-------|-------|
|  | 4 X 2 Models with International Air Suspension                        | 2018987C1  |            | ...   | ...   | O O | 85003 | 89411 |       |
|  |   | 2018987C2  |            | ...   | ...   | O O | 85003 | 89411 |       |
|  | 6 X 4 Models with 12,000 to 14,000 lb Front Axles                     | 3581109C3  | O O        | 85924 | 89457 |     | ...   | ...   |       |
|  |   | 3581109C4  | O O        | 85924 | 89457 |     | ...   | ...   |       |
|  | 6 X 4 Models with International Air Suspension                        | 2018987C1  |            | ...   | ...   | O O | 85003 | 89411 |       |
|  |   | 2018987C2  |            | ...   | ...   | O O | 85003 | 89411 |       |
|  | 6 X 4 Models with International Air Suspension For Lo-Profile         | 1660846C91 |            | ...   | ...   | O O | 83101 | ...   |       |
|  |   | 1660846C92 |            | ...   | ...   | O O | 83101 | ...   |       |
|  | 6 X 4 Models with Neway AD-246-10 Air Suspension and 60" Axle Spacing | Heavy Duty | 2029200C91 |       | ...   | ... | O O   | 85030 | 89440 |
|  |   |            | AMS 600172 |       | ...   | ... | O O   | 85030 | 89440 |
|  |   | Standard   | 2029200C91 |       | ...   | ... | O O   | 83126 | 89430 |

**APPLICATION GUIDE - TRUCKS, TRAILERS, AND BUSES**

| Year<br>Año<br>Année | Model<br>Modelo<br>Modèle | OEM # | Front   |   | Rear  |  |
|----------------------|---------------------------|-------|---|---|---|--|
|                      |                           |       |  Fleetline |  GasSLX |  Fleetline |  GasSLX |

**INTERNATIONAL (NAVISTAR)(Cont'd.)**





**Series 9200, 9200i - Tractor & Straight Truck(Cont'd.)**

|                |   |            |     |              |              |     |              |              |
|----------------|---|------------|-----|--------------|--------------|-----|--------------|--------------|
|                | Heavy Duty  | AMS 600172 |     | ...          | ...          | 010 | <b>83126</b> | <b>89430</b> |
|                | Models with 12,000 - 18,000 lb Suspension               | 1664788C2  | -10 | <b>85316</b> | <b>89426</b> |     | ...          | ...          |
|                |   | 2015556C1  | -10 | <b>85316</b> | <b>89426</b> |     | ...          | ...          |
|                |   | 2032533C1  | -10 | <b>85316</b> | <b>89426</b> |     | ...          | ...          |
| <b>00 - 09</b> | Models with 12,000 lb Front Axle                        | 3581107C1  | 010 | <b>85924</b> | <b>89457</b> |     | ...          | ...          |
|                |   | 3581107C2  | 010 | <b>85924</b> | <b>89457</b> |     | ...          | ...          |
|                |   | 3581107C3  | 010 | <b>85924</b> | <b>89457</b> |     | ...          | ...          |
|                |   | 3584535C3  | 010 | <b>85924</b> | <b>89457</b> |     | ...          | ...          |
|                |   | 6127705C1  | 010 | <b>85924</b> | <b>89457</b> |     | ...          | ...          |
| <b>04 - 09</b> | Models with 40,000 lb Rear Air Suspension               | 3586883C1  |     | ...          | ...          | 010 | <b>85931</b> | <b>89458</b> |
|                | Models with Day Cab & Hendrickson AirTek Suspension     | 3613984C1  | 010 | <b>85955</b> | ...          |     | ...          | ...          |
|                |   | 3660549C1  | 010 | <b>85955</b> | ...          |     | ...          | ...          |
|                |   | 65992-002  | 010 | <b>85955</b> | ...          |     | ...          | ...          |
|                |   | 65992-002L | 010 | <b>85955</b> | ...          |     | ...          | ...          |
|                | Models with Hendrickson HA-460 Models Air Suspension    | AMS 600102 |     | ...          | ...          | 010 | <b>85005</b> | <b>89430</b> |
|                | Models with IAS Suspension w/ 9.25" or 9.5" Ride Height | 3573265C1  |     | ...          | ...          | 010 | <b>85931</b> | <b>89458</b> |
|                | Models with International Air Suspension                | 1675455C1  |     | ...          | ...          | 010 | <b>85003</b> | <b>89411</b> |
|                |   | 1690035C1  |     | ...          | ...          | 010 | <b>85003</b> | <b>89411</b> |
|                |   | 501553C91  |     | ...          | ...          | 010 | <b>85003</b> | <b>89411</b> |
|                | Models with Sleeper Cab & Hendrickson AirTek Suspension | 3609178C1  | 010 | <b>85955</b> | ...          |     | ...          | ...          |
|                |   | 3660548C1  | 010 | <b>85955</b> | ...          |     | ...          | ...          |
|                |   | 65992-001  | 010 | <b>85955</b> | ...          |     | ...          | ...          |

**Series 9300, 9300i, 9400 & 9400i Long Hood Conventional Truck & Tractor**

|                |   |            |     |              |              |     |              |              |
|----------------|---|------------|-----|--------------|--------------|-----|--------------|--------------|
|                | 6 X 4 Models with International Air Suspension Exc. Lo-Profile        | 2018987C1  |     | ...          | ...          | 010 | <b>85003</b> | <b>89411</b> |
|                |   | 2018987C2  |     | ...          | ...          | 010 | <b>85003</b> | <b>89411</b> |
|                | 6 X 4 Models with International Air Suspension For Lo-Profile         | 1660846C91 |     | ...          | ...          | 010 | <b>83101</b> | ...          |
|                |   | 1660846C92 |     | ...          | ...          | 010 | <b>83101</b> | ...          |
|                | 6 X 4 Models with Neway AD-246-10 Air Suspension and 60" Axle Spacing |            |     |              |              |     |              |              |
|                | Heavy Duty  | 2029200C91 |     | ...          | ...          | 010 | <b>85030</b> | <b>89440</b> |
|                |   | AMS 600172 |     | ...          | ...          | 010 | <b>85030</b> | <b>89440</b> |
|                | Standard  | 2029200C91 |     | ...          | ...          | 010 | <b>83126</b> | <b>89430</b> |
|                |   | AMS 600172 |     | ...          | ...          | 010 | <b>83126</b> | <b>89430</b> |
|                | Models with 10,800 lb Suspension                                      | 503610C2   | 010 | <b>83207</b> | <b>89407</b> |     | ...          | ...          |
|                | Models with 12,000 - 14,000 lb Suspension                             | 1664788C2  | -10 | <b>85316</b> | <b>89426</b> |     | ...          | ...          |
|                |   | 2015556C1  | -10 | <b>85316</b> | <b>89426</b> |     | ...          | ...          |
|                |   | 2032533C1  | -10 | <b>85316</b> | <b>89426</b> |     | ...          | ...          |
| <b>00 - 09</b> | Models with 12,000 lb Front Axle                                      | 3581107C1  | 010 | <b>85924</b> | <b>89457</b> |     | ...          | ...          |
|                |   | 3581107C2  | 010 | <b>85924</b> | <b>89457</b> |     | ...          | ...          |
|                |   | 3581107C3  | 010 | <b>85924</b> | <b>89457</b> |     | ...          | ...          |
|                |   | 3584535C3  | 010 | <b>85924</b> | <b>89457</b> |     | ...          | ...          |
|                | Models with 16,000 - 18,000 lb Suspension                             | 1667520C1  | 010 | <b>85058</b> | <b>89431</b> |     | ...          | ...          |
| <b>04 - 09</b> | Models with 40,000 lb Rear Air Suspension                             | 3586883C1  |     | ...          | ...          | 010 | <b>85931</b> | <b>89458</b> |
|                | Models with Day Cab & Hendrickson AirTek Suspension                   | 3613984C1  | 010 | <b>85955</b> | ...          |     | ...          | ...          |
|                |   | 3660549C1  | 010 | <b>85955</b> | ...          |     | ...          | ...          |
|                |   | 65992-002  | 010 | <b>85955</b> | ...          |     | ...          | ...          |
|                |   | 65992-002L | 010 | <b>85955</b> | ...          |     | ...          | ...          |
|                | Models with Hendrickson HA-460 Models Air Suspension                  | AMS 600102 |     | ...          | ...          | 010 | <b>85005</b> | <b>89430</b> |
|                | Models with IAS Suspension w/ 9.25" or 9.5" Ride Height               | 3573265C1  |     | ...          | ...          | 010 | <b>85931</b> | <b>89458</b> |
|                | Models with International Air Suspension                              | 1675455C1  |     | ...          | ...          | 010 | <b>85003</b> | <b>89411</b> |
|                |   | 1690035C1  |     | ...          | ...          | 010 | <b>85003</b> | <b>89411</b> |
|                |   | 501553C91  |     | ...          | ...          | 010 | <b>85003</b> | <b>89411</b> |
|                | Models with Neway ARD-125/244 Air Suspension                          | 790335C91  |     | ...          | ...          | 010 | <b>83209</b> | <b>89414</b> |
|                | Models with O.E.M Number  | 3571713C1  | -10 | <b>85333</b> | ...          |     | ...          | ...          |
|                | Models with Sleeper Cab & Hendrickson AirTek Suspension               | 3609178C1  | 010 | <b>85955</b> | ...          |     | ...          | ...          |

**APPLICATION GUIDE - TRUCKS, TRAILERS, AND BUSES**

| Year<br>Año<br>Année | Model<br>Modelo<br>Modèle | OEM # | Front   |   | Rear  |   |
|----------------------|---------------------------|-------|---|---|---|---|
|                      |                           |       |  |  |  |  |
|                      |                           |       |   | Fleetline   | GasSLX  | Fleetline   |

**INTERNATIONAL (NAVISTAR)(Cont'd.)**

**Series 9300, 9300i, 9400 & 9400i Long Hood Conventional Truck & Tractor(Cont'd.)**

|   |           |     |              |              |  |     |     |
|---|-----------|-----|--------------|--------------|--|-----|-----|
| Models with Sleeper Cab & Hendrickson AirTek Suspension         | 3660548C1 | 010 | <b>85955</b> | ...          |  | ... | ... |
|   | 65992-001 | 010 | <b>85955</b> | ...          |  | ... | ... |
| Set Back Axle Models with 16,000 lb to 18,000 lb Suspension     | 1664149C1 | 010 | <b>85029</b> | ...          |  | ... | ... |
| Set Foreward Axle Models with 16,000 lb to 18,000 lb Suspension | 507202C1  | 010 | <b>85030</b> | <b>89440</b> |  | ... | ... |

**Series 9600 & 9700 Premium Cabover Tractor**

|  |            |     |              |              |     |              |              |
|--|------------|-----|--------------|--------------|-----|--------------|--------------|
| 9600, 9700 Models  | 507202C1   | 010 | <b>85030</b> | <b>89440</b> |     | ...          | ...          |
| 9600, 9700 Models Except Low Profile   | 1664788C2  | -10 | <b>85316</b> | <b>89426</b> |     | ...          | ...          |
|  | 2015556C1  | -10 | <b>85316</b> | <b>89426</b> |     | ...          | ...          |
| 9600, 9700 Models for Low Profile  | 503610C2   | 010 | <b>83207</b> | <b>89407</b> |     | ...          | ...          |
| 9600, 9700 Models with 16000 - 18000 lb Suspension   | 1667520C1  | 010 | <b>85058</b> | <b>89431</b> |     | ...          | ...          |
| 9600, 9700 Models with Hendrickson HA-460 Air Suspension with 55" or 60" axle spacing and 40000 or 46000 lb capacity | AMS 600102 |     | ...          | ...          | 010 | <b>85005</b> | <b>89430</b> |
| 9600, 9700 Models with International STL Spring Suspension   | 503550C1   |     | ...          | ...          | 010 | <b>83207</b> | <b>89407</b> |
| 9600, 9700 Models with Neway ARD-125/244 Air Suspension  | 790335C91  |     | ...          | ...          | 010 | <b>83209</b> | <b>89414</b> |
| 9600, 9700 Models with Neway ARD-234 Air Suspension  | 537524C91  |     | ...          | ...          | 010 | <b>83123</b> | <b>89405</b> |
| Models with International Air Suspension   | 1675455C1  |     | ...          | ...          | 010 | <b>85003</b> | <b>89411</b> |
|  | 1690035C1  |     | ...          | ...          | 010 | <b>85003</b> | <b>89411</b> |
|  | 2018987C1  |     | ...          | ...          | 010 | <b>85003</b> | <b>89411</b> |
|  | 2018987C2  |     | ...          | ...          | 010 | <b>85003</b> | <b>89411</b> |
|  | 501553C91  |     | ...          | ...          | 010 | <b>85003</b> | <b>89411</b> |

**Series 9800 - Premium Cabover Tractor**





|  |            |     |              |              |     |              |              |
|--|------------|-----|--------------|--------------|-----|--------------|--------------|
| 6 X 4 Models with International Air Suspension   | 2018987C1  |     | ...          | ...          | 010 | <b>85003</b> | <b>89411</b> |
|  | 2018987C2  |     | ...          | ...          | 010 | <b>85003</b> | <b>89411</b> |
| 6 X 4 Models with Neway AD-246-10 Air Suspension and 60" Axle Spacing<br>Heavy Duty                            | 2029200C91 |     | ...          | ...          | 010 | <b>85030</b> | <b>89440</b> |
|  | AMS 600172 |     | ...          | ...          | 010 | <b>85030</b> | <b>89440</b> |
|  | 2029200C91 |     | ...          | ...          | 010 | <b>83126</b> | <b>89430</b> |
|  | AMS 600172 |     | ...          | ...          | 010 | <b>83126</b> | <b>89430</b> |
| 9800 Models - with Hendrickson HA-460 Air Suspension with 55" & 60" axle spacing and 40000 & 46000 lb capacity | AMS 600102 |     | ...          | ...          | 010 | <b>85005</b> | <b>89430</b> |
| 9800 Models - with Hendrickson HAS-402-60 Air Suspension   | AMS 650420 |     | ...          | ...          | 010 | <b>85013</b> | <b>89414</b> |
| 9800 Models - with Set Back axle   | 2015556C1  | -10 | <b>85316</b> | <b>89426</b> |     | ...          | ...          |
| 9800 Models - with Set Forward axle  | 503610C2   | 010 | <b>83207</b> | <b>89407</b> |     | ...          | ...          |

**Series 9900, 9900i, 9900ix Long Hood Conventional Truck**

|   |            |     |              |              |     |              |              |
|---|------------|-----|--------------|--------------|-----|--------------|--------------|
| 6 X 4 Models with International Air Suspension Exc. Lo-Profile                      | 2018987C1  |     | ...          | ...          | 010 | <b>85003</b> | <b>89411</b> |
|   | 2018987C2  |     | ...          | ...          | 010 | <b>85003</b> | <b>89411</b> |
| 6 X 4 Models with International Air Suspension For Lo-Profile                       | 1660846C91 |     | ...          | ...          | 010 | <b>83101</b> | ...          |
|   | 1660846C92 |     | ...          | ...          | 010 | <b>83101</b> | ...          |
| 6 X 4 Models with Neway AD-246-10 Air Suspension and 60" Axle Spacing<br>Heavy Duty | 2029200C91 |     | ...          | ...          | 010 | <b>85030</b> | <b>89440</b> |
|   | AMS 600172 |     | ...          | ...          | 010 | <b>85030</b> | <b>89440</b> |
|   | 2029200C91 |     | ...          | ...          | 010 | <b>83126</b> | <b>89430</b> |
|   | AMS 600172 |     | ...          | ...          | 010 | <b>83126</b> | <b>89430</b> |
| - 2011<br>Day Cab Models with 12,000 lb Front Axles                                 | 3581106C1  | 010 | <b>85924</b> | <b>89457</b> |     | ...          | ...          |
|   | 3581106C2  | 010 | <b>85924</b> | <b>89457</b> |     | ...          | ...          |
|   | 3581106C3  | 010 | <b>85924</b> | <b>89457</b> |     | ...          | ...          |
| Models with 10,800 lb - 14,600 lb Suspension  | 503610C2   | 010 | <b>83207</b> | <b>89407</b> |     | ...          | ...          |
| Models with 12,000 - 14,000 lb Suspension   | 1664788C2  | -10 | <b>85316</b> | <b>89426</b> |     | ...          | ...          |
|   | 2015556C1  | -10 | <b>85316</b> | <b>89426</b> |     | ...          | ...          |
|   | 2032533C1  | -10 | <b>85316</b> | <b>89426</b> |     | ...          | ...          |
| 04 - 09<br>Models with 12,000 lb Front axle   | 3584535C3  | 010 | <b>85924</b> | <b>89457</b> |     | ...          | ...          |
| 2013 -<br>Models with 12,000 lb Front axle  | 3810581C3  | 010 | <b>85995</b> | ...          |     | ...          | ...          |
|   | 3810581C4  | 010 | <b>85995</b> | ...          |     | ...          | ...          |



**APPLICATION GUIDE - TRUCKS, TRAILERS, AND BUSES**

| Year<br>Año<br>Année | Model<br>Modelo<br>Modèle | OEM # | Front   |   | Rear  |  |
|----------------------|---------------------------|-------|---|---|---|--|
|                      |                           |       |  Fleetline |  GasSLX |  Fleetline |  GasSLX |

**INTERNATIONAL (NAVISTAR)(Cont'd.)**

**Series 9900, 9900i, 9900ix Long Hood Conventional Truck(Cont'd.)**

|                |  |  |           |              |              |              |              |              |     |
|----------------|--|--|-----------|--------------|--------------|--------------|--------------|--------------|-----|
|                | Models with 16,000 - 18,000 lb Suspension  | 1667520C1  | 010       | <b>85058</b> | <b>89431</b> |              | ...          | ...          |     |
| <b>04 - 11</b> | Models with 40,000 lb Rear Air Suspension  | 3586883C1  |           | ...          | ...          | 010          | <b>85931</b> | <b>89458</b> |     |
| <b>02 - 17</b> | Models with Hendrickson HAS - 230 or 460 Rear Air Suspension                           | 3514952C1  |           | ...          | ...          | 010          | <b>85976</b> | ...          |     |
|                |  | 57905-001  |           | ...          | ...          | 010          | <b>85976</b> | ...          |     |
|                |  | 60675-003  |           | ...          | ...          | 010          | <b>85976</b> | ...          |     |
|                |  | 60675-003L   |           | ...          | ...          | 010          | <b>85976</b> | ...          |     |
|                |  | H60675-003   |           | ...          | ...          | 010          | <b>85976</b> | ...          |     |
| <b>- 2016</b>  | Models with International 40,000 lb Rear Air Suspension (52" Spacing- Heavy Duty Rear) | 3688616C1  |           | ...          | ...          | 010          | <b>85923</b> | <b>89458</b> |     |
|                |  | 1675455C1  |           | ...          | ...          | 010          | <b>85003</b> | <b>89411</b> |     |
|                |  | 1690035C1  |           | ...          | ...          | 010          | <b>85003</b> | <b>89411</b> |     |
|                | Models with International Air Suspension   | 501553C91  |           | ...          | ...          | 010          | <b>85003</b> | <b>89411</b> |     |
|                | Models with Neway ARD-125/244 Air Suspension   | 790335C91  |           | ...          | ...          | 010          | <b>83209</b> | <b>89414</b> |     |
|                | Models with O.E.M Number   | 3571713C1  | -10       | <b>85333</b> | ...          |              | ...          | ...          |     |
| <b>14 - 16</b> | Models with Sleeper Cab and 14,000 to 16,000 lb Taperleaf Front Spring Suspension      | 3977759C2  | 010       | <b>85639</b> | ...          |              | ...          | ...          |     |
|                |  | Set Back Axle Models with 16,000 lb to 18,000 lb Suspension    | 1664149C1 | 010          | <b>85029</b> | ...          |              | ...          | ... |
|                |  | Set Forward Axle Models with 16,000 lb to 18,000 lb Suspension | 507202C1  | 010          | <b>85030</b> | <b>89440</b> |              | ...          | ... |

**TerraStar**

|                |  |           |     |              |     |     |              |              |
|----------------|--|-----------|-----|--------------|-----|-----|--------------|--------------|
| <b>2014</b>    | 4 WD Models with Rear Spring Suspension                          | 3945165C1 |     | ...          | ... | 010 | <b>83180</b> | ...          |
|                |  | 6127096C1 |     | ...          | ... | 010 | <b>83180</b> | ...          |
| <b>12 - 15</b> | Models with 10,000 & 13,500 lb Vari-Rate Rear Spring Suspension  | 3586902C2 |     | ...          | ... | 010 | <b>83146</b> | ...          |
| <b>12 - 17</b> | Models with 10,500 or 13,500 lb Vari-Rate Rear Spring Suspension | 3586902C3 |     | ...          | ... | 010 | <b>83364</b> | ...          |
|                |  | 6127087C1 |     | ...          | ... | 010 | <b>83364</b> | ...          |
| <b>13 - 14</b> | Models with 6,000 to 7,000 lb Front Axle                         | 3902993C3 | 010 | <b>83135</b> | ... |     | ...          | ...          |
|                |  | 3991991C1 | 010 | <b>83135</b> | ... |     | ...          | ...          |
|                |  | OE 18513  | 010 | <b>83135</b> | ... |     | ...          | ...          |
| <b>2012</b>    | Models with 6,000 to 7,000 lb Front Axle                         | 3902993C1 | 010 | <b>83167</b> | ... |     | ...          | ...          |
|                |  | OE17103   | 010 | <b>83167</b> | ... |     | ...          | ...          |
|                | Models with International IROS Air Suspension                    | 3892445C3 |     | ...          | ... | 010 | <b>85931</b> | <b>89458</b> |

**TranStar - 8500, 8600 Series**

|                |  |           |     |              |     |     |              |              |
|----------------|--|-----------|-----|--------------|-----|-----|--------------|--------------|
| <b>03 - 15</b> | Models with 10,000 to 14,000 lb Front axle | 3533357C1 | 010 | <b>85957</b> | ... |     | ...          | ...          |
|                |  | 3533357C2 | 010 | <b>85957</b> | ... |     | ...          | ...          |
|                |  | 3588209C1 | 010 | <b>85957</b> | ... |     | ...          | ...          |
|                |  | 3588209C2 | 010 | <b>85957</b> | ... |     | ...          | ...          |
| <b>03 - 18</b> | Models with 40,000 lb Rear Air Suspension  | 3549099C1 |     | ...          | ... | 010 | <b>85923</b> | <b>89458</b> |
|                |  | 3549099C2 |     | ...          | ... | 010 | <b>85923</b> | <b>89458</b> |
|                |  | 3549099C3 |     | ...          | ... | 010 | <b>85923</b> | <b>89458</b> |
|                | Models with O.E.M. Number                  | 6127690C1 |     | ...          | ... | 010 | <b>85923</b> | <b>89458</b> |
| <b>- 2013</b>  | Models with O.E.M. Number                  | 3674348C1 | 010 | <b>85954</b> | ... |     | ...          | ...          |
| <b>14 - 17</b> | Models with O.E.M. Number                  | 6127086C1 | 010 | <b>85637</b> | ... |     | ...          | ...          |

**Transtar - Conventional**

|  |  |           |     |              |              |     |              |              |
|--|--|-----------|-----|--------------|--------------|-----|--------------|--------------|
|  | 4170, F-4170, 4200, F-4200, 4300 & F-4300 Models                   | 426744R91 | 010 | <b>85303</b> | <b>89422</b> |     | ...          | ...          |
|  |  | 426744R92 | 010 | <b>85303</b> | <b>89422</b> |     | ...          | ...          |
|  |  | 453576C91 | 010 | <b>85303</b> | <b>89422</b> |     | ...          | ...          |
|  |  | 453576C92 | 010 | <b>85303</b> | <b>89422</b> |     | ...          | ...          |
|  |  | 477132C1  | 010 | <b>85303</b> | <b>89422</b> |     | ...          | ...          |
|  | 4170, F-4170, 4200, F-4200, 4300 & F-4300 with Air Ride Suspension | 350425C1  |     | ...          | ...          | 010 | <b>85300</b> | <b>89419</b> |
|  |  | 462557C91 |     | ...          | ...          | 010 | <b>85300</b> | <b>89419</b> |
|  | D-400, DF-400, DC-400, DCF-400 & DCF-400M - Exc. Axle Code 02136   | 426744R91 | 010 | <b>85303</b> | <b>89422</b> |     | ...          | ...          |
|  |  | 426744R92 | 010 | <b>85303</b> | <b>89422</b> |     | ...          | ...          |

## APPLICATION GUIDE - TRUCKS, TRAILERS, AND BUSES

| Year<br>Año<br>Année | Model<br>Modelo<br>Modèle | OEM # | Front     |        | Rear      |        |
|----------------------|---------------------------|-------|-----------|--------|-----------|--------|
|                      |                           |       |           |        |           |        |
|                      |                           |       | Fleetline | GasSLX | Fleetline | GasSLX |

### INTERNATIONAL (NAVISTAR)(Cont'd.)

#### Transtar - Conventional(Cont'd.)

|  |  |           |     |       |       |     |     |
|--|--|-----------|-----|-------|-------|-----|-----|
|  | D-400, DF-400, DC-400, DCF-400 & DCF-400M - Exc. Axle Code 02136 | 453576C91 | OIO | 85303 | 89422 | ... | ... |
|  | D-400, DF-400, DC-400, DCF-400 & DCF-400M with Axle Code 02136   | 293009C91 | OIO | 85308 | 89422 | ... | ... |
|  |  | 453577C91 | OIO | 85308 | 89422 | ... | ... |





#### Unistar

|  |                                |             |     |       |     |     |       |       |
|--|--------------------------------|-------------|-----|-------|-----|-----|-------|-------|
|  | CO7044A                        | 426744R91   |     | 85303 | ... | OIO | 85303 | 89422 |
|  |                                | 426744R92   |     | 85303 | ... | OIO | 85303 | 89422 |
|  |                                | 453576C91   |     | 85303 | ... | OIO | 85303 | 89422 |
|  | Additional O.E.M. Interchanges | 56101 Z5008 | -IO | 83114 |     |     |       |       |
|  |                                | 596329C1    | OIO | 85014 |     |     |       |       |

#### WorkStar - 7000 Series

|         |  |            |     |                |       |     |       |
|---------|--|------------|-----|----------------|-------|-----|-------|
|         | 7300, 7400, 7500, 7600 Models with 16,000 lb to 20,000 lb Multi-leaf Spring<br>Severe Duty<br>Standard | 3541456C1  | OIO | 85929          | ...   | ... | ...   |
|         |  | 3558089C1  | OIO | 85925          | ...   | ... | ...   |
|         |  | 3558089C2  | OIO | 85925          | ...   | ... | ...   |
|         |  | 3558089C3  | OIO | 85925          | ...   | ... | ...   |
| - 2019  | 7400 Models with O.E.M. Number   | 3885832C1  | OIO | 83135          | ...   | ... | ...   |
|         |  | 3885832C2  | OIO | 83135          | ...   | ... | ...   |
| 04 - 15 | 7400, 7500, 7600 Models with 12,000 lb Front axle  | 3533357C1  | OIO | 85957          | ...   | ... | ...   |
|         |  | 3533357C2  | OIO | 85957          | ...   | ... | ...   |
|         |  | 3533357C3  | OIO | 85957          | ...   | ... | ...   |
| 16 - 18 | 7400, 7500, 7600 Models with 12,000 lb Front axle  | 6127714C1  | OIO | 85928          | ...   | ... | ...   |
| - 2018  | 7400, 7500, 7600 Models with 18,000 lb Front Axles   | 3576464C1  | OIO | 85957          | ...   | ... | ...   |
|         |  | 3576464C2  | OIO | 85957          | ...   | ... | ...   |
|         | 7400, 7500, 7600 Models with Hendrickson HAS - 400 (Standard Inboard Rear)                             | 60670-007  |     | ...            | ...   | OIO | 83144 |
|         |  | 60670-007L |     | ...            | ...   | OIO | 83144 |
|         | Models with 10,000 to 16,000 lb Front Suspension   | 3576465C2  | OIO | 85999          | ...   | ... | ...   |
|         |  | 3816234C1  | OIO | 85999          | ...   | ... | ...   |
| 10 - 13 | Models with 12,000 to 14,000 lb Front Taperleaf Suspension   | 3868264C1  | OIO | 85998          | ...   | ... | ...   |
|         | Models with 18,000 to 20,000 lb Front Axle   | 3868265C1  | OIO | 85998          | ...   | ... | ...   |
| - 2018  | Models with 40,000 lb Rear Air Suspension  | 3549099C3  |     | ...            | ...   | OIO | 85923 |
|         |  |            |     | ...            | ...   | OIO | 89458 |
| 02 - 17 | Models with Hendrickson HAS - 230 or 460 Rear Air Suspension   | 3514952C1  |     | ...            | ...   | OIO | 85976 |
|         |  | 57905-001  |     | ...            | ...   | OIO | 85976 |
|         |  | 60675-003  |     | ...            | ...   | OIO | 85976 |
|         |  | 60675-003L |     | ...            | ...   | OIO | 85976 |
|         |  | H60675-003 |     | ...            | ...   | OIO | 85976 |
| - 2014  | Models with Hendrickson HMX 400/460 Haulmax with 16.5" Saddle  | 60680-004  |     | ...            | ...   | OIO | 83143 |
|         |  | 60680-004L |     | ...            | ...   | OIO | 83143 |
| - 2018  | Models with Hendrickson Primaax 230, 460 and 690 Air Suspension (8-1/2" to 10" Ride Height)            | 60657-003  |     | ...            | ...   | OIO | 85072 |
|         |  | 60657-003L |     | ...            | ...   | OIO | 85072 |
| - 2018  | Models with Hendrickson Primaax EX 232, 462 and 692 Air Suspension (8-1/2" to 10" Ride Height)         | 60657-003  |     | ...            | ...   | OIO | 85072 |
|         |  | 60657-003L |     | ...            | ...   | OIO | 85072 |
|         | Models with O.E.M. Number  | 4070336C1  | OIO | 85058          | 89431 | ... | ...   |
|         |  | 6127690C1  |     | ...            | ...   | OIO | 85923 |
|         |  |            |     | ...            | ...   | OIO | 89458 |
|         | S7700 Models w/ Multistage Front Suspension  | 3588591C1  | OIO | 85953          | ...   | ... | ...   |
|         |  | 3588591C2  | OIO | 85953          | ...   | ... | ...   |
|         |  | 3588592C1  | OIO | 85953          | ...   | ... | ...   |
|         |  | 3588592C2  | OIO | 85953          | ...   | ... | ...   |
|         | Additional O.E.M. Interchanges   | 453527C91  | -IO | 85311 or 89424 |       |     |       |
|         |  | 453528C91  | -IO | 85311 or 89424 |       |     |       |

**APPLICATION GUIDE - TRUCKS, TRAILERS, AND BUSES**

| Year<br>Año<br>Année | Model<br>Modelo<br>Modèle | OEM # | Front   |  | Rear  |   |
|----------------------|---------------------------|-------|---|--|---|---|
|                      |                           |       |  |  |  |  |
|                      |                           |       | Fleetline   | GasSLX   | Fleetline   | GasSLX  |

**INTERNATIONAL (NAVISTAR)(Cont'd.)**

|                                |           |     |                       |  |
|--------------------------------|-----------|-----|-----------------------|--|
| Additional O.E.M. Interchanges | 462603C91 | - - | <b>85705 or 89447</b> |  |
|                                | 463926C91 | - - | <b>85705 or 89447</b> |  |





**Additional O.E.M. Interchanges**

|  |               |     |              |              |                       |                       |              |
|--|---------------|-----|--------------|--------------|-----------------------|-----------------------|--------------|
| Models with Chalmers 40,000 lb Rear Suspension | 800670        |     | ...          | ...          | 0 0                   | <b>85060</b>          | ...          |
| Models with Meritor AirLink Suspension         | 446-51-211    |     | ...          | ...          | 0 0                   | <b>85739</b>          | ...          |
| Models with O.E.M. Number                      | 3000098C1     |     | ...          | ...          | - 0                   | <b>83317</b>          | ...          |
|  | 3571711C1     | - 0 | <b>85316</b> | <b>89426</b> |                       | ...                   | ...          |
|  | 3581109C1     | 0 0 | <b>85924</b> | <b>89457</b> |                       | ...                   | ...          |
|  | 3584116C1     | 0 0 | <b>83175</b> | ...          |                       | ...                   | ...          |
|  | 3584116C2     | 0 0 | <b>83175</b> | ...          |                       | ...                   | ...          |
|  | 3584117C1     | 0 0 | <b>83135</b> | ...          |                       | ...                   | ...          |
|  | 3584117C2     | 0 0 | <b>83135</b> | ...          |                       | ...                   | ...          |
|  | 3584118C1     | 0 0 | <b>85928</b> | ...          |                       | ...                   | ...          |
|  | 3584118C2     | 0 0 | <b>85928</b> | ...          |                       | ...                   | ...          |
|  | 3584535C1     | 0 0 | <b>85924</b> | <b>89457</b> |                       | ...                   | ...          |
|  | 3584535C2     | 0 0 | <b>85924</b> | <b>89457</b> |                       | ...                   | ...          |
|  | 3601600C1     | 0 0 | <b>85082</b> |              |                       |                       |              |
|  | 3601600C2     | 0 0 | <b>85082</b> |              |                       |                       |              |
|  | 3601600C3     | 0 0 | <b>85082</b> |              |                       |                       |              |
|  | 47902-24      |     | ...          | ...          | 0 0                   | <b>83137</b>          | ...          |
|  | 4C4Z-18124-N  | 0 0 | <b>85957</b> | ...          |                       | ...                   | ...          |
|  | 4C4Z-18125-DA |     | ...          | ...          | 0 0                   | <b>85926</b>          | ...          |
|  | 503610C1      |     | ...          | ...          | 0 0                   | <b>83207</b>          | <b>89407</b> |
|  | 6ETZ-18125-A  |     | ...          | ...          | 0 0                   | <b>83146</b>          | ...          |
|  | 90044025      |     | ...          | ...          | 0 0                   | <b>83209</b>          | <b>89414</b> |
| Additional O.E.M. Interchanges                 | 3541456C1     | 0 0 |              |              |                       | <b>85929</b>          |              |
|  | 3544768C1     | 0 0 |              |              |                       | <b>85926</b>          |              |
|  | 3549100C1     | 0 0 |              |              |                       | <b>85926</b>          |              |
|  | 3558989C1     | 0 0 |              |              |                       | <b>85925</b>          |              |
|  | 3558989C2     | 0 0 |              |              |                       | <b>85925</b>          |              |
|  | 3596107C1     | 0 0 |              |              |                       | <b>85927</b>          |              |
|  | 3596107C2     | 0 0 |              |              |                       | <b>85927</b>          |              |
|  | 3596107C3     | 0 0 |              |              |                       | <b>85927</b>          |              |
|  | 3596107C4     | 0 0 |              |              |                       | <b>85927</b>          |              |
|  | 70334         | - 0 |              |              |                       | <b>85316 or 89426</b> |              |
|  | AMS650102     | 0 0 |              |              |                       | <b>85001 or 89410</b> |              |
|  | AMS650107     | - 0 |              |              |                       | <b>85316 or 89426</b> |              |
|  | AMS650400     | - 0 |              |              |                       | <b>85033 or 89427</b> |              |
|  | AMS650402     | - 0 |              |              |                       | <b>85311 or 89424</b> |              |
|  | AMS650404     | - - |              |              |                       | <b>85310 or 89423</b> |              |
|  | AMS650405     | 0 0 |              |              |                       | <b>85023 or 89415</b> |              |
|  | AMS650406     | 0 0 |              |              |                       | <b>85024</b>          |              |
| AMS650408                                      | - 0           |     |              |              | <b>85319 or 89428</b> |                       |              |

**INTERNATIONAL (NAVISTAR) CAB SHOCKS**

|                |   |            |     |              |
|----------------|---|------------|-----|--------------|
| <b>1997 -</b>  | Eagle Pro-Sleeper                                       | 1202-0054  | 0 0 | <b>83021</b> |
| <b>09 - 17</b> | LoneStar Models with 72" Hi Roof Sleeper                | 2595314C1  | 0 - | <b>83062</b> |
|                |   | 2600491C91 | 0 - | <b>83062</b> |
| <b>2018</b>    | LT Models With 56" or 72" Hi Roof Sleeper               | 2595314C1  | 0 - | <b>83062</b> |
|                | Models with Link Cab Suspension NPS90                   | 1202-0054  | 0 0 | <b>83021</b> |
|                | Models with Link Cabmate Suspensions with O.E.M. Number | 1201-9003  | 0 0 | <b>83052</b> |
|                |   | 1201-9007  | 0 0 | <b>83054</b> |
|                |   | 1201-9009  | 0 0 | <b>83054</b> |
|                |   | 1201-9013  | 0 - | <b>83062</b> |
|                |   | 1201-9014  | 0 - | <b>83062</b> |

**APPLICATION GUIDE - TRUCKS, TRAILERS, AND BUSES**

| Year<br>Año<br>Année | Model<br>Modelo<br>Modèle | OEM # | Front   |   | Rear  |   |
|----------------------|---------------------------|-------|---|---|---|---|
|                      |                           |       |  |  |  |  |
|                      |                           |       | Fleetline   | GasSLX  | Fleetline   | GasSLX  |

**INTERNATIONAL (NAVISTAR) CAB SHOCKS(Cont'd.)**

|           |   |   |   |  |
|-----------|---|---|---|--|
|           | Models with Link Cabmate Suspensions with O.E.M. Number                                     | 1201-9018<br>1201-9021<br>1202-0012<br>1202-0032<br>1202-0042<br>1202-0043<br>1202-0044<br>1202-0054<br>1202-1212<br>1202-1213  | 01-<br>01-<br>010<br>010<br>010<br>010<br>010<br>010<br>010<br>01-  | <b>83062</b><br><b>83062</b><br><b>83023</b><br><b>83016</b><br><b>83025</b><br><b>83032</b><br><b>83025</b><br><b>83021</b><br><b>83013</b><br><b>83005</b>   |
|           | Models with O.E.M. Number   | 1201-1212<br>2023685C1<br>2500013C1<br>2507409C1<br>2507761C1<br>2507763C1<br>2507948C1<br>2508326C1<br>2508327C1<br>2590915C1<br>2590916C1<br>2597458C91<br>2601488C91<br>2602021C1<br>3557165C1<br>3557166C1<br>3557167C3<br>3557169C1<br>3557169C2<br>3560649C1<br>3560649C2<br>3560705C2<br>AMS66160<br>AMS66161<br>OE14771 | 010<br>01-<br>010<br>010<br>010<br>010<br>010<br>010<br>010<br>01-<br>01-<br>01-<br>01-<br>01-<br>010<br>010<br>010<br>010<br>010<br>010<br>010<br>010<br>010<br>010<br>010<br>01-<br>01- | <b>83013</b><br><b>83015</b><br><b>83013</b><br><b>83052</b><br><b>83052</b><br><b>83052</b><br><b>83054</b><br><b>83021</b><br><b>83025</b><br><b>83062</b><br><b>83062</b><br><b>83062</b><br><b>83062</b><br><b>83062</b><br><b>83053</b><br><b>83052</b><br><b>83053</b><br><b>83052</b><br><b>83052</b><br><b>83052</b><br><b>83054</b><br><b>83052</b><br><b>83054</b><br><b>83052</b><br><b>83053</b><br><b>83062</b> |
| - 1991    | Navistar 60" Sleepers with Link Cabmate Model IHS60   | 1202-1043   | 010   | <b>83025</b>   |
| 11 - 15   | Pro-Star Models With 56" or 72" Hi Roof Sleeper   | 2593803C91<br>2595314C1   | 01-<br>01-  | <b>83062</b><br><b>83062</b>   |
| 2018 - 19 | RH Models With 56" or 72" Hi Roof Sleeper   | 2595314C1   | 01-   | <b>83062</b>   |
|           | S2500, S2600, 8100, 8200, & 8300 Models Conventional Tractors with Link Cabmate Model NAV80 | 1202-1043   | 010   | <b>83025</b>   |
| - 2017    | TranStar 8600 Models With O.E.M. Number   | 2595314C1   | 01-   | <b>83062</b>   |





**4000 Series**

|        |   |                        |            |                              |
|--------|---|------------------------|------------|------------------------------|
|        | 4600, 4700, 4800, 4900 Models with Link Cab Suspension                    | 1201-1044<br>2012769C2 | 010<br>01- | <b>83025</b><br><b>83005</b> |
|        | Cabover Tractors with 74", 84" or 88" cabs with Link Cabmate Model IHB-2P | 1202-0032              | 010        | <b>83016</b>                 |
|        | Conventional Tractors with Link Cabmate Model IHC43                       | 1201-0012<br>1202-0012 | 010<br>010 | <b>83023</b><br><b>83023</b> |
| - 2017 | DuraStar - 4300, 4400 Models Conventional Tractors with O.E.M. Number     | 2509221C91             | 010        | <b>83054</b>                 |
|        | HPV 4000 Models travel crew cabs with ITC 42 Link Cabmate Model           | 1201-9002              | 010        | <b>83052</b>                 |

**4300 , 4400 Series**

|         |  |            |     |              |
|---------|--|------------|-----|--------------|
| 18 - 19 | DuraStar - 4300, 4400 Models Models with O.E.M. Number | 2509223C91 | 010 | <b>83054</b> |
|---------|--|------------|-----|--------------|

**APPLICATION GUIDE - TRUCKS, TRAILERS, AND BUSES**

| Year<br>Año<br>Année | Model<br>Modelo<br>Modèle | OEM # | Front   |  | Rear  |   |
|----------------------|---------------------------|-------|---|--|---|---|
|                      |                           |       |  |  |  |  |
|                      |                           |       | Fleetline   | GasSLX   | Fleetline   | GasSLX  |

**INTERNATIONAL (NAVISTAR) CAB SHOCKS(Cont'd.)**

**5000 Series(Cont'd.)**

|         |  |           |     |       |
|---------|--|-----------|-----|-------|
| 09/94 - | Paystar - SBA Conventionals with Link Cabmate Model NP50 & NP50-A built after August of 1994 | 1201-1044 | 0 0 | 83025 |
|         |  | 1202-1044 | 0 0 | 83025 |
| 09/96 - | Paystar - SFA Conventionals with Link Cabmate Model NP50 & NP50-A built after August of 1996 | 1201-1044 | 0 0 | 83025 |
|         |  | 1202-1044 | 0 0 | 83025 |

**7000 Series**

|        |   |            |     |       |
|--------|---|------------|-----|-------|
|        | 7300, 7400 & 7500 Models trucks with day cab or extended cabs with Link Cabmate Model IDC734  | 1201-9001  | 0 0 | 83052 |
|        | 7300, 7400 & 7500 Models trucks with day cab or extended cabs with Link Cabmate Model IDC7345 | 1201-9008  | 0 0 | 83054 |
|        | 7300, 7400, 7500 & 7600 Models with Link Cabmate Suspensions with O.E.M. Number               | 1201-1043  | 0 0 | 83025 |
|        |   | 1201-1049  | 0 0 | 83025 |
|        | 7600 Models trucks with day cab or extended cabs with Link Cabmate Model IDC76                | 1201-9010  | 0 0 | 83053 |
| - 2015 | WorkStar - 7000 Models Models with O.E.M. Number  | 2509224C91 | 0 0 | 83053 |
| - 2019 | WorkStar - 7000 Models Models with O.E.M. Number  | 2509223C91 | 0 0 | 83054 |

**8000 Series**

|         |   |            |     |       |
|---------|---|------------|-----|-------|
|         | 8100, 8200, & 8300 Model Trucks with Link Cabmate with O.E.M. Number          | 1201-1213  | 0 - | 83005 |
|         | 8100, 8200, & 8300 Model Trucks with O.E.M. Number                            | 2012768C1  | 0 0 | 83013 |
|         |   | 2012769C1  | 0 - | 83005 |
|         |   | 2025790C1  | 0 0 | 83013 |
|         | 8500 Model trucks with day cab or extended cabs with Link Cabmate Model IDC85 | 1201-9008  | 0 0 | 83054 |
|         | 8600 Model trucks with day cab or extended cabs with Link Cabmate Model IDC86 | 1201-9011  | 0 0 | 83053 |
| - 2013  | TranStar - 8500, 8600 Models Tractors with O.E.M. Number                      | 2509223C91 | 0 0 | 83054 |
| 04 - 09 | TranStar - 8500, 8600 Models Tractors with 36" Sleepers                       | 2509222C91 | 0 0 | 83053 |

**9000 Series**

|         |   |           |     |       |
|---------|---|-----------|-----|-------|
| 01/93-  | 48" & 60" Bentz Sleepers on 9000 Models Conventional Tractors with Link Cabmate Model IHS4860 | 1201-1044 | 0 0 | 83025 |
|         |   | 1202-1044 | 0 0 | 83025 |
| 03/97 - | 9100 & 9200 Models Conventionals with Link Cabmate Model ND92-A                               | 1202-1043 | 0 0 | 83025 |
|         |   | 2023684C1 | 0 - | 83015 |
|         | 9300 & 9400 Conventional Tractors with Link Cabmate Model IHC93-A                             | 1202-1043 | 0 0 | 83025 |
|         |   | 2503529C1 | 0 0 | 83025 |
| 1981 -  | 9670 Cabover Tractors with 89" or 110" cabs with Link Cabmate Models IH967-A or IH97110       | 1202-0032 | 0 0 | 83016 |
| 1982 -  | 9670, 9700 & 9800 Cabovers with 89" & 110" cabs with Link Cabmate Model NAV9876               | 1202-0054 | 0 0 | 83021 |
| 1989 -  | 9700 Cabover Tractors with 110" cabs with Link Cabmate Model IH97110                          | 1202-0032 | 0 0 | 83016 |
| 1989 -  | 9700 Cabover Tractors with 89" cabs with Link Cabmate Model IH9789                            | 1202-0032 | 0 0 | 83016 |
| 04 - 09 | Models With 51" Low-Roof Sleeper  | 1201-0154 | 0 0 | 83051 |
|         |   | 2585145C1 | 0 0 | 83051 |
| 04 - 09 | Models with 72" High-Roof Sleeper   | 1201-0254 | 0 0 | 83051 |
|         |   | 2589922C1 | 0 0 | 83051 |

**MV Series**

|      |                                 |            |     |       |
|------|---------------------------------|------------|-----|-------|
| 2019 | MV607 Models with O.E.M. Number | 2509223C91 | 0 0 | 83054 |
|------|---------------------------------|------------|-----|-------|

**ISUZU**









**EVR Series**

|         |            |               |     |       |     |     |     |
|---------|------------|---------------|-----|-------|-----|-----|-----|
| 87 - 92 | EVR Models | 1-51630-160-0 | - 0 | 83162 | ... | ... | ... |
|---------|------------|---------------|-----|-------|-----|-----|-----|

**FSR Series**

|            |            |               |  |     |     |     |       |     |
|------------|------------|---------------|--|-----|-----|-----|-------|-----|
| 10/89 - 96 | FSR Models | 1-51630-167-0 |  | ... | ... | - - | 83613 | ... |
|------------|------------|---------------|--|-----|-----|-----|-------|-----|

**APPLICATION GUIDE - TRUCKS, TRAILERS, AND BUSES**

| Year<br>Año<br>Année | Model<br>Modelo<br>Modèle | OEM # | Front   |   | Rear  |   |
|----------------------|---------------------------|-------|---|---|---|---|
|                      |                           |       |  |  |  |  |
|                      |                           |       |  |  |  |  |
|                      |                           |       | Fleetline   | GasSLX  | Fleetline   | GasSLX  |

**ISUZU(Cont'd.)**

**FSR Series(Cont'd.)**

|         |   |               |     |       |     |     |       |     |
|---------|---|---------------|-----|-------|-----|-----|-------|-----|
| 86 - 92 | FSR Models  | 1-51630-160-0 | -10 | 83162 | ... |     | ...   | ... |
|         |   | 1-51630-168-1 | -10 | 83515 | ... |     | ...   | ... |
|         |   | 51630168      | -10 | 83515 | ... |     | ...   | ... |
| 86 - 96 | FSR Models  | 1-51630-217-1 | -10 | 83114 | ... |     | ...   | ... |
| 97 - 03 | Models with 11000, 13500, 15000 lb Taperleaf Springs                        | 8-22064231-0  |     | ...   | ... | -1- | 85324 | ... |
| 97 - 03 | Models with 15000, 19000, 21000 lb Multileaf Springs                        | 8-22064232-0  |     | ...   | ... | -1- | 85071 | ... |
| 97 - 03 | Models with 16900 lb Taperleaf Springs                                      | 8-22064489-0  |     | ...   | ... | -1- | 85336 | ... |
| 97 - 03 | Models with 19000, 21000, 23000 lb Taperleaf Springs (EXC Low Profile Veh.) | 8-22064233-0  |     | ...   | ... | -1- | 83136 | ... |
|         |   | 8-22064804-0  | -1- | 83136 | ... |     | ...   | ... |
|         |   | 8-22064805-0  | -1- | 83136 | ... |     | ...   | ... |

**FTR Series**

|         |  |               |     |       |     |     |       |     |
|---------|--|---------------|-----|-------|-----|-----|-------|-----|
| 97 - 03 | FL2 Tilt Cab with 5000 to 11000 lb Axle                                    | 8-22064807-0  | -1- | 83136 | ... |     | ...   | ... |
| 97 - 03 | FL3 Tilt Cab with 14575 lb Axle  | 8-22064806-0  | -1- | 83136 | ... |     | ...   | ... |
| 86 - 96 | FTR Models   | 1-51630-167-0 |     | ...   | ... | -1- | 83613 | ... |
| 05 - 09 | FTR Models with 15000, 19000, 21000 lb Multileaf Springs                   | 15174902      |     | ...   | ... | -1- | 85071 | ... |
|         |  | 88982686      |     | ...   | ... | -1- | 85071 | ... |
| 05 - 09 | FTR Models with O.E.M. Number  | 15123676      | -1- | 83136 | ... |     | ...   | ... |
|         |  | 88982682      | -1- | 83136 | ... |     | ...   | ... |
|         |  | 8-98098-059-0 |     | ...   | ... | 010 | 83159 | ... |
|         |  | 8-98098-059-1 |     | ...   | ... | 010 | 83159 | ... |
|         |  | 8-98098-127-0 | -10 | 83515 | ... |     | ...   | ... |
|         |  | 8982326720    | -10 | 83515 | ... |     | ...   | ... |
|         |  | 8-98316-228-0 |     | ...   | ... | 010 | 83159 | ... |
|         |  | 98098059      |     | ...   | ... | 010 | 83159 | ... |
|         |  | 98098127      | -10 | 83515 | ... |     | ...   | ... |
| 97 - 03 | Tilt Cab w/11000, 13500, 15000 lb Taperleaf Springs                        | 8-22064231-0  |     | ...   | ... | -1- | 85324 | ... |
| 97 - 03 | Tilt Cab w/15000, 19000, 21000 lb Multileaf Springs                        | 8-22064232-0  |     | ...   | ... | -1- | 85071 | ... |
| 97 - 03 | Tilt Cab w/16900 lb Taperleaf Springs                                      | 8-22064489-0  |     | ...   | ... | -1- | 85336 | ... |
| 97 - 03 | Tilt Cab w/19000, 21000, 23000 lb Taperleaf Springs (EXC Low Profile Veh.) | 8-22064233-0  |     | ...   | ... | -1- | 83136 | ... |









**FVR Series**

|         |   |               |     |       |     |     |       |       |
|---------|---|---------------|-----|-------|-----|-----|-------|-------|
| - 2009  | FVR Models with Hendrickson HAS suspension                                      | 12474915      |     | ...   | ... | 010 | 83122 | 89406 |
|         |   | 60670-005     |     | ...   | ... | 010 | 83137 | ...   |
| 00 - 09 | FVR Models with O.E.M. Number   | 15887728      | -1- | 83136 | ... |     | ...   | ...   |
|         |   | 19152843      | -1- | 83136 | ... |     | ...   | ...   |
| 90 - 09 | FVR Models with 15000, 19000, 21000 lb Multileaf Springs                        | 8-22064232-0  |     | ...   | ... | -1- | 85071 | ...   |
|         |   | 88982686      |     | ...   | ... | -1- | 85071 | ...   |
| 97 - 02 | FVR Models with 11000, 13500, 15000 lb Taperleaf Springs                        | 8-22064231-0  |     | ...   | ... | -1- | 85324 | ...   |
| 97 - 02 | FVR Models with 14575 lb Axle   | 8-22064806-0  | -1- | 83136 | ... |     | ...   | ...   |
| 97 - 02 | FVR Models with 16900 lb Taperleaf Springs                                      | 8-22064489-0  |     | ...   | ... | -1- | 85336 | ...   |
| 97 - 02 | FVR Models with 19000, 21000, 23000 lb Taperleaf Springs (EXC Low Profile Veh.) | 8-22064233-0  |     | ...   | ... | -1- | 83136 | ...   |
| 97 - 02 | FVR Models with 5000 to 11000 lb Axle   | 8-22064807-0  | -1- | 83136 | ... |     | ...   | ...   |
| 86 - 96 | FVR Models  | 1-51630-167-0 |     | ...   | ... | -1- | 83613 | ...   |
| 86 - 96 | FVR Short & Middle Chassis  | 1-51630-160-0 | -10 | 83162 | ... |     | ...   | ...   |

**NPR Series**

|         |  |               |     |       |     |  |     |     |
|---------|--|---------------|-----|-------|-----|--|-----|-----|
| 86 - 17 | NPR, NPR-HD Models with 11000 lb & 13000 lb Suspension | 8-94454-987-0 | -10 | 83515 | ... |  | ... | ... |
|         |  | 8-97083-027-0 | -10 | 83515 | ... |  | ... | ... |
|         |  | 8-97083-029-0 | -10 | 83515 | ... |  | ... | ... |
|         |  | 8-97253-620-0 | -10 | 83515 | ... |  | ... | ... |
|         |  | 8-97253-620-1 | -10 | 83515 | ... |  | ... | ... |
|         |  | 8-98098-125-0 | -10 | 83515 | ... |  | ... | ... |
|         |  | 8982326710    | -10 | 83515 | ... |  | ... | ... |
|         |  | 8-98232671-0  | -10 | 83515 | ... |  | ... | ... |

## APPLICATION GUIDE - TRUCKS, TRAILERS, AND BUSES

| Year<br>Año<br>Année | Model<br>Modelo<br>Modèle | OEM # | Front  |   | Rear   |   |
|----------------------|---------------------------|-------|--|---|--|---|
|                      |                           |       |  |  |  |  |
|                      |                           |       |   |  |   |  |
|                      |                           |       | Fleetline  | GasSLX  | Fleetline  | GasSLX  |

### ISUZU(Cont'd.)

#### NPR Series(Cont'd.)









|         |  |   |     |              |     |     |              |              |
|---------|--|---|-----|--------------|-----|-----|--------------|--------------|
| 86 - 17 | NPR, NPR-HD Models with 11000 lb & 13000 lb Suspension | 8-98232671-1<br>94454987<br>97083027<br>97083029<br>97253620<br>98098125<br>98232671  | -10 | <b>83515</b> | ... |     | ...          | ...          |
|         |  |   | -10 | <b>83515</b> | ... |     | ...          | ...          |
|         |  |   | -10 | <b>83515</b> | ... |     | ...          | ...          |
|         |  |   | -10 | <b>83515</b> | ... |     | ...          | ...          |
|         |  |   | -10 | <b>83515</b> | ... |     | ...          | ...          |
|         |  |   | -10 | <b>83515</b> | ... |     | ...          | ...          |
|         |  |   | -10 | <b>83515</b> | ... |     | ...          | ...          |
|         |  |   | -10 | <b>83515</b> | ... |     | ...          | ...          |
| 03 - 17 | NPR, NPR-HD Models with O.E.M Number                   | 8-97253-665-0<br>8-98098-058-0<br>8-98098-058-1<br>898098-0581<br>8-98098-059-0<br>8-98098-059-1<br>8-98316227-0<br>8-98316-228-0<br>97253665<br>98098058<br>98098059<br>98316227 |     | ...          | ... | 010 | <b>83159</b> | ...          |
|         |  |   |     | ...          | ... | 010 | <b>83159</b> | ...          |
|         |  |   |     | ...          | ... | 010 | <b>83159</b> | ...          |
|         |  |   |     | ...          | ... | 010 | <b>83159</b> | ...          |
|         |  |   |     | ...          | ... | 010 | <b>83159</b> | ...          |
|         |  |   |     | ...          | ... | 010 | <b>83159</b> | ...          |
|         |  |   |     | ...          | ... | 010 | <b>83159</b> | ...          |
|         |  |   |     | ...          | ... | 010 | <b>83159</b> | ...          |
|         |  |   |     | ...          | ... | 010 | <b>83159</b> | ...          |
|         |  |   |     | ...          | ... | 010 | <b>83159</b> | ...          |
|         |  |   |     | ...          | ... | 010 | <b>83159</b> | ...          |
| 01 - 07 | NPR, NPR-HD ( Diesel Models)                           | 8-97253-651-2<br>97253651   |     | ...          | ... | 010 | <b>83404</b> | ...          |
|         |  |   |     | ...          | ... | 010 | <b>83404</b> | ...          |
| 03 - 08 | NPR, NPR-HD ( Gas Models)                              | 8-97253-651-2<br>97253651   |     | ...          | ... | 010 | <b>83404</b> | ...          |
|         |  |   |     | ...          | ... | 010 | <b>83404</b> | ...          |
| 95 - 02 | NPR, NPR-HD (Gas & Diesel Models)                      | 8-97253-664-0<br>97253664   |     | ...          | ... | 010 | <b>83159</b> | ...          |
|         |  |   |     | ...          | ... | 010 | <b>83159</b> | ...          |
| 86 - 95 | NPR Models (NPC & NPN)                                 | 51630666<br>8-94454-647-1<br>8-94454-986-0<br>8-94454-987-0<br>8-97083-029-0<br>94454986<br>9-51630-666-0<br>9-51630-666-2<br>97083029  |     | ...          | ... | 010 | <b>85012</b> | <b>89413</b> |
|         |  |   | -10 | <b>83515</b> | ... |     | ...          | ...          |
|         |  |   | -10 | <b>83515</b> | ... |     | ...          | ...          |
|         |  |   | -10 | <b>83515</b> | ... |     | ...          | ...          |
|         |  |   | -10 | <b>83515</b> | ... |     | ...          | ...          |
|         |  |   | -10 | <b>83515</b> | ... |     | ...          | ...          |
|         |  |   | -10 | <b>83515</b> | ... |     | ...          | ...          |
|         |  |   | -10 | <b>83515</b> | ... |     | ...          | ...          |
| 89 - 92 | NPR Models Flatlow                                     | 9-51630-666-0<br>9-51630-666-2  |     | ...          | ... | 010 | <b>85012</b> | <b>89413</b> |
|         |  |   |     | ...          | ... | 010 | <b>85012</b> | <b>89413</b> |
| 89 - 90 | NPR Models Flatlow                                     | 51630647<br>9-51630-647-1   | -10 | <b>83515</b> | ... |     | ...          | ...          |
|         |  |   | -10 | <b>83515</b> | ... |     | ...          | ...          |

#### NQR Series

|         |                               |  |     |              |     |     |              |     |
|---------|-------------------------------|--|-----|--------------|-----|-----|--------------|-----|
| 03 - 17 | NQR Models with O.E.M. Number | 8-97253-620-0<br>8-97253-665-0<br>8-98098-059-0<br>8-98098-059-1<br>8-98098-127-0<br>8982326720<br>8-98232672-0<br>8-98232672-1<br>8-98316-228-0<br>8-98343986-0<br>97253620<br>97253665<br>98098059<br>98098127<br>98232672 | -10 | <b>83515</b> | ... |     | ...          | ... |
|         |                               |  |     | ...          | ... | 010 | <b>83159</b> | ... |
|         |                               |  |     | ...          | ... | 010 | <b>83159</b> | ... |
|         |                               |  |     | ...          | ... | 010 | <b>83159</b> | ... |
|         |                               |  | -10 | <b>83515</b> | ... |     | ...          | ... |
|         |                               |  | -10 | <b>83515</b> | ... |     | ...          | ... |
|         |                               |  | -10 | <b>83515</b> | ... |     | ...          | ... |
|         |                               |  | -10 | <b>83515</b> | ... |     | ...          | ... |
|         |                               |  |     | ...          | ... | 010 | <b>83159</b> | ... |
|         |                               |  |     | ...          | ... | 010 | <b>83159</b> | ... |
|         |                               |  | -10 | <b>83515</b> | ... |     | ...          | ... |
|         |                               |  |     | ...          | ... | 010 | <b>83159</b> | ... |
|         |                               |  |     | ...          | ... | 010 | <b>83159</b> | ... |
|         |                               |  | -10 | <b>83515</b> | ... |     | ...          | ... |
|         |                               |  | -10 | <b>83515</b> | ... |     | ...          | ... |



## APPLICATION GUIDE - TRUCKS, TRAILERS, AND BUSES

| Year<br>Año<br>Année | Model<br>Modelo<br>Modèle | OEM # | Front   |   | Rear  |   |
|----------------------|---------------------------|-------|---|---|---|---|
|                      |                           |       |  |  |  |  |
|                      |                           |       |  |  |  |  |
|                      |                           |       | Fleetline   | GasSLX  | Fleetline   | GasSLX  |

### ISUZU(Cont'd.)

#### NQR Series(Cont'd.)

|         |                               |               |  |     |     |     |       |     |
|---------|-------------------------------|---------------|--|-----|-----|-----|-------|-----|
| 03 - 17 | NQR Models with O.E.M. Number | 98343986      |  | ... | ... | OIO | 83159 | ... |
| 2002    | NQR (Diesel)                  | 8-97253-664-0 |  | ... | ... | OIO | 83159 | ... |
|         |                               | 97253664      |  | ... | ... | OIO | 83159 | ... |
| 95 - 97 | NQR (Diesel)                  | 8-97253-664-0 |  | ... | ... | OIO | 83159 | ... |
|         |                               | 97253664      |  | ... | ... | OIO | 83159 | ... |

#### NRR Series

|          |                               |               |     |       |       |     |       |     |
|----------|-------------------------------|---------------|-----|-------|-------|-----|-------|-----|
| 02 - 17  | NRR Models with O.E.M. Number | 8-97253-620-0 | -IO | 83515 | ...   |     | ...   | ... |
|          |                               | 8-97253-665-0 |     | ...   | ...   | OIO | 83159 | ... |
|          |                               | 8-98098-059-0 |     | ...   | ...   | OIO | 83159 | ... |
|          |                               | 8-98098-059-1 |     | ...   | ...   | OIO | 83159 | ... |
|          |                               | 8-98098-127-0 | -IO | 83515 | ...   |     | ...   | ... |
|          |                               | 8982326720    | -IO | 83515 | ...   |     | ...   | ... |
|          |                               | 8-98232672-0  | -IO | 83515 | ...   |     | ...   | ... |
|          |                               | 8-98232672-1  | -IO | 83515 | ...   |     | ...   | ... |
|          |                               | 8-98316-228-0 |     | ...   | ...   | OIO | 83159 | ... |
|          |                               | 8-98343986-0  |     | ...   | ...   | OIO | 83159 | ... |
|          |                               | 97253620      | -IO | 83515 | ...   |     | ...   | ... |
|          |                               | 97253665      |     | ...   | ...   | OIO | 83159 | ... |
|          |                               | 98098059      |     | ...   | ...   | OIO | 83159 | ... |
|          |                               | 98098127      | -IO | 83515 | ...   |     | ...   | ... |
| 98232672 | -IO                           | 83515         | ... |       | ...   | ... |       |     |
| 98343986 |                               | ...           | ... | OIO   | 83159 | ... |       |     |
| 88 - 99  | NRR Models (All)              | 1-51630-217-0 | -IO | 83114 | ...   |     | ...   | ... |
|          |                               | 1-51630-217-1 | -IO | 83114 | ...   |     | ...   | ... |
|          |                               | 1-51630-219-1 | -IO | 83114 | ...   |     | ...   | ... |
|          |                               | 51630217      | -IO | 83114 | ...   |     | ...   | ... |

#### Additional Applications





|          |                           |               |     |       |     |     |       |       |
|----------|---------------------------|---------------|-----|-------|-----|-----|-------|-------|
| 95 - 03  | FRR Models (All)          | 1-51630-219-0 | -IO | 83114 | ... |     | ...   | ...   |
|          |                           | 1-51630-219-1 | -IO | 83114 | ... |     | ...   | ...   |
|          |                           | 51630219      | -IO | 83114 | ... |     | ...   | ...   |
| 1985     | KS22 Models (All)         | 8-97083-027-0 | -IO | 83515 | ... |     | ...   | ...   |
|          |                           | 9-51630-666-0 |     | ...   | ... | OIO | 85012 | 89413 |
|          |                           | 9-51630-666-2 |     | ...   | ... | OIO | 85012 | 89413 |
|          | Models with O.E.M. Number | 8-22064-231-0 |     | ...   | ... | -I- | 85324 | ...   |
|          |                           | 8-22064-232-0 |     | ...   | ... | -I- | 85071 | ...   |
|          |                           | 8-22064-233-0 | -I- | 83136 | ... |     | ...   | ...   |
|          |                           | 8-22064-489-0 |     | ...   | ... | -I- | 85336 | ...   |
|          |                           | 8-22064-804-0 | -I- | 83136 | ... |     | ...   | ...   |
|          |                           | 8-22064-805-0 | -I- | 83136 | ... |     | ...   | ...   |
|          |                           | 8-22064-806-0 | -I- | 83136 | ... |     | ...   | ...   |
|          |                           | 8-22064-807-0 | -I- | 83136 | ... |     | ...   | ...   |
|          |                           | 8-51630-666-0 |     | ...   | ... | OIO | 85012 | 89413 |
|          |                           | 8972019600    | -IO | 83515 | ... |     | ...   | ...   |
|          |                           | 8-97253-616-0 | -IO | 83515 | ... |     | ...   | ...   |
|          |                           | 8-97253-621-0 | -IO | 83515 | ... |     | ...   | ...   |
|          |                           | 8-97253-623-0 | -IO | 83515 | ... |     | ...   | ...   |
|          |                           | 898098-1250   | -IO | 83515 | ... |     | ...   | ...   |
|          |                           | 898098-1270   | -IO | 83515 | ... |     | ...   | ...   |
| 94033786 | -IO                       | 83114         | ... |       | ... | ... |       |       |

### ITASCA

#### Class A MotorHomes

|      |   |              |  |     |     |     |       |     |
|------|---|--------------|--|-----|-----|-----|-------|-----|
| 2006 | Ellipse Series MotorHomes with Freightliner XC Chassis<br>ADL200 Suspension w/ 20K Rear | 16-16873-000 |  | ... | ... | OIO | 85029 | ... |
|------|---|--------------|--|-----|-----|-----|-------|-----|

**APPLICATION GUIDE - TRUCKS, TRAILERS, AND BUSES**





| Year<br>Año<br>Année | Model<br>Modelo<br>Modèle | OEM # | Front   |   | Rear  |  |
|----------------------|---------------------------|-------|---|---|---|--|
|                      |                           |       |  Fleetline |  GasSLX |  Fleetline |  GasSLX |

**ITASCA(Cont'd.)**

**Class A MotorHomes(Cont'd.)**

|                |  |                |       |       |       |       |       |       |
|----------------|--|----------------|-------|-------|-------|-------|-------|-------|
|                | AS120 Front Suspension<br><br>Rear Shock with O.E.M. Number<br><br>ZF - IFS Front Suspension with 23,000 lb GVW or Greater   | 141700131810   | 010   | 83160 | ...   |       | ...   | ...   |
|                |  | 16-16737-000   | 010   | 83160 | ...   |       | ...   | ...   |
|                |  | 16-16874-000   | 010   | 83160 | ...   |       | ...   | ...   |
|                |  | 141700131809   |       | ...   | ...   | 010   | 85029 | ...   |
|                |  | 16-16736-000   |       | ...   | ...   | 010   | 85029 | ...   |
|                |  | 16-18103-000   | -1-   | 85900 | ...   |       | ...   | ...   |
|                |  | 481700000493   | -1-   | 85900 | ...   |       | ...   | ...   |
| <b>04 - 06</b> | Horizon Series MotorHomes with Freightliner XC Chassis<br>ADL200 Suspension w/ 20K Rear<br>AS120 Front Suspension<br><br>Rear Shock with O.E.M. Number<br><br>ZF - IFS Front Suspension with 23,000 lb GVW or Greater  | 16-16873-000   |       | ...   | ...   | 010   | 85029 | ...   |
|                |  | 141700131810   | 010   | 83160 | ...   |       | ...   | ...   |
|                |  | 16-16737-000   | 010   | 83160 | ...   |       | ...   | ...   |
|                |  | 16-16874-000   | 010   | 83160 | ...   |       | ...   | ...   |
|                |  | 141700131809   |       | ...   | ...   | 010   | 85029 | ...   |
|                |  | 16-16736-000   |       | ...   | ...   | 010   | 85029 | ...   |
|                |  | 16-18103-000   | -1-   | 85900 | ...   |       | ...   | ...   |
| 481700000493   | -1-  | 85900          | ...   |       | ...   | ...   |       |       |
| <b>02 - 06</b> | Meridian Series MotorHomes with Freightliner XC Chassis<br>ADL200 Suspension w/ 20K Rear<br>AS120 Front Suspension<br><br>Rear Shock with O.E.M. Number<br><br>ZF - IFS Front Suspension with 23,000 lb GVW or Greater | 16-16873-000   |       | ...   | ...   | 010   | 85029 | ...   |
|                |  | 141700131810   | 010   | 83160 | ...   |       | ...   | ...   |
|                |  | 16-16737-000   | 010   | 83160 | ...   |       | ...   | ...   |
|                |  | 16-16874-000   | 010   | 83160 | ...   |       | ...   | ...   |
|                |  | 141700131809   |       | ...   | ...   | 010   | 85029 | ...   |
|                |  | 16-16736-000   |       | ...   | ...   | 010   | 85029 | ...   |
|                |  | 16-18103-000   | -1-   | 85900 | ...   |       | ...   | ...   |
| 481700000493   | -1-  | 85900          | ...   |       | ...   | ...   |       |       |
|                | Models with Workhorse UFO Chassis with Hendrickson Softek Front Suspension   | 66153-002      | 010   | 83124 | 89407 |       | ...   | ...   |
|                |  | F4-BE5-C832-MO | 010   | 83124 | 89407 |       | ...   | ...   |
| <b>99 - 15</b> | SunCruiser Series MotorHomes with Ford F53 Chassis with 16,000 lb GVW to 22,000 lb GVW   | 1C34-18045-AA  | 010   | 83209 | 89414 |       | ...   | ...   |
|                |  | 1C34-18045-JA  | 010   | 83209 | 89414 |       | ...   | ...   |
|                |  | 9U94-18045-AA  | 010   | 83209 | 89414 |       | ...   | ...   |
|                |  | 9U94-18080-AA  |       | ...   | ...   | 010   | 83122 | 89406 |
|                |  | 9U9Z-18124-A   | 010   | 83209 | 89414 |       | ...   | ...   |
|                |  | 9U9Z-18125-A   |       | ...   | ...   | 010   | 83122 | 89406 |
|                |  | ASH-1022       | 010   | 83209 | 89414 |       | ...   | ...   |
|                |  | ASH-1023       |       | ...   | ...   | 010   | 83122 | 89406 |
|                |  | ASH-1205       | 010   | 83209 | 89414 |       | ...   | ...   |
|                |  | ASH-1206       |       | ...   | ...   | 010   | 83122 | 89406 |
|                |  | ASH-1228       | 010   | 83209 | 89414 |       | ...   | ...   |
|                |  | ASH-1229       | 010   | 83209 | 89414 |       | ...   | ...   |
|                |  | ASH-1230       |       | ...   | ...   | 010   | 83122 | 89406 |
|                |  | ASH-137        |       | ...   | ...   | 010   | 83122 | 89406 |
|                |  | ASH-25822      | 010   | 83209 | 89414 |       | ...   | ...   |
|                |  | ASH-25823      | 010   | 83209 | 89414 |       | ...   | ...   |
|                |  | ASH-25824      |       | ...   | ...   | 010   | 83122 | 89406 |
| ASH-294        | 010  | 83209          | 89414 |       | ...   | ...   |       |       |
| AT-620         | 010  | 83209          | 89414 |       | ...   | ...   |       |       |
| AT-621         |  | ...            | ...   | 010   | 83122 | 89406 |       |       |
| AT-766         | 010  | 83209          | 89414 |       | ...   | ...   |       |       |
| <b>03 - 04</b> | SunCruiser Series MotorHomes with W20 , W22, & W24 Workhorse Chassis   | 24-153249      | 010   | 85125 | ...   |       | ...   | ...   |
|                |  | 24-186537      |       | ...   | ...   | 01-   | 85126 | ...   |
|                |  | 24-186629      | 010   | 85125 | ...   |       | ...   | ...   |
|                |  | F4-BE5-A011-HO |       | ...   | ...   | 01-   | 85126 | ...   |
|                |  | F4-BE5-A832-MO | 010   | 85125 | ...   |       | ...   | ...   |

**APPLICATION GUIDE - TRUCKS, TRAILERS, AND BUSES**

| Year<br>Año<br>Année | Model<br>Modelo<br>Modèle | OEM # | Front   |   | Rear  |   |
|----------------------|---------------------------|-------|---|---|---|---|
|                      |                           |       |  |  |  |  |
|                      |                           |       | Fleetline   | GasSLX  | Fleetline   | GasSLX  |

**ITASCA(Cont'd.)**

**Class A MotorHomes(Cont'd.)**

|         |  |                |     |       |     |     |       |     |
|---------|--|----------------|-----|-------|-----|-----|-------|-----|
| 03 - 04 | SunCruiser Series MotorHomes with W20 , W22, & W24 Workhorse Chassis | F4-BE5-B492-HO | 010 | 85125 | ... |     | ...   | ... |
|         |  | F4-BE5-F324-HO | 010 | 85125 | ... |     | ...   | ... |
|         |  | W0005662       | 010 | 85125 | ... |     | ...   | ... |
|         |  | W0006254       | 010 | 85125 | ... |     | ...   | ... |
| 05 - 14 | Sunova Models with W20 , W22, & W24 WorkHorse MotorHome Chassis      | 24-153256      |     | ...   | ... | - - | 85124 | ... |
|         |  | F4-BE5-F325-HO |     | ...   | ... | - - | 85124 | ... |
|         |  | W0005663       |     | ...   | ... | - - | 85124 | ... |
| 98 - 14 | Sunova Models with W20 , W22, & W24 WorkHorse MotorHome Chassis      | 24-153249      | 010 | 85125 | ... |     | ...   | ... |
|         |  | F4-BE5-A832-MO | 010 | 85125 | ... |     | ...   | ... |
|         |  | F4-BE5-F324-HO | 010 | 85125 | ... |     | ...   | ... |
|         |  | W0005662       | 010 | 85125 | ... |     | ...   | ... |
|         |  | W0006254       | 010 | 85125 | ... |     | ...   | ... |

**Class C MotorHomes**

|         |  |               |     |       |     |     |       |     |
|---------|--|---------------|-----|-------|-----|-----|-------|-----|
| 06 - 19 | Cambria Series Motorhomes with Ford E450 Chassis | 8C24-18045-DA | - 0 | 83177 | ... |     | ...   | ... |
|         |  | 8C24-18080-DB |     | ...   | ... | - 0 | 83178 | ... |
|         |  | 8C2Z-18124-D  | - 0 | 83177 | ... |     | ...   | ... |
|         |  | 8C2Z-18125-D  |     | ...   | ... | - 0 | 83178 | ... |
|         |  | ASH-1136      |     | ...   | ... | - 0 | 83178 | ... |
|         |  | ASH-1154      | - 0 | 83177 | ... |     | ...   | ... |
|         |  | AT-163G       | - 0 | 83177 | ... |     | ...   | ... |
|         |  | AT-164G       |     | ...   | ... | - 0 | 83178 | ... |
| 07 - 14 | Impulse Series Motorhomes with Ford E450 Chassis | 8C24-18045-DA | - 0 | 83177 | ... |     | ...   | ... |
|         |  | 8C24-18080-DB |     | ...   | ... | - 0 | 83178 | ... |
|         |  | 8C2Z-18124-D  | - 0 | 83177 | ... |     | ...   | ... |
|         |  | 8C2Z-18125-D  |     | ...   | ... | - 0 | 83178 | ... |
|         |  | ASH-1136      |     | ...   | ... | - 0 | 83178 | ... |
|         |  | ASH-1154      | - 0 | 83177 | ... |     | ...   | ... |
|         |  | AT-163G       | - 0 | 83177 | ... |     | ...   | ... |
|         |  | AT-164G       |     | ...   | ... | - 0 | 83178 | ... |
| 01 - 19 | Spirit Series Motorhomes with Ford E450 Chassis  | 8C24-18045-DA | - 0 | 83177 | ... |     | ...   | ... |
|         |  | 8C24-18080-DB |     | ...   | ... | - 0 | 83178 | ... |
|         |  | 8C2Z-18124-D  | - 0 | 83177 | ... |     | ...   | ... |
|         |  | 8C2Z-18125-D  |     | ...   | ... | - 0 | 83178 | ... |
|         |  | ASH-1136      |     | ...   | ... | - 0 | 83178 | ... |
|         |  | ASH-1154      | - 0 | 83177 | ... |     | ...   | ... |
|         |  | AT-163G       | - 0 | 83177 | ... |     | ...   | ... |
|         |  | AT-164G       |     | ...   | ... | - 0 | 83178 | ... |

**JAY MADSEN**

|  |                                |         |     |  |       |  |  |
|--|--------------------------------|---------|-----|--|-------|--|--|
|  | Additional O.E.M. Interchanges | 3166657 | 010 |  | 85700 |  |  |
|  |                                | 3192333 | 010 |  | 85700 |  |  |

**JAYCO RV INC**

**Class A MotorHomes**

|         |   |           |     |       |       |     |       |       |
|---------|---|-----------|-----|-------|-------|-----|-------|-------|
| 15 - 19 | Alante Series MotorHomes with Ford F53 Chassis with 16,000 lb GVW to 22,000 lb GVW  | ASH-1229  | 010 | 83209 | 89414 |     | ...   | ...   |
|         |   | ASH-25822 | 010 | 83209 | 89414 |     | ...   | ...   |
|         |   | ASH-25823 | 010 | 83209 | 89414 |     | ...   | ...   |
|         |   | ASH-25824 |     | ...   | ...   | 010 | 83122 | 89406 |
| 14 - 19 | Precept Series MotorHomes with Ford F53 Chassis with 16,000 lb GVW to 22,000 lb GVW | ASH-1229  | 010 | 83209 | 89414 |     | ...   | ...   |
|         |   | ASH-25822 | 010 | 83209 | 89414 |     | ...   | ...   |
|         |   | ASH-25823 | 010 | 83209 | 89414 |     | ...   | ...   |

## APPLICATION GUIDE - TRUCKS, TRAILERS, AND BUSES

| Year<br>Año<br>Année | Model<br>Modelo<br>Modèle | OEM # | Front     |        |  | Rear |  |  |
|----------------------|---------------------------|-------|-----------|--------|--|------|--|--|
|                      |                           |       |           |        |  |      |  |  |
|                      |                           |       | Fleetline | GasSLX |  |      |  |  |

### JAYCO RV INC(Cont'd.)

#### Class A MotorHomes(Cont'd.)

|         |   |           |  |     |     |     |              |              |
|---------|---|-----------|--|-----|-----|-----|--------------|--------------|
| 14 - 19 | Precept Series MotorHomes with Ford F53 Chassis with 16,000 lb GVW to 22,000 lb GVW | ASH-25824 |  | ... | ... | 010 | <b>83122</b> | <b>89406</b> |
|---------|---|-----------|--|-----|-----|-----|--------------|--------------|

#### Class C MotorHomes

|         |   |                      |     |              |     |     |              |     |
|---------|---|----------------------|-----|--------------|-----|-----|--------------|-----|
|         | Designer Series MotorHomes with Ford E350 & E450 Chassis      | ASH-1136<br>ASH-1154 | -10 | ...          | ... | -10 | <b>83178</b> | ... |
|         |   |                      |     | <b>83177</b> | ... |     | ...          | ... |
| 03 - 06 | Escapade Series MotorHomes with Ford E350 & E450 Chassis      | ASH-1136<br>ASH-1154 | -10 | ...          | ... | -10 | <b>83178</b> | ... |
|         |   |                      |     | <b>83177</b> | ... |     | ...          | ... |
| 02 - 06 | Granite Ridge Series MotorHomes with Ford E350 & E450 Chassis | ASH-1136<br>ASH-1154 | -10 | ...          | ... | -10 | <b>83178</b> | ... |
|         |   |                      |     | <b>83177</b> | ... |     | ...          | ... |
| 02 - 19 | Greyhawk Series MotorHomes with Ford E350 & E450 Chassis      | ASH-1136<br>ASH-1154 | -10 | ...          | ... | -10 | <b>83178</b> | ... |
|         |   |                      |     | <b>83177</b> | ... |     | ...          | ... |
| 07 - 15 | Melbourne Series MotorHomes with Ford E350 & E450 Chassis     | ASH-1136<br>ASH-1154 | -10 | ...          | ... | -10 | <b>83178</b> | ... |
|         |   |                      |     | <b>83177</b> | ... |     | ...          | ... |
| 04 - 19 | Redhawk Series MotorHomes with Ford E350 & E450 Chassis       | ASH-1136<br>ASH-1154 | -10 | ...          | ... | -10 | <b>83178</b> | ... |
|         |   |                      |     | <b>83177</b> | ... |     | ...          | ... |

### JIFFLOX

|  |             |         |     |              |     |  |     |     |
|--|-------------|---------|-----|--------------|-----|--|-----|-----|
|  | Truck Dolly | CP-5222 | 010 | <b>85315</b> | ... |  | ... | ... |
|--|-------------|---------|-----|--------------|-----|--|-----|-----|

### JOHN DEERE

|  |                           |         |     |               |     |  |     |     |
|--|---------------------------|---------|-----|---------------|-----|--|-----|-----|
|  | Models with O.E.M. Number | 4036892 | 010 | <b>G63605</b> | ... |  | ... | ... |
|--|---------------------------|---------|-----|---------------|-----|--|-----|-----|

#### Motorhome Chassis

|         |                                       |         |  |     |     |     |               |     |
|---------|---------------------------------------|---------|--|-----|-----|-----|---------------|-----|
| 73 - 81 | M & R-300, 400, 500 Motorhome Chassis | 3638112 |  | ... | ... | 010 | <b>G63183</b> | ... |
|---------|---------------------------------------|---------|--|-----|-----|-----|---------------|-----|

### KENWORTH





#### C500, C500B, C500K, C540 & C550

|         |  |   |     |              |              |     |              |              |
|---------|--|---|-----|--------------|--------------|-----|--------------|--------------|
|         | All with Air Glide 100 Suspension with 8 air bags, 4 units required                | K374-29<br>K374-32                        |     | ...          | ...          | -1- | <b>85310</b> | <b>89423</b> |
|         |  |   |     | ...          | ...          | -1- | <b>85310</b> | <b>89423</b> |
|         | All with Air Glide 200 with 40,000 lb Suspension with 8 air bags, 4 units required | 665903<br>665944<br>70701                 |     | ...          | ...          | -1- | <b>85900</b> | ...          |
|         |  |   |     | ...          | ...          | -1- | <b>85900</b> | ...          |
|         |  |   |     | ...          | ...          | -1- | <b>85900</b> | ...          |
| 01 - 16 | Models with Air Glide 380 (AG380) Rear Air Suspension                              | C71-1002<br>C71-1016                      |     | ...          | ...          | 010 | <b>85067</b> | <b>89451</b> |
|         |  |   |     | ...          | ...          | 010 | <b>85067</b> | <b>89451</b> |
|         | Models with Dual Steering Front Axle and Torsion Bar Bogey Rear Suspension         | K374-28<br>K374-4                         |     | ...          | ...          | 010 | <b>85314</b> | <b>89425</b> |
|         |  |   |     | ...          | ...          | 010 | <b>85314</b> | <b>89425</b> |
| - 2009  | Models with Multiple Leaf Springs on Front Axle                                    | B71-1003<br>K374-3<br>K374-33             | 010 | <b>83312</b> | <b>89409</b> |     | ...          | ...          |
|         |  |   |     | <b>83312</b> | <b>89409</b> |     | ...          | ...          |
|         |  |   |     | <b>83312</b> | <b>89409</b> |     | ...          | ...          |
|         | Models with Neway ADZ Rear Suspension  | 471700004423<br>90045605                  |     | ...          | ...          | 010 | <b>85109</b> | ...          |
|         |  |   |     | ...          | ...          | 010 | <b>85109</b> | ...          |
| 87 - 16 | Models with Taper Leaf Springs on Front Axle                                       | B71-1002<br>K374-16<br>K374-26<br>K374-27 | 010 | <b>85001</b> | <b>89410</b> |     | ...          | ...          |
|         |  |   |     | <b>85001</b> | <b>89410</b> |     | ...          | ...          |
|         |  |   |     | <b>85001</b> | <b>89410</b> |     | ...          | ...          |
|         |  |   |     | <b>85001</b> | <b>89410</b> |     | ...          | ...          |
|         | All with Air Glide 200 with 46,000 lb Suspension with 8 air bags, 4 units required | 665906<br>665945                          |     | ...          | ...          | -1- | <b>85902</b> | ...          |
|         |  |   |     | ...          | ...          | -1- | <b>85902</b> | ...          |

#### ICON 900

|         |   |                      |     |              |     |     |              |              |
|---------|---|----------------------|-----|--------------|-----|-----|--------------|--------------|
| 16 - 17 | Models with 10,000 lb to 14,600 lb Taperleaf Springs and Set Back Front Axles | B71-6019             | 010 | <b>85989</b> | ... |     | ...          | ...          |
| 16 - 17 | Models with Air Glide 380 (AG380) Rear Air Suspension                         | C71-1016<br>C71-6015 |     | ...          | ... | 010 | <b>85067</b> | <b>89451</b> |
|         |   |                      |     | ...          | ... | 010 | <b>85067</b> | <b>89451</b> |
| 16 - 17 | Models with Air Glide 400 (AG400) Rear Air Suspension                         | C71-1014             |     | ...          | ... | 01- | <b>85936</b> | <b>89456</b> |

**APPLICATION GUIDE - TRUCKS, TRAILERS, AND BUSES**

| Year<br>Año<br>Année | Model<br>Modelo<br>Modèle | OEM # | Front   |   | Rear  |   |
|----------------------|---------------------------|-------|---|---|---|---|
|                      |                           |       |  |  |  |  |
|                      |                           |       | Fleetline   | GasSLX  | Fleetline   | GasSLX  |

**KENWORTH(Cont'd.)**

**ICON 900(Cont'd.)**

|         |   |               |     |       |       |     |       |     |
|---------|---|---------------|-----|-------|-------|-----|-------|-----|
| 16 - 17 | Models with Air Glide 460 (AG460) Rear Air Suspension | C71-1015      |     | ...   | ...   | 0 - | 85937 | ... |
|         |   | C71-1015 PLUS |     | ...   | ...   | 0 - | 85937 | ... |
| 16 - 17 | Models with Taper Leaf Springs on Front Axle          | B71-1002      | 0 0 | 85001 | 89410 |     | ...   | ... |

**K100, K100E, K125**

|         |  |           |     |       |       |     |       |       |
|---------|--|-----------|-----|-------|-------|-----|-------|-------|
|         | All with Air Glide 100 Suspension with 8 air bags, 4 units required                | K374-29   |     | ...   | ...   | - - | 85310 | 89423 |
|         |  | K374-32   |     | ...   | ...   | - - | 85310 | 89423 |
|         | All with Air Glide 200 with 40,000 lb Suspension with 8 air bags, 4 units required | 665903    |     | ...   | ...   | - - | 85900 | ...   |
|         |  | 665944    |     | ...   | ...   | - - | 85900 | ...   |
|         |  | 70701     |     | ...   | ...   | - - | 85900 | ...   |
|         | All with Air Glide 200 with 46,000 lb Suspension with 8 air bags, 4 units required | 665906    |     | ...   | ...   | - - | 85902 | ...   |
|         |  | 665945    |     | ...   | ...   | - - | 85902 | ...   |
|         | Models with Dual Steering Front Axle and Torsion Bar Bogey Rear Suspension         | K374-28   |     | ...   | ...   | 0 0 | 85314 | 89425 |
|         |  | K374-4    |     | ...   | ...   | 0 0 | 85314 | 89425 |
|         | Models with Multiple Leaf Springs on Front Axle                                    | B71-1003  | 0 0 | 83312 | 89409 |     | ...   | ...   |
|         |  | K374-3    | 0 0 | 83312 | 89409 |     | ...   | ...   |
|         |  | K374-33   | 0 0 | 83312 | 89409 |     | ...   | ...   |
|         | Models with Set Back Front Axle  | 665331    | 0 - | 85740 | ...   |     | ...   | ...   |
|         |  | K374-13   | 0 - | 85740 | ...   |     | ...   | ...   |
|         |  | K374-13-1 | 0 - | 85740 | ...   |     | ...   | ...   |
| 87 - 06 | Models with Taper Leaf Springs on Front Axle                                       | B71-1002  | 0 0 | 85001 | 89410 |     | ...   | ...   |
|         |  | K374-16   | 0 0 | 85001 | 89410 |     | ...   | ...   |
|         |  | K374-26   | 0 0 | 85001 | 89410 |     | ...   | ...   |
|         |  | K374-27   | 0 0 | 85001 | 89410 |     | ...   | ...   |





**K270, K370**

|         |  |            |     |       |     |     |       |       |
|---------|--|------------|-----|-------|-----|-----|-------|-------|
| 13 - 19 | Models with 10,000 lb or 12,000 lb Front Axle                        | 1707378PAC | - - | 85182 | ... |     | ...   | ...   |
|         |  | BFRG 072   | - - | 85182 | ... |     | ...   | ...   |
| 13 - 19 | Models with 21,000 to 23,000 lb Reyco Spring Suspension              | 19495-01   |     | ...   | ... | 0 0 | 83126 | 89440 |
|         |  | TK19679    |     | ...   | ... | 0 0 | 83126 | 89440 |
| 13 - 18 | Models with Hendrickson HAS - 210L or HAS - 230L Rear Air Suspension | 60670-008  |     | ...   | ... | 0 0 | 83123 | 89405 |
|         |  | 60670-008L |     | ...   | ... | 0 0 | 83123 | 89405 |
| 13 - 18 | Models with Reyco 102 or 79KB Suspension (Drive Axle)                | 16725-01   |     | ...   | ... | 0 0 | 83126 | ...   |
|         |  | 19495-01   |     | ...   | ... | 0 0 | 83126 | ...   |

**K300**

|  |  |          |     |       |       |     |       |       |
|--|--|----------|-----|-------|-------|-----|-------|-------|
|  | All with Air Glide 100 Suspension with 8 air bags, 4 units required                | K374-29  |     | ...   | ...   | - - | 85310 | 89423 |
|  |  | K374-32  |     | ...   | ...   | - - | 85310 | 89423 |
|  | All with Air Glide 200 with 40,000 lb Suspension with 8 air bags, 4 units required | 665903   |     | ...   | ...   | - - | 85900 | ...   |
|  |  | 665944   |     | ...   | ...   | - - | 85900 | ...   |
|  |  | 70701    |     | ...   | ...   | - - | 85900 | ...   |
|  | All with Air Glide 200 with 46,000 lb Suspension with 8 air bags, 4 units required | 665906   |     | ...   | ...   | - - | 85902 | ...   |
|  |  | 665945   |     | ...   | ...   | - - | 85902 | ...   |
|  | K300 COE Medium Duty   | 665565   | 0 0 | 85007 | 89412 |     | ...   | ...   |
|  | Models with 12,000 lb Taper Leaf Front Springs (5/8" Top Mounting bolt)            | 665617   | 0 0 | 85031 | ...   |     | ...   | ...   |
|  |  | B71-1000 | 0 0 | 85031 | ...   |     | ...   | ...   |
|  | Models with Hendrickson Rear Air Suspension  | 47902-19 |     | ...   | ...   | 0 0 | 83123 | 89405 |
|  | Models with Multiple Leaf Springs on Front Axle (3/4" Mounting bolts)              | B71-1003 | 0 0 | 83312 | 89409 |     | ...   | ...   |
|  |  | K374-3   | 0 0 | 83312 | 89409 |     | ...   | ...   |
|  |  | K374-33  | 0 0 | 83312 | 89409 |     | ...   | ...   |
|  | Models with Reyco 102 or 79KB Suspension (Drive Axle)                              | 16725-01 |     | ...   | ...   | 0 0 | 83126 | ...   |

**APPLICATION GUIDE - TRUCKS, TRAILERS, AND BUSES**

| Year<br>Año<br>Année | Model<br>Modelo<br>Modèle | OEM # | Front   |   | Rear  |   |
|----------------------|---------------------------|-------|---|---|---|---|
|                      |                           |       |  |  |  |  |
|                      |                           |       | Fleetline   | GasSLX  | Fleetline   | GasSLX  |

**KENWORTH(Cont'd.)**

**K300(Cont'd.)**

|  |  |          |              |              |              |     |              |     |
|--|--|----------|--------------|--------------|--------------|-----|--------------|-----|
|  | Models with Reyco 102 or 79KB Suspension (Drive Axle)            | 19495-01 |              | ...          | ...          | 0 0 | <b>83126</b> | ... |
|  | Models with Reyco 1209 or 1212 Suspension (Steer Axle)           | 19495-01 | 0 0          | <b>83126</b> | <b>89440</b> |     | ...          | ... |
|  | Models with Taper Leaf Springs on Front Axle (1" Mounting bolts) | B71-1002 | 0 0          | <b>85001</b> | <b>89410</b> |     | ...          | ... |
|  |  | K374-16  | 0 0          | <b>85001</b> | <b>89410</b> |     | ...          | ... |
|  |  | K374-26  | 0 0          | <b>85001</b> | <b>89410</b> |     | ...          | ... |
|  | K374-27  | 0 0      | <b>85001</b> | <b>89410</b> |              | ... | ...          |     |
|  | Models with Woodhead Shock (Stamping Number ACHB 966)            | ACHB966  |              | ...          | ...          | - - | <b>83136</b> | ... |

**T170**

|                |   |          |     |              |     |     |              |     |
|----------------|---|----------|-----|--------------|-----|-----|--------------|-----|
| <b>08 - 13</b> | Models with 8,000 lb Taper Leaf Front Springs | 665617   | 0 0 | <b>85031</b> | ... |     | ...          | ... |
| <b>08 - 18</b> | Models with Reyco 79KB Rear Suspension        | 16725-01 |     | ...          | ... | 0 0 | <b>83126</b> | ... |
|                |   | 19495-01 |     | ...          | ... | 0 0 | <b>83126</b> | ... |





**T270, T370**

|                |   |            |     |              |              |     |              |              |
|----------------|---|------------|-----|--------------|--------------|-----|--------------|--------------|
| <b>10 - 14</b> | Models with 10,000 lb to 12,000 lb Front Axle                                 | B71-6005   | 0 0 | <b>85084</b> | <b>89460</b> |     | ...          | ...          |
| <b>15 - 19</b> | Models with 10,000 lb to 14,600 lb Taperleaf Springs and Set Back Front Axles | B71-6019   | 0 0 | <b>85989</b> | ...          |     | ...          | ...          |
| <b>08 - 10</b> | Models with 12,000 lb Front Axle  | 665617     | 0 0 | <b>85031</b> | ...          |     | ...          | ...          |
| <b>10 - 14</b> | Models with 13,200 lb to 14,600 lb Front Axle                                 | B71-6006   | 0 0 | <b>85084</b> | <b>89460</b> |     | ...          | ...          |
| <b>15 - 19</b> | Models with 16,000 lb to 20,000 lb Taperleaf Springs and Set Back Front Axles | B71-6020   | 0 0 | <b>85989</b> | ...          |     | ...          | ...          |
| <b>10 - 14</b> | Models with 8,000 lb Front Axle   | B71-6004   | 0 0 | <b>85084</b> | <b>89460</b> |     | ...          | ...          |
| <b>10 - 19</b> | Models with AG210L Rear Air Suspension  | C71-1011   |     | ...          | ...          | - - | <b>85069</b> | <b>89455</b> |
|                |   | C71-1017   |     | ...          | ...          | - - | <b>85069</b> | <b>89455</b> |
| <b>10 - 19</b> | Models with Air Glide 400L (AG400L) Rear Air Suspension                       | C71-1011   |     | ...          | ...          | - - | <b>85069</b> | <b>89455</b> |
|                |   | C71-1017   |     | ...          | ...          | - - | <b>85069</b> | <b>89455</b> |
| <b>08 - 19</b> | Models with Hendrickson HAS - 210L or HAS - 230L Rear Air Suspension          | 60670-008  |     | ...          | ...          | 0 0 | <b>83123</b> | <b>89405</b> |
|                |   | 60670-008L |     | ...          | ...          | 0 0 | <b>83123</b> | <b>89405</b> |
| <b>08 - 14</b> | Models with Hendrickson HAS - 400 (Standard) Rear Air Suspension              | 60670-005  |     | ...          | ...          | 0 0 | <b>83137</b> | ...          |
|                |   | 60670-005L |     | ...          | ...          | 0 0 | <b>83137</b> | ...          |
| <b>08 - 19</b> | Models with Hendrickson HMX 400/460 Haulmax (with 16.5" Saddle)               | 60680-004  |     | ...          | ...          | 0 - | <b>83143</b> | ...          |
|                |   | 60680-004L |     | ...          | ...          | 0 - | <b>83143</b> | ...          |
|                |   | 64178-001  |     | ...          | ...          | 0 - | <b>83143</b> | ...          |
| <b>08 - 19</b> | Models with Reyco 102 or 79KB Suspension (Drive Axle)                         | 16725-01   |     | ...          | ...          | 0 0 | <b>83126</b> | ...          |
|                |   | 19495-01   |     | ...          | ...          | 0 0 | <b>83126</b> | ...          |
|                |   | TK19679    |     | ...          | ...          | 0 0 | <b>83126</b> | ...          |

**T300**

|                |  |            |     |              |     |     |              |              |
|----------------|--|------------|-----|--------------|-----|-----|--------------|--------------|
|                | All with Air Glide 100 Suspension with 8 air bags, 4 units required                | K374-29    |     | ...          | ... | - - | <b>85310</b> | <b>89423</b> |
|                |  | K374-32    |     | ...          | ... | - - | <b>85310</b> | <b>89423</b> |
|                | All with Air Glide 200 with 40,000 lb Suspension with 8 air bags, 4 units required | 665903     |     | ...          | ... | - - | <b>85900</b> | ...          |
|                |  | 665944     |     | ...          | ... | - - | <b>85900</b> | ...          |
|                |  | 70701      |     | ...          | ... | - - | <b>85900</b> | ...          |
|                | All with Air Glide 200 with 46,000 lb Suspension with 8 air bags, 4 units required | 665906     |     | ...          | ... | - - | <b>85902</b> | ...          |
|                |  | 665945     |     | ...          | ... | - - | <b>85902</b> | ...          |
| <b>11 - 18</b> | Models with 10,000 lb to 14,600 lb Taperleaf Springs and Set Back Front Axles      | B71-6019   | 0 0 | <b>85989</b> | ... |     | ...          | ...          |
| <b>99 - 10</b> | Models with 12,000 lb Taper Leaf Front Springs (5/8" Top Mounting bolt)            | 665617     | 0 0 | <b>85031</b> | ... |     | ...          | ...          |
|                |  | B71-1000   | 0 0 | <b>85031</b> | ... |     | ...          | ...          |
| <b>12 - 18</b> | Models with Air Glide 400L (AG400L) Rear Air Suspension                            | C71-1011   |     | ...          | ... | - - | <b>85069</b> | <b>89455</b> |
|                |  | C71-1017   |     | ...          | ... | - - | <b>85069</b> | <b>89455</b> |
| <b>07 - 18</b> | Models with Hendrickson HAS - 210L or HAS - 230L Rear Air Suspension               | 60670-008  |     | ...          | ... | 0 0 | <b>83123</b> | <b>89405</b> |
|                |  | 60670-008L |     | ...          | ... | 0 0 | <b>83123</b> | <b>89405</b> |

**APPLICATION GUIDE - TRUCKS, TRAILERS, AND BUSES**

| Year<br>Año<br>Année | Model<br>Modelo<br>Modèle | OEM # | Front   |   | Rear  |   |
|----------------------|---------------------------|-------|---|---|---|---|
|                      |                           |       |  |  |  |  |
|                      |                           |       | Fleetline   | GasSLX  | Fleetline   | GasSLX  |

**KENWORTH(Cont'd.)**

**T300(Cont'd.)**

|               |   |                       |     |              |              |     |              |              |
|---------------|---|-----------------------|-----|--------------|--------------|-----|--------------|--------------|
|               | Models with Hendrickson Rear Air Suspension                           | 47902-19<br>60670-004 |     | ...          | ...          | 0 0 | <b>83123</b> | <b>89405</b> |
|               |   |                       |     | ...          | ...          | 0 0 | <b>83123</b> | <b>89405</b> |
|               | Models with Multiple Leaf Springs on Front Axle (3/4" Mounting bolts) | B71-1003              | 0 0 | <b>83312</b> | <b>89409</b> |     | ...          | ...          |
|               |   | K374-3                | 0 0 | <b>83312</b> | <b>89409</b> |     | ...          | ...          |
|               |   | K374-33               | 0 0 | <b>83312</b> | <b>89409</b> |     | ...          | ...          |
|               | Models with Reyco 102 or 79KB Suspension (Drive Axle)                 | 16725-01<br>19495-01  |     | ...          | ...          | 0 0 | <b>83126</b> | ...          |
|               |   |                       |     | ...          | ...          | 0 0 | <b>83126</b> | ...          |
| <b>- 2018</b> | Models with Reyco 1209 or 1212 Suspension (Steer Axle)                | 19495-01              | 0 0 | <b>83126</b> | <b>89440</b> |     | ...          | ...          |
|               | Models with Taper Leaf Springs on Front Axle (1" Mounting bolts)      | B71-1002              | 0 0 | <b>85001</b> | <b>89410</b> |     | ...          | ...          |
|               |   | K374-16               | 0 0 | <b>85001</b> | <b>89410</b> |     | ...          | ...          |
|               |   | K374-26               | 0 0 | <b>85001</b> | <b>89410</b> |     | ...          | ...          |
|               |   | K374-27               | 0 0 | <b>85001</b> | <b>89410</b> |     | ...          | ...          |
|               | Models with Woodhead Shock (Stamping Number ACHB 966)                 | ACHB966               |     | ...          | ...          | - - | <b>83136</b> | ...          |

**T400, T400B, T450B**





|                |   |                           |     |              |              |     |              |              |
|----------------|---|---------------------------|-----|--------------|--------------|-----|--------------|--------------|
|                | All with Air Glide 100 Suspension with 8 air bags, 4 units required                       | K374-29<br>K374-32        |     | ...          | ...          | - - | <b>85310</b> | <b>89423</b> |
|                |   |                           |     | ...          | ...          | - - | <b>85310</b> | <b>89423</b> |
|                | All with Air Glide 200 with 40,000 lb Suspension with 8 air bags, 4 units required        | 665903<br>665944<br>70701 |     | ...          | ...          | - - | <b>85900</b> | ...          |
|                |   |                           |     | ...          | ...          | - - | <b>85900</b> | ...          |
|                | All with Air Glide 200 with 46,000 lb Suspension with 8 air bags, 4 units required        | 665906<br>665945          |     | ...          | ...          | - - | <b>85902</b> | ...          |
|                |   |                           |     | ...          | ...          | - - | <b>85902</b> | ...          |
|                | Models with Multiple Leaf Springs on Front Axle   | B71-1003                  | 0 0 | <b>83312</b> | <b>89409</b> |     | ...          | ...          |
|                |   | K374-3                    | 0 0 | <b>83312</b> | <b>89409</b> |     | ...          | ...          |
|                |   | K374-33                   | 0 0 | <b>83312</b> | <b>89409</b> |     | ...          | ...          |
| <b>89 - 16</b> | Models with Taper Leaf Springs on Front Axle  | B71-1002                  | 0 0 | <b>85001</b> | <b>89410</b> |     | ...          | ...          |
|                |   | K374-16                   | 0 0 | <b>85001</b> | <b>89410</b> |     | ...          | ...          |
|                |   | K374-26                   | 0 0 | <b>85001</b> | <b>89410</b> |     | ...          | ...          |
|                |   | K374-27                   | 0 0 | <b>85001</b> | <b>89410</b> |     | ...          | ...          |
|                | Models with Torsion Bar Bogey (2 rear axles) and KW Air Ride Suspension (with 4 air bags) | K374-28<br>K374-4         |     | ...          | ...          | 0 0 | <b>85314</b> | <b>89425</b> |
|                |   |                           |     | ...          | ...          | 0 0 | <b>85314</b> | <b>89425</b> |

**T440**

|                |   |                                     |     |              |              |     |              |              |
|----------------|---|-------------------------------------|-----|--------------|--------------|-----|--------------|--------------|
| <b>12 - 19</b> | Models with 12,000 to 20,000 lb Taperleaf Front Suspension    | 665858<br>B71-1001                  | 0 0 | <b>85070</b> | <b>89459</b> |     | ...          | ...          |
|                |   |                                     | 0 0 | <b>85070</b> | <b>89459</b> |     | ...          | ...          |
| <b>12 - 19</b> | Models with 21,000 to 23,000 lb Reyco Spring Suspension       | 19495-01<br>TK19679                 |     | ...          | ...          | 0 0 | <b>83126</b> | <b>89440</b> |
|                |   |                                     |     | ...          | ...          | 0 0 | <b>83126</b> | <b>89440</b> |
| <b>12 - 17</b> | Models with Air Glide 380 (AG380) Rear Air Suspension         | C71-1002<br>C71-1016<br>C71-6015    |     | ...          | ...          | 0 0 | <b>85067</b> | <b>89451</b> |
|                |   |                                     |     | ...          | ...          | 0 0 | <b>85067</b> | <b>89451</b> |
|                |   |                                     |     | ...          | ...          | 0 0 | <b>85067</b> | <b>89451</b> |
| <b>12 - 19</b> | Models with Air Glide 400 (AG400) Rear Air Suspension         | 671962<br>C71-1014                  |     | ...          | ...          | 0 - | <b>85936</b> | <b>89456</b> |
|                |   |                                     |     | ...          | ...          | 0 - | <b>85936</b> | <b>89456</b> |
| <b>12 - 19</b> | Models with Air Glide 400L (AG400L) Rear Air Suspension       | C71-1011<br>C71-1017                |     | ...          | ...          | - - | <b>85069</b> | <b>89455</b> |
|                |   |                                     |     | ...          | ...          | - - | <b>85069</b> | <b>89455</b> |
| <b>12 - 19</b> | Models with Air Glide 460 (AG460) Rear Air Suspension         | 671963<br>C71-1015<br>C71-1015 PLUS |     | ...          | ...          | 0 - | <b>85937</b> | ...          |
|                |   |                                     |     | ...          | ...          | 0 - | <b>85937</b> | ...          |
|                |   |                                     |     | ...          | ...          | 0 - | <b>85937</b> | ...          |
| <b>12 - 18</b> | Models with Chalmers 40,000 lb Rear Suspension                | 665174                              |     | ...          | ...          | 0 0 | <b>85060</b> | ...          |
| <b>12 - 17</b> | Models with Hendrickson HAS - 230 Rear Air Suspension         | 60670-005                           |     | ...          | ...          | 0 0 | <b>83137</b> | ...          |
| <b>12 - 19</b> | Models with Hendrickson HMX 400/460 Haulmax with 16.5" Saddle | 60680-004<br>60680-004L             |     | ...          | ...          | 0 - | <b>83143</b> | ...          |
|                |   |                                     |     | ...          | ...          | 0 - | <b>83143</b> | ...          |



**APPLICATION GUIDE - TRUCKS, TRAILERS, AND BUSES**

| Year<br>Año<br>Année | Model<br>Modelo<br>Modèle | OEM # | Front   |  |   | Rear  |           |        |
|----------------------|---------------------------|-------|---|--|---|---|-----------|--------|
|                      |                           |       |  |  |  |  | Fleetline | GasSLX |

**KENWORTH(Cont'd.)**





**T440(Cont'd.)**

|         |  |              |     |     |     |       |       |
|---------|--|--------------|-----|-----|-----|-------|-------|
| 12 - 18 | Models with Hendrickson HMX 400/460 Haulmax with 17.5" & 18.5" Saddle                          | 60680-005    | ... | ... | 01- | 83142 | ...   |
|         |  | 60680-005L   | ... | ... | 01- | 83142 | ...   |
| 12 - 18 | Models with Hendrickson Primaax 230, 460 and 690 Air Suspension (8-1/2" to 10" Ride Height)    | 60657-003    | ... | ... | 010 | 85072 | ...   |
|         |  | 60657-003L   | ... | ... | 010 | 85072 | ...   |
| 12 - 18 | Models with Hendrickson Primaax EX 232, 462 and 692 Air Suspension (8-1/2" to 10" Ride Height) | 60657-003    | ... | ... | 010 | 85072 | ...   |
|         |  | 60657-003L   | ... | ... | 010 | 85072 | ...   |
| 12 - 17 | Models with Hendrickson Primaax EX 262S or 522S Rear Air Suspension (10" Ride Height)          | 60665-011    | ... | ... | 010 | 85967 | ...   |
| 12 - 16 | Models with Neway AD-123 or AD-246 Models Air Suspension with<br>- Shock stamping              | 90045068     | ... | ... | -10 | ...   | 89441 |
|         |  | 90045099     | ... | ... | 010 | 85906 | 89407 |
|         |  | 90045132     | ... | ... | 010 | 85909 | ...   |
| 12 - 17 | Models with Neway ADZ Rear Suspension  | 471700004423 | ... | ... | 010 | 85109 | ...   |
|         |  | 90045605     | ... | ... | 010 | 85109 | ...   |
| 12 - 17 | Models with Reyco 102 or 79KB Suspension (Drive Axle)  | 16725-01     | ... | ... | 010 | 83126 | ...   |
|         |  | 19495-01     | ... | ... | 010 | 83126 | ...   |

**T470**

|         |  |               |     |       |       |       |       |
|---------|--|---------------|-----|-------|-------|-------|-------|
| 10 - 18 | Models with 12,000 to 20,000 lb Taperleaf Front Suspension   | 665858        | 010 | 85070 | 89459 | ...   | ...   |
|         |  | B71-1001      | 010 | 85070 | 89459 | ...   | ...   |
| 10 - 19 | Models with 21,000 to 23,000 lb Reyco Spring Suspension  | 19495-01      | ... | ...   | 010   | 83126 | 89440 |
|         |  | TK19679       | ... | ...   | 010   | 83126 | 89440 |
| 10 - 16 | Models with Air Glide 230 (AG230) Rear Air Suspension  | 671656        | ... | ...   | 01-   | 85985 | ...   |
|         |  | C71-1013      | ... | ...   | 01-   | 85985 | ...   |
| 10 - 17 | Models with Air Glide 380 (AG380) Rear Air Suspension  | C71-1002      | ... | ...   | 010   | 85067 | 89451 |
|         |  | C71-1016      | ... | ...   | 010   | 85067 | 89451 |
|         |  | C71-6015      | ... | ...   | 010   | 85067 | 89451 |
| 10 - 17 | Models with Air Glide 400 (AG400) Rear Air Suspension  | 671962        | ... | ...   | 01-   | 85936 | 89456 |
|         |  | C71-1014      | ... | ...   | 01-   | 85936 | 89456 |
| 12 - 19 | Models with Air Glide 400L (AG400L) Rear Air Suspension  | C71-1011      | ... | ...   | -1-   | 85069 | 89455 |
|         |  | C71-1017      | ... | ...   | -1-   | 85069 | 89455 |
| 10 - 19 | Models with Air Glide 460 (AG460) Rear Air Suspension  | 671963        | ... | ...   | 01-   | 85937 | ...   |
|         |  | C71-1015      | ... | ...   | 01-   | 85937 | ...   |
|         |  | C71-1015 PLUS | ... | ...   | 01-   | 85937 | ...   |
| 10 - 18 | Models with Chalmers 40,000 lb Rear Suspension   | 665174        | ... | ...   | 010   | 85060 | ...   |
| 10 - 16 | Models with Hendrickson HAS - 230 Rear Air Suspension  | 60670-005     | ... | ...   | 010   | 83137 | ...   |
| 10 - 19 | Models with Hendrickson HMX 400/460 Haulmax with 16.5" Saddle  | 60680-004     | ... | ...   | 01-   | 83143 | ...   |
|         |  | 60680-004L    | ... | ...   | 01-   | 83143 | ...   |
| 10 - 18 | Models with Hendrickson HMX 400/460 Haulmax with 17.5" & 18.5" Saddle                                      | 60680-005     | ... | ...   | 01-   | 83142 | ...   |
|         |  | 60680-005L    | ... | ...   | 01-   | 83142 | ...   |
| 10 - 18 | Models with Hendrickson Primaax 230, 232, 460, 462, 690 and 692 Air Suspension (8-1/2" to 10" Ride Height) | 60657-003     | ... | ...   | 010   | 85072 | ...   |
|         |  | 60657-003L    | ... | ...   | 010   | 85072 | ...   |
| 10 - 16 | Models with Neway AD-123 or AD-246 Models Air Suspension with<br>- Shock stamping                          | 90045068      | ... | ...   | -10   | ...   | 89441 |
|         |  | 90045099      | ... | ...   | 010   | 85906 | 89407 |
|         |  | 90045132      | ... | ...   | 010   | 85909 | ...   |
| 10 - 17 | Models with Neway ADZ Rear Suspension  | 471700004423  | ... | ...   | 010   | 85109 | ...   |
|         |  | 90045605      | ... | ...   | 010   | 85109 | ...   |
| 10 - 18 | Models with Reyco 102 or 79KB Suspension (Drive Axle)  | 16725-01      | ... | ...   | 010   | 83126 | ...   |
|         |  | 19495-01      | ... | ...   | 010   | 83126 | ...   |

**APPLICATION GUIDE - TRUCKS, TRAILERS, AND BUSES**

| Year<br>Año<br>Année | Model<br>Modelo<br>Modèle | OEM # | Front   |   | Rear  |   |
|----------------------|---------------------------|-------|---|---|---|---|
|                      |                           |       |  |  |  |  |
|                      |                           |       | Fleetline   | GasSLX  | Fleetline   | GasSLX  |

**KENWORTH(Cont'd.)**

**T600, T600A, T600B, T602(Cont'd.)**

|         |  |          |     |       |       |     |       |       |
|---------|--|----------|-----|-------|-------|-----|-------|-------|
|         | All with Air Glide 100 Suspension with 8 air bags, 4 units required                | K374-29  |     | ...   | ...   | - - | 85310 | 89423 |
|         |  | K374-32  |     | ...   | ...   | - - | 85310 | 89423 |
|         | All with Air Glide 200 with 40,000 lb Suspension with 8 air bags, 4 units required | 665903   |     | ...   | ...   | - - | 85900 | ...   |
|         |  | 665944   |     | ...   | ...   | - - | 85900 | ...   |
|         |  | 70701    |     | ...   | ...   | - - | 85900 | ...   |
|         | All with Air Glide 200 with 46,000 lb Suspension with 8 air bags, 4 units required | 665906   |     | ...   | ...   | - - | 85902 | ...   |
|         |  | 665945   |     | ...   | ...   | - - | 85902 | ...   |
| 2006 -  | Models with 13,000 lb Front Axle   | 665858   | 0 0 | 85070 | 89459 |     | ...   | ...   |
|         |  | B71-1001 | 0 0 | 85070 | 89459 |     | ...   | ...   |
| 01 - 07 | Models with Air Glide 380 (AG380) Rear Air Suspension                              | C71-1002 |     | ...   | ...   | 0 0 | 85067 | 89451 |
|         |  | C71-1016 |     | ...   | ...   | 0 0 | 85067 | 89451 |
| 01 - 07 | Models with Air Glide 400 (AG400) Rear Air Suspension                              | 671962   |     | ...   | ...   | 0 - | 85936 | 89456 |
|         |  | C71-1014 |     | ...   | ...   | 0 - | 85936 | 89456 |
| - 2007  | Models with Air Glide 460 (AG460) Rear Air Suspension                              | 671963   |     | ...   | ...   | 0 - | 85937 | ...   |
|         | Models with Hendrickson Rear Air Suspension  | 47902-19 |     | ...   | ...   | 0 0 | 83123 | 89405 |
|         |  | 47902-24 |     | ...   | ...   | 0 0 | 83137 | ...   |
|         | Models with Multiple Leaf Springs on Front Axle                                    | B71-1003 | 0 0 | 83312 | 89409 |     | ...   | ...   |
|         |  | K374-3   | 0 0 | 83312 | 89409 |     | ...   | ...   |
|         |  | K374-33  | 0 0 | 83312 | 89409 |     | ...   | ...   |
|         | Models with Reyco 102 or 79KB Suspension (Drive Axle)                              | 16725-01 |     | ...   | ...   | 0 0 | 83126 | ...   |
|         |  | 19495-01 |     | ...   | ...   | 0 0 | 83126 | ...   |
| - 2007  | Models with Reyco 1209 or 1212 Suspension (Steer Axle)                             | 19495-01 | 0 0 | 83126 | 89440 |     | ...   | ...   |
| 86 - 07 | Models with Taper Leaf Springs on Front Axle                                       | B71-1002 | 0 0 | 85001 | 89410 |     | ...   | ...   |
|         |  | K374-16  | 0 0 | 85001 | 89410 |     | ...   | ...   |
|         |  | K374-26  | 0 0 | 85001 | 89410 |     | ...   | ...   |
|         |  | K374-27  | 0 0 | 85001 | 89410 |     | ...   | ...   |

**T660**

|         |   |               |     |       |       |     |       |       |
|---------|---|---------------|-----|-------|-------|-----|-------|-------|
|         | Carhauler with O.E.M. Number                            | K374-36       | 0 0 | ...   | 89432 |     | ...   | ...   |
| 08 - 18 | Models with 12,000 or 13,200 lb Front Axle              | 665858        | 0 0 | 85070 | 89459 |     | ...   | ...   |
|         |   | B71-1001      | 0 0 | 85070 | 89459 |     | ...   | ...   |
| 08 - 17 | Models with 40,000 lb Low Air leaf Suspension           | C71-1011      |     | ...   | ...   | - - | 85069 | 89455 |
|         |   | C71-1017      |     | ...   | ...   | - - | 85069 | 89455 |
| 08 - 17 | Models with Air Glide 230 (AG230) Rear Air Suspension   | 671656        |     | ...   | ...   | 0 - | 85985 | ...   |
|         |   | C71-1013      |     | ...   | ...   | 0 - | 85985 | ...   |
| 08 - 17 | Models with Air Glide 380 (AG380) Rear Air Suspension   | C71-1002      |     | ...   | ...   | 0 0 | 85067 | 89451 |
|         |   | C71-1016      |     | ...   | ...   | 0 0 | 85067 | 89451 |
|         |   | C71-6015      |     | ...   | ...   | 0 0 | 85067 | 89451 |
| 13 - 17 | Models with Air Glide 400 (AG400) Rear Air Suspension   | 671962        |     | ...   | ...   | 0 - | 85936 | 89456 |
|         |   | C71-1014      |     | ...   | ...   | 0 - | 85936 | 89456 |
| 08 - 17 | Models with Air Glide 400L (AG400L) Rear Air Suspension | 03-08781      |     | ...   | ...   | - - | 85069 | 89455 |
|         |   | C71-1011      |     | ...   | ...   | - - | 85069 | 89455 |
|         |   | C71-1017      |     | ...   | ...   | - - | 85069 | 89455 |
| 08 - 17 | Models with Air Glide 460 (AG460) Rear Air Suspension   | 671963        |     | ...   | ...   | 0 - | 85937 | ...   |
|         |   | C71-1015      |     | ...   | ...   | 0 - | 85937 | ...   |
|         |   | C71-1015 PLUS |     | ...   | ...   | 0 - | 85937 | ...   |
| 13 - 17 | Models with O.E.M. Number                               | B71-6012      | 0 0 | 85119 | ...   |     | ...   | ...   |

**T680**

|         |   |          |     |       |       |     |       |       |
|---------|---|----------|-----|-------|-------|-----|-------|-------|
| 13 - 14 | Models with 10,000 lb to 13,200 lb Front Axle                                 | B71-6005 | 0 0 | 85084 | 89460 |     | ...   | ...   |
| 14 - 19 | Models with 10,000 lb to 14,600 lb Taperleaf Springs and Set Back Front Axles | B71-6019 | 0 0 | 85989 | ...   |     | ...   | ...   |
| 14 - 19 | Models with 16,000 lb to 20,000 lb Taperleaf Springs and Set Back Front Axles | B71-6020 | 0 0 | 85989 | ...   |     | ...   | ...   |
| 13 - 19 | Models with 21,000 to 23,000 lb Reyco Spring Suspension                       | 19495-01 |     | ...   | ...   | 0 0 | 83126 | 89440 |

## APPLICATION GUIDE - TRUCKS, TRAILERS, AND BUSES

| Year<br>Año<br>Année | Model<br>Modelo<br>Modèle | OEM # | Front     |        |  | Rear |  |  |
|----------------------|---------------------------|-------|-----------|--------|--|------|--|--|
|                      |                           |       |           |        |  |      |  |  |
|                      |                           |       | Fleetline | GasSLX |  |      |  |  |

### KENWORTH(Cont'd.)

#### T680(Cont'd.)

|         |  |               |     |       |     |     |        |       |
|---------|--|---------------|-----|-------|-----|-----|--------|-------|
| 13 - 19 | Models with 21,000 to 23,000 lb Reyco Spring Suspension  | TK19679       |     | ...   | ... | 010 | 83126  | 89440 |
| 13 - 19 | Models with Air Glide 380 (AG380) Rear Air Suspension  | C71-1002      |     | ...   | ... | 010 | 85067  | 89451 |
|         |  | C71-1016      |     | ...   | ... | 010 | 85067  | 89451 |
|         |  | C71-6015      |     | ...   | ... | 010 | 85067  | 89451 |
| 13 - 19 | Models with Air Glide 400 (AG400) Rear Air Suspension  | 671962        |     | ...   | ... | 01- | 85936  | 89456 |
|         |  | C71-1014      |     | ...   | ... | 01- | 85936  | 89456 |
| 13 - 19 | Models with Air Glide 400L (AG400L) Rear Air Suspension  | C71-1011      |     | ...   | ... | -1- | 85069  | 89455 |
|         |  | C71-1017      |     | ...   | ... | -1- | 85069  | 89455 |
| 13 - 19 | Models with Air Glide 460 (AG460) Rear Air Suspension  | 671963        |     | ...   | ... | 01- | 85937  | ...   |
|         |  | C71-1015      |     | ...   | ... | 01- | 85937  | ...   |
|         |  | C71-1015 PLUS |     | ...   | ... | 01- | 85937  | ...   |
| 13 - 19 | Models with Hendrickson HMX 400/460 Haulmax with 16.5" Saddle  | 60680-004     |     | ...   | ... | 01- | 83143  | ...   |
|         |  | 60680-004L    |     | ...   | ... | 01- | 83143  | ...   |
| 13 - 19 | Models with Hendrickson HMX 400/460 Haulmax with 17.5" & 18.5" Saddle  | 60680-005     |     | ...   | ... | 01- | 83142  | ...   |
|         |  | 60680-005L    |     | ...   | ... | 01- | 83142  | ...   |
| 13 - 19 | Models with Hendrickson Primaax EX 462 Air Suspensions<br>Standard with 12 1/2" - 14 3/8" - 15 1/2" Ride Height<br>Standard with 8 1/2" to 10" Ride Height | 60665-011     |     | ...   | ... | 010 | 85967  | ...   |
|         |  | 60657-003     |     | ...   | ... | 010 | 85072  | ...   |
|         |  | 60657-003L    |     | ...   | ... | 010 | 85072  | ...   |
| 13 - 19 | Models with Neway ADZ Rear Suspension  | 471700004423  |     | ...   | ... | 010 | 85109  | ...   |
|         |  | 90045605      |     | ...   | ... | 010 | 85109  | ...   |
| 13 - 18 | Models with O.E.M. Number  | B71-6012      | 010 | 85119 | ... |     | ...    |       |
| 13 - 19 | Models with Reyco 102 or 79KB Suspension (Drive Axle)  | 16725-01      |     | ...   | ... | 010 | 83126  | ...   |
|         |  | 19495-01      |     | ...   | ... | 010 | 83126  | ...   |
| 13 - 19 | Models with Watson & Chalin SL Series Steerable Lift Axle (8,000 to 13,500 lb)   | 11418         |     | ...   | ... | 010 | 646177 | ...   |





#### T700

|         |   |          |     |       |       |     |       |       |
|---------|---|----------|-----|-------|-------|-----|-------|-------|
| 11 - 16 | Models with 13,000 lb Front Axle                        | 665858   | 010 | 85070 | 89459 |     | ...   | ...   |
|         |   | B71-1001 | 010 | 85070 | 89459 |     | ...   | ...   |
| 11 - 16 | Models with Air Glide 230 (AG230) Rear Air Suspension   | 671656   |     | ...   | ...   | 01- | 85985 | ...   |
|         |   | C71-1013 |     | ...   | ...   | 01- | 85985 | ...   |
| 11 - 16 | Models with Air Glide 380 (AG380) Rear Air Suspension   | C71-1002 |     | ...   | ...   | 010 | 85067 | 89451 |
|         |   | C71-1016 |     | ...   | ...   | 010 | 85067 | 89451 |
|         |   | C71-6015 |     | ...   | ...   | 010 | 85067 | 89451 |
| 11 - 16 | Models with Air Glide 400 (AG400) Rear Air Suspension   | 671962   |     | ...   | ...   | 01- | 85936 | 89456 |
|         |   | C71-1014 |     | ...   | ...   | 01- | 85936 | 89456 |
| 11 - 16 | Models with Air Glide 400L (AG400L) Rear Air Suspension | 03-08781 |     | ...   | ...   | -1- | 85069 | 89455 |
|         |   | C71-1011 |     | ...   | ...   | -1- | 85069 | 89455 |
|         |   | C71-1017 |     | ...   | ...   | -1- | 85069 | 89455 |

#### T800, T800B, T800B(8x4), T800SH, T800H, T800W

|         |  |          |     |       |       |     |       |       |
|---------|--|----------|-----|-------|-------|-----|-------|-------|
|         | All with Air Glide 100 Suspension with 8 air bags, 4 units required                | K374-29  |     | ...   | ...   | -1- | 85310 | 89423 |
|         |  | K374-32  |     | ...   | ...   | -1- | 85310 | 89423 |
|         | All with Air Glide 200 with 40,000 lb Suspension with 8 air bags, 4 units required | 665903   |     | ...   | ...   | -1- | 85900 | ...   |
|         |  | 665944   |     | ...   | ...   | -1- | 85900 | ...   |
|         |  | 70701    |     | ...   | ...   | -1- | 85900 | ...   |
|         | All with Air Glide 200 with 46,000 lb Suspension with 8 air bags, 4 units required | 665906   |     | ...   | ...   | -1- | 85902 | ...   |
|         |  | 665945   |     | ...   | ...   | -1- | 85902 | ...   |
| 05 - 18 | Models with 12,000 to 20,000 lb Front Axles  | 665858   | 010 | 85070 | 89459 |     | ...   | ...   |
|         |  | B71-1001 | 010 | 85070 | 89459 |     | ...   | ...   |
| 06 - 18 | Models with Air Glide 230 (AG230) Rear Air Suspension                              | 671656   |     | ...   | ...   | 01- | 85985 | ...   |
|         |  | C71-1013 |     | ...   | ...   | 01- | 85985 | ...   |
| 01 - 18 | Models with Air Glide 380 (AG380) Rear Air Suspension                              | C71-1002 |     | ...   | ...   | 010 | 85067 | 89451 |

**APPLICATION GUIDE - TRUCKS, TRAILERS, AND BUSES**

| Year<br>Año<br>Année | Model<br>Modelo<br>Modèle | OEM # | Front   |   | Rear  |   |
|----------------------|---------------------------|-------|---|---|---|---|
|                      |                           |       |  |  |  |  |
|                      |                           |       | Fleetline   | GasSLX  | Fleetline   | GasSLX  |

**KENWORTH(Cont'd.)**





**T800, T800B, T800B(8x4), T800SH, T800H, T800W(Cont'd.)**

|         |  |               |       |       |       |     |       |       |
|---------|--|---------------|-------|-------|-------|-----|-------|-------|
| 01 - 18 | Models with Air Glide 380 (AG380) Rear Air Suspension  | C71-1016      |       | ...   | ...   | 010 | 85067 | 89451 |
|         |  | C71-6015      |       | ...   | ...   | 010 | 85067 | 89451 |
| 07 - 18 | Models with Air Glide 400 (AG400) Rear Air Suspension  | 671962        |       | ...   | ...   | 01- | 85936 | 89456 |
|         |  | C71-1014      |       | ...   | ...   | 01- | 85936 | 89456 |
| 14 - 19 | Models with Air Glide 400L (AG400L) Rear Air Suspension  | C71-1017      |       | ...   | ...   | -1- | 85069 | 89455 |
| 07 - 19 | Models with Air Glide 460 (AG460) Rear Air Suspension  | 671963        |       | ...   | ...   | 01- | 85937 | ...   |
|         |  | C71-1015      |       | ...   | ...   | 01- | 85937 | ...   |
|         |  | C71-1015 PLUS |       | ...   | ...   | 01- | 85937 | ...   |
| 87 - 18 | Models with Chalmers 40,000 lb Rear Suspension   | 665174        |       | ...   | ...   | 010 | 85060 | ...   |
| 02 - 19 | Models with Hendrickson HMX 460 Haulmax with 16.5" Saddle                                      | 60680-004     |       | ...   | ...   | 01- | 83143 | ...   |
|         |  | 60680-004L    |       | ...   | ...   | 01- | 83143 | ...   |
| 02 - 19 | Models with Hendrickson HMX 460 Haulmax with 17.5" & 18.5" Saddle                              | 60680-005     |       | ...   | ...   | 01- | 83142 | ...   |
|         |  | 60680-005L    |       | ...   | ...   | 01- | 83142 | ...   |
| 10 - 18 | Models with Hendrickson Primaax EX 232, 462 and 692 Air Suspension (8-1/2" to 10" Ride Height) | 60657-003     |       | ...   | ...   | 010 | 85072 | ...   |
|         |  | 60657-003L    |       | ...   | ...   | 010 | 85072 | ...   |
|         | Models with Hendrickson Rear Air Suspension  | 47902-19      |       | ...   | ...   | 010 | 83123 | 89405 |
|         |  | 47902-24      |       | ...   | ...   | 010 | 83137 | ...   |
|         | Models with Multiple Leaf Springs on Front Axle  | B71-1003      | 010   | 83312 | 89409 |     | ...   | ...   |
| K374-3  |  | 010           | 83312 | 89409 |       | ... | ...   |       |
| K374-33 |  | 010           | 83312 | 89409 |       | ... | ...   |       |
| - 2019  | Models with Neway ADZ Rear Suspension  | 471700004423  |       | ...   | ...   | 010 | 85109 | ...   |
|         |  | 90045605      |       | ...   | ...   | 010 | 85109 | ...   |
|         | Models with Neway Rear Air Suspension  | 90044089      |       | ...   | ...   | 010 | 83124 | 89407 |
| -2018   | Models with Neway Rear Air Suspension (AD123-, AD246- )  | 90045132      |       | ...   | ...   | 010 | 85909 | ...   |
| -2018   | Models with Reyco 102 or 79KB Suspension (Drive Axle)  | 16725-01      |       | ...   | ...   | 010 | 83126 | ...   |
|         |  | 19495-01      |       | ...   | ...   | 010 | 83126 | ...   |
| - 2019  | Models with Reyco 1209 or 1212 Suspension (Steer Axle)   | 19495-01      | 010   | 83126 | 89440 |     | ...   | ...   |
| 88 - 18 | Models with Taper Leaf Springs on Front Axle   | B71-1002      | 010   | 85001 | 89410 |     | ...   | ...   |
|         |  | K374-16       | 010   | 85001 | 89410 |     | ...   | ...   |
|         |  | K374-26       | 010   | 85001 | 89410 |     | ...   | ...   |
|         |  | K374-27       | 010   | 85001 | 89410 |     | ...   | ...   |
|         | Models with Torsion Bar Bogey (2 rear axles) and KW Air Ride Suspension (with 4 air bags)      | K374-28       |       | ...   | ...   | 010 | 85314 | 89425 |
|         |  | K374-4        |       | ...   | ...   | 010 | 85314 | 89425 |

**T880**

|         |   |               |     |       |     |     |       |       |
|---------|---|---------------|-----|-------|-----|-----|-------|-------|
| 14 - 19 | Models with 10,000 lb to 14,600 lb Taperleaf Springs and Set Back Front Axles | B71-6019      | 010 | 85989 | ... |     | ...   | ...   |
| 14 - 19 | Models with 16,000 lb to 20,000 lb Taperleaf Springs and Set Back Front Axles | B71-6020      | 010 | 85989 | ... |     | ...   | ...   |
| 14 - 19 | Models with Air Glide 380 (AG380) Rear Air Suspension                         | C71-1002      |     | ...   | ... | 010 | 85067 | 89451 |
|         |   | C71-1016      |     | ...   | ... | 010 | 85067 | 89451 |
|         |   | C71-6015      |     | ...   | ... | 010 | 85067 | 89451 |
| 14 - 19 | Models with Air Glide 400 (AG400) Rear Air Suspension                         | 671962        |     | ...   | ... | 01- | 85936 | 89456 |
|         |   | C71-1014      |     | ...   | ... | 01- | 85936 | 89456 |
| 14 - 19 | Models with Air Glide 400L (AG400L) Rear Air Suspension                       | C71-1017      |     | ...   | ... | -1- | 85069 | 89455 |
| 14 - 19 | Models with Air Glide 460 (AG460) Rear Air Suspension                         | 671963        |     | ...   | ... | 01- | 85937 | ...   |
|         |   | C71-1015      |     | ...   | ... | 01- | 85937 | ...   |
|         |   | C71-1015 PLUS |     | ...   | ... | 01- | 85937 | ...   |
| 14 - 19 | Models with Hendrickson HMX 400/460 Haulmax with 16.5" Saddle                 | 60680-004     |     | ...   | ... | 01- | 83143 | ...   |
|         |   | 60680-004L    |     | ...   | ... | 01- | 83143 | ...   |
| 14 - 19 | Models with Hendrickson HMX 400/460 Haulmax with 17.5" & 18.5" Saddle         | 60680-005     |     | ...   | ... | 01- | 83142 | ...   |
|         |   | 60680-005L    |     | ...   | ... | 01- | 83142 | ...   |

**APPLICATION GUIDE - TRUCKS, TRAILERS, AND BUSES**

| Year<br>Año<br>Année | Model<br>Modelo<br>Modèle | OEM # | Front   |  |   | Rear  |           |        |
|----------------------|---------------------------|-------|---|--|---|---|-----------|--------|
|                      |                           |       |  |  |  |  | Fleetline | GasSLX |

**KENWORTH(Cont'd.)**

**T880(Cont'd.)**

|         |  |              |     |       |     |     |        |     |
|---------|--|--------------|-----|-------|-----|-----|--------|-----|
| 14 - 19 | Models with Hendrickson Primaax EX 462 Air Suspensions (Standard with 12 1/2" - 14 3/8" - 15 1/2" Ride Height) | 60665-011    |     | ...   | ... | 010 | 85967  | ... |
| 14 - 19 | Models with Hendrickson Primaax EX 462 Air Suspensions (Standard with 8 1/2" to 10" Ride Height)               | 60657-003    |     | ...   | ... | 010 | 85072  | ... |
|         |  | 60657-003L   |     | ...   | ... | 010 | 85072  | ... |
| 14 - 19 | Models with Neway ADZ Rear Suspension  | 471700004423 |     | ...   | ... | 010 | 85109  | ... |
|         |  | 90045605     |     | ...   | ... | 010 | 85109  | ... |
|         | Models with O.E.M. Number  | C71-1015A    |     | ...   | ... | 01- | 85937  | ... |
| 14 - 16 | Models with O.E.M. Number  | B71-6012     | 010 | 85119 | ... |     | ...    | ... |
| 14 - 19 | Models with Reyco 102 or 79KB Suspension (Drive Axle)  | 16725-01     |     | ...   | ... | 010 | 83126  | ... |
|         |  | 19495-01     |     | ...   | ... | 010 | 83126  | ... |
| 14 - 19 | Models with Watson & Chalin SL Series Steerable Lift Axle (8,000 to 13,500 lb)                                 | 11418        |     | ...   | ... | 010 | 646177 | ... |





**T2000**

|         |  |          |     |       |       |     |       |       |
|---------|--|----------|-----|-------|-------|-----|-------|-------|
| 97 - 11 | All with Air Glide 100 Suspension with 8 air bags, 4 units required                | K374-29  |     | ...   | ...   | - - | 85310 | 89423 |
|         |  | K374-32  |     | ...   | ...   | - - | 85310 | 89423 |
| 97 - 11 | All with Air Glide 200 with 40,000 lb Suspension with 8 air bags, 4 units required | 665903   |     | ...   | ...   | - - | 85900 | ...   |
|         |  | 665944   |     | ...   | ...   | - - | 85900 | ...   |
|         |  | 70701    |     | ...   | ...   | - - | 85900 | ...   |
| 97 - 11 | All with Air Glide 200 with 46,000 lb Suspension with 8 air bags, 4 units required | 665906   |     | ...   | ...   | - - | 85902 | ...   |
|         |  | 665945   |     | ...   | ...   | - - | 85902 | ...   |
| 06 - 11 | Models with 13,000 lb Front Axle   | 665858   | 010 | 85070 | 89459 |     | ...   | ...   |
|         |  | B71-1001 | 010 | 85070 | 89459 |     | ...   | ...   |
| 01 - 11 | Models with Air Glide 380 (AG380) Rear Air Suspension                              | C71-1002 |     | ...   | ...   | 010 | 85067 | 89451 |
|         |  | C71-1016 |     | ...   | ...   | 010 | 85067 | 89451 |
| 05 - 11 | Models with Air Glide 400 (AG400) Rear Air Suspension                              | 671962   |     | ...   | ...   | 01- | 85936 | 89456 |
|         |  | C71-1014 |     | ...   | ...   | 01- | 85936 | 89456 |
| 05 - 11 | Models with Air Glide 460 (AG460) Rear Air Suspension                              | 671963   |     | ...   | ...   | 01- | 85937 | ...   |
|         | Models with Multiple Leaf Springs on Front Axle                                    | B71-1003 | 010 | 83312 | 89409 |     | ...   | ...   |
|         |  | K374-3   | 010 | 83312 | 89409 |     | ...   | ...   |
|         |  | K374-33  | 010 | 83312 | 89409 |     | ...   | ...   |
| 97 - 11 | Models with Taper Leaf Springs on Front Axle                                       | B71-1002 | 010 | 85001 | 89410 |     | ...   | ...   |
|         |  | K374-16  | 010 | 85001 | 89410 |     | ...   | ...   |
|         |  | K374-26  | 010 | 85001 | 89410 |     | ...   | ...   |
|         |  | K374-27  | 010 | 85001 | 89410 |     | ...   | ...   |

**W900, W900B, W900L, W900S**

|         |  |          |     |       |       |     |       |       |
|---------|--|----------|-----|-------|-------|-----|-------|-------|
|         | All with Air Glide 100 Suspension with 8 air bags, 4 units required                | K374-29  |     | ...   | ...   | - - | 85310 | 89423 |
|         |  | K374-32  |     | ...   | ...   | - - | 85310 | 89423 |
|         | All with Air Glide 200 with 40,000 lb Suspension with 8 air bags, 4 units required | 665903   |     | ...   | ...   | - - | 85900 | ...   |
|         |  | 665944   |     | ...   | ...   | - - | 85900 | ...   |
|         |  | 70701    |     | ...   | ...   | - - | 85900 | ...   |
|         | All with Air Glide 200 with 46,000 lb Suspension with 8 air bags, 4 units required | 665906   |     | ...   | ...   | - - | 85902 | ...   |
|         |  | 665945   |     | ...   | ...   | - - | 85902 | ...   |
|         | Carhauler with O.E.M. Number   | K374-36  | 010 | ...   | 89432 |     | ...   | ...   |
| 05 - 18 | Models with 12,000 or 13,200 lb Front Axle   | 665858   | 010 | 85070 | 89459 |     | ...   | ...   |
|         |  | B71-1001 | 010 | 85070 | 89459 |     | ...   | ...   |
| 2010    | Models with 46,000 lb Neway Rear Air Suspension                                    | 90045132 |     | ...   | ...   | 010 | 85909 | ...   |
| 06 - 18 | Models with Air Glide 230 (AG230) Rear Air Suspension                              | 671656   |     | ...   | ...   | 01- | 85985 | ...   |
|         |  | C71-1013 |     | ...   | ...   | 01- | 85985 | ...   |
| 01 - 18 | Models with Air Glide 380 (AG380) Rear Air Suspension                              | C71-1002 |     | ...   | ...   | 010 | 85067 | 89451 |
|         |  | C71-1016 |     | ...   | ...   | 010 | 85067 | 89451 |
|         |  | C71-6015 |     | ...   | ...   | 010 | 85067 | 89451 |

**APPLICATION GUIDE - TRUCKS, TRAILERS, AND BUSES**

| Year<br>Año<br>Année | Model<br>Modelo<br>Modèle | OEM # | Front   |   | Rear  |   |
|----------------------|---------------------------|-------|---|---|---|---|
|                      |                           |       |  |  |  |  |
|                      |                           |       | Fleetline   | GasSLX  | Fleetline   | GasSLX  |

**KENWORTH(Cont'd.)**





**W900, W900B, W900L, W900S(Cont'd.)**

|         |   |               |     |       |       |     |       |       |
|---------|---|---------------|-----|-------|-------|-----|-------|-------|
| 05 - 18 | Models with Air Glide 400 (AG400) Rear Air Suspension                                     | 671962        |     | ...   | ...   | 01- | 85936 | 89456 |
|         |   | C71-1014      |     | ...   | ...   | 01- | 85936 | 89456 |
| 08 - 19 | Models with Air Glide 400L (AG400L) Rear Air Suspension                                   | C71-1011      |     | ...   | ...   | -1- | 85069 | 89455 |
|         |   | C71-1017      |     | ...   | ...   | -1- | 85069 | 89455 |
| 05 - 19 | Models with Air Glide 460 (AG460) Rear Air Suspension                                     | 671963        |     | ...   | ...   | 01- | 85937 | ...   |
|         |   | C71-1015      |     | ...   | ...   | 01- | 85937 | ...   |
|         |   | C71-1015 PLUS |     | ...   | ...   | 01- | 85937 | ...   |
| - 2019  | Models with Hendrickson HMX 400/460 Haulmax with 16.5" Saddle                             | 60680-004     |     | ...   | ...   | 01- | 83143 | ...   |
|         |   | 60680-004L    |     | ...   | ...   | 01- | 83143 | ...   |
| - 2018  | Models with Hendrickson HMX 400/460 Haulmax with 17.5" & 18.5" Saddle                     | 60680-005     |     | ...   | ...   | 01- | 83142 | ...   |
|         |   | 60680-005L    |     | ...   | ...   | 01- | 83142 | ...   |
|         | Models with Hendrickson Rear Air Suspension   | 47902-19      |     | ...   | ...   | 010 | 83123 | 89405 |
|         |   | 47902-24      |     | ...   | ...   | 010 | 83137 | ...   |
|         | Models with Multiple Leaf Springs on Front Axle   | B71-1003      | 010 | 83312 | 89409 |     | ...   | ...   |
|         |   | K374-3        | 010 | 83312 | 89409 |     | ...   | ...   |
|         |   | K374-33       | 010 | 83312 | 89409 |     | ...   | ...   |
| - 2018  | Models with Neway ADZ Rear Suspension   | 471700004423  |     | ...   | ...   | 010 | 85109 | ...   |
|         |   | 90045605      |     | ...   | ...   | 010 | 85109 | ...   |
| - 2018  | Models with Reyco 102 or 79KB Suspension (Drive Axle)                                     | 16725-01      |     | ...   | ...   | 010 | 83126 | ...   |
|         |   | 19495-01      |     | ...   | ...   | 010 | 83126 | ...   |
| - 2019  | Models with Reyco 1209 or 1212 Suspension (Steer Axle)                                    | 19495-01      | 010 | 83126 | 89440 |     | ...   | ...   |
| 87 - 19 | Models with Taper Leaf Springs on Front Axle  | B71-1002      | 010 | 85001 | 89410 |     | ...   | ...   |
|         |   | K374-16       | 010 | 85001 | 89410 |     | ...   | ...   |
|         |   | K374-26       | 010 | 85001 | 89410 |     | ...   | ...   |
|         |   | K374-27       | 010 | 85001 | 89410 |     | ...   | ...   |
|         | Models with Torsion Bar Bogey (2 rear axles) and KW Air Ride Suspension (with 4 air bags) | K374-28       |     | ...   | ...   | 010 | 85314 | 89425 |
|         |   | K374-4        |     | ...   | ...   | 010 | 85314 | 89425 |

**Additional O.E.M. Interchanges**

|           |   |                  |     |       |       |     |       |       |
|-----------|---|------------------|-----|-------|-------|-----|-------|-------|
|           | Models with Hendrickson Primaax 260 or 520 Rear Air Suspension (10" Ride Height-Disc Brakes only) | 60665-015        |     | ...   | ...   | 010 | 85966 | ...   |
|           | Models with Hendrickson Primaax 260 or 520 Rear Air Suspension (10" Ride Height-Drum Brakes only) | 60665-013        |     | ...   | ...   | 010 | 85965 | ...   |
|           | Models with Hendrickson Primaax EX 262 or 522 Rear Air Suspension (10" Ride Height)               | 60665-013        |     | ...   | ...   | 010 | 85965 | ...   |
|           | Models with Hendrickson Primaax EX 262S or 522S Rear Air Suspension (10" Ride Height)             | 60665-011        |     | ...   | ...   | 010 | 85967 | ...   |
|           | OE PLUS Shock Stamping Number   | 02-02736PLUS     | 010 | 85302 | 89420 |     | ...   | ...   |
|           |   | 02-02737PLUS     | 010 | 85062 | 89408 |     | ...   | ...   |
|           |   | 02-02738PLUS     | 010 | 85012 | 89413 |     | ...   | ...   |
|           |   | 02-02739PLUS     | 010 | 85013 | 89414 |     | ...   | ...   |
|           |   | 03-04176PLUS     |     | ...   | ...   | 010 | 85308 | 89422 |
|           |   | 03-06084PLUS     |     | ...   | ...   | -10 | 85033 | 89427 |
|           |   | 03-07421PLUS     |     | ...   | ...   | -10 | 85311 | 89424 |
|           |   | 03-07423PLUS     |     | ...   | ...   | -10 | 85033 | 89427 |
|           |   | 10-12032-002PLUS | 010 | 85320 | 89429 |     | ...   | ...   |
|           |   | 10-12542-000PLUS | 010 | 85901 | ...   |     | ...   | ...   |
|           |   | 16-13947-000PLUS |     | ...   | ...   | -10 | 85319 | 89428 |
|           |   | 2018987C1PLUS    |     | ...   | ...   | 010 | 85003 | 89411 |
|           |   | 47902-13PLUS     |     | ...   | ...   | 010 | 83122 | 89406 |
|           |   | 60670-005PLUS    |     | ...   | ...   | 010 | 83137 | ...   |
|           |   | 60670-008PLUS    |     | ...   | ...   | 010 | 83123 | 89405 |
|           |   | 665565PLUS       |     | ...   | ...   | 010 | 85007 | 89412 |
|           |   | 671962PLUS       |     | ...   | ...   | 01- | 85936 | 89456 |
| 70701PLUS |   | ...              | ... | -1-   | 85900 | ... |       |       |

**APPLICATION GUIDE - TRUCKS, TRAILERS, AND BUSES**

| Year<br>Año<br>Année | Model<br>Modelo<br>Modèle | OEM # | Front   |  | Rear  |   |
|----------------------|---------------------------|-------|---|--|---|---|
|                      |                           |       |  |  |  |  |
|                      |                           |       | Fleetline   | GasSLX   | Fleetline   | GasSLX  |





**KENWORTH(Cont'd.)**

**Additional O.E.M. Interchanges(Cont'd.)**

|   |              |     |       |       |       |       |       |
|---|--------------|-----|-------|-------|-------|-------|-------|
| OE PLUS Shock Stamping Number                                       | 8086053PLUS  | ... | ...   | 010   | 85047 | 89435 |       |
|   | 90044025PLUS | 010 | 83209 | 89414 | ...   | ...   |       |
|   | 90044089PLUS | ... | ...   | 010   | 83124 | 89407 |       |
|   | B71-6015     | 010 | 85012 | 89413 | ...   | ...   |       |
|   | C71-1002PLUS | ... | ...   | 010   | 85067 | 89451 |       |
|   | C71-1011PLUS | ... | ...   | -1-   | 85069 | 89455 |       |
|   | K374-26PLUS  | 010 | 85001 | 89410 | ...   | ...   |       |
|   | K374-28PLUS  | ... | ...   | 010   | 85314 | 89425 |       |
|   | K374-29PLUS  | ... | ...   | -1-   | 85310 | 89423 |       |
|   | K374-33PLUS  | 010 | 83312 | 89409 | ...   | ...   |       |
| TruckMaster Shock Stamping Number                                   | 665632       | 010 | 85013 | 89414 | ...   | ...   |       |
|   | 665633       | ... | ...   | -10   | 85033 | 89427 |       |
|   | 665783       | ... | ...   | 010   | 83123 | 89405 |       |
|   | 665784       | ... | ...   | 010   | 83122 | 89406 |       |
|   | 665785       | ... | ...   | 010   | 83137 | ...   |       |
|   | 665844       | ... | ...   | -1-   | 85069 | 89455 |       |
|   | 665918       | ... | ...   | -1-   | 85900 | ...   |       |
|   | 665926       | ... | ...   | 010   | 85047 | 89435 |       |
|   | 665927       | 010 | 85901 | ...   | ...   | ...   |       |
|   | 665928       | 010 | 85062 | 89408 | ...   | ...   |       |
|   | 665930       | 010 | 85001 | 89410 | ...   | ...   |       |
|   | 665931       | 010 | 83312 | 89409 | ...   | ...   |       |
|   | 665932       | 010 | 85012 | 89413 | ...   | ...   |       |
|   | 665950       | ... | ...   | -1-   | 85902 | ...   |       |
|   | 671052       | 010 | 85070 | 89459 | ...   | ...   |       |
|   | 671654       | ... | ...   | 01-   | 85936 | 89456 |       |
|   | 671699       | ... | ...   | 01-   | 85937 | ...   |       |
|   | 671794       | ... | ...   | 010   | 85067 | 89451 |       |
|   | 680237       | ... | 85303 | ...   | 010   | 85303 | 89422 |
|   | 680239       | ... | ...   | ...   | -1-   | 85310 | 89423 |
|   | 680240       | ... | ...   | ...   | 010   | 85302 | 89420 |
|   | 680242       | ... | ...   | ...   | 010   | 85308 | 89422 |
|   | 680253       | ... | ...   | ...   | 010   | 85314 | 89425 |
|   | 680261       | 010 | 85062 | 89408 | ...   | ...   |       |
|   | 680279       | 010 | 83209 | 89414 | ...   | ...   |       |
|   | 680280       | ... | ...   | ...   | 010   | 85906 | 89407 |
|   | 680281       | ... | ...   | ...   | 010   | 85003 | 89411 |
|   | 680283       | 01- | 85740 | ...   | ...   | ...   |       |
|   | 680303       | ... | ...   | ...   | 010   | 85007 | 89412 |
|   | 680425       | 010 | 85320 | 89429 | ...   | ...   |       |
|   | 680435       | ... | ...   | ...   | -10   | 85033 | 89427 |
|   | 680473       | ... | ...   | ...   | -10   | 85319 | 89428 |
| All with Air Glide 100 Suspension with 8 air bags, 4 units required | K374-C7      | ... | ...   | -1-   | 85310 | 89423 |       |
| Models with Multiple Leaf Springs on Front Axle                     | K374-14      | 010 | 83312 | 89409 | ...   | ...   |       |
|   | K374-5       | 010 | 83312 | 89409 | ...   | ...   |       |
| Models with O.E.M. Number   | 665453       | 010 | 85001 | 89410 | ...   | ...   |       |
|   | 665670       | 010 | 85001 | 89410 | ...   | ...   |       |
|   | 665680       | 010 | 83312 | 89409 | ...   | ...   |       |
|   | 665788       | ... | ...   | ...   | 010   | 85000 | 89436 |
|   | 665828       | ... | ...   | ...   | 010   | 85067 | 89451 |
|   | 671962SPL    | ... | ...   | ...   | 01-   | 85936 | 89456 |
|   | 675122       | 010 | 85001 | 89410 | ...   | ...   |       |
|   | 680241       | ... | ...   | ...   | -10   | 85311 | 89424 |
| 680475  | ...          | ... | ...   | 010   | 85314 | 89425 |       |



**APPLICATION GUIDE - TRUCKS, TRAILERS, AND BUSES**

| Year<br>Año<br>Année | Model<br>Modelo<br>Modèle | OEM # | Front   |   | Rear  |   |
|----------------------|---------------------------|-------|---|---|---|---|
|                      |                           |       |  |  |  |  |
|                      |                           |       | Fleetline   | GasSLX  | Fleetline   | GasSLX  |

**KENWORTH(Cont'd.)**

**Additional O.E.M. Interchanges(Cont'd.)**

|  |             |     |                |       |       |       |       |
|--|-------------|-----|----------------|-------|-------|-------|-------|
| Models with O.E.M. Number                    | 680476      | ... | ...            | - -   | 85310 | 89423 |       |
|  | 680486      | ... | ...            | - -   | 85310 | 89423 |       |
|  | 680586      | ... | ...            | - 0   | 85311 | 89424 |       |
|  | B71-6000    | 010 | 85959          | ...   | ...   | ...   |       |
|  | B71-6002    | 010 | 85012          | 89413 | ...   | ...   |       |
|  | B71-6003    | 010 | 85029          | ...   | ...   | ...   |       |
|  | B71-6007    | 010 | 85062          | 89408 | ...   | ...   |       |
|  | B71-6008    | 010 | 83312          | 89409 | ...   | ...   |       |
|  | B71-6010    | 010 | 85023 or 89415 |       |       |       |       |
|  | B71-6011    | 010 | 85062          | 89408 | ...   | ...   |       |
|  | B71-6013    | 010 | 85012          | 89413 | ...   | ...   |       |
|  | B71-6016    | 010 | 85012          | 89413 | ...   | ...   |       |
|  | B71-6017    | 010 | 85910          | ...   | ...   | ...   |       |
|  | B71-6018    | 010 | 85012          | 89413 | ...   | ...   |       |
|  | C71-1011SPL | ... | ...            | ...   | - -   | 85069 | 89455 |
|  | C71-6003    | ... | ...            | ...   | - 0   | 85988 | ...   |
|  | C71-6004    | ... | ...            | ...   | - 0   | 85343 | ...   |
|  | C71-6005    | ... | ...            | ...   | - -   | 85069 | 89455 |
|  | K374-7      | ... | ...            | ...   | - -   | 85310 | 89423 |
|  | K374-9      | ... | ...            | ...   | - -   | 85310 | 89423 |
|  | K374-C31    | 010 | 83312          | 89409 | ...   | ...   |       |
|  | R71-6006    | 010 | 83063          |       |       |       |       |
|  | R71-6007    | 010 | 83008          |       |       |       |       |
|  | R71-6008    | 010 | 83035          |       |       |       |       |
|  | S-20126     | ... | ...            | ...   | 0 0   | 85323 | 89436 |
| Models with Taper Leaf Springs on Front Axle | K374-11     | 010 | 85001          | 89410 | ...   | ...   |       |
| Additional O.E.M. Interchanges               | 3166657     | 010 | 85700          |       |       |       |       |
|  | 665092      | 010 | 83312 or 89409 |       |       |       |       |
|  | 665118      | 010 | 83312 or 89409 |       |       |       |       |
|  | K374-10     | 010 | 83362          |       |       |       |       |
|  | K374-3-1    | 010 | 83312 or 89409 |       |       |       |       |

**KENWORTH CAB SHOCKS**

**Aerocab**

|         |  |           |     |       |
|---------|--|-----------|-----|-------|
|         | Models with 38" Sleepers with Link Cabmate Models KWK1T03 or KWCSA 01-06 | 1202-1264 | 010 | 83031 |
|         | Models with 62" and 74" Sleepers with O.E.M. Number                      | 1202-1164 | 010 | 83031 |
|         | Models with 72" Sleepers with Link Cabmate Models KWK1T02 or KWCSA 01-06 | 1202-1065 | 010 | 83002 |
| 08 - 16 | Models with 86" Sleepers with O.E.M. Number                              | 1202-1286 | 010 | 83056 |
|         |  | 1202K286  | 010 | 83056 |
|         |  | T71-1003  | 010 | 83056 |

**C-500B**

|  |  |           |     |       |
|--|--|-----------|-----|-------|
|  | Models with Link Cabmate KWB500 Air Suspension | 1202-0044 | 010 | 83025 |
|--|--|-----------|-----|-------|

**COE Models**

|  |  |           |     |       |
|--|--|-----------|-----|-------|
|  | 90" and 112" E Models with Link Cabmate KWE90112-B Air Suspension                | 1202K064  | 010 | 83024 |
|  |  | R71-1005  | 010 | 83024 |
|  | Models with Link Cabmate KW1102-B Air Suspension (Does not fit Non-Sleeper cabs) | 1202-0032 | 010 | 83016 |
|  | Models with Link Cabmate KWE90112-A Air Suspension                               | 1202-0032 | 010 | 83016 |

**ICON 900**

|      |   |          |     |       |
|------|---|----------|-----|-------|
| 2016 | Models with 86" Sleepers with O.E.M. Number | T71-1003 | 010 | 83056 |
| 2016 | Models with O.E.M. Number                   | T71-1002 | 010 | 83002 |

## APPLICATION GUIDE - TRUCKS, TRAILERS, AND BUSES

| Year<br>Año<br>Année | Model<br>Modelo<br>Modèle | OEM # | Front     |        | Rear      |        |
|----------------------|---------------------------|-------|-----------|--------|-----------|--------|
|                      |                           |       |           |        |           |        |
|                      |                           |       |           |        |           |        |
|                      |                           |       | Fleetline | GasSLX | Fleetline | GasSLX |

### KENWORTH CAB SHOCKS(Cont'd.)

#### T400A(Cont'd.)

|         |   |           |     |  |       |
|---------|---|-----------|-----|--|-------|
| 06/92 - | Models with Link Cabmate Air Suspension KWB689-A with rear cab support Kenworth P/N K235-1646 | 1202-0012 | 010 |  | 83023 |
| - 05/92 | Models with Link Cabmate KWB400-A Air Suspension  | 1202-0012 | 010 |  | 83023 |
| 05/92 - | Models with Link Cabmate KWB689-B or KWB689-C Air Suspension                                  | 1201-1043 | 010 |  | 83025 |
| 06/92 - | Models with Link Cabmate KWB689-B or KWB689-C Air Suspension                                  | 1202-1043 | 010 |  | 83025 |

#### T440

|  |   |           |     |  |       |
|--|---|-----------|-----|--|-------|
|  | Models with Link Cabmate KWB689-D and Severe service crossmembers | 1201-1046 | 010 |  | 83049 |
|  |   | 1202-1046 | 010 |  | 83049 |
|  |   | 1202K046  | 010 |  | 83049 |
|  |   | R71-1004  | 010 |  | 83049 |

#### T450

|         |   |           |     |  |       |
|---------|---|-----------|-----|--|-------|
| 06/92 - | Models with Link Cabmate Air Suspension KWB689-A with rear cab support Kenworth P/N K235-1646 | 1202-0012 | 010 |  | 83023 |
| - 05/92 | Models with Link Cabmate KWB400-A Air Suspension  | 1202-0012 | 010 |  | 83023 |
| 05/92 - | Models with Link Cabmate KWB689-B or KWB689-C Air Suspension                                  | 1201-1043 | 010 |  | 83025 |
| 06/92 - | Models with Link Cabmate KWB689-B or KWB689-C Air Suspension                                  | 1202-1043 | 010 |  | 83025 |
|         | Models with Link Cabmate KWB689-D and Severe service crossmembers                             | 1202K046  | 010 |  | 83049 |
|         |   | R71-1004  | 010 |  | 83049 |

#### T600

|  |   |           |     |  |       |
|--|---|-----------|-----|--|-------|
|  | Models with Link Cabmate KWMC642 Air Suspension | 1202-0054 | 010 |  | 83021 |
|--|---|-----------|-----|--|-------|

#### T600A

|  |  |           |     |  |       |
|--|--|-----------|-----|--|-------|
|  | Models with Link Cabmate KWB689-A Air Suspension and rear cab mount Kenworth P/N K235-1436 or K235-1488                | 1202-0012 | 010 |  | 83023 |
|  | Models with Link Cabmate KWB689-B or KWB689-C Air Suspension and rear cab mount Kenworth part # K235-1436 or K235-1488 | 1201-1043 | 010 |  | 83025 |
|  |  | 1202-1043 | 010 |  | 83025 |
|  | Models with Link Cabmate KWB689-D and Severe service crossmembers  | 1202K046  | 010 |  | 83049 |
|  |  | R71-1004  | 010 |  | 83049 |

#### T660

|         |   |           |     |  |       |
|---------|---|-----------|-----|--|-------|
| 08 - 17 | Models with 86" Sleepers with O.E.M. Number | 1202-1286 | 010 |  | 83056 |
|         |   | 1202K286  | 010 |  | 83056 |
|         |   | T71-1003  | 010 |  | 83056 |
| 06 - 10 | Models with Link Cab Suspension             | 1202-1065 | 010 |  | 83002 |

#### T680

|         |   |           |     |  |       |
|---------|---|-----------|-----|--|-------|
| 13 - 18 | Models with Sleepers with O.E.M. Number | 1201-8002 | 010 |  | 83081 |
|         |   | R71-6009  | 010 |  | 83081 |

#### T700

|         |   |           |     |  |       |
|---------|---|-----------|-----|--|-------|
| 11 - 16 | DayCab Models with O.E.M. Number            | R71-6000  | 010 |  | 83067 |
|         |   | R71-6010  | 010 |  | 83067 |
| 08 - 16 | Models with 86" Sleepers with O.E.M. Number | 1202-1286 | 010 |  | 83056 |
|         |   | 1202K286  | 010 |  | 83056 |
|         |   | T71-1003  | 010 |  | 83056 |
| 11 - 16 | Models with Extended Sleeper Cab            | 1202-1064 | 010 |  | 83024 |
|         |   | 1202K064  | 010 |  | 83024 |
|         |   | R71-1005  | 010 |  | 83024 |

#### T800 / T800A

|        |   |           |     |  |       |
|--------|---|-----------|-----|--|-------|
| - 2012 | Models with Link Cab Suspension   | 1202-1046 | 010 |  | 83049 |
|        | Models with Link Cabmate KWB689-A Air Suspension and rear cab mount Kenworth P/N K235-1436 or K235-1488 | 1202-0012 | 010 |  | 83023 |

## APPLICATION GUIDE - TRUCKS, TRAILERS, AND BUSES

| Year<br>Año<br>Année | Model<br>Modelo<br>Modèle | OEM # | Front     |        | Rear      |        |
|----------------------|---------------------------|-------|-----------|--------|-----------|--------|
|                      |                           |       |           |        |           |        |
|                      |                           |       |           |        |           |        |
|                      |                           |       | Fleetline | GasSLX | Fleetline | GasSLX |

### KENWORTH CAB SHOCKS(Cont'd.)

#### T800 / T800A(Cont'd.)

|        |  |           |     |       |
|--------|--|-----------|-----|-------|
|        | Models with Link Cabmate KWB689-B or KWB689-C Air Suspension and rear cab mount Kenworth part # K235-1436 or K235-1488 | 1201-1043 | OIO | 83025 |
|        |  | 1202-1043 | OIO | 83025 |
|        | Models with Link Cabmate KWB689-D and Severe service crossmembers  | 1202K046  | OIO | 83049 |
| - 2014 | Models with Link Cabmate KWB689-D and Severe service crossmembers  | R71-1004  | OIO | 83049 |
|        | Models with Link Cabmate KWMC642 Air Suspension  | 1202-0054 | OIO | 83021 |

#### T880

|         |   |           |     |       |
|---------|---|-----------|-----|-------|
| 14 - 18 | Sleeper cab Models with Link Cab Suspension | 1202-1046 | OIO | 83049 |
|---------|---|-----------|-----|-------|

#### W900L

|         |                           |          |     |       |
|---------|---------------------------|----------|-----|-------|
| 06 - 17 | Models with O.E.M. Number | 1202K065 | OIO | 83002 |
|         |                           | T71-1002 | OIO | 83002 |

#### T2000

|         |   |             |     |       |
|---------|---|-------------|-----|-------|
| 97 - 11 | Models with Link Cabmate KWT2000-A Air Suspension       | 1202-1064   | OIO | 83024 |
|         |   | 1202K064    | OIO | 83024 |
|         |   | R71-1005    | OIO | 83024 |
| 07/98 - | Models with PowerPacker Cab Suspension after 6/28/98    | PP2582870   | OIO | 83012 |
| - 06/98 | Models with PowerPacker Cab Suspension prior to 6/28/98 | 96027-10545 | OIO | 83011 |

#### W-900 / W-900B

|  |  |           |     |       |
|--|--|-----------|-----|-------|
|  | Models with Link Cabmate KWB689-A Air Suspension and rear cab mount Kenworth P/N K235-1436 or K235-1488                | 1202-0012 | OIO | 83023 |
|  | Models with Link Cabmate KWB689-B or KWB689-C Air Suspension and rear cab mount Kenworth part # K235-1436 or K235-1488 | 1201-1043 | OIO | 83025 |
|  |  | 1202-1043 | OIO | 83025 |
|  | Models with Link Cabmate KWB689-D and Severe service crossmembers  | 1202K046  | OIO | 83049 |
|  |  | R71-1004  | OIO | 83049 |
|  | Models with Link Cabmate KWMC642 Air Suspension  | 1202-0054 | OIO | 83021 |

#### Additional Applications

|        |  |           |     |       |
|--------|--|-----------|-----|-------|
|        | 60" Sleeper with Link Cab Suspension   | 1202-0043 | OIO | 83032 |
| - 1982 | Conventional Tractors with A-Model cabs & Link Cabmate Model KWA900                  | 1201-0012 | OIO | 83023 |
|        |  | 1202-0012 | OIO | 83023 |
| 1986 - | Kenworth Sleepers with Link Cabmate KWS60-A Air Suspension and round cornered doors. | 1201-1044 | OIO | 83025 |
|        | Models with Link Cab Suspension  | 1202-0042 | OIO | 83025 |
|        | Models with O.E.M. Number  | 1202-K065 | OIO | 83002 |
|        |  | 1202K164  | OIO | 83031 |
|        |  | 1202K264  | OIO | 83031 |
|        |  | PP1058870 | OIO | 83059 |
|        |  | R71-6005  | OIO | 83042 |
|        |  | T71-1000  | OIO | 83031 |
|        |  | T71-1001  | OIO | 83031 |

### KIMBLE MIXER CO





|  |   |              |     |     |     |        |     |
|--|---|--------------|-----|-----|-----|--------|-----|
|  | Rear Discharge Mixers with Self - Steering Axle Shock | T91-00002-00 | ... | ... | OIO | 646155 | ... |
|--|---|--------------|-----|-----|-----|--------|-----|

### KING OF THE ROAD

#### Class A MotorHomes

|         |   |              |     |       |     |       |     |
|---------|---|--------------|-----|-------|-----|-------|-----|
| 04 - 06 | Genesis Series MotorHomes with Freightliner XC Chassis<br>ADL200 Suspension w/ 20K Rear<br>AS120 Front Suspension | 16-16873-000 | ... | ...   | OIO | 85029 | ... |
|         |   | 141700131810 | OIO | 83160 | ... | ...   | ... |
|         |   | 16-16737-000 | OIO | 83160 | ... | ...   | ... |
|         |   | 16-16874-000 | OIO | 83160 | ... | ...   | ... |
|         |   | 141700131809 | ... | ...   | OIO | 85029 | ... |
|         | Rear Shock with O.E.M. Number   |              |     |       |     |       |     |

## APPLICATION GUIDE - TRUCKS, TRAILERS, AND BUSES

| Year<br>Año<br>Année | Model<br>Modelo<br>Modèle | OEM # | Front   |  | Rear  |   |
|----------------------|---------------------------|-------|---|--|---|---|
|                      |                           |       |  |  |  |  |
|                      |                           |       | Fleetline   | GasSLX   | Fleetline   | GasSLX  |

### KING OF THE ROAD(Cont'd.)

#### Class A MotorHomes(Cont'd.)

|         |  |  |     |              |     |     |              |     |
|---------|--|--|-----|--------------|-----|-----|--------------|-----|
| 04 - 06 | ADL200 Suspension w/ 20K Rear<br>ZF - IFS Front Suspension with 23,000 lb GVW or Greater | 16-16736-000<br>16-18103-000<br>481700000493 |     | ...          | ... | 010 | <b>85029</b> | ... |
|         |  |  | -1- | <b>85900</b> | ... |     | ...          | ... |
|         |  |  | -1- | <b>85900</b> | ... |     | ...          | ... |

### KRYSTAL BUS

|        |  |                      |     |              |     |     |              |     |
|--------|--|----------------------|-----|--------------|-----|-----|--------------|-----|
| - 2019 | Krystal E-450 Shuttle bus  | ASH-1136<br>ASH-1154 |     | ...          | ... | -10 | <b>83178</b> | ... |
|        |  |                      | -10 | <b>83177</b> | ... |     | ...          | ... |
|        | Krystal F-650 Shuttle bus - Refer to Ford section for detailed information on F-650 models |                      |     |              |     |     |              |     |

### KWK-LOC (JIFFLOX)

|  |             |                   |     |              |     |  |     |     |
|--|-------------|-------------------|-----|--------------|-----|--|-----|-----|
|  | Truck Dolly | 522217<br>CP-5222 | 010 | <b>85315</b> | ... |  | ... | ... |
|  |             |                   | 010 | <b>85315</b> | ... |  | ... | ... |

### LEYLAND TRUCK

|  |   |         |  |     |     |     |              |              |
|--|---|---------|--|-----|-----|-----|--------------|--------------|
|  | Models with Air Trac Suspension (38000 or 40000 lb) | 1456033 |  | ... | ... | -10 | <b>85311</b> | <b>89424</b> |
|--|---|---------|--|-----|-----|-----|--------------|--------------|





### LGE COACHWORKS

|        |  |                      |     |              |     |     |              |     |
|--------|--|----------------------|-----|--------------|-----|-----|--------------|-----|
| - 2019 | All Shuttle buses with Ford E350 and E450 Chassis  | ASH-1136<br>ASH-1154 |     | ...          | ... | -10 | <b>83178</b> | ... |
|        |  |                      | -10 | <b>83177</b> | ... |     | ...          | ... |
|        | Models with Freightliner M2 Chassis - See Freightliner section for proper year and model information | .....                |     |              |     |     |              |     |

### LINK MANUFACTURING CAB SHOCKS

|                |   |           |     |  |  |  |              |  |
|----------------|---|-----------|-----|--|--|--|--------------|--|
|                | Models with Link Cab Suspension               | 1202-1046 | 010 |  |  |  | <b>83049</b> |  |
| <b>06 - 13</b> | Peterbilt 335 Day Cab models with Link Number | 1202P055  | 010 |  |  |  | <b>83061</b> |  |
|                | Models with Link Cab Suspension               | 1201-0012 | 010 |  |  |  | <b>83023</b> |  |
|                |   | 1201-0154 | 010 |  |  |  | <b>83051</b> |  |
|                |   | 1201-0254 | 010 |  |  |  | <b>83051</b> |  |
|                |   | 1201-1043 | 010 |  |  |  | <b>83025</b> |  |
|                |   | 1201-1044 | 010 |  |  |  | <b>83025</b> |  |
|                |   | 1201-1046 | 010 |  |  |  | <b>83049</b> |  |
|                |   | 1201-1049 | 010 |  |  |  | <b>83025</b> |  |
|                |   | 1201-1212 | 010 |  |  |  | <b>83013</b> |  |
|                |   | 1201-1213 | 01- |  |  |  | <b>83005</b> |  |
|                |   | 1201-9001 | 010 |  |  |  | <b>83052</b> |  |
|                |   | 1201-9002 | 010 |  |  |  | <b>83052</b> |  |
|                |   | 1201-9003 | 010 |  |  |  | <b>83052</b> |  |
|                |   | 1201-9007 | 010 |  |  |  | <b>83054</b> |  |
|                |   | 1201-9008 | 010 |  |  |  | <b>83054</b> |  |
|                |   | 1201-9009 | 010 |  |  |  | <b>83054</b> |  |
|                |   | 1201-9010 | 010 |  |  |  | <b>83053</b> |  |
|                |   | 1201-9011 | 010 |  |  |  | <b>83053</b> |  |
|                |   | 1201-9013 | 01- |  |  |  | <b>83062</b> |  |
|                |   | 1201-9014 | 01- |  |  |  | <b>83062</b> |  |
|                |   | 1201-9018 | 01- |  |  |  | <b>83062</b> |  |
|                |   | 1201-9021 | 01- |  |  |  | <b>83062</b> |  |
|                |   | 1202-0012 | 010 |  |  |  | <b>83023</b> |  |
|                |   | 1202-0032 | 010 |  |  |  | <b>83016</b> |  |
|                |   | 1202-0042 | 010 |  |  |  | <b>83025</b> |  |
|                |   | 1202-0043 | 010 |  |  |  | <b>83032</b> |  |
|                |   | 1202-0044 | 010 |  |  |  | <b>83025</b> |  |
|                |   | 1202-0052 | 010 |  |  |  | <b>83021</b> |  |
|                |   | 1202-0054 | 010 |  |  |  | <b>83021</b> |  |
|                |   | 1202-1042 | 010 |  |  |  | <b>83025</b> |  |

**APPLICATION GUIDE - TRUCKS, TRAILERS, AND BUSES**

| Year<br>Año<br>Année | Model<br>Modelo<br>Modèle | OEM # | Front   |   | Rear  |   |
|----------------------|---------------------------|-------|---|---|---|---|
|                      |                           |       |  |  |  |  |
|                      |                           |       | Fleetline   | GasSLX  | Fleetline   | GasSLX  |

**LINK MANUFACTURING CAB SHOCKS(Cont'd.)**

|                                 |           |              |              |
|---------------------------------|-----------|--------------|--------------|
| Models with Link Cab Suspension | 1202-1043 | 010          | <b>83025</b> |
|                                 | 1202-1044 | 010          | <b>83025</b> |
|                                 | 1202-1064 | 010          | <b>83024</b> |
|                                 | 1202-1065 | 010          | <b>83002</b> |
|                                 | 1202-1164 | 010          | <b>83031</b> |
|                                 | 1202-1212 | 010          | <b>83013</b> |
|                                 | 1202-1213 | 01-          | <b>83005</b> |
|                                 | 1202-1286 | 010          | <b>83056</b> |
|                                 | 1202K065  | 010          | <b>83002</b> |
|                                 | 1202K164  | 010          | <b>83031</b> |
|                                 | 1202K264  | 010          | <b>83031</b> |
|                                 | 1202K286  | 010          | <b>83056</b> |
|                                 | 632129    | 010          | <b>83023</b> |
|                                 | 635705    | 010          | <b>83016</b> |
|                                 | 654669    | 010          | <b>83021</b> |
|                                 | 654799    | 010          | <b>83025</b> |
|                                 | 654811    | 010          | <b>83024</b> |
|                                 | 654833    | 010          | <b>83021</b> |
|                                 | 654847    | 010          | <b>83002</b> |
|                                 | 654849    | 010          | <b>83031</b> |
|                                 | 654867    | 010          | <b>83025</b> |
|                                 | LG40450   | 010          | <b>83016</b> |
|                                 | LG40470   | 010          | <b>83016</b> |
|                                 | R71-1004  | 010          | <b>83049</b> |
|                                 | R71-1005  | 010          | <b>83024</b> |
| T71-1000                        | 010       | <b>83031</b> |              |
| T71-1001                        | 010       | <b>83031</b> |              |
| T71-1002                        | 010       | <b>83002</b> |              |

**LINK MANUFACTURING LTD.**

| (See Specialty Application Section Also)      |           |  |     |     |     |              |     |
|---|-----------|--|-----|-----|-----|--------------|-----|
| Sterling Models with Link Rear Air Suspension | 1210-0528 |  | ... | ... | 010 | <b>85904</b> | ... |
| Models with O.E.M. Number                     | 1210-0005 |  | ... | ... | 010 | <b>85734</b> | ... |
|   | 671093    |  | ... | ... | 010 | <b>85904</b> | ... |

**LION BUS**

|  |            |     |              |     |     |              |              |
|--|------------|-----|--------------|-----|-----|--------------|--------------|
| Bus Chassis With Hendrickson HTS 210 Suspension (Type C School Bus Applications) | 60665-025  |     | ...          | ... | 010 | <b>85036</b> | <b>89405</b> |
|  | 60665-025L |     | ...          | ... | 010 | <b>85036</b> | <b>89405</b> |
| Buses with Hendrickson Softek Suspension with Drum and Disc Brakes               | 58913-009  | 010 | <b>85959</b> | ... |     | ...          | ...          |
|  | 58913-009L | 010 | <b>85959</b> | ... |     | ...          | ...          |





**LODAL, INC.**

|              |         |     |              |              |  |     |     |
|--------------|---------|-----|--------------|--------------|--|-----|-----|
| Refuse Truck | 9960257 | 010 | <b>83122</b> | <b>89406</b> |  | ... | ... |
|--------------|---------|-----|--------------|--------------|--|-----|-----|

**M.A.N. BUS**

|                                   |                 |     |              |     |     |              |     |
|-----------------------------------|-----------------|-----|--------------|-----|-----|--------------|-----|
| Americana Bus with O.E.M. Numbers | 25-1700-106-654 |     | ...          | ... | -1- | <b>85708</b> | ... |
|                                   | 81-43701-6543   |     | ...          | ... | -1- | <b>85708</b> | ... |
|                                   | 81-43701-6572   | -1- | <b>85708</b> | ... |     | ...          | ... |
|                                   | 81-43701-6573   | -1- | <b>85722</b> | ... |     | ...          | ... |
| Articulating Bus - Drive Axle     | 81-43701-6537   |     | ...          | ... | -1- | <b>85709</b> | ... |
| Articulating Bus - Front Axle     | 81-43701-6538   | -1- | <b>85708</b> | ... |     | ...          | ... |
| Articulating Bus - Trailing Axle  | 81-43701-6539   |     | ...          | ... | -1- | <b>85708</b> | ... |
| Models with O.E.M. Number         | 134             |     | ...          | ... | -1- | <b>85709</b> | ... |
|                                   | 81-43701-6609   |     | ...          | ... | -1- | <b>85709</b> | ... |

**APPLICATION GUIDE - TRUCKS, TRAILERS, AND BUSES**

| Year<br>Año<br>Année | Model<br>Modelo<br>Modèle | OEM # | Front   |  | Rear  |   |
|----------------------|---------------------------|-------|---|--|---|---|
|                      |                           |       |  |  |  |  |
|                      |                           |       | Fleetline   | GasSLX   | Fleetline   | GasSLX  |

**M.A.N. BUS(Cont'd.)**

|                           |            |  |     |     |     |              |     |
|---------------------------|------------|--|-----|-----|-----|--------------|-----|
| Models with O.E.M. Number | 9020M-1042 |  | ... | ... | - - | <b>85709</b> | ... |
|---------------------------|------------|--|-----|-----|-----|--------------|-----|

**MAC TRAILER MFG., INC.**

|   |  |  |  |  |  |  |  |
|---|--|--|--|--|--|--|--|
| Identification of the trailer suspension is necessary to determine what section of the catalog to refer to. Some possible options can be Chalmers, Hendrickson, Neway, Ridewell, Reyco. |  |  |  |  |  |  |  |
|---|--|--|--|--|--|--|--|

**MACK**

**ANTHEM Series**

|                |   |                                      |     |              |     |     |              |     |
|----------------|---|--------------------------------------|-----|--------------|-----|-----|--------------|-----|
| <b>18 - 19</b> | Anthem 64T Models with 13,200 lb Front Axles                                  | 141700005839<br>21436096             | O O | <b>85098</b> | ... |     | ...          | ... |
|                |   |                                      |     | <b>85098</b> | ... |     | ...          | ... |
| <b>18 - 19</b> | Anthem 64T Models with 40,000 lb Rear Air Suspensions                         | 22202560<br>471700009647             |     | ...          | ... | O O | <b>85088</b> | ... |
|                |   |                                      |     | ...          | ... | O O | <b>85088</b> | ... |
| <b>18 - 19</b> | Anthem 64T Models with Hendrickson HAS 400 or 460 Series Rear Suspension      | 60675-001<br>60675-001L<br>8083872   |     | ...          | ... | O O | <b>85978</b> | ... |
|                |   |                                      |     | ...          | ... | O O | <b>85978</b> | ... |
|                |   |                                      |     | ...          | ... | O O | <b>85978</b> | ... |
| <b>18 - 19</b> | Models with Hendrickson HMX 400/460 Haulmax with 16.5" Saddle                 | 60680-004<br>60680-004L<br>H60680004 |     | ...          | ... | O - | <b>83143</b> | ... |
|                |   |                                      |     | ...          | ... | O - | <b>83143</b> | ... |
|                |   |                                      |     | ...          | ... | O - | <b>83143</b> | ... |
| <b>18 - 19</b> | Models with Hendrickson HMX 400/460 Haulmax with 17.5" or 18.5" Saddle Height | 60680-005<br>60680-005L<br>H60680005 |     | ...          | ... | O - | <b>83142</b> | ... |
|                |   |                                      |     | ...          | ... | O - | <b>83142</b> | ... |
|                |   |                                      |     | ...          | ... | O - | <b>83142</b> | ... |
| <b>18 - 19</b> | Models with Hendrickson HN - 522 Rear Suspension                              | 60680-003<br>60680-003L              |     | ...          | ... | O - | <b>83112</b> | ... |
|                |   |                                      |     | ...          | ... | O - | <b>83112</b> | ... |

**CH Series**

|  |   |   |     |              |              |     |              |     |
|--|---|---|-----|--------------|--------------|-----|--------------|-----|
|  | CH Models with Hendrickson HA Series Air Suspension                         | 14QK-410M2<br>14QK-410M3<br>25625254  |     | ...          | ...          | O O | <b>83137</b> | ... |
|  |   |   |     | ...          | ...          | O O | <b>83125</b> | ... |
|  |   |   |     | ...          | ...          | O O | <b>83125</b> | ... |
|  | CH600 Models with 12000 lb Taperleaf Spring                                 | 14QK-392AM<br>14QK-392AM3<br>14QK-392BM<br>14QK-392BM3<br>14QK-396<br>14QK-396M<br>25625743 | O O | <b>85005</b> | <b>89430</b> |     | ...          | ... |
|  |   |   |     | <b>85005</b> | <b>89430</b> |     | ...          | ... |
|  |   |   |     | <b>85005</b> | <b>89430</b> |     | ...          | ... |
|  |   |   |     | <b>85005</b> | <b>89430</b> |     | ...          | ... |
|  |   |   |     | <b>85005</b> | <b>89430</b> |     | ...          | ... |
|  |   |   |     | <b>85005</b> | <b>89430</b> |     | ...          | ... |
|  |   |   |     | <b>85005</b> | <b>89430</b> |     | ...          | ... |
|  | CH600 Models with AL Suspension   | 14QK-393M   |     | ...          | ...          | O O | <b>85010</b> | ... |
|  | CH600 Models with ALV Hendrickson Suspension                                | 14QK-413M5<br>14QK-413M6<br>14QK-413M7<br>25622221<br>25625223<br>57241-006<br>57241-006L   |     | ...          | ...          | O - | <b>83138</b> | ... |
|  |   |   |     | ...          | ...          | O - | <b>83111</b> | ... |
|  |   |   |     | ...          | ...          | O - | <b>83111</b> | ... |
|  |   |   |     | ...          | ...          | O - | <b>83111</b> | ... |
|  |   |   |     | ...          | ...          | O - | <b>83111</b> | ... |
|  |   |   |     | ...          | ...          | O - | <b>83111</b> | ... |
|  |   |   |     | ...          | ...          | O - | <b>83111</b> | ... |
|  | CH600 Models with HAS400 MACK Air Suspension                                | 14QK-410M<br>25625234<br>47902-25   |     | ...          | ...          | O O | <b>83125</b> | ... |
|  |   |   |     | ...          | ...          | O O | <b>83125</b> | ... |
|  |   |   |     | ...          | ...          | O O | <b>83125</b> | ... |
|  | CH600 Models with Hendrickson AL-405 Rear Suspension                        | 14QK-413M7<br>25625223<br>57241-006<br>57241-006L   |     | ...          | ...          | O - | <b>83111</b> | ... |
|  |   |   |     | ...          | ...          | O - | <b>83111</b> | ... |
|  |   |   |     | ...          | ...          | O - | <b>83111</b> | ... |
|  |   |   |     | ...          | ...          | O - | <b>83111</b> | ... |
|  | CH600 Models with Hendrickson HAS-40LH Air Suspension (O.E. Number 57241-4) | 14QK-413M4<br>57241-4   |     | ...          | ...          | O - | <b>83110</b> | ... |
|  |   |   |     | ...          | ...          | O - | <b>83110</b> | ... |
|  | CH600 Models with Hendrickson HN-2 Series Suspension                        | 14QK-415M<br>14QK-415M7   |     | ...          | ...          | O - | <b>83112</b> | ... |
|  |   |   |     | ...          | ...          | O - | <b>83112</b> | ... |

## APPLICATION GUIDE - TRUCKS, TRAILERS, AND BUSES

| Year<br>Año<br>Année | Model<br>Modelo<br>Modèle | OEM # | Front     |        | Rear      |        |
|----------------------|---------------------------|-------|-----------|--------|-----------|--------|
|                      |                           |       |           |        |           |        |
|                      |                           |       | Fleetline | GasSLX | Fleetline | GasSLX |

### MACK(Cont'd.)

#### CH Series(Cont'd.)

|  |   |             |     |       |       |     |       |       |
|--|---|-------------|-----|-------|-------|-----|-------|-------|
|  | CH600 Models with Hendrickson HN-2 Series Suspension  | 25624241    |     | ...   | ...   | 01- | 83112 | ...   |
|  |   | 60680-003   |     | ...   | ...   | 01- | 83112 | ...   |
|  |   | 60680-003L  |     | ...   | ...   | 01- | 83112 | ...   |
|  | CH600 Models with Hendrickson Rear Air Suspension   | 14QK-393AM  |     | ...   | ...   | 010 | 83123 | 89405 |
|  |   | 47902-9     |     | ...   | ...   | 010 | 83123 | 89405 |
|  | CH600 Models with Neway AD Air Suspension Shock<br>w/ extended length of 21.70"<br><br>w/ extended length of 24.30" | 14QK-414M   |     | ...   | ...   | 010 | 85906 | 89407 |
|  |   | 90045099    |     | ...   | ...   | 010 | 85906 | 89407 |
|  |   | 14QK-414M2  |     | ...   | ...   | 010 | 85909 | ...   |
|  |   | 25624351    |     | ...   | ...   | 010 | 85909 | ...   |
|  | CH600 Models with ST34 Suspension   | 14QK-2133M  | 010 | 85001 | 89410 |     | ...   | ...   |
|  |   | 25622466    | 010 | 85001 | 89410 |     | ...   | ...   |
|  | Models with O.E.M. Number   | 14QK-2113P6 |     | ...   | ...   | 010 | 85007 | 89412 |
|  |   | 14QK-421M   | 010 | 85014 | ...   |     | ...   | ...   |
|  |   | 47170000426 | 010 | 85014 | ...   |     | ...   | ...   |

#### CHN - Series

|         |   |                |     |       |       |     |       |       |
|---------|---|----------------|-----|-------|-------|-----|-------|-------|
| 04 - 07 | CHN-613 Models w/ MACK Air Suspension                     | 14QK-3101M     |     | ...   | ...   | 010 | 85066 | 89448 |
|         |   | 47170000431    |     | ...   | ...   | 010 | 85066 | 89448 |
|         |   | SDA47170000431 |     | ...   | ...   | 010 | 85066 | 89448 |
| 04 - 07 | CHN-613 Models with 12,000 lb Front Axle                  | 14QK-3107M     | 010 | 85061 | 89450 |     | ...   | ...   |
|         |   | 20973993       | 010 | 85061 | 89450 |     | ...   | ...   |
| 04 - 07 | CHN-613 Models with 14,600 lb Front Axle                  | 14QK-434M      | 010 | 85014 | ...   |     | ...   | ...   |
| 04 - 07 | CHN-613 Models with Camelback Rear Suspension (SS34 & 38) | 20998401       | 010 | 85014 | ...   |     | ...   | ...   |
|         |   | 25625091       |     | ...   | ...   | 010 | 83215 | ...   |

#### CHU - Pinnacle Series





|         |   |                 |     |       |     |     |       |     |
|---------|---|-----------------|-----|-------|-----|-----|-------|-----|
| 08 - 19 | CHU-613 Models with 12,000 lb or 14,600 lb Front Axle                 | 14QK-434M       | 010 | 85014 | ... |     | ...   | ... |
|         |   | 20625775        | 010 | 85014 | ... |     | ...   | ... |
|         |   | 20998401        | 010 | 85014 | ... |     | ...   | ... |
|         |   | 471700002861    | 010 | 85014 | ... |     | ...   | ... |
|         |   | SDA471700002861 | 010 | 85014 | ... |     | ...   | ... |
| 11 - 17 | CHU-613 Models with 40,000 lb Rear Air Suspensions                    | 22202560        |     | ...   | ... | 010 | 85088 | ... |
|         |   | 471700009647    |     | ...   | ... | 010 | 85088 | ... |
| - 2019  | CHU-613 Models with Camelback Rear Suspension (SS34 & 38)             | 14QK-2107P2     |     | ...   | ... | 010 | 83215 | ... |
|         |   | 25625091        |     | ...   | ... | 010 | 83215 | ... |
| 08 - 14 | CHU-613 Models with Hendrickson 38,000 lb Rear Air Suspension         | 14QK-424M       |     | ...   | ... | 010 | 83147 | ... |
|         |   | 20570098        |     | ...   | ... | 010 | 83147 | ... |
|         |   | 60670-006       |     | ...   | ... | 010 | 83147 | ... |
|         |   | 60670-006L      |     | ...   | ... | 010 | 83147 | ... |
| - 2019  | CHU-613 Models with Hendrickson HAS 400 or 460 Series Rear Suspension | 60675-001       |     | ...   | ... | 010 | 85978 | ... |
|         |   | 60675-001L      |     | ...   | ... | 010 | 85978 | ... |
|         |   | 8083872         |     | ...   | ... | 010 | 85978 | ... |

#### CL Series

|  |   |            |  |     |     |     |       |     |
|--|---|------------|--|-----|-----|-----|-------|-----|
|  | CL600, CL700 Models with ALV Hendrickson Suspension | 14QK-413M5 |  | ... | ... | 01- | 83138 | ... |
|  |   | 14QK-413M6 |  | ... | ... | 01- | 83111 | ... |
|  |   | 14QK-413M7 |  | ... | ... | 01- | 83111 | ... |
|  |   | 25622221   |  | ... | ... | 01- | 83111 | ... |
|  |   | 25625223   |  | ... | ... | 01- | 83111 | ... |
|  |   | 57241-006  |  | ... | ... | 01- | 83111 | ... |
|  |   | 57241-006L |  | ... | ... | 01- | 83111 | ... |
|  | CL600, CL700 Models with HAS400 MACK Air Suspension | 14QK-410M  |  | ... | ... | 010 | 83125 | ... |
|  |   | 25625234   |  | ... | ... | 010 | 83125 | ... |
|  |   | 47902-25   |  | ... | ... | 010 | 83125 | ... |



**APPLICATION GUIDE - TRUCKS, TRAILERS, AND BUSES**

| Year<br>Año<br>Année | Model<br>Modelo<br>Modèle | OEM # | Front  |   | Rear   |   |
|----------------------|---------------------------|-------|--|---|--|---|
|                      |                           |       |  |  |  |  |
|                      |                           |       | Fleetline  | GasSLX  | Fleetline  | GasSLX  |

**MACK(Cont'd.)**

**CL Series(Cont'd.)**

|  |  |             |     |              |              |              |              |
|--|--|-------------|-----|--------------|--------------|--------------|--------------|
|  | CL600, CL700 Models with Hendrickson HA Series Air Suspension  | 14QK-410M2  | ... | ...          | 010          | <b>83137</b> | ...          |
|  |  | 14QK-410M3  | ... | ...          | 010          | <b>83125</b> | ...          |
|  |  | 25625254    | ... | ...          | 010          | <b>83125</b> | ...          |
|  | CL600, CL700 Models with Hendrickson HN-2 Series Suspension  | 14QK-415M   | ... | ...          | 01-          | <b>83112</b> | ...          |
|  |  | 14QK-415M7  | ... | ...          | 01-          | <b>83112</b> | ...          |
|  |  | 25624241    | ... | ...          | 01-          | <b>83112</b> | ...          |
|  |  | 60680-003   | ... | ...          | 01-          | <b>83112</b> | ...          |
|  |  | 60680-003L  | ... | ...          | 01-          | <b>83112</b> | ...          |
|  | CL600, CL700 Models with Hendrickson Rear Air Suspension   | 14QK-393AM  | ... | ...          | 010          | <b>83123</b> | <b>89405</b> |
|  |  | 47902-9     | ... | ...          | 010          | <b>83123</b> | <b>89405</b> |
|  | CL600, CL700 Models with Multileaf Spring Suspension   | 14QK-392AM2 | 010 | <b>83123</b> | <b>89405</b> | ...          | ...          |
|  |  | 14QK-392BM2 | 010 | <b>85321</b> | ...          | ...          | ...          |
|  | CL600, CL700 Models with Neway AD Air Suspension Shock<br>w/ extended length of 21.70"<br><br>w/ extended length of 24.30" | 14QK-414M   | ... | ...          | 010          | <b>85906</b> | <b>89407</b> |
|  |  | 90045099    | ... | ...          | 010          | <b>85906</b> | <b>89407</b> |
|  |  | 14QK-414M2  | ... | ...          | 010          | <b>85909</b> | ...          |
|  |  | 25624351    | ... | ...          | 010          | <b>85909</b> | ...          |
|  | CL600, CL700 Models with ST34 Suspension   | 14QK-2113   | 010 | <b>85001</b> | <b>89410</b> | ...          | ...          |
|  |  | 14QK-2133M  | 010 | <b>85001</b> | <b>89410</b> | ...          | ...          |
|  |  | 25621955    | 010 | <b>85001</b> | <b>89410</b> | ...          | ...          |
|  |  | 25622466    | 010 | <b>85001</b> | <b>89410</b> | ...          | ...          |
|  |  | 25632145    | 010 | <b>85001</b> | <b>89410</b> | ...          | ...          |
|  | CL600, CL700 Models with Steering Axle & Taperleaf Spring  | 14QK-392AM  | 010 | <b>85005</b> | <b>89430</b> | ...          | ...          |
|  |  | 14QK-392AM3 | 010 | <b>85005</b> | <b>89430</b> | ...          | ...          |
|  |  | 14QK-392BM  | 010 | <b>85005</b> | <b>89430</b> | ...          | ...          |
|  |  | 25625743    | 010 | <b>85005</b> | <b>89430</b> | ...          | ...          |

**CS, MS - Mid - Liner Series**

|  |                                       |                 |     |              |     |     |     |
|--|---------------------------------------|-----------------|-----|--------------|-----|-----|-----|
|  | CS Models Mid-Liner with O.E.M Number | 4103-5000447861 | -10 | <b>83105</b> | ... | ... | ... |
|  |                                       | 4103-5000546892 | -10 | <b>83105</b> | ... | ... | ... |
|  |                                       | V10234121       | -10 | <b>83105</b> | ... | ... | ... |
|  |                                       | V10242320       | -10 | <b>83105</b> | ... | ... | ... |
|  | MS200, MS300 Models Mid-Liner         | V10234121       | -10 | <b>83105</b> | ... | ... | ... |





**CT, CTX Series**

|  |                           |            |     |              |     |     |     |
|--|---------------------------|------------|-----|--------------|-----|-----|-----|
|  | Models with O.E.M. Number | 14QK-3108  | 01- | <b>85080</b> | ... | ... | ... |
|  |                           | 14QK-3108M | 01- | <b>85080</b> | ... | ... | ... |
|  |                           | 14QK-3116M | 010 | <b>83101</b> | ... | ... | ... |
|  |                           | 14QK-427M  | 01- | <b>85080</b> | ... | ... | ... |
|  |                           | 14QK-428M  | 01- | <b>85080</b> | ... | ... | ... |

**CV - Series**

|                |   |            |     |              |              |              |     |
|----------------|---|------------|-----|--------------|--------------|--------------|-----|
| <b>02 - 08</b> | CV-713 Models with 18,000 lb Front Axles                                      | 14QK-366   | 010 | <b>85036</b> | <b>89405</b> | ...          | ... |
|                |   | 25625151   | 010 | <b>85036</b> | <b>89405</b> | ...          | ... |
| <b>02 - 08</b> | CV-713 Models with Hendrickson HN-2 Models Suspension                         | 14QK-415M  | ... | ...          | 01-          | <b>83112</b> | ... |
|                |   | 14QK-415M7 | ... | ...          | 01-          | <b>83112</b> | ... |
|                |   | 25624241   | ... | ...          | 01-          | <b>83112</b> | ... |
|                |   | 60680-003  | ... | ...          | 01-          | <b>83112</b> | ... |
|                |   | 60680-003L | ... | ...          | 01-          | <b>83112</b> | ... |
| <b>02 - 08</b> | Models with Hendrickson HMX 400/460 Haulmax with 16.5" Saddle                 | 60680-004  | ... | ...          | 01-          | <b>83143</b> | ... |
|                |   | 60680-004L | ... | ...          | 01-          | <b>83143</b> | ... |
|                |   | H60680004  | ... | ...          | 01-          | <b>83143</b> | ... |
| <b>02 - 08</b> | Models with Hendrickson HMX 400/460 Haulmax with 17.5" or 18.5" Saddle Height | 60680-005  | ... | ...          | 01-          | <b>83142</b> | ... |
|                |   | 60680-005L | ... | ...          | 01-          | <b>83142</b> | ... |
|                |   | H60680005  | ... | ...          | 01-          | <b>83142</b> | ... |

**APPLICATION GUIDE - TRUCKS, TRAILERS, AND BUSES**

| Year<br>Año<br>Année | Model<br>Modelo<br>Modèle | OEM # | Front   |   | Rear  |   |
|----------------------|---------------------------|-------|---|---|---|---|
|                      |                           |       |  |  |  |  |
|                      |                           |       | Fleetline   | GasSLX  | Fleetline   | GasSLX  |

**MACK(Cont'd.)**





**CX Series - Vision(Cont'd.)**

|  |  |                 |     |       |       |     |       |       |
|--|--|-----------------|-----|-------|-------|-----|-------|-------|
|  | CX Vision Models w/ Hendrickson Air Suspension                                   | 14QK-431M       |     | ...   | ...   | 010 | 85061 | 89450 |
|  | CX Vision Models w/ Hendrickson HA Models Air Suspension                         | 14QK-410M2      |     | ...   | ...   | 010 | 83137 | ...   |
|  |  | 14QK-410M3      |     | ...   | ...   | 010 | 83125 | ...   |
|  |  | 25625254        |     | ...   | ...   | 010 | 83125 | ...   |
|  | CX Vision Models w/ Hendrickson HN-2 Models Suspension                           | 14QK-415M       |     | ...   | ...   | 01- | 83112 | ...   |
|  |  | 14QK-415M7      |     | ...   | ...   | 01- | 83112 | ...   |
|  |  | 25624241        |     | ...   | ...   | 01- | 83112 | ...   |
|  |  | 60680-003       |     | ...   | ...   | 01- | 83112 | ...   |
|  |  | 60680-003L      |     | ...   | ...   | 01- | 83112 | ...   |
|  | CX Vision Models w/ Parabolic Spring   | 14QK-431M       |     | ...   | ...   | 010 | 85061 | 89450 |
|  | CX Vision Models with Neway AD Air Suspension Shock w/ extended length of 21.70" | 14QK-414M       |     | ...   | ...   | 010 | 85906 | 89407 |
|  |  | 90045099        |     | ...   | ...   | 010 | 85906 | 89407 |
|  | CX Vision Models with Neway AD Air Suspension Shock w/ extended length of 24.30" | 14QK-414M2      |     | ...   | ...   | 010 | 85909 | ...   |
|  |  | 25624351        |     | ...   | ...   | 010 | 85909 | ...   |
|  | CX Vision Models w/ ALV Hendrickson Suspension                                   | 14QK-413M5      |     | ...   | ...   | 01- | 83138 | ...   |
|  |  | 14QK-413M6      |     | ...   | ...   | 01- | 83111 | ...   |
|  |  | 25622221        |     | ...   | ...   | 01- | 83111 | ...   |
|  |  | 25625223        |     | ...   | ...   | 01- | 83111 | ...   |
|  | CX Vision Models w/ MACK Air Suspension  | 14QK-3101M      |     | ...   | ...   | 010 | 85066 | 89448 |
|  |  | 471700000431    |     | ...   | ...   | 010 | 85066 | 89448 |
|  |  | SDA471700000431 |     | ...   | ...   | 010 | 85066 | 89448 |
|  | Models with 12000 lb Taperleaf Front Suspension                                  | 14QK-392BM3     | 010 | 85005 | 89430 |     | ...   | ...   |
|  | Models with HAS400 MACK Air Suspension   | 14QK-410M       |     | ...   | ...   | 010 | 83125 | ...   |
|  |  | 25625234        |     | ...   | ...   | 010 | 83125 | ...   |
|  |  | 47902-25        |     | ...   | ...   | 010 | 83125 | ...   |
|  | Models with Hendrickson Air Suspension (Stamping No. 57241-4)                    | 14QK-413M4      |     | ...   | ...   | 01- | 83110 | ...   |
|  |  | 25624341        |     | ...   | ...   | 01- | 83110 | ...   |
|  | Models with MAC AL405 Suspension   | 14QK-413M7      |     | ...   | ...   | 01- | 83111 | ...   |
|  |  | 25625223        |     | ...   | ...   | 01- | 83111 | ...   |
|  |  | 57241-006       |     | ...   | ...   | 01- | 83111 | ...   |
|  |  | 57241-006L      |     | ...   | ...   | 01- | 83111 | ...   |
|  | Models with O.E.M. Number  | 141700000373    | 010 | 85061 | 89450 |     | ...   | ...   |
|  |  | 20513881        | 010 | 85061 | 89450 |     | ...   | ...   |

**CXN Series**

|         |   |                 |     |       |       |     |       |       |
|---------|---|-----------------|-----|-------|-------|-----|-------|-------|
| 05 - 07 | CXN-613 Models w/ MACK Air Suspension                         | 14QK-3101M      |     | ...   | ...   | 010 | 85066 | 89448 |
|         |   | SDA471700000431 |     | ...   | ...   | 010 | 85066 | 89448 |
| 11 - 14 | CXN-613 Models with 12,000 - 14,600 lb Front Axles            | 141700005839    | 010 | 85098 | ...   |     | ...   | ...   |
|         |   | 21436096        | 010 | 85098 | ...   |     | ...   | ...   |
|         | CXN-613 Models with 12,000 lb Front Axles                     | 14QK-3114M      | 010 | 85061 | 89450 |     | ...   | ...   |
|         |   | 20973993        | 010 | 85061 | 89450 |     | ...   | ...   |
|         |   | SDA141700000380 | 010 | 85061 | 89450 |     | ...   | ...   |
| 08 - 10 | CXN-613 Models with 40,000 lb Rear Air Suspensions            | 14QK-2136M      |     | ...   | ...   | 010 | 85061 | 89450 |
|         |   | 20897198        |     | ...   | ...   | 010 | 85061 | 89450 |
| 11 - 14 | CXN-613 Models with 40,000 lb Rear Air Suspensions            | 21462382        |     | ...   | ...   | 010 | 85088 | ...   |
|         |   | 471700006039    |     | ...   | ...   | 010 | 85088 | ...   |
| 05 - 14 | CXN-613 Models with Hendrickson 38,000 lb Rear Air Suspension | 14QK-424M       |     | ...   | ...   | 010 | 83147 | ...   |
|         |   | 20570098        |     | ...   | ...   | 010 | 83147 | ...   |
|         |   | 60670-006       |     | ...   | ...   | 010 | 83147 | ...   |
|         |   | 60670-006L      |     | ...   | ...   | 010 | 83147 | ...   |
|         | CXN-613 Models with Hendrickson AirTek Front Air Suspension   | 14QK-322M       | 010 | 85933 | 89454 |     | ...   | ...   |
|         |   | 14QK-422M       | 010 | 85933 | 89454 |     | ...   | ...   |
|         |   | 20485633        | 010 | 85933 | 89454 |     | ...   | ...   |

## APPLICATION GUIDE - TRUCKS, TRAILERS, AND BUSES

| Year<br>Año<br>Année | Model<br>Modelo<br>Modèle | OEM # | Front  |   | Rear   |   |
|----------------------|---------------------------|-------|--|---|--|---|
|                      |                           |       |  |  |  |  |
|                      |                           |       | Fleetline  | GasSLX  | Fleetline  | GasSLX  |

### MACK(Cont'd.)

#### CXN Series(Cont'd.)

|  |   |              |     |              |              |  |     |     |
|--|---|--------------|-----|--------------|--------------|--|-----|-----|
|  | CXN-613 Models with Hendrickson AirTek Front Air Suspension | 64838-002    | OIO | <b>85933</b> | <b>89454</b> |  | ... | ... |
|  | Models with O.E.M. Number                                   | 14QK-421M    | OIO | <b>85014</b> | ...          |  | ... | ... |
|  |   | 471700000426 | OIO | <b>85014</b> | ...          |  | ... | ... |

#### CXP Series

|         |  |   |     |              |              |     |              |              |
|---------|--|---|-----|--------------|--------------|-----|--------------|--------------|
| 06 - 07 | CXP-613 Models with 12,000 lb Front Axles          | 14QK-3114M<br>20973993<br>SDA141700000380 | OIO | <b>85061</b> | <b>89450</b> |     | ...          | ...          |
|         |  |   |     | <b>85061</b> | <b>89450</b> |     | ...          | ...          |
|         |  |   |     | <b>85061</b> | <b>89450</b> |     | ...          | ...          |
| 06 - 07 | CXP-613 Models with 40,000 lb Rear Air Suspensions | 14QK-2136M<br>20897198<br>471700002626    |     | ...          | ...          | OIO | <b>85061</b> | <b>89450</b> |
|         |  |   |     | ...          | ...          | OIO | <b>85061</b> | <b>89450</b> |
|         |  |   |     | ...          | ...          | OIO | <b>85061</b> | <b>89450</b> |

#### CXU - Pinnacle Series

|         |  |  |     |              |              |     |              |              |
|---------|--|--|-----|--------------|--------------|-----|--------------|--------------|
| 11 - 18 | CXU-613 Models with 12,000 - 14,600 lb Front Axles | 141700005839<br>21436096   | OIO | <b>85098</b> | ...          |     | ...          | ...          |
|         |  |  |     | <b>85098</b> | ...          |     | ...          | ...          |
| 08 - 10 | CXU-613 Models with 12,000 lb Front Axles          | 141700000380<br>14QK-3114M<br>20973993<br>SDA141700000380                                    | OIO | <b>85061</b> | <b>89450</b> |     | ...          | ...          |
|         |  |  |     | <b>85061</b> | <b>89450</b> |     | ...          | ...          |
|         |  |  |     | <b>85061</b> | <b>89450</b> |     | ...          | ...          |
|         |  |  |     | <b>85061</b> | <b>89450</b> |     | ...          | ...          |
| 08 - 10 | CXU-613 Models with 40,000 lb Rear Air Suspensions | 14QK-2136M<br>20897198<br>471700002626   |     | ...          | ...          | OIO | <b>85061</b> | <b>89450</b> |
|         |  |  |     | ...          | ...          | OIO | <b>85061</b> | <b>89450</b> |
|         |  |  |     | ...          | ...          | OIO | <b>85061</b> | <b>89450</b> |
| 11 - 18 | CXU-613 Models with 40,000 lb Rear Air Suspensions | 21462382<br>21462384<br>22202559<br>22202560<br>471700006039<br>471700009646<br>471700009647 |     | ...          | ...          | OIO | <b>85088</b> | ...          |
|         |  |  |     | ...          | ...          | OIO | <b>85088</b> | ...          |
|         |  |  |     | ...          | ...          | OIO | <b>85088</b> | ...          |
|         |  |  |     | ...          | ...          | OIO | <b>85088</b> | ...          |
|         |  |  |     | ...          | ...          | OIO | <b>85088</b> | ...          |
|         |  |  |     | ...          | ...          | OIO | <b>85088</b> | ...          |
|         |  |  |     | ...          | ...          | OIO | <b>85088</b> | ...          |

#### DM Series

|  |                           |             |     |              |     |  |     |     |
|--|---------------------------|-------------|-----|--------------|-----|--|-----|-----|
|  | Models with O.E.M. Number | 14QK-2100P8 | OIO | <b>83242</b> | ... |  | ... | ... |
|  |                           | 25622345    | OIO | <b>83242</b> | ... |  | ... | ... |









#### F Series

|  |                                   |               |     |              |              |     |              |              |
|--|-----------------------------------|---------------|-----|--------------|--------------|-----|--------------|--------------|
|  | F Models - Eastern                | .....         | OIO | <b>83221</b> | ...          |     | ...          | ...          |
|  | F Models (exc. Eastern)           | .....         | OIO | <b>83207</b> | <b>89407</b> | OIO | <b>83215</b> | ...          |
|  | F Models with Standard Suspension | .....         |     | ...          | ...          | OIO | <b>85305</b> | ...          |
|  | Fire Truck                        | .....         |     | <b>85302</b> | ...          | OIO | <b>85302</b> | <b>89420</b> |
|  | FL Models - Western               | 14QK-143      | OIO | <b>83207</b> | <b>89407</b> |     | ...          | ...          |
|  |                                   | 14QK-2100D-P4 | OIO | <b>83207</b> | <b>89407</b> |     | ...          | ...          |

#### Granite Series

|         |  |            |     |              |     |     |              |     |
|---------|--|------------|-----|--------------|-----|-----|--------------|-----|
| 18 - 19 | Granite 64BR & 64FR Models with 20,000 lb Front Axle                           | 21010744   | OIO | <b>83101</b> | ... |     | ...          | ... |
| 18 - 19 | Granite 64BR & 64FR Models with 46,000 lb Mack Mride Rear Suspension           | 21979343   |     | ...          | ... | OIO | <b>85065</b> | ... |
| 12 - 17 | GU-432 or GU-533 Models with 12,000 lb or 14,600 lb Front Axle                 | 14QK-434M  | OIO | <b>85014</b> | ... |     | ...          | ... |
|         |  | 20998401   | OIO | <b>85014</b> | ... |     | ...          | ... |
| 12 - 18 | GU-432 or GU-533 Models with 14,600 lb to 18,000 lb Multi-Leaf Front Springs   | 21010744   | OIO | <b>83101</b> | ... |     | ...          | ... |
| 12 - 18 | GU-432 or GU-533 Models with Hendrickson HAS 400 or 460 Series Rear Suspension | 60675-001  |     | ...          | ... | OIO | <b>85978</b> | ... |
|         |  | 60675-001L |     | ...          | ... | OIO | <b>85978</b> | ... |
|         |  | 8083872    |     | ...          | ... | OIO | <b>85978</b> | ... |
|         | GU-713 or GU-813 Models O.E.M. Number  | 21687170   | OIO | <b>85120</b> | ... |     | ...          | ... |
| 08 - 19 | GU-713 or GU-813 Models with 14,600 lb to 18,000 lb Multi-Leaf Front Springs   | 14QK-3116M | OIO | <b>83101</b> | ... |     | ...          | ... |
|         |  | 21010744   | OIO | <b>83101</b> | ... |     | ...          | ... |
| 08 - 10 | GU-713 or GU-813 Models with 20,000 lb Front Axles                             | 14QK-3108M | OIO | <b>85080</b> | ... |     | ...          | ... |

**APPLICATION GUIDE - TRUCKS, TRAILERS, AND BUSES**

| Year<br>Año<br>Année | Model<br>Modelo<br>Modèle | OEM # | Front   |   | Rear  |   |
|----------------------|---------------------------|-------|---|---|---|---|
|                      |                           |       |  |  |  |  |
|                      |                           |       |  |  |  |  |
|                      |                           |       | Fleetline   | GasSLX  | Fleetline   | GasSLX  |

**MACK(Cont'd.)**

**Granite Series(Cont'd.)**

|         |  |  |     |       |     |     |       |       |
|---------|--|--|-----|-------|-----|-----|-------|-------|
| 08 - 10 | GU-713 or GU-813 Models with 20,000 lb Front Axles                             | 14QK-427M<br>20863239<br>25626048<br>47170000445 | 01- | 85080 | ... |     | ...   | ...   |
|         |  |  | 01- | 85080 | ... |     | ...   | ...   |
|         |  |  | 01- | 85080 | ... |     | ...   | ...   |
|         |  |  | 01- | 85080 | ... |     | ...   | ...   |
| 08 - 19 | GU-713 or GU-813 Models with Hendrickson 38,000 lb Rear Air Suspension         | 14QK-424M<br>20570098<br>60670-006<br>60670-006L |     | ...   | ... | 010 | 83147 | ...   |
|         |  |  |     | ...   | ... | 010 | 83147 | ...   |
|         |  |  |     | ...   | ... | 010 | 83147 | ...   |
|         |  |  |     | ...   | ... | 010 | 83147 | ...   |
| 08 - 18 | GU-713 or GU-813 Models with Hendrickson HAS 400 or 460 Series Rear Suspension | 60675-001<br>60675-001L<br>8083872               |     | ...   | ... | 010 | 85978 | ...   |
|         |  |  |     | ...   | ... | 010 | 85978 | ...   |
|         |  |  |     | ...   | ... | 010 | 85978 | ...   |
| 08 - 18 | GU-713 or GU-813 Models with Hendrickson HAS Series Rear Suspension            | 22314111<br>60675-13                             |     | ...   | ... | 010 | 85036 | 89405 |
|         |  |  |     | ...   | ... | 010 | 85036 | 89405 |
| - 2019  | Models with Hendrickson HMX 400/460 Haulmax with 16.5" Saddle                  | 60680-004<br>60680-004L<br>H60680004             |     | ...   | ... | 01- | 83143 | ...   |
|         |  |  |     | ...   | ... | 01- | 83143 | ...   |
|         |  |  |     | ...   | ... | 01- | 83143 | ...   |
| - 2019  | Models with Hendrickson HMX 400/460 Haulmax with 17.5" or 18.5" Saddle Height  | 60680-005<br>60680-005L<br>H60680005             |     | ...   | ... | 01- | 83142 | ...   |
|         |  |  |     | ...   | ... | 01- | 83142 | ...   |
|         |  |  |     | ...   | ... | 01- | 83142 | ...   |
|         | Models with O.E.M. Number  | 21979343<br>471700008934                         |     | ...   | ... | 01- | 85065 | ...   |





**LE & LEU Series**

|         |   |                                      |     |       |       |     |       |     |
|---------|---|--------------------------------------|-----|-------|-------|-----|-------|-----|
|         | LE & LEU 613 Models with Ridewell RD-202S HD Tandem Drive Truck Suspension    | 1252607B000                          |     | ...   | ...   | 010 | 85702 | ... |
| 01 - 06 | LE 613 Models with O.E.M Number   | 14QK-366P4<br>25625187               | 010 | 83209 | 89414 |     | ...   | ... |
|         |   |                                      | 010 | 83209 | 89414 |     | ...   | ... |
| 2009    | LEU 613 Models with 18,000 lb Front Axle                                      | 14QK-372M2<br>25632561               | 010 | 83209 | 89414 |     | ...   | ... |
|         |   |                                      | 010 | 83209 | 89414 |     | ...   | ... |
| 10 - 16 | LEU 613 Models with 20,000 lb Front Axle                                      | 21002497                             | 010 | 85972 | ...   |     | ...   | ... |
|         | Models with Hendrickson HMX 400/460 Haulmax with 16.5" Saddle                 | 60680-004<br>60680-004L<br>H60680004 |     | ...   | ...   | 01- | 83143 | ... |
|         |   |                                      |     | ...   | ...   | 01- | 83143 | ... |
|         |   |                                      |     | ...   | ...   | 01- | 83143 | ... |
|         | Models with Hendrickson HMX 400/460 Haulmax with 17.5" or 18.5" Saddle Height | 60680-005<br>60680-005L<br>H60680005 |     | ...   | ...   | 01- | 83142 | ... |
|         |   |                                      |     | ...   | ...   | 01- | 83142 | ... |
|         |   |                                      |     | ...   | ...   | 01- | 83142 | ... |

**MH Series**

|  |  |   |     |       |       |     |       |       |
|--|--|---|-----|-------|-------|-----|-------|-------|
|  | MH Models - 4" Wide Springs                          | 14QK-373<br>14QK-378M<br>25623321   | 010 | 83215 | ...   |     | ...   | ...   |
|  |  |   | 010 | 83215 | ...   |     | ...   | ...   |
|  |  |   | 010 | 83215 | ...   |     | ...   | ...   |
|  | MH Models with Camelback Rear Suspension (SS34 & 38) | 14QK-2107P1<br>14QK-2107P2<br>25625091  |     | ...   | ...   | 010 | 83215 | ...   |
|  |  |   |     | ...   | ...   | 010 | 83215 | ...   |
|  |  |   |     | ...   | ...   | 010 | 83215 | ...   |
|  | MH Models with Neway ARD-234 Air Suspension          | 14QK-375M   |     | ...   | ...   | 010 | 83123 | 89405 |
|  | MH Models with O.E.M. Number                         | 14QK-2113P5<br>14QK-2133M<br>14QK-2133M2<br>14QK-377M<br>14QK-392AM<br>25622466 | 010 | 85001 | 89410 |     | ...   | ...   |
|  |  |   | 010 | 85001 | 89410 |     | ...   | ...   |
|  |  |   | 010 | 85001 | 89410 |     | ...   | ...   |
|  |  |   | 010 | 83215 | ...   |     | ...   | ...   |
|  |  |   | 010 | 85005 | ...   | 010 | 85005 | 89430 |
|  |  |   | 010 | 85001 | 89410 |     | ...   | ...   |
|  | MH Models with Taperleaf Rear Suspension             | 14QK-2113P4   |     | ...   | ...   | 010 | 85007 | 89412 |

## APPLICATION GUIDE - TRUCKS, TRAILERS, AND BUSES

| Year<br>Año<br>Année | Model<br>Modelo<br>Modèle | OEM # | Front  |  | Rear  |   |
|----------------------|---------------------------|-------|--|--|---|---|
|                      |                           |       |  |  |  |  |
|                      |                           |       | Fleetline  | GasSLX   | Fleetline   | GasSLX  |

### MACK(Cont'd.)

#### MR Series(Cont'd.)

|        |   |             |     |       |       |     |       |     |
|--------|---|-------------|-----|-------|-------|-----|-------|-----|
| - 2019 | MRU613 Models with 20,000 lb Front Axle | 14QK-3115M  | OIO | 85972 | ...   |     | ...   | ... |
|        |   | 21002497    | OIO | 85972 | ...   |     | ...   | ... |
|        | MRU613 Models with O.E.M. Number        | 14QK-366P4  | OIO | 83209 | 89414 |     | ...   | ... |
|        |   | 25625187    | OIO | 83209 | 89414 |     | ...   | ... |
| - 2019 | MRU613 Models with O.E.M. Number        | 21979343    |     | ...   | ...   | OIO | 85065 | ... |
|        |   | 47170008934 |     | ...   | ...   | OIO | 85065 | ... |

#### R Series

|  |  |            |     |       |       |     |       |     |
|--|--|------------|-----|-------|-------|-----|-------|-----|
|  | R, RU, RD600 Models-3 1/2" Wide springs  | 14QK-366P1 | OIO | 85036 | 89405 |     | ...   | ... |
|  | R, U Models  | .....      | OIO | 83221 | ...   | OIO | 83215 | ... |
|  | R, U, RD 600 Models  | 14QK-2115  | OIO | 85305 | ...   |     | ...   | ... |
|  |  | 14QK-29302 | OIO | 83207 | 89407 |     | ...   | ... |
|  |  | 25632147   | OIO | 85305 | ...   |     | ...   | ... |
|  | R, U, RD 600 Models/ MR600 Models with Front Taperleaf Springs                   | 14QK-366   | OIO | 85036 | 89405 |     | ...   | ... |
|  |  | 14QK-366P1 | OIO | 85036 | 89405 |     | ...   | ... |
|  |  | 25625151   | OIO | 85036 | 89405 |     | ...   | ... |
|  | RB 600 Models (Drive Axle)   | 14QK-2107  |     | ...   | ...   | OIO | 83215 | ... |
|  |  | 14QK-393M  |     | ...   | ...   | OIO | 85010 | ... |
|  | RD Models with ST34 Suspension   | 14QK-2133M | OIO | 85001 | 89410 |     | ...   | ... |
|  |  | 25622466   | OIO | 85001 | 89410 |     | ...   | ... |
|  | RD800 Models with Shock Absorbers & Taperleaf Suspension (SWT & SWTL 561)(ST-34) | 14QK-2110  | OIO | 85305 | ...   |     | ...   | ... |

#### RW Series

|  |  |             |     |       |       |     |       |       |
|--|--|-------------|-----|-------|-------|-----|-------|-------|
|  | RW Models - 4" Wide Springs                          | 14QK-373    | OIO | 83215 | ...   |     | ...   | ...   |
|  |  | 14QK-378M   | OIO | 83215 | ...   |     | ...   | ...   |
|  |  | 25623321    | OIO | 83215 | ...   |     | ...   | ...   |
|  | RW Models with Camelback Rear Suspension (SS34 & 38) | 14QK-2107P1 |     | ...   | ...   | OIO | 83215 | ...   |
|  |  | 14QK-2107P2 |     | ...   | ...   | OIO | 83215 | ...   |
|  |  | 25625091    |     | ...   | ...   | OIO | 83215 | ...   |
|  | RW Models with Neway ARD-234 Air Suspension          | 14QK-375M   |     | ...   | ...   | OIO | 83123 | 89405 |
|  | RW Models with O.E.M. Number                         | 14QK-2113P5 | OIO | 85001 | 89410 |     | ...   | ...   |
|  |  | 14QK-2133M  | OIO | 85001 | 89410 |     | ...   | ...   |
|  |  | 14QK-2133M2 | OIO | 85001 | 89410 |     | ...   | ...   |
|  |  | 14QK-377M   | OIO | 83215 | ...   |     | ...   | ...   |
|  |  | 14QK-392AM  | OIO | 85005 | ...   | OIO | 85005 | 89430 |
|  |  | 25622466    | OIO | 85001 | 89410 |     | ...   | ...   |
|  | RW Models with Taperleaf Rear Suspension             | 14QK-2113P4 |     | ...   | ...   | OIO | 85007 | 89412 |





#### TD - Titan Series

|         |   |            |     |       |     |     |       |       |
|---------|---|------------|-----|-------|-----|-----|-------|-------|
| 08 - 10 | TD-713 Models with 20,000 lb Front Axle   | 14QK-493M  | OIO | 83101 | ... |     | ...   | ...   |
|         |   | 21155033   | OIO | 83101 | ... |     | ...   | ...   |
| 10 - 15 | TD-713 Models with Hendrickson 38,000 lb Rear Air Suspension                      | 14QK-424M  |     | ...   | ... | OIO | 83147 | ...   |
|         |   | 20570098   |     | ...   | ... | OIO | 83147 | ...   |
|         |   | 60670-006  |     | ...   | ... | OIO | 83147 | ...   |
|         |   | 60670-006L |     | ...   | ... | OIO | 83147 | ...   |
| - 2016  | TD-713 Models with Hendrickson 40,000 lb Pimaax EX and FireMaax EX Air Suspension | 20782199   |     | ...   | ... | OIO | 85072 | ...   |
|         |   | 60657-007  |     | ...   | ... | OIO | 85072 | ...   |
| - 2017  | TD-713 Models with Hendrickson HAS 400 or 460 Series Rear Suspension              | 60675-001  |     | ...   | ... | OIO | 85978 | ...   |
|         |   | 60675-001L |     | ...   | ... | OIO | 85978 | ...   |
|         |   | 8083872    |     | ...   | ... | OIO | 85978 | ...   |
| - 2017  | TD-713 Models with Hendrickson HAS Series Rear Suspension                         | 22314111   |     | ...   | ... | OIO | 85036 | 89405 |
|         |   | 60675-13   |     | ...   | ... | OIO | 85036 | 89405 |

#### TERRAPRO Series

|      |                                  |            |     |       |     |  |     |     |
|------|----------------------------------|------------|-----|-------|-----|--|-----|-----|
| 2019 | Models with 20,000 lb Front Axle | 14QK-3115M | OIO | 85972 | ... |  | ... | ... |
|------|----------------------------------|------------|-----|-------|-----|--|-----|-----|

## APPLICATION GUIDE - TRUCKS, TRAILERS, AND BUSES

| Year<br>Año<br>Année | Model<br>Modelo<br>Modèle | OEM # | Front   |   | Rear  |   |
|----------------------|---------------------------|-------|---|---|---|---|
|                      |                           |       |  |  |  |  |
|                      |                           |       | Fleetline   | GasSLX  | Fleetline   | GasSLX  |

### MACK(Cont'd.)





#### TERRAPRO Series(Cont'd.)

|                                |   |              |     |       |       |     |       |       |
|--------------------------------|---|--------------|-----|-------|-------|-----|-------|-------|
| <b>2019</b>                    | Models with 20,000 lb Front Axle  | 21002497     | OIO | 85972 | ...   | OIO | 85305 | ...   |
| <b>Additional Applications</b> |   |              |     |       |       |     |       |       |
|                                | B Models  | 14QK-142     |     | ...   | ...   | OIO | 85305 | ...   |
|                                | CF Fire Chassis   | 14QK-2102    |     | ...   | ...   | OIO | 85304 | ...   |
|                                | CM 422 Tractor  | 14QK-390     | -IO | 83105 | ...   |     | ...   | ...   |
|                                |   | V10242320    | -IO | 83105 | ...   |     | ...   | ...   |
|                                | DM Models   | .....        | OIO | 83209 | 89414 | OIO | 83215 | ...   |
|                                | MB Models   | .....        | OIO | 83221 | ...   | OIO | 83215 | ...   |
|                                |   | 14QK-2100P4  | OIO | 83207 | 89407 |     | ...   | ...   |
|                                | Model 75 Bogie Axle   | .....        |     | ...   | ...   | OIO | 83215 | ...   |
| <b>06 - 16</b>                 | Models with Hendrickson 40,000 lb Primaax, Pimaax EX and FireMaax EX Air Suspension | 60657-007    |     | ...   | ...   | OIO | 85072 | ...   |
|                                | Models with Hendrickson AirTek Front Air Suspension                                 | 14QK-422M    | OIO | 85933 | 89454 |     | ...   | ...   |
|                                |   | 20469001     | OIO | 85933 | 89454 |     | ...   | ...   |
|                                |   | 20469002     | OIO | 85933 | 89454 |     | ...   | ...   |
|                                |   | 20485632     | OIO | 85933 | 89454 |     | ...   | ...   |
|                                |   | 20485633     | OIO | 85933 | 89454 |     | ...   | ...   |
|                                |   | 471700131921 | OIO | 85933 | 89454 |     | ...   | ...   |
|                                |   | 64838-002    | OIO | 85933 | 89454 |     | ...   | ...   |
|                                | Models with Hendrickson HAS-40LH Air Suspension (O.E. Number 57241-4)               | 14QK-413M4   |     | ...   | ...   | OIO | 83110 | ...   |
|                                | Models with Inverted Camelback Spring Suspension                                    | 14QK-142P1   | OIO | 83215 | ...   |     | ...   | ...   |
|                                | Models with MAC AL405 Suspension  | 14QK-413M    |     | ...   | ...   | OIO | 83111 | ...   |
|                                | Models with Meritor AirLink Suspension  | 14QK-3100    |     | ...   | ...   | OIO | 85739 | ...   |
|                                |   | 446-51-211   |     | ...   | ...   | OIO | 85739 | ...   |
|                                | Models with Neway Rear Suspension (With O.E.Stamping 90045099)                      | 25633154     |     | ...   | ...   | OIO | 85906 | 89407 |
| <b>75 - 79</b>                 | W Models - Western  | .....        | OIO | 83207 | 89407 | OIO | 83215 | ...   |

#### Additional O.E.M. Interchanges

|  |                           |              |     |       |       |     |       |     |
|--|---------------------------|--------------|-----|-------|-------|-----|-------|-----|
|  | Models with O.E.M. Number | 14QK-1200P4  | OIO | 83207 | 89407 |     | ...   | ... |
|  |                           | 14QK-140     | OIO | 85304 | ...   |     | ...   | ... |
|  |                           | 14QK-142AP1  | OIO | 83215 | ...   |     | ...   | ... |
|  |                           | 14QK-145     | OIO | 85307 | ...   |     | ...   | ... |
|  |                           | 14QK-2100P2  | OIO | 83209 | 89414 |     | ...   | ... |
|  |                           | 14QK-2100P3  | OIO | 83207 | 89407 |     | ...   | ... |
|  |                           | 14QK-2100P5  | OIO | 83221 | ...   |     | ...   | ... |
|  |                           | 14QK-2100P6  | OIO | 85036 | 89405 |     | ...   | ... |
|  |                           | 14QK-2100P7  | OIO | 83221 | ...   |     | ...   | ... |
|  |                           | 14QK-2105    | OIO | 83209 | 89414 |     | ...   | ... |
|  |                           | 14QK-2107P3  | OIO | 83215 | ...   |     | ...   | ... |
|  |                           | 14QK-2108    | OIO | 83203 | 89436 |     | ...   | ... |
|  |                           | 14QK-2108P1  | OIO | 83203 | 89436 |     | ...   | ... |
|  |                           | 14QK-2113P3  | OIO | 85001 | 89410 |     | ...   | ... |
|  |                           | 14QK-288-P1  | OIO | 85007 | 89412 |     | ...   | ... |
|  |                           | 14QK-29001P2 | OIO | 85303 | 89422 |     | ...   | ... |
|  |                           | 14QK-29301P1 | OIO | 83207 | 89407 |     | ...   | ... |
|  |                           | 14QK-29301P2 | OIO | 83207 | 89407 |     | ...   | ... |
|  |                           | 14QK-366P2   | OIO | 85036 | 89405 |     | ...   | ... |
|  |                           | 14QK-366P3   | OIO | 85036 | 89405 |     | ...   | ... |
|  |                           | 14QK-372M3   | OIO | 83122 | 89406 |     | ...   | ... |
|  |                           | 14QK-378     | OIO | 83215 | ...   |     | ...   | ... |
|  |                           | 14QK-423M    |     | ...   | ...   | OIO | 85978 | ... |
|  |                           | 14QK-428     | OIO | 85080 | ...   |     | ...   | ... |
|  |                           | 14QK-428M    | OIO | 85080 | ...   |     | ...   | ... |
|  |                           | 25621571     | OIO | 83215 | ...   |     | ...   | ... |

**APPLICATION GUIDE - TRUCKS, TRAILERS, AND BUSES**

| Year<br>Año<br>Année | Model<br>Modelo<br>Modèle | OEM # | Front   |   | Rear   |   |
|----------------------|---------------------------|-------|---|---|--|---|
|                      |                           |       |  |  |  |  |
|                      |                           |       | Fleetline   | GasSLX  | Fleetline  | GasSLX  |

**MACK(Cont'd.)**

**Additional O.E.M. Interchanges(Cont'd.)**

|                                |               |                       |                       |              |     |              |
|--------------------------------|---------------|-----------------------|-----------------------|--------------|-----|--------------|
| Models with O.E.M. Number      | 25626149      | 01-                   | <b>85080</b>          | ...          | ... | ...          |
|                                | 471700000451  | 01-                   | <b>85080</b>          | ...          | ... | ...          |
|                                | 57241-004     |                       | ...                   | ...          | 01- | <b>83110</b> |
|                                | 5966-90044025 | 010                   | <b>83209</b>          | <b>89414</b> | ... | ...          |
|                                | 651103        | 010                   | <b>85036</b>          | <b>89405</b> | ... | ...          |
| Additional O.E.M. Interchanges | 14QK-140P1    | 010                   | <b>83225</b>          |              |     |              |
|                                | 14QK-20001P2  | 010                   | <b>85308 or 89422</b> |              |     |              |
|                                | 14QK-2100     | 010                   | <b>83221</b>          |              |     |              |
|                                | 14QK-2100P1   | 010                   | <b>83221</b>          |              |     |              |
|                                | 14QK-2110P1   | 010                   | <b>85305</b>          |              |     |              |
|                                | 14QK-282P1    | 010                   | <b>83216</b>          |              |     |              |
|                                | 14QK-282P3    | 010                   | <b>83216</b>          |              |     |              |
|                                | 14QK-288P2    | 010                   | <b>83217</b>          |              |     |              |
|                                | 14QK-29302P1  | 010                   | <b>83207 or 89407</b> |              |     |              |
|                                | 14QK-372M     | 010                   | <b>83221</b>          |              |     |              |
|                                | 14QK-392M     | 010                   | <b>85005 or 89430</b> |              |     |              |
|                                | 25624365      | 010                   | <b>83217</b>          |              |     |              |
|                                | 4940654       | 010                   | <b>83216</b>          |              |     |              |
|                                | 5533699       | 010                   | <b>85302 or 89420</b> |              |     |              |
|                                | 5554184       | 010                   | <b>85302 or 89420</b> |              |     |              |
|                                | 650102        | 010                   | <b>85001 or 89410</b> |              |     |              |
|                                | 650107        | -10                   | <b>85316 or 89426</b> |              |     |              |
|                                | 650107MT      | -10                   | <b>85316 or 89426</b> |              |     |              |
|                                | 650400MT      | -10                   | <b>85033 or 89427</b> |              |     |              |
|                                | 650402        | -10                   | <b>85311 or 89424</b> |              |     |              |
|                                | 650402MT      | -10                   | <b>85311 or 89424</b> |              |     |              |
|                                | 650404        | -1-                   | <b>85310 or 89423</b> |              |     |              |
|                                | 650404MT      | -1-                   | <b>85310 or 89423</b> |              |     |              |
|                                | 650405        | 010                   | <b>85023 or 89415</b> |              |     |              |
|                                | 650405MT      | 010                   | <b>85023 or 89415</b> |              |     |              |
|                                | 650406        | 010                   | <b>85024</b>          |              |     |              |
| 650408                         | -10           | <b>85319 or 89428</b> |                       |              |     |              |
| 650408MT                       | -10           | <b>85319 or 89428</b> |                       |              |     |              |
| 651012                         | 010           | <b>83221</b>          |                       |              |     |              |
| 651151                         | 010           | <b>83209 or 89414</b> |                       |              |     |              |
| 70042                          | 010           | <b>85302 or 89420</b> |                       |              |     |              |

**MACK CAB SHOCKS**

**CH Series**

|                           |            |     |              |
|---------------------------|------------|-----|--------------|
| Models with O.E.M. Number | 14QK-411   | 010 | <b>83007</b> |
|                           | 14QK-411AM | 010 | <b>83007</b> |
|                           | 14QK-411M  | 010 | <b>83007</b> |
|                           | 25631922   | 010 | <b>83007</b> |

**CHN - Series**





|         |                                   |            |     |              |
|---------|-----------------------------------|------------|-----|--------------|
| 05 - 07 | CHN-613 Models with O.E.M. Number | 14QK-3103M | 01- | <b>83050</b> |
|         |                                   | 20874147   | 01- | <b>83050</b> |

**CHU - Pinnacle Series**

|         |   |           |     |              |
|---------|---|-----------|-----|--------------|
| - 2017  | CHU-613 DayCab Models with O.E.M. Number                      | 22662259  | 010 | <b>83901</b> |
| - 2018  | CHU-613 DayCab Models with O.E.M. Number                      | 22662254  | 010 | <b>83901</b> |
| - 2019  | CHU-613 DayCab Models with O.E.M. Number                      | 21490486  | 010 | <b>83066</b> |
| - 2017  | CHU-613 Models with Hi - Roof Sleeper Cabs with O.E.M. Number | 25625636  | 01- | <b>83045</b> |
| - 2019  | CHU-613 Models with O.E.M. Number                             | 21345869  | 010 | <b>83066</b> |
|         |   | 23145372  | 010 | <b>83066</b> |
| 08 - 19 | CHU-613 Models with O.E.M. Number                             | 14QK-303M | 01- | <b>83050</b> |



**APPLICATION GUIDE - TRUCKS, TRAILERS, AND BUSES**

| Year<br>Año<br>Année | Model<br>Modelo<br>Modèle | OEM # | Front   |   | Rear  |   |
|----------------------|---------------------------|-------|---|---|---|---|
|                      |                           |       |  |  |  |  |
|                      |                           |       | Fleetline   | GasSLX  | Fleetline   | GasSLX  |

**MACK CAB SHOCKS(Cont'd.)**

**CHU - Pinnacle Series(Cont'd.)**

|         |                                   |            |     |       |
|---------|-----------------------------------|------------|-----|-------|
| 08 - 19 | CHU-613 Models with O.E.M. Number | 14QK-3103M | 01- | 83050 |
|         |                                   | 20874147   | 01- | 83050 |

**CL Series**

|  |                           |             |     |       |
|--|---------------------------|-------------|-----|-------|
|  | Models with O.E.M. Number | 14QK-391AM  | 01- | 83041 |
|  |                           | 14QK-391AM2 | 01- | 83041 |

**CT, CTX - Series**

|  |                           |            |     |       |
|--|---------------------------|------------|-----|-------|
|  | Models with O.E.M. Number | 14QK-303M  | 01- | 83050 |
|  |                           | 14QK-3103M | 01- | 83050 |
|  |                           | 20874147   | 01- | 83050 |

**CX (Vision) Series**

|  |   |            |     |       |
|--|---|------------|-----|-------|
|  | Models with Sleeper Cabs w/O.E.M. Numbers | 14QK-399M  | 01- | 83045 |
|  |   | 14QK-399M2 | 01- | 83045 |
|  |   | 14QK-399M3 | 01- | 83045 |
|  |   | 25625635   | 01- | 83045 |
|  |   | 25625636   | 01- | 83045 |
|  |   | 25625637   | 01- | 83045 |

**CXN Series**

|         |   |            |     |       |
|---------|---|------------|-----|-------|
| 05 - 08 | CXN-613 Models with O.E.M. Number         | 14QK-3103M | 01- | 83050 |
|         |   | 20874147   | 01- | 83050 |
|         | DayCab Models with O.E.M. Number          | 21345869   | 010 | 83066 |
| - 2014  | Models with Sleeper Cabs w/O.E.M. Numbers | 25625635   | 01- | 83045 |

**CXP - Series**

|         |                                  |            |     |       |
|---------|----------------------------------|------------|-----|-------|
| 06 - 07 | CXP-613 Day Cab Models           | 14QK-3103M | 01- | 83050 |
|         |                                  | 20874147   | 01- | 83050 |
| 06 - 07 | CXP-613 Models with Sleeper Cabs | 25625636   | 01- | 83045 |

**CXU - Pinnacle Series**

|           |  |            |     |       |
|-----------|--|------------|-----|-------|
| 2008 - 17 | CXU-613 Models with Hi - Roof Sleeper Cabs with O.E.M. Number  | 25625636   | 01- | 83045 |
| 2011 - 16 | CXU-613 Models with Mid - Roof Sleeper Cabs with O.E.M. Number | 25625635   | 01- | 83045 |
|           |  |            |     |       |
|           | CXU-613 Models with O.E.M. Number                              | 22662259   | 010 | 83901 |
| - 2018    | CXU-613 Models with O.E.M. Number                              | 22662254   | 010 | 83901 |
| - 2019    | CXU-613 Models with O.E.M. Number                              | 21345869   | 010 | 83066 |
|           |  | 21490486   | 010 | 83066 |
|           |  | 23145372   | 010 | 83066 |
| 08 - 11   | CXU-613 Models with O.E.M. Number                              | 14QK-303M  | 01- | 83050 |
|           |  | 14QK-3103M | 01- | 83050 |
|           |  | 20874147   | 01- | 83050 |









**Granite Series**

|         |   |           |     |       |
|---------|---|-----------|-----|-------|
| 18 - 17 | Granite 64BR & 64FR Models with O.E.M. Number | 22662259  | 010 | 83901 |
| 12 - 17 | GU 432 and GU 533 Models with O.E.M. Number   | 22662259  | 010 | 83901 |
| 08 - 17 | GU 713 and GU 813 Models with O.E.M. Number   | 21345869  | 010 | 83066 |
|         |   | 21490486  | 010 | 83066 |
|         |   | 21490486  | 010 | 83066 |
|         |   | 22662259  | 010 | 83901 |
| 08 - 18 | GU 713 and GU 813 Models with O.E.M. Number   | 22662254  | 010 | 83901 |
| 08 - 19 | GU 713 and GU 813 Models with O.E.M. Number   | 20873442  | 01- | 83050 |
| 2008 -  | GU 713 and GU 813 Models with O.E.M. Number   | 14QK-432M | 01- | 83050 |

**R - Series**

|  |  |              |     |       |
|--|--|--------------|-----|-------|
|  | R 600 Tractors with Link Cabmate Model MCR600            | 1201-0012    | 010 | 83023 |
|  |  | 1202-0012    | 010 | 83023 |
|  | R, RD Models   | 14QK-382     | 01- | 83018 |
|  |  | 14QK-382-P2  | 01- | 83018 |
|  | R, RD400 & 600 Models with Cab Air suspension            | 14QK-2111-P4 | 01- | 83019 |
|  | RS & Superliner Tractors with Link Cabmate Model MCRS600 | 1201-0012    | 010 | 83023 |

## APPLICATION GUIDE - TRUCKS, TRAILERS, AND BUSES

| Year<br>Año<br>Année | Model<br>Modelo<br>Modèle | OEM # | Front  |  | Rear  |   |
|----------------------|---------------------------|-------|--|--|---|---|
|                      |                           |       |  |  |  |  |
|                      |                           |       |   |   |  |  |
|                      |                           |       | Fleetline  | GasSLX   | Fleetline   | GasSLX  |

### MACK CAB SHOCKS(Cont'd.)

#### R - Series(Cont'd.)

|  |           |     |              |
|--|-----------|-----|--------------|
| RS & Superliner Tractors with Link Cabmate Model MCRS600 | 1202-0012 | 010 | <b>83023</b> |
|--|-----------|-----|--------------|

#### TD - Titan Series

|   |           |     |              |
|---|-----------|-----|--------------|
| - 2017 TD - Titan Models with O.E.M. Number | 14QK-440M | 01- | <b>83058</b> |
|   | 21154397  | 01- | <b>83058</b> |

#### Additional Applications

|   |              |              |              |
|---|--------------|--------------|--------------|
| 02 - 07 CV-713 Models with O.E.M number | 14QK-391BM   | 01-          | <b>83041</b> |
| MH Models with Air Cab                  | 14QK-374     | -10          | <b>83003</b> |
|   | 14QK-376     | -10          | <b>83003</b> |
| Models with Link Cab Suspension         | 1202-0012    | 010          | <b>83023</b> |
|   | 1202-0032    | 010          | <b>83016</b> |
| Models with O.E.M. Number               | 14QK-2111    | 01-          | <b>83019</b> |
|   | 14QK-2111-P2 | 01-          | <b>83019</b> |
|   | 14QK-391BM2  | 01-          | <b>83041</b> |
|   | 14QK-391M    | 01-          | <b>83041</b> |
|   | 14QK-391M2   | 01-          | <b>83041</b> |
|   | 14QK-397AM   | 010          | <b>83905</b> |
|   | 14QK-439M    | 01-          | <b>83050</b> |
|   | 21154393     | 01-          | <b>83050</b> |
|   | 21345868     | 010          | <b>83066</b> |
|   | 25622373     | 010          | <b>83905</b> |
|   | 25622612     | 01-          | <b>83041</b> |
|   | 25622613     | 01-          | <b>83041</b> |
| 25624837                                | 01-          | <b>83041</b> |              |

### MAECO

|                                 |         |     |              |     |                       |                       |              |
|---------------------------------|---------|-----|--------------|-----|-----------------------|-----------------------|--------------|
| Bus with O.E.M. Number          | 1668722 | 010 | <b>85030</b> | ... | 010                   | <b>85030</b>          | <b>89440</b> |
| FedEx Trucks with O.E.M. Number | 16950   | 010 | <b>83118</b> | ... |                       | ...                   | ...          |
| UPS Trucks with O.E.M. Number   | 16949   |     | ...          | ... | 01-                   | <b>83120</b>          | ...          |
| Additional O.E.M. Interchanges  | 1085    | 010 |              |     |                       | <b>83214</b>          |              |
|                                 | 12608   | 010 |              |     |                       | <b>83125</b>          |              |
|                                 | 12788   | 010 |              |     |                       | <b>83216</b>          |              |
|                                 | 12866   | 010 |              |     |                       | <b>83207 or 89407</b> |              |
|                                 | 16385   | 010 |              |     |                       | <b>83215</b>          |              |
|                                 | 16720   | 010 |              |     |                       | <b>83107</b>          |              |
|                                 | 16767   | 010 |              |     |                       | <b>85013 or 89414</b> |              |
|                                 | 16768   | 010 |              |     |                       | <b>83217</b>          |              |
|                                 | 16769   | 010 |              |     |                       | <b>83221</b>          |              |
|                                 | 16770   | 010 |              |     |                       | <b>83209 or 89414</b> |              |
|                                 | 16771   | 010 |              |     |                       | <b>83126 or 89430</b> |              |
|                                 | 16772   | 010 |              |     |                       | <b>83122 or 89406</b> |              |
|                                 | 16773   | 010 |              |     |                       | <b>85005 or 89430</b> |              |
|                                 | 16774   | 010 |              |     |                       | <b>83215</b>          |              |
|                                 | 16775   | 010 |              |     |                       | <b>83207 or 89407</b> |              |
|                                 | 16776   | 010 |              |     |                       | <b>83122 or 89406</b> |              |
|                                 | 16777   | 010 |              |     |                       | <b>85006</b>          |              |
|                                 | 16778   | 010 |              |     |                       | <b>83203 or 89436</b> |              |
|                                 | 16779   | 010 |              |     |                       | <b>83126 or 89440</b> |              |
|                                 | 16780   | 010 |              |     |                       | <b>83123 or 89405</b> |              |
|                                 | 16781   | 010 |              |     |                       | <b>85006</b>          |              |
|                                 | 16787   | 010 |              |     |                       | <b>85030 or 89440</b> |              |
|                                 | 6025    | 010 |              |     |                       | <b>83122 or 89406</b> |              |
| 6026                            | 010     |     |              |     | <b>83204</b>          |                       |              |
| 70018                           | 010     |     |              |     | <b>85303 or 89422</b> |                       |              |
| 70021                           | 010     |     |              |     | <b>85303 or 89422</b> |                       |              |

## APPLICATION GUIDE - TRUCKS, TRAILERS, AND BUSES

| Year<br>Año<br>Année | Model<br>Modelo<br>Modèle | OEM # | Front     |        | Rear      |        |
|----------------------|---------------------------|-------|-----------|--------|-----------|--------|
|                      |                           |       |           |        |           |        |
|                      |                           |       | Fleetline | GasSLX | Fleetline | GasSLX |

### MAECO(Cont'd.)





|         |                                |         |     |                |
|---------|--------------------------------|---------|-----|----------------|
|         | Additional O.E.M. Interchanges | 70029   | 010 | 85308 or 89422 |
|         |                                | 70034   | 010 | 85302 or 89420 |
|         |                                | 70039   | 010 | 85303 or 89422 |
|         |                                | 70041   | 010 | 85305          |
|         |                                | 70042   | 010 | 85302 or 89420 |
|         |                                | 70088   | 010 | 85307          |
|         |                                | 70123   | 010 | 85716          |
|         |                                | 70127   | 010 | 85006 or 89401 |
|         |                                | 70128   | 010 | 85006 or 89401 |
|         |                                | 70162   | 010 | 85716          |
|         |                                | 70163   | 010 | 85302 or 89420 |
|         |                                | 70164   | 010 | 85716          |
|         |                                | 70300   | 010 | 85320 or 89429 |
|         |                                | 70312   | 010 | 85001 or 89410 |
|         |                                | 70315   | 010 | 85063          |
|         |                                | 70317   | 010 | 89432          |
|         |                                | 70331   | 010 | 85314 or 89425 |
|         |                                | 70332   | 010 | 83314          |
|         |                                | 70334   | 110 | 85316 or 89426 |
|         |                                | 70397   | 010 | 85006          |
|         |                                | 70402   | 010 | 85305          |
|         |                                | 70642   | 010 | 85300 or 89419 |
|         |                                | 70644   | 010 | 85334          |
|         |                                | 70646   | 010 | 85313          |
|         |                                | 70648   | 010 | 89414          |
|         |                                | 70650   | 010 | 89440          |
|         |                                | 70651   | 010 | 85013 or 89414 |
|         |                                | 70652   | 010 | 85030 or 89440 |
|         |                                | 70663   | 010 | 85013 or 89414 |
|         |                                | 70691   | 010 | 85007 or 89412 |
|         |                                | 70720   | 010 | 85934          |
|         |                                | 70721   | 010 | 83125          |
|         |                                | 74039   | 010 | 85303 or 89422 |
|         |                                | OE10881 | 110 | 85711          |
|         |                                | OE10882 | 011 | 85740          |
| OE10883 | 010                            | 85339   |     |                |
| OE12425 | 010                            | 83214   |     |                |
| SC-2920 | 010                            | 83176   |     |                |

### MANDALAY COACH

#### Class A MotorHomes

|                |  |              |       |   |              |               |       |     |               |
|----------------|--|--------------|-------|---|--------------|---------------|-------|-----|---------------|
| <b>04 - 06</b> | Mandalay Series MotorHomes with Freightliner XC Chassis            |              |       |   |              |               |       |     |               |
|                |  |              |       | ADL200 Suspension w/ 20K Rear                           | 16-16873-000 |               |       |     |               |
|                |  |              |       | AS120 Front Suspension                                  | 141700131810 | 010           | 83160 | ... | ...           |
|                |  |              |       |   | 16-16737-000 | 010           | 83160 | ... | ...           |
|                |  |              |       |   | 16-16874-000 | 010           | 83160 | ... | ...           |
|                |  |              |       | Rear Shock with O.E.M. Number                           | 141700131809 |               | ...   | ... | 010 85029 ... |
|                |  |              |       |   | 16-16736-000 |               | ...   | ... | 010 85029 ... |
|                |  |              |       | ZF - IFS Front Suspension with 23,000 lb GVW or Greater | 16-18103-000 | 111           | 85900 | ... | ...           |
|                | 481700000493   | 111          | 85900 | ...   | ...          |               |       |     |               |
| <b>2006</b>    | Presidio & Valencia Series MotorHomes with Freightliner XC Chassis |              |       |   |              |               |       |     |               |
|                |  |              |       | AS120 Front Suspension                                  | 141700131810 | 010           | 83160 | ... | ...           |
|                |  |              |       |   | 16-16737-000 | 010           | 83160 | ... | ...           |
|                |  |              |       |   | 16-16874-000 | 010           | 83160 | ... | ...           |
|                | Rear Shock with O.E.M. Number                                      | 141700131809 |       | ...   | ...          | 010 85029 ... |       |     |               |

**APPLICATION GUIDE - TRUCKS, TRAILERS, AND BUSES**

| Year<br>Año<br>Année | Model<br>Modelo<br>Modèle | OEM # | Front   |  | Rear  |   |
|----------------------|---------------------------|-------|---|--|---|---|
|                      |                           |       |  |  |  |  |
|                      |                           |       | Fleetline   | GasSLX   | Fleetline   | GasSLX  |

**MANDALAY COACH(Cont'd.)**

**Class A MotorHomes(Cont'd.)**

|      |   |              |     |       |     |     |       |     |
|------|---|--------------|-----|-------|-----|-----|-------|-----|
| 2006 | AS120 Front Suspension                                  | 16-16736-000 |     | ...   | ... | 010 | 85029 | ... |
|      | ZF - IFS Front Suspension with 23,000 lb GVW or Greater | 16-18103-000 | -1- | 85900 | ... |     | ...   | ... |
|      |   | 48170000493  | -1- | 85900 | ... |     | ...   | ... |

**MARMON**

|                           |           |     |       |       |     |       |       |
|---------------------------|-----------|-----|-------|-------|-----|-------|-------|
| Models with O.E.M. Number | 1-7001    | 010 | 83216 | ...   |     | ...   | ...   |
|                           | 37-1-1    | 010 | 83122 | 89406 |     | ...   | ...   |
|                           | 51-139-28 |     | ...   | ...   | 010 | 85003 | 89411 |
|                           | 51-163-7  |     | ...   | ...   | 010 | 83123 | 89405 |
|                           | 576451    | 010 | 83122 | 89406 |     | ...   | ...   |
|                           | 665147    | 010 | 83216 | ...   |     | ...   | ...   |

**MARMON CAB SHOCKS**

|        |  |           |     |       |  |  |  |
|--------|--|-----------|-----|-------|--|--|--|
| 1981 - | Conventional Tractors with Link Cabmate Model MARC57-B | 1202-0054 | 010 | 83021 |  |  |  |
|--------|--|-----------|-----|-------|--|--|--|





**MATSON SCHOOL BUS**

|  |                           |         |     |       |       |  |     |     |
|--|---------------------------|---------|-----|-------|-------|--|-----|-----|
|  | Models with O.E.M. Number | 5392387 | 010 | 85303 | 89422 |  | ... | ... |
|--|---------------------------|---------|-----|-------|-------|--|-----|-----|

**MC NEILUS TRUCK & MAN.**

|                       |              |     |       |       |     |       |       |
|-----------------------|--------------|-----|-------|-------|-----|-------|-------|
| Mc Neilus part number | 1139039 MTM  | 010 | 85334 | ...   |     | ...   | ...   |
|                       | 1139046 MTM  |     | ...   | ...   | 01- | 83112 | ...   |
|                       | 1139059 MTM  |     | ...   | ...   | 010 | 83207 | 89407 |
|                       | 1139069 MTM  |     | ...   | ...   | 010 | 83209 | 89414 |
|                       | 12405FX1 MTM |     | 85303 | ...   | 010 | 85303 | 89422 |
|                       | 1323106 MTM  |     | ...   | ...   | 010 | 85305 | ...   |
|                       | 1333575 MTM  |     | ...   | ...   | 010 | 85072 | ...   |
|                       | 1340975 MTM  |     | ...   | ...   | 01- | 83142 | ...   |
|                       | 1340976 MTM  | 010 | 85919 | ...   |     | ...   | ...   |
|                       | 1340979 MTM  |     | ...   | ...   | 01- | 83143 | ...   |
|                       | 1360386 MTM  |     | ...   | ...   | 010 | 85323 | 89436 |
|                       | 1367383 MTM  |     | ...   | ...   | 010 | 83147 | ...   |
|                       | 1396513 MTM  | 010 | 85959 | ...   |     | ...   | ...   |
|                       | 1398980 MTM  |     | ...   | ...   | 010 | 83127 | ...   |
|                       | 1404068 MTM  |     | ...   | ...   | 010 | 85980 | ...   |
|                       | 1404068 MTM  |     | ...   | ...   | 010 | 85087 | ...   |
|                       | 1410046 MTM  | 010 | 85919 | ...   |     | ...   | ...   |
|                       | 1411765 MTM  |     | ...   | ...   | 010 | 83148 | ...   |
|                       | 1412744 MTM  |     | ...   | ...   | 010 | 85966 | ...   |
|                       | 1429317 MTM  | 010 | 85919 |       |     | ...   | ...   |
|                       | 1431085 MTM  |     | ...   | ...   | 010 | 85738 | ...   |
|                       | 1432386 MTM  |     | ...   | ...   | 010 | 85965 | ...   |
|                       | 1433009 MTM  |     | ...   | ...   | 010 | 85962 | ...   |
|                       | 1468783 MTM  |     | ...   | ...   | 010 | 85345 | ...   |
|                       | 1485576 MTM  |     | ...   | ...   | 010 | 85979 | ...   |
|                       | 1491909 MTM  |     | ...   | ...   | 010 | 83128 | 89436 |
|                       | 1KK552 MTM   |     | ...   | ...   | 010 | 85967 | ...   |
|                       | 2218640 MTM  | 010 | 83009 |       |     | ...   | ...   |
|                       | 3215395 MTM  |     | ...   | ...   | 01- | 83112 | ...   |
|                       | 3HR582 MTM   |     | ...   | ...   | 010 | 85013 | 89414 |
|                       | 3HR582 MTM   |     | ...   | ...   | 010 | 85013 | 89414 |
|                       | 3HR916 MTM   |     | ...   | ...   | 010 | 83207 | 89407 |
|                       | 4HA569 MTM   | 010 | 85932 | 89453 |     | ...   | ...   |
|                       | 4KP398 MTM   | 010 | 85933 | 89454 |     | ...   | ...   |
|                       | 5HA994 MTM   |     | ...   | ...   | 010 | 85916 | 89430 |
|                       | 5HB645 MTM   |     | ...   | ...   | 01- | 83109 | ...   |

**APPLICATION GUIDE - TRUCKS, TRAILERS, AND BUSES**

| Year<br>Año<br>Année | Model<br>Modelo<br>Modèle | OEM # | Front   |   | Rear  |   |
|----------------------|---------------------------|-------|---|---|---|---|
|                      |                           |       |  |  |  |  |
|                      |                           |       | Fleetline   | GasSLX  | Fleetline   | GasSLX  |

**MC NEILUS TRUCK & MAN.(Cont'd.)**

|                       |                           |        |     |                |       |       |
|-----------------------|---------------------------|--------|-----|----------------|-------|-------|
| Mc Neilus part number | 5KK247 MTM                | ...    | ... | 01-            | 85977 | ...   |
|                       | 64442AX MTM               | ...    | ... | 010            | 83128 | 89436 |
|                       | 6HA961 MTM                | ...    | ... | 010            | 83123 | 89405 |
|                       | 6HB390 MTM                | ...    | ... | 010            | 83137 | ...   |
|                       | 6HD720 MTM                | ...    | ... | 010            | 85909 | ...   |
|                       | 6HS773 MTM                | ...    | ... | 010            | 83122 | 89406 |
|                       | 6KP857 MTM                | ...    | ... | 010            | 85000 | 89436 |
|                       | 7HS237 MTM                | ...    | ... | 010            | 83122 | 89406 |
|                       | 7HS534 MTM                | ...    | ... | 010            | 85906 | 89407 |
|                       | 8KK524 MTM                | ...    | ... | 010            | 83168 | ...   |
|                       | 9HB362 MTM                | ...    | ... | 010            | 85976 | ...   |
|                       | 9KK464 MTM                | ...    | ... | 010            | 85079 | ...   |
|                       | Models with O.E.M. Number | 217330 | 010 | 85303 or 89422 |       |       |

**MERITOR**

|   |              |     |     |     |       |     |
|---|--------------|-----|-----|-----|-------|-----|
| Air Link Suspensions with O.E.M. Number     | 14QK-3100    | ... | ... | 010 | 85739 | ... |
|   | 446-51-211   | ... | ... | 010 | 85739 | ... |
| AL460 Air Link Suspension                   | 700115       | ... | ... | 010 | 85712 | ... |
| AL520 Air Link Suspension                   | 700115       | ... | ... | 010 | 85712 | ... |
| RC S 9L Suspension                          | 21228392     | ... | ... | 010 | 86201 | ... |
|   | 671500       | ... | ... | 010 | 86201 | ... |
| RFS 23T / 25T / 30T Trailer Air Suspensions | 21227751     | ... | ... | 010 | 87015 | ... |
|   | A-7805L-1026 | ... | ... | 010 | 87015 | ... |

**FlexAir 9NB Suspension**

|   |          |     |     |     |       |     |
|---|----------|-----|-----|-----|-------|-----|
| FlexAir 9NB Suspension with O.E.M. Number | 21224745 | ... | ... | 010 | 86203 | ... |
|   | 21224778 | ... | ... | 010 | 86202 | ... |
|   | 671502   | ... | ... | 010 | 86202 | ... |
|   | 671503   | ... | ... | 010 | 86203 | ... |

**FS230 Trailer Suspension**

|  |              |     |     |     |       |     |
|--|--------------|-----|-----|-----|-------|-----|
| FS230 Trailer Suspension (Light Duty)                        | 680705       | ... | ... | 010 | 85737 | ... |
|  | A-7805P-1030 | ... | ... | 010 | 85737 | ... |
| FS230 Trailer Suspension (Std Duty)                          | 671507       | ... | ... | 010 | 87015 | ... |
|  | A-7805L-1026 | ... | ... | 010 | 87015 | ... |
| FS230T   | 21227751     | ... | ... | 010 | 87015 | ... |
|  | 671020       | ... | ... | 010 | 87015 | ... |
| Meritor Kit 11210 includes washers and nuts (For Shock only) | KIT11210     | ... | ... | 010 | 87015 | ... |

**MTA 25T / MTA 30T Trailer Air Suspension**

|  |              |     |     |     |       |     |
|--|--------------|-----|-----|-----|-------|-----|
| Meritor Kit 11375 includes other components (For Shock only) | KIT11375     | ... | ... | 010 | 86200 | ... |
| Meritor Kit 11376 includes other components (For Shock only) | KIT11376     | ... | ... | 010 | 86200 | ... |
| Meritor Kit 11389 includes other components (For Shock only) | KIT11389     | ... | ... | 010 | 86200 | ... |
| Meritor Kit 11402 includes other components (For Shock only) | KIT11402     | ... | ... | 010 | 86200 | ... |
| MTA 25T / MTA 30T Trailer Air Suspension                     | 671506       | ... | ... | 010 | 86200 | ... |
|  | 7805-F-1020  | ... | ... | 010 | 86200 | ... |
|  | A-7805F-1020 | ... | ... | 010 | 86200 | ... |

**RHP Trailer Suspension**

|        |  |               |     |     |     |       |     |
|--------|--|---------------|-----|-----|-----|-------|-----|
| 1997 - | RHP11, RHP55 and RideSentry Trailer Suspension | 202447        | ... | ... | 010 | 85919 | ... |
|        |  | A-3280-M-9711 | ... | ... | 010 | 85919 | ... |
| 2001 - | RHP11, RHP55 and RideSentry Trailer Suspension | 671907        | ... | ... | 010 | 85919 | ... |
|        |  | A-7805L-1000  | ... | ... | 010 | 85919 | ... |

**MITSUBISHI-FUSO**

**FE Series**

|         |                            |          |       |       |       |        |     |
|---------|----------------------------|----------|-------|-------|-------|--------|-----|
| 07/86 - | FE434, FE439, FE444, FE450 | MB025382 | ..... | ..... | ..... | .....  |     |
|         |                            | MB161497 | ...   | ...   | 010   | G63299 | ... |
| 96 - 97 | FE639, FE639SP, FE639HDT   | MC114595 | ...   | ...   | 010   | G63405 | ... |

## APPLICATION GUIDE - TRUCKS, TRAILERS, AND BUSES

| Year<br>Año<br>Année | Model<br>Modelo<br>Modèle | OEM # | Front |  |  | Rear      |        |           |
|----------------------|---------------------------|-------|-------|--|--|-----------|--------|-----------|
|                      |                           |       |       |  |  |           |        |           |
|                      |                           |       |       |  |  | Fleetline | GasSLX | Fleetline |

### MITSUBISHI-FUSO(Cont'd.)

#### FF Series(Cont'd.)

|         |       |          |     |               |     |     |     |     |
|---------|-------|----------|-----|---------------|-----|-----|-----|-----|
| 86 - 87 | FF415 | MC813511 | - - | <b>G63398</b> | ... | ... | ... | ... |
|---------|-------|----------|-----|---------------|-----|-----|-----|-----|

#### FH Series

|            |                        |          |     |               |     |     |              |     |
|------------|------------------------|----------|-----|---------------|-----|-----|--------------|-----|
| 10/87 - 96 | FH100 Suspension (All) | MC809390 | - - | ...           | ... | - - | <b>83103</b> | ... |
|            |                        |          |     | <b>G63610</b> | ... | ... | ...          | ... |

#### FK Series

|               |       |          |     |               |     |     |     |     |
|---------------|-------|----------|-----|---------------|-----|-----|-----|-----|
| 11/85 - 11/86 | FK414 | MC813511 | - - | <b>G63398</b> | ... | ... | ... | ... |
| 06/88 - 02/91 | FK455 | MC814614 | - 0 | <b>85009</b>  | ... | ... | ... | ... |
| 03/91 - 06/93 | FK457 | MC814614 | - 0 | <b>85009</b>  | ... | ... | ... | ... |

#### FM Series

|               |       |          |     |              |       |     |     |     |
|---------------|-------|----------|-----|--------------|-------|-----|-----|-----|
| 06/88 - 02/91 | FM555 | MC814614 | - 0 | <b>85009</b> | ...   | ... | ... | ... |
| 11/85 - 05/88 | FM555 | MC813135 | - - | <b>83456</b> | 89447 | ... | ... | ... |
| 05/89 - 06/93 | FM557 | MC814614 | - 0 | <b>85009</b> | ...   | ... | ... | ... |









### MOHAWK

|                                |               |     |                       |
|--------------------------------|---------------|-----|-----------------------|
| Additional O.E.M. Interchanges | 01-0100-905   | 0 0 | <b>85303 or 89422</b> |
|                                | 020273544     | 0 0 | <b>83203 or 89436</b> |
|                                | 050134508     | 0 0 | <b>85732</b>          |
|                                | 10134504      | 0 0 | <b>85715</b>          |
|                                | 10134506      | 0 0 | <b>85715</b>          |
|                                | 10234503      | 0 0 | <b>85715</b>          |
|                                | 10234504      | 0 0 | <b>85717</b>          |
|                                | 1235233       | 0 0 | <b>85736</b>          |
|                                | 22012082      | 0 0 | <b>85702</b>          |
|                                | 22012114      | 0 0 | <b>85700</b>          |
|                                | 4968853       | 0 0 | <b>83216</b>          |
|                                | 6-367-7       | 0 0 | <b>85305</b>          |
|                                | 680323        | 0 0 | <b>85700</b>          |
|                                | 680485        | 0 - | <b>85733</b>          |
|                                | 695195        | - - | <b>85707</b>          |
|                                | 695196        | - - | <b>85707</b>          |
|                                | 97-2201-00007 | - 0 | <b>85703</b>          |
|                                | 97-2201-00011 | 0 0 | <b>85704</b>          |
|                                | 97-9999-02320 | 0 0 | <b>85704</b>          |
|                                | MM-6886       | 0 0 | <b>83207 or 89407</b> |
|                                | MM-6957       | 0 0 | <b>83225</b>          |
|                                | MM-74029      | 0 0 | <b>85308 or 89422</b> |

### MONACO

|         |   |                |     |              |     |     |              |     |
|---------|---|----------------|-----|--------------|-----|-----|--------------|-----|
| 01 - 10 | Monarch and LaPalma Models with W20 & W22 Workhorse Motorhome Chassis | 24-186629      | 0 0 | <b>85125</b> | ... | ... | ...          | ... |
|         |   | F4-BE5-B492-HO | 0 0 | <b>85125</b> | ... | ... | ...          | ... |
| 05 - 10 | Monarch and LaPalma Models with W20 & W22 Workhorse Motorhome Chassis | 24-153256      |     | ...          | ... | - - | <b>85124</b> | ... |
|         |   | F4-BE5-F325-HO |     | ...          | ... | - - | <b>85124</b> | ... |
|         |   | W0005663       |     | ...          | ... | - - | <b>85124</b> | ... |
| 01 - 04 | Monarch and LaPalma Models with W20 & W22 Workhorse Motorhome Chassis | 24-186537      |     | ...          | ... | 0 - | <b>85126</b> | ... |
|         |   | F4-BE5-A011-HO |     | ...          | ... | 0 - | <b>85126</b> | ... |
| 01 - 04 | Vacationer Models with W20 & W22 Workhorse Motorhome Chassis          | 24-186629      | 0 0 | <b>85125</b> | ... | ... | ...          | ... |
|         |   | F4-BE5-B492-HO | 0 0 | <b>85125</b> | ... | ... | ...          | ... |
|         |   | 24-186537      |     | ...          | ... | 0 - | <b>85126</b> | ... |

## APPLICATION GUIDE - TRUCKS, TRAILERS, AND BUSES

| Year<br>Año<br>Année | Model<br>Modelo<br>Modèle | OEM # | Front   |   | Rear  |   |
|----------------------|---------------------------|-------|---|---|---|---|
|                      |                           |       |  |  |  |  |
|                      |                           |       |  |  |  |  |
|                      |                           |       | Fleetline   | GasSLX  | Fleetline   | GasSLX  |

### MONACO(Cont'd.)

|         |  |                |     |              |              |     |              |     |
|---------|--|----------------|-----|--------------|--------------|-----|--------------|-----|
| 01 - 04 | Vacationer Models with W20 & W22 Workhorse Motorhome Chassis               | F4-BE5-A011-HO |     | ...          | ...          | 01- | <b>85126</b> | ... |
| 98 - 14 | All Models with W20 & W22 Workhorse Motorhome Chassis                      | 24-186629      | 010 | <b>85125</b> | ...          |     | ...          | ... |
|         |  | F4-BE5-B492-HO | 010 | <b>85125</b> | ...          |     | ...          | ... |
| 95 - 99 | MotorHomes with Freightliner XC Chassis (22,000 to 26,000 lb GVW)          | .....          | 010 | <b>83160</b> | ...          | 010 | <b>85029</b> | ... |
|         | Models with Workhorse UFO Chassis with Hendrickson Softek Front Suspension | 66153-002      | 010 | <b>83124</b> | <b>89407</b> |     | ...          | ... |
|         |  | F4-BE5-C832-MO | 010 | <b>83124</b> | <b>89407</b> |     | ...          | ... |

### Class A MotorHomes

|           |   |               |              |              |              |              |              |              |
|-----------|---|---------------|--------------|--------------|--------------|--------------|--------------|--------------|
| 90 - 97   | Monarch and LaPalma Models with F53 Motorhome Chassis (7.5 L, Gas V8)                           | .....         | 010          | <b>83209</b> | <b>89414</b> | 010          | <b>85097</b> | ...          |
| 99 - 14   | Monarch and LaPalma Series MotorHomes with Ford F53 Chassis with 16,000 lb GVW to 22,000 lb GVW | 1C34-18045-AA | 010          | <b>83209</b> | <b>89414</b> |              | ...          | ...          |
|           |   | 1C34-18045-JA | 010          | <b>83209</b> | <b>89414</b> |              | ...          | ...          |
|           |   | 9U94-18045-AA | 010          | <b>83209</b> | <b>89414</b> |              | ...          | ...          |
|           |   | 9U94-18080-AA |              | ...          | ...          | 010          | <b>83122</b> | <b>89406</b> |
|           |   | 9U9Z-18124-A  | 010          | <b>83209</b> | <b>89414</b> |              | ...          | ...          |
|           |   | 9U9Z-18125-A  |              | ...          | ...          | 010          | <b>83122</b> | <b>89406</b> |
|           |   | ASH-1022      | 010          | <b>83209</b> | <b>89414</b> |              | ...          | ...          |
|           |   | ASH-1023      |              | ...          | ...          | 010          | <b>83122</b> | <b>89406</b> |
|           |   | ASH-1205      | 010          | <b>83209</b> | <b>89414</b> |              | ...          | ...          |
|           |   | ASH-1206      |              | ...          | ...          | 010          | <b>83122</b> | <b>89406</b> |
|           |   | ASH-1228      | 010          | <b>83209</b> | <b>89414</b> |              | ...          | ...          |
|           |   | ASH-1229      | 010          | <b>83209</b> | <b>89414</b> |              | ...          | ...          |
|           |   | ASH-1230      |              | ...          | ...          | 010          | <b>83122</b> | <b>89406</b> |
|           |   | ASH-137       |              | ...          | ...          | 010          | <b>83122</b> | <b>89406</b> |
|           |   | ASH-25822     | 010          | <b>83209</b> | <b>89414</b> |              | ...          | ...          |
|           |   | ASH-25823     | 010          | <b>83209</b> | <b>89414</b> |              | ...          | ...          |
| ASH-25824 |   | ...           | ...          | 010          | <b>83122</b> | <b>89406</b> |              |              |
| ASH-294   | 010   | <b>83209</b>  | <b>89414</b> |              | ...          | ...          |              |              |
| AT-620    | 010   | <b>83209</b>  | <b>89414</b> |              | ...          | ...          |              |              |
| AT-621    |   | ...           | ...          | 010          | <b>83122</b> | <b>89406</b> |              |              |
| AT-766    | 010   | <b>83209</b>  | <b>89414</b> |              | ...          | ...          |              |              |

### MOR-RYDE SUSPENSION

|  |                      |           |  |     |     |     |               |     |
|--|----------------------|-----------|--|-----|-----|-----|---------------|-----|
|  | Bus Suspension       | .....     |  | ... | ... | - - | <b>83103</b>  | ... |
|  |                      | U0109-006 |  | ... | ... | 010 | <b>G63866</b> | ... |
|  | Recreational Vehicle | U0109-014 |  | ... | ... | - - | <b>83400</b>  | ... |
|  |                      | U0109-018 |  | ... | ... | 010 | <b>G63866</b> | ... |
|  | Trailer Rear         | U0109-007 |  | ... | ... | 010 | <b>G63183</b> | ... |





### MOTOR COACH INDUSTRIES

#### Additional Applications

|  |   |            |     |              |     |     |              |     |
|--|---|------------|-----|--------------|-----|-----|--------------|-----|
|  | Drive Axle                              | 12J-5-2    |     | ...          | ... | 01- | <b>85733</b> | ... |
|  |   | 12J-5-4    |     | ...          | ... | 01- | <b>85733</b> | ... |
|  |   | 12L-5-71   |     | ...          | ... | - - | <b>85708</b> | ... |
|  |   | T14-1081   |     | ...          | ... | 01- | <b>85729</b> | ... |
|  | Low Floor Bus Models with O.E.M. Number | 12L-5-99   |     | ...          | ... | 010 | <b>85339</b> | ... |
|  | MC5, MC7, MC8                           | 12B-5-1    |     | <b>85735</b> | ... | 010 | <b>85735</b> | ... |
|  |   | 3178157    |     | <b>85700</b> | ... | 010 | <b>85700</b> | ... |
|  |   | 680323     |     | <b>85700</b> | ... | 010 | <b>85700</b> | ... |
|  | RTS Bus with "V" Drive Rear             | G1101590GS |     | ...          | ... | 010 | <b>85713</b> | ... |
|  | RTS Bus with Regular Rear               | G1011822   |     | ...          | ... | 010 | <b>85702</b> | ... |
|  | RTS Bus with Solid Front Axle           | 22024673   | - 0 | <b>85710</b> | ... |     | ...          | ... |
|  | Steering - Tag Axle                     | 12L-4-170  |     | ...          | ... | 010 | <b>83158</b> | ... |
|  |   | 654789     |     | ...          | ... | 010 | <b>83158</b> | ... |



**APPLICATION GUIDE - TRUCKS, TRAILERS, AND BUSES**

| Year<br>Año<br>Année | Model<br>Modelo<br>Modèle | OEM # | Front   |  | Rear  |   |
|----------------------|---------------------------|-------|---|--|---|---|
|                      |                           |       |  |  |  |  |
|                      |                           |       | Fleetline   | GasSLX   | Fleetline   | GasSLX  |

**MOTOR COACH INDUSTRIES(Cont'd.)**









**Additional Applications(Cont'd.)**

|          |            |     |     |     |              |     |
|----------|------------|-----|-----|-----|--------------|-----|
| Tag Axle | 12-05-6068 | ... | ... | - - | <b>85727</b> | ... |
|          | 12J-5-11   | ... | ... | 0 0 | <b>85313</b> | ... |
|          | 12J-5-3    | ... | ... | 0 0 | <b>85313</b> | ... |
|          | T14-1082   | ... | ... | - - | <b>85727</b> | ... |

**D - Series Coaches**

|                              |                 |            |            |              |              |              |     |
|------------------------------|-----------------|------------|------------|--------------|--------------|--------------|-----|
| D 4000 Coach<br>(Drive Axle) | 12-05-1177      | ...        | ...        | 0 -          | <b>85729</b> | ...          |     |
|                              | 12-05-1261      | ...        | ...        | 0 -          | <b>85729</b> | ...          |     |
|                              | 12-05-1328      | ...        | ...        | 0 -          | <b>85729</b> | ...          |     |
|                              | (Front Axle)    | 12-05-1176 | - -        | <b>85728</b> | ...          | ...          | ... |
|                              |                 | 12-05-1260 | - -        | <b>85728</b> | ...          | ...          | ... |
|                              |                 | 12-05-1327 | - -        | <b>85728</b> | ...          | ...          | ... |
|                              | (Trailing Axle) | 12L-5-97   | - -        | <b>85728</b> | ...          | ...          | ... |
|                              |                 | 12-05-1178 | ...        | ...          | 0 0          | <b>85339</b> | ... |
|                              |                 | 12-05-1194 | ...        | ...          | 0 0          | <b>85339</b> | ... |
| 12L-5-99                     |                 | ...        | ...        | 0 0          | <b>85339</b> | ...          |     |
| D 4005 Coach<br>(Drive Axle) | 12-05-1177      | ...        | ...        | 0 -          | <b>85729</b> | ...          |     |
|                              | 12-05-1261      | ...        | ...        | 0 -          | <b>85729</b> | ...          |     |
|                              | 12-05-1328      | ...        | ...        | 0 -          | <b>85729</b> | ...          |     |
|                              | (Front Axle)    | 12-05-1176 | - -        | <b>85728</b> | ...          | ...          | ... |
|                              |                 | 12-05-1260 | - -        | <b>85728</b> | ...          | ...          | ... |
|                              |                 | 12-05-1327 | - -        | <b>85728</b> | ...          | ...          | ... |
|                              | (Trailing Axle) | 12L-5-97   | - -        | <b>85728</b> | ...          | ...          | ... |
|                              |                 | 12-05-1194 | ...        | ...          | 0 0          | <b>85339</b> | ... |
|                              |                 | 12L-5-99   | ...        | ...          | 0 0          | <b>85339</b> | ... |
| D 4500 Coach<br>(Drive Axle) |                 | 12-05-1177 | ...        | ...          | 0 -          | <b>85729</b> | ... |
|                              | 12-05-1328      | ...        | ...        | 0 -          | <b>85729</b> | ...          |     |
|                              | 12L-5-88        | ...        | ...        | 0 -          | <b>85729</b> | ...          |     |
|                              | 85729           | ...        | ...        | 0 -          | <b>85729</b> | ...          |     |
|                              | (Front Axle)    | 12-05-1176 | - -        | <b>85728</b> | ...          | ...          | ... |
|                              |                 | 12-05-1327 | - -        | <b>85728</b> | ...          | ...          | ... |
|                              |                 | 12L-5-67   | - -        | <b>85728</b> | ...          | ...          | ... |
|                              | (Trailing Axle) | 12-05-1179 | ...        | ...          | - -          | <b>85727</b> | ... |
|                              |                 | 12-05-1262 | ...        | ...          | - -          | <b>85727</b> | ... |
|                              |                 | 12-05-1264 | ...        | ...          | - -          | <b>85727</b> | ... |
|                              |                 | 12-05-1329 | ...        | ...          | - -          | <b>85727</b> | ... |
|                              |                 | 12L-5-114  | ...        | ...          | - -          | <b>85727</b> | ... |
| D 4505 Coach<br>(Drive Axle) |                 | 12-05-1177 | ...        | ...          | 0 -          | <b>85729</b> | ... |
|                              | 12-05-1328      | ...        | ...        | 0 -          | <b>85729</b> | ...          |     |
|                              | 12L-5-88        | ...        | ...        | 0 -          | <b>85729</b> | ...          |     |
|                              | (Front Axle)    | 12-05-1176 | - -        | <b>85728</b> | ...          | ...          | ... |
|                              |                 | 12-05-1327 | - -        | <b>85728</b> | ...          | ...          | ... |
|                              |                 | 12L-5-67   | - -        | <b>85728</b> | ...          | ...          | ... |
|                              | (Trailing Axle) | 12-05-1179 | ...        | ...          | - -          | <b>85727</b> | ... |
|                              |                 | 12-05-1262 | ...        | ...          | - -          | <b>85727</b> | ... |
|                              |                 | 12-05-1264 | ...        | ...          | - -          | <b>85727</b> | ... |
|                              |                 | 12-05-1329 | ...        | ...          | - -          | <b>85727</b> | ... |
|                              |                 | 12L-5-114  | ...        | ...          | - -          | <b>85727</b> | ... |
|                              |                 | DL3 Bus    | 12-05-1327 | - -          | <b>85728</b> | ...          | ... |
| 12-05-1328                   | ...             |            | ...        | 0 -          | <b>85729</b> | ...          |     |
| 12L-5-88                     | ...             |            | ...        | 0 -          | <b>85729</b> | ...          |     |

## APPLICATION GUIDE - TRUCKS, TRAILERS, AND BUSES

| Year<br>Año<br>Année | Model<br>Modelo<br>Modèle | OEM # | Front   |   | Rear  |   |
|----------------------|---------------------------|-------|---|---|---|---|
|                      |                           |       |  |  |  |  |
|                      |                           |       |  |  |  |  |
|                      |                           |       | Fleetline   | GasSLX  | Fleetline   | GasSLX  |

### MOTOR COACH INDUSTRIES(Cont'd.)

#### D - Series Coaches(Cont'd.)

|  |                     |            |     |       |     |     |       |     |
|--|---------------------|------------|-----|-------|-----|-----|-------|-----|
|  | DL3 Bus             | 12L-5-89   |     | ...   | ... | 0 - | 85729 | ... |
|  |                     | 12L-5-96   | - - | 85728 | ... |     | ...   | ... |
|  |                     | 12L-5-97   | - - | 85728 | ... |     | ...   | ... |
|  | DL3 Bus -Drive Axle | 12J-5-10   |     | ...   | ... | 0 - | 85733 | ... |
|  | DL3 Bus -Tag Axle   | 01-205219  |     | ...   | ... | - - | 85727 | ... |
|  |                     | 12-05-1262 |     | ...   | ... | - - | 85727 | ... |
|  |                     | 12-05-1264 |     | ...   | ... | - - | 85727 | ... |
|  |                     | 12-05-1329 |     | ...   | ... | - - | 85727 | ... |
|  |                     | 12L-5-100  |     | ...   | ... | - - | 85727 | ... |
|  |                     | 12L-5-114  |     | ...   | ... | - - | 85727 | ... |
|  |                     | T12-1208   |     | ...   | ... | - - | 85727 | ... |

#### E - Series Coaches

|  |                              |                 |            |     |       |     |       |       |     |
|--|------------------------------|-----------------|------------|-----|-------|-----|-------|-------|-----|
|  | E 4500 Coach<br>(Drive Axle) | 12-05-1022      |            | ... | ...   | 0 - | 85970 | ...   |     |
|  |                              | 12-05-1102      |            | ... | ...   | 0 - | 85970 | ...   |     |
|  |                              | 12-05-1138      |            | ... | ...   | 0 - | 85970 | ...   |     |
|  |                              | 12-05-1148      |            | ... | ...   | 0 - | 85970 | ...   |     |
|  |                              | 12-05-1188      |            | ... | ...   | 0 - | 85970 | ...   |     |
|  |                              | (Front Axle)    | 12-05-1150 | - 0 | 85711 | ... |       | ...   | ... |
|  |                              | (Trailing Axle) | 12-05-1165 | - 0 | 85711 | ... |       | ...   | ... |
|  |                              |                 | 12-05-1139 |     | ...   | ... | 0 -   | 85341 | ... |
|  |                              |                 | 12-05-1147 |     | ...   | ... | 0 -   | 85341 | ... |
|  |                              |                 | 12-05-1166 |     | ...   | ... | 0 -   | 85341 | ... |

#### G - Series Coaches

|  |                            |               |            |     |       |     |       |       |     |
|--|----------------------------|---------------|------------|-----|-------|-----|-------|-------|-----|
|  | G 4500 Coach<br>Drive Axle | 12-05-6001    |            | ... | ...   | 0 - | 85740 | ...   |     |
|  |                            | 12-05-6054    |            | ... | ...   | 0 - | 85740 | ...   |     |
|  |                            | Front Axle    | 12-05-6000 | - 0 | 85711 | ... |       | ...   | ... |
|  |                            |               | 12-05-6053 | - 0 | 85711 | ... |       | ...   | ... |
|  |                            |               | 1497835    | - 0 | 85711 | ... |       | ...   | ... |
|  |                            | Tag Axle      | 1498565    |     | ...   | ... | 0 0   | 85339 | ... |
|  |                            | Trailing Axle | 12-05-6002 |     | ...   | ... | 0 0   | 85339 | ... |
|  |                            |               | 12-05-6033 |     | ...   | ... | 0 0   | 85339 | ... |
|  |                            |               | 12-05-6055 |     | ...   | ... | 0 0   | 85339 | ... |





#### J - Series Coaches

|  |                              |                              |            |     |       |     |       |       |     |
|--|------------------------------|------------------------------|------------|-----|-------|-----|-------|-------|-----|
|  | J 4500 Coach<br>(Drive Axle) | 12-05-1022                   |            | ... | ...   | 0 - | 85970 | ...   |     |
|  |                              | 12-05-1138                   |            | ... | ...   | 0 - | 85970 | ...   |     |
|  |                              | 12-05-1148                   |            | ... | ...   | 0 - | 85970 | ...   |     |
|  |                              | 12-05-1188                   |            | ... | ...   | 0 - | 85970 | ...   |     |
|  |                              | (Front Axle with OEM Number) | 12-05-1137 | 0 - | 85340 | ... |       | ...   | ... |
|  |                              |                              | 12-05-1142 | 0 - | 85340 | ... |       | ...   | ... |
|  |                              |                              | 12-05-1146 | 0 - | 85340 | ... |       | ...   | ... |
|  |                              |                              | 12-05-1150 | - 0 | 85711 | ... |       | ...   | ... |
|  |                              |                              | 12-05-1165 | - 0 | 85711 | ... |       | ...   | ... |
|  |                              | (Trailing Axle)              | 12-05-1228 | - 0 | 85711 | ... |       | ...   | ... |
|  |                              |                              | 12-05-1139 |     | ...   | ... | 0 -   | 85341 | ... |
|  |                              |                              | 12-05-1147 |     | ...   | ... | 0 -   | 85341 | ... |
|  |                              |                              | 12-05-1166 |     | ...   | ... | 0 -   | 85341 | ... |

#### Additional O.E.M. Interchanges

|  |                           |            |     |       |     |     |       |     |
|--|---------------------------|------------|-----|-------|-----|-----|-------|-----|
|  | Models with O.E.M. Number | 12-05-1021 | 0 - | 85340 | ... |     | ...   | ... |
|  |                           | 12-05-1023 |     | ...   | ... | 0 - | 85341 | ... |
|  |                           | 12-05-1101 | 0 - | 85340 | ... |     | ...   | ... |
|  |                           | 12-05-1103 |     | ...   | ... | 0 - | 85341 | ... |

**APPLICATION GUIDE - TRUCKS, TRAILERS, AND BUSES**





| Year<br>Año<br>Année | Model<br>Modelo<br>Modèle | OEM # | Front   |  | Rear  |   |
|----------------------|---------------------------|-------|---|--|---|---|
|                      |                           |       |  |  |  |  |
|                      |                           |       | Fleetline   | GasSLX   | Fleetline   | GasSLX  |

**MOTOR COACH INDUSTRIES(Cont'd.)**

**Additional O.E.M. Interchanges(Cont'd.)**

| Models with O.E.M. Number |     |       |     |     |       |
|---------------------------|-----|-------|-----|-----|-------|
| 12-05-1170                | 01- | 85340 | ... | ... | ...   |
| 12-05-1199                |     | ...   | ... | 01- | 85729 |
| 12-05-1242                | -1- | 85728 | ... | ... | ...   |
| 12-05-1243                |     | ...   | ... | 01- | 85729 |
| 12-05-1244                |     | ...   | ... | -1- | 85727 |
| 12-5-1-G                  | 010 | 85700 | ... | ... | ...   |
| 12-5-1-GS                 | 010 | 85700 | ... | ... | ...   |
| 12B-5-1-G                 | 010 | 85700 | ... | ... | ...   |
| 12B-5-1-GS                | 010 | 85700 | ... | ... | ...   |
| 12J-5-10GS                |     | ...   | ... | 01- | 85733 |
| 12L-5-58                  | -1- | 85728 | ... | ... | ...   |
| 12L-5-69                  | 010 | 85700 | ... | ... | ...   |
| 12L-5-98                  |     | ...   | ... | 010 | 85339 |
| 12T-1-13                  |     | 85303 | ... | 010 | 85303 |
| 12TA-01-013               |     | 85303 | ... | 010 | 85303 |
| 1498200                   |     | ...   | ... | 01- | 85740 |
| 22012067                  | 010 | 85700 | ... | ... | ...   |
| 22024061                  |     | ...   | ... | 010 | 85704 |
| 22045526                  |     | ...   | ... | 010 | 85702 |
| 22046485                  | -10 | 85710 | ... | ... | ...   |
| 3178154                   |     | ...   | ... | 010 | 85735 |
| 5316984                   |     | 85313 | ... | 010 | 85313 |
| 63-0127GS                 |     | 85303 | ... | 010 | 85303 |
| 680231                    |     | ...   | ... | 010 | 85313 |
| 680232                    |     | ...   | ... | 01- | 85733 |
| 680322                    |     | ...   | ... | 010 | 85704 |
| 680323                    | 010 | 85700 | ... | ... | ...   |
| 680350                    | -10 | 85710 | ... | ... | ...   |
| 680369                    |     | ...   | ... | -1- | 85708 |
| 680374                    | -1- | 85728 | ... | ... | ...   |
| 680441                    |     | ...   | ... | 01- | 85729 |
| 680452                    |     | ...   | ... | 010 | 85339 |
| 680462                    | -1- | 85728 | ... | ... | ...   |
| 680470                    |     | ...   | ... | 010 | 85713 |
| 680482                    |     | ...   | ... | -1- | 85727 |
| 680485                    |     | ...   | ... | 01- | 85733 |
| 680544                    | -10 | 85711 | ... | ... | ...   |
| 680546                    |     | ...   | ... | 010 | 85339 |
| 680602                    |     | ...   | ... | 010 | 85339 |
| 680677                    | -1- | 85728 | ... | ... | ...   |
| 680680                    |     | ...   | ... | 01- | 85729 |
| 680681                    |     | ...   | ... | -1- | 85727 |
| 695125                    |     | ...   | ... | 010 | 85704 |
| 97-9999-02585             | 01- | 85723 | ... | ... | ...   |
| G1101590                  |     | ...   | ... | 010 | 85713 |
| G1201338                  | -10 | 85710 | ... | ... | ...   |
| G1201339                  |     | ...   | ... | 010 | 85702 |
| G5008069                  | 010 | 85700 | ... | ... | ...   |
| OE10086S                  |     | ...   | ... | 010 | 85702 |
| OE10881                   | -10 | 85711 | ... | ... | ...   |
| OE10882                   |     | ...   | ... | 01- | 85740 |
| OE10883                   |     | ...   | ... | 010 | 85339 |
| T14-1045GS                | 010 | 85700 | ... | ... | ...   |
| T14-1048                  |     | ...   | ... | 010 | 85302 |
| T14-1080                  | -1- | 85728 | ... | ... | ...   |

**APPLICATION GUIDE - TRUCKS, TRAILERS, AND BUSES**

| Year<br>Año<br>Année | Model<br>Modelo<br>Modèle | OEM # | Front   |   | Rear  |   |
|----------------------|---------------------------|-------|---|---|---|---|
|                      |                           |       |  |  |  |  |
|                      |                           |       | Fleetline   | GasSLX  | Fleetline   | GasSLX  |

**MOTOR COACH INDUSTRIES(Cont'd.)**

**Additional O.E.M. Interchanges(Cont'd.)**

|                                |               |     |       |
|--------------------------------|---------------|-----|-------|
| Additional O.E.M. Interchanges | 12G-5-1       | 010 | 85700 |
|                                | 12J-5-6       | 010 | 85313 |
|                                | 12J-5-7       | 01- | 85733 |
|                                | 12J-5-71      | 01- | 85733 |
|                                | 12J-5-9       | 010 | 85700 |
|                                | 12L-5-70      | 010 | 85700 |
|                                | 12L-5-72      | 010 | 85709 |
|                                | 22012066      | -1- | 85707 |
|                                | 22052014      | 010 | 85702 |
|                                | 6314933       | -1- | 85708 |
|                                | 680333        | -1- | 85708 |
|                                | 690029        | 010 | 85700 |
|                                | 97-2201-00151 | 010 | 85700 |
|                                | 97-2210-00164 | -1- | 85708 |
|                                | 97-9999-02514 | 010 | 85700 |
|                                | 97-9999-02634 | 01- | 85733 |

**MUNCIE RECLAMATION**

**Additional O.E.M. Interchanges**

|                                |               |       |                |     |       |     |
|--------------------------------|---------------|-------|----------------|-----|-------|-----|
| Models with O.E.M. Number      | 665459        | ...   | ...            | -1- | 89447 | ... |
|                                | 665568        | ...   | ...            | 010 | 85051 | ... |
|                                | H53-20415-006 | ...   | ...            | 010 | 85051 | ... |
|                                | MR6394        | 01-   | 85723          | ... | ...   | ... |
| Additional O.E.M. Interchanges | 665569        | 010   | 85045          |     |       |     |
|                                | 680334        | -1-   | 85709          |     |       |     |
|                                | 97-2210-00164 | -1-   | 85708          |     |       |     |
|                                | H53-21144-004 | 010   | 85045          |     |       |     |
|                                | MR1623        | 010   | 85700          |     |       |     |
|                                | MR1710        | 010   | 85713          |     |       |     |
|                                | MR1751        | 010   | 85713          |     |       |     |
|                                | MR1763        | 010   | 85300 or 89419 |     |       |     |
|                                | MR1765        | 010   | 85713          |     |       |     |
|                                | MR25767       | 010   | 85702          |     |       |     |
|                                | MR2960        | 010   | 85702          |     |       |     |
|                                | MR2996        | 010   | 85704          |     |       |     |
|                                | MR2997        | -10   | 85703          |     |       |     |
|                                | MR3303        | -1-   | 85709          |     |       |     |
|                                | MR3304        | -10   | 85710          |     |       |     |
|                                | MR3304H       | -1-   | 85709          |     |       |     |
|                                | MR3306        | -1-   | 85705 or 89447 |     |       |     |
|                                | MR3307        | -1-   | 85707          |     |       |     |
|                                | MR3650        | -1-   | 85707          |     |       |     |
|                                | MR6535        | -1-   | 85708          |     |       |     |
| MR6536                         | -1-           | 85722 |                |     |       |     |
| MR7388                         | -10           | 85710 |                |     |       |     |

**NATIONAL COACH CORP**





|                      |         |     |       |       |     |     |
|----------------------|---------|-----|-------|-------|-----|-----|
| Eldorado Coach RE-29 | C800853 | 010 | 83207 | 89407 | ... | ... |
|----------------------|---------|-----|-------|-------|-----|-----|

**NATIONAL RV INC.**

**Class A MotorHomes**

|         |  |               |     |       |       |     |     |
|---------|--|---------------|-----|-------|-------|-----|-----|
| 99 - 08 | Models with Ford F53 Chassis with 16,000 lb GVW to 22,000 lb GVW | 1C34-18045-AA | 010 | 83209 | 89414 | ... | ... |
|         |  | 1C34-18045-JA | 010 | 83209 | 89414 | ... | ... |
|         |  | 9U94-18045-AA | 010 | 83209 | 89414 | ... | ... |

**APPLICATION GUIDE - TRUCKS, TRAILERS, AND BUSES**

| Year<br>Año<br>Année | Model<br>Modelo<br>Modèle | OEM # | Front  |   | Rear   |   |
|----------------------|---------------------------|-------|--|---|--|---|
|                      |                           |       |  |  |  |  |
|                      |                           |       | Fleetline  | GasSLX  | Fleetline  | GasSLX  |

**NATIONAL RV INC.(Cont'd.)**

**Class A MotorHomes(Cont'd.)**

|         |   |                |       |       |       |     |       |       |
|---------|---|----------------|-------|-------|-------|-----|-------|-------|
| 99 - 08 | Models with Ford F53 Chassis with 16,000 lb GVW to 22,000 lb GVW            | 9U94-18080-AA  |       | ...   | ...   | 010 | 83122 | 89406 |
|         |   | 9U9Z-18124-A   | 010   | 83209 | 89414 |     | ...   | ...   |
|         |   | 9U9Z-18125-A   |       | ...   | ...   | 010 | 83122 | 89406 |
|         |   | ASH-1022       | 010   | 83209 | 89414 |     | ...   | ...   |
|         |   | ASH-1023       |       | ...   | ...   | 010 | 83122 | 89406 |
|         |   | ASH-1205       | 010   | 83209 | 89414 |     | ...   | ...   |
|         |   | ASH-1206       |       | ...   | ...   | 010 | 83122 | 89406 |
|         |   | ASH-1228       | 010   | 83209 | 89414 |     | ...   | ...   |
|         |   | ASH-1229       | 010   | 83209 | 89414 |     | ...   | ...   |
|         |   | ASH-1230       |       | ...   | ...   | 010 | 83122 | 89406 |
|         |   | ASH-137        |       | ...   | ...   | 010 | 83122 | 89406 |
|         |   | ASH-25822      | 010   | 83209 | 89414 |     | ...   | ...   |
|         |   | ASH-25823      | 010   | 83209 | 89414 |     | ...   | ...   |
|         |   | ASH-25824      |       | ...   | ...   | 010 | 83122 | 89406 |
|         |   | ASH-294        | 010   | 83209 | 89414 |     | ...   | ...   |
|         |   | AT-620         | 010   | 83209 | 89414 |     | ...   | ...   |
|         |   | AT-621         |       | ...   | ...   | 010 | 83122 | 89406 |
| AT-766  | 010   | 83209          | 89414 |       | ...   | ... |       |       |
| 05 - 08 | Models with Workhorse W20 , W22, & W24 MotorHome Chassis with O.E.M. Number | 24-153256      |       | ...   | ...   | -1- | 85124 | ...   |
|         |   | F4-BE5-F325-HO |       | ...   | ...   | -1- | 85124 | ...   |
|         |   | W0005663       |       | ...   | ...   | -1- | 85124 | ...   |
| 98 - 04 | Models with Workhorse W20 , W22, & W24 MotorHome Chassis with O.E.M. Number | 24-186537      |       | ...   | ...   | 01- | 85126 | ...   |
|         |   | F4-BE5-A011-HO |       | ...   | ...   | 01- | 85126 | ...   |
| 98 - 08 | Models with Workhorse W20 , W22, & W24 MotorHome Chassis with O.E.M. Number | 24-153249      | 010   | 85125 | ...   |     | ...   | ...   |
|         |   | 24-186629      | 010   | 85125 | ...   |     | ...   | ...   |
|         |   | F4-BE5-A832-MO | 010   | 85125 | ...   |     | ...   | ...   |
|         |   | F4-BE5-B492-HO | 010   | 85125 | ...   |     | ...   | ...   |
|         |   | F4-BE5-F324-HO | 010   | 85125 | ...   |     | ...   | ...   |
|         |   | W0005662       | 010   | 85125 | ...   |     | ...   | ...   |
|         |   | W0006254       | 010   | 85125 | ...   |     | ...   | ...   |

**NAVISTAR - SEE INTERNATIONAL (NAVISTAR)**

|  |  |  |  |  |  |  |  |  |
|--|--|--|--|--|--|--|--|--|
|  |  |  |  |  |  |  |  |  |
|--|--|--|--|--|--|--|--|--|

**NEOPLAN BUS**

|  |                           |                 |     |       |     |     |       |       |
|--|---------------------------|-----------------|-----|-------|-----|-----|-------|-------|
|  | Mini-Bus                  | 24-1700-106-149 |     | ...   | ... | 010 | 83216 | ...   |
|  |                           | 24-1700-999-362 | -10 | 85009 | ... |     | ...   | ...   |
|  |                           | BN1002002       | -10 | 85009 | ... |     | ...   | ...   |
|  |                           | BT1002011       |     | ...   | ... | 010 | 83216 | ...   |
|  | Model 40                  | 25-1700-101-426 |     | 85705 | ... | -1- | 85705 | 89447 |
|  |                           | DT1002002       |     | 85707 | ... | -1- | 85707 | ...   |
|  | Model 80B                 | CL1002003       |     | 85705 | ... | -1- | 85705 | 89447 |
|  |                           | DZ1002002       |     | 85705 | ... | -1- | 85705 | 89447 |
|  | Models with O.E.M. Number | 680307          |     | 85705 | ... | -1- | 85705 | 89447 |
|  |                           | 680308          |     | 85706 | ... | -1- | 85706 | ...   |
|  |                           | AA1002002       |     | 85705 | ... | -1- | 85705 | 89447 |
|  |                           | AA1002003       |     | 85705 | ... | -1- | 85705 | 89447 |
|  |                           | AA1802002       |     | 85705 | ... | -1- | 85705 | 89447 |
|  |                           | AC1002002       |     | 85705 | ... | -1- | 85705 | 89447 |
|  |                           | AC1002002GS     |     | 85705 | ... | -1- | 85705 | 89447 |
|  |                           | AC1002003       |     | 85705 | ... | -1- | 85705 | 89447 |
|  |                           | DT1802002       |     | 85705 | ... | -1- | 85705 | 89447 |

## APPLICATION GUIDE - TRUCKS, TRAILERS, AND BUSES

| Year<br>Año<br>Année | Model<br>Modelo<br>Modèle | OEM # | Front     |        | Rear      |        |
|----------------------|---------------------------|-------|-----------|--------|-----------|--------|
|                      |                           |       |           |        |           |        |
|                      |                           |       | Fleetline | GasSLX | Fleetline | GasSLX |

### NEOPLAN BUS(Cont'd.)

|  |                                |               |     |                       |     |     |              |              |
|--|--------------------------------|---------------|-----|-----------------------|-----|-----|--------------|--------------|
|  | Models with O.E.M. Number      | GJ1002002     |     | <b>85706</b>          | ... | - - | <b>85706</b> | ...          |
|  |                                | GJ1002003     |     | <b>85705</b>          | ... | - - | <b>85705</b> | <b>89447</b> |
|  |                                | MM1002002     |     | <b>85705</b>          | ... | - - | <b>85705</b> | <b>89447</b> |
|  |                                | MM1002003     |     | <b>85705</b>          | ... | - - | <b>85705</b> | <b>89447</b> |
|  | Additional O.E.M. Interchanges | 97-9999-02519 | - - | <b>85707</b>          |     |     |              |              |
|  |                                | CI 1002003    | - - | <b>85705 or 89447</b> |     |     |              |              |

### NEW FLYER

|                |  |               |     |              |     |     |              |     |
|----------------|--|---------------|-----|--------------|-----|-----|--------------|-----|
|                | Diesel Low Floor Coach                         | 015813        |     | ...          | ... | - - | <b>85708</b> | ... |
| <b>01 - 11</b> | Transit Buses (Low Profile) with O.E.M. Number | 203398        | - - | <b>85346</b> | ... |     | ...          | ... |
|                |  | 204428        |     | ...          | ... | - - | <b>85347</b> | ... |
| <b>1991 -</b>  | Transit Buses (Low Profile) with O.E.M. Number | 009863        | - - | <b>85722</b> | ... |     | ...          | ... |
|                |  | 016415        | - - | <b>85722</b> | ... |     | ...          | ... |
|                |  | 680346        | - - | <b>85722</b> | ... |     | ...          | ... |
| <b>2002 -</b>  | Transit Buses (Low Profile) with O.E.M. Number | 152959        |     | ...          | ... | - - | <b>85708</b> | ... |
|                |  | 680671        |     | ...          | ... | - - | <b>85708</b> | ... |
|                | Models with O.E.M. Number                      | 69536140Y     | - 0 | <b>87016</b> | ... |     | ...          | ... |
|                |  | G1011823      | - 0 | <b>85710</b> | ... |     | ...          | ... |
|                | Additional O.E.M. Interchanges                 | 015915        | - 0 | <b>85711</b> |     |     |              |     |
|                |  | 064845        | - 0 | <b>85711</b> |     |     |              |     |
|                |  | 68027440Y     | 0 0 | <b>85716</b> |     |     |              |     |
|                |  | 68035041Y     | - 0 | <b>85710</b> |     |     |              |     |
|                |  | 680352        | - 0 | <b>85711</b> |     |     |              |     |
|                |  | 68037840B     | 0 0 | <b>85720</b> |     |     |              |     |
|                |  | 68050440X     | 0 0 | <b>85716</b> |     |     |              |     |
|                |  | 68050640Y     | 0 0 | <b>85732</b> |     |     |              |     |
|                |  | 690102        | - 0 | <b>85711</b> |     |     |              |     |
|                |  | 69536640Y     | 0 0 | <b>85732</b> |     |     |              |     |
|                |  | 97-2210-00164 | - - | <b>85708</b> |     |     |              |     |

### NEWAY (HOLLAND) SUSPENSION SYSTEMS - SEE SAF HOLLAND





Refer to SAF Holland Section for application information

### NEWMAR CORP

#### Class A MotorHomes

|                |  |   |              |              |              |     |              |              |     |
|----------------|--|---|--------------|--------------|--------------|-----|--------------|--------------|-----|
| <b>13 - 19</b> | Bay Star, Bay Star Sport & Canyon Star Series MotorHomes with Ford F53 Chassis with 16,000 lb GVW to 22,000 lb GVW | ASH-1229  | 0 0          | <b>83209</b> | <b>89414</b> |     | ...          | ...          |     |
|                |  | ASH-25822   | 0 0          | <b>83209</b> | <b>89414</b> |     | ...          | ...          |     |
|                |  | ASH-25823   | 0 0          | <b>83209</b> | <b>89414</b> |     | ...          | ...          |     |
|                |  | ASH-25824   |              | ...          | ...          | 0 0 | <b>83122</b> | <b>89406</b> |     |
| <b>02 - 04</b> | Dutch Star & Moundain Aire Series MotorHomes with Freightliner XC Chassis<br>AS120 Front Suspension                | 141700131810  | 0 0          | <b>83160</b> | ...          |     | ...          | ...          |     |
|                |  | 16-16737-000  | 0 0          | <b>83160</b> | ...          |     | ...          | ...          |     |
|                |  | 16-16874-000  | 0 0          | <b>83160</b> | ...          |     | ...          | ...          |     |
|                |  | Rear Shock with O.E.M. Number                           | 141700131809 |              | ...          | ... | 0 0          | <b>85029</b> | ... |
|                |  |   | 16-16736-000 |              | ...          | ... | 0 0          | <b>85029</b> | ... |
|                |  | ZF - IFS Front Suspension with 23,000 lb GVW or Greater | 16-18103-000 | - -          | <b>85900</b> | ... |              | ...          | ... |
|                |  |   | 481700000493 | - -          | <b>85900</b> | ... |              | ...          | ... |
| <b>02 - 05</b> | Kountry Star Series MotorHomes with Freightliner XC Chassis<br>AS120 Front Suspension                              | 141700131810  | 0 0          | <b>83160</b> | ...          |     | ...          | ...          |     |
|                |  | 16-16737-000  | 0 0          | <b>83160</b> | ...          |     | ...          | ...          |     |
|                |  | 16-16874-000  | 0 0          | <b>83160</b> | ...          |     | ...          | ...          |     |
|                |  | Rear Shock with O.E.M. Number                           | 141700131809 |              | ...          | ... | 0 0          | <b>85029</b> | ... |
|                |  |   | 16-16736-000 |              | ...          | ... | 0 0          | <b>85029</b> | ... |
|                |  | ZF - IFS Front Suspension with 23,000 lb GVW or Greater | 16-18103-000 | - -          | <b>85900</b> | ... |              | ...          | ... |

**APPLICATION GUIDE - TRUCKS, TRAILERS, AND BUSES**

| Year<br>Año<br>Année | Model<br>Modelo<br>Modèle | OEM # | Front  |   | Rear   |   |
|----------------------|---------------------------|-------|--|---|--|---|
|                      |                           |       |  |  |  |  |
|                      |                           |       | Fleetline  | GasSLX  | Fleetline  | GasSLX  |

**NEWMAR CORP(Cont'd.)**

**Class A MotorHomes(Cont'd.)**

|         |  |   |              |       |       |     |     |       |     |
|---------|--|---|--------------|-------|-------|-----|-----|-------|-----|
| 02 - 05 | AS120 Front Suspension   | 48170000493   | - -          | 85900 | ...   |     | ... | ...   |     |
| 2006    | Ventana Series MotorHomes with Freightliner XC Chassis<br>AS120 Front Suspension | 141700131810  | 0 0          | 83160 | ...   |     | ... | ...   |     |
|         |  | 16-16737-000  | 0 0          | 83160 | ...   |     | ... | ...   |     |
|         |  | 16-16874-000  | 0 0          | 83160 | ...   |     | ... | ...   |     |
|         |  | Rear Shock with O.E.M. Number                           | 141700131809 |       | ...   | ... | 0 0 | 85029 | ... |
|         |  | 16-16736-000  |              |       | ...   | ... | 0 0 | 85029 | ... |
|         |  | ZF - IFS Front Suspension with 23,000 lb GVW or Greater | 16-18103-000 | - -   | 85900 | ... |     | ...   | ... |
|         |  | 48170000493   | - -          | 85900 | ...   |     | ... | ...   |     |

**NEXUS RV**

**Class A MotorHomes**

|         |  |           |     |       |       |     |       |       |
|---------|--|-----------|-----|-------|-------|-----|-------|-------|
| 16 - 19 | Maybach Series MotorHomes with Ford F53 Chassis with<br>16,000 lb GVW to 22,000 lb GVW | ASH-1229  | 0 0 | 83209 | 89414 |     | ...   | ...   |
|         |  | ASH-25822 | 0 0 | 83209 | 89414 |     | ...   | ...   |
|         |  | ASH-25823 | 0 0 | 83209 | 89414 |     | ...   | ...   |
|         |  | ASH-25824 |     | ...   | ...   | 0 0 | 83122 | 89406 |

**Class C MotorHomes**

|         |  |          |     |       |     |     |       |     |
|---------|--|----------|-----|-------|-----|-----|-------|-----|
| 11 - 19 | Phantom Series MotorHomes with Ford E350 & E450 Chassis  | ASH-1136 |     | ...   | ... | - 0 | 83178 | ... |
|         |  | ASH-1154 | - 0 | 83177 | ... |     | ...   | ... |
| 11 - 12 | Scenic Traveler Series MotorHomes with Ford E450 Chassis | ASH-1136 |     | ...   | ... | - 0 | 83178 | ... |
|         |  | ASH-1154 | - 0 | 83177 | ... |     | ...   | ... |
| 12 - 19 | Viper Series MotorHomes with Ford E350 & E450 Chassis    | ASH-1136 |     | ...   | ... | - 0 | 83178 | ... |
|         |  | ASH-1154 | - 0 | 83177 | ... |     | ...   | ... |

**NISSAN**

**UD 1200 Series**

|         |                                    |            |     |       |     |  |     |     |
|---------|------------------------------------|------------|-----|-------|-----|--|-----|-----|
| 99 - 04 | U D 1200 Models with O.E.M. Number | 561000T825 | - 0 | 83515 | ... |  | ... | ... |
|         |                                    | E61000T825 | - 0 | 83515 | ... |  | ... | ... |

**UD 1300 Series**

|         |                                    |             |     |        |     |  |     |     |
|---------|------------------------------------|-------------|-----|--------|-----|--|-----|-----|
| 05 - 07 | U D 1300 Models with O.E.M. Number | 561000T825  | - 0 | 83515  | ... |  | ... | ... |
|         |                                    | E61000T825  | - 0 | 83515  | ... |  | ... | ... |
|         | UD 1300 Models Steer Axle          | 56110-T8123 | - 0 | G63432 | ... |  | ... | ... |
|         |                                    | 56110-T8129 | - 0 | G63432 | ... |  | ... | ... |
|         |                                    | 66400       | - 0 | G63432 | ... |  | ... | ... |

**UD 1400 Series**

|         |                                    |            |     |       |     |  |     |     |
|---------|------------------------------------|------------|-----|-------|-----|--|-----|-----|
| 94 - 10 | U D 1400 Models with O.E.M. Number | 561000T825 | - 0 | 83515 | ... |  | ... | ... |
|         |                                    | E61000T825 | - 0 | 83515 | ... |  | ... | ... |

**UD 1800 Series**





|         |                           |             |     |        |     |  |     |     |
|---------|---------------------------|-------------|-----|--------|-----|--|-----|-----|
| 11 - 13 | Models with 19.5" Tires   | 56101-30Z01 | - 0 | 83161  | ... |  | ... | ... |
|         |                           | 56110-30Z01 | - 0 | 83161  | ... |  | ... | ... |
| 95 - 98 | Models with 19.5" Tires   | 56101-30Z01 | - 0 | 83161  | ... |  | ... | ... |
|         |                           | 56110-30Z01 | - 0 | 83161  | ... |  | ... | ... |
| 11 - 13 | Models with 22.5" Tires   | 56101-30Z02 | 0 - | G63610 | ... |  | ... | ... |
|         |                           | 56110-30Z02 | 0 - | G63610 | ... |  | ... | ... |
| 95 - 98 | Models with 22.5" Tires   | 56101-30Z02 | 0 - | G63610 | ... |  | ... | ... |
|         |                           | 56110-30Z02 | 0 - | G63610 | ... |  | ... | ... |
| 89 - 94 | Models with O.E.M. Number | 56101-Z5008 | - 0 | 83114  | ... |  | ... | ... |
|         |                           | 56110-Z5008 | - 0 | 83114  | ... |  | ... | ... |

**UD 18CS Series**

|         |                           |             |     |       |     |  |     |     |
|---------|---------------------------|-------------|-----|-------|-----|--|-----|-----|
| 05 - 10 | Models with 19.5" Tires   | 56101-30Z01 | - 0 | 83161 | ... |  | ... | ... |
|         |                           | 56110-30Z01 | - 0 | 83161 | ... |  | ... | ... |
| 99 - 04 | Models with O.E.M. Number | 56101-Z5008 | - 0 | 83114 | ... |  | ... | ... |
|         |                           | 56110-Z5008 | - 0 | 83114 | ... |  | ... | ... |



## APPLICATION GUIDE - TRUCKS, TRAILERS, AND BUSES

| Year<br>Año<br>Année | Model<br>Modelo<br>Modèle | OEM # | Front   |   | Rear  |   |
|----------------------|---------------------------|-------|---|---|---|---|
|                      |                           |       |  |  |  |  |
|                      |                           |       | Fleetline   | GasSLX  | Fleetline   | GasSLX  |

### NISSAN(Cont'd.)

#### UD 18CS Series(Cont'd.)

|         |                           |             |  |     |     |     |              |     |
|---------|---------------------------|-------------|--|-----|-----|-----|--------------|-----|
| 99 - 04 | Models with O.E.M. Number | 56201-Z5001 |  | ... | ... | - - | <b>85085</b> | ... |
|         |                           | 56210-Z5001 |  | ... | ... | - - | <b>85085</b> | ... |

#### UD 18HD Series

|         |                         |             |     |               |     |  |     |     |
|---------|-------------------------|-------------|-----|---------------|-----|--|-----|-----|
| 99 - 10 | Models with 19.5" Tires | 56101-30Z01 | - O | <b>83161</b>  | ... |  | ... | ... |
|         |                         | 56110-30Z01 | - O | <b>83161</b>  | ... |  | ... | ... |
| 99 - 10 | Models with 22.5" Tires | 56101-30Z02 | O - | <b>G63610</b> | ... |  | ... | ... |
|         |                         | 56110-30Z02 | O - | <b>G63610</b> | ... |  | ... | ... |

#### UD 2000 Series

|         |                                    |             |     |               |     |  |     |     |
|---------|------------------------------------|-------------|-----|---------------|-----|--|-----|-----|
| 95 - 13 | Models with 19.5" Tires            | 56101-30Z01 | - O | <b>83161</b>  | ... |  | ... | ... |
|         |                                    | 56110-30Z01 | - O | <b>83161</b>  | ... |  | ... | ... |
|         | Models with 22.5" Tires            | 56110-Z5011 | - O | <b>G63610</b> | ... |  | ... | ... |
| 95 - 13 | Models with 22.5" Tires            | 56101-30Z02 | O - | <b>G63610</b> | ... |  | ... | ... |
|         |                                    | 56110-30Z02 | O - | <b>G63610</b> | ... |  | ... | ... |
| 89 - 94 | U D 2000 Models with O.E.M. Number | 56101-Z5008 | - O | <b>83114</b>  | ... |  | ... | ... |
|         |                                    | 56110-Z5008 | - O | <b>83114</b>  | ... |  | ... | ... |

#### UD 23DH Series

|         |                         |             |     |               |     |  |     |     |
|---------|-------------------------|-------------|-----|---------------|-----|--|-----|-----|
| 95 - 13 | Models with 19.5" Tires | 56101-30Z01 | - O | <b>83161</b>  | ... |  | ... | ... |
|         |                         | 56110-30Z01 | - O | <b>83161</b>  | ... |  | ... | ... |
| 95 - 13 | Models with 22.5" Tires | 56101-30Z02 | O - | <b>G63610</b> | ... |  | ... | ... |
|         |                         | 56110-30Z02 | O - | <b>G63610</b> | ... |  | ... | ... |

#### UD 23LP Series

|         |                         |             |     |               |     |  |     |     |
|---------|-------------------------|-------------|-----|---------------|-----|--|-----|-----|
| 95 - 13 | Models with 19.5" Tires | 56101-30Z01 | - O | <b>83161</b>  | ... |  | ... | ... |
|         |                         | 56110-30Z01 | - O | <b>83161</b>  | ... |  | ... | ... |
| 95 - 13 | Models with 22.5" Tires | 56101-30Z02 | O - | <b>G63610</b> | ... |  | ... | ... |
|         |                         | 56110-30Z02 | O - | <b>G63610</b> | ... |  | ... | ... |

#### UD 2600 Series

|         |                                    |             |     |              |     |     |              |     |
|---------|------------------------------------|-------------|-----|--------------|-----|-----|--------------|-----|
| 89 - 13 | U D 2600 Models with O.E.M. Number | 56101-Z5014 | - O | <b>83162</b> | ... |     | ...          | ... |
|         |                                    | 56101-Z5017 | - O | <b>83162</b> | ... |     | ...          | ... |
|         |                                    | 56110-Z5014 | - O | <b>83162</b> | ... |     | ...          | ... |
|         |                                    | 56110-Z5017 | - O | <b>83162</b> | ... |     | ...          | ... |
| 92 - 94 | U D 2600 Models with O.E.M. Number | 56201-Z5001 |     | ...          | ... | - - | <b>85085</b> | ... |
|         |                                    | 56210-Z5001 |     | ...          | ... | - - | <b>85085</b> | ... |









#### UD 2800 Series

|         |                                    |             |     |              |     |     |              |     |
|---------|------------------------------------|-------------|-----|--------------|-----|-----|--------------|-----|
| 89 - 94 | U D 2800 Models with O.E.M. Number | 56101-Z5014 | - O | <b>83162</b> | ... |     | ...          | ... |
|         |                                    | 56101-Z5017 | - O | <b>83162</b> | ... |     | ...          | ... |
|         |                                    | 56110-Z5014 | - O | <b>83162</b> | ... |     | ...          | ... |
|         |                                    | 56110-Z5017 | - O | <b>83162</b> | ... |     | ...          | ... |
| 92 - 94 | U D 2800 Models with O.E.M. Number | 56201-Z5001 |     | ...          | ... | - - | <b>85085</b> | ... |
|         |                                    | 56210-Z5001 |     | ...          | ... | - - | <b>85085</b> | ... |

#### UD 3000 Series

|         |                                    |             |     |              |     |     |              |     |
|---------|------------------------------------|-------------|-----|--------------|-----|-----|--------------|-----|
| 89 - 91 | U D 3000 Models with O.E.M. Number | 56101-Z5014 | - O | <b>83162</b> | ... |     | ...          | ... |
|         |                                    | 56101-Z5017 | - O | <b>83162</b> | ... |     | ...          | ... |
|         |                                    | 56110-Z5014 | - O | <b>83162</b> | ... |     | ...          | ... |
|         |                                    | 56110-Z5017 | - O | <b>83162</b> | ... |     | ...          | ... |
| 95 - 00 | U D 3000 Models with O.E.M. Number | 56101-Z5014 | - O | <b>83162</b> | ... |     | ...          | ... |
|         |                                    | 56101-Z5017 | - O | <b>83162</b> | ... |     | ...          | ... |
|         |                                    | 56110-Z5014 | - O | <b>83162</b> | ... |     | ...          | ... |
|         |                                    | 56110-Z5017 | - O | <b>83162</b> | ... |     | ...          | ... |
| 89 - 94 | U D 3300 Models with O.E.M. Number | 56101-Z5014 | - O | <b>83162</b> | ... |     | ...          | ... |
|         |                                    | 56101-Z5017 | - O | <b>83162</b> | ... |     | ...          | ... |
|         |                                    | 56110-Z5014 | - O | <b>83162</b> | ... |     | ...          | ... |
|         |                                    | 56110-Z5017 | - O | <b>83162</b> | ... |     | ...          | ... |
| 92 - 94 | U D 3300 Models with O.E.M. Number | 56201-Z5001 |     | ...          | ... | - - | <b>85085</b> | ... |
|         |                                    | 56210-Z5001 |     | ...          | ... | - - | <b>85085</b> | ... |

## APPLICATION GUIDE - TRUCKS, TRAILERS, AND BUSES

| Year<br>Año<br>Année | Model<br>Modelo<br>Modèle | OEM # | Front  |   | Rear   |   |
|----------------------|---------------------------|-------|--|---|--|---|
|                      |                           |       |  |  |  |  |
|                      |                           |       |   |  |   |  |
|                      |                           |       | Fleetline  | GasSLX  | Fleetline  | GasSLX  |

### NISSAN(Cont'd.)

#### UD 3000 Series(Cont'd.)

|         |                                    |             |     |              |     |     |              |     |
|---------|------------------------------------|-------------|-----|--------------|-----|-----|--------------|-----|
| 99 - 13 | U D 3300 Models with O.E.M. Number | 56101-Z5014 | -10 | <b>83162</b> | ... |     | ...          | ... |
|         |                                    | 56101-Z5017 | -10 | <b>83162</b> | ... |     | ...          | ... |
|         |                                    | 56110-Z5014 | -10 | <b>83162</b> | ... |     | ...          | ... |
|         |                                    | 56110-Z5017 | -10 | <b>83162</b> | ... |     | ...          | ... |
|         |                                    | 56201-Z5001 |     | ...          | ... | -1- | <b>85085</b> | ... |
|         |                                    | 56210-Z5001 |     | ...          | ... | -1- | <b>85085</b> | ... |





#### Additional Applications

|         |                                |             |     |              |     |     |              |     |
|---------|--------------------------------|-------------|-----|--------------|-----|-----|--------------|-----|
| 92 - 94 | 30HD Models with O.E.M. Number | 56101-Z5014 | -10 | <b>83162</b> | ... |     | ...          | ... |
|         |                                | 56101-Z5017 | -10 | <b>83162</b> | ... |     | ...          | ... |
|         |                                | 56110-Z5014 | -10 | <b>83162</b> | ... |     | ...          | ... |
|         |                                | 56110-Z5017 | -10 | <b>83162</b> | ... |     | ...          | ... |
|         |                                | 56201-Z5001 |     | ...          | ... | -1- | <b>85085</b> | ... |
|         |                                | 56210-Z5001 |     | ...          | ... | -1- | <b>85085</b> | ... |
| 92 - 94 | 30SD Models with O.E.M. Number | 56101-Z5014 | -10 | <b>83162</b> | ... |     | ...          | ... |
|         |                                | 56101-Z5017 | -10 | <b>83162</b> | ... |     | ...          | ... |
|         |                                | 56110-Z5014 | -10 | <b>83162</b> | ... |     | ...          | ... |
|         |                                | 56110-Z5017 | -10 | <b>83162</b> | ... |     | ...          | ... |
|         |                                | 56201-Z5001 |     | ...          | ... | -1- | <b>85085</b> | ... |
|         |                                | 56210-Z5001 |     | ...          | ... | -1- | <b>85085</b> | ... |
| 89 - 91 | 500T Models with O.E.M. Number | 56101-Z5014 | -10 | <b>83162</b> | ... |     | ...          | ... |
|         |                                | 56101-Z5017 | -10 | <b>83162</b> | ... |     | ...          | ... |
|         |                                | 56110-Z5014 | -10 | <b>83162</b> | ... |     | ...          | ... |
|         |                                | 56110-Z5017 | -10 | <b>83162</b> | ... |     | ...          | ... |
| 92 - 94 | 600T Models with O.E.M. Number | 56101-Z5014 | -10 | <b>83162</b> | ... |     | ...          | ... |
|         |                                | 56101-Z5017 | -10 | <b>83162</b> | ... |     | ...          | ... |
|         |                                | 56110-Z5014 | -10 | <b>83162</b> | ... |     | ...          | ... |
|         |                                | 56110-Z5017 | -10 | <b>83162</b> | ... |     | ...          | ... |
|         |                                | 56201-Z5001 |     | ...          | ... | -1- | <b>85085</b> | ... |
|         |                                | 56210-Z5001 |     | ...          | ... | -1- | <b>85085</b> | ... |

### NOVA BUS

|              |   |               |         |              |     |     |              |     |
|--------------|---|---------------|---------|--------------|-----|-----|--------------|-----|
|              | Classic Bus with O.E.M. Number          | 97-2201-00151 |         | <b>85700</b> | ... | 010 | <b>85700</b> | ... |
|              | Low Floor Bus Models with O.E.M. Number | 481700131250  | 010     | <b>85377</b> | ... |     | ...          | ... |
|              |   | 481700131252  |         | ...          | ... | 010 | <b>85378</b> | ... |
|              |   | 680480        | 010     | <b>85377</b> | ... |     | ...          | ... |
|              |   | 695393        | 010     | <b>85377</b> | ... |     | ...          | ... |
|              |   | N16248        | 010     | <b>85377</b> | ... |     | ...          | ... |
|              |   | N16249        |         | ...          | ... | 010 | <b>85378</b> | ... |
|              |   | N21543        |         | ...          | ... | 010 | <b>85378</b> | ... |
|              |   | N31830        |         | ...          | ... | 010 | <b>85378</b> | ... |
|              |   | N31831        | 010     | <b>85377</b> | ... |     | ...          | ... |
|              |   |               | RTS Bus | 22045526     |     | ... | ...          | 010 |
| 22052014     |   |               |         | ...          | ... | 010 | <b>85702</b> | ... |
| G1011822     |   |               |         | ...          | ... | 010 | <b>85702</b> | ... |
| G1203223     |   |               |         | ...          | ... | 010 | <b>85702</b> | ... |
| G1205763     | 010                                     |               |         | <b>87019</b> | ... |     | ...          | ... |
| G1205763-001 | 010                                     |               |         | <b>87019</b> | ... |     | ...          | ... |
| OE 10086S    |   |               |         | ...          | ... | 010 | <b>85702</b> | ... |
|              | RTS Bus with "V" Drive                  | G1011823      | -10     | <b>85710</b> | ... |     | ...          | ... |
|              |   | G1101590      |         | ...          | ... | 010 | <b>85713</b> | ... |
|              | RTS Bus with Solid Front Axle           | 22024673      | -10     | <b>85710</b> | ... |     | ...          | ... |
|              | Models with O.E.M. Number               | 12J-5-10      |         | ...          | ... | 01- | <b>85733</b> | ... |
|              |   | 12J-5-11      |         | ...          | ... | 010 | <b>85313</b> | ... |
|              |   | 680231        |         | ...          | ... | 010 | <b>85313</b> | ... |

## APPLICATION GUIDE - TRUCKS, TRAILERS, AND BUSES

| Year<br>Año<br>Année | Model<br>Modelo<br>Modèle | OEM # | Front   |   | Rear  |   |
|----------------------|---------------------------|-------|---|---|---|---|
|                      |                           |       |  |  |  |  |
|                      |                           |       | Fleetline   | GasSLX  | Fleetline   | GasSLX  |

### NOVA BUS(Cont'd.)

|  |                           |                                |               |       |       |     |       |     |
|--|---------------------------|--------------------------------|---------------|-------|-------|-----|-------|-----|
|  | Models with O.E.M. Number | 680232                         |               | ...   | ...   | 01- | 85733 | ... |
|  |                           | 680323                         | 010           | 85700 | ...   |     | ...   | ... |
|  |                           | 680326                         | 010           | 85700 | ...   |     | ...   | ... |
|  |                           | 680470                         |               | ...   | ...   | 010 | 85713 | ... |
|  |                           | 680481                         |               | ...   | ...   | 010 | 85378 | ... |
|  |                           | G1201338                       | -10           | 85710 | ...   |     | ...   | ... |
|  |                           | G1201339                       |               | ...   | ...   | 010 | 85702 | ... |
|  |                           | G5008070                       | 010           | 85700 | ...   |     | ...   | ... |
|  |                           | N22212                         | 010           | 85700 | ...   |     | ...   | ... |
|  |                           | Additional O.E.M. Interchanges | 97-9999-02514 | 010   | 85700 |     |       |     |

### OLE GRANNING

|  |                           |      |     |       |     |  |     |     |
|--|---------------------------|------|-----|-------|-----|--|-----|-----|
|  | Models with O.E.M. Number | 1086 | 010 | 83217 | ... |  | ... | ... |
|--|---------------------------|------|-----|-------|-----|--|-----|-----|

### ONEIDA PRODUCTS

|  |                                    |       |  |       |     |     |       |     |
|--|------------------------------------|-------|--|-------|-----|-----|-------|-----|
|  | School Bus w/Heavy Duty Suspension | ..... |  | 85307 | ... | 010 | 85307 | ... |
|  | School Bus w/Standard Suspension   | ..... |  | 83216 | ... | 010 | 83216 | ... |





### OPTIMA BUS CORP

|  |   |             |  |     |     |     |       |     |
|--|---|-------------|--|-----|-----|-----|-------|-----|
|  | Buses with Ridewell RAS - 227 Models Steer Axle Air Suspension w/ O.E.M. Number | 1260008     |  | ... | ... | 010 | 87017 | ... |
|  |   | 90-2610-SP1 |  | ... | ... | 010 | 87017 | ... |

### ORION BUS INDUSTRIES

|  |                                      |             |                      |           |       |       |       |       |
|--|--------------------------------------|-------------|----------------------|-----------|-------|-------|-------|-------|
|  | Orion 1                              | 010134505-4 | 010                  | 85715     | ...   |       | ...   | ...   |
|  |                                      | 010134509   | 010                  | 85717     | ...   |       | ...   | ...   |
|  |                                      | 010234503-4 |                      | ...       | ...   | 010   | 85308 | 89422 |
|  |                                      | 010234506   |                      | ...       | ...   | 010   | 85715 | ...   |
|  | Orion 102                            | 050134501-4 | 010                  | 85716     | ...   |       | ...   | ...   |
|  |                                      | 050230501   |                      | ...       | ...   | 010   | 85716 | ...   |
|  |                                      | 050231505   |                      | ...       | ...   | 010   | 85716 | ...   |
|  |                                      | 680504      |                      | ...       | ...   | 010   | 85716 | ...   |
|  | Orion II                             | 010134505-4 | 010                  | 85715     | ...   |       | ...   | ...   |
|  |                                      | 010234503-4 |                      | ...       | ...   | 010   | 85308 | 89422 |
|  |                                      | 020117504   | 010                  | 85720     | ...   |       | ...   | ...   |
|  |                                      | 020273541   | 010                  | 83203     | 89436 |       | ...   | ...   |
|  |                                      | 020273541-4 |                      | ...       | ...   | 010   | 85000 | 89436 |
|  |                                      | 020273544   | 010                  | 83203     | 89436 |       | ...   | ...   |
|  |                                      | 20117501    | 010                  | 85720     | ...   |       | ...   | ...   |
|  |                                      | 20117503    | 010                  | 85720     | ...   |       | ...   | ...   |
|  |                                      | 20117504    | 010                  | 85720     | ...   |       | ...   | ...   |
|  |                                      | 20117505    | 010                  | 85720     | ...   |       | ...   | ...   |
|  | Orion V                              | 010134508-4 | 010                  | 85732     | ...   |       | ...   | ...   |
|  |                                      | 050134502-4 | 010                  | 85732     | ...   |       | ...   | ...   |
|  |                                      | 050134506-4 | 010                  | 85732     | ...   |       | ...   | ...   |
|  |                                      | 050134509   | 010                  | 85732     | ...   |       | ...   | ...   |
|  |                                      | 050134510   | 010                  | 85732     | ...   |       | ...   | ...   |
|  |                                      | 050134513   | 010                  | 85732     | ...   |       | ...   | ...   |
|  |                                      | 050231505   |                      | ...       | ...   | 010   | 85716 | ...   |
|  |                                      | 680504      |                      | ...       | ...   | 010   | 85716 | ...   |
|  |                                      | 695347      | 010                  | 85732     | ...   |       | ...   | ...   |
|  |                                      |             | Orion VI (Low Floor) | 060231508 | 010   | 85717 | ...   |       |
|  | Orion VI (M Axle) with O.E.M. Number | 060131507   | -10                  | 87016     | ...   |       | ...   | ...   |
|  |                                      | 060131508   | -10                  | 87016     | ...   |       | ...   | ...   |
|  | Orion VII - 30 ft Rear               | 070231527   |                      | ...       | ...   | 01-   | 85729 | ...   |
|  | Orion VII with O.E.M. Number         | 070131502   | -10                  | 87016     | ...   |       | ...   | ...   |

**APPLICATION GUIDE - TRUCKS, TRAILERS, AND BUSES**

| Year<br>Año<br>Année | Model<br>Modelo<br>Modèle | OEM # | Front   |  | Rear  |   |
|----------------------|---------------------------|-------|---|--|---|---|
|                      |                           |       |  |  |  |  |
|                      |                           |       | Fleetline   | GasSLX   | Fleetline   | GasSLX  |









**ORION BUS INDUSTRIES(Cont'd.)**

|               |                              |           |                                |              |              |     |                       |     |              |  |
|---------------|------------------------------|-----------|--------------------------------|--------------|--------------|-----|-----------------------|-----|--------------|--|
|               | Orion VII with O.E.M. Number | 070131506 | -10                            | <b>87016</b> | ...          |     | ...                   | ... |              |  |
|               |                              | 070231514 |                                | ...          | ...          | 01- | <b>85729</b>          | ... |              |  |
|               | Models with O.E.M. Number    | 680271    |                                | ...          | ...          | 010 | <b>85715</b>          | ... |              |  |
|               |                              | 680274    |                                | ...          | ...          | 010 | <b>85716</b>          | ... |              |  |
|               |                              | 680328    | 010                            | <b>85717</b> | ...          |     | ...                   | ... |              |  |
|               |                              | 680378    | 010                            | <b>85720</b> | ...          |     | ...                   | ... |              |  |
|               |                              | 695327    | 010                            | <b>85732</b> | ...          |     | ...                   | ... |              |  |
|               |                              | 695343    | 010                            | <b>85732</b> | ...          |     | ...                   | ... |              |  |
|               |                              | 695366    | 010                            | <b>85732</b> | ...          |     | ...                   | ... |              |  |
|               |                              | 695389    | -10                            | <b>87016</b> | ...          |     | ...                   | ... |              |  |
|               |                              | 695420    |                                | ...          | ...          | 01- | <b>85729</b>          | ... |              |  |
|               |                              | 695421    | -10                            | <b>87016</b> | ...          |     | ...                   | ... |              |  |
|               |                              | 695440    |                                | ...          | ...          | 01- | <b>85729</b>          | ... |              |  |
|               |                              |           | Additional O.E.M. Interchanges | 010134501-4  | 010          |     |                       |     | <b>85307</b> |  |
|               |                              |           |                                | 010134504-4  | 010          |     |                       |     | <b>85715</b> |  |
| 010134506-4   | 010                          |           |                                |              |              |     | <b>85717</b>          |     |              |  |
| 050134508     | 010                          |           |                                |              |              |     | <b>85732</b>          |     |              |  |
| 0501345-11    | 010                          |           |                                |              |              |     | <b>85732</b>          |     |              |  |
| 050231502-4   | 010                          |           |                                |              |              |     | <b>85716</b>          |     |              |  |
| 050231507     | 010                          |           |                                |              |              |     | <b>85716</b>          |     |              |  |
| 680091        | 010                          |           |                                |              |              |     | <b>85303 or 89422</b> |     |              |  |
| 680102        | 010                          |           |                                |              |              |     | <b>85712</b>          |     |              |  |
| 680352        | -10                          |           |                                |              |              |     | <b>85711</b>          |     |              |  |
| 680501        | 010                          |           |                                |              |              |     | <b>85715</b>          |     |              |  |
| 680502        | 010                          |           |                                |              |              |     | <b>85715</b>          |     |              |  |
| 680505        | 010                          |           |                                |              |              |     | <b>85717</b>          |     |              |  |
| 680506        | 010                          |           |                                |              |              |     | <b>85732</b>          |     |              |  |
| 690102        | -10                          |           |                                |              |              |     | <b>85711</b>          |     |              |  |
| 97-9999-02635 | 010                          |           |                                |              |              |     | <b>85732</b>          |     |              |  |
| 97-9999-02636 | 010                          |           |                                |              |              |     | <b>85716</b>          |     |              |  |
| A-4890        | 010                          |           |                                |              |              |     | <b>85712</b>          |     |              |  |
| OB020570      | -10                          |           |                                |              |              |     | <b>85711</b>          |     |              |  |
| OB020764      | 010                          |           |                                |              |              |     | <b>85716</b>          |     |              |  |
| OB3166657     | 010                          |           |                                |              | <b>85700</b> |     |                       |     |              |  |

**OSHKOSH MOTORS**

|  |  |           |     |               |              |     |               |     |
|--|--|-----------|-----|---------------|--------------|-----|---------------|-----|
|  | Mobile Home - ForeTravel                               | 1583470   |     | ...           | ...          | 010 | <b>85051</b>  | ... |
|  | Models with 16" Long Shock Absorber w/1" Mounting Pins | ....      | 010 | <b>85303</b>  | <b>89422</b> |     | ...           | ... |
|  | Models with 3/4" Mounting Pins                         | ....      | 010 | <b>83122</b>  | <b>89406</b> |     | ...           | ... |
|  | Models with Neway Air Suspension                       | 90044448  |     | ...           | ...          | 010 | <b>85051</b>  | ... |
|  | Motor Homes with O.E.M. Number                         | 1398980   |     | <b>83127</b>  | ...          | 010 | <b>83127</b>  | ... |
|  |  | GBL654875 |     | ...           | ...          | 010 | <b>83117</b>  | ... |
|  |  | RW24285   | 010 | <b>83119</b>  | ...          |     | ...           | ... |
|  | V - Line Coach   | 1573280   |     | ...           | ...          | 010 | <b>83221</b>  | ... |
|  | Models with O.E.M. Number                              | 12405F    | 010 | <b>85734</b>  | ...          |     | ...           | ... |
|  |  | 12405F-1  | 010 | <b>85303</b>  | <b>89422</b> |     | ...           | ... |
|  |  | 1583470   |     | ...           | ...          | 010 | <b>85051</b>  | ... |
|  |  | 3638112   |     | ...           | ...          | 010 | <b>G63183</b> | ... |
|  |  | 4036892   | 010 | <b>G63605</b> | ...          |     | ...           | ... |
|  |  | 5353054   | 010 | <b>85303</b>  | <b>89422</b> |     | ...           | ... |
|  |  | 5361994   | 010 | <b>85734</b>  | ...          |     | ...           | ... |
|  |  | 651444    |     | ...           | ...          | 010 | <b>83221</b>  | ... |
|  |  | 665040    | 010 | <b>85303</b>  | <b>89422</b> |     | ...           | ... |
|  |  | 690049    | 010 | <b>85303</b>  | <b>89422</b> |     | ...           | ... |
|  |  | GBL654918 | 010 | <b>83118</b>  | ...          |     | ...           | ... |

## APPLICATION GUIDE - TRUCKS, TRAILERS, AND BUSES

| Year<br>Año<br>Année | Model<br>Modelo<br>Modèle | OEM # | Front   |   | Rear  |   |
|----------------------|---------------------------|-------|---|---|---|---|
|                      |                           |       |  |  |  |  |
|                      |                           |       |  |  |  |  |
|                      |                           |       | Fleetline   | GasSLX  | Fleetline   | GasSLX  |

### OSHKOSH MOTORS(Cont'd.)

|  |                                |          |     |                       |     |     |              |     |
|--|--------------------------------|----------|-----|-----------------------|-----|-----|--------------|-----|
|  | Models with O.E.M. Number      | P117099  |     | ...                   | ... | 01- | <b>83120</b> | ... |
|  |                                | P117146  | 010 | <b>83118</b>          | ... |     | ...          | ... |
|  | Additional O.E.M. Interchanges | 12405FX1 | 010 | <b>85303 or 89422</b> |     |     |              |     |
|  |                                | 1445910  | 010 | <b>85300 or 89419</b> |     |     |              |     |
|  |                                | 1573270  | 010 | <b>83207 or 89407</b> |     |     |              |     |
|  |                                | 1745500  | 010 | <b>89430</b>          |     |     |              |     |
|  |                                | 2173340  | 010 | <b>85303 or 89422</b> |     |     |              |     |
|  |                                | 26228-A  | 010 | <b>83122 or 89406</b> |     |     |              |     |
|  |                                | 2JD137   | 010 | <b>83119</b>          |     |     |              |     |
|  |                                | 40-0242  | 010 | <b>83312 or 89409</b> |     |     |              |     |
|  |                                | 40-4845  | 010 | <b>85304</b>          |     |     |              |     |
|  |                                | 40-4951  | 10  | <b>85316 or 89426</b> |     |     |              |     |
|  |                                | 40-5348  | 010 | <b>85058 or 89431</b> |     |     |              |     |
|  |                                | 40-6967  | 010 | <b>85030 or 89440</b> |     |     |              |     |
|  |                                | 665060   | 010 | <b>83122 or 89406</b> |     |     |              |     |

### OSHKOSH MOTORS CAB SHOCKS

|  |  |           |     |              |  |  |  |  |
|--|--|-----------|-----|--------------|--|--|--|--|
|  | Models with Link Cabmate Model OKTP with O.E.M. Number | 1202-0054 | 010 | <b>83021</b> |  |  |  |  |
|  | Models with O.E.M. Number                              | 2218640   | 010 | <b>83009</b> |  |  |  |  |

### OSTERLUND TRUCK

|  |                                |           |     |              |              |     |              |     |
|--|--------------------------------|-----------|-----|--------------|--------------|-----|--------------|-----|
|  | Models with O.E.M. Number      | 59011     | 010 | <b>83214</b> | ...          |     | ...          | ... |
|  |                                | 680117    | 010 | <b>85300</b> | <b>89419</b> |     | ...          | ... |
|  | Additional O.E.M. Interchanges | 220-S5-10 |     | ...          | ...          | 010 | <b>85712</b> | ... |

### OTTAWA TRUCK

|  |                                |          |     |                       |              |     |              |     |
|--|--------------------------------|----------|-----|-----------------------|--------------|-----|--------------|-----|
|  | Yard Tractor                   | 59009    |     | <b>83217</b>          | ...          | 010 | <b>83217</b> | ... |
|  | Models with O.E.M. Number      | 59011    | 010 | <b>83214</b>          | ...          |     | ...          | ... |
|  |                                | 680117   | 010 | <b>85300</b>          | <b>89419</b> |     | ...          | ... |
|  | Additional O.E.M. Interchanges | 53540451 | 010 | <b>85300 or 89419</b> |              |     |              |     |
|  |                                | 90013787 | 1-  | <b>85310 or 89423</b> |              |     |              |     |
|  |                                | 9007342  | 010 | <b>85303 or 89422</b> |              |     |              |     |
|  | Yard Tractor                   | 90027577 | 010 | <b>85720</b>          | ...          |     | ...          | ... |

### PACCAR

#### Additional Applications

|  |                                   |        |  |     |     |    |              |              |
|--|-----------------------------------|--------|--|-----|-----|----|--------------|--------------|
|  | TruckMaster Shock Stamping Number | 665633 |  | ... | ... | 10 | <b>85033</b> | <b>89427</b> |
|--|-----------------------------------|--------|--|-----|-----|----|--------------|--------------|

### PACIFIC TRUCK & TRAILER

|  |                                |          |     |                       |  |  |  |  |
|--|--------------------------------|----------|-----|-----------------------|--|--|--|--|
|  | Additional O.E.M. Interchanges | 3178157C | 010 | <b>85735</b>          |  |  |  |  |
|  |                                | 507202C1 | 010 | <b>85030 or 89440</b> |  |  |  |  |









### PAGE SUSPENSION

|  |  |         |  |     |     |     |              |              |
|--|--|---------|--|-----|-----|-----|--------------|--------------|
|  | Model with LM-2000 Models Lift Axle Suspension | 1080099 |  | ... | ... | 010 | <b>83203</b> | <b>89436</b> |
|  | Model with Trailmaster Air Spring Suspension   | 1081933 |  | ... | ... | 010 | <b>83204</b> | ...          |
|  |  | A-2212  |  | ... | ... | 010 | <b>85029</b> | ...          |
|  | Models with O.E.M. Number                      | 665133  |  | ... | ... | 010 | <b>83203</b> | <b>89436</b> |
|  |  | 665267  |  | ... | ... | 010 | <b>85029</b> | ...          |

### PAI CORP

|  |                           |          |     |              |     |  |     |     |
|--|---------------------------|----------|-----|--------------|-----|--|-----|-----|
|  | Models with O.E.M. Number | HSA-5067 | 010 | <b>85305</b> | ... |  | ... | ... |
|  |                           | HSA-5080 | 010 | <b>83221</b> | ... |  | ... | ... |
|  |                           | HSA-5095 | 010 | <b>83215</b> | ... |  | ... | ... |

## APPLICATION GUIDE - TRUCKS, TRAILERS, AND BUSES

| Year<br>Año<br>Année | Model<br>Modelo<br>Modèle | OEM # | Front  |  | Rear  |   |
|----------------------|---------------------------|-------|--|--|---|---|
|                      |                           |       |  |  |  |  |
|                      |                           |       |   |   |  |  |
|                      |                           |       | Fleetline  | GasSLX   | Fleetline   | GasSLX  |

### PEERLESS TRAILER

|                            |       |  |     |     |     |              |     |
|----------------------------|-------|--|-----|-----|-----|--------------|-----|
| Models with Air Suspension | 72-61 |  | ... | ... | OIO | <b>83125</b> | ... |
| Models with O.E.M. Number  | 120-1 |  | ... | ... | OIO | <b>83125</b> | ... |

### PETERBILT

#### 210 Series

|   |          |  |     |     |     |              |     |
|---|----------|--|-----|-----|-----|--------------|-----|
| Models with Reyco 79KB Rear Steel Spring Suspension | 16725-01 |  | ... | ... | OIO | <b>83126</b> | ... |
|   | 19495-01 |  | ... | ... | OIO | <b>83126</b> | ... |

#### 220 Series

|         |  |            |     |              |              |              |              |              |
|---------|--|------------|-----|--------------|--------------|--------------|--------------|--------------|
| 07 - 12 | Models with 12,000 lb Front Axle                                     | 02-02738   | OIO | <b>85012</b> | <b>89413</b> |              | ...          | ...          |
|         |  |            |     | B71-6016     | OIO          | <b>85012</b> | <b>89413</b> | ...          |
| 13 - 19 | Models with 12,000 lb Front Axle                                     | 1707378PAC | - - | <b>85182</b> | ...          |              | ...          | ...          |
|         |  |            |     | BFRG072      | - -          | <b>85182</b> | ...          | ...          |
| 07 - 19 | Models with Hendrickson HAS - 210L or HAS - 230L Rear Air Suspension | 60670-008  |     | ...          | ...          | OIO          | <b>83123</b> | <b>89405</b> |
|         |  |            |     | 60670-008L   | OIO          | <b>83123</b> | <b>89405</b> |              |
| 07 - 19 | Models with Reyco 102AR (Standard) Rear Air Suspension               | 12887-01   |     | ...          | ...          | OIO          | <b>85013</b> | <b>89414</b> |
|         |  |            |     | 12887-02     | OIO          | <b>85013</b> | <b>89414</b> |              |
| 07 - 19 | Models with Reyco 21,000 lb Spring Suspension                        | 19495-01   |     | ...          | ...          | OIO          | <b>83126</b> | <b>89440</b> |
| 07 - 19 | Models with Reyco 79KB Rear Steel Spring Suspension                  | 16725-01   |     | ...          | ...          | OIO          | <b>83126</b> | ...          |
|         |  |            |     | 19495-01     | OIO          | <b>83126</b> | ...          |              |

#### 270 Series

|   |         |  |     |     |     |              |     |
|---|---------|--|-----|-----|-----|--------------|-----|
| Models with Woodhead Shock (Stamping Number ACHB 966) | ACHB966 |  | ... | ... | - - | <b>83136</b> | ... |
|---|---------|--|-----|-----|-----|--------------|-----|

#### 320 Series

|         |  |              |     |              |              |              |              |              |     |
|---------|--|--------------|-----|--------------|--------------|--------------|--------------|--------------|-----|
| 87 - 18 | Models with 12,000 lb to 14,600 lb Taperleaf Spring Suspension and Set Forward Front Axle.       | 02-01787     | OIO | <b>85062</b> | <b>89408</b> |              | ...          | ...          |     |
|         |  |              |     | 02-02737     | OIO          | <b>85062</b> | <b>89408</b> | ...          | ... |
|         |  |              |     | B71-6009     | OIO          | <b>85062</b> | <b>89408</b> | ...          | ... |
| 01 - 19 | Models with 18,000 lb to 23,000 lb Taperleaf Front Spring Suspension and Set Forward Front Axle. | 02-02742     | OIO | <b>85062</b> | <b>89408</b> |              | ...          | ...          |     |
|         |  |              |     | B71-6011     | OIO          | <b>85062</b> | <b>89408</b> | ...          | ... |
| 87 - 13 | Models with Air Trac Suspension  | 03-07421     |     | ...          | ...          | - O          | <b>85311</b> | <b>89424</b> |     |
| 14 - 18 | Models with Air Trac Suspension (40,000 lb)  | C71-6003     |     | ...          | ...          | - O          | <b>85988</b> | ...          |     |
| 14 - 18 | Models with Air Trac Suspension (46,000 lb)  | C71-6002     |     | ...          | ...          | - O          | <b>85311</b> | <b>89424</b> |     |
| 01 - 19 | Models with Hendrickson HMX 400/460 Haulmax with 16.5" Saddle                                    | 60680-004    |     | ...          | ...          | O -          | <b>83143</b> | ...          |     |
|         |  |              |     | 60680-004L   | O -          | <b>83143</b> | ...          |              |     |
| 01 - 19 | Models with Hendrickson HMX 400/460 Haulmax with 17.5" & 18.5" Saddle                            | 60680-005    |     | ...          | ...          | O -          | <b>83142</b> | ...          |     |
|         |  |              |     | 60680-005L   | O -          | <b>83142</b> | ...          |              |     |
|         |  |              |     | 90045132     | OIO          | <b>85909</b> | ...          |              |     |
|         | Models with Neway ADZ Rear Suspension  | 471700004423 |     | ...          | ...          | OIO          | <b>85109</b> | ...          |     |
|         |  | 90045605     |     | ...          | ...          | OIO          | <b>85109</b> | ...          |     |
| 02 - 18 | Models with Peterbilt Low Air Leaf Suspension  | 03-08781     |     | ...          | ...          | - -          | <b>85069</b> | <b>89455</b> |     |
|         |  |              |     | C71-1011     | - -          | <b>85069</b> | <b>89455</b> |              |     |
|         |  |              |     | C71-1017     | - -          | <b>85069</b> | <b>89455</b> |              |     |
|         | Models with Quadraflex 4 Spring Rear Suspension  | 03-07420     |     | ...          | ...          | - -          | <b>85336</b> | ...          |     |
|         | Models with Reyco 102AR (Standard) Rear Air Suspension   | 12887-01     |     | ...          | ...          | OIO          | <b>85013</b> | <b>89414</b> |     |
|         |  | 12887-02     |     | ...          | ...          | OIO          | <b>85013</b> | <b>89414</b> |     |
|         | Models with Reyco 79KB Rear Steel Spring Suspension  | 16725-01     |     | ...          | ...          | OIO          | <b>83126</b> | ...          |     |
|         |  | 19495-01     |     | ...          | ...          | OIO          | <b>83126</b> | ...          |     |





#### 325 Series

|         |   |          |     |              |              |     |              |              |
|---------|---|----------|-----|--------------|--------------|-----|--------------|--------------|
| 08 - 19 | Models with 21,000 lb Reyco Spring Suspension | 19495-01 |     | ...          | ...          | OIO | <b>83126</b> | <b>89440</b> |
| 08 - 15 | Models with 8,000 lb Front Axle               | B71-6004 | OIO | <b>85084</b> | <b>89460</b> |     | ...          | ...          |

#### 330 Series

|         |   |          |     |              |              |  |     |     |
|---------|---|----------|-----|--------------|--------------|--|-----|-----|
| 16 - 19 | Models with 10,000 lb to 14,600 lb Taperleaf Springs and Set Back Front Axles | B71-6019 | OIO | <b>85989</b> | ...          |  | ... | ... |
| 95 - 16 | Models with 12000 lb Set Back Front Axle                                      | 02-02738 | OIO | <b>85012</b> | <b>89413</b> |  | ... | ... |

**APPLICATION GUIDE - TRUCKS, TRAILERS, AND BUSES**

| Year<br>Año<br>Année | Model<br>Modelo<br>Modèle | OEM # | Front   |   | Rear  |   |
|----------------------|---------------------------|-------|---|---|---|---|
|                      |                           |       |  |  |  |  |
|                      |                           |       | Fleetline   | GasSLX  | Fleetline   | GasSLX  |

**PETERBILT(Cont'd.)**

**330 Series(Cont'd.)**

|         |  |           |     |       |       |     |       |       |
|---------|--|-----------|-----|-------|-------|-----|-------|-------|
| 95 - 16 | Models with 12000 lb Set Back Front Axle               | B71-6016  | 010 | 85012 | 89413 |     | ...   | ...   |
|         |  | B71-6016A | 010 | 85012 | 89413 |     | ...   | ...   |
| - 2018  | Models with 21,000 lb Reyco Spring Suspension          | 19495-01  |     | ...   | ...   | 010 | 83126 | 89440 |
| 87 - 13 | Models with Air Trac Suspension                        | 03-07421  |     | ...   | ...   | -10 | 85311 | 89424 |
| 14 - 19 | Models with Air Trac Suspension (40,000 lb)            | C71-6003  |     | ...   | ...   | -10 | 85988 | ...   |
| 14 - 19 | Models with Air Trac Suspension (46,000 lb)            | C71-6002  |     | ...   | ...   | -10 | 85311 | 89424 |
| 95 - 02 | Models with Peterbilt 40000 lb Low Air Leaf Suspension | 03-07423  |     | ...   | ...   | -10 | 85033 | 89427 |
| 03 - 19 | Models with Peterbilt Low Air Leaf Suspension          | 03-08781  |     | ...   | ...   | -1- | 85069 | 89455 |
|         |  | C71-1011  |     | ...   | ...   | -1- | 85069 | 89455 |
|         |  | C71-1017  |     | ...   | ...   | -1- | 85069 | 89455 |
|         | Models with Reyco 102AR (Standard) Rear Air Suspension | 12887-01  |     | ...   | ...   | 010 | 85013 | 89414 |
|         |  | 12887-02  |     | ...   | ...   | 010 | 85013 | 89414 |
| - 2018  | Models with Reyco 79KB Rear Steel Spring Suspension    | 16725-01  |     | ...   | ...   | 010 | 83126 | ...   |
|         |  | 19495-01  |     | ...   | ...   | 010 | 83126 | ...   |
|         | Models with O.E.M. Number                              | 02-03020  | 010 | 85910 | ...   |     | ...   | ...   |
|         |  | B71-6017  | 010 | 85910 | ...   |     | ...   | ...   |

**335 Series**

|         |   |           |     |       |       |     |       |       |
|---------|---|-----------|-----|-------|-------|-----|-------|-------|
| 05 - 10 | Models with 12000 lb Set Back Front Axle      | 02-02738  | 010 | 85012 | 89413 |     | ...   | ...   |
|         |   | 02-02741  | 010 | 85012 | 89413 |     | ...   | ...   |
|         |   | B71-6016  | 010 | 85012 | 89413 |     | ...   | ...   |
|         |   | B71-6016A | 010 | 85012 | 89413 |     | ...   | ...   |
| 05 - 10 | Models with Air Trac Suspension               | 03-07421  |     | ...   | ...   | -10 | 85311 | 89424 |
| 05 - 10 | Models with Peterbilt Low Air Leaf Suspension | 03-08781  |     | ...   | ...   | -1- | 85069 | 89455 |
|         |   | C71-1011  |     | ...   | ...   | -1- | 85069 | 89455 |
|         |   | C71-1017  |     | ...   | ...   | -1- | 85069 | 89455 |

**337 Series**

|         |   |          |     |       |       |     |       |       |
|---------|---|----------|-----|-------|-------|-----|-------|-------|
| 10 - 14 | Models with 10,000 lb to 12,000 lb Front Axle                                 | B71-6005 | 010 | 85084 | 89460 |     | ...   | ...   |
| 15 - 18 | Models with 10,000 lb to 14,600 lb Taperleaf Springs and Set Back Front Axles | B71-6019 | 010 | 85989 | ...   |     | ...   | ...   |
| 10 - 14 | Models with 13,200 lb to 14,600 lb Front Axle                                 | B71-6006 | 010 | 85084 | 89460 |     | ...   | ...   |
| 10 - 13 | Models with Air Trac Suspension   | 03-07421 |     | ...   | ...   | -10 | 85311 | 89424 |
| 14 - 19 | Models with Air Trac Suspension (40,000 lb)                                   | C71-6003 |     | ...   | ...   | -10 | 85988 | ...   |
| 14 - 19 | Models with Air Trac Suspension (46,000 lb)                                   | C71-6002 |     | ...   | ...   | -10 | 85311 | 89424 |
| 10 - 19 | Models with Peterbilt Low Air Leaf Suspension                                 | 03-08781 |     | ...   | ...   | -1- | 85069 | 89455 |
|         |   | C71-1011 |     | ...   | ...   | -1- | 85069 | 89455 |
|         |   | C71-1017 |     | ...   | ...   | -1- | 85069 | 89455 |
| 10 - 16 | Models with Reyco 102AR (Standard) Rear Air Suspension                        | 12887-01 |     | ...   | ...   | 010 | 85013 | 89414 |
|         |   | 12887-02 |     | ...   | ...   | 010 | 85013 | 89414 |
| 10 - 18 | Models with Reyco 79KB Rear Steel Spring Suspension                           | 16725-01 |     | ...   | ...   | 010 | 83126 | ...   |
|         |   | 19495-01 |     | ...   | ...   | 010 | 83126 | ...   |

**340 Series**

|         |  |           |     |       |       |     |       |       |
|---------|--|-----------|-----|-------|-------|-----|-------|-------|
| 07 - 10 | Models with 12000 lb Set Back Front Axle | 02-02738  | 010 | 85012 | 89413 |     | ...   | ...   |
|         |  | 02-02741  | 010 | 85012 | 89413 |     | ...   | ...   |
|         |  | B71-6016  | 010 | 85012 | 89413 |     | ...   | ...   |
|         |  | B71-6016A | 010 | 85012 | 89413 |     | ...   | ...   |
| 07 - 10 | Models with Air Trac Suspension          | 03-07421  |     | ...   | ...   | -10 | 85311 | 89424 |

**348 Series**

|         |   |          |     |       |       |     |       |       |
|---------|---|----------|-----|-------|-------|-----|-------|-------|
| 12 - 13 | Models with 10,000 lb to 12,000 lb Front Axle                                 | B71-6005 | 010 | 85084 | 89460 |     | ...   | ...   |
| 14 - 18 | Models with 10,000 lb to 14,600 lb Taperleaf Springs and Set Back Front Axles | B71-6019 | 010 | 85989 | ...   |     | ...   | ...   |
| 14 - 19 | Models with 20,000 lb Taperleaf Springs and Set Back Front Axles              | B71-6020 | 010 | 85989 | ...   |     | ...   | ...   |
| 10 - 13 | Models with Air Trac Suspension   | 03-07421 |     | ...   | ...   | -10 | 85311 | 89424 |
| 14 - 19 | Models with Air Trac Suspension (40,000 lb)                                   | C71-6003 |     | ...   | ...   | -10 | 85988 | ...   |
| 14 - 19 | Models with Air Trac Suspension (46,000 lb)                                   | C71-6002 |     | ...   | ...   | -10 | 85311 | 89424 |



## APPLICATION GUIDE - TRUCKS, TRAILERS, AND BUSES

| Year<br>Año<br>Année | Model<br>Modelo<br>Modèle | OEM # | Front         |            | Rear          |            |
|----------------------|---------------------------|-------|---------------|------------|---------------|------------|
|                      |                           |       | <br>Fleetline | <br>GasSLX | <br>Fleetline | <br>GasSLX |

### PETERBILT(Cont'd.)

#### 348 Series(Cont'd.)

|         |   |                          |     |       |     |       |       |
|---------|---|--------------------------|-----|-------|-----|-------|-------|
| 10 - 19 | Models with Hendrickson HMX 400/460 Haulmax with 16.5" Saddle         | 60680-004<br>60680-004L  | ... | ...   | 01- | 83143 | ...   |
|         |   |                          | ... | ...   | 01- | 83143 | ...   |
| 10 - 19 | Models with Hendrickson HMX 400/460 Haulmax with 17.5" & 18.5" Saddle | 60680-005<br>60680-005L  | ... | ...   | 01- | 83142 | ...   |
|         |   |                          | ... | ...   | 01- | 83142 | ...   |
| 10 - 19 | Models with Neway ADZ Rear Suspension                                 | 471700004423<br>90045605 | ... | ...   | 010 | 85109 | ...   |
|         |   |                          | ... | ...   | 010 | 85109 | ...   |
| 15 - 16 | Models with O.E.M. Number   | B71-6012                 | 010 | 85119 | ... | ...   | ...   |
| 10 - 19 | Models with Reyco 102AR (Standard) Rear Air Suspension                | 12887-01<br>12887-02     | ... | ...   | 010 | 85013 | 89414 |
|         |   |                          | ... | ...   | 010 | 85013 | 89414 |
| 10 - 19 | Models with Reyco 79KB Rear Steel Spring Suspension                   | 16725-01<br>19495-01     | ... | ...   | 010 | 83126 | ...   |
|         |   |                          | ... | ...   | 010 | 83126 | ...   |

#### 349 Series

|         |  |                                  |     |       |       |     |     |
|---------|--|----------------------------------|-----|-------|-------|-----|-----|
| 84 - 87 | 349 Conventional Models with 12000 lb capacity | 02-00376<br>02-00495<br>02-02736 | 010 | 85302 | 89420 | ... | ... |
|         |  |                                  | 010 | 85302 | 89420 | ... | ... |
|         |  |                                  | 010 | 85302 | 89420 | ... | ... |

#### 353 Series

|         |  |                                  |     |       |       |     |     |
|---------|--|----------------------------------|-----|-------|-------|-----|-----|
| 81 - 93 | 353 Conventional Models with 12000 lb capacity | 02-00376<br>02-00495<br>02-02736 | 010 | 85302 | 89420 | ... | ... |
|         |  |                                  | 010 | 85302 | 89420 | ... | ... |
|         |  |                                  | 010 | 85302 | 89420 | ... | ... |





#### 357 Series

|         |  |   |     |       |       |     |             |
|---------|--|---|-----|-------|-------|-----|-------------|
|         | Conventional Models with Front Air Suspension and Set Back Front Axle.                           | 02-02739  | 010 | 85013 | 89414 | ... | ...         |
|         | Conventional Models with Front Air Suspension and without Set Back Front Axle.                   | 02-02740  | 010 | 85036 | 89405 | ... | ...         |
| 87 - 08 | Conventional Models with Spring Suspension and with Set Back Front Axle.                         | 02-01890<br>02-02738<br>02-02741<br>B71-6016<br>B71-6016A | 010 | 85012 | 89413 | ... | ...         |
|         |  |   | 010 | 85012 | 89413 | ... | ...         |
|         |  |   | 010 | 85012 | 89413 | ... | ...         |
|         |  |   | 010 | 85012 | 89413 | ... | ...         |
| 87 - 08 | Models with 12,000 lb to 14,600 lb Taperleaf Spring Suspension and Set Forward Front Axle.       | 02-02737<br>B71-6007<br>B71-6009                          | 010 | 85062 | 89408 | ... | ...         |
|         |  |   | 010 | 85062 | 89408 | ... | ...         |
|         |  |   | 010 | 85062 | 89408 | ... | ...         |
| 87 - 08 | Models with 18,000 lb to 23,000 lb Taperleaf Front Spring Suspension and Set Forward Front Axle. | 02-02742<br>B71-6011                                      | 010 | 85062 | 89408 | ... | ...         |
| 87 - 08 | Models with Air Trac Suspension  | 03-07421  |     | ...   | ...   | -10 | 85311 89424 |
| 97 - 08 | Models with Air Track Tandem with TRD8000 Pusher Axle  | 03-08350<br>C71-6004                                      |     | ...   | ...   | -10 | 85343 ...   |
|         |  |   |     | ...   | ...   | -10 | 85343 ...   |
| 87 - 08 | Models with Chalmers 40,000 lb Rear Suspension   | 665174<br>800670  |     | ...   | ...   | 010 | 85060 ...   |
|         |  |   |     | ...   | ...   | 010 | 85060 ...   |
| 02 - 08 | Models with Hendrickson HMX 400/460 Haulmax with 16.5" Saddle                                    | 60680-004<br>60680-004L                                   |     | ...   | ...   | 01- | 83143 ...   |
|         |  |   |     | ...   | ...   | 01- | 83143 ...   |
| 02 - 08 | Models with Hendrickson HMX 400/460 Haulmax with 17.5" & 18.5" Saddle                            | 60680-005<br>60680-005L                                   |     | ...   | ...   | 01- | 83142 ...   |
|         |  |   |     | ...   | ...   | 01- | 83142 ...   |
| 87 - 08 | Models with Neway ARD 125/244-8 Models Rear Air Suspension                                       | 90044011  |     | ...   | ...   | 010 | 85004 ...   |
| 02 - 08 | Models with Peterbilt Low Air Leaf Suspension  | 03-08781<br>C71-1017                                      |     | ...   | ...   | -1- | 85069 89455 |
|         |  |   |     | ...   | ...   | -1- | 85069 89455 |
| 87 - 01 | Models with Peterbilt Low Air Leaf Suspension  | 03-07423<br>665633  |     | ...   | ...   | -10 | 85033 89427 |
|         |  |   |     | ...   | ...   | -10 | 85033 89427 |

#### 359 Series

|         |  |          |     |       |       |     |     |
|---------|--|----------|-----|-------|-------|-----|-----|
| 81 - 87 | 359 Conventional Models with 12000 lb capacity | 02-00376 | 010 | 85302 | 89420 | ... | ... |
|---------|--|----------|-----|-------|-------|-----|-----|

**APPLICATION GUIDE - TRUCKS, TRAILERS, AND BUSES**

| Year<br>Año<br>Année | Model<br>Modelo<br>Modèle | OEM # | Front   |   | Rear  |   |
|----------------------|---------------------------|-------|---|---|---|---|
|                      |                           |       |  |  |  |  |
|                      |                           |       | Fleetline   | GasSLX  | Fleetline   | GasSLX  |

**PETERBILT(Cont'd.)**

**359 Series(Cont'd.)**

|         |  |                      |     |       |       |     |       |       |
|---------|--|----------------------|-----|-------|-------|-----|-------|-------|
| 81 - 87 | 359 Conventional Models with 12000 lb capacity | 02-00495<br>02-02736 | 010 | 85302 | 89420 |     | ...   | ...   |
|         |  |                      | 010 | 85302 | 89420 |     | ...   | ...   |
| 81 - 87 | Models with Peterbilt Air Leaf Suspension      | 03-07421             |     | ...   | ...   | -10 | 85311 | 89424 |









**362 Series**

|         |  |                                   |     |       |       |     |       |       |
|---------|--|-----------------------------------|-----|-------|-------|-----|-------|-------|
|         | C.O.E. Models with 12000 lb capacity                                   | 02-02736                          | 010 | 85302 | 89420 |     | ...   | ...   |
|         | C.O.E. Models with 14600 lb Taper Leaf Springs and Set Back Front Axle | 02-02740                          | 010 | 85036 | 89405 |     | ...   | ...   |
| 81 - 06 | C.O.E. Models with Progressive Springs                                 | 02-02738<br>B71-6016<br>B71-6016A | 010 | 85012 | 89413 |     | ...   | ...   |
|         |  |                                   | 010 | 85012 | 89413 |     | ...   | ...   |
|         |  |                                   | 010 | 85012 | 89413 |     | ...   | ...   |
| 81 - 06 | C.O.E. Models without Set Back Front Axle                              | 02-00376<br>02-00495              | 010 | 85302 | 89420 |     | ...   | ...   |
|         |  |                                   | 010 | 85302 | 89420 |     | ...   | ...   |
| 81 - 06 | Models with Air Trac Suspension  | 03-07421                          |     | ...   | ...   | -10 | 85311 | 89424 |
| - 11/82 | Models with Air Trac Suspension (38000 or 40000 lb)                    | 03-04176                          |     | ...   | ...   | 010 | 85308 | 89422 |
| 81 - 06 | Models with Chalmers 40,000 lb Rear Suspension                         | 665174<br>800670                  |     | ...   | ...   | 010 | 85060 | ...   |
|         |  |                                   |     | ...   | ...   | 010 | 85060 | ...   |
| 81 - 06 | Models with Neway ARD 125/244-8 Models Rear Air Suspension             | 90044011                          |     | ...   | ...   | 010 | 85004 | ...   |
| 02 - 06 | Models with Peterbilt Low Air Leaf Suspension                          | 03-08781<br>C71-1017              |     | ...   | ...   | -1- | 85069 | 89455 |
|         |  |                                   |     | ...   | ...   | -1- | 85069 | 89455 |
| 81 - 01 | Models with Peterbilt Low Air Leaf Suspension                          | 03-07423<br>665633                |     | ...   | ...   | -10 | 85033 | 89427 |
|         |  |                                   |     | ...   | ...   | -10 | 85033 | 89427 |

**365 Series**

|         |  |  |     |       |       |     |       |       |
|---------|--|--|-----|-------|-------|-----|-------|-------|
| 08 - 18 | Models with 12,000 lb to 14,600 lb Taperleaf Spring Suspension and Set Forward Front Axle.       | B71-6007                                     | 010 | 85062 | 89408 |     | ...   | ...   |
| 08 - 15 | Models with 12,000 lb to 16,000 lb Taperleaf Front Suspension (Set-Back Axle)                    | B71-6002<br>B71-6013                         | 010 | 85012 | 89413 |     | ...   | ...   |
|         |  |  | 010 | 85012 | 89413 |     | ...   | ...   |
| 08 - 18 | Models with 18,000 lb to 23,000 lb Taperleaf Front Spring Suspension and Set Forward Front Axle. | 02-02742<br>B71-6011                         | 010 | 85062 | 89408 |     | ...   | ...   |
|         |  |  | 010 | 85062 | 89408 |     | ...   | ...   |
| 08 - 13 | Models with Air Trac Suspension  | 03-07421                                     |     | ...   | ...   | -10 | 85311 | 89424 |
| 14 - 19 | Models with Air Trac Suspension (40,000 lb)  | C71-6003                                     |     | ...   | ...   | -10 | 85988 | ...   |
| 14 - 19 | Models with Air Trac Suspension (46,000 lb)  | C71-6002                                     |     | ...   | ...   | -10 | 85311 | 89424 |
| 08 - 19 | Models with Chalmers 40,000 lb Rear Suspension   | 665174<br>800670                             |     | ...   | ...   | 010 | 85060 | ...   |
|         |  |  |     | ...   | ...   | 010 | 85060 | ...   |
| 08 - 19 | Models with FlexAir Suspension (38000 lb)  | C71-1002<br>C71-1016<br>C71-6000<br>C71-6015 |     | ...   | ...   | 010 | 85067 | 89451 |
|         |  |  |     | ...   | ...   | 010 | 85067 | 89451 |
|         |  |  |     | ...   | ...   | 010 | 85067 | 89451 |
|         |  |  |     | ...   | ...   | 010 | 85067 | 89451 |
| 08 - 19 | Models with Hendrickson HMX 400/460 Haulmax with 16.5" Saddle                                    | 60680-004<br>60680-004L                      |     | ...   | ...   | 01- | 83143 | ...   |
|         |  |  |     | ...   | ...   | 01- | 83143 | ...   |
| 08 - 19 | Models with Hendrickson HMX 400/460 Haulmax with 17.5" & 18.5" Saddle                            | 60680-005<br>60680-005L                      |     | ...   | ...   | 01- | 83142 | ...   |
|         |  |  |     | ...   | ...   | 01- | 83142 | ...   |
| - 2019  | Models with Neway ADZ Rear Suspension  | 471700004423<br>90045605                     |     | ...   | ...   | 010 | 85109 | ...   |
|         |  |  |     | ...   | ...   | 010 | 85109 | ...   |
| 08 - 19 | Models with Peterbilt Low Air Leaf Suspension  | 03-08781<br>C71-1011<br>C71-1017<br>C71-6005 |     | ...   | ...   | -1- | 85069 | 89455 |
|         |  |  |     | ...   | ...   | -1- | 85069 | 89455 |
|         |  |  |     | ...   | ...   | -1- | 85069 | 89455 |
|         |  |  |     | ...   | ...   | -1- | 85069 | 89455 |
| 08 - 12 | Models with Quadraflex 4 Spring Rear Suspension  | 03-07420                                     |     | ...   | ...   | -1- | 85336 | ...   |
| 10 - 19 | Models with Reyco 102AR (Standard) Rear Air Suspension   | 12887-01<br>12887-02                         |     | ...   | ...   | 010 | 85013 | 89414 |
|         |  |  |     | ...   | ...   | 010 | 85013 | 89414 |
| 10 - 19 | Models with Reyco 79KB Rear Steel Spring Suspension  | 16725-01<br>19495-01                         |     | ...   | ...   | 010 | 83126 | ...   |
|         |  |  |     | ...   | ...   | 010 | 83126 | ...   |

## APPLICATION GUIDE - TRUCKS, TRAILERS, AND BUSES

| Year<br>Año<br>Année | Model<br>Modelo<br>Modèle | OEM # | Front  |  | Rear  |   |
|----------------------|---------------------------|-------|--|--|---|---|
|                      |                           |       |  |  |  |  |
|                      |                           |       |   |   |  |  |
|                      |                           |       | Fleetline  | GasSLX   | Fleetline   | GasSLX  |

### PETERBILT(Cont'd.)

#### 367 Series(Cont'd.)

|         |  |              |     |              |              |     |              |              |
|---------|--|--------------|-----|--------------|--------------|-----|--------------|--------------|
| 08 - 16 | Models with 10,000 lb to 16,000 lb Taperleaf Front Spring Suspension and with Set Back Front Axle. | B71-6002     | 010 | <b>85012</b> | <b>89413</b> |     | ...          | ...          |
|         |  |              | 010 | <b>85012</b> | <b>89413</b> |     | ...          | ...          |
| 14 - 18 | Models with 12,000 lb to 14,600 lb Taperleaf Spring Suspension and Set Forward Front Axle.         | B71-6009     | 010 | <b>85062</b> | <b>89408</b> |     | ...          | ...          |
| 08 - 18 | Models with 18,000 lb to 23,000 lb Taperleaf Front Spring Suspension and Set Forward Front Axle.   | 02-02742     | 010 | <b>85062</b> | <b>89408</b> |     | ...          | ...          |
|         |  | B71-6007     | 010 | <b>85062</b> | <b>89408</b> |     | ...          | ...          |
|         |  | B71-6011     | 010 | <b>85062</b> | <b>89408</b> |     | ...          | ...          |
| 08 - 13 | Models with Air Trac Suspension  | 03-07421     |     | ...          | ...          | -10 | <b>85311</b> | <b>89424</b> |
| 14 - 19 | Models with Air Trac Suspension (40,000 lb)  | C71-6003     |     | ...          | ...          | -10 | <b>85988</b> | ...          |
| 14 - 19 | Models with Air Trac Suspension (46,000 lb)  | C71-6002     |     | ...          | ...          | -10 | <b>85311</b> | <b>89424</b> |
|         | Models with Air Track Tri Drive Suspension   | 03-08350     |     | ...          | ...          | -10 | <b>85343</b> | ...          |
|         |  | C71-6004     |     | ...          | ...          | -10 | <b>85343</b> | ...          |
| 08 - 19 | Models with Chalmers 40,000 lb Rear Suspension   | 665174       |     | ...          | ...          | 010 | <b>85060</b> | ...          |
|         |  | 800670       |     | ...          | ...          | 010 | <b>85060</b> | ...          |
| 08 - 19 | Models with FlexAir Suspension (38000 lb)  | C71-1002     |     | ...          | ...          | 010 | <b>85067</b> | <b>89451</b> |
|         |  | C71-1016     |     | ...          | ...          | 010 | <b>85067</b> | <b>89451</b> |
|         |  | C71-6000     |     | ...          | ...          | 010 | <b>85067</b> | <b>89451</b> |
|         |  | C71-6015     |     | ...          | ...          | 010 | <b>85067</b> | <b>89451</b> |
| 08 - 19 | Models with Hendrickson HMX 400/460 Haulmax with 16.5" Saddle                                      | 60680-004    |     | ...          | ...          | 01- | <b>83143</b> | ...          |
|         |  | 60680-004L   |     | ...          | ...          | 01- | <b>83143</b> | ...          |
| 08 - 19 | Models with Hendrickson HMX 400/460 Haulmax with 17.5" & 18.5" Saddle                              | 60680-005    |     | ...          | ...          | 01- | <b>83142</b> | ...          |
|         |  | 60680-005L   |     | ...          | ...          | 01- | <b>83142</b> | ...          |
| - 2019  | Models with Neway ADZ Rear Suspension  | 471700004423 |     | ...          | ...          | 010 | <b>85109</b> | ...          |
|         |  | 90045605     |     | ...          | ...          | 010 | <b>85109</b> | ...          |
| 08 - 19 | Models with Peterbilt Low Air Leaf Suspension  | 03-08781     |     | ...          | ...          | -1- | <b>85069</b> | <b>89455</b> |
|         |  | C71-1011     |     | ...          | ...          | -1- | <b>85069</b> | <b>89455</b> |
|         |  | C71-1017     |     | ...          | ...          | -1- | <b>85069</b> | <b>89455</b> |
| 08 - 10 | Models with Quadraflex 4 Spring Rear Suspension  | 03-07420     |     | ...          | ...          | -1- | <b>85336</b> | ...          |

#### 372 Series

|         |  |           |     |              |              |     |              |              |
|---------|--|-----------|-----|--------------|--------------|-----|--------------|--------------|
| 89 - 93 | C.O.E. Models with Front Air Suspension                    | 02-02739  | 010 | <b>85013</b> | <b>89414</b> |     | ...          | ...          |
| 89 - 93 | C.O.E. Models with Front Spring Suspension                 | 02-02738  | 010 | <b>85012</b> | <b>89413</b> |     | ...          | ...          |
|         |  | B71-6016  | 010 | <b>85012</b> | <b>89413</b> |     | ...          | ...          |
|         |  | B71-6016A | 010 | <b>85012</b> | <b>89413</b> |     | ...          | ...          |
| 89 - 93 | Models with Air Trac Suspension                            | 03-07421  |     | ...          | ...          | -10 | <b>85311</b> | <b>89424</b> |
| 89 - 93 | Models with Chalmers 40,000 lb Rear Suspension             | 665174    |     | ...          | ...          | 010 | <b>85060</b> | ...          |
|         |  | 800670    |     | ...          | ...          | 010 | <b>85060</b> | ...          |
| 89 - 93 | Models with Neway ARD 125/244-8 Models Rear Air Suspension | 90044011  |     | ...          | ...          | 010 | <b>85004</b> | ...          |
| 89 - 93 | Models with Peterbilt Low Air Leaf Suspension              | 03-07423  |     | ...          | ...          | -10 | <b>85033</b> | <b>89427</b> |
|         |  | 665633    |     | ...          | ...          | -10 | <b>85033</b> | <b>89427</b> |

#### 375 Series

|         |  |           |     |              |              |  |     |     |
|---------|--|-----------|-----|--------------|--------------|--|-----|-----|
| 87 - 96 | Conventional Models with Front Air Suspension and Set Back Front Axle.                     | 02-02739  | 010 | <b>85013</b> | <b>89414</b> |  | ... | ... |
| 87 - 96 | Conventional Models with Front Air Suspension and without Set Back Front Axle.             | 02-02740  | 010 | <b>85036</b> | <b>89405</b> |  | ... | ... |
| 87 - 96 | Conventional Models with Spring Suspension and with Set Back Front Axle.                   | 02-02738  | 010 | <b>85012</b> | <b>89413</b> |  | ... | ... |
|         |  | 02-02741  | 010 | <b>85012</b> | <b>89413</b> |  | ... | ... |
|         |  | B71-6016  | 010 | <b>85012</b> | <b>89413</b> |  | ... | ... |
|         |  | B71-6016A | 010 | <b>85012</b> | <b>89413</b> |  | ... | ... |
| 87 - 96 | Models with 12,000 lb to 14,600 lb Taperleaf Spring Suspension and Set Forward Front Axle. | 02-02737  | 010 | <b>85062</b> | <b>89408</b> |  | ... | ... |
|         |  | B71-6007  | 010 | <b>85062</b> | <b>89408</b> |  | ... | ... |
|         |  | B71-6009  | 010 | <b>85062</b> | <b>89408</b> |  | ... | ... |

## APPLICATION GUIDE - TRUCKS, TRAILERS, AND BUSES

| Year<br>Año<br>Année | Model<br>Modelo<br>Modèle | OEM # | Front     |        | Rear      |        |
|----------------------|---------------------------|-------|-----------|--------|-----------|--------|
|                      |                           |       |           |        |           |        |
|                      |                           |       | Fleetline | GasSLX | Fleetline | GasSLX |

### PETERBILT(Cont'd.)

#### 375 Series(Cont'd.)

|         |  |          |     |       |       |     |       |       |
|---------|--|----------|-----|-------|-------|-----|-------|-------|
| 87 - 96 | Models with 18,000 lb to 23,000 lb Taperleaf Front Spring Suspension and Set Forward Front Axle. | 02-02742 | ○ ○ | 85062 | 89408 |     | ...   | ...   |
|         |  | B71-6011 | ○ ○ | 85062 | 89408 |     | ...   | ...   |
| 87 - 96 | Models with Air Trac Suspension  | 03-07421 |     | ...   | ...   | - ○ | 85311 | 89424 |
| 87 - 96 | Models with Chalmers 40,000 lb Rear Suspension   | 665174   |     | ...   | ...   | ○ ○ | 85060 | ...   |
|         |  | 800670   |     | ...   | ...   | ○ ○ | 85060 | ...   |
| 87 - 96 | Models with Neway ARD 125/244-8 Models Rear Air Suspension                                       | 90044011 |     | ...   | ...   | ○ ○ | 85004 | ...   |
| 87 - 96 | Models with Peterbilt Low Air Leaf Suspension  | 03-07423 |     | ...   | ...   | - ○ | 85033 | 89427 |
|         |  | 665633   |     | ...   | ...   | - ○ | 85033 | 89427 |

#### 376 Series

|         |  |           |     |       |       |     |       |       |
|---------|--|-----------|-----|-------|-------|-----|-------|-------|
| 88 - 03 | Conventional Models with Front Air Suspension and Set Back Front Axle.                           | 02-02739  | ○ ○ | 85013 | 89414 |     | ...   | ...   |
| 88 - 03 | Conventional Models with Front Air Suspension and without Set Back Front Axle.                   | 02-02740  | ○ ○ | 85036 | 89405 |     | ...   | ...   |
| 88 - 03 | Conventional Models with Spring Suspension and with Set Back Front Axle.                         | 02-02738  | ○ ○ | 85012 | 89413 |     | ...   | ...   |
|         |  | 02-02741  | ○ ○ | 85012 | 89413 |     | ...   | ...   |
|         |  | B71-6016  | ○ ○ | 85012 | 89413 |     | ...   | ...   |
|         |  | B71-6016A | ○ ○ | 85012 | 89413 |     | ...   | ...   |
| 88 - 03 | Models with 12,000 lb to 14,600 lb Taperleaf Spring Suspension and Set Forward Front Axle.       | 02-02737  | ○ ○ | 85062 | 89408 |     | ...   | ...   |
|         |  | B71-6007  | ○ ○ | 85062 | 89408 |     | ...   | ...   |
|         |  | B71-6009  | ○ ○ | 85062 | 89408 |     | ...   | ...   |
| 88 - 03 | Models with 18,000 lb to 23,000 lb Taperleaf Front Spring Suspension and Set Forward Front Axle. | 02-02742  | ○ ○ | 85062 | 89408 |     | ...   | ...   |
|         |  | B71-6011  | ○ ○ | 85062 | 89408 |     | ...   | ...   |
| 88 - 03 | Models with Air Trac Suspension  | 03-07421  |     | ...   | ...   | - ○ | 85311 | 89424 |
| 88 - 03 | Models with Chalmers 40,000 lb Rear Suspension   | 665174    |     | ...   | ...   | ○ ○ | 85060 | ...   |
|         |  | 800670    |     | ...   | ...   | ○ ○ | 85060 | ...   |
| 88 - 03 | Models with Neway ARD 125/244-8 Models Rear Air Suspension                                       | 90044011  |     | ...   | ...   | ○ ○ | 85004 | ...   |
| 88 - 03 | Models with Peterbilt Low Air Leaf Suspension  | 03-07423  |     | ...   | ...   | - ○ | 85033 | 89427 |
|         |  | 665633    |     | ...   | ...   | - ○ | 85033 | 89427 |

#### 377 Series

|         |  |          |     |       |       |     |       |       |
|---------|--|----------|-----|-------|-------|-----|-------|-------|
| 87 - 01 | Conventional Models with Front Air Suspension and Set Back Front Axle.                           | 02-02739 | ○ ○ | 85013 | 89414 |     | ...   | ...   |
| 87 - 01 | Conventional Models with Front Air Suspension and without Set Back Front Axle.                   | 02-02740 | ○ ○ | 85036 | 89405 |     | ...   | ...   |
| 87 - 01 | Conventional Models with Spring Suspension and with Set Back Front Axle.                         | 02-02738 | ○ ○ | 85012 | 89413 |     | ...   | ...   |
|         |  | 02-02741 | ○ ○ | 85012 | 89413 |     | ...   | ...   |
| 87 - 01 | Models with 12,000 lb to 14,600 lb Taperleaf Spring Suspension and Set Forward Front Axle.       | 02-02737 | ○ ○ | 85062 | 89408 |     | ...   | ...   |
|         |  | B71-6007 | ○ ○ | 85062 | 89408 |     | ...   | ...   |
|         |  | B71-6009 | ○ ○ | 85062 | 89408 |     | ...   | ...   |
| 87 - 01 | Models with 18,000 lb to 23,000 lb Taperleaf Front Spring Suspension and Set Forward Front Axle. | 02-02742 | ○ ○ | 85062 | 89408 |     | ...   | ...   |
| 87 - 01 | Models with 18,000 lb to 23,000 lb Taperleaf Spring Suspension and Set Forward Axles             | B71-6011 | ○ ○ | 85062 | 89408 |     | ...   | ...   |
| 87 - 01 | Models with Air Trac Suspension  | 03-07421 |     | ...   | ...   | - ○ | 85311 | 89424 |
| 87 - 01 | Models with Chalmers 40,000 lb Rear Suspension   | 665174   |     | ...   | ...   | ○ ○ | 85060 | ...   |
|         |  | 800670   |     | ...   | ...   | ○ ○ | 85060 | ...   |
| 87 - 01 | Models with Neway ARD 125/244-8 Models Rear Air Suspension                                       | 90044011 |     | ...   | ...   | ○ ○ | 85004 | ...   |
| 87 - 01 | Models with Peterbilt Low Air Leaf Suspension  | 03-07423 |     | ...   | ...   | - ○ | 85033 | 89427 |
|         |  | 665633   |     | ...   | ...   | - ○ | 85033 | 89427 |

#### 378 Series

|  |  |          |     |       |       |  |     |     |
|--|--|----------|-----|-------|-------|--|-----|-----|
|  | Conventional Models with Front Air Suspension and Set Back Front Axle. | 02-02739 | ○ ○ | 85013 | 89414 |  | ... | ... |
|--|--|----------|-----|-------|-------|--|-----|-----|

## APPLICATION GUIDE - TRUCKS, TRAILERS, AND BUSES

| Year<br>Año<br>Année | Model<br>Modelo<br>Modèle | OEM # | Front         |            | Rear          |            |
|----------------------|---------------------------|-------|---------------|------------|---------------|------------|
|                      |                           |       | <br>Fleetline | <br>GasSLX | <br>Fleetline | <br>GasSLX |

### PETERBILT(Cont'd.)





#### 378 Series(Cont'd.)

|                |  |           |     |              |              |     |              |              |
|----------------|--|-----------|-----|--------------|--------------|-----|--------------|--------------|
|                | Conventional Models with Front Air Suspension and without Set Back Front Axle.                   | 02-02740  | 010 | <b>85036</b> | <b>89405</b> |     | ...          | ...          |
| <b>88 - 07</b> | Conventional Models with Spring Suspension and with Set Back Front Axle.                         | 02-02738  | 010 | <b>85012</b> | <b>89413</b> |     | ...          | ...          |
|                |  | 02-02741  | 010 | <b>85012</b> | <b>89413</b> |     | ...          | ...          |
|                |  | B71-6016  | 010 | <b>85012</b> | <b>89413</b> |     | ...          | ...          |
|                |  | B71-6016A | 010 | <b>85012</b> | <b>89413</b> |     | ...          | ...          |
| <b>88 - 07</b> | Models with 12,000 lb to 14,600 lb Taperleaf Spring Suspension and Set Forward Front Axle.       | 02-02737  | 010 | <b>85062</b> | <b>89408</b> |     | ...          | ...          |
|                |  | B71-6007  | 010 | <b>85062</b> | <b>89408</b> |     | ...          | ...          |
|                |  | B71-6009  | 010 | <b>85062</b> | <b>89408</b> |     | ...          | ...          |
| <b>88 - 07</b> | Models with 18,000 lb to 23,000 lb Taperleaf Front Spring Suspension and Set Forward Front Axle. | 02-02742  | 010 | <b>85062</b> | <b>89408</b> |     | ...          | ...          |
|                |  | B71-6011  | 010 | <b>85062</b> | <b>89408</b> |     | ...          | ...          |
| <b>88 - 07</b> | Models with Air Trac Suspension  | 03-07421  |     | ...          | ...          | -10 | <b>85311</b> | <b>89424</b> |
| <b>88 - 07</b> | Models with Chalmers 40,000 lb Rear Suspension   | 665174    |     | ...          | ...          | 010 | <b>85060</b> | ...          |
|                |  | 800670    |     | ...          | ...          | 010 | <b>85060</b> | ...          |
| <b>99 - 07</b> | Models with FlexAir Suspension (38000 lb)  | C71-1002  |     | ...          | ...          | 010 | <b>85067</b> | <b>89451</b> |
|                |  | C71-6000  |     | ...          | ...          | 010 | <b>85067</b> | <b>89451</b> |
| <b>88 - 07</b> | Models with Neway ARD 125/244-8 Models Rear Air Suspension                                       | 90044011  |     | ...          | ...          | 010 | <b>85004</b> | ...          |
| <b>- 2003</b>  | Models with Peterbilt Low Air Leaf Suspension  | 03-07423  |     | ...          | ...          | -10 | <b>85033</b> | <b>89427</b> |
|                |  | 665633    |     | ...          | ...          | -10 | <b>85033</b> | <b>89427</b> |
| <b>03 - 07</b> | Models with Peterbilt Low Air Leaf Suspension  | 03-08781  |     | ...          | ...          | -1- | <b>85069</b> | <b>89455</b> |
|                |  | C71-1017  |     | ...          | ...          | -1- | <b>85069</b> | <b>89455</b> |

#### 379 Series

|                |  |             |     |              |              |     |              |              |
|----------------|--|-------------|-----|--------------|--------------|-----|--------------|--------------|
|                | Conventional Models with Front Air Suspension and Set Back Front Axle.                           | 02-02739    | 010 | <b>85013</b> | <b>89414</b> |     | ...          | ...          |
|                | Conventional Models with Front Air Suspension and without Set Back Front Axle.                   | 02-02740    | 010 | <b>85036</b> | <b>89405</b> |     | ...          | ...          |
| <b>85 - 09</b> | Conventional Models with Spring Suspension and with Set Back Front Axle.                         | 02-01890    | 010 | <b>85012</b> | <b>89413</b> |     | ...          | ...          |
|                |  | 02-02738    | 010 | <b>85012</b> | <b>89413</b> |     | ...          | ...          |
|                |  | 02-02741    | 010 | <b>85012</b> | <b>89413</b> |     | ...          | ...          |
|                |  | B71-6016    | 010 | <b>85012</b> | <b>89413</b> |     | ...          | ...          |
|                |  | B71-6016A   | 010 | <b>85012</b> | <b>89413</b> |     | ...          | ...          |
| <b>85 - 09</b> | Models with 12,000 lb to 14,600 lb Taperleaf Spring Suspension and Set Forward Front Axle.       | 02-01787    | 010 | <b>85062</b> | <b>89408</b> |     | ...          | ...          |
|                |  | 02-02737    | 010 | <b>85062</b> | <b>89408</b> |     | ...          | ...          |
|                |  | B71-6007    | 010 | <b>85062</b> | <b>89408</b> |     | ...          | ...          |
|                |  | B71-6009    | 010 | <b>85062</b> | <b>89408</b> |     | ...          | ...          |
| <b>85 - 09</b> | Models with 18,000 lb to 23,000 lb Taperleaf Front Spring Suspension and Set Forward Front Axle. | 02-02742    | 010 | <b>85062</b> | <b>89408</b> |     | ...          | ...          |
|                |  | B71-6011    | 010 | <b>85062</b> | <b>89408</b> |     | ...          | ...          |
| <b>85 - 09</b> | Models with Air Trac Suspension  | 03-07421    |     | ...          | ...          | -10 | <b>85311</b> | <b>89424</b> |
|                |  | 03-07421SPL |     | ...          | ...          | -10 | <b>85311</b> | <b>89424</b> |
| <b>85 - 09</b> | Models with Chalmers 40,000 lb Rear Suspension   | 665174      |     | ...          | ...          | 010 | <b>85060</b> | ...          |
|                |  | 800670      |     | ...          | ...          | 010 | <b>85060</b> | ...          |
| <b>99 - 09</b> | Models with FlexAir Suspension (38000 lb)  | C71-1002    |     | ...          | ...          | 010 | <b>85067</b> | <b>89451</b> |
|                |  | C71-6000    |     | ...          | ...          | 010 | <b>85067</b> | <b>89451</b> |
|                | Models with Neway ARD 125/244-8 Models Rear Air Suspension                                       | 90044011    |     | ...          | ...          | 010 | <b>85004</b> | ...          |
| <b>03 - 09</b> | Models with Peterbilt Low Air Leaf Suspension  | 03-08781    |     | ...          | ...          | -1- | <b>85069</b> | <b>89455</b> |
|                |  | C71-1011    |     | ...          | ...          | -1- | <b>85069</b> | <b>89455</b> |
|                |  | C71-1017    |     | ...          | ...          | -1- | <b>85069</b> | <b>89455</b> |
| <b>85 - 02</b> | Models with Peterbilt Low Air Leaf Suspension  | 03-07423    |     | ...          | ...          | -10 | <b>85033</b> | <b>89427</b> |
|                |  | 665633      |     | ...          | ...          | -10 | <b>85033</b> | <b>89427</b> |

**APPLICATION GUIDE - TRUCKS, TRAILERS, AND BUSES**

| Year<br>Año<br>Année | Model<br>Modelo<br>Modèle | OEM # | Front   |   | Rear  |   |
|----------------------|---------------------------|-------|---|---|---|---|
|                      |                           |       |  |  |  |  |
|                      |                           |       | Fleetline   | GasSLX  | Fleetline   | GasSLX  |

**PETERBILT(Cont'd.)**

**382 Series(Cont'd.)**

|         |  |          |     |       |       |     |       |       |
|---------|--|----------|-----|-------|-------|-----|-------|-------|
| 2011 -  | Models with 10,000 lb to 12,000 lb Front Axle  | B71-6005 | 010 | 85084 | 89460 |     | ...   | ...   |
| 2011 -  | Models with 12,000 lb to 14,600 lb Taperleaf Spring Suspension and Set Forward Front Axle. | 02-02737 | 010 | 85062 | 89408 |     | ...   | ...   |
|         |  | B71-6009 | 010 | 85062 | 89408 |     | ...   | ...   |
| 11 - 13 | Models with Air Trac Suspension  | 03-07421 |     | ...   | ...   | -10 | 85311 | 89424 |
| 14 - 17 | Models with Air Trac Suspension (46,000 lb)  | C71-6002 |     | ...   | ...   | -10 | 85311 | 89424 |
| 11 - 17 | Models with FlexAir Suspension (38000 lb)  | C71-1002 |     | ...   | ...   | 010 | 85067 | 89451 |
|         |  | C71-1016 |     | ...   | ...   | 010 | 85067 | 89451 |
|         |  | C71-6000 |     | ...   | ...   | 010 | 85067 | 89451 |
|         |  | C71-6015 |     | ...   | ...   | 010 | 85067 | 89451 |
| 11 - 17 | Models with Peterbilt Low Air Leaf Suspension  | 03-08781 |     | ...   | ...   | -1- | 85069 | 89455 |
|         |  | C71-1011 |     | ...   | ...   | -1- | 85069 | 89455 |
|         |  | C71-1017 |     | ...   | ...   | -1- | 85069 | 89455 |
| 11 - 17 | Models with Quadraflex 4 Spring Rear Suspension  | 03-07420 |     | ...   | ...   | -1- | 85336 | ...   |
| 11 - 17 | Models with Reyco 102AR (Standard) Rear Air Suspension                                     | 12887-01 |     | ...   | ...   | 010 | 85013 | 89414 |
|         |  | 12887-02 |     | ...   | ...   | 010 | 85013 | 89414 |
| 11 - 17 | Models with Reyco 79KB Rear Steel Spring Suspension  | 16725-01 |     | ...   | ...   | 010 | 83126 | ...   |
|         |  | 19495-01 |     | ...   | ...   | 010 | 83126 | ...   |

**384 Series**





|         |  |          |     |       |       |     |       |       |
|---------|--|----------|-----|-------|-------|-----|-------|-------|
| 08 - 12 | Models with 12,000 lb to 14,600 lb Taperleaf Spring Suspension and Set Forward Front Axle.                               | 02-02737 | 010 | 85062 | 89408 |     | ...   | ...   |
| 13 - 14 | Models with 12,000 lb to 14,600 lb Taperleaf Spring Suspension and Set Forward Front Axle.<br>(Std Duty)<br>(Heavy Duty) | B71-6009 | 010 | 83219 | 89408 |     | ...   | ...   |
|         |  | B71-6009 | 010 | 85062 | 89408 |     | ...   | ...   |
|         |  |          |     |       |       |     |       |       |
| 08 - 13 | Models with Air Trac Suspension  | 03-07421 |     | ...   | ...   | -10 | 85311 | 89424 |
| 14 - 16 | Models with Air Trac Suspension (46,000 lb)  | C71-6002 |     | ...   | ...   | -10 | 85311 | 89424 |
| 08 - 16 | Models with FlexAir Suspension (38000 lb)  | C71-1002 |     | ...   | ...   | 010 | 85067 | 89451 |
|         |  | C71-1016 |     | ...   | ...   | 010 | 85067 | 89451 |
|         |  | C71-6000 |     | ...   | ...   | 010 | 85067 | 89451 |
|         |  | C71-6015 |     | ...   | ...   | 010 | 85067 | 89451 |
| 08 - 16 | Models with Peterbilt Low Air Leaf Suspension  | 03-08781 |     | ...   | ...   | -1- | 85069 | 89455 |
|         |  | C71-1011 |     | ...   | ...   | -1- | 85069 | 89455 |
|         |  | C71-1017 |     | ...   | ...   | -1- | 85069 | 89455 |
| 2008 -  | Models with Quadraflex 4 Spring Rear Suspension  | 03-07420 |     | ...   | ...   | -1- | 85336 | ...   |

**385 Series**

|         |  |                  |     |       |       |     |       |       |
|---------|--|------------------|-----|-------|-------|-----|-------|-------|
| - 2007  | Conventional Models with Spring Suspension and with Set Back Front Axle.                         | 02-02738         | 010 | 85012 | 89413 |     | ...   | ...   |
|         |  | 02-02741         | 010 | 85012 | 89413 |     | ...   | ...   |
|         |  | B71-6016         | 010 | 85012 | 89413 |     | ...   | ...   |
|         |  | B71-6016A        | 010 | 85012 | 89413 |     | ...   | ...   |
| - 2007  | Models with 12,000 lb to 14,600 lb Taperleaf Spring Suspension and Set Forward Front Axle.       | 02-02737         | 010 | 85062 | 89408 |     | ...   | ...   |
|         |  | B71-6007         | 010 | 85062 | 89408 |     | ...   | ...   |
|         |  | B71-6009         | 010 | 85062 | 89408 |     | ...   | ...   |
| - 2007  | Models with 18,000 lb to 23,000 lb Taperleaf Front Spring Suspension and Set Forward Front Axle. | 02-02742         | 010 | 85062 | 89408 |     | ...   | ...   |
|         |  | B71-6011         | 010 | 85062 | 89408 |     | ...   | ...   |
| 95 - 08 | Models with Air Trac Suspension  | 03-07421         |     | ...   | ...   | -10 | 85311 | 89424 |
|         | Models with Chalmers 40,000 lb Rear Suspension   | 665174<br>800670 |     | ...   | ...   | 010 | 85060 | ...   |
| 95 - 08 | Models with FlexAir Suspension (38000 lb)  | C71-1002         |     | ...   | ...   | 010 | 85067 | 89451 |
|         |  | C71-6000         |     | ...   | ...   | 010 | 85067 | 89451 |
|         | Models with Neway ARD 125/244-8 Models Rear Air Suspension                                       | 90044011         |     | ...   | ...   | 010 | 85004 | ...   |
| - 2003  | Models with Peterbilt Low Air Leaf Suspension  | 03-07423         |     | ...   | ...   | -10 | 85033 | 89427 |
|         |  | 665633           |     | ...   | ...   | -10 | 85033 | 89427 |



**APPLICATION GUIDE - TRUCKS, TRAILERS, AND BUSES**

| Year<br>Año<br>Année | Model<br>Modelo<br>Modèle | OEM # | Front  |  | Rear  |   |
|----------------------|---------------------------|-------|--|--|---|---|
|                      |                           |       |  |  |  |  |
|                      |                           |       | Fleetline  | GasSLX   | Fleetline   | GasSLX  |

**PETERBILT(Cont'd.)**

**385 Series(Cont'd.)**

|         |   |          |  |     |     |     |       |       |
|---------|---|----------|--|-----|-----|-----|-------|-------|
| 04 - 07 | Models with Peterbilt Low Air Leaf Suspension   | 03-08781 |  | ... | ... | - - | 85069 | 89455 |
|         |   | C71-1017 |  | ... | ... | - - | 85069 | 89455 |
|         | Models with Quadraflex 4 Spring Rear Suspension | 03-07420 |  | ... | ... | - - | 85336 | ...   |

**386 Series**





|         |  |           |     |       |       |     |       |       |
|---------|--|-----------|-----|-------|-------|-----|-------|-------|
| 2006 -  | Conventional Models with Front Air Suspension and Set Back Front Axle.                           | 02-02739  | 0 0 | 85013 | 89414 |     | ...   | ...   |
| 2006 -  | Conventional Models with Front Air Suspension and without Set Back Front Axle.                   | 02-02740  | 0 0 | 85036 | 89405 |     | ...   | ...   |
| 13 - 14 | Conventional Models with Spring Suspension and with Set Back Front Axle.                         | B71-6016  | 0 0 | 85012 | 89413 |     | ...   | ...   |
|         |  | B71-6016A | 0 0 | 85012 | 89413 |     | ...   | ...   |
| 2006 -  | Conventional Models with Spring Suspension and with Set Back Front Axle.                         | 02-02738  | 0 0 | 85012 | 89413 |     | ...   | ...   |
|         |  | 02-02741  | 0 0 | 85012 | 89413 |     | ...   | ...   |
|         |  | 02-04010  | 0 0 | 85012 | 89413 |     | ...   | ...   |
|         |  | B71-6018  | 0 0 | 85012 | 89413 |     | ...   | ...   |
| 06 - 12 | Models with 12,000 lb to 14,600 lb Taperleaf Spring Suspension and Set Forward Front Axle.       | 02-02737  | 0 0 | 85062 | 89408 |     | ...   | ...   |
|         |  | B71-6009  | 0 0 | 85062 | 89408 |     | ...   | ...   |
| 2006 -  | Models with 12,000 lb to 14,600 lb Taperleaf Spring Suspension and Set Forward Front Axle.       | B71-6007  | 0 0 | 85062 | 89408 |     | ...   | ...   |
| 2006 -  | Models with 18,000 lb to 23,000 lb Taperleaf Front Spring Suspension and Set Forward Front Axle. | 02-02742  | 0 0 | 85062 | 89408 |     | ...   | ...   |
|         |  | B71-6011  | 0 0 | 85062 | 89408 |     | ...   | ...   |
| 06 - 16 | Models with FlexAir Suspension (38000 lb)  | C71-1002  |     | ...   | ...   | 0 0 | 85067 | 89451 |
|         |  | C71-1016  |     | ...   | ...   | 0 0 | 85067 | 89451 |
|         |  | C71-6000  |     | ...   | ...   | 0 0 | 85067 | 89451 |
|         |  | C71-6015  |     | ...   | ...   | 0 0 | 85067 | 89451 |
| 06 - 16 | Models with Peterbilt Air Leaf Suspension  | 03-07421  |     | ...   | ...   | - 0 | 85311 | 89424 |
|         |  | C71-6002  |     | ...   | ...   | - 0 | 85311 | 89424 |
| 06 - 16 | Models with Peterbilt Low Air Leaf Suspension  | 03-08781  |     | ...   | ...   | - - | 85069 | 89455 |
|         |  | C71-1011  |     | ...   | ...   | - - | 85069 | 89455 |
|         |  | C71-1017  |     | ...   | ...   | - - | 85069 | 89455 |

**387 Series**

|         |  |           |     |       |       |     |       |       |
|---------|--|-----------|-----|-------|-------|-----|-------|-------|
| - 2009  | Conventional Models with Front Air Suspension and Set Back Front Axle.                           | 02-02739  | 0 0 | 85013 | 89414 |     | ...   | ...   |
| - 2009  | Conventional Models with Front Air Suspension and without Set Back Front Axle.                   | 02-02740  | 0 0 | 85036 | 89405 |     | ...   | ...   |
| - 2011  | Conventional Models with Spring Suspension and with Set Back Front Axle.                         | 02-02738  | 0 0 | 85012 | 89413 |     | ...   | ...   |
|         |  | 02-02741  | 0 0 | 85012 | 89413 |     | ...   | ...   |
|         |  | 02-04010  | 0 0 | 85012 | 89413 |     | ...   | ...   |
|         |  | B71-6016  | 0 0 | 85012 | 89413 |     | ...   | ...   |
|         |  | B71-6016A | 0 0 | 85012 | 89413 |     | ...   | ...   |
| - 2011  | Models with 12,000 lb to 14,600 lb Taperleaf Spring Suspension and Set Forward Front Axle.       | 02-02737  | 0 0 | 85062 | 89408 |     | ...   | ...   |
|         |  | B71-6007  | 0 0 | 85062 | 89408 |     | ...   | ...   |
|         |  | B71-6009  | 0 0 | 85062 | 89408 |     | ...   | ...   |
| - 2011  | Models with 18,000 lb to 23,000 lb Taperleaf Front Spring Suspension and Set Forward Front Axle. | 02-02742  | 0 0 | 85062 | 89408 |     | ...   | ...   |
|         |  | B71-6011  | 0 0 | 85062 | 89408 |     | ...   | ...   |
| 00 - 11 | Models with FlexAir Suspension (38000 lb)  | C71-1002  |     | ...   | ...   | 0 0 | 85067 | 89451 |
|         |  | C71-6000  |     | ...   | ...   | 0 0 | 85067 | 89451 |
| 00 - 11 | Models with Peterbilt Air Leaf Suspension  | 03-07421  |     | ...   | ...   | - 0 | 85311 | 89424 |
| - 2003  | Models with Peterbilt Low Air Leaf Suspension  | 03-07423  |     | ...   | ...   | - 0 | 85033 | 89427 |
|         |  | 665633    |     | ...   | ...   | - 0 | 85033 | 89427 |
| 03 - 11 | Models with Peterbilt Low Air Leaf Suspension  | 03-08781  |     | ...   | ...   | - - | 85069 | 89455 |
|         |  | C71-1011  |     | ...   | ...   | - - | 85069 | 89455 |



## APPLICATION GUIDE - TRUCKS, TRAILERS, AND BUSES

| Year<br>Año<br>Année | Model<br>Modelo<br>Modèle | OEM # | Front   |   | Rear  |   |
|----------------------|---------------------------|-------|---|---|---|---|
|                      |                           |       |  |  |  |  |
|                      |                           |       | Fleetline   | GasSLX  | Fleetline   | GasSLX  |

### PETERBILT(Cont'd.)

#### 387 Series(Cont'd.)

|         |   |          |  |     |     |     |       |       |
|---------|---|----------|--|-----|-----|-----|-------|-------|
| 03 - 11 | Models with Peterbilt Low Air Leaf Suspension | C71-1017 |  | ... | ... | -1- | 85069 | 89455 |
|---------|---|----------|--|-----|-----|-----|-------|-------|





#### 388 Series

|         |  |              |     |       |       |     |       |       |
|---------|--|--------------|-----|-------|-------|-----|-------|-------|
| 08 - 16 | Conventional Models with Front Air Suspension and Set Back Front Axle.   | 02-02739     | 010 | 85013 | 89414 |     | ...   | ...   |
|         |  | 85013A0C     | 010 | 85013 | 89414 |     | ...   | ...   |
| 2008 -  | Conventional Models with Front Air Suspension and without Set Back Front Axle.   | 02-02740     | 010 | 85036 | 89405 |     | ...   | ...   |
| 2008 -  | Conventional Models with Spring Suspension and with Set Back Front Axle.   | 02-04010     | 010 | 85012 | 89413 |     | ...   | ...   |
|         |  | B71-6018     | 010 | 85012 | 89413 |     | ...   | ...   |
| 08 - 17 | Models with 12,000 lb to 14,600 lb Taperleaf Spring Suspension and Set Forward Front Axle.                               | B71-6007     | 010 | 85062 | 89408 |     | ...   | ...   |
| 13 - 17 | Models with 12,000 lb to 14,600 lb Taperleaf Spring Suspension and Set Forward Front Axle.<br>(Heavy Duty)<br>(Std Duty) | B71-6009     | 010 | 85062 | 89408 |     | ...   | ...   |
|         |  | B71-6009     | 010 | 83219 | 89408 |     | ...   | ...   |
| 08 - 17 | Models with 18,000 lb to 23,000 lb Taperleaf Front Spring Suspension and Set Forward Front Axle.                         | 02-02742     | 010 | 85062 | 89408 |     | ...   | ...   |
|         |  | B71-6011     | 010 | 85062 | 89408 |     | ...   | ...   |
| 08 - 17 | Models with Air Trac Suspension  | 03-07421     |     | ...   | ...   | -10 | 85311 | 89424 |
| 14 - 17 | Models with Air Trac Suspension (40,000 lb)  | C71-6003     |     | ...   | ...   | -10 | 85988 | ...   |
| 14 - 17 | Models with Air Trac Suspension (46,000 lb)  | C71-6002     |     | ...   | ...   | -10 | 85311 | 89424 |
| 08 - 17 | Models with FlexAir Suspension (38000 lb)  | C71-1002     |     | ...   | ...   | 010 | 85067 | 89451 |
|         |  | C71-1016     |     | ...   | ...   | 010 | 85067 | 89451 |
|         |  | C71-6000     |     | ...   | ...   | 010 | 85067 | 89451 |
|         |  | C71-6015     |     | ...   | ...   | 010 | 85067 | 89451 |
|         | Models with Hendrickson HMX 400/460 Haulmax with 16.5" Saddle  | 60680-004    |     | ...   | ...   | 01- | 83143 | ...   |
|         |  | 60680-004L   |     | ...   | ...   | 01- | 83143 | ...   |
|         | Models with Hendrickson HMX 400/460 Haulmax with 17.5" & 18.5" Saddle  | 60680-005    |     | ...   | ...   | 01- | 83142 | ...   |
|         |  | 60680-005L   |     | ...   | ...   | 01- | 83142 | ...   |
| 08 - 17 | Models with Peterbilt Air Leaf Suspension  | 03-07421     |     | ...   | ...   | -10 | 85311 | 89424 |
|         |  | 03-07421PLUS |     | ...   | ...   | -10 | 85311 | 89424 |
| 08 - 17 | Models with Peterbilt Low Air Leaf Suspension  | 03-08781     |     | ...   | ...   | -1- | 85069 | 89455 |
|         |  | C71-1011     |     | ...   | ...   | -1- | 85069 | 89455 |
|         |  | C71-1017     |     | ...   | ...   | -1- | 85069 | 89455 |

#### 389 Series

|         |  |          |     |       |       |     |       |       |
|---------|--|----------|-----|-------|-------|-----|-------|-------|
| 2008 -  | Conventional Models with Front Air Suspension and Set Back Front Axle.                           | 02-02739 | 010 | 85013 | 89414 |     | ...   | ...   |
| 2008 -  | Conventional Models with Front Air Suspension and without Set Back Front Axle.                   | 02-02740 | 010 | 85036 | 89405 |     | ...   | ...   |
| 2008 -  | Conventional Models with Spring Suspension and with Set Back Front Axle.                         | 02-04010 | 010 | 85012 | 89413 |     | ...   | ...   |
|         |  | B71-6018 | 010 | 85012 | 89413 |     | ...   | ...   |
| 08 - 19 | Models with 12,000 lb to 14,600 lb Taperleaf Spring Suspension and Set Forward Front Axle.       | 02-02737 | 010 | 85062 | 89408 |     | ...   | ...   |
|         |  | B71-6007 | 010 | 85062 | 89408 |     | ...   | ...   |
|         |  | B71-6009 | 010 | 85062 | 89408 |     | ...   | ...   |
| 08 - 19 | Models with 18,000 lb to 23,000 lb Taperleaf Front Spring Suspension and Set Forward Front Axle. | 02-02742 | 010 | 85062 | 89408 |     | ...   | ...   |
|         |  | B71-6011 | 010 | 85062 | 89408 |     | ...   | ...   |
| 14 - 19 | Models with Air Trac Suspension (40,000 lb)  | C71-6003 |     | ...   | ...   | -10 | 85988 | ...   |
| 14 - 19 | Models with Air Trac Suspension (46,000 lb)  | C71-6002 |     | ...   | ...   | -10 | 85311 | 89424 |
| 08 - 19 | Models with FlexAir Suspension (38000 lb)  | C71-1002 |     | ...   | ...   | 010 | 85067 | 89451 |
|         |  | C71-1016 |     | ...   | ...   | 010 | 85067 | 89451 |
|         |  | C71-6000 |     | ...   | ...   | 010 | 85067 | 89451 |
|         |  | C71-6015 |     | ...   | ...   | 010 | 85067 | 89451 |

**APPLICATION GUIDE - TRUCKS, TRAILERS, AND BUSES**

| Year<br>Año<br>Année | Model<br>Modelo<br>Modèle | OEM # | Front  |  | Rear  |   |
|----------------------|---------------------------|-------|--|--|---|---|
|                      |                           |       |  |  |  |  |
|                      |                           |       | Fleetline  | GasSLX   | Fleetline   | GasSLX  |

**PETERBILT(Cont'd.)**

**389 Series(Cont'd.)**

|         |   |              |     |     |     |       |       |
|---------|---|--------------|-----|-----|-----|-------|-------|
| 08 - 19 | Models with Hendrickson HMX 400/460 Haulmax with 16.5" Saddle         | 60680-004    | ... | ... | 01- | 83143 | ...   |
|         |   | 60680-004L   | ... | ... | 01- | 83143 | ...   |
| 08 - 19 | Models with Hendrickson HMX 400/460 Haulmax with 17.5" & 18.5" Saddle | 60680-005    | ... | ... | 01- | 83142 | ...   |
|         |   | 60680-005L   | ... | ... | 01- | 83142 | ...   |
| 08 - 19 | Models with Hendrickson HN - 522 Rear Suspension                      | 60680-003    | ... | ... | 01- | 83112 | ...   |
|         |   | 60680-003L   | ... | ... | 01- | 83112 | ...   |
| 14 - 19 | Models with Neway ADZ Rear Suspension                                 | 471700004423 | ... | ... | 010 | 85109 | ...   |
|         |   | 90045605     | ... | ... | 010 | 85109 | ...   |
| 08 - 13 | Models with Peterbilt Air Leaf Suspension                             | 03-07421     | ... | ... | -10 | 85311 | 89424 |
| 08 - 19 | Models with Peterbilt Low Air Leaf Suspension                         | 03-08781     | ... | ... | -1- | 85069 | 89455 |
|         |   | C71-1011     | ... | ... | -1- | 85069 | 89455 |
|         |   | C71-1017     | ... | ... | -1- | 85069 | 89455 |





**520 Series**

|         |  |              |     |       |       |       |       |
|---------|--|--------------|-----|-------|-------|-------|-------|
| 17 - 19 | Models with 18,000 lb to 23,000 lb Taperleaf Front Spring Suspension and Set Forward Front Axle. | B71-6011     | 010 | 85062 | 89408 | ...   | ...   |
| 17 - 19 | Models with Air Trac Suspension (40,000 lb)  | C71-6003     | ... | ...   | -10   | 85988 | ...   |
| 17 - 19 | Models with Air Trac Suspension (46,000 lb)  | C71-6002     | ... | ...   | -10   | 85311 | 89424 |
| 17 - 19 | Models with Hendrickson HMX 400/460 Haulmax with 16.5" Saddle                                    | 60680-004    | ... | ...   | 01-   | 83143 | ...   |
|         |  | 60680-004L   | ... | ...   | 01-   | 83143 | ...   |
| 17 - 19 | Models with Hendrickson HMX 400/460 Haulmax with 17.5" & 18.5" Saddle                            | 60680-005    | ... | ...   | 01-   | 83142 | ...   |
|         |  | 60680-005L   | ... | ...   | 01-   | 83142 | ...   |
| 17 - 19 | Models with Neway AD-252-10 Tandem Axle  | 90045132     | ... | ...   | 010   | 85909 | ...   |
| 17 - 19 | Models with Neway ADZ Rear Suspension  | 471700004423 | ... | ...   | 010   | 85109 | ...   |
|         |  | 90045605     | ... | ...   | 010   | 85109 | ...   |
| 17 - 19 | Models with Peterbilt Low Air Leaf Suspension  | C71-1011     | ... | ...   | -1-   | 85069 | 89455 |
|         |  | C71-1017     | ... | ...   | -1-   | 85069 | 89455 |
| 17 - 19 | Models with Reyco 102AR (Standard) Rear Air Suspension   | 12887-01     | ... | ...   | 010   | 85013 | 89414 |
|         |  | 12887-02     | ... | ...   | 010   | 85013 | 89414 |
| 17 - 19 | Models with Reyco 79KB Rear Steel Spring Suspension  | 16725-01     | ... | ...   | 010   | 83126 | ...   |
|         |  | 19495-01     | ... | ...   | 010   | 83126 | ...   |

**567 Series**

|         |  |              |     |       |       |       |       |
|---------|--|--------------|-----|-------|-------|-------|-------|
| 14 - 17 | Models with 10,000 lb to 14,600 lb Taperleaf Springs and Set Back Front Axles              | B71-6019     | 010 | 85989 | ...   | ...   | ...   |
| 14 - 18 | Models with 12,000 lb to 14,600 lb Taperleaf Spring Suspension and Set Forward Front Axle. | B71-6009     | 010 | 85062 | 89408 | ...   | ...   |
| 14 - 19 | Models with 18,000 lb to 23,000 lb Taperleaf Spring Suspension and Set Forward Axles       | B71-6011     | 010 | 85062 | 89408 | ...   | ...   |
| 14 - 19 | Models with 20,000 lb Taperleaf Springs and Set Back Front Axles                           | B71-6020     | 010 | 85989 | ...   | ...   | ...   |
| 14 - 19 | Models with Air Trac Suspension (40,000 lb)  | C71-6003     | ... | ...   | -10   | 85988 | ...   |
| 14 - 19 | Models with Air Trac Suspension (46,000 lb)  | C71-6002     | ... | ...   | -10   | 85311 | 89424 |
| 14 - 19 | Models with Chalmers 40,000 lb Rear Suspension   | 665174       | ... | ...   | 010   | 85060 | ...   |
|         |  | 800670       | ... | ...   | 010   | 85060 | ...   |
| 14 - 19 | Models with FlexAir Suspension (38000 lb)  | C71-1016     | ... | ...   | 010   | 85067 | 89451 |
|         |  | C71-6015     | ... | ...   | 010   | 85067 | 89451 |
| 14 - 19 | Models with Hendrickson HMX 400/460 Haulmax with 16.5" Saddle                              | 60680-004    | ... | ...   | 01-   | 83143 | ...   |
|         |  | 60680-004L   | ... | ...   | 01-   | 83143 | ...   |
| 14 - 19 | Models with Hendrickson HMX 400/460 Haulmax with 17.5" & 18.5" Saddle                      | 60680-005    | ... | ...   | 01-   | 83142 | ...   |
|         |  | 60680-005L   | ... | ...   | 01-   | 83142 | ...   |
| 14 - 19 | Models with Neway ADZ Rear Suspension  | 471700004423 | ... | ...   | 010   | 85109 | ...   |
|         |  | 90045605     | ... | ...   | 010   | 85109 | ...   |
| 14 - 19 | Models with Peterbilt Low Air Leaf Suspension  | C71-1017     | ... | ...   | -1-   | 85069 | 89455 |

## APPLICATION GUIDE - TRUCKS, TRAILERS, AND BUSES

| Year<br>Año<br>Année | Model<br>Modelo<br>Modèle | OEM # | Front   |   | Rear  |   |
|----------------------|---------------------------|-------|---|---|---|---|
|                      |                           |       |  |  |  |  |
|                      |                           |       | Fleetline   | GasSLX  | Fleetline   | GasSLX  |

### PETERBILT(Cont'd.)

#### 567 Series(Cont'd.)

|         |   |          |  |     |     |     |       |       |
|---------|---|----------|--|-----|-----|-----|-------|-------|
| 14 - 19 | Models with Peterbilt Low Air Leaf Suspension | C71-6005 |  | ... | ... | - - | 85069 | 89455 |
|---------|---|----------|--|-----|-----|-----|-------|-------|

#### 579 Series

|         |  |              |     |       |       |     |       |       |
|---------|--|--------------|-----|-------|-------|-----|-------|-------|
| 13 - 16 | Day Cab Models with 10,000 lb to 12,000 lb Front Axle                                      | B71-6005     | OIO | 85084 | 89460 |     | ...   | ...   |
| 13 - 17 | Models with 10,000 lb to 14,600 lb Taperleaf Springs and Set Back Front Axles              | B71-6019     | OIO | 85989 | ...   |     | ...   | ...   |
| 13 - 18 | Models with 12,000 lb to 14,600 lb Taperleaf Spring Suspension and Set Forward Front Axle. | 02-02737     | OIO | 85062 | 89408 |     | ...   | ...   |
|         |  | B71-6009     | OIO | 85062 | 89408 |     | ...   | ...   |
| 2013    | Models with Air Trac Suspension  | 03-07421     |     | ...   | ...   | - O | 85311 | 89424 |
| 14 - 19 | Models with Air Trac Suspension (40,000 lb)  | C71-6003     |     | ...   | ...   | - O | 85988 | ...   |
| 14 - 19 | Models with Air Trac Suspension (46,000 lb)  | C71-6002     |     | ...   | ...   | - O | 85311 | 89424 |
| 13 - 19 | Models with FlexAir Suspension (38000 lb)  | C71-1002     |     | ...   | ...   | OIO | 85067 | 89451 |
|         |  | C71-1016     |     | ...   | ...   | OIO | 85067 | 89451 |
|         |  | C71-6000     |     | ...   | ...   | OIO | 85067 | 89451 |
|         |  | C71-6015     |     | ...   | ...   | OIO | 85067 | 89451 |
| 13 - 18 | Models with Neway ADZ Rear Suspension  | 471700004423 |     | ...   | ...   | OIO | 85109 | ...   |
|         |  | 90045605     |     | ...   | ...   | OIO | 85109 | ...   |
| 2013 -  | Models with Peterbilt Front Air Leaf Suspension  | B71-6000     | OIO | 85959 | ...   |     | ...   | ...   |
| 13 - 19 | Models with Peterbilt Low Air Leaf Suspension  | 03-08781     |     | ...   | ...   | - - | 85069 | 89455 |
|         |  | C71-1011     |     | ...   | ...   | - - | 85069 | 89455 |
|         |  | C71-1017     |     | ...   | ...   | - - | 85069 | 89455 |
|         |  | C71-6005     |     | ...   | ...   | - - | 85069 | 89455 |
| 13 - 19 | Models with Reyco 102AR (Standard) Rear Air Suspension                                     | 12887-01     |     | ...   | ...   | OIO | 85013 | 89414 |
|         |  | 12887-02     |     | ...   | ...   | OIO | 85013 | 89414 |
| 13 - 19 | Models with Reyco 79KB Rear Steel Spring Suspension  | 16725-01     |     | ...   | ...   | OIO | 83126 | ...   |
|         |  | 19495-01     |     | ...   | ...   | OIO | 83126 | ...   |

#### 587 Series

|         |  |          |     |       |       |     |       |       |
|---------|--|----------|-----|-------|-------|-----|-------|-------|
| 11 - 16 | Models with 12,000 lb to 14,600 lb Taperleaf Spring Suspension and Set Forward Front Axle. | 02-02737 | OIO | 85062 | 89408 |     | ...   | ...   |
|         |  | B71-6009 | OIO | 85062 | 89408 |     | ...   | ...   |
| 11 - 13 | Models with Air Trac Suspension  | 03-07421 |     | ...   | ...   | - O | 85311 | 89424 |
| 14 - 18 | Models with Air Trac Suspension (46,000 lb)  | C71-6002 |     | ...   | ...   | - O | 85311 | 89424 |
| 11 - 18 | Models with FlexAir Suspension (38000 lb)  | C71-1002 |     | ...   | ...   | OIO | 85067 | 89451 |
|         |  | C71-1016 |     | ...   | ...   | OIO | 85067 | 89451 |
|         |  | C71-6000 |     | ...   | ...   | OIO | 85067 | 89451 |
|         |  | C71-6015 |     | ...   | ...   | OIO | 85067 | 89451 |
| 11 - 13 | Models with Peterbilt Front Air Leaf Suspension  | B71-6000 | OIO | 85959 | ...   |     | ...   | ...   |
| 11 - 18 | Models with Peterbilt Low Air Leaf Suspension  | 03-08781 |     | ...   | ...   | - - | 85069 | 89455 |
|         |  | C71-1011 |     | ...   | ...   | - - | 85069 | 89455 |
|         |  | C71-1017 |     | ...   | ...   | - - | 85069 | 89455 |
| 11 - 18 | Models with Quadraflex 4 Spring Rear Suspension  | 03-07420 |     | ...   | ...   | - - | 85336 | ...   |
| 11 - 18 | Models with Reyco 102AR (Standard) Rear Air Suspension                                     | 12887-01 |     | ...   | ...   | OIO | 85013 | 89414 |
|         |  | 12887-02 |     | ...   | ...   | OIO | 85013 | 89414 |
| 11 - 18 | Models with Reyco 79KB Rear Steel Spring Suspension  | 16725-01 |     | ...   | ...   | OIO | 83126 | ...   |
|         |  | 19495-01 |     | ...   | ...   | OIO | 83126 | ...   |

#### Additional Applications

|  |                               |                  |     |       |       |     |       |       |
|--|-------------------------------|------------------|-----|-------|-------|-----|-------|-------|
|  | OE PLUS Shock Stamping Number | 02-02736PLUS     | OIO | 85302 | 89420 |     | ...   | ...   |
|  |                               | 02-02737PLUS     | OIO | 85062 | 89408 |     | ...   | ...   |
|  |                               | 02-02738PLUS     | OIO | 85012 | 89413 |     | ...   | ...   |
|  |                               | 02-02739PLUS     | OIO | 85013 | 89414 |     | ...   | ...   |
|  |                               | 03-04176PLUS     |     | ...   | ...   | OIO | 85308 | 89422 |
|  |                               | 03-06084PLUS     |     | ...   | ...   | - O | 85033 | 89427 |
|  |                               | 03-07421PLUS     |     | ...   | ...   | - O | 85311 | 89424 |
|  |                               | 03-07423PLUS     |     | ...   | ...   | - O | 85033 | 89427 |
|  |                               | 10-12032-002PLUS | OIO | 85320 | 89429 |     | ...   | ...   |

## APPLICATION GUIDE - TRUCKS, TRAILERS, AND BUSES









| Year<br>Año<br>Année | Model<br>Modelo<br>Modèle | OEM # | Front     |        | Rear      |        |
|----------------------|---------------------------|-------|-----------|--------|-----------|--------|
|                      |                           |       |           |        |           |        |
|                      |                           |       | Fleetline | GasSLX | Fleetline | GasSLX |

### PETERBILT(Cont'd.)

#### Additional Applications(Cont'd.)

|                                   |                           |          |       |       |       |     |       |       |     |
|-----------------------------------|---------------------------|----------|-------|-------|-------|-----|-------|-------|-----|
| OE PLUS Shock Stamping Number     | 10-12542-000PLUS          | 010      | 85901 | ...   | -     | 0   | ...   | ...   |     |
|                                   | 16-13947-000PLUS          |          | ...   | ...   | 0     | 10  | 85319 | 89428 |     |
|                                   | 2018987C1PLUS             |          | ...   | ...   | 0     | 10  | 85003 | 89411 |     |
|                                   | 47902-13PLUS              |          | ...   | ...   | 0     | 10  | 83122 | 89406 |     |
|                                   | 60670-005PLUS             |          | ...   | ...   | 0     | 10  | 83137 | ...   |     |
|                                   | 60670-008PLUS             |          | ...   | ...   | 0     | 10  | 83123 | 89405 |     |
|                                   | 665565PLUS                |          | ...   | ...   | 0     | 10  | 85007 | 89412 |     |
|                                   | 671962PLUS                |          | ...   | ...   | 0     | 1-  | 85936 | 89456 |     |
|                                   | 70701PLUS                 |          | ...   | ...   | 1     | 1-  | 85900 | ...   |     |
|                                   | 8086053PLUS               |          | ...   | ...   | 0     | 10  | 85047 | 89435 |     |
|                                   | 90044025PLUS              | 010      | 83209 | 89414 |       |     | ...   | ...   |     |
|                                   | 90044089PLUS              |          | ...   | ...   | 0     | 10  | 83124 | 89407 |     |
|                                   | B71-6015                  | 010      | 85012 | 89413 |       |     | ...   | ...   |     |
|                                   | C71-1002PLUS              |          | ...   | ...   | 0     | 10  | 85067 | 89451 |     |
|                                   | C71-1011PLUS              |          | ...   | ...   | 1     | 1-  | 85069 | 89455 |     |
|                                   | K374-26PLUS               | 010      | 85001 | 89410 |       |     | ...   | ...   |     |
|                                   | K374-28PLUS               |          | ...   | ...   | 0     | 10  | 85314 | 89425 |     |
|                                   | K374-29PLUS               |          | ...   | ...   | 1     | 1-  | 85310 | 89423 |     |
| K374-33PLUS                       | 010                       | 83312    | 89409 |       |       | ... | ...   |       |     |
| TruckMaster Shock Stamping Number | 665632                    | 010      | 85013 | 89414 |       |     | ...   | ...   |     |
|                                   | 665783                    |          | ...   | ...   | 0     | 10  | 83123 | 89405 |     |
|                                   | 665784                    |          | ...   | ...   | 0     | 10  | 83122 | 89406 |     |
|                                   | 665785                    |          | ...   | ...   | 0     | 10  | 83137 | ...   |     |
|                                   | 665844                    |          | ...   | ...   | 1     | 1-  | 85069 | 89455 |     |
|                                   | 665918                    |          | ...   | ...   | 1     | 1-  | 85900 | ...   |     |
|                                   | 665926                    |          | ...   | ...   | 0     | 10  | 85047 | 89435 |     |
|                                   | 665927                    | 010      | 85901 | ...   |       |     | ...   | ...   |     |
|                                   | 665928                    | 010      | 85062 | 89408 |       |     | ...   | ...   |     |
|                                   | 665930                    | 010      | 85001 | 89410 |       |     | ...   | ...   |     |
|                                   | 665931                    | 010      | 83312 | 89409 |       |     | ...   | ...   |     |
|                                   | 665932                    | 010      | 85012 | 89413 |       |     | ...   | ...   |     |
|                                   | 665950                    |          | ...   | ...   | 1     | 1-  | 85902 | ...   |     |
|                                   | 671052                    | 010      | 85070 | 89459 |       |     | ...   | ...   |     |
|                                   | 671654                    |          | ...   | ...   | 0     | 1-  | 85936 | 89456 |     |
|                                   | 671699                    |          | ...   | ...   | 0     | 1-  | 85937 | ...   |     |
|                                   | 671794                    |          | ...   | ...   | 0     | 10  | 85067 | 89451 |     |
|                                   | 680237                    |          | ...   | ...   | 0     | 10  | 85303 | 89422 |     |
|                                   | 680239                    |          | ...   | ...   | 1     | 1-  | 85310 | 89423 |     |
|                                   | 680240                    |          | ...   | ...   | 0     | 10  | 85302 | 89420 |     |
|                                   | 680242                    |          | ...   | ...   | 0     | 10  | 85308 | 89422 |     |
|                                   | 680253                    |          | ...   | ...   | 0     | 10  | 85314 | 89425 |     |
|                                   | 680261                    | 010      | 85062 | 89408 |       |     | ...   | ...   |     |
|                                   | 680279                    | 010      | 83209 | 89414 |       |     | ...   | ...   |     |
|                                   | 680280                    |          | ...   | ...   | 0     | 10  | 85906 | 89407 |     |
|                                   | 680281                    |          | ...   | ...   | 0     | 10  | 85003 | 89411 |     |
|                                   | 680303                    |          | ...   | ...   | 0     | 10  | 85007 | 89412 |     |
|                                   | 680425                    | 010      | 85320 | 89429 |       |     | ...   | ...   |     |
|                                   | 680435                    |          | ...   | ...   | 1     | 10  | 85033 | 89427 |     |
|                                   | 680473                    |          | ...   | ...   | 1     | 10  | 85319 | 89428 |     |
|                                   | Models with O.E.M. Number | 02-01759 | 010   | 83312 | 89409 |     |       | ...   | ... |
|                                   |                           | 02-01890 | 010   | 85012 | 89413 |     |       | ...   | ... |
| 02-02061                          |                           | 010      | 85013 | 89414 |       |     | ...   | ...   |     |
| 02-02142                          |                           | 010      | 85036 | 89405 |       |     | ...   | ...   |     |
| 02-02225                          |                           | 010      | 85012 | 89413 |       |     | ...   | ...   |     |
| 03-01635                          |                           |          | ...   | ...   | 0     | 10  | 85308 | 89422 |     |

## APPLICATION GUIDE - TRUCKS, TRAILERS, AND BUSES









| Year<br>Año<br>Année | Model<br>Modelo<br>Modèle | OEM # | Front   |   | Rear  |   |
|----------------------|---------------------------|-------|---|---|---|---|
|                      |                           |       |  |  |  |  |
|                      |                           |       |  |  |  |  |
|                      |                           |       | Fleetline   | GasSLX  | Fleetline   | GasSLX  |

### PETERBILT(Cont'd.)

#### Additional Applications(Cont'd.)

|               |   |              |     |                       |              |              |              |              |
|---------------|---|--------------|-----|-----------------------|--------------|--------------|--------------|--------------|
|               | Models with O.E.M. Number                       | 03-04629     |     | ...                   | ...          | -10          | <b>85311</b> | <b>89424</b> |
|               |   | 03-05106     |     | ...                   | ...          | -10          | <b>85033</b> | <b>89427</b> |
|               |   | 03-05384     |     | ...                   | ...          | -10          | <b>85033</b> | <b>89427</b> |
|               |   | 03-06084     |     | ...                   | ...          | -10          | <b>85033</b> | <b>89427</b> |
|               |   | 03-07281     |     | ...                   | ...          | -10          | <b>85311</b> | <b>89424</b> |
|               |   | 03-07424     |     | ...                   | ...          | -10          | <b>85311</b> | <b>89424</b> |
|               |   | 03-07424PLUS |     | ...                   | ...          | -10          | <b>85311</b> | <b>89424</b> |
|               |   | 23-08233     |     | ...                   | ...          | 010          | <b>85308</b> | <b>89422</b> |
|               |   | 23-10393     |     | ...                   | ...          | 010          | <b>85308</b> | <b>89422</b> |
|               |   | 23-12262     |     | ...                   | ...          | 010          | <b>85012</b> | <b>89413</b> |
|               |   | 665133       |     | ...                   | ...          | 010          |              |              |
|               |   | 665617       |     | ...                   | ...          | 010          | <b>85031</b> | ...          |
|               |   | 665655       |     | ...                   | ...          | 010          | <b>85062</b> | <b>89408</b> |
|               |   | 665656       |     | ...                   | ...          | 010          | <b>85012</b> | <b>89413</b> |
|               |   | 665657       |     | ...                   | ...          | 010          | <b>85013</b> | <b>89414</b> |
|               |   | 665658       |     | ...                   | ...          | 010          | <b>85036</b> | <b>89405</b> |
|               |   | 665660       |     | ...                   | ...          | -10          |              |              |
|               |   | 665662       |     | ...                   | ...          | 010          | <b>85012</b> | <b>89413</b> |
|               |   | 665738       |     | ...                   | ...          | 010          | <b>85910</b> | ...          |
|               |   | 665752       |     | ...                   | ...          | 010          |              |              |
|               |   | 665762       |     | ...                   | ...          | 010          | <b>85012</b> | <b>89413</b> |
|               |   | 665788       |     | ...                   | ...          | 010          |              |              |
|               |   | 665826       |     | ...                   | ...          | -1-          |              |              |
|               |   | 665858       |     | ...                   | ...          | 010          | <b>85070</b> | <b>89459</b> |
|               |   | 665876       |     | ...                   | ...          | 010          | <b>85959</b> | ...          |
|               |   | 665945       |     | ...                   | ...          | -1-          |              |              |
|               |   | 671091       |     | ...                   | ...          | -1-          |              |              |
|               |   | 671092       |     | ...                   | ...          | 010          | <b>85012</b> | <b>89413</b> |
|               |   | 671962SPL    |     | ...                   | ...          | 01-          |              |              |
|               |   | 671963       |     | ...                   | ...          | 01-          |              |              |
|               |   | 680026       |     | ...                   | ...          | 010          | <b>85302</b> | <b>89420</b> |
|               |   | 680027       |     | ...                   | ...          | 010          | <b>85308</b> | <b>89422</b> |
|               |   | 680185       |     | ...                   | ...          | 010          | <b>85308</b> | <b>89422</b> |
|               |   | 680241       |     | ...                   | ...          | -10          |              |              |
|               |   | 680348       |     | ...                   | ...          | 010          | <b>85012</b> | <b>89413</b> |
|               |   | 680435       |     | ...                   | ...          | -10          |              |              |
|               |   | 680457       |     | ...                   | ...          | 010          | <b>85302</b> | <b>89420</b> |
|               |   | 680458       |     | ...                   | ...          | -1-          |              |              |
|               |   | 680459       |     | ...                   | ...          | -10          |              |              |
|               |   | 680586       |     | ...                   | ...          | -10          |              |              |
|               |   | B71-1000     |     | ...                   | ...          | 010          | <b>85031</b> | ...          |
|               |   | B71-1001     |     | ...                   | ...          | 010          | <b>85070</b> | <b>89459</b> |
|               |   | B71-1002     |     | ...                   | ...          | 010          | <b>85001</b> | <b>89410</b> |
|               |   | B71-1003     |     | ...                   | ...          | 010          | <b>83312</b> | <b>89409</b> |
|               |   | B71-6002     |     | ...                   | ...          | 010          | <b>85012</b> | <b>89413</b> |
| B71-6003      |   | ...          | ... | 010                   | <b>85029</b> | ...          |              |              |
| B71-6004      |   | ...          | ... | 010                   | <b>85084</b> | <b>89460</b> |              |              |
| B71-6008      |   | ...          | ... | 010                   | <b>83312</b> | <b>89409</b> |              |              |
| C71-1011SPL   |   | ...          | ... | -1-                   |              |              |              |              |
| C71-1013      |   | ...          | ... | 01-                   |              |              |              |              |
| C71-1014      |   | ...          | ... | 01-                   |              |              |              |              |
| C71-6005      |   | ...          | ... | -1-                   |              |              |              |              |
| <b>2013 -</b> | Models with O.E.M. Number                       | B71-6010     | 010 | <b>85023 or 89415</b> |              |              |              |              |
|               | Models with Quadraflex 4 spring rear suspension | 03-04628     |     | ...                   | ...          | -1-          | <b>85336</b> | ...          |

## APPLICATION GUIDE - TRUCKS, TRAILERS, AND BUSES

| Year<br>Año<br>Année | Model<br>Modelo<br>Modèle | OEM # | Front  |  | Rear  |   |
|----------------------|---------------------------|-------|--|--|---|---|
|                      |                           |       |  |  |  |  |
|                      |                           |       |   |   |  |  |
|                      |                           |       | Fleetline  | GasSLX   | Fleetline   | GasSLX  |

### PETERBILT CAB SHOCKS

|         |   |            |     |  |       |
|---------|---|------------|-----|--|-------|
| 2018    | 330 Day Cab models with O.E.M. Number   | 1202P055   | 010 |  | 83061 |
| 06 - 13 | 335 Day Cab models with O.E.M. Number   | 1202P055   | 010 |  | 83061 |
| 10 - 18 | 337 Day Cab models with O.E.M. Number   | 1202P055   | 010 |  | 83061 |
| - 2018  | 348 Day Cab models with O.E.M. Number   | 1202P055   | 010 |  | 83061 |
| - 2018  | 348 Sleepers with O.E.M. Number   | 1201-8002  | 010 |  | 83081 |
|         |   | R71-6009   | 010 |  | 83081 |
|         | 357, 375, 376, 377 & 378 Conventional Truck & Tractors with Link Cabmate Models PBC377 & PBC377-A | 1202-0054  | 010 |  | 83021 |
| 1981 -  | 362 Cabovers with Link Cabmate Model PB-362-2P  | 1202-0032  | 010 |  | 83016 |
| 1978 -  | 48" Sleepers with Link Bunkmate Model PBS48-A   | 1202-1044  | 010 |  | 83025 |
| 1978 -  | 63" Sleepers with Link Bunkmate Model PBS63-A   | 1202-1044  | 010 |  | 83025 |
|         | Models with O.E.M. Number   | 654782     | 010 |  | 83008 |
|         |   | 654812     | 010 |  | 83042 |
|         |   | 654919     | 010 |  | 83035 |
|         |   | R71-1004   | 010 |  | 83049 |
|         |   | R71-1005   | 010 |  | 83024 |
|         | Models with PowerPacker Cab Suspension  | 96027-1054 | 010 |  | 83011 |
|         |   | PP1058870  | 010 |  | 83059 |
|         |   | PP1059870  | 010 |  | 83060 |
|         |   | PP2582870  | 010 |  | 83012 |

#### 348 Series

|      |   |          |     |  |       |
|------|---|----------|-----|--|-------|
| 2018 | 348 Conventional Day Cab with O.E.M. Number | R71-6005 | 010 |  | 83042 |
|------|---|----------|-----|--|-------|

#### 359 Series

|         |  |           |     |  |       |
|---------|--|-----------|-----|--|-------|
| 81 - 87 | 359 Conventional Truck & Tractors with Link Cabmate Models PBC379 & PBC379-A     | 1202-0054 | 010 |  | 83021 |
| 81 - 87 | 359 Models (Older Models) Conventional Tractors with Link Cabmate Model PBCAL359 | 1201-0012 | 010 |  | 83023 |
|         |  | 1202-0012 | 010 |  | 83023 |

#### 365 Series

|         |   |          |     |  |       |
|---------|---|----------|-----|--|-------|
| 08 - 18 | 365 Conventional Day Cab with O.E.M. Number | 20-16755 | 010 |  | 83042 |
|         |   | R71-6005 | 010 |  | 83042 |

#### 367 Series

|         |   |          |     |  |       |
|---------|---|----------|-----|--|-------|
| 08 - 17 | 367 Conventional Day Cab with O.E.M. Number | 20-16755 | 010 |  | 83042 |
|         |   | R71-6005 | 010 |  | 83042 |
| 08 - 19 | 367 Models with 70" Sleepers                | 29-02455 | 010 |  | 83008 |
|         |   | R71-6007 | 010 |  | 83008 |

#### 377 & 379 Series

|  |  |           |     |  |       |
|--|--|-----------|-----|--|-------|
|  | 377 & 379 Conventional Models with Unibuilt Cab                              | 29-02455  | 010 |  | 83008 |
|  |  | R71-6007  | 010 |  | 83008 |
|  | 379 Conventional Truck & Tractors with Link Cabmate Models PBC379 & PBC379-A | 1202-0054 | 010 |  | 83021 |

#### 384 Series

|         |   |          |     |  |       |
|---------|---|----------|-----|--|-------|
| 08 - 16 | 384 Conventional Day Cab with O.E.M. Number | 20-16755 | 010 |  | 83042 |
|         |   | R71-6005 | 010 |  | 83042 |

#### 386 Series

|         |   |          |     |  |       |
|---------|---|----------|-----|--|-------|
| 06 - 16 | 386 Conventional Day Cab with O.E.M. Number | 20-16755 | 010 |  | 83042 |
|         |   | R71-6005 | 010 |  | 83042 |
| 06 - 19 | 386 Models with Sleepers                    | 29-02455 | 010 |  | 83008 |
|         |   | R71-6007 | 010 |  | 83008 |

#### 387 Series

|         |                                  |          |     |  |       |
|---------|----------------------------------|----------|-----|--|-------|
| 1999 -  | 387 Models with 70" Sleepers     | 29-06032 | 010 |  | 83035 |
|         |                                  | R71-6008 | 010 |  | 83035 |
| 1999 -  | 387 Models with O.E.M. Number    | 29-06005 | 010 |  | 83035 |
| 08 - 11 | DayCab Models with O.E.M. Number | R71-6000 | 010 |  | 83067 |
|         |                                  | R71-6010 | 010 |  | 83067 |

## APPLICATION GUIDE - TRUCKS, TRAILERS, AND BUSES

| Year<br>Año<br>Année | Model<br>Modelo<br>Modèle | OEM # | Front |                    | Rear |                    |
|----------------------|---------------------------|-------|-------|--------------------|------|--------------------|
|                      |                           |       |       |                    |      |                    |
|                      |                           |       | ○ ○   | Fleetline   GasSLX | ○ ○  | Fleetline   GasSLX |

### PETERBILT CAB SHOCKS(Cont'd.)

#### 388 Series(Cont'd.)

|         |   |          |     |  |       |
|---------|---|----------|-----|--|-------|
| 08 - 17 | 388 Conventional Day Cab with O.E.M. Number | 20-16755 | ○ ○ |  | 83042 |
|         |   | R71-6005 | ○ ○ |  | 83042 |
| 08 - 17 | 388 Models with 70" Sleepers                | 29-02455 | ○ ○ |  | 83008 |
|         |   | R71-6007 | ○ ○ |  | 83008 |

#### 389 Series

|         |                                       |          |     |  |       |
|---------|---------------------------------------|----------|-----|--|-------|
| - 2019  | 389 Day Cab models with O.E.M. Number | 20-19140 | ○ ○ |  | 83063 |
|         |                                       | R71-6006 | ○ ○ |  | 83063 |
| 08 - 19 | 389 Models with 70" Sleepers          | 29-02455 | ○ ○ |  | 83008 |
|         |                                       | R71-6007 | ○ ○ |  | 83008 |

#### 567 Series

|         |   |           |     |  |       |
|---------|---|-----------|-----|--|-------|
| 16 - 18 | Sleeper Cab models with O.E.M. Number (Shocks only) | 1201-8006 | ○ ○ |  | 83081 |
|         |   | 25523024  | ○ ○ |  | 83081 |

#### 579 Series

|         |   |           |     |  |       |
|---------|---|-----------|-----|--|-------|
| 16 - 18 | Sleeper Cab models with O.E.M. Number (Shocks only) | 1201-8006 | ○ ○ |  | 83081 |
|         |   | 25523024  | ○ ○ |  | 83081 |

#### 587 Series

|         |                              |          |     |  |       |
|---------|------------------------------|----------|-----|--|-------|
| 11 - 16 | 587 Models with 70" Sleepers | 29-06032 | ○ ○ |  | 83035 |
|         |                              | R71-6008 | ○ ○ |  | 83035 |

### PHOENIX CRUISER RV

|         |  |          |     |       |     |     |       |     |
|---------|--|----------|-----|-------|-----|-----|-------|-----|
| 11 - 19 | All models with Ford E350 & E450 Chassis | ASH-1136 |     | ...   | ... | - ○ | 83178 | ... |
|         |  | ASH-1154 | - ○ | 83177 | ... |     | ...   | ... |

### PIERCE MANUFACTURING INC.

|  |                                      |         |     |       |     |  |                |     |
|--|--------------------------------------|---------|-----|-------|-----|--|----------------|-----|
|  | Pierce FireTrucks with O.E.M. Number | 680401  | ○ ○ | 85307 | ... |  | ...            | ... |
|  | Additional O.E.M. Interchanges       | 1445910 | ○ ○ |       |     |  | 85300 or 89419 |     |
|  |                                      | 40-0242 | ○ ○ |       |     |  | 83312 or 89409 |     |
|  |                                      | 40-4845 | ○ ○ |       |     |  | 85304          |     |
|  |                                      | 40-4951 | - ○ |       |     |  | 85316 or 89426 |     |
|  |                                      | 40-5348 | ○ ○ |       |     |  | 85058 or 89431 |     |
|  |                                      | 40-6967 | ○ ○ |       |     |  | 85030 or 89440 |     |

### POWERHOUSE COACH INC.





|         |   |              |     |       |       |     |       |       |
|---------|---|--------------|-----|-------|-------|-----|-------|-------|
| 06 - 10 | Models with Volvo VNL780 Chassis with 12,500 - 14,600 lb Front Axle | 20433424     | ○ ○ | 85061 | 89450 |     | ...   | ...   |
| 11 - 18 | Models with Volvo VNL780 Chassis with 12,500 - 14,600 lb Front Axle | 141700005838 | ○ ○ | 85098 | ...   |     | ...   | ...   |
|         |   | 21436086     | ○ ○ | 85098 | ...   |     | ...   | ...   |
| 06 - 11 | Models with Volvo VNL780 Chassis with 40,000 lb Rear Air Suspension | 20551628     |     | ...   | ...   | ○ ○ | 85066 | 89448 |
|         |   | 471700000443 |     | ...   | ...   | ○ ○ | 85066 | 89448 |
| 11 - 18 | Models with Volvo VNL780 Chassis with 40,000 lb Rear Air Suspension | 21462380     |     | ...   | ...   | ○ ○ | 85088 | ...   |
|         |   | 471700006040 |     | ...   | ...   | ○ ○ | 85088 | ...   |
| 06 - 16 | Models with Volvo VNL780 Chassis with Hendrickson Airtek            | 20485632     | ○ ○ | 85933 | 89454 |     | ...   | ...   |
|         |   | 20485633     | ○ ○ | 85933 | 89454 |     | ...   | ...   |
|         |   | 21137330     | ○ ○ | 85933 | 89454 |     | ...   | ...   |
|         |   | 471700003832 | ○ ○ | 85933 | 89454 |     | ...   | ...   |
|         |   | 64838-003    | ○ ○ | 85933 | 89454 |     | ...   | ...   |
|         |   | 64838-003L   | ○ ○ | 85933 | 89454 |     | ...   | ...   |

### POWERPACKER CAB SHOCKS

|  |  |           |     |  |       |
|--|--|-----------|-----|--|-------|
|  | Models with PowerPacker Cab Suspension | PP1058870 | ○ ○ |  | 83059 |
|  |  | PP1059870 | ○ ○ |  | 83060 |







**APPLICATION GUIDE - TRUCKS, TRAILERS, AND BUSES**

| Year<br>Año<br>Année | Model<br>Modelo<br>Modèle | OEM # | Front   |  | Rear  |   |
|----------------------|---------------------------|-------|---|--|---|---|
|                      |                           |       |  |  |  |  |
|                      |                           |       | Fleetline   | GasSLX   | Fleetline   | GasSLX  |

**PREVOST**

|         |  |                                       |             |       |       |               |     |
|---------|--|---------------------------------------|-------------|-------|-------|---------------|-----|
| 04 - 09 | H3 Bus, H3 VIP Bus<br>Drive and Tag Axle Shocks                                | 630253                                |             |       |       |               |     |
|         |  | 481700999386                          |             |       | 010   | 85713         | ... |
|         |  | 630127                                |             |       | 010   | 85736         | ... |
|         |  | 650407                                |             |       | 010   | 85736         | ... |
|         |  | VIP with Independant Front Suspension | 48170000208 | 01-   | 85379 | ...           | ... |
|         |  | 630251                                | 01-         | 85379 | ...   | ...           | ... |
|         |  | With I-Beam Front Suspension          | 630252      | 010   | 85329 | ...           | ... |
|         |  | 481700999376                          | 010         | 85329 | ...   | ...           | ... |
|         |  | 630134                                | 010         | 85329 | ...   | ...           | ... |
|         |  | 680422                                | 010         | 85329 | ...   | ...           | ... |
|         | Intercity Bus with O.E.M. Number   | 481700999427                          | 01-         | 85380 | ...   | ...           |     |
|         |  | 630228                                | 01-         | 85380 | ...   | ...           |     |
|         |  | 680583                                | 01-         | 85380 | ...   | ...           |     |
|         | LeMirage XL 40 ft, 45 ft, & H Models Coaches with Independant Front Suspension | 630136                                | 01-         | 85330 | ...   | ...           |     |
|         | LeMirage XL 40 ft, 45 ft, & H3-45 VIP Coaches with I-Beam Front Suspension     | 481700999376                          | 010         | 85329 | ...   | ...           |     |
|         |  | 630134                                | 010         | 85329 | ...   | ...           |     |
|         | Low Floor Bus Models with O.E.M. Number  | N16249                                |             | ...   | ...   | 010 85378 ... |     |
|         | X3-45 Bus  |                                       |             |       |       |               |     |
|         | Drive and Tag Axle Shocks  | 630253                                |             |       |       | ...           |     |
|         | With I-Beam Front Suspension   | 48170000206                           | 01-         | 85380 | ...   | ...           |     |
|         |  | 630254                                | 01-         | 85380 | ...   | ...           |     |
|         | With Independant Front Suspension  | 630136                                | 01-         | 85330 | ...   | ...           |     |
| 04 - 06 | XL II Bus, XL II MTH Bus<br>Drive and Tag Axle Shocks                          | 630253                                |             |       |       |               |     |
|         |  | 481700999386                          |             |       | 010   | 85713         | ... |
|         |  | 630127                                |             |       | 010   | 85736         | ... |
|         |  | 650407                                |             |       | 010   | 85736         | ... |
|         |  | With I-Beam Front Suspension          | 630252      | 010   | 85329 | ...           | ... |
|         |  | 481700999376                          | 010         | 85329 | ...   | ...           | ... |
|         |  | 630134                                | 010         | 85329 | ...   | ...           | ... |
|         |  | 680422                                | 010         | 85329 | ...   | ...           | ... |
|         |  | With Independant Front Suspension     | 48170000208 | 01-   | 85379 | ...           | ... |
|         |  | 630251                                | 01-         | 85379 | ...   | ...           | ... |
|         | 481700999377   | 01-                                   | 85330       | ...   | ...   |               |     |
|         | 630163   | 01-                                   | 85330       | ...   | ...   |               |     |
| 07 - 09 | XL II MTH Bus<br>Drive and Tag Axle Shocks                                     | 630253                                |             |       |       |               |     |
|         |  | 630136                                | 01-         | 85330 | ...   | ...           |     |
| 89 - 00 | XL-45 Coach<br>Drive and Tag Axle Shocks                                       | 481700999386                          |             |       |       |               |     |
|         |  | 630127                                |             |       | 010   | 85736         | ... |
|         |  | 650407                                |             |       | 010   | 85736         |     |
|         | With I-Beam Front Suspension   | 481700999376                          | 010         | 85329 | ...   | ...           |     |
|         |  | 630134                                | 010         | 85329 | ...   | ...           |     |
|         |  | 680422                                | 010         | 85329 | ...   | ...           |     |
|         | Models with O.E.M. Number  | 12L-5-89                              |             |       |       | 01- 85729 ... |     |
|         |  | 12T-1-13                              |             |       | 010   | 85303 89422   |     |
|         |  | 19501288                              |             |       | 01-   | 85729 ...     |     |
|         |  | 19501289                              | -1-         | 85728 | ...   | ...           |     |
|         |  | 19501547                              |             |       | 01-   | 85740 ...     |     |
|         |  | 48170000207                           | 010         | 85329 | ...   | ...           |     |
|         |  | 48170000209                           |             |       | 010   | 85713 ...     |     |
|         |  | 630103                                | 010         | 85329 | ...   | ...           |     |

**APPLICATION GUIDE - TRUCKS, TRAILERS, AND BUSES**

| Year<br>Año<br>Année | Model<br>Modelo<br>Modèle | OEM # | Front   |   | Rear  |   |
|----------------------|---------------------------|-------|---|---|---|---|
|                      |                           |       |  |  |  |  |
|                      |                           |       | Fleetline   | GasSLX  | Fleetline   | GasSLX  |

**PREVOST(Cont'd.)**

|  |                                |              |     |              |     |     |                       |     |
|--|--------------------------------|--------------|-----|--------------|-----|-----|-----------------------|-----|
|  | Models with O.E.M. Number      | 630161       |     | ...          | ... | 010 | <b>85736</b>          | ... |
|  |                                | 630234       | 010 | <b>85329</b> | ... |     | ...                   | ... |
|  |                                | 630235       | 01- | <b>85330</b> | ... |     | ...                   | ... |
|  |                                | 630236       | 010 | <b>85329</b> | ... |     | ...                   | ... |
|  |                                | 680510       | 01- | <b>85330</b> | ... |     | ...                   | ... |
|  |                                | G5008070     | 010 | <b>85700</b> | ... |     | ...                   | ... |
|  | Additional O.E.M. Interchanges | 01-0100-905  | 010 |              |     |     | <b>85303 or 89422</b> |     |
|  |                                | 0822045526   | 010 |              |     |     | <b>85702</b>          |     |
|  |                                | 12B-5-1      | 010 |              |     |     | <b>85735</b>          |     |
|  |                                | 19501669     | 010 |              |     |     | <b>85339</b>          |     |
|  |                                | 19502711     | 010 |              |     |     | <b>85702</b>          |     |
|  |                                | 19506846     | 010 |              |     |     | <b>85339</b>          |     |
|  |                                | 196347       | -10 |              |     |     | <b>85710</b>          |     |
|  |                                | 196533       | -1- |              |     |     | <b>85708</b>          |     |
|  |                                | 3166657      | 010 |              |     |     | <b>85700</b>          |     |
|  |                                | 481700999377 | 01- |              |     |     | <b>85330</b>          |     |
|  |                                | 52001        | -1- |              |     |     | <b>85708</b>          |     |
|  |                                | 630001       | 010 |              |     |     | <b>85713</b>          |     |
|  |                                | 630080       | 010 |              |     |     | <b>85713</b>          |     |
|  |                                | 630091       | 010 |              |     |     | <b>85736</b>          |     |
|  |                                | 630163       | 01- |              |     |     | <b>85330</b>          |     |
|  |                                | 63-1013      | 010 |              |     |     | <b>85329</b>          |     |
|  |                                | 680323       | 010 |              |     |     | <b>85700</b>          |     |
|  |                                | 680492       | 010 |              |     |     | <b>85713</b>          |     |
|  |                                | 680555       | 01- |              |     |     | <b>85330</b>          |     |
|  |                                | 690060       | 010 |              |     |     | <b>85713</b>          |     |
|  |                                | 74939852     | 010 |              |     |     | <b>85308 or 89422</b> |     |
|  |                                | G1011822     | 010 |              |     |     | <b>85702</b>          |     |
|  |                                | N22212       | 010 |              |     |     | <b>85700</b>          |     |

**RAMERIZ TRAILER**

Identification of the trailer suspension is necessary to determine what section of the catalog to refer to. Some possible options can be Chalmers, Hendrickson, Neway, Ridewell, Reyco.

**Trailer**

|  |   |          |  |     |     |     |              |     |
|--|---|----------|--|-----|-----|-----|--------------|-----|
|  | 86 AR / RS 1015, 1035, 3015, 3035 Slider Air Suspension | 18165-01 |  | ... | ... | 010 | <b>85006</b> | ... |
|--|---|----------|--|-----|-----|-----|--------------|-----|

**RAYDAN MANUFACTURING**

|  |   |            |  |     |     |     |              |     |
|--|---|------------|--|-----|-----|-----|--------------|-----|
|  | Air Link Suspensions with O.E.M. Number | 14QK-3100  |  | ... | ... | 010 | <b>85739</b> | ... |
|  |   | 446-51-211 |  | ... | ... | 010 | <b>85739</b> | ... |
|  | AL460 Air Link Suspension               | 700115     |  | ... | ... | 010 | <b>85712</b> | ... |
|  | AL520 Air Link Suspension               | 700115     |  | ... | ... | 010 | <b>85712</b> | ... |

**RED LION TRAILER**

|  |   |          |  |     |     |     |              |     |
|--|---|----------|--|-----|-----|-----|--------------|-----|
|  | Trailers with Neway Air Susp. RL196-14, -15 | 90044978 |  | ... | ... | 010 | <b>85059</b> | ... |
|--|---|----------|--|-----|-----|-----|--------------|-----|

**REINKE MANUFACTURING COMPANY, INC.**

Identification of the trailer suspension is necessary to determine what section of the catalog to refer to. Some possible options can be Chalmers, Hendrickson, Neway, Ridewell, Reyco.

**RENEGADE RV**

|         |  |                 |     |              |     |     |              |              |
|---------|--|-----------------|-----|--------------|-----|-----|--------------|--------------|
| - 2019  | All Models with Freightliner Airliner Rear Air Suspension  | 16-18708-000    |     | ...          | ... | 010 | <b>85724</b> | <b>89443</b> |
|         |  | SDA471700002809 |     | ...          | ... | 010 | <b>85724</b> | <b>89443</b> |
| 12 - 19 | Ikon Series Motorhomes with Freightliner Cascadia Chassis and 12,000 to 13,300 lb Taperleaf Front Suspension | 10-13809-000    | 010 | <b>85958</b> | ... |     | ...          | ...          |
|         |  | SDA471400003920 | 010 | <b>85958</b> | ... |     | ...          | ...          |
| 09 - 19 | Models with Freightliner M2-112 Chassis with 12000 lb to 20000 Front Axle                                    | 10-13809-000    | 010 | <b>85958</b> | ... |     | ...          | ...          |

## APPLICATION GUIDE - TRUCKS, TRAILERS, AND BUSES

| Year<br>Año<br>Année | Model<br>Modelo<br>Modèle | OEM # | Front     |        | Rear      |        |
|----------------------|---------------------------|-------|-----------|--------|-----------|--------|
|                      |                           |       |           |        |           |        |
|                      |                           |       | Fleetline | GasSLX | Fleetline | GasSLX |

### RENEGADE RV(Cont'd.)

|         |   |                 |     |       |       |     |       |       |
|---------|---|-----------------|-----|-------|-------|-----|-------|-------|
| 09 - 19 | Models with Freightliner M2-112 Chassis with 12000 lb to 20000 Front Axle   | 471700003920    | OIO | 85958 | ...   |     | ...   | ...   |
| 06 - 10 | Models with Volvo VNL630 Chassis with 12,500 - 14,600 lb Front Axle   | 20433424        | OIO | 85061 | 89450 |     | ...   | ...   |
| 11 - 18 | Models with Volvo VNL630 Chassis with 12,500 - 14,600 lb Front Axle   | 141700005838    | OIO | 85098 | ...   |     | ...   | ...   |
|         |   | 21436086        | OIO | 85098 | ...   |     | ...   | ...   |
| 06 - 11 | Models with Volvo VNL630 Chassis with 40,000 lb Rear Air Suspension   | 20551628        |     | ...   | ...   | OIO | 85066 | 89448 |
|         |   | 471700000443    |     | ...   | ...   | OIO | 85066 | 89448 |
| 11 - 18 | Models with Volvo VNL630 Chassis with 40,000 lb Rear Air Suspension   | 21462380        |     | ...   | ...   | OIO | 85088 | ...   |
|         |   | 471700006040    |     | ...   | ...   | OIO | 85088 | ...   |
| 15 - 19 | Renegade XL Series Motorhomes with Freightliner Cascadia Chassis and 12,000 to 13,300 lb Taperleaf Front Suspension | 10-13809-000    | OIO | 85958 | ...   |     | ...   | ...   |
|         |   | SDA471400003920 | OIO | 85958 | ...   |     | ...   | ...   |
| 16 - 19 | Verona & Verona LE Series Motorhomes with Freightliner M2-106 Chassis   | 10-13760-000    | OIO | 85959 | 89503 |     | ...   | ...   |
|         |   | 471700002991    | OIO | 85959 | 89503 |     | ...   | ...   |
|         |   | SDA471700002991 | OIO | 85959 | 89503 |     | ...   | ...   |

### REYCO SUSPENSION

#### Drive Axle

|  |   |          |  |     |     |     |       |       |
|--|---|----------|--|-----|-----|-----|-------|-------|
|  | 101A, 101AR Models                              | 18166-01 |  | ... | ... | OIO | 85704 | ...   |
|  | 102 Models                                      | 16725-01 |  | ... | ... | OIO | 83126 | ...   |
|  |   | 19495-01 |  | ... | ... | OIO | 83126 | ...   |
|  | 102AR (Hvy Duty) Models                         | 18286-01 |  | ... | ... | OIO | ...   | 89414 |
|  | 102AR (Special) Models                          | 17146-01 |  | ... | ... | OIO | 83209 | 89414 |
|  | 102AR (Standard) Models                         | 12887-01 |  | ... | ... | OIO | 85013 | 89414 |
|  |   | 12887-02 |  | ... | ... | OIO | 85013 | 89414 |
|  | 102AR for Western Star Models                   | 19824-01 |  | ... | ... | OIO | 85006 | ...   |
|  | 102AR-7 Models                                  | 17794-01 |  | ... | ... | OIO | 83215 | ...   |
|  | 102AR-LM Models                                 | 19623-01 |  | ... | ... | OIO | 83123 | 89405 |
|  | 102W Drive Models                               | 21497-01 |  | ... | ... | OIO | 85005 | 89430 |
|  | 200 Models Air Suspension                       | 20129-01 |  | ... | ... | OIO | 85007 | 89412 |
|  | 200 Models Air Suspension<br>With O.E.M. Number | 22062-01 |  | ... | ... | OIO | 85007 | 89412 |
|  |   |          |  |     |     |     |       |       |
|  | 21AR - 25000 lb Capacity                        | 12887-01 |  | ... | ... | OIO | 85013 | 89414 |
|  |   | 12887-02 |  | ... | ... | OIO | 85013 | 89414 |
|  | 240AR Air-Ride Suspension<br>With O.E.M. Number | 20125-01 |  | ... | ... | OIO | 85030 | 89440 |
|  |   | 20126-01 |  | ... | ... | OIO | ...   | 89440 |
|  |   | 20129-01 |  | ... | ... | OIO | 85007 | 89412 |
|  | 74AR - 30000 lb Capacity                        | 12887-01 |  | ... | ... | OIO | 85013 | 89414 |
|  |   | 12887-02 |  | ... | ... | OIO | 85013 | 89414 |
|  | 79AR Models                                     | 12887-02 |  | ... | ... | OIO | 85013 | 89414 |
|  | 79KB Models                                     | 16725-01 |  | ... | ... | OIO | 83126 | ...   |
|  |   | 19495-01 |  | ... | ... | OIO | 83126 | ...   |
|  | AirGlide 400 Air Suspension                     | 20129-01 |  | ... | ... | OIO | 85007 | 89412 |

#### Steer Axle

|  |                              |          |     |       |       |  |     |     |
|--|------------------------------|----------|-----|-------|-------|--|-----|-----|
|  | 1200 (Spartan Option) Models | 21310-01 | OIO | 85307 | ...   |  | ... | ... |
|  | 1207 Models                  | 17403-01 | OIO | 83122 | 89406 |  | ... | ... |
|  | 1209 (Alternate) Models      | 17408-01 | OIO | 85005 | 89430 |  | ... | ... |
|  | 1209, 1212 Models            | 17358-01 | OIO | 83126 | 89430 |  | ... | ... |
|  |                              | 19495-01 | OIO | 83126 | 89440 |  | ... | ... |
|  | 21B Models                   | 14954-01 | OIO | 83217 | ...   |  | ... | ... |

#### Trailer

|  |   |           |  |     |     |     |       |       |
|--|---|-----------|--|-----|-----|-----|-------|-------|
|  | 19AR / RS1062 Models with Unit # 700649-01 to -06 | 700098-01 |  | ... | ... | OIO | 83128 | 89436 |
|--|---|-----------|--|-----|-----|-----|-------|-------|

## APPLICATION GUIDE - TRUCKS, TRAILERS, AND BUSES









| Year<br>Año<br>Année | Model<br>Modelo<br>Modèle | OEM # | Front     |        | Rear      |        |
|----------------------|---------------------------|-------|-----------|--------|-----------|--------|
|                      |                           |       |           |        |           |        |
|                      |                           |       | Fleetline | GasSLX | Fleetline | GasSLX |

### REYCO SUSPENSION(Cont'd.)

#### Trailer(Cont'd.)

|  |           |     |     |     |       |       |
|--|-----------|-----|-----|-----|-------|-------|
| 19AR / RS1062 Models with Unit # 700649-07 to -12  | 24392-01  | ... | ... | 010 | 85051 | ...   |
| 20 AR / RS 3162 Models with O.E.M. number  | 18163-01  | ... | ... | 010 | 83207 | 89407 |
| 20AR & 22AR Models with O.E.M. Number  | 700098-03 | ... | ... | 010 | 85052 | ...   |
| 21B (Special) Models   | 18800-01  | ... | ... | 010 | 83203 | 89436 |
| 23 ART Models with O.E.M. Number   | 665748    | ... | ... | 010 | 85086 | ...   |
| 23 ARTB-14A, -15A, 16A or -19A Models  | 23523-01  | ... | ... | 010 | 85086 | ...   |
| 23 ARTB-14A-FS Models  | 702135-01 | ... | ... | 010 | 85045 | ...   |
|  | 702135-01 | ... | ... | 010 | 85045 | ...   |
|  | 702135-01 | ... | ... | 010 | 85045 | ...   |
| 23 ARTU Models (All except -14A-FS and , -15A-FS)  | 23523-01  | ... | ... | 010 | 85086 | ...   |
| 23 ARTU-14A-FS and -15A-FS Models  | 702135-01 | ... | ... | 010 | 85045 | ...   |
| 23 ARTUL Models (All except -14A-FS and , -15A-FS)   | 23523-01  | ... | ... | 010 | 85086 | ...   |
| 25 ARTB-13A, -14A, -15A, -16A, -17A Models   | 24392-01  | ... | ... | 010 | 85051 | ...   |
| 25 ARTBL-13A, -14A, -15A, -16A, -17A, -18A, -19A Models  | 24392-01  | ... | ... | 010 | 85051 | ...   |
| 25 ARTBL-14A-FS, -15A-FS, -16A-FS, -17A-FS Models  | 702135-01 | ... | ... | 010 | 85045 | ...   |
| 25 ARTBL-18A-FS, -19A-FS, -20A-FS Models   | 704672-01 | ... | ... | 010 | 85938 | ...   |
| 25 ARTU Models ( All except -12A-FS )  | 24392-01  | ... | ... | 010 | 85051 | ...   |
| 25 ARTU-12A-FS   | 702136-01 | ... | ... | 010 | 85052 | ...   |
| 25 ARTUL-13A, -13S, -14A, -14S, -15A, -15S, -16A, -16S, -17A, -17S, -18A, -18S, -19A, -19S Models                                    | 24392-01  | ... | ... | 010 | 85051 | ...   |
| 25 ARTUL-18A-FS, -19A-FS, -20A-FS, -21A-FS, -22A-FS, -23A-FS, -24A-FS, -18-FS, -19-FS, -20-FS, -21-FS, -22-FS, -23-FS, -24-FS Models | 704672-01 | ... | ... | 010 | 85938 | ...   |
| 25 ARUU Models ( All except -06-5A-NZ )  | 23553-01  | ... | ... | 010 | 85938 | ...   |
| 25 ARUU-06-5A-NZ Models  | 702136-01 | ... | ... | 010 | 85052 | ...   |
| 25 ARUUL-09A, -09A-99, -9S, -09S-99 Models   | 702135-01 | ... | ... | 010 | 85045 | ...   |
| 25 ARUUL-10A, -10S, -11A, -11S, -12A, -12S, -13A, -13S, -14A, -14S, -15A, -15S Models  | 23553-01  | ... | ... | 010 | 85938 | ...   |
| 30 ART with O.E.M. Number  | 23524-01  | ... | ... | 010 | 85738 | ...   |
| 30 ARTB-14A, -15A, -16A, -17A, -18A, -19A, -20A Models   | 23524-01  | ... | ... | 010 | 85738 | ...   |
| 30 ARTB-19A-FS, -20A-FS Models   | 23553-01  | ... | ... | 010 | 85938 | ...   |
| 30 ARTBL-15A, -16A, -17A, -18A, -19A Models  | 23524-01  | ... | ... | 010 | 85738 | ...   |
| 30 ARTBL-19A-FS, -20A-FS Models  | 23553-01  | ... | ... | 010 | 85938 | ...   |
| 30 ARTU-14A, -14S, -15A, -15S, -16A, -16S, -17A, -17S, -18A, -18S, -19A, -19S, -20A Models   | 23524-01  | ... | ... | 010 | 85738 | ...   |
| 30 ARTU-20A-FS Models  | 23553-01  | ... | ... | 010 | 85938 | ...   |
| 30 ARTUL-15A, -15S, -16A, -16S, -17A, -17S, -18A, -19A, -19S, -20A-TTN Models  | 23524-01  | ... | ... | 010 | 85738 | ...   |
| 30 ARTUL-20A-FS Models   | 23553-01  | ... | ... | 010 | 85938 | ...   |
| 30 ARUU - 14 and -15 Models  | 23553-01  | ... | ... | 010 | 85938 | ...   |
| 30 ARUU - 9, -12 and -17 Models  | 23524-01  | ... | ... | 010 | 85738 | ...   |
| 30 ARUUL - 12 and -17 Models   | 23524-01  | ... | ... | 010 | 85738 | ...   |
| 30 ARUUL - 9, -14 and -15 Models   | 23553-01  | ... | ... | 010 | 85938 | ...   |
| 44 AR Models   | 19623-01  | ... | ... | 010 | 83123 | 89405 |
| 81C Models   | 12885-03  | ... | ... | 010 | 85300 | 89419 |
| 81LC Models  | 12885-01  | ... | ... | 010 | 85300 | 89419 |
| 81LM Models  | 12886-01  | ... | ... | 010 | 85334 | ...   |
| 81S Models   | 12885-03  | ... | ... | 010 | 85300 | 89419 |
| 86 AR / RS 1015, 1035, 3015, 3035 Slider Air Suspension  | 18165-01  | ... | ... | 010 | 85006 | ...   |
| 87 for Great Dane Models   | 18163-01  | ... | ... | 010 | 83207 | 89407 |
|  | 18164-01  | ... | ... | 010 | 83122 | 89406 |
| 87-14 (Rear Mount) Models  | 18146-01  | ... | ... | 010 | 85313 | ...   |
| 87-14, -17 Models  | 16230-01  | ... | ... | 010 | 85702 | ...   |
| 87-14, -17 Slider Models   | 12885-01  | ... | ... | 010 | 85300 | 89419 |
| 87-6, 87-9 Models  | 12885-01  | ... | ... | 010 | 85300 | 89419 |
| 87M-12 Models  | 18146-01  | ... | ... | 010 | 85313 | ...   |

## APPLICATION GUIDE - TRUCKS, TRAILERS, AND BUSES

| Year<br>Año<br>Année | Model<br>Modelo<br>Modèle | OEM # | Front  |  | Rear  |   |
|----------------------|---------------------------|-------|--|--|---|---|
|                      |                           |       |  |  |  |  |
|                      |                           |       |   |   |  |  |
|                      |                           |       | Fleetline  | GasSLX   | Fleetline   | GasSLX  |

### REYCO SUSPENSION(Cont'd.)

#### Additional Applications(Cont'd.)

|                           |           |     |     |       |       |       |
|---------------------------|-----------|-----|-----|-------|-------|-------|
| Models with O.E.M. Number | 16824-01  | ... | ... | 010   | 85006 | ...   |
|                           | 17142-01  | ... | ... | 010   | 85001 | 89410 |
|                           | 20960-01  | ... | ... | 010   | 83204 | ...   |
|                           | 23106-01  | ... | ... | 010   | 85975 | ...   |
|                           | 23614-01  | ... | ... | 010   | 85717 | ...   |
|                           | 665519    | ... | ... | 010   | ...   | 89414 |
|                           | 665813    | ... | ... | 010   | 85051 | ...   |
|                           | 665830    | ... | ... | 010   | 85045 | ...   |
|                           | 665833    | ... | ... | 010   | 85052 | ...   |
|                           | 671707    | ... | ... | 010   | 85323 | 89436 |
|                           | 680551    | ... | ... | 010   | 85738 | ...   |
|                           | 680552    | ... | ... | 010   | 85938 | ...   |
|                           | 680700    | ... | ... | 010   | 85938 | ...   |
|                           | 702135-01 | ... | ... | 010   | 85045 | ...   |
|                           | 702136-01 | ... | ... | 010   | 85052 | ...   |
|                           | 702209-01 | ... | ... | 010   | 85014 | ...   |
| 704672-01                 | ...       | ... | 010 | 85938 | ...   |       |

### RIDEWELL CORPORATION





#### Bus and R.V. Air-Rides

|  |             |     |     |     |       |       |
|--|-------------|-----|-----|-----|-------|-------|
| Mobile Home & RV with Air Suspension                         | AS563B      | ... | ... | 010 | 83203 | 89436 |
|  | S6009B      | ... | ... | 010 | 83203 | 89436 |
| RAS - 227 Models Steer Axles Air Suspension w/ O.E.M. Number | 1260008     | ... | ... | 010 | 87017 | ...   |
|  | 90-2610 SP1 | ... | ... | 010 | 87017 | ...   |

#### Trailer Air-Rides

|   |   |       |     |     |       |       |       |
|---|---|-------|-----|-----|-------|-------|-------|
| RAR - 244 FeatherRide Light Duty Air Suspension (8,000 lb Capacity) | 1270007   | ...   | ... | 010 | 85045 | ...   |       |
| RAR-210<br>With Double Convolution Spring                           | AS789B  | ...   | ... | 010 | 85014 | ...   |       |
|   | S5878B  | ...   | ... | 010 | 83207 | 89407 |       |
|   | With Shock Absorber Bracket 2-1/2" Above Frame Rail       | ..... | ... | ... | 010   | 85006 | ...   |
|   | With Shock Absorber Bracket 2-7/8" Above Lower Frame Rail | ..... | ... | ... | 010   | 83207 | 89407 |
|   | With Shock Absorber Bracket 3" Above Lower Frame Rail     | ..... | ... | ... | 010   | 85005 | 89430 |
| RAR-210 For Trailers with 25" Drop                                  | AS546B  | ...   | ... | 010 | 85006 | ...   |       |
|   | 1253069B000   | ...   | ... | 010 | 85005 | 89430 |       |
|   | AS30698   | ...   | ... | 010 | 85005 | 89430 |       |
| RAR-210 Tag Axle  | AS3069B   | ...   | ... | 010 | 85005 | 89430 |       |
|   | AS563B  | ...   | ... | 010 | 83203 | 89436 |       |
| RAR-221 Tag Axle  | S6009B  | ...   | ... | 010 | 83203 | 89436 |       |
|   | AS563B  | ...   | ... | 010 | 83203 | 89436 |       |
| RAR-221 Tag Axle  | AS789B  | ...   | ... | 010 | 85014 | ...   |       |
|   | S5878B  | ...   | ... | 010 | 83207 | 89407 |       |
|   | S6009B  | ...   | ... | 010 | 83203 | 89436 |       |
|   | AS563B  | ...   | ... | 010 | 83203 | 89436 |       |
| RAR-221-11, 12, 13-USW Trailer with Shock Absorber and Hanger       | S6009B  | ...   | ... | 010 | 83203 | 89436 |       |
|   | AS563B  | ...   | ... | 010 | 83203 | 89436 |       |
| RAR-221AS-11-USW, RAR-221AS-11-1-USW Trailer                        | 1253069B000   | ...   | ... | 010 | 85005 | 89430 |       |
|   | AS30698   | ...   | ... | 010 | 85005 | 89430 |       |
|   | AS3069B   | ...   | ... | 010 | 85005 | 89430 |       |
| RAR-221AS-12-USW, RAR-221AS-12-1-USW Trailer                        | 1250546B000   | ...   | ... | 010 | 85006 | ...   |       |
|   | AS546B  | ...   | ... | 010 | 85006 | ...   |       |
| RAR-240, RAR-240W (Mono Pivot Trailers with HD Air Suspension)      |   |       |     |     |       |       |       |
| With O.E.M. Number  | 1270563B000   | ...   | ... | 010 | 85000 | 89436 |       |

**APPLICATION GUIDE - TRUCKS, TRAILERS, AND BUSES**

| Year<br>Año<br>Année | Model<br>Modelo<br>Modèle | OEM # | Front   |   | Rear  |   |
|----------------------|---------------------------|-------|---|---|---|---|
|                      |                           |       |  |  |  |  |
|                      |                           |       | Fleetline   | GasSLX  | Fleetline   | GasSLX  |

**RIDEWELL CORPORATION(Cont'd.)**





**Trailer Air-Rides(Cont'd.)**

|  |             |     |     |     |              |              |
|--|-------------|-----|-----|-----|--------------|--------------|
| With O.E.M. Number   | 1270563B003 | ... | ... | 010 | <b>85934</b> | ...          |
|  | 1270789B000 | ... | ... | 010 | <b>85014</b> | ...          |
| RAR-243 (Mono Pivot Trailers with HD Air Suspension)                 | 1270563B003 | ... | ... | 010 | <b>85934</b> | ...          |
| RAR-260 Overslung Air Suspension (25,000 lb Capacity)                | 1270563B003 | ... | ... | 010 | <b>85934</b> | ...          |
| RAR-260 Underslung Air Suspension (25,000 lb and 30,000 lb Capacity) | 1270563B003 | ... | ... | 010 | <b>85934</b> | ...          |
| RideLite Trailer Air Suspension                                      | 1270563B003 | ... | ... | 010 | <b>85934</b> | ...          |
| Models with O.E.M. Number  | 1275943B    | ... | ... | 010 | <b>85005</b> | <b>89430</b> |
|  | 57645       | ... | ... | 010 | <b>85005</b> | <b>89430</b> |
|  | 665526      | ... | ... | 010 | <b>85014</b> | ...          |

**Truck Air-Rides**

|   |             |     |              |              |              |              |
|---|-------------|-----|--------------|--------------|--------------|--------------|
| Fire Truck with Ridewell Front Suspension   | AS 4025B    | 010 | <b>85712</b> | ...          | ...          | ...          |
| Pusher w/Axle Lift  | AS563B      | ... | ...          | 010          | <b>83203</b> | <b>89436</b> |
|   | S6009B      | ... | ...          | 010          | <b>83203</b> | <b>89436</b> |
| RAD-221R Drive Axle   | S2607B      | ... | ...          | 010          | <b>85702</b> | ...          |
|   | S5477B      | ... | ...          | 010          | <b>85307</b> | ...          |
| RCA-215 Models Air Suspension<br>(RCA-215 LM, RCA-215 MM)                               | 1250789B000 | ... | ...          | 010          | <b>85014</b> | ...          |
| RD-202B Tandem Drive Axle   | S5478B      | ... | ...          | 010          | <b>85307</b> | ...          |
| RD-202S-54-48-BS Tandem Drive Air Suspension  | 1252607B000 | ... | ...          | 010          | <b>85702</b> | ...          |
| RD-202S-54-52T-SR Tandem Drive Air Suspension   | 1252607B000 | ... | ...          | 010          | <b>85702</b> | ...          |
| RSS-236, RSS-236R Self Steering Tag/Pusher Lift Axle (For 13000 lb & 16000 lb Capacity) | 1253069B000 | ... | ...          | 010          | <b>85005</b> | <b>89430</b> |
|   | AS30698     | ... | ...          | 010          | <b>85005</b> | <b>89430</b> |
|   | AS3069B     | ... | ...          | 010          | <b>85005</b> | <b>89430</b> |
| RUA-220B-1-, 10, 10.5, 11, 11.5, 12, 12.5, 13 (Lift Tag Axle & Trailer Lift Suspension) | 1250789B000 | ... | ...          | 010          | <b>85014</b> | ...          |
|   | AS789B000   | ... | ...          | 010          | <b>85014</b> | ...          |
| RUA-220B-1-, 7, 7.5, 8, 8.5, 9, 9.5, 10 (Lift Tag Axle & Trailer Lift Suspension)       | 1270563B000 | ... | ...          | 010          | <b>85000</b> | <b>89436</b> |
| Models with O.E.M. Number   | 1250563B000 | ... | ...          | 010          | <b>85000</b> | <b>89436</b> |
|   | 1253069B000 | ... | ...          | 010          | <b>85005</b> | <b>89430</b> |
|   | 1254190B000 | ... | ...          | 010          | <b>85302</b> | <b>89420</b> |
|   | 1265157B000 | ... | ...          | 010          | <b>85712</b> | ...          |
|   | 1266009B000 | ... | ...          | 010          | <b>83130</b> | ...          |
|   | 1267120B000 | ... | ...          | 010          | <b>85734</b> | ...          |
|   | 1267395B000 | ... | ...          | 010          | <b>85302</b> | <b>89420</b> |
|   | 1275813B000 | ... | ...          | 010          | <b>85704</b> | ...          |
|   | 665198      | ... | ...          | 010          | <b>85005</b> | <b>89430</b> |
|   | 665267      | ... | ...          | 010          | <b>85029</b> | ...          |
|   | 680101      | ... | ...          | 010          | <b>85702</b> | ...          |
|   | 70654       | ... | ...          | 010          | <b>85000</b> | <b>89436</b> |
|   | 90-1813     | ... | ...          | 010          | <b>85712</b> | ...          |
|   | AS575B      | ... | ...          | 010          | <b>85005</b> | <b>89430</b> |
|   | S4025B      | ... | ...          | 010          | <b>85712</b> | ...          |
|   | S5813B      | ... | ...          | 010          | <b>85704</b> | ...          |
|   | S7120B      | ... | ...          | 010          | <b>85304</b> | ...          |
| S7172B  | ...         | ... | 010          | <b>83207</b> | <b>89407</b> |              |
| S7249B  | ...         | ... | 010          | <b>85307</b> | ...          |              |
| S7365B  | ...         | ... | 010          | <b>85305</b> | ...          |              |
| Additional O.E.M. Interchanges  | 1250005     | 010 | <b>85901</b> |              |              |              |
|   | 1254025B000 | 010 | <b>85712</b> |              |              |              |
|   | 1265478B000 | 010 | <b>85736</b> |              |              |              |
|   | 1267249B000 | 010 | <b>85712</b> |              |              |              |

## APPLICATION GUIDE - TRUCKS, TRAILERS, AND BUSES

| Year<br>Año<br>Année | Model<br>Modelo<br>Modèle | OEM # | Front   |  |           | Rear   |   |   |
|----------------------|---------------------------|-------|---|--|-----------|--------|---|---|
|                      |                           |       |  |  | Fleetline | GasSLX |  |  |
|                      |                           |       |   |  |           |        |   |   |

### ROADMASTER (MONACO)

|   |          |  |     |     |     |  |              |     |
|---|----------|--|-----|-----|-----|--|--------------|-----|
| Models with AD-123 Models Suspension (AD123-6,-8,-10,-8.75) | 90045132 |  | ... | ... | 010 |  | <b>85909</b> | ... |
| Models with O.E.M. Number                                   | 90045188 |  | ... | ... | 010 |  | <b>85910</b> | ... |





### SAF HOLLAND

#### Trailer Air Suspension

|   |          |     |     |     |     |              |              |              |
|---|----------|-----|-----|-----|-----|--------------|--------------|--------------|
| AirLite 2 Model Trailer Air Suspension  | 90044025 |     | ... | ... | 010 |              | <b>83209</b> | <b>89414</b> |
| AR-120 Models Trailer Air Suspension<br>(AR-120, AR-120-L, AR-120-US, AR-120-US-F)<br>(AR-120-US-L, -1, -2, -3)                 | 90044626 |     | ... | ... | 010 |              | <b>83126</b> | <b>89430</b> |
|   | 90044625 |     | ... | ... | 010 |              | <b>83125</b> | ...          |
| AR-125 Models Trailer Air Suspension<br>(AR-125, AR-125-L, AR-125-US, AR-125-US-F)<br>(AR-125-US-L, -1, -2, -3)                 | 90044626 |     | ... | ... | 010 |              | <b>83126</b> | <b>89430</b> |
|   | 90044625 |     | ... | ... | 010 |              | <b>83125</b> | ...          |
| AR-165-US Models Trailer Air Suspension (AR165-US)  | 90044626 |     | ... | ... | 010 |              | <b>83126</b> | <b>89430</b> |
| AR-250 Models Trailer Air Suspension<br>(AR-250-12)<br>(AR-250-14, -15)<br>(AR-250-16, -17)                                     | 90045054 |     | ... | ... | 010 |              | <b>85051</b> | ...          |
|   | 90044642 |     | ... | ... | 010 |              | <b>83127</b> | ...          |
|   | 90044089 |     | ... | ... | 010 |              | <b>83124</b> | <b>89407</b> |
| AR-41 Models Trailer Air Suspension<br>(All)  | 90044162 |     | ... | ... | 010 |              | <b>83128</b> | <b>89436</b> |
| AR-45 Models Trailer Air Suspension<br>(AR-45, AR-45-1)   | 90044162 |     | ... | ... | 010 |              | <b>83128</b> | <b>89436</b> |
| AR-50 Models Trailer Air Suspension<br>(AR-50-US, AR-50-US-F,-1,-2)   | 90044162 |     | ... | ... | 010 |              | <b>83128</b> | <b>89436</b> |
| AR-51 Models Trailer Air Suspension (AR51-US)   | 90044162 |     | ... | ... | 010 |              | <b>83128</b> | <b>89436</b> |
| AR-70 Models Trailer Air Suspension<br>(AR-70-9, -14, AR-70A-9, 14)   | 90044626 |     | ... | ... | 010 |              | <b>83126</b> | <b>89430</b> |
| AR-75 Models Trailer Air Suspension<br>(AR-75-12)<br>(AR-75-6, -9, -1-12)   | 90044625 |     | ... | ... | 010 |              | <b>83125</b> | ...          |
|   | 90044626 |     | ... | ... | 010 |              | <b>83126</b> | <b>89430</b> |
| AR-80 Models Trailer Air Suspension<br>(AR-80-6.75)<br>(AR-80-9, -9FM)<br>(AR-80-9-WST)   | 90044046 |     | ... | ... | 010 |              | <b>83123</b> | <b>89405</b> |
|   | 90044868 |     | ... | ... | 010 |              | <b>85045</b> | ...          |
|   | 90044626 |     | ... | ... | 010 |              | <b>83126</b> | <b>89430</b> |
| AR-85-A Models Trailer Air Suspension<br>(AR-85-A)  | 90044625 |     | ... | ... | 010 |              | <b>83125</b> | ...          |
| AR-90 Models Trailer Air Suspension<br>(AR-90-14, -15, -16, -17)  | 90044089 |     | ... | ... | 010 |              | <b>83124</b> | <b>89407</b> |
| AR-90-1 Models Trailer Air Suspension<br>(AR-90-1-12, -14, -17)<br>(AR-90-1-15, -16)  | 90044162 |     | ... | ... | 010 |              | <b>83128</b> | <b>89436</b> |
|   | 90044448 |     | ... | ... | 010 |              | <b>85051</b> | ...          |
|   | 90045054 |     | ... | ... | 010 |              | <b>85051</b> | ...          |
| AR-92 Models Trailer Air Suspension<br>(AR-92-12)<br><br>(AR-92-14)<br>(AR-92-15)<br><br>(AR-92-16)<br>(AR-92-17)<br>(AR-92-18) | 90044162 |     | ... | ... | 010 |              | <b>83128</b> | <b>89436</b> |
|   | 90044992 |     | ... | ... | 010 |              | <b>85000</b> | <b>89436</b> |
|   | 90045040 |     | ... | ... | 010 |              | <b>83130</b> | ...          |
|   | 90044448 |     | ... | ... | 010 |              | <b>85051</b> | ...          |
|   | 90045054 |     | ... | ... | 010 |              | <b>85051</b> | ...          |
|   | 90044794 |     | ... | ... | 010 |              | <b>83127</b> | ...          |
|   | 90044642 |     | ... | ... | 010 |              | <b>83127</b> | ...          |
|   | 90044089 |     | ... | ... | 010 |              | <b>83124</b> | <b>89407</b> |
| 90044769  |          | ... | ... | 010 |     | <b>83207</b> | <b>89407</b> |              |
| AR-93 Models Trailer Air Suspension<br>(AR-93-14)<br><br>(AR-93-15)   | 90044448 |     | ... | ... | 010 |              | <b>85051</b> | ...          |
|   | 90045054 |     | ... | ... | 010 |              | <b>85051</b> | ...          |
|   | 90044794 |     | ... | ... | 010 |              | <b>83127</b> | ...          |



**APPLICATION GUIDE - TRUCKS, TRAILERS, AND BUSES**





| Year<br>Año<br>Année | Model<br>Modelo<br>Modèle | OEM # | Front   |   | Rear  |   |
|----------------------|---------------------------|-------|---|---|---|---|
|                      |                           |       |  |  |  |  |
|                      |                           |       | Fleetline   | GasSLX  | Fleetline   | GasSLX  |

**SAF HOLLAND(Cont'd.)**

**Trailer Air Suspension(Cont'd.)**

|  |  |          |     |     |     |       |       |
|--|--|----------|-----|-----|-----|-------|-------|
|  | (AR-93-16)   | 90044642 | ... | ... | 010 | 83127 | ...   |
|  | (AR-93-17)   | 90044089 | ... | ... | 010 | 83124 | 89407 |
|  |  | 90044769 | ... | ... | 010 | 83207 | 89407 |
|  | AR-94 Models Trailer Air Suspension  | 90045028 | ... | ... | 010 | 85907 | ...   |
|  |  | 90045048 | ... | ... | 010 | 85905 | ...   |
|  |  | 90045049 | ... | ... | 010 | 85905 | ...   |
|  | AR-95 Models Trailer Air Suspension<br>(AR-95-9, -12, -14, -17, All -HD Models, AR-95A-9, -12, -14, -17)           | 90044625 | ... | ... | 010 | 83125 | ...   |
|  | AR-955 Models Trailer Air Suspension (Liftaxle)<br>(AR-955-9, -12, -14, -17)                                       | 90044625 | ... | ... | 010 | 83125 | ...   |
|  | (AR-955-9HD, -12HD, -14HD, -17HD)  | 90044625 | ... | ... | 010 | 83125 | ...   |
|  | (AR-955A-9, -12, -14, -17)   | 90044625 | ... | ... | 010 | 83125 | ...   |
|  | (AR-955A-9HD, -12HD, -14HD, -17HD)   | 90044625 | ... | ... | 010 | 83125 | ...   |
|  | ARA-93 Models Trailer Air Suspension (ARA-93-14)   | 90045054 | ... | ... | 010 | 85051 | ...   |
|  | ARL20 Models Trailer Air Suspension (ARL20-D, ARL20-D-US)  | 90044162 | ... | ... | 010 | 83128 | 89436 |
|  | ARS112 Models Trailer Air Suspension (ARS112-6)  | 90045096 | ... | ... | 010 | 85916 | 89430 |
|  | ARU-92 Models Trailer Air Suspension<br>(ARU-92-8, -9, -10, -12)   | 90044642 | ... | ... | 010 | 83127 | ...   |
|  | ARU-93 Models Trailer Air Suspension<br>(ARU-93-6)   | 90045040 | ... | ... | 010 | 83130 | ...   |
|  | (ARU-93-7, -8, -9, -10)  | 90044642 | ... | ... | 010 | 83127 | ...   |
|  | ARU-98 Models Trailer Air Suspension<br>(ARU-98-17)  | 90045054 | ... | ... | 010 | 85051 | ...   |
|  | CB 25Y/CBX 25Y Models with Fusion Axle and Beam Assembly (10.0" Ride Height)                                       | 90044162 | ... | ... | 010 | 83128 | 89436 |
|  | CB 25Y/CBX 25Y Models with Fusion Axle and Beam Assembly (12.0" Ride Height)                                       | 90045040 | ... | ... | 010 | 83130 | ...   |
|  | CB 25Y/CBX 25Y Models with Fusion Axle and Beam Assembly (7.0" Ride Height)  | 90044868 | ... | ... | 010 | 85045 | ...   |
|  | CB 25Y/CBX 25Y Models with Fusion Axle and Beam Assembly (8.0" Ride Height)  | 90045381 | ... | ... | 010 | 83150 | ...   |
|  | CB 25Y/CBX 25Y Models with Fusion Axle and Beam Assembly (9.0" Ride Height)  | 90045608 | ... | ... | 010 | 83363 | ...   |
|  | CB-2300 Models Trailer Air Suspension<br>(CB-2300-14)  | 90044868 | ... | ... | 010 | 85045 | ...   |
|  | (CB-2300-15)   | 90045381 | ... | ... | 010 | 83150 | ...   |
|  | CB-2300 Models Trailer Air Suspension (16.0" & 17.0" Ride Height)  | 90045298 | ... | ... | 010 | 83363 | ...   |
|  | CB-400/4000 Models Trailer Air Suspension<br>15.5" & 16.0" Ride Height (CB-400-15.5, CB-400-16.0)                  | 90045298 | ... | ... | 010 | 83363 | ...   |
|  | 16.5" & 17.0" Ride Height (CB-400-16.5, CB-400-17.0)   | 90044162 | ... | ... | 010 | 83128 | 89436 |
|  | 18.0" Ride Height (CB-400-18.0)  | 90045040 | ... | ... | 010 | 83130 | ...   |
|  | CBX 23 & CBX 25 Models Trailer Air Suspension (16.0" & 17.0" Ride Height)  | 90045298 | ... | ... | 010 | 83363 | ...   |
|  | CBX 23 Models Trailer Air Suspension<br>(CBX 23-14)  | 90044868 | ... | ... | 010 | 85045 | ...   |
|  | (CBX 23-15)  | 90045381 | ... | ... | 010 | 83150 | ...   |
|  | CBX 23 Models with 245 or 317 Fusion Axle and Beam Assembly<br>For Bracket Type #1, 3, 4, & 5 - 15.0" Ride Height  | 90045608 | ... | ... | 010 | 83363 | ...   |
|  | CBX 23 with 245 or 317 Fusion Axle and Beam Assembly<br>For Bracket Type #1, 3, 4, & 5 - 16.0" & 17.0" Ride Height | 90045299 | ... | ... | 010 | 83389 | 89436 |
|  | CBX 23U Models with 342 Fusion Axle and Beam Assembly (8.0" Ride Height)   | 90045608 | ... | ... | 010 | 83363 | ...   |
|  | CBX 25 Models Trailer Air Suspension<br>(CBX 25-14)  | 90045607 | ... | ... | 010 | 83150 | ...   |
|  | (CBX 25-16, CBX 25-17)   | 90045040 | ... | ... | 010 | 83130 | ...   |

**APPLICATION GUIDE - TRUCKS, TRAILERS, AND BUSES**





| Year<br>Año<br>Année | Model<br>Modelo<br>Modèle | OEM # | Front  |   | Rear      |        |
|----------------------|---------------------------|-------|--|---|-----------|--------|
|                      |                           |       |   |   | Fleetline | GasSLX |

**SAF HOLLAND(Cont'd.)**

**Trailer Air Suspension(Cont'd.)**

|  |          |     |     |     |              |              |
|--|----------|-----|-----|-----|--------------|--------------|
| CBX 25 Models with 245 or 338 Fusion Axle and Beam Assembly (15.0" Ride Height)                              | 90045608 | ... | ... | 010 | <b>83363</b> | ...          |
| CBX 25 with 245 Fusion Axle and Beam Assembly (16.0" & 17.0" Ride Height)                                    | 90045299 | ... | ... | 010 | <b>83389</b> | <b>89436</b> |
| CBX 25U-4 Models with 342 Fusion Axle and Beam Assembly (9.0" Ride Height)                                   | 90045608 | ... | ... | 010 | <b>83363</b> | ...          |
| CBX 30 Models with 245 or 338 Fusion Axle and Beam Assembly (15.0" Ride Height)                              | 90045608 | ... | ... | 010 | <b>83363</b> | ...          |
| CBX 30 with 245 Fusion Axle and Beam Assembly (16.0" & 17.0" Ride Height)                                    | 90045299 | ... | ... | 010 | <b>83389</b> | <b>89436</b> |
| CBX 40 Models Trailer Air Suspension<br>(CBX 40 -16.5, CBX 40 -17.0)<br>(CBX 40-18.0)                        | 90044162 | ... | ... | 010 | <b>83128</b> | <b>89436</b> |
|  | 90045040 | ... | ... | 010 | <b>83130</b> | ...          |
| CBX 40 Models with 265 Fusion Axle and Beam Assembly (15.5" & 16.0" Ride Height)                             | 90045298 | ... | ... | 010 | <b>83363</b> | ...          |
| CBX 46 Models Trailer Air Suspension (16" Ride Height)   | 90045298 | ... | ... | 010 | <b>83363</b> | ...          |
| CBX 46 Models Trailer Air Suspension (16.5" & 17.0" Ride Height)   | 90044162 | ... | ... | 010 | <b>83128</b> | <b>89436</b> |
| CBX 50 Models Trailer Air Suspension (16" Ride Height)   | 90045298 | ... | ... | 010 | <b>83363</b> | ...          |
| CBX 50 Models Trailer Air Suspension (16.5" & 17.0" Ride Height)   | 90044162 | ... | ... | 010 | <b>83128</b> | <b>89436</b> |
| CBX 69 Trailer Air Suspension  | 90045669 | ... | ... | 010 | <b>83389</b> | <b>89436</b> |
| NL-200 Models Non Steer - Auxiliary Lift Air Suspension<br>(NL-200-1S, NL-200-2S)                            | 90044162 | ... | ... | 010 | <b>83128</b> | <b>89436</b> |
|  |          |     |     |     |              |              |
| NS-190 Models Trailer Air Suspension<br>(NS-190-16.0)<br>(NS-190-16.5, NS-190-17.0)<br>(NS-190-18.0)         | 90044162 | ... | ... | 010 | <b>83128</b> | <b>89436</b> |
|  | 90045040 | ... | ... | 010 | <b>83130</b> | ...          |
|  | 90045054 | ... | ... | 010 | <b>85051</b> | ...          |
| NS-400 Models Trailer Air Suspension<br>(NS-400-16.0)<br>(NS-400-16.5)<br>(NS-400-18.0)                      | 90045298 | ... | ... | 010 | <b>83363</b> | ...          |
|  | 90044162 | ... | ... | 010 | <b>83128</b> | <b>89436</b> |
|  | 90045040 | ... | ... | 010 | <b>83130</b> | ...          |
| NS-400 Models Trailer Air Suspension (17.0" Ride Height)   | 90045299 | ... | ... | 010 | <b>83389</b> | <b>89436</b> |
| NS-450 Models Trailer Air Suspension<br>(NS-450-16.0)<br>(NS-450-16.5)<br>(NS-450-18.0)                      | 90045298 | ... | ... | 010 | <b>83363</b> | ...          |
|  | 90044162 | ... | ... | 010 | <b>83128</b> | <b>89436</b> |
|  | 90045040 | ... | ... | 010 | <b>83130</b> | ...          |
| NS-450 Models Trailer Air Suspension (17.0" Ride Height)   | 90045299 | ... | ... | 010 | <b>83389</b> | <b>89436</b> |
| RL-196 Models Trailer Air Suspension<br>(RL-196-12)<br>(RL-196-14, -15)<br>(RL-196-16, -17)                  | 90044977 | ... | ... | 010 | <b>83115</b> | ...          |
|  | 90044978 | ... | ... | 010 | <b>85059</b> | ...          |
|  | 90044979 | ... | ... | 010 | <b>83113</b> | ...          |
| RL-196A Models Trailer Air Suspension<br>(RL-196A-12)<br>(RL-196A-14, -15)<br>(RL-196A-16, -17)              | 90044162 | ... | ... | 010 | <b>83128</b> | <b>89436</b> |
|  | 90045040 | ... | ... | 010 | <b>83130</b> | ...          |
|  | 90044794 | ... | ... | 010 | <b>83127</b> | ...          |
| RL-228 Models Trailer Air Suspension<br>(RL-228-12-3)<br>(RL-228-14-3, -14-4, -15-3, -16-3)<br>(RL-228-17-3) | 90044162 | ... | ... | 010 | <b>83128</b> | <b>89436</b> |
|  | 90044642 | ... | ... | 010 | <b>83127</b> | ...          |
|  | 90044089 | ... | ... | 010 | <b>83124</b> | <b>89407</b> |
| RL-230 Models Trailer Air Suspension<br>(RL-230-12-3)<br>(RL-230-14-3, -15-3)<br>(RL-230-16-3, -17-3)        | 90045381 | ... | ... | 010 | <b>83150</b> | ...          |
|  | 90044642 | ... | ... | 010 | <b>83127</b> | ...          |
|  | 90044089 | ... | ... | 010 | <b>83124</b> | <b>89407</b> |
| RL-230 Models Trailer Air Suspension (Hanger Mounted Shock)<br>(RL-230-14-3, -15-4)<br>(RL-230-16-4)         | 90045381 | ... | ... | 010 | <b>83150</b> | ...          |
|  | 90045299 | ... | ... | 010 | <b>83389</b> | <b>89436</b> |

**APPLICATION GUIDE - TRUCKS, TRAILERS, AND BUSES**





| Year<br>Año<br>Année | Model<br>Modelo<br>Modèle | OEM # | Front   |   | Rear  |   |
|----------------------|---------------------------|-------|---|---|---|---|
|                      |                           |       |  |  |  |  |
|                      |                           |       | Fleetline   | GasSLX  | Fleetline   | GasSLX  |

**SAF HOLLAND(Cont'd.)**

**Trailer Air Suspension(Cont'd.)**

|  |  |          |     |     |     |       |       |
|--|--|----------|-----|-----|-----|-------|-------|
|  | (RL-230-17-4)  | 90045040 | ... | ... | 010 | 83130 | ...   |
|  | RL-230 Models Trailer Air Suspension (Single Stud Air Spring)                            |          |     |     |     |       |       |
|  | (RL-230-14-3, -15-4, -16-4)  | 90044642 | ... | ... | 010 | 83127 | ...   |
|  | (RL-230-17-4)  | 90044089 | ... | ... | 010 | 83124 | 89407 |
|  | RL-250 Models Trailer Air Suspension (Shock Below Frame)                                 |          |     |     |     |       |       |
|  | (RL-250-14-3, -15-4)   | 90045040 | ... | ... | 010 | 83130 | ...   |
|  | (RL-250-16-4, -17-4)   | 90045299 | ... | ... | 010 | 83389 | 89436 |
|  | RL-250 Models Trailer Air Suspension (Std Suspension)                                    |          |     |     |     |       |       |
|  | (RL-250-12)  | 90045054 | ... | ... | 010 | 85051 | ...   |
|  | (RL-250-14.0, -15.0)   | 90044642 | ... | ... | 010 | 83127 | ...   |
|  | (RL-250-16.0, -17.0)   | 90044089 | ... | ... | 010 | 83124 | 89407 |
|  | RL-300 Models Trailer Air Suspension (Offset Stud Air Spring)                            |          |     |     |     |       |       |
|  | (RL-300-13)  | 90045054 | ... | ... | 010 | 85051 | ...   |
|  | (RL-300-14, -15, -16, -17)   | 90045338 | ... | ... | 010 | 85060 | ...   |
|  | RL-300 Models Trailer Air Suspension (Std Suspension)                                    |          |     |     |     |       |       |
|  | (RL-300-12, -13)   | 90045054 | ... | ... | 010 | 85051 | ...   |
|  | (RL-300-14, -15, -16, -17)   | 90045338 | ... | ... | 010 | 85060 | ...   |
|  | RLSA Models Trailer Air Suspension (RLSA-4212, -4812)                                    | 90044977 | ... | ... | 010 | 83115 | ...   |
|  | RLSA Models Trailer Air Suspension (RLSA-4214, -4215, -4814, -4815)                      | 90044978 | ... | ... | 010 | 85059 | ...   |
|  | RLSA Models Trailer Air Suspension (RLSA-4216, -4217, -4816, -4817)                      | 90044979 | ... | ... | 010 | 83113 | ...   |
|  | RLSA228 Models Trailer Air Suspension (RLSA-228-4214, -4215, -4216, -4814, -4815, -4816) | 90044642 | ... | ... | 010 | 83127 | ...   |
|  | RLSA228 Models Trailer Air Suspension (RLSA-228-4217, -4817)                             | 90044089 | ... | ... | 010 | 83124 | 89407 |
|  | RLU-228 Models Trailer Air Suspension  |          |     |     |     |       |       |
|  | (RLU-228-10-3)   | 90044089 | ... | ... | 010 | 83124 | 89407 |
|  | (RLU-228-6-3)  | 90045040 | ... | ... | 010 | 83130 | ...   |
|  | (RLU-228-7-3)  | 90044642 | ... | ... | 010 | 83127 | ...   |
|  | (RLU-228-8-3, RLU-228-9-3)   | 90044626 | ... | ... | 010 | 83126 | 89430 |
|  | RLU-228 Models Trailer Air Suspension (Axle Mounted Shock Suspension)                    |          |     |     |     |       |       |
|  | (RLU-228-8-3)  | 90044162 | ... | ... | 010 | 83128 | 89436 |
|  | (RLU-228-9-3, RLU-228-10-3, RLU-228-12-3)  | 90044642 | ... | ... | 010 | 83127 | ...   |
|  | RLU-228 Models Trailer Air Suspension (Current Production - w/3" Axle Travel Up)         |          |     |     |     |       |       |
|  | (RLU-228-10-3, RLU-228-12-3)   | 90044642 | ... | ... | 010 | 83127 | ...   |
|  | (RLU-228-6-3)  | 90045298 | ... | ... | 010 | 83363 | ...   |
|  | (RLU-228-7-3)  | 90044162 | ... | ... | 010 | 83128 | 89436 |
|  | (RLU-228-8-3)  | 90045040 | ... | ... | 010 | 83130 | ...   |
|  | (RLU-228-9-3)  | 90045054 | ... | ... | 010 | 85051 | ...   |
|  | RLU-228 Models Trailer Air Suspension (Current Production - w/4" Axle Travel Up)         |          |     |     |     |       |       |
|  | (RLU-228-10-4)   | 90044642 | ... | ... | 010 | 83127 | ...   |
|  | (RLU-228-8-4)  | 90044162 | ... | ... | 010 | 83128 | 89436 |
|  | (RLU-228-9-4, RLU-228-12-4)  | 90044626 | ... | ... | 010 | 83126 | 89430 |
|  | RLU-228 Models Trailer Air Suspension (Current Production - w/4" Axle Travel Up) HVY DTY |          |     |     |     |       |       |
|  | (RLU-228-8-4)  | 90045337 | ... | ... | 010 | 85911 | ...   |
|  | RLU-250 Models Trailer Air Suspension  |          |     |     |     |       |       |
|  | (RLU-250-12)   | 90044642 | ... | ... | 010 | 83127 | ...   |
|  | (RLU-250-6.5)  | 90045381 | ... | ... | 010 | 83150 | ...   |
|  | (RLU-250-9)  | 90044162 | ... | ... | 010 | 83128 | 89436 |
|  | RLU-250 Models Trailer Air Suspension (Frame Mount Suspension)                           |          |     |     |     |       |       |
|  | (RLU-250-12-FMT)   | 90045054 | ... | ... | 010 | 85051 | ...   |
|  | (RLU-250-6.5-FMT)  | 90045381 | ... | ... | 010 | 83150 | ...   |

**APPLICATION GUIDE - TRUCKS, TRAILERS, AND BUSES**

| Year<br>Año<br>Année | Model<br>Modelo<br>Modèle | OEM # | Front  |  | Rear  |   |
|----------------------|---------------------------|-------|--|--|---|---|
|                      |                           |       |  |  |  |  |
|                      |                           |       | Fleetline  | GasSLX   | Fleetline   | GasSLX  |

**SAF HOLLAND(Cont'd.)**





**Trailer Air Suspension(Cont'd.)**

|  |               |     |     |     |              |              |
|--|---------------|-----|-----|-----|--------------|--------------|
| (RLU-250-9-FMT)  | 90044162      | ... | ... | 010 | <b>83128</b> | <b>89436</b> |
| RLU-300 Models Trailer Air Suspension (Std Suspension) |               |     |     |     |              |              |
| (RLU-300-6.5)  | 90045471      | ... | ... | 010 | <b>83150</b> | ...          |
| (RLU-300-9)  | 90045337      | ... | ... | 010 | <b>85911</b> | ...          |
| Trailer Air Suspension (RL196-16,-17)                  | 90044979      | ... | ... | 010 | <b>83113</b> | ...          |
| Models with O.E.M. Number                              |               |     |     |     |              |              |
|  | 665454        | ... | ... | 010 | <b>85045</b> | ...          |
|  | 671931        | ... | ... | 010 | <b>85916</b> | <b>89430</b> |
|  | 680234        | ... | ... | 010 | <b>85906</b> | <b>89407</b> |
|  | 680268        | ... | ... | 010 | <b>85323</b> | <b>89436</b> |
|  | 90044980      | ... | ... | 010 | <b>85907</b> | ...          |
|  | 90045000      | ... | ... | 010 | <b>85906</b> | <b>89407</b> |
|  | 90045001      | ... | ... | 010 | <b>85323</b> | <b>89436</b> |
|  | 90045002      | ... | ... | 010 | <b>85906</b> | <b>89407</b> |
|  | 90045003      | ... | ... | 010 | <b>85323</b> | <b>89436</b> |
|  | 90045080      | ... | ... | 010 | <b>85912</b> | ...          |
|  | 90045083      | ... | ... | 010 | <b>85910</b> | ...          |
|  | 90045188      | ... | ... | 010 | <b>85910</b> | ...          |
|  | 90045207      | ... | ... | 010 | ...          | <b>89405</b> |
|  | 90045433      | ... | ... | 010 | <b>85916</b> | <b>89430</b> |
|  | 90045563      | ... | ... | 010 | <b>85014</b> | ...          |
|  | 90045564      | ... | ... | 010 | <b>83128</b> | <b>89436</b> |
|  | 90045572      | ... | ... | 010 | <b>85045</b> | ...          |
|  | 90045574      | ... | ... | 010 | <b>83130</b> | ...          |
|  | 90045575      | ... | ... | 010 | <b>85051</b> | ...          |
|  | 90045576      | ... | ... | 010 | <b>83150</b> | ...          |
|  | 90045665      | ... | ... | 010 | <b>85029</b> | ...          |
|  | 90045667      | ... | ... | 010 | <b>85060</b> | ...          |
|  | XB-SPN-053-36 | ... | ... | 010 | <b>83125</b> | ...          |
| Models with O.E.M. Number (Hvy Duty)                   | 90045666      | ... | ... | 010 | <b>85051</b> | ...          |
| Models with O.E.M. Number (STD)                        | 90045666      | ... | ... | 010 | <b>83130</b> | ...          |

**Truck & Tractor Air Suspension (Tag Axle)**

|                           |           |     |     |     |              |              |
|---------------------------|-----------|-----|-----|-----|--------------|--------------|
| Models with O.E.M. Number |           |     |     |     |              |              |
|                           | 57639     | ... | ... | 010 | <b>85000</b> | <b>89436</b> |
|                           | 57643     | ... | ... | 010 | <b>85013</b> | <b>89414</b> |
|                           | 6025      | ... | ... | 010 | <b>83122</b> | <b>89406</b> |
|                           | 6026      | ... | ... | 010 | <b>83204</b> | ...          |
|                           | 665197    | ... | ... | 010 | <b>85051</b> | ...          |
|                           | 665514    | ... | ... | 010 | <b>83127</b> | ...          |
|                           | 665969    | ... | ... | 010 | ...          | <b>89430</b> |
|                           | 90044001  | ... | ... | 010 | <b>85005</b> | <b>89430</b> |
|                           | 90044071  | ... | ... | 010 | <b>85000</b> | <b>89436</b> |
|                           | 90044081  | ... | ... | 010 | <b>85000</b> | <b>89436</b> |
|                           | 90044086  | ... | ... | 010 | <b>85000</b> | <b>89436</b> |
|                           | 90044089C | ... | ... | 010 | <b>83124</b> | <b>89407</b> |
|                           | 90044095  | ... | ... | 010 | <b>83203</b> | <b>89436</b> |
|                           | 90044679  | ... | ... | 010 | <b>83122</b> | <b>89406</b> |
|                           | 90044680  | ... | ... | 010 | <b>83125</b> | ...          |
|                           | 90044681  | ... | ... | 010 | <b>83204</b> | ...          |
|                           | 90044682  | ... | ... | 010 | <b>83209</b> | <b>89414</b> |
|                           | 90044683  | ... | ... | 010 | <b>83122</b> | <b>89406</b> |
|                           | 90044684  | ... | ... | 010 | <b>83124</b> | <b>89407</b> |
|                           | 90044685  | ... | ... | 010 | <b>83389</b> | <b>89436</b> |
|                           | 90044686  | ... | ... | 010 | <b>85051</b> | ...          |
|                           | 90044687  | ... | ... | 010 | <b>83125</b> | ...          |
|                           | 90044688  | ... | ... | 010 | <b>83122</b> | <b>89406</b> |

**APPLICATION GUIDE - TRUCKS, TRAILERS, AND BUSES**

| Year<br>Año<br>Année | Model<br>Modelo<br>Modèle | OEM # | Front   |   | Rear  |   |
|----------------------|---------------------------|-------|---|---|---|---|
|                      |                           |       |  |  |  |  |
|                      |                           |       | Fleetline   | GasSLX  | Fleetline   | GasSLX  |

**SAF HOLLAND(Cont'd.)**





**Truck & Tractor Air Suspension (Tag Axle)(Cont'd.)**

| Year | Model                     | OEM #       | Fleetline | GasSLX | Fleetline | GasSLX      |
|------|---------------------------|-------------|-----------|--------|-----------|-------------|
|      | Models with O.E.M. Number | 90044770    | ...       | ...    | 010       | 83207 89407 |
|      |                           | 90044833    | ...       | ...    | 010       | 85052 ...   |
|      |                           | 90044834    | ...       | ...    | 010       | 85052 ...   |
|      |                           | 90044878    | ...       | ...    | 01-       | 83635 ...   |
|      |                           | 90044915    | ...       | ...    | 010       | 83127 ...   |
|      |                           | 90044981    | ...       | ...    | 010       | 85000 89436 |
|      |                           | 90044982    | ...       | ...    | 010       | 85000 89436 |
|      |                           | 90044991    | ...       | ...    | 010       | 85000 89436 |
|      |                           | 90045110    | ...       | ...    | 010       | 83137 ...   |
|      |                           | 90045175    | ...       | ...    | 010       | 85916 89430 |
|      |                           | 90045384    | ...       | ...    | 010       | ... 89430   |
|      |                           | AR-1008     | ...       | ...    | 010       | 85006 ...   |
|      |                           | AR-1141     | ...       | ...    | 010       | 83204 ...   |
|      |                           | AR-1141-C   | ...       | ...    | 010       | 83204 ...   |
|      |                           | AR-1202     | ...       | ...    | 010       | 85300 89419 |
|      |                           | AR-134-C    | ...       | ...    | 010       | 85005 89430 |
|      |                           | AR-1404     | ...       | ...    | 010       | 85301 ...   |
|      |                           | AR-1425     | ...       | ...    | 010       | 85301 ...   |
|      |                           | AR-1434     | ...       | ...    | 010       | 83203 89436 |
|      |                           | AR-1654     | ...       | ...    | 010       | 83209 89414 |
|      |                           | AR-1822     | ...       | ...    | 010       | 85304 ...   |
|      |                           | AR-2451     | ...       | ...    | 010       | 83203 89436 |
|      |                           | AR-2598     | ...       | ...    | 010       | 83123 89405 |
|      |                           | AR-718-C    | ...       | ...    | 010       | 83203 89436 |
|      |                           | AR-718-C-HD | ...       | ...    | 010       | 85000 89436 |
|      |                           | AR-781      | ...       | ...    | 010       | 83203 89436 |
|      |                           | AR-958      | ...       | ...    | 010       | 83207 89407 |
|      |                           | AR-995      | ...       | ...    | 010       | 85734 ...   |

**Truck, Bus & Motorhome Air Suspensions**

|      |   |          |     |     |     |             |
|------|---|----------|-----|-----|-----|-------------|
|      | AD-123 Models Truck and Tractor Air Suspension (AD123-6,-8,-10,-8.75)   | 90045068 | ... | ... | -10 | ... 89441   |
|      | AD-123 Models Truck and Tractor Air Suspension (AD123-6,-8,-10,-8.75)   |          |     |     |     |             |
|      | Shock Mount approx. 2-1/2" above bottom of frame                        | 90045132 | ... | ... | 010 | 85909 ...   |
|      | Shock Mount flush with bottom of frame                                  | 90045099 | ... | ... | 010 | 85906 89407 |
|      | AD-130 Models Truck and Tractor Air Suspension (AD123-6,-8,-10,-8.75)   | 90045466 | ... | ... | 010 | ... 89406   |
|      | AD-130 Models Truck and Tractor Air Suspension W/ OEM Number            | 90045432 | ... | ... | 010 | 85321 ...   |
|      | AD-150 Models Truck & Tractor Air Suspension                            | 90045075 | ... | ... | 010 | 85911 ...   |
|      | AD-200 Models Truck & Tractor Air Suspension (AD-200-7, -8, -9, -11)    | 90045138 | ... | ... | 010 | 85910 ...   |
|      | AD-246 Models Truck & Tractor Air Suspension (AD246 -6, -8, -10, -8.75) | 90045099 | ... | ... | 010 | 85906 89407 |
|      |   | 90045132 | ... | ... | 010 | 85909 ...   |
| 00 - | AD-246 Models with 10" Ride Height                                      | 90045504 | ... | ... | 010 | 85030 89440 |
|      | AD-252-10 Tandem Axle   | 90045132 | ... | ... | 010 | 85909 ...   |
| 00 - | AD-369 Models with 10" Ride Height                                      | 90045504 | ... | ... | 010 | 85030 89440 |
|      | ADZ-123 Models Truck and Bus Air Suspension                             | 90045605 | ... | ... | 010 | 85109 ...   |
|      | ADZ-126 Models Truck and Bus Air Suspension                             | 90045605 | ... | ... | 010 | 85109 ...   |
|      | ADZ-246 Models Truck and Bus Air Suspension                             | 90045605 | ... | ... | 010 | 85109 ...   |
|      | ADZ-252 Models Truck and Bus Air Suspension                             | 90045605 | ... | ... | 010 | 85109 ...   |
|      | ADZ-369 Models Truck and Bus Air Suspension                             | 90045605 | ... | ... | 010 | 85109 ...   |
|      | ADZ-378 Models Truck and Bus Air Suspension                             | 90045605 | ... | ... | 010 | 85109 ...   |
|      | ARD-120 Models Truck & Tractor Air Suspension (ARD-120-6)               | 90044025 | ... | ... | 010 | 83209 89414 |

## APPLICATION GUIDE - TRUCKS, TRAILERS, AND BUSES









| Year<br>Año<br>Année | Model<br>Modelo<br>Modèle | OEM # | Front   |  | Rear   |   |
|----------------------|---------------------------|-------|---|--|--|---|
|                      |                           |       | <br>Fleetline | <br>GasSLX | <br>Fleetline | <br>GasSLX |

### SAF HOLLAND(Cont'd.)

#### Truck, Bus & Motorhome Air Suspensions(Cont'd.)

|  |              |     |              |     |              |              |
|--|--------------|-----|--------------|-----|--------------|--------------|
| ARD-125 Models Truck & Tractor Air Suspension<br>(ARD-125-6 use on Ford, GM, International (Navistar), Mack, White, Western Star, Freightliner)<br>(ARD-125-8 use on Freightliner, White, Western Star)<br>(ARD-125-8 use on Mack) | 90044025     | ... | ...          | OIO | <b>83209</b> | <b>89414</b> |
|  | 90044011     | ... | ...          | OIO | <b>85004</b> | ...          |
|  | 90044016     | ... | ...          | OIO | <b>85300</b> | <b>89419</b> |
| ARD-165 Models Truck & Tractor Air Suspension<br>(ARD-165-A, ARD-165-B)  | 90044011     | ... | ...          | OIO | <b>85004</b> | ...          |
| ARD-190 Models Truck & Tractor Air Suspension (ARD-190-B)  | 90044016     | ... | ...          | OIO | <b>85300</b> | <b>89419</b> |
| ARD-234 Models Truck & Tractor Air Suspension (ARD-234-6)  | 90044046     | ... | ...          | OIO | <b>83123</b> | <b>89405</b> |
| ARD-238 Models Truck & Tractor Air Suspension (ARD-238-6)  | 90044025     | ... | ...          | OIO | <b>83209</b> | <b>89414</b> |
| ARD-244 Models Truck & Tractor Air Suspension<br>(ARD-244-6 use on Ford, GM, International (Navistar), Mack, White, Western Star, Freightliner)<br>(ARD-244-8 use on Freightliner, White, Western Star)<br>(ARD-244-8 use on Mack) | 90044025     | ... | ...          | OIO | <b>83209</b> | <b>89414</b> |
|  | 90044011     | ... | ...          | OIO | <b>85004</b> | ...          |
|  | 90044016     | ... | ...          | OIO | <b>85300</b> | <b>89419</b> |
| ARDAB-120 Models Truck & Tractor Air Suspension (ARDAB-120-5)  | 90044907     | ... | ...          | OIO | <b>83635</b> | ...          |
| ARDAB-238-5 Models Truck & Tractor Air Suspension  | 90044907     | ... | ...          | OIO | <b>83635</b> | ...          |
| ARDAB-240 Models Truck & Tractor Air Suspension (ARDAB-240-5)  | 90044907     | ... | ...          | OIO | <b>83635</b> | ...          |
| ARDST-123 Models Truck & Tractor Air Suspension (ARDST-123-6, ARDSTM/L-123-6)  | 90044025     | ... | ...          | OIO | <b>83209</b> | <b>89414</b> |
| ARDST-244 Models Truck & Tractor Air Suspension (ARDST-244-6)  | 90044025     | ... | ...          | OIO | <b>83209</b> | <b>89414</b> |
| ARDST-246 Models Truck & Tractor Air Suspension (ARDST-246-6, ARDSTM/L-246-6)  | 90044025     | ... | ...          | OIO | <b>83209</b> | <b>89414</b> |
| ARDST-250-6 Models Truck & Tractor Air Suspension  | 90044025     | ... | ...          | OIO | <b>83209</b> | <b>89414</b> |
| ARDTB-125 Models Bus Air Suspension (ARDTB-125-6A)   | 90044448     | ... | ...          | OIO | <b>85051</b> | ...          |
| ARDTB-125 Models Bus Air Suspension (ARDTB-125-6B)   | 90045031     | ... | ...          | OIO | <b>85968</b> | ...          |
| ARDTB-125-6A (Note: Front shock)   | 90045050     | OIO | <b>85914</b> | ... | ...          | ...          |
| ARDTB-125-6A (Note: Rear shock)  | 90045053     | ... | ...          | OIO | <b>85908</b> | ...          |
| ART-500 Models Truck & Tractor Tag Axle Air Suspension<br>(ART-500-B, ART-500-B-1)<br>(ART-500-US, ART-500-US-A)   | 90044162     | ... | ...          | OIO | <b>83128</b> | <b>89436</b> |
|  | 90044008     | ... | ...          | OIO | <b>85000</b> | <b>89436</b> |
| ART-505 Models Truck & Tractor Tag Axle Air Suspension<br>(ART-505-B, -1, ART-505-C, -1)   | 90044162     | ... | ...          | OIO | <b>83128</b> | <b>89436</b> |
| ART-541 Models Truck & Tractor Tag Axle Air Suspension<br>(ART-541B)   | 90044162     | ... | ...          | OIO | <b>83128</b> | <b>89436</b> |
| ART-550 Models Truck & Tractor Tag Axle Air Suspension<br>(ART-550-US-1, -2, -3)   | 90044012     | ... | ...          | OIO | <b>85006</b> | ...          |
| ART-551 Models Truck & Tractor Tag Axle Air Suspension<br>(ART-551-B-1)<br>(ART-551-B-2, -3, ART-551-US-1, -2, -3)   | 90044162     | ... | ...          | OIO | <b>83128</b> | <b>89436</b> |
|  | 90044017     | ... | ...          | OIO | <b>83204</b> | ...          |
| ART-555 Models Truck & Tractor Tag Axle Air Suspension<br>(ART-555-B-1, ART-555-C-1)<br>(ART-555-B-2, -3, ART555C-2, -3)   | 90044162     | ... | ...          | OIO | <b>83128</b> | <b>89436</b> |
|  | 90044642     | ... | ...          | OIO | <b>83127</b> | ...          |
| Models with O.E.M. Number  | 471700000433 | ... | ...          | OIO | <b>85099</b> | ...          |
|  | 471700000436 | ... | ...          | OIO | <b>85030</b> | <b>89440</b> |
|  | 471700000458 | ... | ...          | OIO | <b>85014</b> | ...          |
|  | 471700000459 | ... | ...          | OIO | <b>85030</b> | <b>89440</b> |
|  | 471700000460 | ... | ...          | OIO | <b>85097</b> | ...          |
|  | 471700000461 | ... | ...          | OIO | ...          | <b>89414</b> |
|  | 481700000483 | ... | ...          | OIO | <b>85975</b> | ...          |
|  | 481700000484 | ... | ...          | OIO | <b>85974</b> | ...          |
|  | 481700000485 | ... | ...          | OIO | <b>85975</b> | ...          |
|  | 665002       | ... | ...          | OIO | <b>85004</b> | ...          |
|  | 665003       | ... | ...          | OIO | <b>85300</b> | <b>89419</b> |

## APPLICATION GUIDE - TRUCKS, TRAILERS, AND BUSES

| Year<br>Año<br>Année | Model<br>Modelo<br>Modèle | OEM # | Front   |   | Rear  |   |
|----------------------|---------------------------|-------|---|---|---|---|
|                      |                           |       |  |  |  |  |
|                      |                           |       |  |  |  |  |
|                      |                           |       | Fleetline   | GasSLX  | Fleetline   | GasSLX  |

### SAF HOLLAND(Cont'd.)

#### Truck, Bus & Motorhome Air Suspensions(Cont'd.)

|                           |          |     |     |              |              |              |
|---------------------------|----------|-----|-----|--------------|--------------|--------------|
| Models with O.E.M. Number | 671921   | ... | ... | 010          | <b>85916</b> | <b>89430</b> |
|                           | 671922   | ... | ... | 010          | ...          | <b>89405</b> |
|                           | 671923   | ... | ... | 010          | ...          | <b>89440</b> |
|                           | 680645   | ... | ... | 010          | <b>85321</b> | ...          |
|                           | 90045084 | ... | ... | 010          | <b>85968</b> | ...          |
|                           | 90045277 | ... | ... | 010          | <b>85030</b> | <b>89440</b> |
|                           | 90045336 | ... | ... | 010          | <b>85014</b> | ...          |
|                           | 90045418 | ... | ... | 010          | <b>85916</b> | <b>89430</b> |
|                           | 90045419 | ... | ... | 010          | ...          | <b>89405</b> |
|                           | 90045420 | ... | ... | 010          | ...          | <b>89440</b> |
|                           | 90045455 | ... | ... | 010          | <b>85909</b> | ...          |
|                           | 90045499 | ... | ... | 010          | <b>85974</b> | ...          |
|                           | 90045500 | ... | ... | 010          | <b>85975</b> | ...          |
|                           | 90045503 | ... | ... | 010          | <b>85975</b> | ...          |
|                           | 90045504 | ... | ... | 010          | <b>85030</b> | <b>89440</b> |
|                           | 90045532 | ... | ... | 010          | <b>85030</b> | <b>89440</b> |
|                           | 90045533 | ... | ... | 010          | <b>85099</b> | ...          |
|                           | 90045534 | ... | ... | 010          | <b>85014</b> | ...          |
|                           | 90045535 | ... | ... | 010          | <b>85097</b> | ...          |
|                           | 90045536 | ... | ... | 010          | ...          | <b>89414</b> |
| 90045568                  | ...      | ... | 010 | <b>85060</b> | ...          |              |

### SEAGRAVE FIRE APPARATUS LLC

|                           |          |     |     |     |              |              |
|---------------------------|----------|-----|-----|-----|--------------|--------------|
| Models with O.E.M. Number | 680117   | ... | ... | 010 | <b>85300</b> | <b>89419</b> |
|                           | P0025500 | ... | ... | 010 | <b>85300</b> | <b>89419</b> |

### SHASTA RV

|  |          |     |              |     |              |     |
|--|----------|-----|--------------|-----|--------------|-----|
| All models with Ford E350 & E450 Chassis | ASH-1136 | ... | ...          | -10 | <b>83178</b> | ... |
|  | ASH-1154 | -10 | <b>83177</b> | ... | ...          | ... |

### SHOWHAULER MOTORHOMES

|  |       |  |  |  |       |       |
|--|-------|--|--|--|-------|-------|
| Models with Cascadia Chassis - See Freightliner section for proper year and model information  | ..... |  |  |  | ..... | ..... |
| Models with Kenworth Chassis - See Kenworth section for proper year and model information      | ..... |  |  |  | ..... | ..... |
| Models with Lonestar Chassis - See International section for proper year and model information | ..... |  |  |  | ..... | ..... |
| Models with VNL Chassis - See Volvo section for proper year and model information              | ..... |  |  |  | ..... | ..... |

### SICARD

|                           |         |  |              |     |     |              |     |
|---------------------------|---------|--|--------------|-----|-----|--------------|-----|
| Models with O.E.M. Number | 3166657 |  | <b>85700</b> | ... | 010 | <b>85700</b> | ... |
|---------------------------|---------|--|--------------|-----|-----|--------------|-----|

### SOUTHERN COACH

|                            |       |  |              |     |     |              |     |
|----------------------------|-------|--|--------------|-----|-----|--------------|-----|
| Early Model Air Suspension | ..... |  | <b>85304</b> | ... | 010 | <b>85304</b> | ... |
| Late Model Air Suspension  | ..... |  | <b>83217</b> | ... | 010 | <b>83217</b> | ... |
| U.S. Army Coaches          | ..... |  | <b>83217</b> | ... | 010 | <b>83217</b> | ... |

### SPARTAN MOTORS

|         |  |              |     |              |     |              |                           |
|---------|--|--------------|-----|--------------|-----|--------------|---------------------------|
| 97 - 00 | Alpine / Summit MotorHome Chassis with O.E.M. Number                         | 0377-SS5     | ... | ...          | 010 | <b>85029</b> | ...                       |
|         |  | B46-1725     | ... | ...          | 010 | <b>85029</b> | ...                       |
|         | Buses with Hendrickson Softek Suspension with Drum and Disc Brakes           | 471700000456 | 010 | <b>85959</b> | ... | ...          | ...                       |
|         |  | 58913-009    | 010 | <b>85959</b> | ... | ...          | ...                       |
|         |  | 58913-009L   | 010 | <b>85959</b> | ... | ...          | ...                       |
|         | Chassis With Hendrickson HTS 210 Suspension (Type C School Bus Applications) | 60665-025    |     | ...          | ... | 010          | <b>85036</b> <b>89405</b> |



## APPLICATION GUIDE - TRUCKS, TRAILERS, AND BUSES

| Year<br>Año<br>Année | Model<br>Modelo<br>Modèle | OEM # | Front     |        |  | Rear      |        |  |
|----------------------|---------------------------|-------|-----------|--------|--|-----------|--------|--|
|                      |                           |       |           |        |  |           |        |  |
|                      |                           |       | Fleetline | GasSLX |  | Fleetline | GasSLX |  |

### SPARTAN MOTORS(Cont'd.)

|                |  |            |     |              |     |     |              |              |
|----------------|--|------------|-----|--------------|-----|-----|--------------|--------------|
|                | Chassis With Hendrickson HTS 210 Suspension (Type C School Bus Applications) | 60665-025L |     | ...          | ... | 010 | <b>85036</b> | <b>89405</b> |
|                | Fire Truck with O.E.M. Number  | 0272-SS5   | 010 | <b>85712</b> | ... |     | ...          | ...          |
| <b>1986</b>    | Fire Truck with Ridewell Front Suspension                                    | AS 4025B   | 010 | <b>85712</b> | ... |     | ...          | ...          |
| <b>97 - 00</b> | K2 / K3/ MountainMaster with O.E.M. Number                                   | B46-2151   |     | ...          | ... | 010 | <b>85007</b> | <b>89412</b> |
| <b>91 - 95</b> | K2 / K3/ MountainMaster with Tuthill 102 AR Air Suspension                   | 0346-SS5   |     | ...          | ... | 010 | <b>85013</b> | <b>89414</b> |
|                |  | B46-1594   |     | ...          | ... | 010 | <b>85013</b> | <b>89414</b> |
|                | Models with Reyco 1200 Steer Option)   | 21310-01   | 010 | <b>85307</b> | ... |     | ...          | ...          |
|                | Motorhome chassis with Ridewell Front Suspension                             | AS 4025B   | 010 | <b>85712</b> | ... |     | ...          | ...          |
|                | Models with O.E.M. Number  | 59011      | 010 | <b>83214</b> | ... |     | ...          | ...          |
|                | Additional O.E.M. Interchanges   | 78068      | 010 | <b>85304</b> |     |     |              |              |

### STARCRAFT BUS CO.

#### Allstar XL & XLT - Series

|                       |   |               |     |              |     |     |              |     |
|-----------------------|---|---------------|-----|--------------|-----|-----|--------------|-----|
| <b>00 - 15</b>        | Models with F-650 chassis with 10,000 lb Front Suspension                         | 3584116C1     | 010 | <b>83175</b> | ... |     | ...          | ... |
|                       |   | 3584116C2     | 010 | <b>83175</b> | ... |     | ...          | ... |
|                       |   | 4C4Z-18124-QA | 010 | <b>83175</b> | ... |     | ...          | ... |
|                       |   | AA-616        | 010 | <b>83175</b> | ... |     | ...          | ... |
| <b>00 - 15</b>        | Models with F-650 chassis with 12,000 & 13,200 lb Front Springs                   | 3584118C2     | 010 | <b>85928</b> | ... |     | ...          | ... |
|                       |   | 4C4Z-18124-JB | 010 | <b>85928</b> | ... |     | ...          | ... |
|                       |   | 4C4Z-18124-RA | 010 | <b>85928</b> | ... |     | ...          | ... |
|                       |   | AA-617        | 010 | <b>85928</b> | ... |     | ...          | ... |
|                       |   | AT-812        | 010 | <b>85928</b> | ... |     | ...          | ... |
| <b>July/2015 - 19</b> | Models with F-650 chassis with 13,500, 15,500 & 19,000 lb Multi-leaf Rear Springs | 471700011531  |     | ...          | ... | 010 | <b>85180</b> | ... |
|                       |   | ASH-24660     |     | ...          | ... | 010 | <b>85180</b> | ... |
|                       |   | FC44-18080-AB |     | ...          | ... | 010 | <b>85180</b> | ... |
|                       |   | FC4Z-18125-A  |     | ...          | ... | 010 | <b>85180</b> | ... |
| <b>July/2015 - 19</b> | Models with F-650 chassis with 19.5" or 22.5" Wheels (22,000 lb GVW)              | 471700011530  | 010 | <b>85181</b> | ... |     | ...          | ... |
|                       |   | ASH-24658     | 010 | <b>85181</b> | ... |     | ...          | ... |
|                       |   | ASH-24659     | 010 | <b>85181</b> | ... |     | ...          | ... |
|                       |   | FC44-18045-BB | 010 | <b>85181</b> | ... |     | ...          | ... |
|                       |   | FC4Z-18124-A  | 010 | <b>85181</b> | ... |     | ...          | ... |
|                       |   | FC4Z-18124-B  | 010 | <b>85181</b> | ... |     | ...          | ... |
| <b>- 2015</b>         | Models with F-650 chassis with 21,000 lb Rear Air Suspension                      | 3578858C1     |     | ...          | ... | 010 | <b>85926</b> | ... |
|                       |   | 3578858C2     |     | ...          | ... | 010 | <b>85926</b> | ... |
|                       |   | 4C4Z-18125-DA |     | ...          | ... | 010 | <b>85926</b> | ... |
| <b>04 - 11</b>        | Models with F-650 chassis with 22,000 lb Multi-leaf Rear Springs                  | 4C4Z-18125-B  |     | ...          | ... | -10 | <b>83317</b> | ... |
|                       |   | 501906C92     |     | ...          | ... | -10 | <b>83317</b> | ... |

#### E350 & E450 Ford Chassis Models

|               |  |          |     |              |     |     |              |     |
|---------------|--|----------|-----|--------------|-----|-----|--------------|-----|
| <b>- 2019</b> | Allstar Series Shuttle buses with Ford E350 & E450 Chassis   | ASH-1136 |     | ...          | ... | -10 | <b>83178</b> | ... |
|               |  | ASH-1154 | -10 | <b>83177</b> | ... |     | ...          | ... |
| <b>- 2019</b> | MVP Series Shuttle buses with Ford E450 Chassis              | ASH-1136 |     | ...          | ... | -10 | <b>83178</b> | ... |
|               |  | ASH-1154 | -10 | <b>83177</b> | ... |     | ...          | ... |
| <b>- 2019</b> | Starlite Series Shuttle buses with Ford E350 & E450 Chassis  | ASH-1136 |     | ...          | ... | -10 | <b>83178</b> | ... |
|               |  | ASH-1154 | -10 | <b>83177</b> | ... |     | ...          | ... |
| <b>- 2019</b> | Starquest Series Shuttle buses with Ford E350 & E450 Chassis | ASH-1136 |     | ...          | ... | -10 | <b>83178</b> | ... |
|               |  | ASH-1154 | -10 | <b>83177</b> | ... |     | ...          | ... |
| <b>- 2019</b> | Ultra Star Series Shuttle buses with Ford E450 Chassis       | ASH-1136 |     | ...          | ... | -10 | <b>83178</b> | ... |
|               |  | ASH-1154 | -10 | <b>83177</b> | ... |     | ...          | ... |
| <b>- 2019</b> | Xpress Series Shuttle buses with Ford E350 & E450 Chassis    | ASH-1136 |     | ...          | ... | -10 | <b>83178</b> | ... |
|               |  | ASH-1154 | -10 | <b>83177</b> | ... |     | ...          | ... |

## APPLICATION GUIDE - TRUCKS, TRAILERS, AND BUSES

| Year<br>Año<br>Année | Model<br>Modelo<br>Modèle | OEM # | Front     |        | Rear      |        |
|----------------------|---------------------------|-------|-----------|--------|-----------|--------|
|                      |                           |       |           |        |           |        |
|                      |                           |       | Fleetline | GasSLX | Fleetline | GasSLX |

### STERLING TRUCK

#### A - Line 9500 Series (SilverStar)

|         |   |               |     |       |       |       |       |
|---------|---|---------------|-----|-------|-------|-------|-------|
| 1998 -  | A9513, A9522, AT9513, AT9522 (113" & 122" BBC) Models with 8500 or 9000 lb Axle and 54" Taperleaf Spring        | F6HT-18045-HB | OIO | 85054 | 89438 | ...   | ...   |
|         |   | F6HT-18045-HC | OIO | 85054 | 89438 | ...   | ...   |
| 1998 -  | A9513, A9522, AT9513, AT9522 (113" & 122" BBC) Models with 8500, 9000 or 10000 lb Axle and 54" Multileaf Spring | F6HT-18045-KA | OIO | 83200 | 89402 | ...   | ...   |
| 1998 -  | All Models with 10000 lb or 12000 lb Axle and 54" Taperleaf Spring  | F6HT-18045-AC | OIO | 85054 | 89438 | ...   | ...   |
| 1998 -  | All Models with 12000 lb or 13200 lb Axle and 54" Multileaf Spring  | F6HT-18045-BC | OIO | 85047 | 89435 | ...   | ...   |
| 1998 -  | All Models with 12000 lb, 13200 lb or 14600 lb Axle and 60" Taperleaf Spring                                    | F6HT-18045-EB | OIO | 85055 | 89439 | ...   | ...   |
|         |   | F6HT-18045-EC | OIO | 85055 | 89439 | ...   | ...   |
| 1998 -  | All Models with 13200 lb or 14600 lb Axle and 54" Taperleaf Spring  | F6HT-18045-GC | OIO | 85030 | 89440 | ...   | ...   |
| 1998 -  | All Models with 14600 lb or 16000 lb Axle and 54" Multi-leaf Spring   | F6HT-18045-CC | OIO | 85055 | 89439 | ...   | ...   |
| 1998 -  | All Models with 23000 lb Axle and 52" Taperleaf Softride Rear Suspension  | F6HT-18080-CA | OIO | ...   | ...   | 85314 | 89425 |
| 1998 -  | All Models with Hendrickson 40LH Tandem Axle  | 57241-2       | OIO | ...   | ...   | 83109 | ...   |
| 1998 -  | All Models with Hendrickson HAS Rear Air Suspension   | 47902-28      | OIO | ...   | ...   | 85013 | 89414 |
|         |   | F6HT-18080-FC | OIO | ...   | ...   | 85013 | 89414 |
| 1998 -  | Models with FAS II Rear Air Suspension  | 16-15817-000  | OIO | ...   | ...   | 85724 | 89443 |
| 98 - 03 | Models with O.E.M. Number   | 10-13205-000  | OIO | 85918 | 89449 | ...   | ...   |
|         |   | 471700131646  | OIO | 85918 | 89449 | ...   | ...   |

#### ACTERRA

|         |  |  |            |       |       |       |       |
|---------|--|--|------------|-------|-------|-------|-------|
|         | All Models with Freightliner TufTrac Rear Air Suspension               | 16-15770-000                             | OIO        | ...   | ...   | 85956 | ...   |
|         |  | 481700125969                             | OIO        | ...   | ...   | 85956 | ...   |
| 09 - 10 | Models with 10000 to 12000 lb. Front Axle and 3" Taper-leaf Suspension | 10-13592-000                             | OIO        | 85959 | ...   | ...   | ...   |
|         |  | SDA47170000440                           | OIO        | 85959 | ...   | ...   | ...   |
| 2003 -  | Models with 10000 to 12000 lb. Taper-leaf Spring Suspension            | 10-12390-000                             | OIO        | 85920 | 89503 | ...   | ...   |
|         |  | Models with 11000 to 12000 lb Front axle | 6803230300 | OIO   | 85006 | ...   | ...   |
|         | Models with 15000 lb Rear Suspension                                   | 6803260000                               | OIO        | ...   | ...   | 83120 | ...   |
| - 2002  | Models with 6000 to 9000 lb Front axle                                 | 6803230200                               | OIO        | 85043 | ...   | ...   | ...   |
| 03 - 08 | Models with 6000 to 9000 lb Front axle                                 | 10-12388-000                             | OIO        | 85920 | 89503 | ...   | ...   |
| 03 - 10 | Models with FAS II Rear Air Suspension                                 | 16-15817-000                             | OIO        | ...   | ...   | 85724 | 89443 |
|         |  | 16-18708-000                             | OIO        | ...   | ...   | 85724 | 89443 |
|         |  | 471700002809                             | OIO        | ...   | ...   | 85724 | 89443 |
|         |  | 481700006848                             | OIO        | ...   | ...   | 85724 | 89443 |
|         |  | 680611                                   | OIO        | ...   | ...   | 85724 | 89443 |
|         |  | SDA471700002809                          | OIO        | ...   | ...   | 85724 | 89443 |
| - 04/09 | Models with Hendrickson Airtek Suspension                              | 58913-003                                | OIO        | 85932 | 89453 | ...   | ...   |
|         |  | 58913-003L                               | OIO        | 85932 | 89453 | ...   | ...   |

#### Cargo Line

|      |   |               |     |       |       |     |     |
|------|---|---------------|-----|-------|-------|-----|-----|
| 1998 | SC-7000 or SC-8000 Models with 12000 or 13000 lb. Axles   | F6HT-18045-LA | OIO | 85376 | ...   | ... | ... |
| 1998 | SC-7000 or SC-8000 Models with 16000 lb. Multileaf Spring | F6HT-18045-AA | OIO | 85054 | 89438 | ... | ... |

#### L - Line 7500 Series - Short Haul Tractor

|  |                                 |               |     |       |       |     |     |
|--|---------------------------------|---------------|-----|-------|-------|-----|-----|
|  | Models with 10000 lb Front Axle | F6HT-18045-KA | OIO | 83200 | 89402 | ... | ... |
|--|---------------------------------|---------------|-----|-------|-------|-----|-----|

#### L - Line 8500 Series - Conventional Cab

|        |  |               |     |       |       |     |     |
|--------|--|---------------|-----|-------|-------|-----|-----|
| 1998   | All Models with 10000 lb or 12000 lb Axle and 54" Taperleaf Spring           | F6HT-18045-AC | OIO | 85054 | 89438 | ... | ... |
| 1998 - | All Models with 12000 lb or 13200 lb Axle and 54" Multileaf Spring           | F6HT-18045-BC | OIO | 85047 | 89435 | ... | ... |
| 1998 - | All Models with 12000 lb, 13200 lb or 14600 lb Axle and 60" Taperleaf Spring | F6HT-18045-EB | OIO | 85055 | 89439 | ... | ... |
|        |  | F6HT-18045-EC | OIO | 85055 | 89439 | ... | ... |
| 1998 - | All Models with 13200 lb or 14600 lb Axle and 54" Taperleaf Spring           | F6HT-18045-GC | OIO | 85030 | 89440 | ... | ... |

## APPLICATION GUIDE - TRUCKS, TRAILERS, AND BUSES

| Year<br>Año<br>Année | Model<br>Modelo<br>Modèle | OEM # | Front     |        | Rear      |        |
|----------------------|---------------------------|-------|-----------|--------|-----------|--------|
|                      |                           |       |           |        |           |        |
|                      |                           |       | Fleetline | GasSLX | Fleetline | GasSLX |

### STERLING TRUCK(Cont'd.)

#### L - Line 8500 Series - Conventional Cab(Cont'd.)

|         |  |               |     |       |       |     |       |       |
|---------|--|---------------|-----|-------|-------|-----|-------|-------|
| 1998 -  | All Models with 14600 lb or 16000 lb Axle and 54"Multi-leaf Spring           | F6HT-18045-CC | 010 | 85055 | 89439 |     | ...   | ...   |
| 1998 -  | All Models with 23000 lb Axle and 52" Taperleaf Softride Rear Suspension     | F6HT-18080-CA |     | ...   | ...   | 010 | 85314 | 89425 |
| 1998    | All with Hendrickson HAS Rear Air Suspension                                 | 47902-28      |     | ...   | ...   | 010 | 85013 | 89414 |
|         |  | F6HT-18080-FC |     | ...   | ...   | 010 | 85013 | 89414 |
| 1998    | LT-8000 Models with 12000 or 13000 lb Axles                                  | F6HT-18045-LA | 010 | 85376 | ...   |     | ...   | ...   |
| 1998    | LT-8000 Models with 16000 lb. Multileaf Spring                               | F6HT-18045-AA | 010 | 85054 | 89438 |     | ...   | ...   |
| 1998    | LT-8501 (101" BBC) Models with 8500 or 9000 lb Axle and 54" Multileaf Spring | F6HT-18045-JB | 010 | 83200 | 89402 |     | ...   | ...   |
|         |  | F6HT-18045-JC | 010 | 83200 | 89402 |     | ...   | ...   |
|         | LT-8501 (101" BBC) Models with 8500 or 9000 lb Axle and 54" Taperleaf Spring | F6HT-18045-HB | 010 | 85054 | 89438 |     | ...   | ...   |
|         |  | F6HT-18045-HC | 010 | 85054 | 89438 |     | ...   | ...   |
| 99 - 10 | Models with FAS II Rear Air Suspension                                       | 16-15817-000  |     | ...   | ...   | 010 | 85724 | 89443 |
|         |  | 680611        |     | ...   | ...   | 010 | 85724 | 89443 |
| 1998    | Models with Hendrickson 40LH Tandem Axle                                     | 57241-2       |     | ...   | ...   | 01- | 83109 | ...   |





#### L - Line 9500 Series - Conventional Cab

|         |  |               |     |       |       |     |       |       |
|---------|--|---------------|-----|-------|-------|-----|-------|-------|
| 1998    | All Models with 10000 lb or 12000 lb Axle and 54" Taperleaf Spring   | F6HT-18045-AC | 010 | 85054 | 89438 |     | ...   | ...   |
| 1998 -  | All Models with 12000 lb or 13200 lb Axle and 54" Multileaf Spring   | F6HT-18045-BC | 010 | 85047 | 89435 |     | ...   | ...   |
| 1998 -  | All Models with 12000 lb, 13200 lb or 14600 lb Axle and 60" Taperleaf Spring                                     | F6HT-18045-EB | 010 | 85055 | 89439 |     | ...   | ...   |
|         |  | F6HT-18045-EC | 010 | 85055 | 89439 |     | ...   | ...   |
| 1998 -  | All Models with 13200 lb or 14600 lb Axle and 54" Taperleaf Spring   | F6HT-18045-GC | 010 | 85030 | 89440 |     | ...   | ...   |
| 1998 -  | All Models with 14600 lb or 16000 lb Axle and 54"Multi-leaf Spring   | F6HT-18045-CC | 010 | 85055 | 89439 |     | ...   | ...   |
| 1998 -  | All with 23000 lb Axle and 52" Taperleaf Softride Rear Suspension  | F6HT-18080-CA |     | ...   | ...   | 010 | 85314 | 89425 |
|         |  | 47902-28      |     | ...   | ...   | 010 | 85013 | 89414 |
| 1998 -  | All with Hendrickson HAS Rear Air Suspension   | F6HT-18080-FC |     | ...   | ...   | 010 | 85013 | 89414 |
|         |  |               |     | ...   | ...   | 010 | 85013 | 89414 |
| 1998 -  | LT-9501, LT-9511, LT-9513 or LT-9513 (113" & 122" BBC) Models with 8500 or 9000 lb Axle and 54" Multileaf Spring | F6HT-18045-JB | 010 | 83200 | 89402 |     | ...   | ...   |
|         |  | F6HT-18045-JC | 010 | 83200 | 89402 |     | ...   | ...   |
| 1998 -  | LT-9501, LT-9511, LT-9513 or LT-9513 (113" & 122" BBC) Models with 8500 or 9000 lb Axle and 54" Taperleaf Spring | F6HT-18045-HB | 010 | 85054 | 89438 |     | ...   | ...   |
|         |  | F6HT-18045-HC | 010 | 85054 | 89438 |     | ...   | ...   |
| 99 - 10 | Models with FAS II Rear Air Suspension   | 16-13957-000  |     | ...   | ...   | 010 | 85724 | 89443 |
|         |  | XC45-18080-BA |     | ...   | ...   | 010 | 85724 | 89443 |
| 1998 -  | Models with Hendrickson 40LH Tandem Axle   | 57241-2       |     | ...   | ...   | 01- | 83109 | ...   |

#### Additional O.E.M. Interchanges

|              |                                      |               |     |        |       |     |       |       |
|--------------|--------------------------------------|---------------|-----|--------|-------|-----|-------|-------|
|              | Models with Link Rear Air Suspension | 1210-0528     |     | ...    | ...   | 010 | 85904 | ...   |
|              | Models with Neway Rear Suspension    | 90045099      |     | ...    | ...   | 010 | 85906 | 89407 |
|              | Models with O.E.M. Number            | 16-15770-000  |     | ...    | ...   | 010 | 85956 | ...   |
|              |                                      | 4C4Z-18124-N  | 010 | 85957  | ...   |     | ...   | ...   |
|              |                                      | 4C4Z-18125-DA |     | ...    | ...   | 010 | 85926 | ...   |
|              |                                      | 6E7Z-18125-A  |     | ...    | ...   | 010 | 83146 | ...   |
|              |                                      | AT-560        | 010 | G63809 | ...   |     | ...   | ...   |
|              |                                      | AX-267A       | 010 | 83309  | 89446 |     | ...   | ...   |
|              |                                      | AX-310        |     | ...    | ...   | 010 | 83215 | ...   |
|              |                                      | C4HZ-18124-E  | 010 | 83309  | 89446 |     | ...   | ...   |
|              |                                      | C4TZ-18124-AB | 010 | 83308  | ...   |     | ...   | ...   |
|              |                                      | D8HZ-18124-A  | 010 | 85301  | ...   |     | ...   | ...   |
|              |                                      | E6HZ-18124-A  | 010 | 85301  | ...   |     | ...   | ...   |
|              |                                      | E6HZ-18124-D  | 010 | 85301  | ...   |     | ...   | ...   |
|              |                                      | E6HZ-18125-D  |     | ...    | ...   | 010 | 83215 | ...   |
| E7HZ-18124-A | 010                                  | 85301         | ... |        | ...   | ... |       |       |

**APPLICATION GUIDE - TRUCKS, TRAILERS, AND BUSES**

| Year<br>Año<br>Année | Model<br>Modelo<br>Modèle | OEM # | Front   |  | Rear  |  |
|----------------------|---------------------------|-------|---|--|---|--|
|                      |                           |       |  Fleetline |  GasSLX |  Fleetline |  GasSLX |

**STERLING TRUCK(Cont'd.)**

**Additional O.E.M. Interchanges(Cont'd.)**

| Models with O.E.M. Number |     |               |              |     |               |              |  |
|---------------------------|-----|---------------|--------------|-----|---------------|--------------|--|
| E7XZ-18124-A              | -10 | <b>G63386</b> | ...          |     | ...           | ...          |  |
| E7XZ-18125-B              |     | ...           | ...          | -10 | <b>G63387</b> | ...          |  |
| E9HZ-18124-A              | 010 | <b>83309</b>  | <b>89446</b> |     | ...           | ...          |  |
| F0HZ-18124-B              | 010 | <b>85006</b>  | ...          |     | ...           | ...          |  |
| F1HZ-18124-A              | 010 | <b>83309</b>  | <b>89446</b> |     | ...           | ...          |  |
| F1HZ-18124-B              | 010 | <b>83308</b>  | ...          |     | ...           | ...          |  |
| F1HZ-18124-D              | 010 | <b>85006</b>  | <b>89401</b> |     | ...           | ...          |  |
| F1HZ-18124-E              | 010 | <b>85006</b>  | <b>89401</b> |     | ...           | ...          |  |
| F1HZ-18124-H              | 010 | <b>85040</b>  | ...          |     | ...           | ...          |  |
| F1HZ-18124-J              | 010 | <b>83308</b>  | ...          |     | ...           | ...          |  |
| F1HZ-18124-K              | 010 | ...           | <b>89402</b> |     | ...           | ...          |  |
| F2HZ-18124-A              | 010 | <b>85376</b>  | ...          |     | ...           | ...          |  |
| F2HZ-18124-B              | 010 | <b>85301</b>  | ...          |     | ...           | ...          |  |
| F4HT-18080-AB             |     | ...           | ...          | 010 | <b>85314</b>  | <b>89425</b> |  |
| F4HT-18080-BA             |     | ...           | ...          | 010 | <b>85001</b>  | <b>89410</b> |  |
| F5HZ-18124-A              | 010 | <b>83314</b>  | ...          |     | ...           | ...          |  |
| F5HZ-18124-B              | 010 | <b>83107</b>  | ...          |     | ...           | ...          |  |
| F5HZ-18124-C              | 010 | <b>85063</b>  | ...          |     | ...           | ...          |  |
| F5HZ-18124-D              | 010 | <b>83125</b>  | ...          |     | ...           | ...          |  |
| F5HZ-18125-A              |     | ...           | ...          | 010 | <b>85314</b>  | <b>89425</b> |  |
| F5HZ-18125-B              |     | ...           | ...          | 010 | <b>85001</b>  | <b>89410</b> |  |
| F6HT-18045-GB             | 010 | <b>85030</b>  | <b>89440</b> |     | ...           | ...          |  |
| F6HT-18080-B              |     | ...           | ...          | 01- | <b>83109</b>  | ...          |  |
| F6HT-18080-DA             |     | ...           | ...          | 01- | <b>83109</b>  | ...          |  |
| F6HT-18080-EA             |     | ...           | ...          | 010 | <b>85906</b>  | <b>89407</b> |  |
| F6HT-18124-JC             | 010 | <b>83200</b>  | <b>89402</b> |     | ...           | ...          |  |
| F6HT-18124-KA             | 010 | <b>83200</b>  | <b>89402</b> |     | ...           | ...          |  |
| F6HZ-18124-A              | 010 | <b>85054</b>  | <b>89438</b> |     | ...           | ...          |  |
| F6HZ-18124-B              | 010 | <b>83308</b>  | ...          |     | ...           | ...          |  |
| F6HZ-18124-C              | 010 | <b>85055</b>  | <b>89439</b> |     | ...           | ...          |  |
| F6HZ-18124-D              | 010 | <b>85055</b>  | <b>89439</b> |     | ...           | ...          |  |
| F6HZ-18124-E              | 010 | <b>85055</b>  | <b>89439</b> |     | ...           | ...          |  |
| F6HZ-18124-F              | 010 | <b>85055</b>  | <b>89439</b> |     | ...           | ...          |  |
| F6HZ-18124-G              | 010 | <b>85054</b>  | <b>89438</b> |     | ...           | ...          |  |
| F6HZ-18124-H              | 010 | <b>85054</b>  | <b>89438</b> |     | ...           | ...          |  |
| F6HZ-18124-J              | 010 | <b>83200</b>  | <b>89402</b> |     | ...           | ...          |  |
| F6HZ-18125-B              |     | ...           | ...          | 01- | <b>83109</b>  | ...          |  |
| F6HZ-18125-D              |     | ...           | ...          | 010 | <b>85013</b>  | <b>89414</b> |  |
| F81A-18045-AGB            | 010 | <b>G63809</b> | ...          |     | ...           | ...          |  |
| XC45-18045-AA             | 010 | <b>83216</b>  | ...          |     | ...           | ...          |  |

**STERLING TRUCK CAB SHOCKS**

|  |               |     |              |
|--|---------------|-----|--------------|
| 8500 & 9500 Models with 113" & 122" BBC Conventional Tractors with Link Cabmate Models FH1322 & FH1322-A | 1202-1043     | 010 | <b>83025</b> |
| AT-9500 Models with O.E.M. Number  | F6HZ-5K407-BA | 010 | <b>83033</b> |
|  | F8HT-5K407-AA | 010 | <b>83033</b> |
| L8501 & L9501 Models with 101" BBC Conventional Tractors with Link Cabmate Model FH101                   | 1202-1043     | 010 | <b>83025</b> |
| LT-9500 Models with O.E.M. Number  | F6HZ-5K407-AB | 010 | <b>83034</b> |
| Models with O.E.M. Number  | 18-45067-000  | 010 | <b>83034</b> |

**ACTERRA**

|                |                                   |                 |     |              |
|----------------|-----------------------------------|-----------------|-----|--------------|
| <b>03 - 10</b> | Acterra Models with O.E.M. Number | 18-43504-000    | 010 | <b>83057</b> |
|                |                                   | 18-60768-000    | 010 | <b>83057</b> |
|                |                                   | 18-814903003484 | 010 | <b>83057</b> |

## APPLICATION GUIDE - TRUCKS, TRAILERS, AND BUSES

| Year<br>Año<br>Année | Model<br>Modelo<br>Modèle | OEM # | Front     |        |  | Rear |  |  |
|----------------------|---------------------------|-------|-----------|--------|--|------|--|--|
|                      |                           |       |           |        |  |      |  |  |
|                      |                           |       | Fleetline | GasSLX |  |      |  |  |

### STOUGHTON TRAILERS INC.

|  |            |  |     |     |     |       |       |
|--|------------|--|-----|-----|-----|-------|-------|
| Trailers with Hendrickson HT190T, HT190U, & HS190T Models Air Suspension | HTA20001   |  | ... | ... | OIO | 83128 | 89436 |
| Trailers with Hendrickson HT230T Models Air Suspension                   | HTA20002   |  | ... | ... | OIO | 85000 | 89436 |
| Trailers with Neway AR-90-1-12, -14, -17 Models Air Suspension           | NW90044162 |  | ... | ... | OIO | 83128 | 89436 |
| Trailers with Neway AR-90-1-15, -16 Models Air Suspension                | NW90044448 |  | ... | ... | OIO | 85051 | ...   |
| Trailers with Neway RL-196-14, -15, Models Air Suspension                | NW90044978 |  | ... | ... | OIO | 85059 | ...   |
| Trailers with Neway RL-196-16, -17, Models Air Suspension                | NW90044979 |  | ... | ... | OIO | 83113 | ...   |
| Trailers with Reyco 86AR/RS1015 Air Ride Suspension                      | RT18165-01 |  | ... | ... | OIO | 85006 | ...   |
| Trailers with Reyco 86AR/RS1035 Anti-Dock Walk Air Suspension            | RT18165-01 |  | ... | ... | OIO | 85006 | ...   |

### SUSPENSYS

|                                       |           |  |     |     |     |       |     |
|---------------------------------------|-----------|--|-----|-----|-----|-------|-----|
| FS230 Trailer Suspension (Light Duty) | 218004872 |  | ... | ... | OIO | 85737 | ... |
|---------------------------------------|-----------|--|-----|-----|-----|-------|-----|





### THE BINKLEY COMPANY

|      |  |       |  |     |     |     |       |     |
|------|--|-------|--|-----|-----|-----|-------|-----|
| 1997 | Trailers with Binkley AirLite Suspension | 16965 |  | ... | ... | OIO | 85006 | ... |
|      |  | 6898  |  | ... | ... | OIO | 83125 | ... |

### THOMAS SCHOOL BUS

|         |  |              |     |       |       |     |       |       |
|---------|--|--------------|-----|-------|-------|-----|-------|-------|
|         | Buses with Neway Tandem Air Suspension   | 61310232     |     | ...   | ...   | OIO | 85000 | 89436 |
|         | Buses with O.E.M. Number   | 16-19138-000 | OIO | 85058 | 89431 |     | ...   | ...   |
|         | Model MVP  | 61310101     |     | 85736 | ...   | OIO | 85736 | ...   |
| 06 - 18 | Models with B2 Bus Chassis with FAS II Rear Air Suspension                       | 16-15817-000 |     | ...   | ...   | OIO | 85724 | 89443 |
|         |  | 16-18708-000 |     | ...   | ...   | OIO | 85724 | 89443 |
| - 2018  | Models with Freightliner B2 Bus Chassis & 15000 lb Rear Suspension               | 6803260000   |     | ...   | ...   | OI- | 83120 | ...   |
| 06 - 15 | Models with Freightliner CC B2 Bus Chassis                                       | 10-13634-000 | OIO | 85918 | 89449 |     | ...   | ...   |
| 06 - 18 | Models with Freightliner CC B2 Bus Chassis                                       | 10-13211-000 | OIO | 85918 | 89449 |     | ...   | ...   |
|         | ROC Front, SAF-T-Liner   | 61300285     | -I- | 83102 | ...   |     | ...   | ...   |
|         |  | GBL651442    | -I- | 83102 | ...   |     | ...   | ...   |
|         | SAF-T-Liner HDX Models with Hendrickson Comfort Air Rear Air Suspension          | 471700131545 |     | ...   | ...   | OIO | 85006 | ...   |
|         |  | 60998-001    |     | ...   | ...   | OIO | 85006 | ...   |
|         |  | 60998-003    |     | ...   | ...   | OIO | 85006 | ...   |
|         | SAF-T-Liner School Bus MVP-ER & MVP-EF   | 61300219     | OIO | 85091 | ...   |     | ...   | ...   |
|         |  | 61300222     | OIO | 85091 | ...   |     | ...   | ...   |
|         |  | 61300223     | OIO | 85091 | ...   |     | ...   | ...   |
|         |  | 70445        | OIO | 85091 | ...   |     | ...   | ...   |
| 2009    | SAF-T-Liner School Bus with SAF Holland AD-246 Suspension                        | 90045504     | OIO | 85030 | 89440 |     | ...   | ...   |
| 2009    | SAF-T-Liner School Bus with SAF Holland AD-369 Suspension                        | 90045504     | OIO | 85030 | 89440 |     | ...   | ...   |
|         | School Bus   | 300-0614966  |     | ...   | ...   | OIO | 85307 | ...   |
|         |  | 614966       |     | ...   | ...   | OIO | 85307 | ...   |
|         |  | 614974       | OIO | 85304 | ...   |     | ...   | ...   |
|         |  | 680010       | OIO | 85304 | ...   |     | ...   | ...   |
|         |  | 680054       |     | ...   | ...   | OIO | 85307 | ...   |
| 07 - 12 | Type C Conventional Buses (65 capacity) with 12000 lb Taperleaf Front Suspension | 10-13634-000 | OIO | 85918 | 89449 |     | ...   | ...   |
| - 2017  | Type C Conventional Buses (65 capacity) with FAS II Rear Air Suspension          | 16-15817-000 |     | ...   | ...   | OIO | 85724 | 89443 |
|         |  | 16-18708-000 |     | ...   | ...   | OIO | 85724 | 89443 |
|         |  | 61310434     |     | ...   | ...   | OIO | 85724 | 89443 |
|         |  | 61310478     |     | ...   | ...   | OIO | 85724 | 89443 |
| 2003    | Type C Conventional School buses (65 capacity) with O.E.M. Number                | 680-323-0300 | OIO | 85006 | ...   |     | ...   | ...   |
|         |  | GBL665538    | OIO | 85006 | ...   |     | ...   | ...   |
| 09-12   | Type C School bus chassis with O.E.M. Number                                     | 16-18713-000 |     | ...   | ...   | OI- | 85122 | ...   |
|         |  | 471700003070 |     | ...   | ...   | OI- | 85122 | ...   |

**APPLICATION GUIDE - TRUCKS, TRAILERS, AND BUSES**

| Year<br>Año<br>Année | Model<br>Modelo<br>Modèle | OEM # | Front   |   | Rear  |   |
|----------------------|---------------------------|-------|---|---|---|---|
|                      |                           |       |  |  |  |  |
|                      |                           |       | Fleetline   | GasSLX  | Fleetline   | GasSLX  |

**THOMAS SCHOOL BUS(Cont'd.)**

|  |   |                         |     |              |              |     |              |              |
|--|---|-------------------------|-----|--------------|--------------|-----|--------------|--------------|
|  | Models with Hendrickson Comfort Air Rear Air Suspension | 60670-006<br>60670-006L |     | ...          | ...          | 010 | <b>83147</b> | ...          |
|  |   |                         |     | ...          | ...          | 010 | <b>83147</b> | ...          |
|  | Models with O.E.M. Number                               | 128745                  | -1- | <b>83102</b> | ...          |     | ...          | ...          |
|  |   | 61300112                | -1- | <b>83613</b> | ...          |     | ...          | ...          |
|  |   | 61300224                | 010 | <b>85918</b> | <b>89449</b> |     | ...          | ...          |
|  |   | 61300240                | 010 | <b>85918</b> | <b>89449</b> |     | ...          | ...          |
|  |   | 61310102                |     | ...          | ...          | 010 | <b>85308</b> | <b>89422</b> |
|  |   | 61310103                |     | ...          | ...          | 010 | <b>85308</b> | <b>89422</b> |
|  |   | 651442                  | -1- | <b>83102</b> | ...          |     | ...          | ...          |
|  |   | 659287                  | -1- | <b>83102</b> | ...          |     | ...          | ...          |
|  |   | 680-326-0000            |     | ...          | ...          | 01- | <b>83120</b> | ...          |
|  |   | GBL654725               |     | ...          | ...          | 01- | <b>83120</b> | ...          |
|  | Additional O.E.M. Interchanges                          | 6130-0114               | 010 |              |              |     | <b>89437</b> |              |
|  |   | 6130029                 | 010 |              |              |     | <b>85712</b> |              |
|  |   | 61310104                | 010 |              |              |     | <b>85713</b> |              |
|  |   | 63-0001                 | 010 |              |              |     | <b>85713</b> |              |
|  |   | 680088                  | 010 |              |              |     | <b>85713</b> |              |
|  |   | 680102                  | 010 |              |              |     | <b>85712</b> |              |
|  |   | 728802                  | 010 |              |              |     | <b>85736</b> |              |
|  |   | 87002                   | 010 |              |              |     | <b>85736</b> |              |
|  |   | A-4890                  | 010 |              |              |     | <b>85712</b> |              |

**Type A School Bus**

|                |   |               |     |              |     |     |              |     |
|----------------|---|---------------|-----|--------------|-----|-----|--------------|-----|
| <b>92 - 19</b> | Minotour Type A School bus with Ford E350 Chassis | 8C24-18045-DA | -10 | <b>83177</b> | ... |     | ...          | ... |
|                |   | 8C2Z-18124-D  | -10 | <b>83177</b> | ... |     | ...          | ... |
|                |   | ASH-1154      | -10 | <b>83177</b> | ... |     | ...          | ... |
|                |   | AT-163G       | -10 | <b>83177</b> | ... |     | ...          | ... |
|                |   | 8C24-18080-DB |     | ...          | ... | -10 | <b>83178</b> | ... |
|                |   | 8C2Z-18125-D  |     | ...          | ... | -10 | <b>83178</b> | ... |
|                |   | ASH-1136      |     | ...          | ... | -10 | <b>83178</b> | ... |
|                |   | AT-164G       |     | ...          | ... | -10 | <b>83178</b> | ... |
| <b>00 - 19</b> | Minotour Type A School bus with Ford E450 Chassis | 8C24-18045-DA | -10 | <b>83177</b> | ... |     | ...          | ... |
|                |   | 8C2Z-18124-D  | -10 | <b>83177</b> | ... |     | ...          | ... |
|                |   | ASH-1154      | -10 | <b>83177</b> | ... |     | ...          | ... |
|                |   | AT-163G       | -10 | <b>83177</b> | ... |     | ...          | ... |
|                |   | 8C24-18080-DB |     | ...          | ... | -10 | <b>83178</b> | ... |
|                |   | 8C2Z-18125-D  |     | ...          | ... | -10 | <b>83178</b> | ... |
|                |   | ASH-1136      |     | ...          | ... | -10 | <b>83178</b> | ... |
|                |   | AT-164G       |     | ...          | ... | -10 | <b>83178</b> | ... |

**THOR MOTOR COACH**

**Class A MotorHomes**

|                |   |   |     |              |              |              |              |              |              |     |
|----------------|---|---|-----|--------------|--------------|--------------|--------------|--------------|--------------|-----|
| <b>12 - 19</b> | ACE Series MotorHomes with Ford F53 Chassis with 16,000 lb GVW to 22,000 lb GVW                                   | ASH-1229  | 010 | <b>83209</b> | <b>89414</b> |              | ...          | ...          |              |     |
|                |   | ASH-25822   | 010 | <b>83209</b> | <b>89414</b> |              | ...          | ...          |              |     |
|                |   | ASH-25823   | 010 | <b>83209</b> | <b>89414</b> |              | ...          | ...          |              |     |
|                |   | ASH-25824   |     | ...          | ...          | 010          | <b>83122</b> | <b>89406</b> |              |     |
| <b>2006</b>    | Astoria Series MotorHomes with Freightliner XC Chassis<br>ADL200 Suspension w/ 20K Rear<br>AS120 Front Suspension | 16-16873-000  |     | ...          | ...          | 010          | <b>85029</b> | ...          |              |     |
|                |   | 141700131810  | 010 | <b>83160</b> | ...          |              | ...          | ...          |              |     |
|                |   | 16-16737-000  | 010 | <b>83160</b> | ...          |              | ...          | ...          |              |     |
|                |   | 16-16874-000  | 010 | <b>83160</b> | ...          |              | ...          | ...          |              |     |
|                |   | Rear Shock with O.E.M. Number                           |     | 141700131809 |              | ...          | ...          | 010          | <b>85029</b> | ... |
|                |   |   |     | 16-16736-000 |              | ...          | ...          | 010          | <b>85029</b> | ... |
|                |   | ZF - IFS Front Suspension with 23,000 lb GVW or Greater |     | 16-18103-000 | -1-          | <b>85900</b> | ...          |              | ...          | ... |
|                |   |   |     | 481700000493 | -1-          | <b>85900</b> | ...          |              | ...          | ... |
| <b>14 - 19</b> | Axis Series MotorHomes with Ford E450 Chassis   | ASH-1136  |     | ...          | ...          | -10          | <b>83178</b> | ...          |              |     |

## APPLICATION GUIDE - TRUCKS, TRAILERS, AND BUSES

| Year<br>Año<br>Année | Model<br>Modelo<br>Modèle | OEM # | Front     |        | Rear      |        |
|----------------------|---------------------------|-------|-----------|--------|-----------|--------|
|                      |                           |       |           |        |           |        |
|                      |                           |       | Fleetline | GasSLX | Fleetline | GasSLX |

### THOR MOTOR COACH(Cont'd.)

#### Class A MotorHomes(Cont'd.)

|         |  |              |     |       |       |     |       |       |
|---------|--|--------------|-----|-------|-------|-----|-------|-------|
| 14 - 19 | Axis Series MotorHomes with Ford E450 Chassis  | ASH-1154     | -10 | 83177 | ...   |     | ...   | ...   |
| 05 - 19 | Challenger Series MotorHomes with Ford F53 Chassis with 16,000 lb GVW to 22,000 lb GVW   | ASH-1229     | 010 | 83209 | 89414 |     | ...   | ...   |
|         |  | ASH-25822    | 010 | 83209 | 89414 |     | ...   | ...   |
|         |  | ASH-25823    | 010 | 83209 | 89414 |     | ...   | ...   |
|         |  | ASH-25824    |     | ...   | ...   | 010 | 83122 | 89406 |
| 02 - 05 | Escaper Series MotorHomes with Freightliner XC Chassis<br>ADL200 Suspension w/ 20K Rear<br>AS120 Front Suspension<br><br>Rear Shock with O.E.M. Number<br><br>ZF - IFS Front Suspension with 23,000 lb GVW or Greater    | 16-16873-000 |     | ...   | ...   | 010 | 85029 | ...   |
|         |  | 141700131810 | 010 | 83160 | ...   |     | ...   | ...   |
|         |  | 16-16737-000 | 010 | 83160 | ...   |     | ...   | ...   |
|         |  | 16-16874-000 | 010 | 83160 | ...   |     | ...   | ...   |
|         |  | 141700131809 |     | ...   | ...   | 010 | 85029 | ...   |
|         |  | 16-16736-000 |     | ...   | ...   | 010 | 85029 | ...   |
|         |  | 16-18103-000 | -1- | 85900 | ...   |     | ...   | ...   |
|         |  | 481700000493 | -1- | 85900 | ...   |     | ...   | ...   |
| 04 - 19 | Hurricane Series MotorHomes with Ford F53 Chassis with 16,000 lb GVW to 22,000 lb GVW  | ASH-1229     | 010 | 83209 | 89414 |     | ...   | ...   |
|         |  | ASH-25822    | 010 | 83209 | 89414 |     | ...   | ...   |
|         |  | ASH-25823    | 010 | 83209 | 89414 |     | ...   | ...   |
|         |  | ASH-25824    |     | ...   | ...   | 010 | 83122 | 89406 |
| 14 - 19 | Miramar Series MotorHomes with Ford F53 Chassis with 16,000 lb GVW to 22,000 lb GVW  | ASH-1229     | 010 | 83209 | 89414 |     | ...   | ...   |
|         |  | ASH-25822    | 010 | 83209 | 89414 |     | ...   | ...   |
|         |  | ASH-25823    | 010 | 83209 | 89414 |     | ...   | ...   |
|         |  | ASH-25824    |     | ...   | ...   | 010 | 83122 | 89406 |
| 07 - 19 | Outlaw Series MotorHomes with Ford F53 Chassis with 16,000 lb GVW to 22,000 lb GVW   | ASH-1229     | 010 | 83209 | 89414 |     | ...   | ...   |
|         |  | ASH-25822    | 010 | 83209 | 89414 |     | ...   | ...   |
|         |  | ASH-25823    | 010 | 83209 | 89414 |     | ...   | ...   |
|         |  | ASH-25824    |     | ...   | ...   | 010 | 83122 | 89406 |
| 2006    | Tuscany Series MotorHomes with Freightliner XC Chassis<br>ADL200 Suspension w/ 20K Rear<br>AS120 Front Suspension<br><br>Rear Shock with O.E.M. Number<br><br>ZF - IFS Front Suspension with 23,000 lb GVW or Greater    | 16-16873-000 |     | ...   | ...   | 010 | 85029 | ...   |
|         |  | 141700131810 | 010 | 83160 | ...   |     | ...   | ...   |
|         |  | 16-16737-000 | 010 | 83160 | ...   |     | ...   | ...   |
|         |  | 16-16874-000 | 010 | 83160 | ...   |     | ...   | ...   |
|         |  | 141700131809 |     | ...   | ...   | 010 | 85029 | ...   |
|         |  | 16-16736-000 |     | ...   | ...   | 010 | 85029 | ...   |
|         |  | 16-18103-000 | -1- | 85900 | ...   |     | ...   | ...   |
|         |  | 481700000493 | -1- | 85900 | ...   |     | ...   | ...   |
| 02 - 05 | UltraSport Series MotorHomes with Freightliner XC Chassis<br>ADL200 Suspension w/ 20K Rear<br>AS120 Front Suspension<br><br>Rear Shock with O.E.M. Number<br><br>ZF - IFS Front Suspension with 23,000 lb GVW or Greater | 16-16873-000 |     | ...   | ...   | 010 | 85029 | ...   |
|         |  | 141700131810 | 010 | 83160 | ...   |     | ...   | ...   |
|         |  | 16-16737-000 | 010 | 83160 | ...   |     | ...   | ...   |
|         |  | 16-16874-000 | 010 | 83160 | ...   |     | ...   | ...   |
|         |  | 141700131809 |     | ...   | ...   | 010 | 85029 | ...   |
|         |  | 16-16736-000 |     | ...   | ...   | 010 | 85029 | ...   |
|         |  | 16-18103-000 | -1- | 85900 | ...   |     | ...   | ...   |
|         |  | 481700000493 | -1- | 85900 | ...   |     | ...   | ...   |
| 14 - 19 | Vegas Series MotorHomes with Ford E450 Chassis   | ASH-1136     |     | ...   | ...   | -10 | 83178 | ...   |
|         |  | ASH-1154     | -10 | 83177 | ...   |     | ...   | ...   |
| 06 - 19 | WindSport Series MotorHomes with Ford F53 Chassis with 16,000 lb GVW to 22,000 lb GVW  | ASH-1229     | 010 | 83209 | 89414 |     | ...   | ...   |
|         |  | ASH-25822    | 010 | 83209 | 89414 |     | ...   | ...   |
|         |  | ASH-25823    | 010 | 83209 | 89414 |     | ...   | ...   |
|         |  | ASH-25824    |     | ...   | ...   | 010 | 83122 | 89406 |



## APPLICATION GUIDE - TRUCKS, TRAILERS, AND BUSES

| Year<br>Año<br>Année | Model<br>Modelo<br>Modèle | OEM # | Front |  |  | Rear      |        |           |
|----------------------|---------------------------|-------|-------|--|--|-----------|--------|-----------|
|                      |                           |       |       |  |  |           |        |           |
|                      |                           |       |       |  |  | Fleetline | GasSLX | Fleetline |

### THOR MOTOR COACH(Cont'd.)

#### Class C MotorHomes(Cont'd.)

|         |  |          |     |       |     |     |       |     |
|---------|--|----------|-----|-------|-----|-----|-------|-----|
| 08 - 13 | Chateau Citation Series MotorHomes with Ford E350 & E450 Chassis | ASH-1136 |     | ...   | ... | -10 | 83178 | ... |
|         |  | ASH-1154 | -10 | 83177 | ... |     | ...   | ... |
| 99 - 19 | Chateau Series MotorHomes with Ford E350 & E450 Chassis          | ASH-1136 |     | ...   | ... | -10 | 83178 | ... |
|         |  | ASH-1154 | -10 | 83177 | ... |     | ...   | ... |
| 01 - 14 | Citation Series MotorHomes with Ford E350 & E450 Chassis         | ASH-1136 |     | ...   | ... | -10 | 83178 | ... |
|         |  | ASH-1154 | -10 | 83177 | ... |     | ...   | ... |
| 01 - 19 | Four Winds Series MotorHomes with Ford E350 & E450 Chassis       | ASH-1136 |     | ...   | ... | -10 | 83178 | ... |
|         |  | ASH-1154 | -10 | 83177 | ... |     | ...   | ... |
| 10 - 19 | Freedom Elite Series MotorHomes with Ford E350 & E450 Chassis    | ASH-1136 |     | ...   | ... | -10 | 83178 | ... |
|         |  | ASH-1154 | -10 | 83177 | ... |     | ...   | ... |
| 12 - 14 | Majestic Series MotorHomes with Ford E350 & E450 Chassis         | ASH-1136 |     | ...   | ... | -10 | 83178 | ... |
|         |  | ASH-1154 | -10 | 83177 | ... |     | ...   | ... |
| 16 - 19 | Outlaw Series MotorHomes with Ford E350 & E450 Chassis           | ASH-1136 |     | ...   | ... | -10 | 83178 | ... |
|         |  | ASH-1154 | -10 | 83177 | ... |     | ...   | ... |
| 16 - 19 | Quantum Series MotorHomes with Ford E350 & E450 Chassis          | ASH-1136 |     | ...   | ... | -10 | 83178 | ... |
|         |  | ASH-1154 | -10 | 83177 | ... |     | ...   | ... |

### TIFFIN MOTORHOMES INC

|   |            |     |       |     |  |     |     |  |
|---|------------|-----|-------|-----|--|-----|-----|--|
| Models with Freightliner Chassis - See Freightliner section for proper year and model information | .....      |     | ..... |     |  |     |     |  |
| Models with Hendrickson Softek Suspension   | 58913-009  | 010 | 85959 | ... |  | ... | ... |  |
|   | 58913-009L | 010 | 85959 | ... |  | ... | ... |  |
| Models with Workhorse Chassis - See Workhorse section for proper year and model information       | .....      |     | ..... |     |  |     |     |  |

### TIMBREN INDUSTRIES

|                                |        |     |       |  |  |  |  |  |
|--------------------------------|--------|-----|-------|--|--|--|--|--|
| Additional O.E.M. Interchanges | 665804 | 010 | 85939 |  |  |  |  |  |
|--------------------------------|--------|-----|-------|--|--|--|--|--|

### TRAIL KING INDUSTRIES

|   |  |  |  |  |  |  |  |
|---|--|--|--|--|--|--|--|
| Identification of the trailer suspension is necessary to determine what section of the catalog to refer to. Some possible options can be Chalmers, Hendrickson, Neway, Ridewell, Reyco. |  |  |  |  |  |  |  |
|---|--|--|--|--|--|--|--|

### TRAILMOBILE CANADA CORP.

|  |          |  |     |     |     |       |       |
|--|----------|--|-----|-----|-----|-------|-------|
| Trailers with Granning Air Susp. T-350A                                | 43-8-022 |  | ... | ... | 010 | 83225 | ...   |
| Trailers with Hendrickson Air Susp. HT230T (23,000 lb Capacity)        | 43-6-118 |  | ... | ... | 010 | 85000 | 89436 |
| Trailers with Hendrickson Air Susp. HT250U, HT250U-Y                   | A-2212   |  | ... | ... | 010 | 85029 | ...   |
| Trailers with Hendrickson Air Susp. T23-RL-17                          | 43-8-011 |  | ... | ... | 010 | 83207 | 89407 |
| Trailers with Hendrickson Air Susp. T23-US-6 (Non-Liftable)            | 43-8-015 |  | ... | ... | 010 | 85006 | ...   |
| Trailers with Hendrickson Air Susp. T23-US-9 (Liftable & Non-Liftable) | 43-8-014 |  | ... | ... | 010 | 85013 | 89414 |
| Trailers with Hendrickson Air Susp. T30-US-9, -12, -14, -17            | 43-8-013 |  | ... | ... | 010 | 85000 | 89436 |
| Trailers with Neway Air Susp. AR90-1-14, AR90-1-17                     | 90044089 |  | ... | ... | 010 | 83124 | 89407 |
| Trailers with Neway Air Susp. AR90-14, -17,                            | 90044089 |  | ... | ... | 010 | 83124 | 89407 |
| Trailers with Neway Air Susp. AR92-14                                  | 90044992 |  | ... | ... | 010 | 85000 | 89436 |
| Trailers with Neway Air Susp. AR92-17                                  | 90044642 |  | ... | ... | 010 | 83127 | ...   |
| Trailers with Neway Air Susp. AR93-14                                  | 90045054 |  | ... | ... | 010 | 85051 | ...   |
| Trailers with Neway Air Susp. AR93-17                                  | 90044089 |  | ... | ... | 010 | 83124 | 89407 |
| Trailers with Neway Air Susp. AR95-9-HD, -12-HD, -14-HD, 17-HD         | 90044625 |  | ... | ... | 010 | 83125 | ...   |
| Trailers with Neway Air Susp. RL196-12                                 | 90044977 |  | ... | ... | 010 | 83115 | ...   |
| Trailers with Neway Air Susp. RL196-14, -15                            | 90044978 |  | ... | ... | 010 | 85059 | ...   |
| Trailers with Neway Air Susp. RL196-16, -17                            | 90044979 |  | ... | ... | 010 | 83113 | ...   |
| Trailers with Reyco Air Susp. Model # 21AR (25,000 LB Capacity)        | 43-8-002 |  | ... | ... | 010 | 83209 | 89414 |

## APPLICATION GUIDE - TRUCKS, TRAILERS, AND BUSES

| Year<br>Año<br>Année | Model<br>Modelo<br>Modèle | OEM # | Front |  |  | Rear      |        |           |
|----------------------|---------------------------|-------|-------|--|--|-----------|--------|-----------|
|                      |                           |       |       |  |  |           |        |           |
|                      |                           |       |       |  |  | Fleetline | GasSLX | Fleetline |

### TRAILMOBILE CANADA CORP.(Cont'd.)

|  |          |     |     |     |              |              |              |
|--|----------|-----|-----|-----|--------------|--------------|--------------|
| Trailers with Reyco Air Susp. Model # 74AR ( 30,000 LB Capacity) | 43-8-002 |     | ... | ... | 010          | <b>83209</b> | <b>89414</b> |
| Trailers with Reyco Air Susp. Model # 86AR                       | 43-8-015 |     | ... | ... | 010          | <b>85006</b> | ...          |
| Models with O.E.M. Number  | 43-4-235 |     | ... | ... | 010          | <b>85051</b> | ...          |
|  | 43-4-236 |     | ... | ... | 010          | <b>85029</b> | ...          |
|  | 43-4-237 |     | ... | ... | 010          | <b>85000</b> | <b>89436</b> |
|  | 43-4-239 |     | ... | ... | 010          | <b>83207</b> | <b>89407</b> |
|  | 43-4-241 |     | ... | ... | 010          | <b>85006</b> | ...          |
|  | 43-4-277 |     | ... | ... | 010          | <b>85000</b> | <b>89436</b> |
|  | 43-4-278 |     | ... | ... | 010          | <b>85059</b> | ...          |
|  | 43-4-279 |     | ... | ... | 010          | <b>83204</b> | ...          |
|  | 43-6-028 |     | ... | ... | 010          | <b>85000</b> | <b>89436</b> |
|  | 43-6-137 |     | ... | ... | 010          | <b>85006</b> | ...          |
|  | 43-6-158 |     | ... | ... | 010          | <b>85013</b> | <b>89414</b> |
|  | 43-6-164 |     | ... | ... | 010          | <b>83207</b> | <b>89407</b> |
| 43-8-031   |          | ... | ... | 010 | <b>85029</b> | ...          |              |

### TRANSPORTATION MFG. CORP

|  |            |     |              |     |     |              |              |
|--|------------|-----|--------------|-----|-----|--------------|--------------|
| City Cruiser   | 12TA-01-13 |     | <b>85303</b> | ... | 010 | <b>85303</b> | <b>89422</b> |
| Drive Axle   | 12J-5-10   |     | ...          | ... | 01- | <b>85733</b> | ...          |
|  | 12J-5-2    |     | ...          | ... | 01- | <b>85733</b> | ...          |
|  | 12J-5-4    |     | ...          | ... | 01- | <b>85733</b> | ...          |
| G 4500 Coach<br>(Front)<br>45 ft Coach -Tag Axle<br>Tag Axle | 12-05-6000 | -10 | <b>85711</b> | ... |     | ...          | ...          |
|  | 12-05-6033 |     | ...          | ... | 010 | <b>85339</b> | ...          |
|  | 12-05-6002 |     | ...          | ... | 010 | <b>85339</b> | ...          |
| Low Floor Bus Models with O.E.M. Number                      | 12L-5-99   |     | ...          | ... | 010 | <b>85339</b> | ...          |
| RTS Bus with "V" Drive Rear                                  | G1101590   |     | ...          | ... | 010 | <b>85713</b> | ...          |
| RTS Bus with Regular Rear                                    | 22045526   |     | ...          | ... | 010 | <b>85702</b> | ...          |
|  | 22052014   |     | ...          | ... | 010 | <b>85702</b> | ...          |
|  | G1011822   |     | ...          | ... | 010 | <b>85702</b> | ...          |
| RTS Bus with Solid Front Axle                                | 22024673   | -10 | <b>85710</b> | ... |     | ...          | ...          |
|  | 22046485   | -10 | <b>85710</b> | ... |     | ...          | ...          |
|  | 680350     | -10 | <b>85710</b> | ... |     | ...          | ...          |
|  | 695273     | -10 | <b>85710</b> | ... |     | ...          | ...          |
|  | 695279     | -10 | <b>85710</b> | ... |     | ...          | ...          |
| Tag Axle   | 12J-5-11   |     | ...          | ... | 010 | <b>85313</b> | ...          |
|  | 12J-5-3    |     | ...          | ... | 010 | <b>85313</b> | ...          |
|  | 12J-5-6    |     | ...          | ... | 010 | <b>85313</b> | ...          |
|  | 12J-5-9    |     | ...          | ... | 010 | <b>85700</b> | ...          |
| Models with O.E.M. Number                                    | 12B-5-1    |     | ...          | ... | 010 | <b>85735</b> | ...          |
|  | 12G-5-1    | 010 | <b>85700</b> | ... |     | ...          | ...          |
|  | 12T-1-13   |     | <b>85303</b> | ... | 010 | <b>85303</b> | <b>89422</b> |
|  | 680349     |     | ...          | ... | 010 | <b>85702</b> | ...          |
|  | 680470     |     | ...          | ... | 010 | <b>85713</b> | ...          |
| Additional O.E.M. Interchanges                               | 12L-5-69   | 010 | <b>85700</b> |     |     |              |              |
|  | 12L-5-70   | 010 | <b>85700</b> |     |     |              |              |





### TRINITY TRAILER MFG., INC.

Identification of the trailer suspension is necessary to determine what section of the catalog to refer to. Some possible options can be Chalmers, Hendrickson, Neway, Ridewell, Reyco.

### TURNER-QUICK LIFT - SEE HENDRICKSON SUSPENSION

|  |  |  |  |  |  |  |  |
|--|--|--|--|--|--|--|--|
|  |  |  |  |  |  |  |  |
|--|--|--|--|--|--|--|--|

## APPLICATION GUIDE - TRUCKS, TRAILERS, AND BUSES

| Year<br>Año<br>Année | Model<br>Modelo<br>Modèle | OEM # | Front   |   | Rear  |   |
|----------------------|---------------------------|-------|---|---|---|---|
|                      |                           |       |  |  |  |  |
|                      |                           |       | Fleetline   | GasSLX  | Fleetline   | GasSLX  |

### TURTLETOP BUS

|        |  |          |     |       |     |       |     |
|--------|--|----------|-----|-------|-----|-------|-----|
| - 2019 | Odyssey Series Shuttle buses with Ford E450 Chassis              | ASH-1136 | ... | ...   | -10 | 83178 | ... |
|        |  | ASH-1154 | -10 | 83177 | ... | ...   | ... |
| - 2019 | Terra Transit Series Shuttle buses with Ford E350 & E450 Chassis | ASH-1136 | ... | ...   | -10 | 83178 | ... |
|        |  | ASH-1154 | -10 | 83177 | ... | ...   | ... |
| - 2019 | Vanterra Series Shuttle buses with Ford E350 Chassis             | ASH-1136 | ... | ...   | -10 | 83178 | ... |
|        |  | ASH-1154 | -10 | 83177 | ... | ...   | ... |

### TUTHILL TECHNOLOGIES

#### Drive Axle

|   |          |     |     |     |       |       |
|---|----------|-----|-----|-----|-------|-------|
| 101A, 101AR Models                              | 18166-01 | ... | ... | 010 | 85704 | ...   |
| 102AR (Hvy Duty) Models                         | 18286-01 | ... | ... | 010 | ...   | 89414 |
| 102AR (Special) Models                          | 17146-01 | ... | ... | 010 | 83209 | 89414 |
| 102AR (Standard) Models                         | 12887-02 | ... | ... | 010 | 85013 | 89414 |
| 102AR for Western Star Models                   | 19824-01 | ... | ... | 010 | 85006 | ...   |
| 102AR-7 Models                                  | 17794-01 | ... | ... | 010 | 83215 | ...   |
| 102AR-LM Models                                 | 19623-01 | ... | ... | 010 | 83123 | 89405 |
| 200 Models Air Suspension                       | 20129-01 | ... | ... | 010 | 85007 | 89412 |
| 240AR Air-Ride Suspension<br>With O.E.M. Number | 20125-01 | ... | ... | 010 | 85030 | 89440 |
|   | 20126-01 | ... | ... | 010 | ...   | 89440 |
| 74AR - 30000 lb Capacity                        | 12887-01 | ... | ... | 010 | 85013 | 89414 |
| 79KB Models                                     | 16725-01 | ... | ... | 010 | 83126 | ...   |
|   | 19495-01 | ... | ... | 010 | 83126 | ...   |







#### Steer Axle

|                         |          |     |       |       |     |     |
|-------------------------|----------|-----|-------|-------|-----|-----|
| 1207 Models             | 17403-01 | 010 | 83122 | 89406 | ... | ... |
| 1209 (Alternate) Models | 17408-01 | 010 | 85005 | 89430 | ... | ... |
| 1209, 1212 Models       | 17358-01 | 010 | 83126 | 89430 | ... | ... |
|                         | 19495-01 | 010 | 83126 | 89440 | ... | ... |
| 21B Models              | 14954-01 | 010 | 83217 | ...   | ... | ... |

#### Trailer

|   |           |     |     |     |       |       |
|---|-----------|-----|-----|-----|-------|-------|
| 21B (Special) Models                                    | 18800-01  | ... | ... | 010 | 83203 | 89436 |
| 25 ART Models with O.E.M. Number                        | 24392-01  | ... | ... | 010 | 85051 | ...   |
| 25 ARU Models with O.E.M. Number                        | 23553-01  | ... | ... | 010 | 85938 | ...   |
| 30 ARUUL - 12 and -17 Models                            | 23524-01  | ... | ... | 010 | 85738 | ...   |
| 81S Models  | 12885-03  | ... | ... | 010 | 85300 | 89419 |
| 86 AR / RS 1015, 1035, 3015, 3035 Slider Air Suspension | 18165-01  | ... | ... | 010 | 85006 | ...   |
| 87 for Great Dane Models                                | 18163-01  | ... | ... | 010 | 83207 | 89407 |
|   | 18164-01  | ... | ... | 010 | 83122 | 89406 |
| 87-14 (Rear Mount) Models                               | 18146-01  | ... | ... | 010 | 85313 | ...   |
| 87-14, -17 Models                                       | 16230-01  | ... | ... | 010 | 85702 | ...   |
| 87-6, 87-9 Models                                       | 12885-01  | ... | ... | 010 | 85300 | 89419 |
| Models with O.E.M. Number                               | 1085      | ... | ... | 010 | 83214 | ...   |
|   | 16824-01  | ... | ... | 010 | 85006 | ...   |
|   | 17142-01  | ... | ... | 010 | 85001 | 89410 |
|   | 20960-01  | ... | ... | 010 | 83204 | ...   |
|   | 21497-01  | ... | ... | 010 | 85005 | 89430 |
|   | 23614-01  | ... | ... | 010 | 85717 | ...   |
|   | 2697      | ... | ... | 010 | 85712 | ...   |
|   | 680162    | ... | ... | 010 | 85300 | 89419 |
|   | 702135-01 | ... | ... | 010 | 85045 | ...   |
|   | 702136-01 | ... | ... | 010 | 85052 | ...   |
|   | 702209-01 | ... | ... | 010 | 85014 | ...   |
|   | OE12425   | ... | ... | 010 | 83214 | ...   |

## APPLICATION GUIDE - TRUCKS, TRAILERS, AND BUSES

| Year<br>Año<br>Année | Model<br>Modelo<br>Modèle | OEM # | Front  |   |   | Rear  |   |   |
|----------------------|---------------------------|-------|--|---|---|---|---|---|
|                      |                           |       |  |  |  |  |  |  |

### TWIN COACH

|  |                           |          |             |     |     |     |              |              |              |
|--|---------------------------|----------|-------------|-----|-----|-----|--------------|--------------|--------------|
|  | Models with O.E.M. Number | 90044089 |             | ... | ... | ○ ○ | <b>83124</b> | <b>89407</b> |              |
|  |                           |          | 90044089C   |     | ... | ... | ○ ○          | <b>83124</b> | <b>89407</b> |
|  |                           |          | 90044162    |     | ... | ... | ○ ○          | <b>83128</b> | <b>89436</b> |
|  |                           |          | AR-718-C-HD |     | ... | ... | ○ ○          | <b>85000</b> | <b>89436</b> |
|  |                           |          | AR-958      |     | ... | ... | ○ ○          | <b>83207</b> | <b>89407</b> |

### UNITED MANUFACTURING

|  |                           |         |  |     |     |     |              |     |
|--|---------------------------|---------|--|-----|-----|-----|--------------|-----|
|  | Models with O.E.M. Number | K-96-41 |  | ... | ... | ○ ○ | <b>85304</b> | ... |
|--|---------------------------|---------|--|-----|-----|-----|--------------|-----|

### UNIVERSAL COACH

|  |                           |            |        |     |     |     |              |              |
|--|---------------------------|------------|--------|-----|-----|-----|--------------|--------------|
|  | Models with O.E.M. Number | 12-05-1199 |        | ... | ... | ○ - | <b>85729</b> | ...          |
|  |                           |            | 680777 |     | ... | ... | ○ -          | <b>85729</b> |

### UPS TRUCK

|  |                           |         |         |     |              |     |              |     |
|--|---------------------------|---------|---------|-----|--------------|-----|--------------|-----|
|  | Models with O.E.M. Number | P117099 |         | ... | ...          | ○ - | <b>83120</b> | ... |
|  |                           |         | P117146 | ○ ○ | <b>83118</b> | ... |              | ... |

### UTILITY TRAILER MANUFACTURING COMPANY

|   |  |  |  |  |  |  |  |  |
|---|--|--|--|--|--|--|--|--|
| Identification of the trailer suspension is necessary to determine what section of the catalog to refer to. Some possible options can be Chalmers, Hendrickson, Neway, Ridewell, Reyco. |  |  |  |  |  |  |  |  |
|---|--|--|--|--|--|--|--|--|

#### Flatbeds

|  |   |  |  |     |     |     |              |              |
|--|---|--|--|-----|-----|-----|--------------|--------------|
|  | 4000A Model Trailers with Hendrickson AANT 23K Intraax Air Ride<br>(High Damping)<br>(Hvy Duty)<br>(Limited Rebound)<br>(Standard)  | B-24023<br>B-24125<br>B-23361<br>B-23566 |  | ... | ... | ○ ○ | <b>85738</b> | ...          |
|  |   |  |  | ... | ... | ○ ○ | <b>85323</b> | <b>89436</b> |
|  |   |  |  | ... | ... | ○ ○ | <b>85911</b> | ...          |
|  |   |  |  | ... | ... | ○ ○ | <b>85000</b> | <b>89436</b> |
|  | Drop Deck Trailers with Hendrickson AANL 23K Intraax Air Ride<br>with 12" to 17" Ride Height - High Damping<br>with 6.5" to 9" Ride Height - High Damping<br>with 6.5" to 9" Ride Height - Standard | B-25515<br>B-24579<br>B-23651            |  | ... | ... | ○ ○ | <b>85338</b> | ...          |
|  |   |  |  | ... | ... | ○ ○ | <b>85939</b> | ...          |
|  |   |  |  | ... | ... | ○ ○ | <b>85045</b> | ...          |





#### Reefers & Dry Vans

|  |   |                    |          |         |     |     |              |              |              |
|--|---|--------------------|----------|---------|-----|-----|--------------|--------------|--------------|
|  | 3000R Multi-Temp Trailers with Hendrickson HKANT 40K Vantraax Air Ride<br>Heavy Duty  | B-24088<br>S-24088 |          | ...     | ... | ○ ○ | <b>85000</b> | <b>89436</b> |              |
|  |   |                    |          | ...     | ... | ○ ○ | <b>85000</b> | <b>89436</b> |              |
|  |   |                    | Standard | B-24088 | ... | ... | ○ ○          | <b>83128</b> | <b>89436</b> |
|  |   |                    |          | S-24088 | ... | ... | ○ ○          | <b>83128</b> | <b>89436</b> |
|  | 4000D Trailers with Hendrickson HKANT 40K Vantraax Air Ride<br>Heavy Duty             | B-24088<br>S-24088 |          | ...     | ... | ○ ○ | <b>85000</b> | <b>89436</b> |              |
|  |   |                    |          | ...     | ... | ○ ○ | <b>85000</b> | <b>89436</b> |              |
|  |   |                    | Standard | B-24088 | ... | ... | ○ ○          | <b>83128</b> | <b>89436</b> |
|  |   |                    |          | S-24088 | ... | ... | ○ ○          | <b>83128</b> | <b>89436</b> |
|  | 4000D-X Composite Trailers with Hendrickson HKANT 40K Vantraax Air Ride<br>Heavy Duty | B-24088<br>S-24088 |          | ...     | ... | ○ ○ | <b>85000</b> | <b>89436</b> |              |
|  |   |                    |          | ...     | ... | ○ ○ | <b>85000</b> | <b>89436</b> |              |
|  |   |                    | Standard | B-24088 | ... | ... | ○ ○          | <b>83128</b> | <b>89436</b> |
|  |   |                    |          | S-24088 | ... | ... | ○ ○          | <b>83128</b> | <b>89436</b> |

### VAN HOOL

|         |   |                                  |  |              |     |     |               |     |
|---------|---|----------------------------------|--|--------------|-----|-----|---------------|-----|
| 00 - 09 | T2145 and T2150 Buses with O.E.M. Number (Front & Tag Axle) | 10685703<br>624314570<br>90-2291 |  | ...          | ... | - - | <b>695406</b> | ... |
|         |   |                                  |  | ...          | ... | - - | <b>695406</b> | ... |
|         |   |                                  |  | ...          | ... | - - | <b>695406</b> | ... |
|         | T811, T812, T813, T814 Buses                                | 6243-14040                       |  | <b>85708</b> | ... | - - | <b>85708</b>  | ... |

**APPLICATION GUIDE - TRUCKS, TRAILERS, AND BUSES**

| Year<br>Año<br>Année | Model<br>Modelo<br>Modèle | OEM # | Front   |   | Rear  |   |
|----------------------|---------------------------|-------|---|---|---|---|
|                      |                           |       |  |  |  |  |
|                      |                           |       | Fleetline   | GasSLX  | Fleetline   | GasSLX  |

**VAN HOOL(Cont'd.)**

|                | T811, T812, T813, T814 Buses | 665563     |  | <b>85708</b> | ... | - - | <b>85708</b>  | ... |
|----------------|------------------------------|------------|--|--------------|-----|-----|---------------|-----|
|                | T815 4D Buses                | 6243-14040 |  | ...          | ... | - - | <b>85708</b>  | ... |
|                |                              | 665563     |  | ...          | ... | - - | <b>85708</b>  | ... |
| <b>00 - 09</b> | T940 and T945 Buses          | 624314570  |  | ...          | ... | - - | <b>695406</b> | ... |
|                |                              | 90-2291    |  | ...          | ... | - - | <b>695406</b> | ... |
|                | TL 13/14 Buses               | 6243-13790 |  | <b>85708</b> | ... | - - | <b>85708</b>  | ... |
|                |                              | 665562     |  | <b>85708</b> | ... | - - | <b>85708</b>  | ... |

**VOLVO**

**FE Series**

|  |   |         |     |              |     |     |              |              |
|--|---|---------|-----|--------------|-----|-----|--------------|--------------|
|  | FE6 Models  | 6857668 | - O | <b>83105</b> | ... |     | ...          | ...          |
|  |   | 6876828 | - O | <b>83105</b> | ... |     | ...          | ...          |
|  | FE611, FE614 Front after CH419306                 | 6794358 | O O | <b>85040</b> | ... |     | ...          | ...          |
|  | FE614 Tractor                                     | 6790756 |     | ...          | ... | O O | <b>83215</b> | ...          |
|  |   | 6794358 | O O | <b>85040</b> | ... |     | ...          | ...          |
|  | FE615, FE715                                      | 6772218 | O O | <b>85040</b> | ... |     | ...          | ...          |
|  |   | 6775412 | O O | <b>85040</b> | ... |     | ...          | ...          |
|  | FE7 Models up to Chassis No. 20855                | 1505190 |     | ...          | ... | - - | <b>85722</b> | ...          |
|  | FE7 Models with over 6.5 Front Axle (Ton)         | 1590439 | O O | <b>83104</b> | ... |     | ...          | ...          |
|  | FE7 Models with Rear Air Suspension (Drive Axle)  | 1591501 |     | ...          | ... | - - | <b>85722</b> | ...          |
|  | FE715 with Rear Parabolic Spring                  | 6790756 |     | ...          | ... | O O | <b>83215</b> | ...          |
|  | Models with Rear Air Suspension and O.E.M. Number | 8056892 |     | ...          | ... | O O | <b>85023</b> | <b>89415</b> |

**N Series**

|  |                                  |                 |     |              |     |  |     |     |
|--|----------------------------------|-----------------|-----|--------------|-----|--|-----|-----|
|  | N10 with 5.5 Ton Front Axle      | 1593843         | O O | <b>83215</b> | ... |  | ... | ... |
|  | N11 Models                       | 1-0200-32-888-1 | O O | <b>83104</b> | ... |  | ... | ... |
|  |                                  | 1591735         | O O | <b>83104</b> | ... |  | ... | ... |
|  |                                  | 1593843         | O O | <b>83215</b> | ... |  | ... | ... |
|  | N12 Models                       | 1-0200-32-888-1 | O O | <b>83104</b> | ... |  | ... | ... |
|  |                                  | 1591735         | O O | <b>83104</b> | ... |  | ... | ... |
|  |                                  | 1593843         | O O | <b>83215</b> | ... |  | ... | ... |
|  | N12 with over 6.5 Ton Front Axle | 1590439         | O O | <b>83104</b> | ... |  | ... | ... |

**VAH Series**

|             |   |              |     |              |     |     |              |     |
|-------------|---|--------------|-----|--------------|-----|-----|--------------|-----|
|             | VAH 430 Models with Hendrickson HAS 400 or 460 Series Rear Suspension | 60675-001    |     | ...          | ... | O O | <b>85978</b> | ... |
|             |   | 60675-001L   |     | ...          | ... | O O | <b>85978</b> | ... |
|             |   | 8083872      |     | ...          | ... | O O | <b>85978</b> | ... |
| <b>2014</b> | VAH 430 Models with O.E.M. Number                                     | 141700005838 | O O | <b>85098</b> | ... |     | ...          | ... |
|             |   | 21436086     | O O | <b>85098</b> | ... |     | ...          | ... |

**VHD - Series**

|                |  |                 |     |              |     |     |              |     |
|----------------|--|-----------------|-----|--------------|-----|-----|--------------|-----|
| <b>08 - 17</b> | Models with 12,000 to 22,000 lb Front Axles                                | 20353932        | O - | <b>85081</b> | ... |     | ...          | ... |
|                |  | 20414440        | O - | <b>85081</b> | ... |     | ...          | ... |
|                |  | 20433426        | O - | <b>85081</b> | ... |     | ...          | ... |
|                |  | 20434880        | O - | <b>85081</b> | ... |     | ...          | ... |
|                |  | 471700131258    | O - | <b>85081</b> | ... |     | ...          | ... |
|                |  | SDA471700131258 | O - | <b>85081</b> | ... |     | ...          | ... |
| <b>- 2017</b>  | Models with Hendrickson 40,000 lb Pimaax EX and FireMaax EX Air Suspension | 20782199        |     | ...          | ... | O O | <b>85072</b> | ... |
|                |  | 60657-007       |     | ...          | ... | O O | <b>85072</b> | ... |
|                | Models with Neway ADZ Rear Suspension                                      | 471700004423    |     | ...          | ... | O O | <b>85109</b> | ... |
|                |  | 90045605        |     | ...          | ... | O O | <b>85109</b> | ... |
| <b>08 - 17</b> | Models with T-Ride Rear Suspension   | 20433427        |     | ...          | ... | O - | <b>85065</b> | ... |
|                |  | 471700131256    |     | ...          | ... | O - | <b>85065</b> | ... |

**VN Series - 2200**

|                |                             |              |  |     |     |     |              |              |
|----------------|-----------------------------|--------------|--|-----|-----|-----|--------------|--------------|
| <b>05/99 -</b> | Models built after May 1999 | 20433425     |  | ... | ... | O O | <b>85066</b> | <b>89448</b> |
|                |                             | 471700002627 |  | ... | ... | O O | <b>85066</b> | <b>89448</b> |
|                |                             | 8086651      |  | ... | ... | O O | <b>85066</b> | <b>89448</b> |

## APPLICATION GUIDE - TRUCKS, TRAILERS, AND BUSES

| Year<br>Año<br>Année | Model<br>Modelo<br>Modèle | OEM # | Front         |            | Rear          |            |
|----------------------|---------------------------|-------|---------------|------------|---------------|------------|
|                      |                           |       | <br>Fleetline | <br>GasSLX | <br>Fleetline | <br>GasSLX |

### VOLVO(Cont'd.)





#### VN Series - 2200(Cont'd.)

|  |                           |             |     |       |       |     |       |       |
|--|---------------------------|-------------|-----|-------|-------|-----|-------|-------|
|  | Models with O.E.M. Number | 20433424    | OIO | 85061 | 89450 |     | ...   | ...   |
|  |                           | 20513881    | OIO | 85061 | 89450 |     | ...   | ...   |
|  |                           | 20551628    |     | ...   | ...   | OIO | 85066 | 89448 |
|  |                           | 47170000443 |     | ...   | ...   | OIO | 85066 | 89448 |
|  |                           | 665607      |     | ...   | ...   | OIO | 85047 | 89435 |
|  |                           | 8077874     |     | ...   | ...   | OIO | 85047 | 89435 |
|  |                           | 8077874-P01 |     | ...   | ...   | OIO | 85047 | 89435 |
|  |                           | 8078195     | OIO | 85061 | 89450 |     | ...   | ...   |
|  |                           | 8086053     |     | ...   | ...   | OIO | 85047 | 89435 |
|  |                           | 8169859     |     | ...   | ...   | OIO | 85047 | 89435 |

#### VNL Series

|         |  |              |     |       |       |     |       |       |
|---------|--|--------------|-----|-------|-------|-----|-------|-------|
| 06 - 16 | 300 Models with Hendrickson 40,000 lb Pimaax EX and FireMaax EX Air Suspension | 20782199     |     | ...   | ...   | OIO | 85072 | ...   |
|         |  | 60657-007    |     | ...   | ...   | OIO | 85072 | ...   |
| 06 - 10 | 300, 300U Models with 12,000 - 13,200 lb Front Axles                           | 20433424     | OIO | 85061 | 89450 |     | ...   | ...   |
| 11 - 19 | 300, 300U Models with 12,000 - 13,200 lb Front Axles                           | 141700005838 | OIO | 85098 | ...   |     | ...   | ...   |
|         |  | 21436086     | OIO | 85098 | ...   |     | ...   | ...   |
| 06 - 11 | 300, 300U Models with 40,000 lb Rear Air Suspension                            | 20433425     |     | ...   | ...   | OIO | 85066 | 89448 |
|         |  | 20551628     |     | ...   | ...   | OIO | 85066 | 89448 |
|         |  | 47170000443  |     | ...   | ...   | OIO | 85066 | 89448 |
|         |  | 471700002627 |     | ...   | ...   | OIO | 85066 | 89448 |
| 11 - 17 | 300, 300U Models with 40,000 lb Rear Air Suspension                            | 21462378     |     | ...   | ...   | OIO | 85088 | ...   |
|         |  | 471700006038 |     | ...   | ...   | OIO | 85088 | ...   |
| 06 - 14 | 300, 300U Models with Hendrickson Airtek                                       | 20485632     | OIO | 85933 | 89454 |     | ...   | ...   |
|         |  | 20485633     | OIO | 85933 | 89454 |     | ...   | ...   |
|         |  | 21137330     | OIO | 85933 | 89454 |     | ...   | ...   |
|         |  | 471700003832 | OIO | 85933 | 89454 |     | ...   | ...   |
|         |  | 64838-003    | OIO | 85933 | 89454 |     | ...   | ...   |
|         |  | 64838-003L   | OIO | 85933 | 89454 |     | ...   | ...   |
| 11 - 18 | 430 Models with 12,500 - 14,600 lb Front Axle                                  | 141700005838 | OIO | 85098 | ...   |     | ...   | ...   |
|         |  | 21436086     | OIO | 85098 | ...   |     | ...   | ...   |
| 06 - 10 | 430 Models with 13,200 lb Front Axle   | 20433424     | OIO | 85061 | 89450 |     | ...   | ...   |
| 05 - 11 | 430 Models with 40,000 lb Rear Air Suspension                                  | 20433425     |     | ...   | ...   | OIO | 85066 | 89448 |
|         |  | 20551628     |     | ...   | ...   | OIO | 85066 | 89448 |
|         |  | 47170000443  |     | ...   | ...   | OIO | 85066 | 89448 |
|         |  | 471700002627 |     | ...   | ...   | OIO | 85066 | 89448 |
| 11 - 18 | 430 Models with 40,000 lb Rear Air Suspension                                  | 21462380     |     | ...   | ...   | OIO | 85088 | ...   |
|         |  | 471700006040 |     | ...   | ...   | OIO | 85088 | ...   |
| 05 - 14 | 430 Models with Hendrickson Airtek   | 20485632     | OIO | 85933 | 89454 |     | ...   | ...   |
|         |  | 20485633     | OIO | 85933 | 89454 |     | ...   | ...   |
|         |  | 21137330     | OIO | 85933 | 89454 |     | ...   | ...   |
|         |  | 471700003832 | OIO | 85933 | 89454 |     | ...   | ...   |
|         |  | 64838-003    | OIO | 85933 | 89454 |     | ...   | ...   |
|         |  | 64838-003L   | OIO | 85933 | 89454 |     | ...   | ...   |
| 11 - 18 | 630 & 670 Models with 12,500 - 14,600 lb Front Axle                            | 141700005838 | OIO | 85098 | ...   |     | ...   | ...   |
|         |  | 21436086     | OIO | 85098 | ...   |     | ...   | ...   |
| 06 - 10 | 630 & 670 Models with 13,200 lb Front Axle                                     | 20433424     | OIO | 85061 | 89450 |     | ...   | ...   |
| 06 - 11 | 630 & 670 Models with 40,000 lb Rear Air Suspension                            | 20551628     |     | ...   | ...   | OIO | 85066 | 89448 |
|         |  | 47170000443  |     | ...   | ...   | OIO | 85066 | 89448 |
| 11 - 18 | 630 & 670 Models with 40,000 lb Rear Air Suspension                            | 21462380     |     | ...   | ...   | OIO | 85088 | ...   |
|         |  | 471700006040 |     | ...   | ...   | OIO | 85088 | ...   |
| 06 - 16 | 630 & 670 Models with Hendrickson Airtek                                       | 20485632     | OIO | 85933 | 89454 |     | ...   | ...   |
|         |  | 20485633     | OIO | 85933 | 89454 |     | ...   | ...   |
|         |  | 21137330     | OIO | 85933 | 89454 |     | ...   | ...   |
|         |  | 471700003832 | OIO | 85933 | 89454 |     | ...   | ...   |

## APPLICATION GUIDE - TRUCKS, TRAILERS, AND BUSES

| Year<br>Año<br>Année | Model<br>Modelo<br>Modèle | OEM # | Front   |   | Rear  |   |
|----------------------|---------------------------|-------|---|---|---|---|
|                      |                           |       |  |  |  |  |
|                      |                           |       | Fleetline   | GasSLX  | Fleetline   | GasSLX  |

### VOLVO(Cont'd.)

#### VNL Series(Cont'd.)

|           |   |              |     |       |       |     |       |       |
|-----------|---|--------------|-----|-------|-------|-----|-------|-------|
| 06 - 16   | 630 & 670 Models with Hendrickson Airtek  | 64838-003    | 010 | 85933 | 89454 |     | ...   | ...   |
|           |   | 64838-003L   | 010 | 85933 | 89454 |     | ...   | ...   |
| 06 - 16   | 64T-830 Models with Hendrickson 40,000 lb Pimaax EX and FireMaax EX Air Suspension          | 20782199     |     | ...   | ...   | 010 | 85072 | ...   |
| 06 - 16   | 64T-830 Models with Hendrickson 40,000 lb Primaax, Pimaax EX and FireMaax EX Air Suspension | 60657-007    |     | ...   | ...   | 010 | 85072 | ...   |
| 11 - 18   | 730 & 780 Models with 12,500 - 14,600 lb Front Axle   | 141700005838 | 010 | 85098 | ...   |     | ...   | ...   |
|           |   | 21436086     | 010 | 85098 | ...   |     | ...   | ...   |
| 06 - 10   | 730 & 780 Models with 13,200 lb Front Axle  | 20433424     | 010 | 85061 | 89450 |     | ...   | ...   |
| 06 - 11   | 730 & 780 Models with 40,000 lb Rear Air Suspension   | 20551628     |     | ...   | ...   | 010 | 85066 | 89448 |
|           |   | 471700000443 |     | ...   | ...   | 010 | 85066 | 89448 |
| 11 - 18   | 730 & 780 Models with 40,000 lb Rear Air Suspension   | 21462380     |     | ...   | ...   | 010 | 85088 | ...   |
|           |   | 471700006040 |     | ...   | ...   | 010 | 85088 | ...   |
|           |   |              |     | ...   | ...   | 010 | 85088 | ...   |
| 06 - 16   | 730 & 780 Models with Hendrickson Airtek  | 20485632     | 010 | 85933 | 89454 |     | ...   | ...   |
|           |   | 20485633     | 010 | 85933 | 89454 |     | ...   | ...   |
|           |   | 21137330     | 010 | 85933 | 89454 |     | ...   | ...   |
|           |   | 471700003832 | 010 | 85933 | 89454 |     | ...   | ...   |
|           |   | 64838-003    | 010 | 85933 | 89454 |     | ...   | ...   |
|           |   | 64838-003L   | 010 | 85933 | 89454 |     | ...   | ...   |
| 2018 - 19 | 740 Models with 12,500 - 14,600 lb Front Axle   | 141700005838 | 010 | 85098 | ...   |     | ...   | ...   |
|           |   | 21436086     | 010 | 85098 | ...   |     | ...   | ...   |
| 2018 - 19 | 740 Models with 40,000 lb Rear Air Suspension   | 21462380     |     | ...   | ...   | 010 | 85088 | ...   |
|           |   | 471700006040 |     | ...   | ...   | 010 | 85088 | ...   |
| 2018 - 19 | 740 Models with Hendrickson Airtek  | 21137330     | 010 | 85933 | 89454 |     | ...   | ...   |
|           |   | 471700003832 | 010 | 85933 | 89454 |     | ...   | ...   |
|           |   | 64838-003    | 010 | 85933 | 89454 |     | ...   | ...   |
|           |   | 64838-003L   | 010 | 85933 | 89454 |     | ...   | ...   |
| 2018 - 19 | 760 Models with 12,500 - 14,600 lb Front Axle   | 141700005838 | 010 | 85098 | ...   |     | ...   | ...   |
|           |   | 21436086     | 010 | 85098 | ...   |     | ...   | ...   |
| 2018 - 19 | 760 Models with 40,000 lb Rear Air Suspension   | 21462380     |     | ...   | ...   | 010 | 85088 | ...   |
|           |   | 471700006040 |     | ...   | ...   | 010 | 85088 | ...   |
| 2018 - 19 | 860 Models with 12,500 - 14,600 lb Front Axle   | 141700005838 | 010 | 85098 | ...   |     | ...   | ...   |
|           |   | 21436086     | 010 | 85098 | ...   |     | ...   | ...   |
| 2018 - 19 | 860 Models with 40,000 lb Rear Air Suspension   | 21462380     |     | ...   | ...   | 010 | 85088 | ...   |
|           |   | 471700006040 |     | ...   | ...   | 010 | 85088 | ...   |
|           |   |              |     | ...   | ...   | 010 | 85088 | ...   |
| 06 - 10   | All Models with 12,000 - 13,200 lb Front Axles  | 20433424     | 010 | 85061 | 89450 |     | ...   | ...   |
|           |   | 8071881      | 010 | 85061 | 89450 |     | ...   | ...   |
| 05/99 -   | Models with 38,000 lb Rear Air Suspension built after May 1999                              | 20433425     |     | ...   | ...   | 010 | 85066 | 89448 |
|           |   | 471700002627 |     | ...   | ...   | 010 | 85066 | 89448 |
| - 2018    | Models with Neway ADZ Rear Suspension   | 471700004423 |     | ...   | ...   | 010 | 85109 | ...   |
|           |   | 90045605     |     | ...   | ...   | 010 | 85109 | ...   |

#### VNM Series

|        |  |          |     |       |     |     |       |     |
|--------|--|----------|-----|-------|-----|-----|-------|-----|
| - 2017 | 200 Models with 12,000 lb Front Axles            | 21436086 | 010 | 85098 | ... |     | ...   | ... |
| - 2016 | 200 Models with 46,000 lb T-Ride Rear Suspension | 20433427 |     | ...   | ... | 01- | 85065 | ... |
| - 2017 | 430 Models with 12,500 lb Front Axle             | 21436086 | 010 | 85098 | ... |     | ...   | ... |
| - 2017 | 630 Models with 12,500 lb Front Axle             | 21436086 | 010 | 85098 | ... |     | ...   | ... |
| - 2017 | 630 Models with 38,000 lb Rear Air Suspension    | 21462378 |     | ...   | ... | 010 | 85088 | ... |
|        |  | 21462380 |     | ...   | ... | 010 | 85088 | ... |

#### VNR Series

|           |   |              |     |       |       |     |       |     |
|-----------|---|--------------|-----|-------|-------|-----|-------|-----|
| 2018      | 400 Models with 12,500 lb Front Axle          | 21436086     | 010 | 85098 | ...   |     | ...   | ... |
| 2018      | 400 Models with 38,000 lb Rear Air Suspension | 21462380     |     | ...   | ...   | 010 | 85088 | ... |
| 2018 - 19 | Models with Hendrickson Airtek                | 21137330     | 010 | 85933 | 89454 |     | ...   | ... |
|           |   | 471700003832 | 010 | 85933 | 89454 |     | ...   | ... |
|           |   | 64838-003    | 010 | 85933 | 89454 |     | ...   | ... |
|           |   | 64838-003L   | 010 | 85933 | 89454 |     | ...   | ... |



## APPLICATION GUIDE - TRUCKS, TRAILERS, AND BUSES

| Year<br>Año<br>Année | Model<br>Modelo<br>Modèle | OEM # | Front     |        |           | Rear   |        |  |
|----------------------|---------------------------|-------|-----------|--------|-----------|--------|--------|--|
|                      |                           |       |           |        |           |        |        |  |
|                      |                           |       | Fleetline | GasSLX | Fleetline | GasSLX | GasSLX |  |

### VOLVO(Cont'd.)

#### VNR Series(Cont'd.)

|      |   |            |     |     |     |       |     |
|------|---|------------|-----|-----|-----|-------|-----|
| 2018 | Models with Hendrickson HAS 400 or 460 Series Rear Suspension | 60675-001  | ... | ... | OIO | 85978 | ... |
|      |   | 60675-001L | ... | ... | OIO | 85978 | ... |
|      |   | 8083872    | ... | ... | OIO | 85978 | ... |

#### VNX - Series

|  |   |              |     |       |     |       |     |
|--|---|--------------|-----|-------|-----|-------|-----|
|  | Models with 12,500 - 14,600 lb Front Axle | 141700005838 | OIO | 85098 | ... | ...   | ... |
|  |   | 21436086     | OIO | 85098 | ... | ...   | ... |
|  | Models with 40,000 lb Rear Air Suspension | 21462380     | ... | ...   | OIO | 85088 | ... |
|  |   | 471700006040 | ... | ...   | OIO | 85088 | ... |
|  | Models with Neway ADZ Rear Suspension     | 471700004423 | ... | ...   | OIO | 85109 | ... |
|  |   | 90045605     | ... | ...   | OIO | 85109 | ... |

#### Vocational Trucks

|  |   |            |     |     |     |       |     |
|--|---|------------|-----|-----|-----|-------|-----|
|  | Models with T-Ride Rear Suspension  | 20433427   | ... | ... | OIO | 85065 | ... |
|  |   | 8060026    | ... | ... | OIO | 85065 | ... |
|  |   | 8073212    | ... | ... | OIO | 85065 | ... |
|  |   | 8075257    | ... | ... | OIO | 85065 | ... |
|  | WX, WXR, WG, AC Models with Hendrickson HN-402 Rear Suspension  | 57241-3    | ... | ... | OIO | 83112 | ... |
|  |   | 60680-003  | ... | ... | OIO | 83112 | ... |
|  |   | 60680-003L | ... | ... | OIO | 83112 | ... |
|  | WX, WXML, WXR, WG, AC Models<br>With Hendrickson HAS-400 Rear Air Suspension<br>With Hendrickson HAS-460 Rear Air Suspension<br>With Hendrickson HN-462 Rear Suspension | 47902-24   | ... | ... | OIO | 83137 | ... |
|  |   | 47902-24   | ... | ... | OIO | 83137 | ... |
|  |   | 57241-3    | ... | ... | OIO | 83112 | ... |
|  |   | 60680-003  | ... | ... | OIO | 83112 | ... |
|  |   | 60680-003L | ... | ... | OIO | 83112 | ... |

#### VT Series

|         |   |              |     |       |       |       |       |
|---------|---|--------------|-----|-------|-------|-------|-------|
| 06 - 10 | 64T-830 Models with 40,000 lb Rear Air Suspension   | 20551628     | ... | ...   | OIO   | 85066 | 89448 |
|         |   | 471700000443 | ... | ...   | OIO   | 85066 | 89448 |
| 06 - 10 | 64T-830 Models with Hendrickson 40,000 lb Primaax, Pimaax EX and FireMaax EX Air Suspension | 60657-007    | ... | ...   | OIO   | 85072 | ...   |
| 06 - 10 | 64T-880 Models with Hendrickson 40,000 lb Pimaax EX and FireMaax EX Air Suspension          | 20782199     | ... | ...   | OIO   | 85072 | ...   |
| 06 - 10 | All Models with 12,000 - 13,200 lb Front Axles  | 20433424     | OIO | 85061 | 89450 | ...   | ...   |
|         |   | 8071881      | OIO | 85061 | 89450 | ...   | ...   |





#### WCA & WIA Series

|         |  |                               |            |       |       |       |       |
|---------|--|-------------------------------|------------|-------|-------|-------|-------|
| 1995 -  | All with O.E.M. Number and after V.I.N. Number 723506    | 8169859                       | ...        | ...   | OIO   | 85047 | 89435 |
|         |  | Models with Front Dual Shocks | 02-7005976 | -I-   | 83400 | ...   | ...   |
|         |  | 3082284                       | -I-        | 83400 | ...   | ...   | ...   |
| 93 - 95 | Models with O.E.M. Number and after V.I.N. Number 657841 | 8026658                       | ...        | ...   | OIO   | 85046 | 89434 |
| - 1992  | Models with O.E.M. Number and up to V.I.N. Number 657250 | 8071524                       | ...        | ...   | OIO   | 85024 | ...   |
|         | Models with O.E.M. Number                                | 37301-0016                    | OIO        | 85026 | 89417 | ...   | ...   |
|         |  | 37301-0021                    | OIO        | 85026 | 89417 | ...   | ...   |
|         |  | 37301-3201                    | -I-        | 85027 | 89418 | ...   | ...   |
|         |  | 37301-3202                    | OIO        | 85026 | 89417 | ...   | ...   |
|         |  | 4975549                       | OIO        | 83216 | ...   | ...   | ...   |
|         |  | 8065787                       | OIO        | 85026 | 89417 | ...   | ...   |

#### WG Series

|         |                           |            |     |       |       |       |       |
|---------|---------------------------|------------|-----|-------|-------|-------|-------|
|         | Models with O.E.M. Number | 35901-3201 | ... | ...   | OIO   | 85024 | ...   |
|         |                           | 37301-3201 | -I- | 85027 | 89418 | ...   | ...   |
|         |                           | 665623     | ... | ...   | OIO   | 85046 | 89434 |
| - 1992  | Models with O.E.M. Number | 8065787    | OIO | 85026 | 89417 | ...   | ...   |
|         |                           | 8071524    | ... | ...   | OIO   | 85024 | ...   |
| 93 - 95 | Models with O.E.M. Number | 8026658    | ... | ...   | OIO   | 85046 | 89434 |

**APPLICATION GUIDE - TRUCKS, TRAILERS, AND BUSES**

| Year<br>Año<br>Année | Model<br>Modelo<br>Modèle | OEM # | Front   |   | Rear  |   |
|----------------------|---------------------------|-------|---|---|---|---|
|                      |                           |       |  |  |  |  |
|                      |                           |       | Fleetline   | GasSLX  | Fleetline   | GasSLX  |

**VOLVO(Cont'd.)**

**WH Series(Cont'd.)**

|         |  |            |     |              |              |     |              |              |
|---------|--|------------|-----|--------------|--------------|-----|--------------|--------------|
|         | WHS, WHR, WHL or WHE Models with Front Dual Shocks   | 02-7005976 | - - | <b>83400</b> | ...          |     | ...          | ...          |
|         |  | 3082284    | - - | <b>83400</b> | ...          |     | ...          | ...          |
|         | WHS, WHR, WHL or WHE Models with Front Single Shocks | 37301-0021 | 0 - | <b>85026</b> | <b>89417</b> |     | ...          | ...          |
| - 1992  | WHS, WHR, WHL or WHE Models with O.E.M. Number       | 35901-3201 |     | ...          | ...          | 0 0 | <b>85024</b> | ...          |
|         |  | 8071524    |     | ...          | ...          | 0 0 | <b>85024</b> | ...          |
| 1995 -  | WHS, WHR, WHL or WHE Models with O.E.M. Number       | 8169859    |     | ...          | ...          | 0 0 | <b>85047</b> | <b>89435</b> |
| 93 - 95 | WHS, WHR, WHL or WHE Models with O.E.M. Number       | 8026658    |     | ...          | ...          | 0 0 | <b>85046</b> | <b>89434</b> |





**Additional Applications**

|         |  |              |     |              |              |     |              |              |
|---------|--|--------------|-----|--------------|--------------|-----|--------------|--------------|
|         | 1500 Models  | .....        |     | <b>83122</b> | ...          | 0 0 | <b>83122</b> | <b>89406</b> |
|         | 1500 Models  |              |     |              |              |     |              |              |
|         | Models with Rear Suspension  | 35901-0005   |     | ...          | ...          | 0 0 | <b>83219</b> | ...          |
|         | Models with Velvet Ride Suspension   | 530596       |     | ...          | ...          | 0 0 | <b>85308</b> | <b>89422</b> |
|         | 3000, 4000 & 9000 Models - Special Unit - Four Shock Absorbers Required Per Axle                       | 5554959      | 0 0 | <b>83401</b> | ...          |     | ...          | ...          |
|         |  | 676081       | 0 0 | <b>83401</b> | ...          |     | ...          | ...          |
|         |  | 676082       | 0 0 | <b>83401</b> | ...          |     | ...          | ...          |
|         | 3014, 3015, 3016, 3020 C.O.E. and 1500   | .....        | 0 0 | <b>83122</b> | <b>89406</b> |     | ...          | ...          |
|         | 9000 Models  | .....        | 0 0 | <b>83122</b> | <b>89406</b> |     | ...          | ...          |
|         | Brigadier Models   | 22012065     | 0 0 | <b>85304</b> | ...          |     | ...          | ...          |
|         |  | 22046483     | 0 0 | <b>85304</b> | ...          |     | ...          | ...          |
|         |  | 22052336     | 0 0 | <b>85304</b> | ...          |     | ...          | ...          |
|         | Models with Hendrickson HN - 400 Rear suspension   | 3971703      |     | ...          | ...          | 0 - | <b>83112</b> | ...          |
| 78 - 83 | RC2  | .....        |     | ...          | ...          | 0 0 | <b>83122</b> | <b>89406</b> |
|         | Road Boss, Road Boss II, Road Commander II, Road Expeditor - (Four Shocks per Axle)                    | 3946210      | - - | <b>83103</b> | ...          |     | ...          | ...          |
|         | Road Boss, Road Boss II, Road Commander, Road Commander II, Road Expeditor II - (Four Shocks per Axle) | 02-7005976   | - - | <b>83400</b> | ...          |     | ...          | ...          |
|         |  | 02-7005977   | - - | <b>83400</b> | ...          |     | ...          | ...          |
|         |  | 4975479      | - - | <b>83400</b> | ...          |     | ...          | ...          |
|         |  | 4975480      | - - | <b>83400</b> | ...          |     | ...          | ...          |
|         | Models with Hendrickson Airtex   | 20469001     | 0 0 | <b>85933</b> | <b>89454</b> |     | ...          | ...          |
|         |  | 20469002     | 0 0 | <b>85933</b> | <b>89454</b> |     | ...          | ...          |
|         |  | 471700131920 | 0 0 | <b>85933</b> | <b>89454</b> |     | ...          | ...          |
|         |  | 471700131921 | 0 0 | <b>85933</b> | <b>89454</b> |     | ...          | ...          |
|         |  | 64838-001    | 0 0 | <b>85933</b> | <b>89454</b> |     | ...          | ...          |
|         |  | 64838-002    | 0 0 | <b>85933</b> | <b>89454</b> |     | ...          | ...          |

**Additional O.E.M. Interchanges**

|  |                                |            |     |                       |  |
|--|--------------------------------|------------|-----|-----------------------|--|
|  | Additional O.E.M. Interchanges | 03-1106460 | 0 0 | <b>85005 or 89430</b> |  |
|  |                                | 20863239   | 0 - | <b>85080</b>          |  |
|  |                                | 35901-0003 | 0 0 | <b>85301</b>          |  |
|  |                                | 35901-0004 | 0 0 | <b>83219</b>          |  |
|  |                                | 35901-0011 | 0 0 | <b>83123 or 89405</b> |  |
|  |                                | 35901-0017 | 0 0 | <b>83314</b>          |  |
|  |                                | 35901-0022 | 0 - | <b>83635</b>          |  |
|  |                                | 35901-3406 | 0 0 | <b>85305</b>          |  |
|  |                                | 35901-3409 | 0 0 | <b>85304</b>          |  |
|  |                                | 35901-3410 | 0 0 | <b>85307</b>          |  |
|  |                                | 35901-3413 | 0 0 | <b>85006</b>          |  |
|  |                                | 35901-3420 | 0 0 | <b>85303 or 89422</b> |  |
|  |                                | 37001-5    | 0 0 | <b>83401</b>          |  |
|  |                                | 37301-0001 | 0 0 | <b>85013 or 89414</b> |  |
|  |                                | 37301-0018 | 0 0 | <b>85005 or 89430</b> |  |
|  |                                | 3953643    | 0 0 | <b>85040</b>          |  |
|  |                                | 4940640    | 0 0 | <b>83216</b>          |  |
|  |                                | 494-660    | 0 0 | <b>83219</b>          |  |

**APPLICATION GUIDE - TRUCKS, TRAILERS, AND BUSES**





| Year<br>Año<br>Année | Model<br>Modelo<br>Modèle | OEM # | Front   |  | Rear  |   |
|----------------------|---------------------------|-------|---|--|---|---|
|                      |                           |       |  |  |  |  |
|                      |                           |       | Fleetline   | GasSLX   | Fleetline   | GasSLX  |

**VOLVO(Cont'd.)**

**Additional O.E.M. Interchanges(Cont'd.)**

| Additional O.E.M. Interchanges |            |     |                |
|--------------------------------|------------|-----|----------------|
|                                | 5322338    | 010 | 83214          |
|                                | 5513989    | 010 | 83216          |
|                                | 5531435    | 010 | 85307          |
|                                | 5531436    | 010 | 85307          |
|                                | 5531437    | 010 | 85307          |
|                                | 5534430    | 010 | 85303 or 89422 |
|                                | 5534447    | 010 | 85303 or 89422 |
|                                | 5549899    | 010 | 83207 or 89407 |
|                                | 5549925    | 010 | 85304          |
|                                | 629398     | 010 | 85307          |
|                                | 629501     | 010 | 85307          |
|                                | 646220     | 010 | 85734          |
|                                | 66010-0016 | 01- | 85025          |
|                                | 668302     | 010 | 83216          |
|                                | 6771501    | 010 | 85040          |
|                                | 6775411    | 010 | 85040          |
|                                | 1091347    | 010 | 83125          |
|                                | 1091348    | 010 | 83122 or 89406 |
|                                | 1091349    | 010 | 83204          |
|                                | 1091350    | 010 | 83207 or 89407 |
|                                | 1091351    | 010 | 83209 or 89414 |
|                                | 1091353    | 010 | 83215          |
|                                | 1091354    | 010 | 83216          |
|                                | 1091355    | 010 | 83217          |
|                                | 1091357    | 010 | 83219          |
|                                | 1091358    | -1- | 83456 or 89447 |
|                                | 1091359    | 010 | 83123 or 89405 |
|                                | 1091360    | 010 | 83303          |
|                                | 1091361    | 010 | 83304          |
|                                | 1091362    | 010 | 83309 or 89446 |
|                                | 1091363    | 010 | 83221          |
|                                | 1091364    | 010 | 83312 or 89409 |
|                                | 1091365    | -1- | 83400          |
|                                | 1091366    | 010 | 83401          |
|                                | 1091367    | 010 | 85000 or 89436 |
|                                | 1091368    | 010 | 85003 or 89411 |
|                                | 1091370    | 010 | 85006          |
|                                | 1091371    | 010 | 85300 or 89419 |
|                                | 1091372    | 010 | 85301          |
|                                | 1091373    | 010 | 85302 or 89420 |
|                                | 1091374    | 010 | 85303 or 89422 |
|                                | 1091375    | 010 | 85304          |
|                                | 1091376    | 010 | 85305          |
|                                | 1091377    | 010 | 85307          |
|                                | 1091378    | 010 | 85308 or 89422 |
|                                | 1091379    | -1- | 85310 or 89423 |
|                                | 1091384    | 010 | 85735          |
|                                | 1093100    | -1- | 85027 or 89418 |
|                                | 1093176    | 010 | 85024          |
|                                | 1093177    | 01- | 85025          |
|                                | 1093178    | 01- | 85026 or 89417 |
|                                | 1093180    | 010 | 85030 or 89440 |
|                                | 1716824    | 010 | 85304          |
|                                | 19501669   | 010 | 85339          |
|                                | 19502711   | 010 | 85702          |

**APPLICATION GUIDE - TRUCKS, TRAILERS, AND BUSES**





| Year<br>Año<br>Année | Model<br>Modelo<br>Modèle | OEM # | Front   |   | Rear  |   |
|----------------------|---------------------------|-------|---|---|---|---|
|                      |                           |       |  |  |  |  |
|                      |                           |       | Fleetline   | GasSLX  | Fleetline   | GasSLX  |

**VOLVO(Cont'd.)**

**Additional O.E.M. Interchanges(Cont'd.)**

| Additional O.E.M. Interchanges |          |     |                |  |
|--------------------------------|----------|-----|----------------|--|
|                                | 19506846 | 010 | 85339          |  |
|                                | 3130140  | 010 | 85315          |  |
|                                | 3171696  | 010 | 85307          |  |
|                                | 3172948  | 010 | 85303 or 89422 |  |
|                                | 3199937  | -10 | 85316 or 89426 |  |
|                                | 3199938  | 010 | 85030 or 89440 |  |
|                                | 3199939  | 010 | 85058 or 89431 |  |
|                                | 3199940  | 010 | 85005 or 89430 |  |
|                                | 3199941  | 010 | 85006          |  |
|                                | 3199942  | 010 | 89402          |  |
|                                | 3199943  | 010 | 85012 or 89413 |  |
|                                | 3199944  | 010 | 85006          |  |
|                                | 3199945  | -1- | 85027 or 89418 |  |
|                                | 3199946  | -10 | 85033 or 89427 |  |
|                                | 3199947  | 010 | 85013 or 89414 |  |
|                                | 3199948  | -10 | 85311 or 89424 |  |
|                                | 3199949  | -1- | 85310 or 89423 |  |
|                                | 3199950  | 010 | 85023 or 89415 |  |
|                                | 3199951  | 010 | 85024          |  |
|                                | 3199952  | 010 | 85736          |  |
|                                | 3199953  | -10 | 85319 or 89428 |  |
|                                | 3199954  | 010 | 85003 or 89411 |  |
|                                | 3199955  | 010 | 85300 or 89419 |  |
|                                | 3199956  | 010 | 85036 or 89405 |  |
|                                | 3199957  | 010 | 83122 or 89406 |  |
|                                | 3199959  | 010 | 85323 or 89436 |  |
|                                | 3199960  | 010 | 85322          |  |
|                                | 3199961  | 010 | 85307          |  |
|                                | 3199962  | 010 | 85314 or 89425 |  |
|                                | 3199963  | 010 | 85315          |  |
|                                | 3199965  | 010 | 85736          |  |
|                                | 3199966  | 010 | 85303 or 89422 |  |
|                                | 3199967  | 010 | 85302 or 89420 |  |
|                                | 3199968  | 010 | 85308 or 89422 |  |
|                                | 3199972  | 010 | 85320 or 89429 |  |
|                                | 3199973  | -1- | 85722          |  |
|                                | 3199974  | 010 | 85712          |  |
|                                | 3199975  | 010 | 85700          |  |
|                                | 3199976  | -10 | 85711          |  |
|                                | 3199977  | -10 | 85711          |  |
|                                | 3199978  | 010 | 85712          |  |
|                                | 3199979  | 010 | 85702          |  |
|                                | 3199980  | -1- | 85310 or 89423 |  |
|                                | 3199982  | -10 | 85703          |  |
|                                | 3199983  | 010 | 85704          |  |
|                                | 3199984  | 010 | 85314 or 89425 |  |
|                                | 3199985  | 01- | 85723          |  |
|                                | 3199986  | -1- | 85318          |  |
|                                | 3199987  | -1- | 85705          |  |
|                                | 3199988  | -10 | 85311 or 89424 |  |
|                                | 3199989  | -1- | 85709          |  |
|                                | 3199990  | 010 | 85003 or 89411 |  |
|                                | 3199991  | -1- | 85708          |  |
|                                | 3199992  | 01- | 85733          |  |
|                                | 3199993  | 010 | 85712          |  |

**APPLICATION GUIDE - TRUCKS, TRAILERS, AND BUSES**





| Year<br>Año<br>Année | Model<br>Modelo<br>Modèle | OEM # | Front   |  | Rear  |   |
|----------------------|---------------------------|-------|---|--|---|---|
|                      |                           |       |  |  |  |  |
|                      |                           |       | Fleetline   | GasSLX   | Fleetline   | GasSLX  |

**VOLVO(Cont'd.)**

**Additional O.E.M. Interchanges(Cont'd.)**

|                                |         |                |                |
|--------------------------------|---------|----------------|----------------|
| Additional O.E.M. Interchanges | 3199994 | 010            | 85308 or 89422 |
|                                | 3915917 | -10            | 85319 or 89428 |
|                                | 3915947 | 010            | 85001 or 89410 |
|                                | 3915948 | -10            | 85311 or 89424 |
|                                | 3916352 | 010            | 85013 or 89414 |
|                                | 3919055 | 010            | 85007 or 89412 |
|                                | 3919056 | 010            | 83203 or 89436 |
|                                | 3919057 | 010            | 83225          |
|                                | 3919526 | 010            | 83314          |
|                                | 3919561 | 010            | 85314 or 89425 |
|                                | 3919565 | -1-            | 83103          |
|                                | 3919567 | -1-            | 83613          |
|                                | 3919569 | 010            | 85052          |
|                                | 3919570 | 010            | 83128 or 89436 |
|                                | 3919571 | 01-            | 83635          |
|                                | 3919572 | 010            | 83130          |
|                                | 3919573 | 010            | 83123 or 89405 |
|                                | 3919574 | 010            | 85006 or 89401 |
|                                | 3919575 | 01-            | 83120          |
|                                | 3919582 | 010            | 83215          |
|                                | 3919583 | 010            | 83100          |
|                                | 3919585 | 010            | 83209 or 89414 |
|                                | 3919586 | 010            | 83100          |
|                                | 3919587 | -10            | 83105          |
|                                | 3919588 | 010            | 83216          |
|                                | 3919589 | 01-            | 85026 or 89417 |
|                                | 3919590 | 010            | 85042          |
|                                | 3919591 | -10            | 83515          |
|                                | 3919592 | 010            | 85024          |
|                                | 3919593 | 010            | 83242          |
|                                | 3919594 | 010            | 85003 or 89411 |
|                                | 3919596 | 01-            | G63484         |
|                                | 3919598 | 010            | 83312 or 89409 |
|                                | 3919900 | 010            | 85012 or 89413 |
|                                | 3919901 | -1-            | 83103          |
|                                | 3919902 | 010            | 83126 or 89430 |
|                                | 3919903 | 010            | 83216          |
|                                | 3919904 | 010            | G63183         |
|                                | 3919906 | 010            | 83308          |
|                                | 3919907 | 010            | 83309 or 89446 |
|                                | 3919908 | 010            | 83104          |
|                                | 3919909 | 010            | G63605         |
|                                | 3919910 | 010            | 83221          |
|                                | 3919911 | 010            | 83124 or 89407 |
|                                | 3919912 | 010            | 83215          |
|                                | 3919913 | 010            | 83203 or 89436 |
|                                | 3919914 | 010            | 83209 or 89414 |
| 3919915                        | 010     | 83127          |                |
| 3919916                        | 010     | 83126 or 89430 |                |
| 3919917                        | 010     | 83125          |                |
| 3919918                        | 010     | 83401          |                |
| 3919919                        | 010     | G63625         |                |
| 3919920                        | 010     | 83303          |                |
| 3919921                        | 010     | 83123 or 89405 |                |
| 3919922                        | -1-     | 83318          |                |

**APPLICATION GUIDE - TRUCKS, TRAILERS, AND BUSES**





| Year<br>Año<br>Année | Model<br>Modelo<br>Modèle | OEM # | Front   |   | Rear  |   |
|----------------------|---------------------------|-------|---|---|---|---|
|                      |                           |       |  |  |  |  |
|                      |                           |       | Fleetline   | GasSLX  | Fleetline   | GasSLX  |

**VOLVO(Cont'd.)**

**Additional O.E.M. Interchanges(Cont'd.)**

| Additional O.E.M. Interchanges | OEM #   | Interchange Code | Interchange Part # |
|--------------------------------|---------|------------------|--------------------|
|                                | 3919923 | -10              | 83301              |
|                                | 3919924 | -1-              | 83456 or 89447     |
|                                | 3919925 | -10              | 83317              |
|                                | 3919926 | 010              | G63403             |
|                                | 3919927 | 010              | 83101              |
|                                | 3919928 | 010              | 83225              |
|                                | 3919931 | 010              | 83126 or 89430     |
|                                | 3919932 | 010              | 85062 or 89408     |
|                                | 3919933 | 010              | 85001 or 89410     |
|                                | 3919934 | 010              | 85320 or 89429     |
|                                | 3919935 | 01-              | 85026 or 89417     |
|                                | 3919936 | 010              | 83207 or 89407     |
|                                | 3919937 | -10              | 85316 or 89426     |
|                                | 3919938 | 010              | 85030 or 89440     |
|                                | 3919939 | 010              | 85058 or 89431     |
|                                | 3919940 | 010              | 85005 or 89430     |
|                                | 3919941 | 010              | 85006              |
|                                | 3919942 | 010              | 89402              |
|                                | 3919943 | 010              | 85012 or 89413     |
|                                | 3919944 | 010              | 85036 or 89405     |
|                                | 3919945 | -1-              | 85027 or 89418     |
|                                | 3919946 | -10              | 85033 or 89427     |
|                                | 3919947 | 010              | 85013 or 89414     |
|                                | 3919948 | -10              | 85311 or 89424     |
|                                | 3919949 | -1-              | 85310 or 89423     |
|                                | 3919950 | 010              | 83219              |
|                                | 3919951 | 010              | 83309 or 89446     |
|                                | 3919952 | 010              | 85736              |
|                                | 3919953 | -10              | 85319 or 89428     |
|                                | 3919954 | 010              | 85003 or 89411     |
|                                | 3919955 | 010              | 85300 or 89419     |
|                                | 3919956 | 010              | 85036 or 89405     |
|                                | 3919957 | 010              | 83122 or 89406     |
|                                | 3919959 | 010              | 85000 or 89436     |
|                                | 3919960 | 010              | 85322              |
|                                | 3919961 | 010              | 85302 or 89420     |
|                                | 3919962 | 010              | 85700              |
|                                | 3919963 | 010              |                    |
|                                | 3919964 | 010              | 85304              |
|                                | 3919965 | 010              | 85702              |
|                                | 3919966 | 010              | 85736              |
|                                | 3919967 | 010              | 85302 or 89420     |
|                                | 3919968 | 010              | 85736              |
|                                | 3919972 | 010              | 85320 or 89429     |
|                                | 3919973 | 010              | 85956              |
|                                | 3919974 | 010              | 85712              |
|                                | 3919975 | 010              | 85700              |
|                                | 3919976 | -10              | 85033 or 89427     |
|                                | 3919977 | -10              | 85033 or 89427     |
|                                | 3919978 | 010              | 85702              |
|                                | 3919979 | 010              | 85702              |
|                                | 3919980 | 010              | 85702              |
|                                | 3919982 | -10              | 85703              |
|                                | 3919983 | 010              | 85704              |
|                                | 3919984 | 010              | 85700              |

**APPLICATION GUIDE - TRUCKS, TRAILERS, AND BUSES**

| Year<br>Año<br>Année | Model<br>Modelo<br>Modèle | OEM # | Front   |  | Rear  |   |
|----------------------|---------------------------|-------|---|--|---|---|
|                      |                           |       |  |  |  |  |
|                      |                           |       | Fleetline   | GasSLX   | Fleetline   | GasSLX  |





**VOLVO(Cont'd.)**

**Additional O.E.M. Interchanges(Cont'd.)**

| Additional O.E.M. Interchanges |           |     |                |
|--------------------------------|-----------|-----|----------------|
|                                | 3919985   | 01- | 85723          |
|                                | 3919987   | -1- | 85706          |
|                                | 3919988   | -10 | 85311 or 89424 |
|                                | 3919989   | -1- | 85709          |
|                                | 3919990   | 010 | 85003 or 89411 |
|                                | 3919991   | -1- | 85708          |
|                                | 3919992   | 01- | 85733          |
|                                | 3919993   | 010 | 85712          |
|                                | 3919994   | -1- | 85310 or 89423 |
|                                | 3945806   | 01- | 89417          |
|                                | 3945807   | 010 |                |
|                                | 3945808   | 010 | 89407          |
|                                | 3945809   | 010 | 89410          |
|                                | 3945810   | 010 | 89420          |
|                                | 3945811   | 010 | 89409          |
|                                | 3945812   | -1- | 89423          |
|                                | 3945813   | -10 | 89428          |
|                                | 3945814   | -10 | 89424          |
|                                | 3945815   | 010 | 89406          |
|                                | 3945816   | 010 | 89430          |
|                                | 3945817   | 010 | 89422          |
|                                | 3945818   | 010 | 89415          |
|                                | 3945819   | 010 | 89411          |
|                                | 3945820   | 010 | 89413          |
|                                | 3945821   | 010 | 89419          |
|                                | 3946217   | 010 | 83125          |
|                                | 3946219   | -1- | 83400          |
|                                | 662211401 | 010 | 83215          |
|                                | 83176191  | 01- | 83019          |
|                                | 83176192  | 01- | 83041          |
|                                | 83176193  | 01- | 83045          |
|                                | 83176194  | 010 | 83048          |
|                                | 83176195  | -1- | 83103          |
|                                | 83176196  | 01- | 83110          |
|                                | 83176197  | 01- | 83111          |
|                                | 83176198  | 01- | 83112          |
|                                | 83176199  | 010 | 83123          |
|                                | 83176200  | 010 | 83124          |
|                                | 83176201  | 010 | 83125          |
|                                | 83176202  | 010 | 83126          |
|                                | 83176203  | 010 | 83127          |
|                                | 83176204  | 010 | 83128 or 89436 |
|                                | 83176205  | -1- | 83136          |
|                                | 83176206  | 010 | 83148          |
|                                | 83176207  | 010 | 83203 or 89436 |
|                                | 83176208  | 010 | 83209 or 89414 |
|                                | 83176209  | 010 | 83215          |
|                                | 83176210  | 010 | 83216          |
|                                | 83176211  | 010 | 85000 or 89436 |
|                                | 83176212  | 010 | 85001 or 89410 |
|                                | 83176213  | 010 | 85003 or 89411 |
|                                | 83176214  | 010 | 85005 or 89430 |
|                                | 83176215  | 010 | 85023 or 89415 |
|                                | 83176216  | 01- | 85026 or 89417 |
|                                | 83176217  | -10 | 85033 or 89427 |



**APPLICATION GUIDE - TRUCKS, TRAILERS, AND BUSES**





| Year<br>Año<br>Année | Model<br>Modelo<br>Modèle | OEM # | Front   |   | Rear  |   |
|----------------------|---------------------------|-------|---|---|---|---|
|                      |                           |       |  |  |  |  |
|                      |                           |       | Fleetline   | GasSLX  | Fleetline   | GasSLX  |

**VOLVO(Cont'd.)**

**Additional O.E.M. Interchanges(Cont'd.)**

| Additional O.E.M. Interchanges |           |     |                |
|--------------------------------|-----------|-----|----------------|
|                                | 83176218  | 010 | 85036 or 89405 |
|                                | 83176219  | 010 | 85045          |
|                                | 83176220  | 010 | 85046 or 89434 |
|                                | 83176221  | 010 | 85047 or 89435 |
|                                | 83176222  | 010 | 85052          |
|                                | 83176223  | 010 | 85061 or 89450 |
|                                | 83176224  | 010 | 85062 or 89408 |
|                                | 83176225  | 010 | 85066 or 89448 |
|                                | 83176226  | 010 | 85067 or 89451 |
|                                | 83176227  | -1- | 85069 or 89455 |
|                                | 83176228  | 010 | 85070 or 89459 |
|                                | 83176229  | 010 | 85303 or 89422 |
|                                | 83176230  | -1- | 85310 or 89423 |
|                                | 83176231  | -10 | 85311 or 89424 |
|                                | 83176232  | 010 | 85320 or 89429 |
|                                | 83176233  | 010 | 85321          |
|                                | 83176234  | 010 | 85323 or 89436 |
|                                | 83176235  | 010 | 85724 or 89443 |
|                                | 83176236  | -1- | 85900          |
|                                | 83176237  | 010 | 85916 or 89430 |
|                                | 83176238  | 010 | 85918 or 89449 |
|                                | 83176239  | 010 | 85933 or 89454 |
|                                | 83176240  | 010 | 646155         |
|                                | 85104186  | 010 | 85006          |
|                                | 85106580  | 010 | 85918 or 89449 |
|                                | 85137234  | 010 | 83125          |
|                                | 85137420  | 010 | 85000 or 89436 |
|                                | RC SA3041 | 01- | 83041          |
|                                | RC SA3045 | 01- | 83045          |
|                                | RC SA3048 | 010 | 83048          |
|                                | RC SA3103 | -1- | 83103          |
|                                | RC SA3111 | 01- | 83111          |
|                                | RC SA3112 | 01- | 83112          |
|                                | RC SA3124 | 010 | 83124          |
|                                | RC SA3125 | 010 | 83125          |
|                                | RC SA3127 | 010 | 83127          |
|                                | RC SA3128 | 010 | 83128 or 89436 |
|                                | RC SA3136 | -1- | 83136          |
|                                | RC SA3148 | 010 | 83148          |
|                                | RC SA3203 | 010 | 83203 or 89436 |
|                                | RC SA3216 | 010 | 83216          |
|                                | RC SA5000 | 010 | 85000 or 89436 |
|                                | RC SA5001 | 010 | 85001 or 89410 |
|                                | RC SA5003 | 010 | 85003 or 89411 |
|                                | RC SA5005 | 010 | 85005 or 89430 |
|                                | RC SA5047 | 010 | 85047 or 89435 |
|                                | RC SA5052 | 010 | 85052          |
|                                | RC SA5061 | 010 | 85061 or 89450 |
|                                | RC SA5062 | 010 | 85062 or 89408 |
|                                | RC SA5066 | 010 | 85066 or 89448 |
|                                | RC SA5067 | 010 | 85067 or 89451 |
|                                | RC SA5070 | 010 | 85070 or 89459 |
|                                | RC SA5310 | -1- | 85310 or 89423 |
|                                | RC SA5320 | 010 | 85320 or 89429 |
|                                | RC SA5724 | 010 | 85724 or 89443 |

**APPLICATION GUIDE - TRUCKS, TRAILERS, AND BUSES**

| Year<br>Año<br>Année | Model<br>Modelo<br>Modèle | OEM # | Front   |  | Rear  |   |
|----------------------|---------------------------|-------|---|--|---|---|
|                      |                           |       |  |  |  |  |
|                      |                           |       | Fleetline   | GasSLX   | Fleetline   | GasSLX  |

**VOLVO(Cont'd.)**

**Additional O.E.M. Interchanges(Cont'd.)**

|                                |             |                |                |       |     |       |       |
|--------------------------------|-------------|----------------|----------------|-------|-----|-------|-------|
| Additional O.E.M. Interchanges | RC SA5900   | - -            | 85900          |       |     |       |       |
|                                | RC SA5918   | 0 0            | 85918 or 89449 |       |     |       |       |
|                                | RC SA5933   | 0 0            | 85933 or 89454 |       |     |       |       |
|                                | RC SA6155   | 0 0            | 646155         |       |     |       |       |
|                                | SA3019      | 0 -            | 83019          |       |     |       |       |
|                                | SA3041      | 0 -            | 83041          |       |     |       |       |
|                                | SA3045      | 0 -            | 83045          |       |     |       |       |
|                                | SA3048      | 0 0            | 83048          |       |     |       |       |
|                                | SA3103      | - -            | 83103          |       |     |       |       |
|                                | SA3110      | 0 -            | 83110          |       |     |       |       |
|                                | SA3111      | 0 -            | 83111          |       |     |       |       |
|                                | SA3112      | 0 -            | 83112          |       |     |       |       |
|                                | SA3123      | 0 0            | 83123          |       |     |       |       |
|                                | SA3124      | 0 0            | 83124          |       |     |       |       |
|                                | SA3125      | 0 0            | 83125          |       |     |       |       |
|                                | SA3126      | 0 0            | 83126          |       |     |       |       |
|                                | SA3127      | 0 0            | 83127          |       |     |       |       |
|                                | SA3128      | 0 0            | 83128 or 89436 |       |     |       |       |
|                                | SA3136      | - -            | 83136          |       |     |       |       |
|                                | SA3148      | 0 0            | 83148          |       |     |       |       |
|                                | SA5000      | 0 0            | 85000 or 89436 |       |     |       |       |
|                                | SA5001      | 0 0            | 85001 or 89410 |       |     |       |       |
|                                | SA5003      | 0 0            | 85003 or 89411 |       |     |       |       |
|                                | SA5005      | 0 0            | 85005 or 89430 |       |     |       |       |
|                                | SA5023      | 0 0            | 85023 or 89415 |       |     |       |       |
|                                | SA5026      | 0 -            | 85026 or 89417 |       |     |       |       |
|                                | SA5033      | - 0            | 85033 or 89427 |       |     |       |       |
|                                | SA5036      | 0 0            | 85036 or 89405 |       |     |       |       |
|                                | SA5045      | 0 0            | 85045          |       |     |       |       |
|                                | SA5046      | 0 0            | 85046 or 89434 |       |     |       |       |
|                                | SA5047      | 0 0            | 85047 or 89435 |       |     |       |       |
|                                | SA5052      | 0 0            | 85052          |       |     |       |       |
|                                | SA5061      | 0 0            | 85061 or 89450 |       |     |       |       |
| SA5062                         | 0 0         | 85062 or 89408 |                |       |     |       |       |
| SA5066                         | 0 0         | 85066 or 89448 |                |       |     |       |       |
| SA5067                         | 0 0         | 85067 or 89451 |                |       |     |       |       |
| SA5069                         | - -         | 85069 or 89455 |                |       |     |       |       |
| SA5070                         | 0 0         | 85070 or 89459 |                |       |     |       |       |
| SA5303                         | 0 0         | 85303 or 89422 |                |       |     |       |       |
| SA5310                         | - -         | 85310 or 89423 |                |       |     |       |       |
| SA5311                         | - 0         | 85311 or 89424 |                |       |     |       |       |
| SA5320                         | 0 0         | 85320          |                |       |     |       |       |
| SA5321                         | 0 0         | 85321          |                |       |     |       |       |
| SA5323                         | 0 0         | 85323 or 89436 |                |       |     |       |       |
| SA5724                         | 0 0         | 85724 or 89443 |                |       |     |       |       |
| SA5900                         | - -         | 85900          |                |       |     |       |       |
| SA5916                         | 0 0         | 85916 or 89430 |                |       |     |       |       |
| SA5918                         | 0 0         | 85918 or 89449 |                |       |     |       |       |
| SA5933                         | 0 0         | 85933 or 89454 |                |       |     |       |       |
| SA6155                         | 0 0         | 646155         |                |       |     |       |       |
| Models with O.E.M. Number      | 14170000373 | 0 0            | 85061          | 89450 |     | ...   | ...   |
|                                | 3092842     | 0 0            | 85061          | 89450 |     | ...   | ...   |
|                                | 35901-0001  |                | ...            | ...   | 0 0 | 83209 | 89414 |
|                                | 35901-0008  |                | ...            | ...   | 0 0 | 85060 | ...   |
|                                | 37301-0008  | - -            | 83400          | ...   |     | ...   | ...   |

## APPLICATION GUIDE - TRUCKS, TRAILERS, AND BUSES

| Year<br>Año<br>Année | Model<br>Modelo<br>Modèle | OEM # | Front     |        | Rear      |        |
|----------------------|---------------------------|-------|-----------|--------|-----------|--------|
|                      |                           |       |           |        |           |        |
|                      |                           |       | Fleetline | GasSLX | Fleetline | GasSLX |

### VOLVO(Cont'd.)

#### Additional O.E.M. Interchanges(Cont'd.)

| Models with O.E.M. Number | OEM # | Fleetline | GasSLX | Fleetline | GasSLX                        |
|---------------------------|-------|-----------|--------|-----------|-------------------------------|
| 3919958                   | ...   | ...       | ...    | 010       | <b>85046</b> <b>89434</b>     |
| 3946239                   | ...   | ...       | ...    | 010       | <b>85724</b> <b>89443</b>     |
| 3949240                   | ...   | ...       | ...    | 010       | <b>85047</b> <b>89435</b>     |
| 3949241                   | ...   | ...       | ...    | 010       | <b>85061</b> <b>89450</b> ... |
| 3972662                   | ...   | ...       | ...    | 010       | <b>85976</b> ...              |
| 665410                    | ...   | ...       | ...    | 01-       | <b>85027</b> <b>89418</b> ... |
| 665539                    | ...   | ...       | ...    | 01-       | <b>85026</b> <b>89417</b> ... |
| 665739                    | ...   | ...       | ...    | 010       | <b>85047</b> <b>89435</b>     |
| 70042                     | ...   | ...       | ...    | 010       | <b>85302</b> <b>89420</b> ... |
| 8075287                   | ...   | ...       | ...    | 01-       | <b>85065</b> ...              |
| 8174749                   | ...   | ...       | ...    | 010       | <b>85906</b> <b>89407</b>     |
| 85104221                  | ...   | ...       | ...    | 010       | <b>85066</b> <b>89448</b>     |
| 85107238                  | ...   | ...       | ...    | 010       | <b>85976</b> ...              |
| 85134402                  | ...   | ...       | ...    | 010       | <b>85061</b> <b>89450</b> ... |

### VOLVO CAB SHOCKS

|   |            |     |              |
|---|------------|-----|--------------|
| Aero Models (WCA & WIA Models)  | 66010-0007 | 010 | <b>83004</b> |
|   | 66010-0008 | 010 | <b>83004</b> |
|   | 8162662    | 010 | <b>83004</b> |
| Link Cabmate Model WRC-2P   | 1202-0032  | 010 | <b>83016</b> |
| Models with O.E.M. Number   | 20874147   | 01- | <b>83050</b> |
|   | 3945842    | 010 | <b>83009</b> |
|   | 635869     | 010 | <b>83004</b> |
|   | 8168617    | 010 | <b>83030</b> |
|   | 85107095   | 010 | <b>83009</b> |
| <b>2014 -</b> VAH 430 Models with 42" Sleeper Cabs  | 20721254   | 010 | <b>83048</b> |
|   | 22662224   | 010 | <b>83048</b> |
| <b>11 - 17</b> VNL / VNM & VNX DayCab Models with O.E.M. Number                           | 21368411   | 010 | <b>83905</b> |
|   | 22662230   | 010 | <b>83905</b> |
| <b>06 - 10</b> VT Models - All with 60" to 77" Mid - High Roof Sleepers (w/O.E.M. Number) | 20721254   | 010 | <b>83048</b> |
| WG Conventional Tractors with 112" cabs with Link Cabmate Model WWG112-A                  | 1201-0012  | 010 | <b>83023</b> |
|   | 1202-0012  | 010 | <b>83023</b> |

#### VHD - Series

|  |          |     |              |
|--|----------|-----|--------------|
| <b>11 - 17</b> DayCab Models with O.E.M. Number        | 22662230 | 010 | <b>83905</b> |
| <b>12 - 17</b> VHD 64T-200 Models - With O.E.M. Number | 22662230 | 010 | <b>83905</b> |
| <b>08 - 09</b> VHD Models - With O.E.M. Number         | 20704334 | 010 | <b>83048</b> |
|  | 22662125 | 010 | <b>83048</b> |





#### VN Series - 2200

|   |          |     |              |
|---|----------|-----|--------------|
| VN Models - Horizontal Position                 | 20496217 | 010 | <b>83029</b> |
|   | 8078547  | 010 | <b>83029</b> |
| VN Models - Vertical Position (w/O.E.M. Number) | 20496215 | 010 | <b>83048</b> |
|   | 20704334 | 010 | <b>83048</b> |
|   | 20721254 | 010 | <b>83048</b> |
|   | 21368413 | 010 | <b>83048</b> |
|   | 22662125 | 010 | <b>83048</b> |
|   | 8078546  | 010 | <b>83028</b> |

#### VNL - Series

|   |          |     |              |
|---|----------|-----|--------------|
| <b>06 - 10</b> VNL 42T-300 Models - With O.E.M. Number      | 20704334 | 010 | <b>83048</b> |
|   | 22662125 | 010 | <b>83048</b> |
| <b>2011 -</b> VNL 42T-300 Models - With O.E.M. Number       | 22662230 | 010 | <b>83905</b> |
| <b>11 - 17</b> VNL 64T-300 DayCab Models with O.E.M. Number | 21368411 | 010 | <b>83905</b> |
|   | 22662230 | 010 | <b>83905</b> |
| <b>13 - 16</b> VNL 64T-430 Models with Flat Top Sleepers    | 21391412 | 010 | <b>83048</b> |

**APPLICATION GUIDE - TRUCKS, TRAILERS, AND BUSES**

| Year<br>Año<br>Année | Model<br>Modelo<br>Modèle | OEM # | Front  |   | Rear   |   |
|----------------------|---------------------------|-------|--|---|--|---|
|                      |                           |       |  |  |  |  |
|                      |                           |       | Fleetline  | GasSLX  | Fleetline  | GasSLX  |

**VOLVO CAB SHOCKS(Cont'd.)**

**VNL - Series(Cont'd.)**

|           |   |          |     |       |
|-----------|---|----------|-----|-------|
| 13 - 16   | VNL 64T-630 Models with Flat Top Sleepers                                   | 21391412 | 010 | 83048 |
| - 2013    | VNL 64T-670 Models with High Rise Sleeper Cabs                              | 21368413 | 010 | 83048 |
| 14 - 17   | VNL 64T-670 Models with High Rise Sleeper Cabs                              | 22662235 | 010 | 83905 |
| 15 - 18   | VNL 64T-730 Models with Mid Rise Sleeper Cabs                               | 22662237 | 010 | 83905 |
| 2018 - 19 | VNL 64T-740 Models with High Rise Sleeper Cabs                              | 22662237 | 010 | 83905 |
| - 2014    | VNL 64T-780 Models with High Rise Sleeper Cabs                              | 20721254 | 010 | 83048 |
|           |   | 21368413 | 010 | 83048 |
| 15 - 18   | VNL 64T-780 Models with High Rise Sleeper Cabs                              | 22662237 | 010 | 83905 |
| 2018 - 19 | VNL 64T-860 Models with High Rise Sleeper Cabs                              | 22662237 | 010 | 83905 |
| 06 - 11   | VNL Models - All with 60" to 77" Mid - High Roof Sleepers (w/O.E.M. Number) | 20721254 | 010 | 83048 |

**VNM - Series**

|         |   |          |     |       |
|---------|---|----------|-----|-------|
| 2013    | VNM 42T-200 Day Cab Models  | 21368411 | 010 | 83905 |
| 13 - 17 | VNM 64T-200 Day Cab Models  | 21368411 | 010 | 83905 |
|         |   | 22662230 | 010 | 83905 |
|         |   | 22662237 | 010 | 83905 |
| 2016    | VNM 64T-630 Models with High Rise Sleeper Cabs                              | 22662235 | 010 | 83905 |
| - 2014  | VNM Models - All with 60" to 77" Mid - High Roof Sleepers (w/O.E.M. Number) | 21391412 | 010 | 83048 |





**VNR - Series**

|      |   |          |     |       |
|------|---|----------|-----|-------|
| 2018 | VNR 64T-400 Models with 42" Flat Roof Sleeper | 22662235 | 010 | 83905 |
|------|---|----------|-----|-------|

**WABASH NATIONAL**

| Identification of the trailer suspension is necessary to determine what section of the catalog to refer to. Some possible options can be Chalmers, Hendrickson, Neway, Ridewell, Reyco. |  |                |     |     |     |       |       |
|---|--|----------------|-----|-----|-----|-------|-------|
| 1997 -  | RHP11, RHP55 and RideSentry Trailer Suspension | 202447         | ... | ... | 010 | 85919 | ...   |
|   |  | 203447         | ... | ... | 010 | 85919 | ...   |
|   | Trailers with Aurora part number               | DANSR1VJ100    | ... | ... | 010 | 85078 | ...   |
|   |  | FLL83203-071   | ... | ... | 010 | 83203 | 89436 |
|   |  | FLL83207-071   | ... | ... | 010 | 83207 | 89407 |
|   |  | FLL85000-071   | ... | ... | 010 | 85000 | 89436 |
|   |  | FLL85030-071   | ... | ... | 010 | 85030 | 89440 |
|   |  | FRUUCE1295-1   | ... | ... | 010 | 85300 | 89419 |
|   |  | FRUUCE1295-901 | ... | ... | 010 | 85300 | 89419 |
|   |  | FRUUCE2983-1   | ... | ... | 010 | 85322 | ...   |
|   |  | FRUUCF8339-1   | ... | ... | 010 | 85321 | ...   |
|   |  | HENS-20001     | ... | ... | 010 | 83128 | 89436 |
|   |  | HENS-20002     | ... | ... | 010 | 85000 | 89436 |
|   |  | HENS-20126     | ... | ... | 010 | 85323 | 89436 |
|   |  | HENS-21292     | ... | ... | 010 | 85052 | ...   |
|   |  | HENS-23566     | ... | ... | 010 | 85000 | 89436 |
|   |  | NEW900-44-089  | ... | ... | 010 | 83124 | 89407 |
|   |  | NEW900-44-162  | ... | ... | 010 | 83128 | 89436 |
|   |  | NEW900-44-625  | ... | ... | 010 | 83125 | ...   |
|   |  | NEW900-44-626  | ... | ... | 010 | 83126 | 89430 |
|   |  | NEW900-44-642  | ... | ... | 010 | 83127 | ...   |
|   |  | NEW900-44-794  | ... | ... | 010 | 83127 | ...   |
|   |  | NEW900-44-868  | ... | ... | 010 | 85045 | ...   |
|   |  | NEW900-44-978  | ... | ... | 010 | 85059 | ...   |
|   |  | NEW900-44-979  | ... | ... | 010 | 83113 | ...   |
|   |  | NEW900-45-040  | ... | ... | 010 | 83130 | ...   |
|   |  | NEW900-45-054  | ... | ... | 010 | 85051 | ...   |
|   |  | NEW900-45-298  | ... | ... | 010 | 83128 | 89436 |
|   |  | NEW900-45-299  | ... | ... | 010 | 85000 | 89436 |

**APPLICATION GUIDE - TRUCKS, TRAILERS, AND BUSES**

| Year<br>Año<br>Année | Model<br>Modelo<br>Modèle | OEM # | Front   |   | Rear  |   |
|----------------------|---------------------------|-------|---|---|---|---|
|                      |                           |       |  |  |  |  |
|                      |                           |       | Fleetline   | GasSLX  | Fleetline   | GasSLX  |

**WABASH NATIONAL(Cont'd.)**

|                                  |            |  |     |     |     |       |       |  |
|----------------------------------|------------|--|-----|-----|-----|-------|-------|--|
| Trailers with Aurora part number |            |  |     |     |     |       |       |  |
| Heavy Duty                       | HENS-24088 |  | ... | ... | 010 | 85000 | 89436 |  |
| Standard                         | HENS-24088 |  | ... | ... | 010 | 83128 | 89436 |  |

**WATSON & CHALIN MFG. INC.**

**Heavy Duty Trailer Air Suspension**

|                      |       |  |     |     |     |       |     |  |
|----------------------|-------|--|-----|-----|-----|-------|-----|--|
| TA-2590-14, 17 HD    | 10148 |  | ... | ... | 010 | 83204 | ... |  |
| TA-3090-14, -17, -19 | 10148 |  | ... | ... | 010 | 83204 | ... |  |
| TA-550-17            | 10148 |  | ... | ... | 010 | 83204 | ... |  |

**Light Weight Trailer Air Suspension**

|           |       |  |     |     |     |       |       |  |
|-----------|-------|--|-----|-----|-----|-------|-------|--|
| TA-3175-9 | 17079 |  | ... | ... | 010 | 85300 | 89419 |  |
| TA-751-16 | 10148 |  | ... | ... | 010 | 83204 | ...   |  |

**LWSL-1100-SR Self Steer Axle Suspension**

|                   |       |  |     |     |     |       |       |  |
|-------------------|-------|--|-----|-----|-----|-------|-------|--|
| AL-1100-SR Models | 10148 |  | ... | ... | 010 | 83204 | ...   |  |
| HL-1100-20        | 10148 |  | ... | ... | 010 | 83204 | ...   |  |
| HL-1100-20 FL     | 10147 |  | ... | ... | 010 | 83203 | 89436 |  |
| SL-1100-LR        | 12128 |  | ... | ... | 010 | 85005 | 89430 |  |

**Trailer Air Suspension**

|                           |       |  |     |     |     |       |       |  |
|---------------------------|-------|--|-----|-----|-----|-------|-------|--|
| TA-2590-12, 14, 15, & 17, | 12128 |  | ... | ... | 010 | 85005 | 89430 |  |
| TA-2590-12-1              | 10147 |  | ... | ... | 010 | 83203 | 89436 |  |

**WCAL-2200 Series Pusher or Tag Axle Assembly**

|                |       |  |     |     |     |       |     |  |
|----------------|-------|--|-----|-----|-----|-------|-----|--|
| AL-2200 Models | 10148 |  | ... | ... | 010 | 83204 | ... |  |
|----------------|-------|--|-----|-----|-----|-------|-----|--|

**WCTA Series Dump Trailer Air Suspension**

|                                      |       |  |     |     |     |       |       |  |
|--------------------------------------|-------|--|-----|-----|-----|-------|-------|--|
| TA-1600-21                           | 11604 |  | ... | ... | 010 | 83125 | ...   |  |
| TA-1900-15                           | 10147 |  | ... | ... | 010 | 83203 | 89436 |  |
| TA-1900-16, -17                      | 10148 |  | ... | ... | 010 | 83204 | ...   |  |
| TA-1900-18, -19                      | 12128 |  | ... | ... | 010 | 85005 | 89430 |  |
| TA-5000-DB-19, -F-19                 | 12128 |  | ... | ... | 010 | 85005 | 89430 |  |
| TA-5000-DB-24, -DB-30, -F-24, -F-30, | 11724 |  | ... | ... | 010 | 83123 | 89405 |  |
| TA-525, -DB                          | 10147 |  | ... | ... | 010 | 83203 | 89436 |  |

**WCTA Series Trailer Air Suspension**

|                          |       |  |     |     |     |       |       |  |
|--------------------------|-------|--|-----|-----|-----|-------|-------|--|
| TA-2075-6                | 10148 |  | ... | ... | 010 | 83204 | ...   |  |
| TA-2075-9                | 12128 |  | ... | ... | 010 | 85005 | 89430 |  |
| TA-250-12                | 10148 |  | ... | ... | 010 | 83204 | ...   |  |
| TA-250-6, 7.5, 9,        | 10147 |  | ... | ... | 010 | 83203 | 89436 |  |
| TA-251-12, -12FS,        | 10148 |  | ... | ... | 010 | 83204 | ...   |  |
| TA-251-6.5, -6.5FS,      | 10147 |  | ... | ... | 010 | 83203 | 89436 |  |
| TA-251-7.5, -7.5FS       | 10147 |  | ... | ... | 010 | 83203 | 89436 |  |
| TA-251-8FS               | 10147 |  | ... | ... | 010 | 83203 | 89436 |  |
| TA-251-9.0, -9.0FS, -10, | 10147 |  | ... | ... | 010 | 83203 | 89436 |  |
| TA-255-9                 | 10147 |  | ... | ... | 010 | 83203 | 89436 |  |
| TA-280-6.5, 7.5, -9.0,   | 11604 |  | ... | ... | 010 | 83125 | ...   |  |
| TA-300-9                 | 10147 |  | ... | ... | 010 | 83203 | 89436 |  |
| TA-380-9                 | 12128 |  | ... | ... | 010 | 85005 | 89430 |  |

**WCTA-1200 Series Trailer Air Suspension**

|           |       |  |     |     |     |        |       |  |
|-----------|-------|--|-----|-----|-----|--------|-------|--|
| TA-1000   | 10634 |  | ... | ... | 010 | G63357 | ...   |  |
| TA-1200-5 | 10147 |  | ... | ... | 010 | 83203  | 89436 |  |

**WCTL-2200 Series Trailer Air Lift**

|                                |       |  |     |     |     |       |       |  |
|--------------------------------|-------|--|-----|-----|-----|-------|-------|--|
| TL-1600-21                     | 11604 |  | ... | ... | 010 | 83125 | ...   |  |
| 10/89 - TL-2590-12,14,15, & 17 | 12128 |  | ... | ... | 010 | 85005 | 89430 |  |

**WCWB Series Trailer Air Suspension**

|                    |       |  |     |     |     |       |       |  |
|--------------------|-------|--|-----|-----|-----|-------|-------|--|
| WB-2500-6          | 10148 |  | ... | ... | 010 | 83204 | ...   |  |
| WB-2500-7.5, -9,   | 12128 |  | ... | ... | 010 | 85005 | 89430 |  |
| WB-251-6.5, 7.5, 9 | 10147 |  | ... | ... | 010 | 83203 | 89436 |  |

## APPLICATION GUIDE - TRUCKS, TRAILERS, AND BUSES

| Year<br>Año<br>Année | Model<br>Modelo<br>Modèle | OEM # | Front     |        |  | Rear |  |  |
|----------------------|---------------------------|-------|-----------|--------|--|------|--|--|
|                      |                           |       |           |        |  |      |  |  |
|                      |                           |       | Fleetline | GasSLX |  |      |  |  |

### WATSON & CHALIN MFG. INC.(Cont'd.)

#### WCWB Series Trailer Air Suspension(Cont'd.)

|                           |         |  |     |     |     |       |       |
|---------------------------|---------|--|-----|-----|-----|-------|-------|
| WB-280-9                  | 11604   |  | ... | ... | 010 | 83125 | ...   |
| Models with O.E.M. Number | 17300   |  | ... | ... | 010 | 85052 | ...   |
|                           | 3946219 |  | ... | ... | 11  | 83400 | ...   |
|                           | 665727  |  | ... | ... | 010 | 85005 | 89430 |
|                           | 665769  |  | ... | ... | 010 | 85052 | ...   |

#### Additional O.E.M. Interchanges

|                           |          |  |     |     |     |       |       |
|---------------------------|----------|--|-----|-----|-----|-------|-------|
| Models with O.E.M. Number | 10147HD  |  | ... | ... | 010 | 85000 | 89436 |
|                           | 17186    |  | ... | ... | 010 | 85323 | 89436 |
|                           | 17186-01 |  | ... | ... | 010 | 85323 | 89436 |
|                           | 17218    |  | ... | ... | 010 | 85029 | ...   |
|                           | 17297    |  | ... | ... | 010 | 85064 | ...   |
|                           | 17306    |  | ... | ... | 010 | 85938 | ...   |
|                           | 17317    |  | ... | ... | 010 | 85344 | ...   |
|                           | 17382    |  | ... | ... | 010 | 85014 | ...   |
|                           | 17430    |  | ... | ... | 010 | 85321 | ...   |
|                           | 17474    |  | ... | ... | 10  | 85009 | ...   |
|                           | 19036    |  | ... | ... | 010 | 85934 | ...   |
|                           | 19249    |  | ... | ... | 010 | 85939 | ...   |
|                           | 19250    |  | ... | ... | 010 | 85382 | ...   |
|                           | 19603    |  | ... | ... | 010 | 85939 | ...   |
|                           | 665724   |  | ... | ... | 010 | 85000 | 89436 |
|                           | 665728   |  | ... | ... | 010 | 85060 | ...   |
|                           | 665770   |  | ... | ... | 010 | 85064 | ...   |
|                           | 665862   |  | ... | ... | 010 | 85000 | 89436 |
|                           | 680547   |  | ... | ... | 010 | 85323 | 89436 |
|                           | 680584   |  | ... | ... | 010 | 85938 | ...   |
|                           | 680714   |  | ... | ... | 010 | 85934 | ...   |
|                           | 727603   |  | ... | ... | 010 | 83203 | 89436 |
|                           | 727604   |  | ... | ... | 010 | 83204 | ...   |
|                           | A-20345  |  | ... | ... | 010 | 85345 | ...   |
|                           | B-23649  |  | ... | ... | 010 | 85064 | ...   |
|                           | B-23650  |  | ... | ... | 010 | 85052 | ...   |
|                           | B-23651  |  | ... | ... | 010 | 85045 | ...   |
|                           | B-23743  |  | ... | ... | 010 | 85938 | ...   |

### WESTERN STAR

|                                       |             |  |     |     |     |       |     |
|---------------------------------------|-------------|--|-----|-----|-----|-------|-----|
| Models with Neway ADZ Rear Suspension | 47170000423 |  | ... | ... | 010 | 85109 | ... |
|                                       | 90045605    |  | ... | ... | 010 | 85109 | ... |

#### 3800 Series - Heritage Class

|                                  |            |     |       |       |     |       |       |
|----------------------------------|------------|-----|-------|-------|-----|-------|-------|
| 3842S, 3864S Models              | 37390-4401 | 010 | 85053 | 89442 |     | ...   | ...   |
|                                  | 37390-4402 | 010 | 85053 | 89442 |     | ...   | ...   |
|                                  | 37390-4403 | 010 | 85053 | 89442 |     | ...   | ...   |
| With Hendrickson Rear Suspension | 47902-13   |     | ...   | ...   | 010 | 83122 | 89406 |
|                                  | 47902-24   |     | ...   | ...   | 010 | 83137 | ...   |
|                                  | 47902-8    |     | ...   | ...   | 010 | 83122 | 89406 |
| With Neway Rear Suspension       | 90044025   |     | ...   | ...   | 010 | 83209 | 89414 |
|                                  | 90044907   |     | ...   | ...   | 01  | 83635 | ...   |

#### 4700 Series

|  |              |     |       |       |     |       |       |
|--|--------------|-----|-------|-------|-----|-------|-------|
| 11 - 19<br>Models with 18,000 lb - 20,000 lb Flat Leaf Spring and Set Forward Front Axle | 10-13684-000 | 010 | 85918 | 89449 |     | ...   | ...   |
|  | 471700000470 | 010 | 85918 | 89449 |     | ...   | ...   |
| 11 - 19<br>Models with 20000 lb Set -Back Front Axle                                     | 10-13809-000 | 010 | 85958 | ...   |     | ...   | ...   |
|  | 471700003920 | 010 | 85958 | ...   |     | ...   | ...   |
| 11 - 19<br>Models with FAS II Rear Air Suspension  | 16-18708-000 |     | ...   | ...   | 010 | 85724 | 89443 |
|  | 471700002809 |     | ...   | ...   | 010 | 85724 | 89443 |

## APPLICATION GUIDE - TRUCKS, TRAILERS, AND BUSES

| Year<br>Año<br>Année | Model<br>Modelo<br>Modèle | OEM # | Front     |        | Rear      |        |
|----------------------|---------------------------|-------|-----------|--------|-----------|--------|
|                      |                           |       |           |        |           |        |
|                      |                           |       | Fleetline | GasSLX | Fleetline | GasSLX |

### WESTERN STAR(Cont'd.)

#### 4700 Series(Cont'd.)

|         |  |                 |  |     |     |     |              |     |
|---------|--|-----------------|--|-----|-----|-----|--------------|-----|
| 11 - 19 | Models with Freightliner TufTrac Rear Air Suspension   | 16-15770-000    |  | ... | ... | O O | <b>85956</b> | ... |
|         |  | 481700125969    |  | ... | ... | O O | <b>85956</b> | ... |
|         |  | SDA481700125969 |  | ... | ... | O O | <b>85956</b> | ... |
| 11 - 19 | Models with Hendrickson HMX 400/460 Haulmax with 16.5" Saddle                                  | 60680-004       |  | ... | ... | O - | <b>83143</b> | ... |
|         |  | 60680-004L      |  | ... | ... | O - | <b>83143</b> | ... |
| 11 - 19 | Models with Hendrickson HMX 400/460 Haulmax with 17.5" & 18.5" Saddle                          | 60680-005       |  | ... | ... | O - | <b>83142</b> | ... |
|         |  | 60680-005L      |  | ... | ... | O - | <b>83142</b> | ... |
| 11 - 19 | Models with Hendrickson HN - 462   | 60680-003       |  | ... | ... | O - | <b>83112</b> | ... |
|         |  | 60680-003L      |  | ... | ... | O - | <b>83112</b> | ... |
| 11 - 19 | Models with Hendrickson Primaax EX 462 Air Suspensions Standard with 8 1/2" to 10" Ride Height | 60657-003       |  | ... | ... | O O | <b>85072</b> | ... |
|         |  | 60657-003L      |  | ... | ... | O O | <b>85072</b> | ... |
| 11 - 19 | Models with Reyco 79KB Rear Steel Spring Suspension  | 16725-01        |  | ... | ... | O O | <b>83126</b> | ... |
|         |  | 19495-01        |  | ... | ... | O O | <b>83126</b> | ... |

#### 4800 & 4900 Series - Constellation Class





|         |  |                 |     |              |              |     |              |              |
|---------|--|-----------------|-----|--------------|--------------|-----|--------------|--------------|
|         | 4842FX, 4864FX, 4964EX, 4964EX, 4942SX or 4964SX Constellation Class | 37301-3401      | O O | <b>85053</b> | <b>89442</b> |     | ...          | ...          |
|         |  | 37301-3404      | O O | <b>85053</b> | <b>89442</b> |     | ...          | ...          |
|         |  | 37301-3409      | O O | <b>85053</b> | <b>89442</b> |     | ...          | ...          |
|         |  | 37301-3412      | O O | <b>85053</b> | <b>89442</b> |     | ...          | ...          |
|         |  | 37390-4401      | O O | <b>85053</b> | <b>89442</b> |     | ...          | ...          |
|         |  | 37390-4402      | O O | <b>85053</b> | <b>89442</b> |     | ...          | ...          |
|         |  | 37390-4403      | O O | <b>85053</b> | <b>89442</b> |     | ...          | ...          |
| 09 - 12 | Models w/ Low Profile Rear Air Suspension                            | 16-18706-000    |     | ...          | ...          | O O | <b>85331</b> | ...          |
| 09 - 15 | Models with 12000 lb Taperleaf Front Suspension                      | 10-13809-000    | O O | <b>85958</b> | ...          |     | ...          | ...          |
|         |  | SDA471700003920 | O O | <b>85958</b> | ...          |     | ...          | ...          |
| 08 - 19 | Models with Freightliner TufTrac Rear Air Suspension                 | 16-15770-000    |     | ...          | ...          | O O | <b>85956</b> | ...          |
|         |  | SDA481700125969 |     | ...          | ...          | O O | <b>85956</b> | ...          |
| - 2016  | Models with Hendrickson Front Airtek                                 | 471700006269    | O O | <b>85932</b> | <b>89453</b> |     | ...          | ...          |
|         |  | 471700131331    | O O | <b>85932</b> | <b>89453</b> |     | ...          | ...          |
|         |  | 58913-003       | O O | <b>85932</b> | <b>89453</b> |     | ...          | ...          |
|         |  | 58913-003L      | O O | <b>85932</b> | <b>89453</b> |     | ...          | ...          |
|         |  | 58913-012       | O O | <b>85932</b> | <b>89453</b> |     | ...          | ...          |
|         |  | 58913-012L      | O O | <b>85932</b> | <b>89453</b> |     | ...          | ...          |
|         | With Hendrickson HAS-40LH Rear Suspension                            | 57241-1         |     | ...          | ...          | O - | <b>83111</b> | ...          |
|         | With Hendrickson Rear Suspension                                     | 47902-13        |     | ...          | ...          | O O | <b>83122</b> | <b>89406</b> |
|         |  | 47902-24        |     | ...          | ...          | O O | <b>83137</b> | ...          |
|         |  | 47902-8         |     | ...          | ...          | O O | <b>83122</b> | <b>89406</b> |
|         | With Neway Rear Suspension   | 90044025        |     | ...          | ...          | O O | <b>83209</b> | <b>89414</b> |
|         |  | 90044907        |     | ...          | ...          | O - | <b>83635</b> | ...          |
|         |  | 90045099        |     | ...          | ...          | O O | <b>85906</b> | <b>89407</b> |

#### 4800 & 4900 Series - Heritage Class

|         |   |                 |     |              |              |     |              |     |
|---------|---|-----------------|-----|--------------|--------------|-----|--------------|-----|
|         | 4842F, 4864F, 4843S, 4864S, 4942F, 4964F, 4942S or 4964S Heritage Class | 37301-3401      | O O | <b>85053</b> | <b>89442</b> |     | ...          | ... |
|         |   | 37301-3404      | O O | <b>85053</b> | <b>89442</b> |     | ...          | ... |
|         |   | 37301-3409      | O O | <b>85053</b> | <b>89442</b> |     | ...          | ... |
|         |   | 37301-3412      | O O | <b>85053</b> | <b>89442</b> |     | ...          | ... |
|         |   | 37390-4401      | O O | <b>85053</b> | <b>89442</b> |     | ...          | ... |
|         |   | 37390-4402      | O O | <b>85053</b> | <b>89442</b> |     | ...          | ... |
|         |   | 37390-4403      | O O | <b>85053</b> | <b>89442</b> |     | ...          | ... |
| 09 - 15 | Models with 12000 lb Taperleaf Front Suspension                         | 10-13809-000    | O O | <b>85958</b> | ...          |     | ...          | ... |
|         |   | SDA471700003920 | O O | <b>85958</b> | ...          |     | ...          | ... |
| 08 - 19 | Models with Freightliner TufTrac Rear Air Suspension                    | 16-15770-000    |     | ...          | ...          | O O | <b>85956</b> | ... |
|         |   | SDA481700125969 |     | ...          | ...          | O O | <b>85956</b> | ... |



**APPLICATION GUIDE - TRUCKS, TRAILERS, AND BUSES**

| Year<br>Año<br>Année | Model<br>Modelo<br>Modèle | OEM # | Front  |  | Rear  |   |
|----------------------|---------------------------|-------|--|--|---|---|
|                      |                           |       |  |  |  |  |
|                      |                           |       | Fleetline  | GasSLX   | Fleetline   | GasSLX  |

**WESTERN STAR(Cont'd.)**

**4800 & 4900 Series - Heritage Class(Cont'd.)**

|               |   |              |     |              |              |              |              |              |
|---------------|---|--------------|-----|--------------|--------------|--------------|--------------|--------------|
| <b>- 2016</b> | Models with Hendrickson Front Airtek      | 471700006269 | 010 | <b>85932</b> | <b>89453</b> |              | ...          | ...          |
|               |   | 471700131331 | 010 | <b>85932</b> | <b>89453</b> |              | ...          | ...          |
|               |   | 58913-003    | 010 | <b>85932</b> | <b>89453</b> |              | ...          | ...          |
|               |   | 58913-003L   | 010 | <b>85932</b> | <b>89453</b> |              | ...          | ...          |
|               |   | 58913-012    | 010 | <b>85932</b> | <b>89453</b> |              | ...          | ...          |
|               |   | 58913-012L   | 010 | <b>85932</b> | <b>89453</b> |              | ...          | ...          |
|               | With Hendrickson HAS-40LH Rear Suspension | 57241-1      |     | ...          | ...          | 01-          | <b>83111</b> | ...          |
|               | With Hendrickson Rear Suspension          | 47902-13     |     | ...          | ...          | 010          | <b>83122</b> | <b>89406</b> |
| 47902-24      |   |              | ... | ...          | 010          | <b>83137</b> | ...          |              |
| 47902-8       |   |              | ... | ...          | 010          | <b>83122</b> | <b>89406</b> |              |
|               | With Neway Rear Suspension                | 90044025     |     | ...          | ...          | 010          | <b>83209</b> | <b>89414</b> |
| 90044907      |   |              | ... | ...          | 01-          | <b>83635</b> | ...          |              |
| 90045099      |   |              | ... | ...          | 010          | <b>85906</b> | <b>89407</b> |              |

**5800 & 5900 Series - Constellation Class**

|                 |  |                |   |              |              |              |              |              |
|-----------------|--|----------------|---|--------------|--------------|--------------|--------------|--------------|
|                 | 5842SS, 5864SS, 5942SS or 5964SS Constellation Class | 37301-3401     | 010   | <b>85053</b> | <b>89442</b> |              | ...          | ...          |
|                 |  | 37301-3404     | 010   | <b>85053</b> | <b>89442</b> |              | ...          | ...          |
|                 |  | 37301-3409     | 010   | <b>85053</b> | <b>89442</b> |              | ...          | ...          |
|                 |  | 37301-3412     | 010   | <b>85053</b> | <b>89442</b> |              | ...          | ...          |
|                 |  | 37390-4401     | 010   | <b>85053</b> | <b>89442</b> |              | ...          | ...          |
|                 |  | 37390-4402     | 010   | <b>85053</b> | <b>89442</b> |              | ...          | ...          |
|                 |  | 37390-4403     | 010   | <b>85053</b> | <b>89442</b> |              | ...          | ...          |
|                 |  | <b>09 - 15</b> | Models with 12000 lb Taperleaf Front Suspension | 10-13809-000 | 010          | <b>85958</b> | ...          |              |
| SDA471700003920 | 010  | <b>85958</b>   |   | ...          |              | ...          | ...          |              |
| <b>08 - 15</b>  | Models with Freightliner TufTrac Rear Air Suspension | 16-15770-000   |   | ...          | ...          | 010          | <b>85956</b> | ...          |
| SDA481700125969 |  |                | ...   | ...          | 010          | <b>85956</b> | ...          |              |
|                 | With Hendrickson Rear Suspension                     | 47902-13       |   | ...          | ...          | 010          | <b>83122</b> | <b>89406</b> |
| 47902-24        |  |                | ...   | ...          | 010          | <b>83137</b> | ...          |              |
| 47902-8         |  |                | ...   | ...          | 010          | <b>83122</b> | <b>89406</b> |              |
|                 | With Neway Rear Suspension                           | 90044025       |   | ...          | ...          | 010          | <b>83209</b> | <b>89414</b> |
| 90044907        |  |                | ...   | ...          | 01-          | <b>83635</b> | ...          |              |
| 90045099        |  |                | ...   | ...          | 010          | <b>85906</b> | <b>89407</b> |              |
|                 | With Hendrickson Rear Suspension                     | 57905-2        |   | ...          | ...          | 010          | <b>85006</b> | ...          |

**5900 & 6900 Series - Heritage Class**

|                 |  |              |                               |              |              |              |              |              |
|-----------------|--|--------------|-------------------------------|--------------|--------------|--------------|--------------|--------------|
|                 | 5942S, 5964S, 6964F or 6964S Heritage Class          | 37301-3401   | 010                           | <b>85053</b> | <b>89442</b> |              | ...          | ...          |
|                 |  | 37301-3404   | 010                           | <b>85053</b> | <b>89442</b> |              | ...          | ...          |
|                 |  | 37301-3409   | 010                           | <b>85053</b> | <b>89442</b> |              | ...          | ...          |
|                 |  | 37301-3412   | 010                           | <b>85053</b> | <b>89442</b> |              | ...          | ...          |
|                 |  | 37390-4401   | 010                           | <b>85053</b> | <b>89442</b> |              | ...          | ...          |
|                 |  | 37390-4402   | 010                           | <b>85053</b> | <b>89442</b> |              | ...          | ...          |
|                 |  | 37390-4403   | 010                           | <b>85053</b> | <b>89442</b> |              | ...          | ...          |
|                 |  |              | All with 4 shock Front System | .....        | 010          | <b>83401</b> | ...          |              |
| <b>09 - 15</b>  | Models with 12000 lb Taperleaf Front Suspension      | 10-13809-000 | 010                           | <b>85958</b> | ...          |              | ...          | ...          |
| SDA471700003920 |  | 010          | <b>85958</b>                  | ...          |              | ...          | ...          |              |
| <b>08 - 15</b>  | Models with Freightliner TufTrac Rear Air Suspension | 16-15770-000 |                               | ...          | ...          | 010          | <b>85956</b> | ...          |
| SDA481700125969 |  |              | ...                           | ...          | 010          | <b>85956</b> | ...          |              |
| <b>- 06/10</b>  | Models with Hendrickson Airtek Suspension            | 58913-003    | 010                           | <b>85932</b> | <b>89453</b> |              | ...          | ...          |
| 58913-003L      |  | 010          | <b>85932</b>                  | <b>89453</b> |              | ...          | ...          |              |
| <b>07/10 -</b>  | Models with Hendrickson Airtek Suspension            | 471700006269 | 010                           | <b>85932</b> | <b>89453</b> |              | ...          | ...          |
| 58913-012       |  | 010          | <b>85932</b>                  | <b>89453</b> |              | ...          | ...          |              |
| 58913-012L      |  | 010          | <b>85932</b>                  | <b>89453</b> |              | ...          | ...          |              |
|                 | With Hendrickson HAS-40LH Rear Suspension            | 57241-1      |                               | ...          | ...          | 01-          | <b>83111</b> | ...          |
|                 | With Hendrickson Rear Suspension                     | 47902-13     |                               | ...          | ...          | 010          | <b>83122</b> | <b>89406</b> |
| 47902-24        |  |              | ...                           | ...          | 010          | <b>83137</b> | ...          |              |
| 47902-8         |  |              | ...                           | ...          | 010          | <b>83122</b> | <b>89406</b> |              |

## APPLICATION GUIDE - TRUCKS, TRAILERS, AND BUSES

| Year<br>Año<br>Année | Model<br>Modelo<br>Modèle | OEM # | Front     |        | Rear      |        |
|----------------------|---------------------------|-------|-----------|--------|-----------|--------|
|                      |                           |       |           |        |           |        |
|                      |                           |       | Fleetline | GasSLX | Fleetline | GasSLX |

### WESTERN STAR(Cont'd.)

#### 5900 & 6900 Series - Heritage Class(Cont'd.)

|  |                                  |            |     |              |              |     |                       |              |
|--|----------------------------------|------------|-----|--------------|--------------|-----|-----------------------|--------------|
|  | With Hendrickson Rear Suspension | 60675-002  |     | ...          | ...          | 010 | <b>85979</b>          | ...          |
|  |                                  | 60675-002L |     | ...          | ...          | 010 | <b>85979</b>          | ...          |
|  | With Neway Rear Suspension       | 90044025   |     | ...          | ...          | 010 | <b>83209</b>          | <b>89414</b> |
|  |                                  | 90044907   |     | ...          | ...          | 01- | <b>83635</b>          | ...          |
|  |                                  | 90045099   |     | ...          | ...          | 010 | <b>85906</b>          | <b>89407</b> |
|  |                                  |            |     | ...          | ...          |     |                       |              |
|  | Models with O.E.M. Number        | 02-7005976 | -1- | <b>83400</b> | ...          |     | ...                   | ...          |
|  |                                  | 02-7005977 | -1- | <b>83400</b> | ...          |     | ...                   | ...          |
|  |                                  | 04-9041375 |     | ...          | ...          | 010 | <b>85315</b>          | ...          |
|  |                                  | 28R010     | 010 | <b>83216</b> | ...          |     | ...                   | ...          |
|  |                                  | 35066-4413 |     | ...          | ...          | 010 | <b>83122</b>          | <b>89406</b> |
|  |                                  | 35901-0001 |     | ...          | ...          | 010 | <b>83209</b>          | <b>89414</b> |
|  |                                  | 35901-4403 |     | ...          | ...          | 010 | <b>85060</b>          | ...          |
|  |                                  | 37301-3405 | 010 | <b>85053</b> | <b>89442</b> |     | ...                   | ...          |
|  |                                  | 57252      | 010 | <b>85308</b> | <b>89422</b> |     | ...                   | ...          |
|  |                                  | 57905-1    |     | ...          | ...          | 010 | <b>85976</b>          | ...          |
|  |                                  | 665682     | 010 | <b>85053</b> | <b>89442</b> |     | ...                   | ...          |
|  |                                  | CP-5222    |     | ...          | ...          | 010 | <b>85315</b>          | ...          |
|  | With Hendrickson Rear Suspension | 57905-2    |     | ...          | ...          | 010 | <b>85006</b>          | ...          |
|  | Additional O.E.M. Interchanges   | 1011839    | 010 | <b>83216</b> | ...          |     | ...                   | ...          |
|  |                                  | 35901-3406 | 010 |              |              |     | <b>85305</b>          |              |
|  |                                  | 35901-3409 | 010 |              |              |     | <b>85304</b>          |              |
|  |                                  | 35901-3410 | 010 |              |              |     | <b>85307</b>          |              |
|  |                                  | 35901-3413 | 010 |              |              |     | <b>85006</b>          |              |
|  |                                  | 35901-3420 | 010 |              |              |     | <b>85303 or 89422</b> |              |
|  |                                  | 615016     | 010 |              |              |     | <b>83401</b>          |              |
|  |                                  | 676081     | 010 |              |              |     | <b>83401</b>          |              |
|  |                                  | 676082     | 010 |              |              |     | <b>83401</b>          |              |
|  |                                  |            |     |              |              |     |                       |              |





### WESTERN STAR CAB SHOCKS

|                |   |               |     |  |              |
|----------------|---|---------------|-----|--|--------------|
|                | 6900 Models   | 725470        | 010 |  | <b>83010</b> |
| <b>01 - 15</b> | 6900 SX Models  | 66010-3407    | 010 |  | <b>83065</b> |
|                | Constellation Day Cab Models                          | 18-60772-000  | 010 |  | <b>83026</b> |
|                |   | 66010-3405    | 010 |  | <b>83026</b> |
|                |   | 81-4903003500 | 010 |  | <b>83026</b> |
|                | Constellation Sleeper Cab Models                      | 18-60773-000  | 01- |  | <b>83027</b> |
|                |   | 66010-3406    | 01- |  | <b>83027</b> |
|                |   | 814903003501  | 01- |  | <b>83027</b> |
| <b>1986 -</b>  | Conventional Tractors with Link Cabmate Model WSC4000 | 1201-0012     | 010 |  | <b>83023</b> |
|                |   | 1202-0012     | 010 |  | <b>83023</b> |
|                | For 4800, 4900, 6900 Heritage & Constellation Day Cab | 66010-3402    | 010 |  | <b>83022</b> |
|                |   | 66010-3403    | 010 |  | <b>83022</b> |
|                | Heritage Constellation models                         | 66010-3404    | 010 |  | <b>83022</b> |
|                | Models with Link Cab Suspension                       | 1202-0032     | 010 |  | <b>83016</b> |
|                | Models with O.E.M. Number                             | 617547        | 010 |  | <b>83022</b> |
|                |   | 654846        | 01- |  | <b>83027</b> |
|                |   | GBL 654916    | 010 |  | <b>83026</b> |

### WESTERN UNIT "STABILAIRE" SUSPENSION

|  |   |         |  |     |     |     |              |              |
|--|---|---------|--|-----|-----|-----|--------------|--------------|
|  | Model 893T Trailer Suspension                                     | .....   |  | ... | ... | 010 | <b>85307</b> | ...          |
|  | Model TDA202, 203, 206, 240, 241, 243 Truck Drive Axle Suspension | .....   |  | ... | ... | 010 | <b>85735</b> | ...          |
|  | Model TDA204, 205, 242 - Truck Drive Axle Suspension              | .....   |  | ... | ... | 010 | <b>85307</b> | ...          |
|  | Models with O.E.M. Number   | 101030  |  | ... | ... | 010 | <b>85307</b> | ...          |
|  |   | 101364  |  | ... | ... | 010 | <b>85305</b> | ...          |
|  |   | 4939967 |  | ... | ... | 010 | <b>85308</b> | <b>89422</b> |

## APPLICATION GUIDE - TRUCKS, TRAILERS, AND BUSES

| Year<br>Año<br>Année | Model<br>Modelo<br>Modèle | OEM # | Front   |  | Rear  |   |
|----------------------|---------------------------|-------|---|--|---|---|
|                      |                           |       |  |  |  |  |
|                      |                           |       | Fleetline   | GasSLX   | Fleetline   | GasSLX  |

### WESTERN UNIT "STABILAIRE" SUSPENSION(Cont'd.)

|                           |       |  |     |     |     |              |              |
|---------------------------|-------|--|-----|-----|-----|--------------|--------------|
| Models with O.E.M. Number | 80370 |  | ... | ... | 010 | <b>85304</b> | ...          |
|                           | 80600 |  | ... | ... | 010 | <b>85300</b> | <b>89419</b> |

### WHEELED COACH IND





|  |          |     |              |     |     |              |     |
|--|----------|-----|--------------|-----|-----|--------------|-----|
| Citimedic models with Ford E350 & E450 Chassis | ASH-1136 |     | ...          | ... | -10 | <b>83178</b> | ... |
|  | ASH-1154 | -10 | <b>83177</b> | ... |     | ...          | ... |

### WINNEBAGO

#### Class A MotorHomes

|           |  |                |              |              |              |              |              |              |
|-----------|--|----------------|--------------|--------------|--------------|--------------|--------------|--------------|
| 99 - 17   | Adventurer Series MotorHomes with Ford F53 Chassis with 16,000 lb GVW to 22,000 lb GVW   | 1C34-18045-AA  | 010          | <b>83209</b> | <b>89414</b> |              | ...          | ...          |
|           |  | 1C34-18045-JA  | 010          | <b>83209</b> | <b>89414</b> |              | ...          | ...          |
|           |  | 9U94-18045-AA  | 010          | <b>83209</b> | <b>89414</b> |              | ...          | ...          |
|           |  | 9U94-18080-AA  |              | ...          | ...          | 010          | <b>83122</b> | <b>89406</b> |
|           |  | 9U9Z-18124-A   | 010          | <b>83209</b> | <b>89414</b> |              | ...          | ...          |
|           |  | 9U9Z-18125-A   |              | ...          | ...          | 010          | <b>83122</b> | <b>89406</b> |
|           |  | ASH-1022       | 010          | <b>83209</b> | <b>89414</b> |              | ...          | ...          |
|           |  | ASH-1023       |              | ...          | ...          | 010          | <b>83122</b> | <b>89406</b> |
|           |  | ASH-1205       | 010          | <b>83209</b> | <b>89414</b> |              | ...          | ...          |
|           |  | ASH-1206       |              | ...          | ...          | 010          | <b>83122</b> | <b>89406</b> |
|           |  | ASH-1228       | 010          | <b>83209</b> | <b>89414</b> |              | ...          | ...          |
|           |  | ASH-1229       | 010          | <b>83209</b> | <b>89414</b> |              | ...          | ...          |
|           |  | ASH-1230       |              | ...          | ...          | 010          | <b>83122</b> | <b>89406</b> |
|           |  | ASH-137        |              | ...          | ...          | 010          | <b>83122</b> | <b>89406</b> |
|           |  | ASH-25822      | 010          | <b>83209</b> | <b>89414</b> |              | ...          | ...          |
| ASH-25823 | 010  | <b>83209</b>   | <b>89414</b> |              | ...          | ...          |              |              |
| ASH-25824 |  | ...            | ...          | 010          | <b>83122</b> | <b>89406</b> |              |              |
| ASH-294   | 010  | <b>83209</b>   | <b>89414</b> |              | ...          | ...          |              |              |
| AT-620    | 010  | <b>83209</b>   | <b>89414</b> |              | ...          | ...          |              |              |
| AT-621    |  | ...            | ...          | 010          | <b>83122</b> | <b>89406</b> |              |              |
| AT-766    | 010  | <b>83209</b>   | <b>89414</b> |              | ...          | ...          |              |              |
| 03 - 04   | Adventurer Series MotorHomes with Workhorse W22, & W24 MotorHome Chassis with O.E.M. Number  | 24-186537      |              | ...          | ...          | 01-          | <b>85126</b> | ...          |
|           |  | F4-BE5-A011-HO |              | ...          | ...          | 01-          | <b>85126</b> | ...          |
| 03 - 10   | Adventurer Series MotorHomes with Workhorse W22, & W24 MotorHome Chassis with O.E.M. Number  | 24-153249      | 010          | <b>85125</b> | ...          |              | ...          | ...          |
|           |  | 24-186629      | 010          | <b>85125</b> | ...          |              | ...          | ...          |
|           |  | F4-BE5-A832-MO | 010          | <b>85125</b> | ...          |              | ...          | ...          |
|           |  | F4-BE5-B492-HO | 010          | <b>85125</b> | ...          |              | ...          | ...          |
|           |  | F4-BE5-F324-HO | 010          | <b>85125</b> | ...          |              | ...          | ...          |
|           |  | W0005662       | 010          | <b>85125</b> | ...          |              | ...          | ...          |
| W0006254  | 010  | <b>85125</b>   | ...          |              | ...          | ...          |              |              |
| 05 - 10   | Adventurer Series MotorHomes with Workhorse W22, & W24 MotorHome Chassis with O.E.M. Number  | 24-153256      |              | ...          | ...          | -1-          | <b>85124</b> | ...          |
|           |  | F4-BE5-F325-HO |              | ...          | ...          | -1-          | <b>85124</b> | ...          |
|           |  | W0005663       |              | ...          | ...          | -1-          | <b>85124</b> | ...          |
| 18 - 19   | Intent Series MotorHomes with Ford F53 Chassis with 16,000 lb GVW to 22,000 lb GVW   | ASH-1229       | 010          | <b>83209</b> | <b>89414</b> |              | ...          | ...          |
|           |  | ASH-25822      | 010          | <b>83209</b> | <b>89414</b> |              | ...          | ...          |
|           |  | ASH-25823      | 010          | <b>83209</b> | <b>89414</b> |              | ...          | ...          |
|           |  | ASH-25824      |              | ...          | ...          | 010          | <b>83122</b> | <b>89406</b> |
| 03 - 06   | Journey Series MotorHomes with Freightliner XC Chassis<br>ADL200 Suspension w/ 20K Rear<br>AS120 Front Suspension<br><br>Rear Shock with O.E.M. Number | 16-16873-000   |              | ...          | ...          | 010          | <b>85029</b> | ...          |
|           |  | 141700131810   | 010          | <b>83160</b> | ...          |              | ...          | ...          |
|           |  | 16-16737-000   | 010          | <b>83160</b> | ...          |              | ...          | ...          |
|           |  | 16-16874-000   | 010          | <b>83160</b> | ...          |              | ...          | ...          |
|           |  | 141700131809   |              | ...          | ...          | 010          | <b>85029</b> | ...          |

**APPLICATION GUIDE - TRUCKS, TRAILERS, AND BUSES**

| Year<br>Año<br>Année | Model<br>Modelo<br>Modèle | OEM # | Front   |   | Rear  |   |
|----------------------|---------------------------|-------|---|---|---|---|
|                      |                           |       |  |  |  |  |
|                      |                           |       | Fleetline   | GasSLX  | Fleetline   | GasSLX  |

**WINNEBAGO(Cont'd.)**

**Class A MotorHomes(Cont'd.)**

|         |   |                |     |       |       |     |       |       |
|---------|---|----------------|-----|-------|-------|-----|-------|-------|
| 03 - 06 | ADL200 Suspension w/ 20K Rear<br>ZF - IFS Front Suspension with 23,000 lb GVW or Greater  | 16-16736-000   |     | ...   | ...   | 010 | 85029 | ...   |
|         |   | 16-18103-000   | -1- | 85900 | ...   |     | ...   | ...   |
|         |   | 481700000493   | -1- | 85900 | ...   |     | ...   | ...   |
|         | Models with Workhorse UFO Chassis with Hendrickson Softek Front Suspension  | 66153-002      | 010 | 83124 | 89407 |     | ...   | ...   |
|         |   | F4-BE5-C832-MO | 010 | 83124 | 89407 |     | ...   | ...   |
| 11 - 19 | Sightseer Series MotorHomes with Ford F53 Chassis with 16,000 lb GVW to 22,000 lb GVW   | ASH-1229       | 010 | 83209 | 89414 |     | ...   | ...   |
|         |   | ASH-25822      | 010 | 83209 | 89414 |     | ...   | ...   |
|         |   | ASH-25823      | 010 | 83209 | 89414 |     | ...   | ...   |
|         |   | ASH-25824      |     | ...   | ...   | 010 | 83122 | 89406 |
| 11 - 19 | Sunova Series MotorHomes with Ford F53 Chassis with 16,000 lb GVW to 22,000 lb GVW  | ASH-1229       | 010 | 83209 | 89414 |     | ...   | ...   |
|         |   | ASH-25822      | 010 | 83209 | 89414 |     | ...   | ...   |
|         |   | ASH-25823      | 010 | 83209 | 89414 |     | ...   | ...   |
|         |   | ASH-25824      |     | ...   | ...   | 010 | 83122 | 89406 |
| 11 - 19 | SunStar & SunStar LX Series MotorHomes with Ford F53 Chassis with 16,000 lb GVW to 22,000 lb GVW  | ASH-1229       | 010 | 83209 | 89414 |     | ...   | ...   |
|         |   | ASH-25822      | 010 | 83209 | 89414 |     | ...   | ...   |
|         |   | ASH-25823      | 010 | 83209 | 89414 |     | ...   | ...   |
|         |   | ASH-25824      |     | ...   | ...   | 010 | 83122 | 89406 |
| 2006    | Tour Series MotorHomes with Freightliner XC Chassis<br>ADL200 Suspension w/ 20K Rear<br>AS120 Front Suspension<br><br>Rear Shock with O.E.M. Number<br><br>ZF - IFS Front Suspension with 23,000 lb GVW or Greater  | 16-16873-000   |     | ...   | ...   | 010 | 85029 | ...   |
|         |   | 141700131810   | 010 | 83160 | ...   |     | ...   | ...   |
|         |   | 16-16737-000   | 010 | 83160 | ...   |     | ...   | ...   |
|         |   | 16-16874-000   | 010 | 83160 | ...   |     | ...   | ...   |
|         |   | 141700131809   |     | ...   | ...   | 010 | 85029 | ...   |
|         |   | 16-16736-000   |     | ...   | ...   | 010 | 85029 | ...   |
|         |   | 16-18103-000   | -1- | 85900 | ...   |     | ...   | ...   |
|         |   | 481700000493   | -1- | 85900 | ...   |     | ...   | ...   |
| 04 - 06 | Vetra Series MotorHomes with Freightliner XC Chassis<br>ADL200 Suspension w/ 20K Rear<br>AS120 Front Suspension<br><br>Rear Shock with O.E.M. Number<br><br>ZF - IFS Front Suspension with 23,000 lb GVW or Greater | 16-16873-000   |     | ...   | ...   | 010 | 85029 | ...   |
|         |   | 141700131810   | 010 | 83160 | ...   |     | ...   | ...   |
|         |   | 16-16737-000   | 010 | 83160 | ...   |     | ...   | ...   |
|         |   | 16-16874-000   | 010 | 83160 | ...   |     | ...   | ...   |
|         |   | 141700131809   |     | ...   | ...   | 010 | 85029 | ...   |
|         |   | 16-16736-000   |     | ...   | ...   | 010 | 85029 | ...   |
|         |   | 16-18103-000   | -1- | 85900 | ...   |     | ...   | ...   |
|         |   | 481700000493   | -1- | 85900 | ...   |     | ...   | ...   |
| 11 - 19 | Vista & Vista LX Series MotorHomes with Ford F53 Chassis with 16,000 lb GVW to 22,000 lb GVW  | ASH-1229       | 010 | 83209 | 89414 |     | ...   | ...   |
|         |   | ASH-25822      | 010 | 83209 | 89414 |     | ...   | ...   |
|         |   | ASH-25823      | 010 | 83209 | 89414 |     | ...   | ...   |
|         |   | ASH-25824      |     | ...   | ...   | 010 | 83122 | 89406 |

**Class C MotorHomes**

|         |   |          |     |       |     |     |       |     |
|---------|---|----------|-----|-------|-----|-----|-------|-----|
| 07 - 13 | Access, Access Premier & Aspect Series MotorHomes with Ford E350 & E450 Chassis | ASH-1136 |     | ...   | ... | -10 | 83178 | ... |
|         |   | ASH-1154 | -10 | 83177 | ... |     | ...   | ... |
| 05 - 19 | Aspect Series MotorHomes with Ford E450 Chassis                                 | ASH-1136 |     | ...   | ... | -10 | 83178 | ... |
|         |   | ASH-1154 | -10 | 83177 | ... |     | ...   | ... |
| 13 - 19 | Cambria Series MotorHomes with Ford E450 Chassis                                | ASH-1136 |     | ...   | ... | -10 | 83178 | ... |
|         |   | ASH-1154 | -10 | 83177 | ... |     | ...   | ... |
| 99 - 19 | Minnie Winnie Series MotorHomes with Ford E350 & E450 Chassis                   | ASH-1136 |     | ...   | ... | -10 | 83178 | ... |
|         |   | ASH-1154 | -10 | 83177 | ... |     | ...   | ... |
| 06 - 19 | Outlook Series MotorHomes with Ford E350 & E450 Chassis                         | ASH-1136 |     | ...   | ... | -10 | 83178 | ... |
|         |   | ASH-1154 | -10 | 83177 | ... |     | ...   | ... |

## APPLICATION GUIDE - TRUCKS, TRAILERS, AND BUSES

| Year<br>Año<br>Année | Model<br>Modelo<br>Modèle | OEM # | Front     |        | Rear      |        |
|----------------------|---------------------------|-------|-----------|--------|-----------|--------|
|                      |                           |       |           |        |           |        |
|                      |                           |       | Fleetline | GasSLX | Fleetline | GasSLX |

### WINNEBAGO(Cont'd.)

#### Class C MotorHomes(Cont'd.)

|         |  |                      |     |              |     |     |              |     |
|---------|--|----------------------|-----|--------------|-----|-----|--------------|-----|
| 15 - 19 | Spirit Series MotorHomes with Ford E350 & E450 Chassis | ASH-1136<br>ASH-1154 |     | ...          | ... | - 0 | <b>83178</b> | ... |
|         |  |                      | - 0 | <b>83177</b> | ... | ... | ...          | ... |

### WORKHORSE

|                |  |  |     |              |              |               |               |     |
|----------------|--|--|-----|--------------|--------------|---------------|---------------|-----|
|                | Models with O.E.M. Number                                      | 659223<br>680672<br>W0011635<br>W0011636   | 0 0 | ...          | ...          | 0 0           | <b>G63866</b> | ... |
|                |  |  |     | ...          | ...          | 0 0           | <b>85919</b>  | ... |
|                |  |  |     | <b>83221</b> | ...          | ...           | ...           | ... |
|                |  |  |     | ...          | ...          | 0 0           | <b>G63366</b> | ... |
|                | Models with RSAS Rear Suspension                               | 7805-X-1012  |     | ...          | ...          | 0 0           | <b>85919</b>  | ... |
|                | Step Van Models with O.E.M. Number                             | 659222<br>W0007363<br>W0007365   | 0 0 | <b>83171</b> | ...          | ...           | ...           | ... |
|                |  |  | 0 0 | <b>83171</b> | ...          | ...           | ...           | ... |
|                |  |  | ... | ...          | 0 0          | <b>G63866</b> | ...           |     |
| <b>06 - 11</b> | Step Van Models with W42 Chassis                               | W8007000   | 0 0 | <b>83171</b> | ...          | ...           | ...           | ... |
|                | UFO Motorhome Chassis with Hendrickson Softek Front Suspension | 66153-002<br>F4-BE5-C832-MO  | 0 0 | <b>83124</b> | <b>89407</b> | ...           | ...           | ... |
|                |  |  | 0 0 | <b>83124</b> | <b>89407</b> | ...           | ...           | ... |
| <b>06 - 09</b> | W16 & W18 MotorHome Chassis with O.E.M. Number                 | F4-BE5-F324-HO<br>W0005662   | 0 0 | <b>85125</b> | ...          | ...           | ...           | ... |
|                | W20 , W22, & W24 MotorHome Chassis with O.E.M. Number          | 24-153256<br>F4-BE5-F325-HO<br>W0005663  | ... | ...          | ...          | - -           | <b>85124</b>  | ... |
|                |  |  | ... | ...          | ...          | - -           | <b>85124</b>  | ... |
|                |  |  | ... | ...          | ...          | - -           | <b>85124</b>  | ... |
| <b>98 - 04</b> | W20 , W22, & W24 MotorHome Chassis with O.E.M. Number          | 24-186537<br>F4-BE5-A011-HO  | ... | ...          | ...          | 0 -           | <b>85126</b>  | ... |
|                |  |  | ... | ...          | ...          | 0 -           | <b>85126</b>  | ... |
| <b>98 - 14</b> | W20 , W22, & W24 MotorHome Chassis with O.E.M. Number          | 24-153249<br>24-186629<br>F4-BE5-A832-MO<br>F4-BE5-B492-HO<br>F4-BE5-F324-HO<br>W0005662<br>W0006254 | 0 0 | <b>85125</b> | ...          | ...           | ...           | ... |
|                |  |  | 0 0 | <b>85125</b> | ...          | ...           | ...           | ... |
|                |  |  | 0 0 | <b>85125</b> | ...          | ...           | ...           | ... |
|                |  |  | 0 0 | <b>85125</b> | ...          | ...           | ...           | ... |
|                |  |  | 0 0 | <b>85125</b> | ...          | ...           | ...           | ... |
|                |  |  | 0 0 | <b>85125</b> | ...          | ...           | ...           | ... |
|                |  |  | 0 0 | <b>85125</b> | ...          | ...           | ...           | ... |

### WORLD TRANS BUS CO.

|  |  |                      |     |              |     |     |              |     |
|--|--|----------------------|-----|--------------|-----|-----|--------------|-----|
|  | E & G Series Commercial buses on Ford E350 or E450 Chassis | ASH-1136<br>ASH-1154 |     | ...          | ... | - 0 | <b>83178</b> | ... |
|  |  |                      | - 0 | <b>83177</b> | ... | ... | ...          | ... |

# NUMERICAL LISTING LISTA NUMÉRICA LISTE NUMÉRIQUE

| GABRIEL#                               | APPLICATION   | MTG ACC<br>PKG NO | GABRIEL# | APPLICATION   | MTG ACC<br>PKG NO | GABRIEL#                      | APPLICATION  | MTG ACC<br>PKG NO     |
|--|---|-------------------|----------|---|-------------------|-------------------------------|--|-----------------------|
| <b>Shocks for Special Applications</b> |   |                   | G63398   | W<br>FORD<br>MITSUBISHI-FUSO  | 141138            | G63773                        | W<br>FORD  | Not Req'd.            |
| 83176                                  | X<br>VARIOUS  | Not Req'd.        | G63403   | W<br>FREIGHTLINER<br>VOLVO  | Not Req'd.        | G63775                        | W<br>FORD  | Not Req'd.            |
| 632147                                 | W<br>CHALLENGE<br>LINK/HIGH-STEER<br>MC NEILUS TRUCK & MAN.<br>WATSON & CHALIN MFG. INC.  | Not Req'd.        | G63405   | W<br>MITSUBISHI-FUSO  | 140884            | G63778                        | W<br>FORD  | 142700                |
| 646155                                 | A<br>ADVANCE MIXER<br>GRANNING SUSPENSION<br>HENDRICKSON TRAILER SUSPENSION SYSTEMS<br>HENDRICKSON TRUCK SUSPENSION SYSTEMS<br>KIMBLE MIXER CO<br>LINK/HIGH-STEER<br>LONDON MIXER<br>MC NEILUS TRUCK & MAN.<br>REX MIXER<br>RIDEWELL CORPORATION<br>SAF HOLLAND<br>SUSPENSIONS INC.<br>TEREX CORPORATION<br>TUTHILL TECHNOLOGIES<br>WATSON & CHALIN MFG. INC. | Not Req'd.        | G63406   | W<br>FORD   | Not Req'd.        | G63808                        | W<br>FORD  | Not Req'd.            |
| 646177                                 | A<br>CHALLENGE<br>LINK/HIGH-STEER<br>OSHKOSH MOTORS<br>PIERCE MANUFACTURING INC.<br>SAF HOLLAND<br>SPRING VALLEY<br>WESTPORT AXLE CORP  | Not Req'd.        | G63409   | W<br>FORD   | Not Req'd.        | G63809                        | W<br>FORD<br>STERLING TRUCK  | Not Req'd.            |
| 665472                                 | W<br>INGERSALL MACHINE  | Not Req'd.        | G63414   | W<br>FORD   | 140780            | G63810                        | W<br>FORD  | Not Req'd.            |
| 665937                                 | C<br>LINK/HIGH-STEER<br>REYCO SUSPENSION<br>RIDEWELL CORPORATION  | Not Req'd.        | G63419   | W<br>HINO   | Not Req'd.        | G63811                        | W<br>FORD  | Not Req'd.            |
| <b>Gas Light Truck Applications</b>    |   |                   | G63432   | W<br>INTERNATIONAL (NAVISTAR)<br>NISSAN                                   | 141349 & 140169   | G63837                        | W<br>FORD  | Not Req'd.            |
| G63183                                 | W<br>CHRYSLER<br>DODGE TRUCK<br>FREIGHTLINER<br>HOLIDAY RAMBLER<br>JOHN DEERE<br>MOR-RYDE SUSPENSION<br>OSHKOSH MOTORS<br>VOLVO   | Not Req'd.        | G63440   | W<br>HINO   | Not Req'd.        | G63866                        | W<br>MOR-RYDE SUSPENSION<br>WORKHORSE  | Not Req'd.            |
| G63299                                 | W<br>FORD<br>INTERNATIONAL (NAVISTAR)<br>MITSUBISHI-FUSO  | 140885(1)         | G63455   | W<br>FORD   | Not Req'd.        | G63929                        | W<br>FORD  | 140780                |
| G63306                                 | W<br>FORD<br>INTERNATIONAL (NAVISTAR)   | Not Req'd.        | G63461   | W<br>FORD   | Not Req'd.        | G63969                        | W<br>FORD  | 143146                |
| G63347                                 | W<br>CHEVROLET TRUCK (Also See GMC Truck)<br>GMC TRUCK  | Not Req'd.        | G63484   | W<br>VOLVO  | 140524            | <b>Fleetline Applications</b> |  |                       |
| G63350                                 | W<br>FORD   | 140126            | G63500   | W<br>FORD   | 140780            | 83001                         | B<br>FREIGHTLINER CAB SHOCKS   | 404702(1)             |
| G63355                                 | W<br>CHALMERS SUSPENSION  | 140702            | G63511   | W<br>FORD   | 141353            | 83002                         | C<br>KENWORTH CAB SHOCKS<br>LINK MANUFACTURING CAB SHOCKS  | Not Req'd.            |
| G63357                                 | W<br>WATSON & CHALIN MFG. INC.  | Not Req'd.        | G63524   | W<br>FORD   | Not Req'd.        | 83003                         | X<br>MACK CAB SHOCKS   | 140455(1)             |
| G63366                                 | W<br>WORKHORSE  | Not Req'd.        | G63525   | W<br>FORD   | Not Req'd.        | 83004                         | W<br>VOLVO CAB SHOCKS  | Not Req'd.            |
| G63386                                 | W<br>FORD<br>STERLING TRUCK   | 140780            | G63605   | W<br>DODGE TRUCK<br>FREIGHTLINER<br>JOHN DEERE<br>OSHKOSH MOTORS<br>VOLVO | 140169            | 83005                         | X<br>INTERNATIONAL (NAVISTAR) CAB SHOCKS<br>LINK MANUFACTURING CAB SHOCKS  | 140455(1)             |
| G63387                                 | W<br>FORD<br>STERLING TRUCK   | 140126            | G63607   | W<br>FORD   | 140719            | 83006                         | W<br>FREIGHTLINER CAB SHOCKS   | 404702(1)             |
| G63396                                 | W<br>FORD   | 140780            | G63608   | W<br>FORD   | 140780            | 83007                         | W<br>MACK CAB SHOCKS   | 404702(2) & 140702(1) |
|  |   |                   | G63610   | W<br>HINO<br>INTERNATIONAL (NAVISTAR)<br>MITSUBISHI-FUSO<br>NISSAN        | 142389            | 83008                         | A<br>KENWORTH<br>PETERBILT CAB SHOCKS  | Not Req'd.            |
|  |   |                   | G63614   | W<br>FORD   | 140780            | 83009                         | B<br>FREIGHTLINER CAB SHOCKS<br>MC NEILUS TRUCK & MAN.<br>OSHKOSH MOTORS CAB SHOCKS<br>VOLVO CAB SHOCKS  | Not Req'd.            |
|  |   |                   | G63622   | W<br>FORD   | 142617            | 83010                         | W<br>WESTERN STAR CAB SHOCKS   | Not Req'd.            |
|  |   |                   | G63623   | W<br>FORD   | 142617            | 83011                         | D<br>KENWORTH CAB SHOCKS<br>PETERBILT CAB SHOCKS   | 404702(2)             |
|  |   |                   | G63624   | W<br>FORD   | 140780            | 83012                         | W<br>KENWORTH CAB SHOCKS<br>PETERBILT CAB SHOCKS   | 404702(2)             |
|  |   |                   | G63625   | W<br>VOLVO  | 140702            | 83013                         | X<br>INTERNATIONAL (NAVISTAR) CAB SHOCKS<br>LINK MANUFACTURING CAB SHOCKS  | Not Req'd.            |
|  |   |                   | G63676   | W<br>FORD   | Not Req'd.        | 83015                         | W<br>INTERNATIONAL (NAVISTAR) CAB SHOCKS   | 140455(1)             |
|  |   |                   | G63678   | W<br>FORD   | Not Req'd.        | 83016                         | W<br>CHEVROLET TRUCK CAB SHOCKS<br>FORD CAB SHOCKS<br>FREIGHTLINER CAB SHOCKS<br>GMC TRUCK CAB SHOCKS<br>INTERNATIONAL (NAVISTAR) CAB SHOCKS<br>KENWORTH CAB SHOCKS<br>LINK MANUFACTURING CAB SHOCKS<br>MACK CAB SHOCKS<br>PETERBILT CAB SHOCKS<br>VOLVO CAB SHOCKS<br>WESTERN STAR CAB SHOCKS | Not Req'd.            |
|  |   |                   | G63679   | W<br>FORD   | 140719            |                               |  |                       |
|  |   |                   | G63714   | W<br>FORD   | 142731            |                               |  |                       |
|  |   |                   | G63716   | W<br>FORD   | 142731            |                               |  |                       |
|  |   |                   | G63772   | W<br>FORD   | 141665            |                               |  |                       |

X = Discontinued once inventory is gone

# NUMERICAL LISTING LISTA NUMÉRICA LISTE NUMÉRIQUE

| GABRIEL# | APPLICATION  | MTG ACC<br>PKG NO | GABRIEL# | APPLICATION   | MTG ACC<br>PKG NO | GABRIEL# | APPLICATION   | MTG ACC<br>PKG NO |
|----------|--|-------------------|----------|---|-------------------|----------|---|-------------------|
| 83017    | D<br>FREIGHTLINER CAB SHOCKS   | Not Req'd.        | 83039    | W<br>FREIGHTLINER CAB SHOCKS  | Not Req'd.        | 83100    | X<br>INTERNATIONAL (NAVISTAR)<br>VOLVO  | Not Req'd.        |
| 83018    | W<br>MACK CAB SHOCKS   | 140780(1)         | 83040    | W<br>FREIGHTLINER CAB SHOCKS  | Not Req'd.        | 83101    | W<br>IC CORPORATION<br>INTERNATIONAL (NAVISTAR)<br>MACK<br>VOLVO  | Not Req'd.        |
| 83019    | W<br>MACK CAB SHOCKS<br>VOLVO  | 140780(1)         | 83041    | D<br>MACK CAB SHOCKS<br>VOLVO   | 140780(1)         | 83102    | W<br>THOMAS SCHOOL BUS  | 145089-000(2)     |
| 83020    | W<br>FREIGHTLINER CAB SHOCKS   | Not Req'd.        | 83042    | D<br>KENWORTH CAB SHOCKS<br>PETERBILT CAB SHOCKS                                  | Not Req'd.        | 83103    | W<br>INTERNATIONAL (NAVISTAR)<br>MITSUBISHI-FUSO<br>MOR-RYDE SUSPENSION<br>VOLVO  | 145054(2)         |
| 83021    | C<br>CHEVROLET TRUCK CAB SHOCKS<br>CNH GLOBAL N V<br>FREIGHTLINER CAB SHOCKS<br>GMC TRUCK CAB SHOCKS<br>INTERNATIONAL (NAVISTAR) CAB SHOCKS<br>KENWORTH CAB SHOCKS<br>LINK MANUFACTURING CAB SHOCKS<br>MARMON CAB SHOCKS<br>OSHKOSH MOTORS CAB SHOCKS<br>PETERBILT CAB SHOCKS                  | Not Req'd.        | 83044    | W<br>FREIGHTLINER CAB SHOCKS  | Not Req'd.        | 83104    | W<br>HINO<br>VOLVO  | Not Req'd.        |
| 83022    | W<br>CNH GLOBAL N V<br>WESTERN STAR CAB SHOCKS   | Not Req'd.        | 83045    | W<br>MACK CAB SHOCKS<br>VOLVO   | 140780(1)         | 83105    | W<br>MACK<br>VOLVO  | 140780(1)         |
| 83023    | W<br>CHEVROLET TRUCK CAB SHOCKS<br>FORD CAB SHOCKS<br>FREIGHTLINER CAB SHOCKS<br>GMC TRUCK CAB SHOCKS<br>INTERNATIONAL (NAVISTAR) CAB SHOCKS<br>KENWORTH CAB SHOCKS<br>LINK MANUFACTURING CAB SHOCKS<br>MACK CAB SHOCKS<br>PETERBILT CAB SHOCKS<br>VOLVO CAB SHOCKS<br>WESTERN STAR CAB SHOCKS | Not Req'd.        | 83047    | D<br>FREIGHTLINER CAB SHOCKS  | 404702(1)         | 83107    | W<br>FORD<br>MAECO<br>STERLING TRUCK  | 145080(2)         |
| 83024    | D<br>KENWORTH CAB SHOCKS<br>LINK MANUFACTURING CAB SHOCKS<br>PETERBILT CAB SHOCKS  | Not Req'd.        | 83048    | C<br>VOLVO<br>VOLVO CAB SHOCKS  | Not Req'd.        | 83109    | W<br>FORD<br>HENDRICKSON TRUCK SUSPENSION SYSTEMS<br>MC NEILUS TRUCK & MAN.<br>STERLING TRUCK   | 145128(1)         |
| 83025    | C<br>FORD CAB SHOCKS<br>FREIGHTLINER CAB SHOCKS<br>GMC TRUCK CAB SHOCKS<br>INTERNATIONAL (NAVISTAR) CAB SHOCKS<br>KENWORTH CAB SHOCKS<br>LINK MANUFACTURING CAB SHOCKS<br>PETERBILT CAB SHOCKS<br>STERLING TRUCK CAB SHOCKS  | Not Req'd.        | 83049    | D<br>KENWORTH CAB SHOCKS<br>LINK MANUFACTURING CAB SHOCKS<br>PETERBILT CAB SHOCKS | Not Req'd.        | 83110    | D<br>HENDRICKSON TRUCK SUSPENSION SYSTEMS<br>MACK<br>VOLVO  | 145128(1)         |
| 83026    | W<br>FREIGHTLINER CAB SHOCKS<br>WESTERN STAR CAB SHOCKS  | Not Req'd.        | 83050    | W<br>MACK CAB SHOCKS<br>VOLVO CAB SHOCKS  | 140780(1)         | 83111    | D<br>HENDRICKSON TRUCK SUSPENSION SYSTEMS<br>MACK<br>VOLVO<br>WESTERN STAR  | 145128(1)         |
| 83027    | D<br>FREIGHTLINER CAB SHOCKS<br>WESTERN STAR CAB SHOCKS  | 140126(1)         | 83051    | C<br>INTERNATIONAL (NAVISTAR) CAB SHOCKS<br>LINK MANUFACTURING CAB SHOCKS         | Not Req'd.        | 83112    | C<br>ADVANCE MIXER<br>AUTOCAR<br>HENDRICKSON TRUCK SUSPENSION SYSTEMS<br>INTERNATIONAL (NAVISTAR)<br>MACK<br>MC NEILUS TRUCK & MAN.<br>PETERBILT<br>VOLVO<br>WESTERN STAR | 145128(1)         |
| 83028    | C<br>VOLVO CAB SHOCKS  | Not Req'd.        | 83052    | X<br>INTERNATIONAL (NAVISTAR) CAB SHOCKS<br>LINK MANUFACTURING CAB SHOCKS         | Not Req'd.        | 83113    | W<br>SAF HOLLAND<br>STOUGHTON TRAILERS INC.<br>TRAILMOBILE CANADA CORP.<br>WABASH NATIONAL  | Not Req'd.        |
| 83029    | C<br>VOLVO CAB SHOCKS  | Not Req'd.        | 83053    | W<br>INTERNATIONAL (NAVISTAR) CAB SHOCKS<br>LINK MANUFACTURING CAB SHOCKS         | Not Req'd.        | 83114    | W<br>CHEVROLET TRUCK (Also See GMC Truck)<br>GMC TRUCK<br>INTERNATIONAL (NAVISTAR)<br>ISUZU<br>NISSAN   | 140780(1)         |
| 83030    | W<br>VOLVO CAB SHOCKS  | Not Req'd.        | 83054    | W<br>INTERNATIONAL (NAVISTAR) CAB SHOCKS<br>LINK MANUFACTURING CAB SHOCKS         | Not Req'd.        | 83115    | X<br>SAF HOLLAND<br>TRAILMOBILE CANADA CORP.  | Not Req'd.        |
| 83031    | C<br>KENWORTH CAB SHOCKS<br>LINK MANUFACTURING CAB SHOCKS  | Not Req'd.        | 83055    | W<br>KENWORTH CAB SHOCKS<br>LINK MANUFACTURING CAB SHOCKS                         | Not Req'd.        | 83116    | W<br>FREIGHTLINER CUSTOM CHASSIS  | Not Req'd.        |
| 83032    | S<br>FREIGHTLINER CAB SHOCKS<br>INTERNATIONAL (NAVISTAR) CAB SHOCKS<br>KENWORTH CAB SHOCKS<br>LINK MANUFACTURING CAB SHOCKS  | Not Req'd.        | 83056    | X<br>KENWORTH CAB SHOCKS<br>PETERBILT CAB SHOCKS<br>POWERPACKER CAB SHOCKS        | Not Req'd.        | 83117    | W<br>FREIGHTLINER<br>FREIGHTLINER CUSTOM CHASSIS<br>OSHKOSH MOTORS  | 404702(1)         |
| 83033    | W<br>FORD CAB SHOCKS<br>FREIGHTLINER CAB SHOCKS<br>STERLING TRUCK CAB SHOCKS   | Not Req'd.        | 83057    | X<br>FREIGHTLINER CAB SHOCKS<br>STERLING TRUCK CAB SHOCKS                         | Not Req'd.        | 83118    | W<br>FREIGHTLINER<br>FREIGHTLINER CUSTOM CHASSIS<br>MAECO<br>OSHKOSH MOTORS<br>UPS TRUCK  | Not Req'd.        |
| 83034    | W<br>FORD CAB SHOCKS<br>FREIGHTLINER CAB SHOCKS<br>STERLING TRUCK CAB SHOCKS   | Not Req'd.        | 83058    | X<br>MACK CAB SHOCKS  | 140780(1)         | 83119    | W<br>FREIGHTLINER CUSTOM CHASSIS<br>OSHKOSH MOTORS  | Not Req'd.        |
| 83035    | C<br>KENWORTH<br>PETERBILT CAB SHOCKS  | Not Req'd.        | 83059    | W<br>KENWORTH CAB SHOCKS<br>PETERBILT CAB SHOCKS<br>POWERPACKER CAB SHOCKS        | Not Req'd.        | 83120    | W<br>145089-000(1) &<br>145143(1)<br>FREIGHTLINER<br>FREIGHTLINER CUSTOM CHASSIS<br>MAECO<br>OSHKOSH MOTORS   |                   |
| 83038    | A<br>FREIGHTLINER CAB SHOCKS   | 404702(1)         | 83060    | X<br>PETERBILT CAB SHOCKS<br>POWERPACKER CAB SHOCKS                               | Not Req'd.        |          |   |                   |
|          |  |                   | 83061    | X<br>LINK MANUFACTURING CAB SHOCKS<br>PETERBILT CAB SHOCKS                        | Not Req'd.        |          |   |                   |
|          |  |                   | 83062    | W<br>INTERNATIONAL (NAVISTAR) CAB SHOCKS<br>LINK MANUFACTURING CAB SHOCKS         | 145128(1)         |          |   |                   |
|          |  |                   | 83063    | N<br>KENWORTH<br>PETERBILT CAB SHOCKS   | Not Req'd.        |          |   |                   |
|          |  |                   | 83064    | N<br>ARVIN MERITOR<br>FREIGHTLINER CAB SHOCKS                                     | Not Req'd.        |          |   |                   |
|          |  |                   | 83065    | N<br>WESTERN STAR CAB SHOCKS  | Not Req'd.        |          |   |                   |
|          |  |                   | 83066    | N<br>MACK CAB SHOCKS  | Not Req'd.        |          |   |                   |
|          |  |                   | 83067    | N<br>KENWORTH CAB SHOCKS<br>PETERBILT CAB SHOCKS                                  | Not Req'd.        |          |   |                   |
|          |  |                   | 83081    | N<br>KENWORTH CAB SHOCKS<br>PETERBILT CAB SHOCKS                                  | Not Req'd.        |          |   |                   |

N = New, S = Superseded, X = Discontinued once inventory is gone



# NUMERICAL LISTING LISTA NUMÉRICA LISTE NUMÉRIQUE

| GABRIEL# | APPLICATION   | MTG ACC<br>PKG NO            | GABRIEL# | APPLICATION   | MTG ACC<br>PKG NO            | GABRIEL# | APPLICATION  | MTG ACC<br>PKG NO |
|----------|---|------------------------------|----------|---|------------------------------|----------|--|-------------------|
| 83120    | W   | 145089-000(1) &<br>145143(1) | 83125    | B   | Not Req'd.                   | 83142    | W  | 145128(1)         |
|          | STERLING TRUCK<br>THOMAS SCHOOL BUS<br>UPS TRUCK<br>VOLVO   |                              |          | WABASH NATIONAL<br>WATSON & CHALIN MFG. INC.  |                              |          | AUTOCAR<br>CATERPILLAR<br>FREIGHTLINER<br>HENDRICKSON TRUCK SUSPENSION SYSTEMS<br>INTERNATIONAL (NAVISTAR)<br>KENWORTH<br>MACK<br>MC NEILUS TRUCK & MAN.<br>PETERBILT<br>WESTERN STAR  |                   |
| 83122    | D   | Not Req'd.                   | 83126    | D   | Not Req'd.                   | 83143    | D  | 145128(1)         |
|          | ALLCO TRAILER<br>AUTOCAR<br>CHEVROLET TRUCK (Also See GMC Truck)<br>COACHMEN RV<br>DAMON MOTOR COACH<br>ENTEGRAS COACH<br>FLEETWOOD RV<br>FORD<br>FOREST RIVER INC<br>FREIGHTLINER<br>FRUEHAUF<br>GEORGIE BOY MANUFACTURING<br>GILLIG BROS.<br>GMC TRUCK<br>GREAT DANE TRAILER<br>HENDRICKSON TRUCK SUSPENSION SYSTEMS<br>HOLIDAY RAMBLER<br>ISUZU<br>ITASCA<br>JAYCO RV INC<br>KENWORTH<br>LODAL, INC.<br>MACK<br>MAECO<br>MARMON<br>MC NEILUS TRUCK & MAN.<br>MONACO<br>NATIONAL RV INC.<br>NEWMAR CORP<br>NEXUS RV<br>OSHKOSH MOTORS<br>PETERBILT<br>REYCO SUSPENSION<br>SAF HOLLAND<br>THOR MOTOR COACH<br>TUTHILL TECHNOLOGIES<br>VOLVO<br>WESTERN STAR<br>WINNEBAGO |                              |          | CHEVROLET TRUCK (Also See GMC Truck)<br>GMC TRUCK<br>HINO<br>INTERNATIONAL (NAVISTAR)<br>KENWORTH<br>MAECO<br>PETERBILT<br>REYCO SUSPENSION<br>SAF HOLLAND<br>TUTHILL TECHNOLOGIES<br>VOLVO<br>WABASH NATIONAL<br>WESTERN STAR  |                              |          | AUTOCAR<br>CATERPILLAR<br>CRANE CARRIER<br>FREIGHTLINER<br>HENDRICKSON TRUCK SUSPENSION SYSTEMS<br>INTERNATIONAL (NAVISTAR)<br>KENWORTH<br>MACK<br>MC NEILUS TRUCK & MAN.<br>PETERBILT<br>WESTERN STAR                           |                   |
| 83123    | C   | Not Req'd.                   | 83127    | C   | Not Req'd.                   | 83144    | W  | Not Req'd.        |
|          | FORD<br>GILLIG BROS.<br>HENDRICKSON TRUCK SUSPENSION SYSTEMS<br>IC CORPORATION<br>INTERNATIONAL (NAVISTAR)<br>KENWORTH<br>MACK<br>MAECO<br>MARMON<br>MC NEILUS TRUCK & MAN.<br>PETERBILT<br>REYCO SUSPENSION<br>SAF HOLLAND<br>TUTHILL TECHNOLOGIES<br>VOLVO<br>WATSON & CHALIN MFG. INC.   |                              |          | BLUEBIRD SCHOOL BUS<br>FREIGHTLINER<br>FREIGHTLINER CUSTOM CHASSIS<br>HOLIDAY RAMBLER<br>MC NEILUS TRUCK & MAN.<br>OSHKOSH MOTORS<br>SAF HOLLAND<br>TRAILMOBILE CANADA CORP.<br>VOLVO<br>WABASH NATIONAL  |                              |          | HENDRICKSON TRUCK SUSPENSION SYSTEMS<br>INTERNATIONAL (NAVISTAR)   |                   |
| 83124    | C   | Not Req'd.                   | 83128    | A   | Not Req'd.                   | 83145    | X  | Not Req'd.        |
|          | BENSON TRUCK BODIES INC.<br>BLUEBIRD SCHOOL BUS<br>COACHMEN RV<br>EAST MANUFACTURING CORP.<br>FOREST RIVER INC<br>GEORGIE BOY MANUFACTURING<br>ITASCA<br>KENWORTH<br>MONACO<br>PETERBILT<br>SAF HOLLAND<br>TRAILMOBILE CANADA CORP.<br>TWIN COACH<br>VOLVO<br>WABASH NATIONAL<br>WINNEBAGO<br>WORKHORSE   |                              |          | EAST MANUFACTURING CORP.<br>FREIGHTLINER<br>GREAT DANE TRAILER<br>HENDRICKSON TRAILER SUSPENSION SYSTEMS<br>MC NEILUS TRUCK & MAN.<br>REYCO SUSPENSION<br>SAF HOLLAND<br>STOUGHTON TRAILERS INC.<br>TWIN COACH<br>UTILITY TRAILER MANUFACTURING COMPANY<br>VOLVO<br>WABASH NATIONAL       |                              |          | FORD   |                   |
| 83125    | B   | Not Req'd.                   | 83130    | D   | Not Req'd.                   | 83146    | S  | Not Req'd.        |
|          | CASCADE TRAILER<br>EAST MANUFACTURING CORP.<br>FORD<br>GENERAL TRAILER CO<br>HENDRICKSON TRUCK SUSPENSION SYSTEMS<br>HOLLAND - BINKLEY<br>MACK<br>MAECO<br>PEERLESS TRAILER<br>SAF HOLLAND<br>STERLING TRUCK<br>THE BINKLEY COMPANY<br>TRAILMOBILE CANADA CORP.<br>VOLVO  |                              |          | RIDEWELL CORPORATION<br>SAF HOLLAND<br>VOLVO<br>WABASH NATIONAL   |                              |          | FORD<br>INTERNATIONAL (NAVISTAR)<br>STERLING TRUCK   |                   |
| 83126    | B   | Not Req'd.                   | 83131    | W   | Not Req'd.                   | 83147    | B  | Not Req'd.        |
|          | ASCADA TRAILER<br>EAST MANUFACTURING CORP.<br>FORD<br>GENERAL TRAILER CO<br>HENDRICKSON TRUCK SUSPENSION SYSTEMS<br>HOLLAND - BINKLEY<br>MACK<br>MAECO<br>PEERLESS TRAILER<br>SAF HOLLAND<br>STERLING TRUCK<br>THE BINKLEY COMPANY<br>TRAILMOBILE CANADA CORP.<br>VOLVO   |                              |          | FORD  |                              |          | HENDRICKSON TRUCK SUSPENSION SYSTEMS<br>MACK<br>MC NEILUS TRUCK & MAN.<br>THOMAS SCHOOL BUS  |                   |
| 83127    | B   | Not Req'd.                   | 83132    | W   | 145054(1)                    | 83148    | D  | Not Req'd.        |
|          | ASCADA TRAILER<br>EAST MANUFACTURING CORP.<br>FORD<br>GENERAL TRAILER CO<br>HENDRICKSON TRUCK SUSPENSION SYSTEMS<br>HOLLAND - BINKLEY<br>MACK<br>MAECO<br>PEERLESS TRAILER<br>SAF HOLLAND<br>STERLING TRUCK<br>THE BINKLEY COMPANY<br>TRAILMOBILE CANADA CORP.<br>VOLVO   |                              |          | FREIGHTLINER  |                              |          | HENDRICKSON TRUCK SUSPENSION SYSTEMS<br>HINO<br>MC NEILUS TRUCK & MAN.<br>VOLVO  |                   |
| 83128    | B   | Not Req'd.                   | 83133    | C   | Not Req'd.                   | 83149    | W  | Not Req'd.        |
|          | ASCADA TRAILER<br>EAST MANUFACTURING CORP.<br>FORD<br>GENERAL TRAILER CO<br>HENDRICKSON TRUCK SUSPENSION SYSTEMS<br>HOLLAND - BINKLEY<br>MACK<br>MAECO<br>PEERLESS TRAILER<br>SAF HOLLAND<br>STERLING TRUCK<br>THE BINKLEY COMPANY<br>TRAILMOBILE CANADA CORP.<br>VOLVO   |                              |          | FORD<br>IC CORPORATION<br>INTERNATIONAL (NAVISTAR)  |                              |          | HENDRICKSON TRUCK SUSPENSION SYSTEMS   |                   |
| 83129    | B   | Not Req'd.                   | 83134    | C   | 145054(2)                    | 83150    | W  | Not Req'd.        |
|          | ASCADA TRAILER<br>EAST MANUFACTURING CORP.<br>FORD<br>GENERAL TRAILER CO<br>HENDRICKSON TRUCK SUSPENSION SYSTEMS<br>HOLLAND - BINKLEY<br>MACK<br>MAECO<br>PEERLESS TRAILER<br>SAF HOLLAND<br>STERLING TRUCK<br>THE BINKLEY COMPANY<br>TRAILMOBILE CANADA CORP.<br>VOLVO   |                              |          | CHAMPION BUS INC<br>CHEVROLET TRUCK (Also See GMC Truck)<br>GMC TRUCK<br>GULF STREAM COACH<br>ISUZU<br>KENWORTH<br>PETERBILT<br>VOLVO   |                              |          | HENDRICKSON TRAILER SUSPENSION SYSTEMS<br>SAF HOLLAND  |                   |
| 83130    | B   | Not Req'd.                   | 83135    | D   | Not Req'd.                   | 83151    | W  | Not Req'd.        |
|          | ASCADA TRAILER<br>EAST MANUFACTURING CORP.<br>FORD<br>GENERAL TRAILER CO<br>HENDRICKSON TRUCK SUSPENSION SYSTEMS<br>HOLLAND - BINKLEY<br>MACK<br>MAECO<br>PEERLESS TRAILER<br>SAF HOLLAND<br>STERLING TRUCK<br>THE BINKLEY COMPANY<br>TRAILMOBILE CANADA CORP.<br>VOLVO   |                              |          | AUTOCAR<br>BERING TRUCK CORP.<br>BLUEBIRD SCHOOL BUS<br>CHEVROLET TRUCK (Also See GMC Truck)<br>GMC TRUCK<br>HENDRICKSON TRUCK SUSPENSION SYSTEMS<br>INTERNATIONAL (NAVISTAR)<br>ISUZU<br>KENWORTH<br>MACK<br>MC NEILUS TRUCK & MAN.<br>PETERBILT<br>SAF HOLLAND<br>VOLVO<br>WESTERN STAR |                              |          | CHEVROLET TRUCK (Also See GMC Truck)<br>GMC TRUCK  |                   |
| 83131    | B   | Not Req'd.                   | 83136    | W   | 145128(1)                    | 83152    | W  | 145089-000(1)     |
|          | ASCADA TRAILER<br>EAST MANUFACTURING CORP.<br>FORD<br>GENERAL TRAILER CO<br>HENDRICKSON TRUCK SUSPENSION SYSTEMS<br>HOLLAND - BINKLEY<br>MACK<br>MAECO<br>PEERLESS TRAILER<br>SAF HOLLAND<br>STERLING TRUCK<br>THE BINKLEY COMPANY<br>TRAILMOBILE CANADA CORP.<br>VOLVO   |                              |          | MACK  |                              |          | FREIGHTLINER CUSTOM CHASSIS  |                   |
| 83132    | B   | Not Req'd.                   | 83137    | W   | 415010-802(2) &<br>145148(2) | 83153    | X  | Not Req'd.        |
|          | ASCADA TRAILER<br>EAST MANUFACTURING CORP.<br>FORD<br>GENERAL TRAILER CO<br>HENDRICKSON TRUCK SUSPENSION SYSTEMS<br>HOLLAND - BINKLEY<br>MACK<br>MAECO<br>PEERLESS TRAILER<br>SAF HOLLAND<br>STERLING TRUCK<br>THE BINKLEY COMPANY<br>TRAILMOBILE CANADA CORP.<br>VOLVO   |                              |          | FORD<br>HINO  |                              |          | CHEVROLET TRUCK (Also See GMC Truck)<br>GMC TRUCK  |                   |
| 83133    | B   | Not Req'd.                   | 83138    | W   | 415010-802(2) &<br>145148(2) | 83154    | W  | TR0027(4)         |
|          | ASCADA TRAILER<br>EAST MANUFACTURING CORP.<br>FORD<br>GENERAL TRAILER CO<br>HENDRICKSON TRUCK SUSPENSION SYSTEMS<br>HOLLAND - BINKLEY<br>MACK<br>MAECO<br>PEERLESS TRAILER<br>SAF HOLLAND<br>STERLING TRUCK<br>THE BINKLEY COMPANY<br>TRAILMOBILE CANADA CORP.<br>VOLVO   |                              |          | MACK  |                              |          | GMC TRUCK<br>ISUZU   |                   |
| 83134    | B   | Not Req'd.                   | 83139    | W   | 140524(1) & 404702(1)        | 83155    | W  | Not Req'd.        |
|          | ASCADA TRAILER<br>EAST MANUFACTURING CORP.<br>FORD<br>GENERAL TRAILER CO<br>HENDRICKSON TRUCK SUSPENSION SYSTEMS<br>HOLLAND - BINKLEY<br>MACK<br>MAECO<br>PEERLESS TRAILER<br>SAF HOLLAND<br>STERLING TRUCK<br>THE BINKLEY COMPANY<br>TRAILMOBILE CANADA CORP.<br>VOLVO   |                              |          | HINO  |                              |          | COACHMEN RV<br>FLEETWOOD RV<br>FOREST RIVER INC<br>FREIGHTLINER CUSTOM CHASSIS<br>GULF STREAM COACH<br>HOLIDAY RAMBLER<br>ITASCA<br>KING OF THE ROAD<br>MANDALAY COACH<br>MONACO<br>NEWMAR CORP<br>THOR MOTOR COACH<br>WINNEBAGO |                   |
| 83135    | B   | Not Req'd.                   | 83140    | X   | Not Req'd.                   | 83156    | X  | Not Req'd.        |
|          | ASCADA TRAILER<br>EAST MANUFACTURING CORP.<br>FORD<br>GENERAL TRAILER CO<br>HENDRICKSON TRUCK SUSPENSION SYSTEMS<br>HOLLAND - BINKLEY<br>MACK<br>MAECO<br>PEERLESS TRAILER<br>SAF HOLLAND<br>STERLING TRUCK<br>THE BINKLEY COMPANY<br>TRAILMOBILE CANADA CORP.<br>VOLVO   |                              |          | FORD  |                              |          | GMC TRUCK<br>NISSAN  |                   |

S = Superseded, X = Discontinued once inventory is gone

# NUMERICAL LISTING LISTA NUMÉRICA LISTE NUMÉRIQUE

| GABRIEL# | APPLICATION   | MTG ACC<br>PKG NO | GABRIEL# | APPLICATION  | MTG ACC<br>PKG NO | GABRIEL# | APPLICATION   | MTG ACC<br>PKG NO |
|----------|---|-------------------|----------|--|-------------------|----------|---|-------------------|
| 83162    | W 140780(1) & 145116 & 406422 & 415010-802(1)   |                   | 83178    | N GLAVAL BUS CO.<br>GOSHEN COACH<br>GRECH MOTORS<br>GULF STREAM COACH<br>HOLIDAY RAMBLER<br>ITASCA<br>JAYCO RV INC<br>KRYSTAL BUS<br>LGE COACHWORKS<br>NEXUS RV<br>PHOENIX CRUISER RV<br>SHASTA RV<br>STARCRAFT BUS CO.<br>THOMAS SCHOOL BUS<br>THOR MOTOR COACH<br>TURTLETOP BUS<br>WHEELED COACH IND<br>WINNEBAGO<br>WORLD TRANS BUS CO.   | 142095(1)         | 83209    | D FLEETWOOD RV<br>FORD<br>FOREST RIVER INC<br>GEORGIE BOY MANUFACTURING<br>GMC TRUCK<br>HENDRICKSON TRAILER SUSPENSION SYSTEMS<br>HOLIDAY RAMBLER<br>INTERNATIONAL (NAVISTAR)<br>ITASCA<br>JAYCO RV INC<br>KENWORTH<br>MACK<br>MAECO<br>MC NEILUS TRUCK & MAN.<br>MONACO<br>NATIONAL RV INC.<br>NEWMAR CORP<br>NEXUS RV<br>PETERBILT<br>REYCO SUSPENSION<br>SAF HOLLAND<br>THOR MOTOR COACH<br>TRAILMOBILE CANADA CORP.<br>TUTHILL TECHNOLOGIES<br>VOLVO<br>WESTERN STAR<br>WINNEBAGO | Not Req'd.        |
| 83163    | W IC CORPORATION<br>INTERNATIONAL (NAVISTAR)  | Not Req'd.        | 83180    | N INTERNATIONAL (NAVISTAR)   | Not Req'd.        | 83214    | W ARVIN MERITOR<br>CHEVROLET TRUCK (Also See GMC Truck)<br>DIAMOND-REO<br>EAST MANUFACTURING CORP.<br>GMC TRUCK<br>GRANNING SUSPENSION<br>MAECO<br>OSTERLUND TRUCK<br>OTTAWA TRUCK<br>SPARTAN MOTORS<br>TUTHILL TECHNOLOGIES<br>VOLVO   | 401754(4)         |
| 83164    | W ARVIN MERITOR<br>FREIGHTLINER CUSTOM CHASSIS  | Not Req'd.        | 83200    | S ARVIN MERITOR<br>FORD<br>STERLING TRUCK  | 140149(1)         | 83215    | W ACF BRILL BUS<br>ARVIN MERITOR<br>BROCKWAY SCHOOL BUS<br>CHEVROLET TRUCK (Also See GMC Truck)<br>FORD<br>GMC TRUCK<br>HINO<br>INTERNATIONAL (NAVISTAR)<br>MACK<br>MAECO<br>PAI CORP<br>REYCO SUSPENSION<br>STERLING TRUCK<br>TUTHILL TECHNOLOGIES<br>VOLVO  | 401754(4)         |
| 83166    | W HENDRICKSON TRUCK SUSPENSION SYSTEMS<br>HINO  | Not Req'd.        | 83203    | B CHANCE COACH<br>CHEVROLET TRUCK (Also See GMC Truck)<br>DURA SUSPENSION<br>FRUEHAUF<br>GMC TRUCK<br>HIGHWAY PRODUCT<br>HUTCHENS SUSPENSION<br>MACK<br>MAECO<br>MOHAWK<br>ORION BUS INDUSTRIES<br>PAGE SUSPENSION<br>PETERBILT<br>REYCO SUSPENSION<br>RIDEWELL CORPORATION<br>SAF HOLLAND<br>TUTHILL TECHNOLOGIES<br>VOLVO<br>WABASH NATIONAL<br>WATSON & CHALIN MFG. INC.  | Not Req'd.        | 83216    | W ARVIN MERITOR<br>AUTOCAR<br>BROCKWAY SCHOOL BUS<br>CHEVROLET TRUCK (Also See GMC Truck)<br>FORD<br>GILLIG BROS.<br>GMC TRUCK<br>HINO<br>INTERNATIONAL (NAVISTAR)<br>MACK<br>MAECO<br>MARMON<br>MOHAWK<br>NEOPLAN BUS<br>ONEIDA PRODUCTS<br>STERLING TRUCK<br>VOLVO<br>WESTERN STAR  | 140149(1)         |
| 83167    | W INTERNATIONAL (NAVISTAR)  | Not Req'd.        | 83204    | W DUPLEX TRUCK<br>DURA SUSPENSION<br>MAECO<br>PAGE SUSPENSION<br>REYCO SUSPENSION<br>SAF HOLLAND<br>TRAILMOBILE CANADA CORP.<br>TUTHILL TECHNOLOGIES<br>VOLVO<br>WATSON & CHALIN MFG. INC.   | Not Req'd.        | 83217    | W CHEVROLET TRUCK (Also See GMC Truck)<br>DIAMOND-REO<br>EAST MANUFACTURING CORP.<br>FLXIBLE BUS<br>FORD<br>GMC TRUCK<br>HINO<br>HYSTER<br>MACK<br>MAECO<br>OLE GRANNING<br>OTTAWA TRUCK<br>REYCO SUSPENSION<br>SOUTHERN COACH<br>TUTHILL TECHNOLOGIES<br>VOLVO   | 401754(4)         |
| 83168    | W HENDRICKSON TRUCK SUSPENSION SYSTEMS<br>HINO<br>MC NEILUS TRUCK & MAN.  | Not Req'd.        | 83207    | C ADVANCE MIXER<br>ARVIN MERITOR<br>BLUEBIRD SCHOOL BUS<br>BROCKWAY SCHOOL BUS<br>CHANCE COACH<br>CHEVROLET TRUCK (Also See GMC Truck)<br>DURA SUSPENSION<br>FORD<br>GILLIG BROS.<br>GMC TRUCK<br>GREAT DANE TRAILER<br>HARDEE MFG<br>HENDRICKSON TRUCK SUSPENSION SYSTEMS<br>HIGHWAY PRODUCT<br>INTERNATIONAL (NAVISTAR)<br>MACK<br>MAECO<br>MC NEILUS TRUCK & MAN.<br>MOHAWK<br>NATIONAL COACH CORP<br>OSHKOSH MOTORS<br>REYCO SUSPENSION<br>RIDEWELL CORPORATION<br>SAF HOLLAND<br>TRAILMOBILE CANADA CORP.<br>TUTHILL TECHNOLOGIES<br>TWIN COACH<br>VOLVO<br>WABASH NATIONAL | Not Req'd.        | 83219    | W ARVIN MERITOR<br>CHEVROLET TRUCK (Also See GMC Truck)   | 140149(1)         |
| 83169    | W IC CORPORATION<br>INTERNATIONAL (NAVISTAR)  | Not Req'd.        | 83209    | D ADVANCE MIXER<br>ARVIN MERITOR<br>CHEVROLET TRUCK (Also See GMC Truck)<br>COACHMEN RV<br>DAMON MOTOR COACH<br>ENTEGRAL COACH   | Not Req'd.        |          |   |                   |
| 83171    | X ARVIN MERITOR<br>WORKHORSE  | Not Req'd.        |          |  |                   |          |   |                   |
| 83174    | X FREIGHTLINER CUSTOM CHASSIS   | Not Req'd.        |          |  |                   |          |   |                   |
| 83175    | N FORD<br>GLAVAL BUS CO.<br>INTERNATIONAL (NAVISTAR)<br>STARCRAFT BUS CO.   | Not Req'd.        |          |  |                   |          |   |                   |
| 83176    | X MAECO   | Not Req'd.        |          |  |                   |          |   |                   |
| 83177    | N 140780(1) & 404702(1)   |                   |          |  |                   |          |   |                   |
|          | BERKSHIRE COACH<br>BLUEBIRD SCHOOL BUS<br>CHAMPION BUS INC<br>COACH HOUSE RV<br>COACHMEN RV<br>COLLINS BUS CORP<br>DIAMOND COACH<br>DUTCHMEN RV<br>DYNAMAX CORP (COUNTRY COACH)<br>ELDORADO NATIONAL<br>ELKHART COACH<br>ENTEGRAL COACH<br>FEDERAL COACH<br>FLEETWOOD RV<br>FORD<br>FOREST RIVER INC<br>GEORGIE BOY MANUFACTURING<br>GLAVAL BUS CO.<br>GOSHEN COACH<br>GRECH MOTORS<br>GULF STREAM COACH<br>HOLIDAY RAMBLER<br>ITASCA<br>JAYCO RV INC<br>KRYSTAL BUS<br>LGE COACHWORKS<br>NEXUS RV<br>PHOENIX CRUISER RV<br>SHASTA RV<br>STARCRAFT BUS CO.<br>THOMAS SCHOOL BUS<br>THOR MOTOR COACH<br>TURTLETOP BUS<br>WHEELED COACH IND<br>WINNEBAGO<br>WORLD TRANS BUS CO. |                   |          |  |                   |          |   |                   |

N = New, S = Superseded, X = Discontinued once inventory is gone

# NUMERICAL LISTING LISTA NUMÉRICA LISTE NUMÉRIQUE

| GABRIEL# | APPLICATION  | MTG ACC<br>PKG NO | GABRIEL# | APPLICATION  | MTG ACC<br>PKG NO     | GABRIEL# | APPLICATION  | MTG ACC<br>PKG NO |
|----------|--|-------------------|----------|--|-----------------------|----------|--|-------------------|
| 83219    | W<br>FORD<br>GILLIG BROS.<br>GMC TRUCK<br>PETERBILT<br>VOLVO   | 140149(1)         | 83363    | N<br>SAF HOLLAND   | Not Req'd.            | 85001    | A<br>KENWORTH<br>MACK<br>MAECO<br>PETERBILT<br>REYCO SUSPENSION<br>STERLING TRUCK<br>TUTHILL TECHNOLOGIES<br>VOLVO   | 401754(4)         |
| 83221    | D<br>CHEVROLET TRUCK (Also See GMC Truck)<br>GMC TRUCK<br>MACK<br>MAECO<br>OSHKOSH MOTORS<br>PAI CORP<br>VOLVO<br>WORKHORSE  | Not Req'd.        | 83364    | N<br>INTERNATIONAL (NAVISTAR)  | Not Req'd.            | 85003    | A<br>ARVIN MERITOR<br>IC CORPORATION<br>INTERNATIONAL (NAVISTAR)<br>KENWORTH<br>MARMON<br>PETERBILT<br>VOLVO   | Not Req'd.        |
| 83225    | W<br>ACF BRILL BUS<br>ARVIN MERITOR<br>FORD<br>FREIGHTLINER<br>HENDRICKSON TRUCK SUSPENSION SYSTEMS<br>INTERNATIONAL (NAVISTAR)<br>MACK<br>MOHAWK<br>TRAILMOBILE CANADA CORP.<br>VOLVO | 401754(4)         | 83389    | N<br>SAF HOLLAND   | Not Req'd.            | 85004    | W<br>ARVIN MERITOR<br>PETERBILT<br>SAF HOLLAND   | 401754(4)         |
| 83242    | W<br>ARVIN MERITOR<br>MACK<br>VOLVO  | Not Req'd.        | 83391    | N<br>HINO  | 145177(2)             | 85005    | B<br>ARVIN MERITOR<br>AUTOCAR<br>BLUEBIRD SCHOOL BUS<br>BOYDSTUN EQUIPMENT MANUFACTURING<br>CHEVROLET TRUCK (Also See GMC Truck)<br>CUSH CORPORATION<br>EAST MANUFACTURING CORP.<br>FREIGHTLINER<br>FREIGHTLINER CUSTOM CHASSIS<br>GMC TRUCK<br>HENDRICKSON TRAILER SUSPENSION SYSTEMS<br>HENDRICKSON TRUCK SUSPENSION SYSTEMS<br>INTERNATIONAL (NAVISTAR)<br>MACK<br>MAECO<br>REYCO SUSPENSION<br>RIDEWELL CORPORATION<br>SAF HOLLAND<br>TUTHILL TECHNOLOGIES<br>VOLVO<br>WATSON & CHALIN MFG. INC. | Not Req'd.        |
| 83301    | W<br>ARVIN MERITOR<br>INTERNATIONAL (NAVISTAR)<br>VOLVO  | 141083(1)         | 83395    | N<br>INTERNATIONAL (NAVISTAR)  | 145054(1)             | 85006    | A<br>ARVIN MERITOR<br>BLUEBIRD SCHOOL BUS<br>BUILT RITE<br>DEXTER AXLE<br>FORD<br>FREIGHTLINER<br>FREIGHTLINER CUSTOM CHASSIS<br>GREAT DANE TRAILER<br>HENDRICKSON TRAILER SUSPENSION SYSTEMS<br>HENDRICKSON TRUCK SUSPENSION SYSTEMS<br>MAECO<br>RAMERIZ TRAILER<br>REYCO SUSPENSION<br>RIDEWELL CORPORATION<br>SAF HOLLAND<br>STERLING TRUCK<br>STOUGHTON TRAILERS INC.<br>THE BINKLEY COMPANY<br>THOMAS SCHOOL BUS<br>TRAILMOBILE CANADA CORP.<br>TUTHILL TECHNOLOGIES<br>VOLVO<br>WESTERN STAR   | Not Req'd.        |
| 83303    | W<br>ARVIN MERITOR<br>CHEVROLET TRUCK (Also See GMC Truck)<br>GMC TRUCK<br>VOLVO   | 140702(1)         | 83400    | W<br>CHEVROLET TRUCK (Also See GMC Truck)<br>FORD<br>GMC TRUCK<br>MOR-RYDE SUSPENSION<br>VOLVO<br>WATSON & CHALIN MFG. INC.<br>WESTERN STAR  | 140455(2)             | 85007    | W<br>ARVIN MERITOR<br>FREIGHTLINER<br>KENWORTH<br>MACK<br>MAECO<br>PETERBILT<br>REYCO SUSPENSION<br>SPARTAN MOTORS<br>TUTHILL TECHNOLOGIES<br>VOLVO  | 401754(4)         |
| 83304    | W<br>ARVIN MERITOR<br>CHEVROLET TRUCK (Also See GMC Truck)<br>GMC TRUCK<br>VOLVO   | 140702(1)         | 83401    | W<br>CHEVROLET TRUCK (Also See GMC Truck)<br>GMC TRUCK<br>VOLVO<br>WESTERN STAR  | 404702(2)             | 85009    | W<br>ARVIN MERITOR<br>FREIGHTLINER<br>MITSUBISHI-FUSO<br>NEOPLAN BUS<br>WATSON & CHALIN MFG. INC.  | 145054(1)         |
| 83308    | W<br>ARVIN MERITOR<br>CHEVROLET TRUCK (Also See GMC Truck)<br>FORD<br>GMC TRUCK<br>INTERNATIONAL (NAVISTAR)<br>STERLING TRUCK<br>VOLVO   | 140149(1)         | 83404    | S<br>GMC TRUCK<br>ISUZU  | 401011(4)             | 85011    | X<br>ARVIN MERITOR<br>FREIGHTLINER   | Not Req'd.        |
| 83309    | W<br>ARVIN MERITOR<br>FORD<br>INTERNATIONAL (NAVISTAR)<br>STERLING TRUCK<br>VOLVO  | 140149(1)         | 83456    | C<br>IC CORPORATION<br>INTERNATIONAL (NAVISTAR)<br>MITSUBISHI-FUSO<br>VOLVO  | 142998(2)             |          |  |                   |
| 83312    | W<br>ARVIN MERITOR<br>FORD<br>KENWORTH<br>OSHKOSH MOTORS<br>PETERBILT<br>PIERCE MANUFACTURING INC.<br>VOLVO  | 140149(1)         | 83515    | N<br>CHEVROLET TRUCK (Also See GMC Truck)<br>GMC TRUCK<br>ISUZU<br>NISSAN<br>VOLVO   | 141041(1) & TR0027(2) |          |  |                   |
| 83314    | W<br>ARVIN MERITOR<br>FORD<br>GMC TRUCK<br>INTERNATIONAL (NAVISTAR)<br>MAECO<br>STERLING TRUCK<br>VOLVO  | 140149(1)         | 83518    | N<br>HINO  | 141041(1) & TR0027(2) |          |  |                   |
| 83317    | W<br>DINA BUS<br>FORD<br>GLAVAL BUS CO.<br>IC CORPORATION<br>INTERNATIONAL (NAVISTAR)<br>STARCRAFT BUS CO.<br>VOLVO  | 141083(1)         | 83519    | N<br>HINO  | TR0027(4)             |          |  |                   |
| 83318    | W<br>ARVIN MERITOR<br>INTERNATIONAL (NAVISTAR)<br>VOLVO  | 141083(2)         | 83613    | W<br>ARVIN MERITOR<br>INTERNATIONAL (NAVISTAR)<br>ISUZU<br>THOMAS SCHOOL BUS<br>VOLVO  | 141083(2)             |          |  |                   |
| 83362    | S<br>HINO<br>KENWORTH  | 401754(4)         | 83635    | W<br>SAF HOLLAND<br>VOLVO<br>WESTERN STAR  | 145054(1)             |          |  |                   |
|          |  |                   | 83901    | N<br>MACK CAB SHOCKS   | Not Req'd.            |          |  |                   |
|          |  |                   | 83905    | N<br>MACK CAB SHOCKS<br>VOLVO CAB SHOCKS   | Not Req'd.            |          |  |                   |
|          |  |                   | 83906    | N<br>FREIGHTLINER CAB SHOCKS   | Not Req'd.            |          |  |                   |
|          |  |                   | 85000    | A<br>ARVIN MERITOR<br>BENSON TRUCK BODIES INC.<br>CUSH CORPORATION<br>EAST MANUFACTURING CORP.<br>FREIGHTLINER<br>GREAT DANE TRAILER<br>HENDRICKSON TRAILER SUSPENSION SYSTEMS<br>KENWORTH<br>MC NEILUS TRUCK & MAN.<br>ORION BUS INDUSTRIES<br>PETERBILT<br>RIDEWELL CORPORATION<br>SAF HOLLAND<br>STOUGHTON TRAILERS INC.<br>THOMAS SCHOOL BUS<br>TRAILMOBILE CANADA CORP.<br>TWIN COACH<br>UTILITY TRAILER MANUFACTURING COMPANY<br>VOLVO<br>WABASH NATIONAL<br>WATSON & CHALIN MFG. INC. | Not Req'd.            |          |  |                   |
|          |  |                   | 85001    | A<br>ARVIN MERITOR<br>FORD<br>INTERNATIONAL (NAVISTAR)   | 401754(4)             |          |  |                   |

N = New, S = Superseded, X = Discontinued once inventory is gone

# NUMERICAL LISTING LISTA NUMÉRICA LISTE NUMÉRIQUE

| GABRIEL#  | APPLICATION | MTG ACC<br>PKG NO     | GABRIEL#   | APPLICATION | MTG ACC<br>PKG NO     | GABRIEL#  | APPLICATION | MTG ACC<br>PKG NO |
|---|-------------|-----------------------|--|-------------|-----------------------|---|-------------|-------------------|
| 85012   | A           | 145080(2)             | 85029  | B           | Not Req'd.            | 85051   | D           | Not Req'd.        |
| ARVIN MERITOR<br>BLUEBIRD SCHOOL BUS<br>BROCKWAY SCHOOL BUS<br>CHANCE COACH<br>CHEVROLET TRUCK (Also See GMC Truck)<br>FORD<br>GMC TRUCK<br>INTERNATIONAL (NAVISTAR)<br>ISUZU<br>KENWORTH<br>PETERBILT<br>VOLVO   |             |                       | TRAILMOBILE CANADA CORP.<br>WATSON & CHALIN MFG. INC.<br>WINNEBAGO   |             |                       | SAF HOLLAND<br>STOUGHTON TRAILERS INC.<br>TRAILMOBILE CANADA CORP.<br>TUTHILL TECHNOLOGIES<br>WABASH NATIONAL   |             |                   |
| 85013   | B           | Not Req'd.            | 85030  | C           | Not Req'd.            | 85052   | A           | Not Req'd.        |
| ARVIN MERITOR<br>BLUEBIRD SCHOOL BUS<br>FORD<br>HENDRICKSON TRAILER SUSPENSION SYSTEMS<br>HENDRICKSON TRUCK SUSPENSION SYSTEMS<br>INTERNATIONAL (NAVISTAR)<br>KENWORTH<br>MAECO<br>MC NEILUS TRUCK & MAN.<br>PETERBILT<br>REYCO SUSPENSION<br>SAF HOLLAND<br>SPARTAN MOTORS<br>STERLING TRUCK<br>TRAILMOBILE CANADA CORP.<br>TUTHILL TECHNOLOGIES<br>VOLVO  |             |                       | ARVIN MERITOR<br>BLUEBIRD SCHOOL BUS<br>CHEVROLET TRUCK (Also See GMC Truck)<br>EAST MANUFACTURING CORP.<br>FORD<br>FRUEHAUF<br>GMC TRUCK<br>HENDRICKSON TRAILER SUSPENSION SYSTEMS<br>HENDRICKSON TRUCK SUSPENSION SYSTEMS<br>INTERNATIONAL (NAVISTAR)<br>MAECO<br>OSHKOSH MOTORS<br>PACIFIC TRUCK & TRAILER<br>PIERCE MANUFACTURING INC.<br>REYCO SUSPENSION<br>SAF HOLLAND<br>STERLING TRUCK<br>THOMAS SCHOOL BUS<br>TUTHILL TECHNOLOGIES<br>VOLVO<br>WABASH NATIONAL |             |                       | ARVIN MERITOR<br>BLUEBIRD SCHOOL BUS<br>GREAT DANE TRAILER<br>HENDRICKSON TRAILER SUSPENSION SYSTEMS<br>INGERSOLL AXLES<br>REYCO SUSPENSION<br>SAF HOLLAND<br>TUTHILL TECHNOLOGIES<br>VOLVO<br>WABASH NATIONAL<br>WATSON & CHALIN MFG. INC. |             |                   |
| 85014   | D           | Not Req'd.            | 85031  | D           | 145147(1) & TR0027(2) | 85053   | C           | 145126(2)         |
| ARVIN MERITOR<br>CHANCE COACH<br>CUSH CORPORATION<br>DINA BUS<br>HARDEE MFG<br>HENDRICKSON TRAILER SUSPENSION SYSTEMS<br>INTERNATIONAL (NAVISTAR)<br>MACK<br>REYCO SUSPENSION<br>RIDEWELL CORPORATION<br>SAF HOLLAND<br>TUTHILL TECHNOLOGIES<br>WATSON & CHALIN MFG. INC.   |             |                       | KENWORTH<br>PETERBILT  |             |                       | WESTERN STAR  |             |                   |
| 85023   | D           | 140149(1)             | 85033  | A           | 145099(1)             | 85054   | W           | 145080(2)         |
| INTERNATIONAL (NAVISTAR)<br>KENWORTH<br>MACK<br>PETERBILT<br>VOLVO  |             |                       | INTERNATIONAL (NAVISTAR)<br>KENWORTH<br>MACK<br>PACCAR<br>PETERBILT<br>VOLVO   |             |                       | FORD<br>STERLING TRUCK  |             |                   |
| 85024   | W           | 140149(1)             | 85036  | D           | Not Req'd.            | 85055   | W           | 145080(2)         |
| AUTOCAR<br>INTERNATIONAL (NAVISTAR)<br>MACK<br>VOLVO  |             |                       | AUTOCAR<br>BLUEBIRD SCHOOL BUS<br>HENDRICKSON TRUCK SUSPENSION SYSTEMS<br>LION BUS<br>MACK<br>PETERBILT<br>SPARTAN MOTORS<br>VOLVO   |             |                       | FORD<br>STERLING TRUCK  |             |                   |
| 85025   | W           | 140169(1) & 145054(1) | 85040  | W           | 401754(4)             | 85058   | B           | Not Req'd.        |
| VOLVO   |             |                       | FORD<br>STERLING TRUCK<br>VOLVO  |             |                       | BLUEBIRD SCHOOL BUS<br>FREIGHTLINER<br>FREIGHTLINER CUSTOM CHASSIS<br>INTERNATIONAL (NAVISTAR)<br>OSHKOSH MOTORS<br>PIERCE MANUFACTURING INC.<br>THOMAS SCHOOL BUS<br>VOLVO   |             |                   |
| 85026   | W           | 145054(1)             | 85042  | W           | 401754(4)             | 85059   | W           | Not Req'd.        |
| ARVIN MERITOR<br>AUTOCAR<br>GMC TRUCK<br>VOLVO  |             |                       | FREIGHTLINER<br>VOLVO  |             |                       | RED LION TRAILER<br>SAF HOLLAND<br>STOUGHTON TRAILERS INC.<br>TRAILMOBILE CANADA CORP.<br>WABASH NATIONAL   |             |                   |
| 85027   | W           | 145054(2)             | 85043  | D           | Not Req'd.            | 85060   | D           | Not Req'd.        |
| ARVIN MERITOR<br>AUTOCAR<br>INTERNATIONAL (NAVISTAR)<br>VOLVO   |             |                       | FREIGHTLINER<br>FREIGHTLINER CUSTOM CHASSIS<br>HENDRICKSON TRAILER SUSPENSION SYSTEMS<br>STERLING TRUCK  |             |                       | AUTOCAR<br>CHALMERS SUSPENSION<br>FREIGHTLINER<br>INTERNATIONAL (NAVISTAR)<br>KENWORTH<br>PETERBILT<br>SAF HOLLAND<br>VOLVO<br>WATSON & CHALIN MFG. INC.<br>WESTERN STAR  |             |                   |
| 85029   | B           | Not Req'd.            | 85045  | A           | Not Req'd.            | 85061   | A           | Not Req'd.        |
| ARVIN MERITOR<br>BLUEBIRD SCHOOL BUS<br>COACHMEN RV<br>DURA SUSPENSION<br>EAST MANUFACTURING CORP.<br>FLEETWOOD RV<br>FOREST RIVER INC<br>FREIGHTLINER CUSTOM CHASSIS<br>GULF STREAM COACH<br>HENDRICKSON TRAILER SUSPENSION SYSTEMS<br>HOLIDAY RAMBLER<br>INTERNATIONAL (NAVISTAR)<br>ITASCA<br>KENWORTH<br>KING OF THE ROAD<br>MANDALAY COACH<br>MONACO<br>NEWMAR CORP<br>PAGE SUSPENSION<br>PETERBILT<br>RIDEWELL CORPORATION<br>SAF HOLLAND<br>SPARTAN MOTORS<br>THOR MOTOR COACH |             |                       | ARVIN MERITOR<br>CUSH CORPORATION<br>HENDRICKSON TRAILER SUSPENSION SYSTEMS<br>INGERSOLL AXLES<br>MUNCIE RECLAMATION<br>REYCO SUSPENSION<br>RIDEWELL CORPORATION<br>SAF HOLLAND<br>TUTHILL TECHNOLOGIES<br>UTILITY TRAILER MANUFACTURING COMPANY<br>VOLVO<br>WABASH NATIONAL<br>WATSON & CHALIN MFG. INC.  |             |                       | MACK<br>POWERHOUSE COACH INC.<br>RENEGADE RV<br>VOLVO   |             |                   |
|   |             |                       | 85046  | W           | 140149(1)             | 85062   | A           | 145080(2)         |
|   |             |                       | AUTOCAR<br>VOLVO   |             |                       | KENWORTH<br>PETERBILT<br>VOLVO  |             |                   |
|   |             |                       | 85047  | C           | 140149(1)             | 85063   | W           | 145080(2)         |
|   |             |                       | FORD<br>KENWORTH<br>PETERBILT<br>STERLING TRUCK<br>VOLVO   |             |                       | FORD<br>MAECO<br>STERLING TRUCK   |             |                   |
|   |             |                       | 85050  | S           | Not Req'd.            | 85064   | C           | Not Req'd.        |
|   |             |                       | CHEVROLET TRUCK (Also See GMC Truck)<br>GMC TRUCK  |             |                       | CUSH CORPORATION<br>GREAT DANE TRAILER<br>HENDRICKSON TRAILER SUSPENSION SYSTEMS<br>WATSON & CHALIN MFG. INC.   |             |                   |
|   |             |                       | 85051  | D           | Not Req'd.            | 85065   | W           | 145128(1)         |
|   |             |                       | BLUEBIRD SCHOOL BUS<br>GILLIG BROS.<br>MUNCIE RECLAMATION<br>OSHKOSH MOTORS<br>REYCO SUSPENSION  |             |                       | MACK<br>VOLVO   |             |                   |
|   |             |                       |  |             |                       | 85066   | A           | Not Req'd.        |
|   |             |                       |  |             |                       | MACK<br>POWERHOUSE COACH INC.<br>RENEGADE RV<br>VOLVO   |             |                   |
|   |             |                       |  |             |                       | 85067   | A           | Not Req'd.        |
|   |             |                       |  |             |                       | KENWORTH<br>PETERBILT<br>VOLVO  |             |                   |
|   |             |                       |  |             |                       | 85069   | A           | 145089-000(2)     |
|   |             |                       |  |             |                       | ARVIN MERITOR<br>KENWORTH<br>PETERBILT<br>VOLVO   |             |                   |

*S = Superseded*

# NUMERICAL LISTING LISTA NUMÉRICA LISTE NUMÉRIQUE

| GABRIEL# | APPLICATION   | MTG ACC<br>PKG NO | GABRIEL# | APPLICATION  | MTG ACC<br>PKG NO | GABRIEL# | APPLICATION  | MTG ACC<br>PKG NO |
|----------|---|-------------------|----------|--|-------------------|----------|--|-------------------|
| 85070    | A<br>KENWORTH<br>PETERBILT<br>VOLVO   | 401754(2)         | 85119    | N<br>PETERBILT   | Not Req'd.        | 85302    | W<br>FWD TRUCK<br>GILLIG BROS.<br>GMC TRUCK<br>KENWORTH<br>MACK<br>MAECO<br>MOTOR COACH INDUSTRIES<br>PETERBILT<br>RIDEWELL CORPORATION<br>VOLVO   | 401754(4)         |
| 85071    | W<br>CHEVROLET TRUCK (Also See GMC Truck)<br>GMC TRUCK<br>ISUZU   | 145054(2)         | 85120    | N<br>MACK  | Not Req'd.        | 85122    | N<br>FREIGHTLINER CUSTOM CHASSIS<br>THOMAS SCHOOL BUS  | 145089-000(1)     |
| 85072    | C<br>AUTOCAR<br>HENDRICKSON TRUCK SUSPENSION SYSTEMS<br>INTERNATIONAL (NAVISTAR)<br>KENWORTH<br>MACK<br>MC NEILUS TRUCK & MAN.<br>VOLVO<br>WESTERN STAR | Not Req'd.        | 85123    | N<br>FREIGHTLINER  | 145090(1)         | 85124    | N<br>DAMON MOTOR COACH<br>FLEETWOOD RV<br>HOLIDAY RAMBLER<br>ITASCA<br>MONACO<br>NATIONAL RV INC.<br>WINNEBAGO<br>WORKHORSE  | 145054(2)         |
| 85078    | W<br>DANA<br>WABASH NATIONAL  | Not Req'd.        | 85125    | N<br>DAMON MOTOR COACH<br>FLEETWOOD RV<br>HOLIDAY RAMBLER<br>ITASCA<br>MONACO<br>NATIONAL RV INC.<br>WINNEBAGO<br>WORKHORSE  | Not Req'd.        | 85126    | N<br>DAMON MOTOR COACH<br>FLEETWOOD RV<br>HOLIDAY RAMBLER<br>ITASCA<br>MONACO<br>NATIONAL RV INC.<br>WINNEBAGO<br>WORKHORSE  | 145054(1)         |
| 85079    | W<br>HENDRICKSON TRAILER SUSPENSION SYSTEMS<br>MC NEILUS TRUCK & MAN.   | Not Req'd.        | 85180    | N<br>FORD<br>GLAVAL BUS CO.<br>STARCRAFT BUS CO.   | Not Req'd.        | 85181    | N<br>FORD<br>GLAVAL BUS CO.<br>STARCRAFT BUS CO.   | Not Req'd.        |
| 85080    | W<br>MACK<br>VOLVO  | 145054(1)         | 85182    | N<br>KENWORTH<br>PETERBILT   | 145089-200(2)     | 85300    | D<br>ARVIN MERITOR<br>CHEVROLET TRUCK (Also See GMC Truck)<br>FREIGHTLINER<br>FRUEHAUF<br>GMC TRUCK<br>GRANNING SUSPENSION<br>HOBBS TRAILERS<br>INTERNATIONAL (NAVISTAR)<br>MAECO<br>MUNCIE RECLAMATION<br>OSHKOSH MOTORS<br>OSTERLUND TRUCK<br>OTTAWA TRUCK<br>PIERCE MANUFACTURING INC.<br>REYCO SUSPENSION<br>SAF HOLLAND<br>SEAGRAVE FIRE APPARATUS LLC<br>TUTHILL TECHNOLOGIES<br>VOLVO<br>WABASH NATIONAL<br>WATSON & CHALIN MFG. INC.<br>WESTERN UNIT "STABILAIRE" SUSPENSION | 401754(4)         |
| 85081    | W<br>VOLVO  | 145090(1)         | 85301    | W<br>BECK BUS<br>CHEVROLET TRUCK (Also See GMC Truck)<br>CLARK EQUIPMENT<br>FLXIBLE BUS<br>FORD<br>FREIGHTLINER<br>GMC TRUCK<br>HENDRICKSON TRAILER SUSPENSION SYSTEMS<br>SAF HOLLAND<br>STERLING TRUCK<br>VOLVO | 401754(4)         | 85305    | W<br>ARVIN MERITOR<br>BROCKWAY SCHOOL BUS<br>BUS & TRUCK CO.<br>CHEVROLET TRUCK (Also See GMC Truck)<br>CONTINENTAL TRAILWAYS-EAGLE INT'L<br>EAGLE MOTOR COACH<br>FLXIBLE BUS<br>FORD<br>FRUEHAUF<br>GMC TRUCK<br>HENDRICKSON TRUCK SUSPENSION SYSTEMS<br>MACK<br>MAECO<br>MC NEILUS TRUCK & MAN.<br>MOHAWK<br>PAI CORP<br>RIDEWELL CORPORATION<br>VOLVO<br>WESTERN STAR<br>WESTERN UNIT "STABILAIRE" SUSPENSION   | 401754(4)         |
| 85082    | W<br>IC CORPORATION<br>INTERNATIONAL (NAVISTAR)   | Not Req'd.        | 85302    | W<br>AM GENERAL<br>ARVIN MERITOR<br>CHEVROLET TRUCK (Also See GMC Truck)<br>CRANE CARRIER<br>FORD<br>FREIGHTLINER  | 401754(4)         | 85307    | W<br>ACF BRILL BUS<br>ARVIN MERITOR<br>BECK BUS<br>BLUEBIRD SCHOOL BUS<br>BROCKWAY SCHOOL BUS<br>BUS & TRUCK CO.<br>CHEVROLET TRUCK (Also See GMC Truck)   | 401754(4)         |
| 85083    | X<br>HENDRICKSON TRUCK SUSPENSION SYSTEMS   | 145128(1)         |          |  |                   |          |  |                   |
| 85084    | D<br>KENWORTH<br>PETERBILT  | Not Req'd.        |          |  |                   |          |  |                   |
| 85085    | X<br>NISSAN   | 145054(2)         |          |  |                   |          |  |                   |
| 85086    | W<br>BLUEBIRD SCHOOL BUS<br>REYCO SUSPENSION  | Not Req'd.        |          |  |                   |          |  |                   |
| 85087    | W<br>HENDRICKSON TRUCK SUSPENSION SYSTEMS<br>MC NEILUS TRUCK & MAN.   | Not Req'd.        |          |  |                   |          |  |                   |
| 85088    | A<br>MACK<br>POWERHOUSE COACH INC.<br>RENEGADE RV<br>VOLVO  | Not Req'd.        |          |  |                   |          |  |                   |
| 85090    | W<br>BLUEBIRD SCHOOL BUS  | Not Req'd.        |          |  |                   |          |  |                   |
| 85091    | W<br>THOMAS SCHOOL BUS  | Not Req'd.        |          |  |                   |          |  |                   |
| 85092    | X<br>FREIGHTLINER CUSTOM CHASSIS  | 145054(1)         |          |  |                   |          |  |                   |
| 85097    | X<br>FREIGHTLINER CUSTOM CHASSIS<br>HOLIDAY RAMBLER<br>MONACO<br>SAF HOLLAND  | Not Req'd.        |          |  |                   |          |  |                   |
| 85098    | B<br>MACK<br>POWERHOUSE COACH INC.<br>RENEGADE RV<br>VOLVO  | Not Req'd.        |          |  |                   |          |  |                   |
| 85099    | X<br>SAF HOLLAND  | Not Req'd.        |          |  |                   |          |  |                   |
| 85102    | W<br>HENDRICKSON TRUCK SUSPENSION SYSTEMS<br>INTERNATIONAL (NAVISTAR)   | Not Req'd.        |          |  |                   |          |  |                   |
| 85106    | W<br>BLUEBIRD SCHOOL BUS  | Not Req'd.        |          |  |                   |          |  |                   |
| 85109    | N<br>KENWORTH<br>PETERBILT<br>SAF HOLLAND<br>VOLVO<br>WESTERN STAR  | Not Req'd.        |          |  |                   |          |  |                   |
| 85119    | N<br>KENWORTH   | Not Req'd.        |          |  |                   |          |  |                   |

N = New, X = Discontinued once inventory is gone

# NUMERICAL LISTING LISTA NUMÉRICA LISTE NUMÉRIQUE

| GABRIEL# | APPLICATION   | MTG ACC<br>PKG NO | GABRIEL# | APPLICATION  | MTG ACC<br>PKG NO | GABRIEL# | APPLICATION   | MTG ACC<br>PKG NO            |
|----------|---|-------------------|----------|--|-------------------|----------|---|------------------------------|
| 85307    | W<br>CLARK EQUIPMENT<br>CONTINENTAL TRAILWAYS-EAGLE INT'L<br>CRANE CARRIER<br>DIAMOND-REO<br>DINA BUS<br>EAGLE MOTOR COACH<br>FLXIBLE BUS<br>FORD<br>GMC TRUCK<br>HENDRICKSON TRUCK SUSPENSION SYSTEMS<br>INTERNATIONAL (NAVISTAR)<br>MACK<br>MAECO<br>ONEIDA PRODUCTS<br>ORION BUS INDUSTRIES<br>PIERCE MANUFACTURING INC.<br>REYCO SUSPENSION<br>RIDEWELL CORPORATION<br>SPARTAN MOTORS<br>THOMAS SCHOOL BUS<br>VOLVO<br>WESTERN STAR<br>WESTERN UNIT "STABILAIRE" SUSPENSION | 401754(4)         | 85316    | C<br>OSHKOSH MOTORS<br>PIERCE MANUFACTURING INC.<br>VOLVO  | 145090(1)         | 85338    | W<br>HENDRICKSON TRAILER SUSPENSION SYSTEMS<br>UTILITY TRAILER MANUFACTURING COMPANY  | Not Req'd.                   |
| 85308    | W<br>ACF BRILL BUS<br>ARVIN MERITOR<br>CHEVROLET TRUCK (Also See GMC Truck)<br>EAGLE MOTOR COACH<br>FREIGHTLINER<br>GMC TRUCK<br>INTERNATIONAL (NAVISTAR)<br>KENWORTH<br>MACK<br>MAECO<br>MOHAWK<br>ORION BUS INDUSTRIES<br>PETERBILT<br>PREVOST<br>THOMAS SCHOOL BUS<br>VOLVO<br>WESTERN STAR<br>WESTERN UNIT "STABILAIRE" SUSPENSION  | 401754(4)         | 85318    | W<br>ARVIN MERITOR<br>GILLIG BROS.<br>HAUSMAN<br>VOLVO   | 145054(2)         | 85339    | W<br>MAECO<br>MOTOR COACH INDUSTRIES<br>PREVOST<br>TRANSPORTATION MFG. CORP<br>VOLVO  | 401754(4)                    |
| 85310    | B<br>ARVIN MERITOR<br>INTERNATIONAL (NAVISTAR)<br>KENWORTH<br>MACK<br>OTTAWA TRUCK<br>PETERBILT<br>VOLVO  | 141108(1)         | 85319    | C<br>FREIGHTLINER<br>INTERNATIONAL (NAVISTAR)<br>KENWORTH<br>MACK<br>PETERBILT<br>VOLVO  | 145089-000(1)     | 85340    | W<br>MOTOR COACH INDUSTRIES   | 145089-000(1)                |
| 85311    | A<br>ARVIN MERITOR<br>FLXIBLE BUS<br>INTERNATIONAL (NAVISTAR)<br>KENWORTH<br>LEYLAND TRUCK<br>MACK<br>PETERBILT<br>VOLVO  | 141247(1)         | 85320    | A<br>FREIGHTLINER<br>KENWORTH<br>MAECO<br>PETERBILT<br>VOLVO   | 401754(4)         | 85341    | W<br>MOTOR COACH INDUSTRIES   | 145089-000(1)                |
| 85313    | X<br>ARVIN MERITOR<br>FLXIBLE BUS<br>GMC TRUCK<br>GREYHOUND BUS<br>MAECO<br>MOTOR COACH INDUSTRIES<br>NOVA BUS<br>REYCO SUSPENSION<br>TRANSPORTATION MFG. CORP<br>TUTHILL TECHNOLOGIES  | 401754(4)         | 85321    | W<br>ARVIN MERITOR<br>FRUEHAUF<br>HOLLAND - BINKLEY<br>MACK<br>SAF HOLLAND<br>VOLVO<br>WABASH NATIONAL<br>WATSON & CHALIN MFG. INC.  | Not Req'd.        | 85342    | X<br>CHEVROLET TRUCK (Also See GMC Truck)<br>GMC TRUCK  | 145054(2)                    |
| 85314    | W<br>ARVIN MERITOR<br>AUTOCAR<br>CHALMERS SUSPENSION<br>EAGLE MOTOR COACH<br>FORD<br>KENWORTH<br>MAECO<br>PETERBILT<br>STERLING TRUCK<br>VOLVO  | 401754(4)         | 85322    | W<br>FRUEHAUF<br>VOLVO<br>WABASH NATIONAL  | 401754(2)         | 85343    | W<br>KENWORTH<br>PETERBILT  | 145089-000(1) &<br>401754(2) |
| 85315    | W<br>CLARK EQUIPMENT<br>CUNHA PRODUCTS OHD<br>FORD<br>JIFFLOX<br>KWK-LOC (JIFFLOX)<br>VOLVO<br>WESTERN STAR   | 401754(4)         | 85323    | A<br>ARVIN MERITOR<br>EAST MANUFACTURING CORP.<br>GREAT DANE TRAILER<br>HENDRICKSON TRAILER SUSPENSION SYSTEMS<br>INGERSOLL AXLES<br>KENWORTH<br>MC NEILUS TRUCK & MAN.<br>REYCO SUSPENSION<br>SAF HOLLAND<br>UTILITY TRAILER MANUFACTURING COMPANY<br>VOLVO<br>WABASH NATIONAL<br>WATSON & CHALIN MFG. INC. | Not Req'd.        | 85344    | W<br>HENDRICKSON TRAILER SUSPENSION SYSTEMS<br>WATSON & CHALIN MFG. INC.  | Not Req'd.                   |
| 85316    | C<br>INTERNATIONAL (NAVISTAR)<br>MACK<br>MAECO  | 145090(1)         | 85324    | X<br>CHAMPION BUS INC<br>CHEVROLET TRUCK (Also See GMC Truck)<br>GMC TRUCK<br>ISUZU  | 145054(2)         | 85345    | W<br>HENDRICKSON TRAILER SUSPENSION SYSTEMS<br>MC NEILUS TRUCK & MAN.<br>WATSON & CHALIN MFG. INC.  | Not Req'd.                   |
|          |   |                   | 85327    | W<br>FRUEHAUF  | 401754(2)         | 85346    | X<br>NEW FLYER  | 145090(2)                    |
|          |   |                   | 85329    | W<br>ARVIN MERITOR<br>BLUEBIRD SCHOOL BUS<br>PREVOST   | 401754(4)         | 85347    | X<br>NEW FLYER  | 145090(2)                    |
|          |   |                   | 85330    | S<br>PREVOST   | 145054(1)         | 85351    | N<br>IC CORPORATION<br>INTERNATIONAL (NAVISTAR)   | 145090(1)                    |
|          |   |                   | 85331    | C<br>FREIGHTLINER<br>FREIGHTLINER CUSTOM CHASSIS<br>WESTERN STAR   | Not Req'd.        | 85376    | W<br>FORD<br>STERLING TRUCK   | 401754(4)                    |
|          |   |                   | 85332    | W<br>IC CORPORATION<br>INTERNATIONAL (NAVISTAR)  | 145128(1)         | 85377    | W<br>NOVA BUS   | Not Req'd.                   |
|          |   |                   | 85333    | W<br>INTERNATIONAL (NAVISTAR)  | 145128(1)         | 85378    | X<br>NOVA BUS<br>PREVOST  | Not Req'd.                   |
|          |   |                   | 85334    | D<br>ADVANCE MIXER<br>MAECO<br>MC NEILUS TRUCK & MAN.<br>REYCO SUSPENSION  | 401754(4)         | 85379    | X<br>PREVOST  | 145054(1)                    |
|          |   |                   | 85335    | W<br>FREIGHTLINER  | Not Req'd.        | 85380    | X<br>PREVOST  | 145090(1) & 401754(2)        |
|          |   |                   | 85336    | W<br>CHEVROLET TRUCK (Also See GMC Truck)<br>GMC TRUCK<br>ISUZU<br>PETERBILT   | 145054(2)         | 85382    | W<br>HENDRICKSON TRAILER SUSPENSION SYSTEMS<br>WATSON & CHALIN MFG. INC.  | Not Req'd.                   |
|          |   |                   | 85337    | W<br>HENDRICKSON TRAILER SUSPENSION SYSTEMS  | Not Req'd.        | 85637    | N<br>INTERNATIONAL (NAVISTAR)   | Not Req'd.                   |
|          |   |                   |          |  |                   | 85638    | N<br>HENDRICKSON TRUCK SUSPENSION SYSTEMS   | Not Req'd.                   |
|          |   |                   |          |  |                   | 85639    | N<br>INTERNATIONAL (NAVISTAR)   | Not Req'd.                   |
|          |   |                   |          |  |                   | 85700    | W<br>ABC BUS<br>AM GENERAL<br>ARVIN MERITOR<br>CHEVROLET TRUCK (Also See GMC Truck)<br>FLXIBLE BUS<br>FLYER INDUSTRIES<br>GMC TRUCK<br>GREYHOUND BUS<br>GRUMMAN BUS<br>JAY MADSEN<br>KENWORTH<br>MOHAWK<br>MOTOR COACH INDUSTRIES<br>MUNCIE RECLAMATION<br>NOVA BUS<br>ORION BUS INDUSTRIES<br>PREVOST<br>SICARD<br>TRANSPORTATION MFG. CORP<br>VOLVO | 401754(4)                    |
|          |   |                   |          |  |                   | 85702    | W<br>ACF BRILL BUS<br>ARVIN MERITOR<br>CHEVROLET TRUCK (Also See GMC Truck)<br>FLXIBLE BUS  | 401754(4)                    |

N = New, S = Superseded, X = Discontinued once inventory is gone

# NUMERICAL LISTING LISTA NUMÉRICA LISTE NUMÉRIQUE

| GABRIEL#  | APPLICATION | MTG ACC<br>PKG NO     | GABRIEL#   | APPLICATION             | MTG ACC<br>PKG NO     | GABRIEL#   | APPLICATION             | MTG ACC<br>PKG NO     |
|---|-------------|-----------------------|--|-------------------------|-----------------------|--|-------------------------|-----------------------|
| 85702   | W           | 401754(4)             | 85711  | W 145054(1) & 401754(2) |                       | 85729  | C 145176(1) & 401754(2) |                       |
| GMC TRUCK<br>HAUSMAN<br>MACK<br>MOHAWK<br>MOTOR COACH INDUSTRIES<br>MUNCIE RECLAMATION<br>NOVA BUS<br>PREVOST<br>REYCO SUSPENSION<br>RIDEWELL CORPORATION<br>TRANSPORTATION MFG. CORP<br>TUTHILL TECHNOLOGIES<br>VOLVO                      |             |                       | TRANSPORTATION MFG. CORP<br>VOLVO  |                         |                       | PREVOST<br>UNIVERSAL COACH   |                         |                       |
| 85703   | X           | 141247(1) & 401754(2) | 85712  | D                       | 401754(4)             | 85731  | X                       | 145054(1) & 401754(2) |
| FLXIBLE BUS<br>GRUMMAN BUS<br>MOHAWK<br>MUNCIE RECLAMATION<br>VOLVO   |             |                       | ARVIN MERITOR<br>BLUEBIRD SCHOOL BUS<br>CARPENTER BUS<br>CRANE CARRIER<br>DIAMOND-REO<br>FLUIDRIVE<br>FLXIBLE BUS<br>FORD<br>GILLIG BROS.<br>GRANNING SUSPENSION<br>HENDRICKSON TRAILER SUSPENSION SYSTEMS<br>MERITOR<br>ORION BUS INDUSTRIES<br>OSTERLUND TRUCK<br>RAYDAN MANUFACTURING<br>RIDEWELL CORPORATION<br>SPARTAN MOTORS<br>THOMAS SCHOOL BUS<br>TUTHILL TECHNOLOGIES<br>VOLVO |                         |                       | FLXIBLE BUS  |                         |                       |
| 85704   | W           | 401754(4)             | 85713  | W                       | 401754(4)             | 85732  | W                       | 145116(2)             |
| ARVIN MERITOR<br>CHEVROLET TRUCK (Also See GMC Truck)<br>FLXIBLE BUS<br>GMC TRUCK<br>GRUMMAN BUS<br>MOHAWK<br>MOTOR COACH INDUSTRIES<br>MUNCIE RECLAMATION<br>REYCO SUSPENSION<br>RIDEWELL CORPORATION<br>TUTHILL TECHNOLOGIES<br>VOLVO     |             |                       | CARPENTER BUS<br>CRANE CARRIER<br>EAGLE MOTOR COACH<br>MOTOR COACH INDUSTRIES<br>MUNCIE RECLAMATION<br>NOVA BUS<br>PREVOST<br>THOMAS SCHOOL BUS<br>TRANSPORTATION MFG. CORP  |                         |                       | ABC BUS<br>ARVIN MERITOR<br>FLXIBLE BUS<br>MOHAWK<br>MOTOR COACH INDUSTRIES<br>NOVA BUS<br>TRANSPORTATION MFG. CORP<br>VOLVO   |                         |                       |
| 85705   | W           | 145090(2)             | 85715  | X                       | 145093(1)             | 85733  | W                       | 145089-000(1)         |
| ARVIN MERITOR<br>FLXIBLE BUS<br>INTERNATIONAL (NAVISTAR)<br>MUNCIE RECLAMATION<br>NEOPLAN BUS<br>VOLVO  |             |                       | MOHAWK<br>ORION BUS INDUSTRIES   |                         |                       | ABC BUS<br>ARVIN MERITOR<br>CHEVROLET TRUCK (Also See GMC Truck)<br>EAGLE MOTOR COACH<br>FLXIBLE BUS<br>GILLIG BROS.<br>GMC TRUCK<br>INTERNATIONAL (NAVISTAR)<br>LINK MANUFACTURING LTD.<br>OSHKOSH MOTORS<br>RIDEWELL CORPORATION<br>SAF HOLLAND<br>VOLVO |                         |                       |
| 85706   | X           | 145090(2)             | 85716  | W                       | 145093(1)             | 85734  | W                       | 401754(4)             |
| HAUSMAN<br>NEOPLAN BUS<br>VOLVO   |             |                       | CRANE CARRIER<br>DINA BUS<br>FLXIBLE BUS<br>FORD<br>GILLIG BROS.<br>MAECO<br>NEW FLYER<br>ORION BUS INDUSTRIES   |                         |                       | BLUEBIRD SCHOOL BUS<br>CHEVROLET TRUCK (Also See GMC Truck)<br>CROWN COACH<br>FLXIBLE BUS<br>GILLIG BROS.<br>GMC TRUCK<br>INTERNATIONAL (NAVISTAR)<br>LINK MANUFACTURING LTD.<br>OSHKOSH MOTORS<br>RIDEWELL CORPORATION<br>SAF HOLLAND<br>VOLVO            |                         |                       |
| 85707   | X           | 145090(2)             | 85717  | S                       | 145093(1)             | 85735  | W                       | 401754(4)             |
| ARVIN MERITOR<br>FLXIBLE BUS<br>MOHAWK<br>MOTOR COACH INDUSTRIES<br>MUNCIE RECLAMATION<br>NEOPLAN BUS   |             |                       | MOHAWK<br>ORION BUS INDUSTRIES<br>REYCO SUSPENSION<br>TUTHILL TECHNOLOGIES   |                         |                       | ABC BUS<br>CHEVROLET TRUCK (Also See GMC Truck)<br>EAGLE MOTOR COACH<br>GMC TRUCK<br>GREYHOUND BUS<br>MOTOR COACH INDUSTRIES<br>PACIFIC TRUCK & TRAILER<br>PREVOST<br>TRANSPORTATION MFG. CORP<br>VOLVO<br>WESTERN UNIT "STABILAIR" SUSPENSION             |                         |                       |
| 85708   | D           | 145090(2)             | 85720  | W                       | 401754(4)             | 85736  | W                       | 401754(4)             |
| ABC BUS<br>ARVIN MERITOR<br>CHEVROLET TRUCK (Also See GMC Truck)<br>FLXIBLE BUS<br>FLYER INDUSTRIES<br>GILLIG BROS.<br>GMC TRUCK<br>M.A.N. BUS<br>MOTOR COACH INDUSTRIES<br>MUNCIE RECLAMATION<br>NEW FLYER<br>PREVOST<br>VAN HOOL<br>VOLVO |             |                       | NEW FLYER<br>ORION BUS INDUSTRIES<br>OTTAWA TRUCK  |                         |                       | ACF BRILL BUS<br>ARVIN MERITOR<br>BLUEBIRD SCHOOL BUS<br>FLXIBLE BUS<br>MOHAWK<br>PREVOST<br>RIDEWELL CORPORATION<br>THOMAS SCHOOL BUS<br>VOLVO  |                         |                       |
| 85709   | W           | 145090(2)             | 85722  | C                       | 145090(2)             | 85737  | W                       | Not Req'd.            |
| ABC BUS<br>M.A.N. BUS<br>MOTOR COACH INDUSTRIES<br>MUNCIE RECLAMATION<br>VOLVO  |             |                       | ARVIN MERITOR<br>FLYER INDUSTRIES<br>GILLIG BROS.<br>GMC TRUCK<br>M.A.N. BUS<br>MUNCIE RECLAMATION<br>NEW FLYER<br>VOLVO   |                         |                       | MERITOR<br>SUSPENSYS   |                         |                       |
| 85710   | X           | 145054(1) & 401754(2) | 85723  | W                       | 145075(1)             | 85738  | B                       | Not Req'd.            |
| CHEVROLET TRUCK (Also See GMC Truck)<br>FLXIBLE BUS<br>GMC TRUCK<br>MOTOR COACH INDUSTRIES<br>MUNCIE RECLAMATION<br>NEW FLYER<br>NOVA BUS<br>PREVOST<br>TRANSPORTATION MFG. CORP  |             |                       | GILLIG BROS.<br>MOTOR COACH INDUSTRIES<br>MUNCIE RECLAMATION<br>VOLVO  |                         |                       | EAST MANUFACTURING CORP.<br>HENDRICKSON TRAILER SUSPENSION SYSTEMS<br>MC NEILUS TRUCK & MAN.<br>REYCO SUSPENSION<br>TUTHILL TECHNOLOGIES<br>UTILITY TRAILER MANUFACTURING COMPANY  |                         |                       |
| 85711   | W           | 145054(1) & 401754(2) | 85724  | A                       | Not Req'd.            | 85739  | W                       | Not Req'd.            |
| ARVIN MERITOR<br>CHEVROLET TRUCK (Also See GMC Truck)<br>FLXIBLE BUS<br>FLYER INDUSTRIES<br>GMC TRUCK<br>MAECO<br>MOTOR COACH INDUSTRIES<br>NEW FLYER<br>ORION BUS INDUSTRIES   |             |                       | DYNAMAX CORP (COUNTRY COACH)<br>FEDERAL COACH<br>FREIGHTLINER<br>FREIGHTLINER CUSTOM CHASSIS<br>RENEGADE RV<br>STERLING TRUCK<br>THOMAS SCHOOL BUS<br>VOLVO<br>WESTERN STAR  |                         |                       | INTERNATIONAL (NAVISTAR)<br>MACK<br>MERITOR<br>RAYDAN MANUFACTURING  |                         |                       |
|   |             |                       | 85727  | D                       | 145176(2)             | 85740  | W                       | 145090(1) & 401754(2) |
|   |             |                       | ABC BUS<br>MOTOR COACH INDUSTRIES  |                         |                       | KENWORTH<br>MAECO<br>MOTOR COACH INDUSTRIES<br>PREVOST   |                         |                       |
|   |             |                       | 85728  | D                       | 145176(2)             | 85745  | N                       | 145090(2)             |
|   |             |                       | MOTOR COACH INDUSTRIES<br>PREVOST  |                         |                       | ELDORADO NATIONAL  |                         |                       |
|   |             |                       | 85729  | C                       | 145176(1) & 401754(2) | 85746  | N                       | 145090(2)             |
|   |             |                       | ABC BUS<br>MOTOR COACH INDUSTRIES<br>ORION BUS INDUSTRIES  |                         |                       | ELDORADO NATIONAL  |                         |                       |
|   |             |                       |  |                         |                       | 85900  | B                       | 145054(2)             |
|   |             |                       |  |                         |                       | COACHMEN RV<br>FLEETWOOD RV<br>FOREST RIVER INC<br>FREIGHTLINER CUSTOM CHASSIS<br>GULF STREAM COACH  |                         |                       |

N = New, S = Superseded, X = Discontinued once inventory is gone



# NUMERICAL LISTING LISTA NUMÉRICA LISTE NUMÉRIQUE

| GABRIEL# | APPLICATION  | MTG ACC<br>PKG NO | GABRIEL# | APPLICATION  | MTG ACC<br>PKG NO | GABRIEL# | APPLICATION   | MTG ACC<br>PKG NO |
|----------|--|-------------------|----------|--|-------------------|----------|---|-------------------|
| 85900    | B<br>ITASCA<br>KENWORTH<br>KING OF THE ROAD<br>MANDALAY COACH<br>NEWMAR CORP<br>PETERBILT<br>THOR MOTOR COACH<br>VOLVO<br>WINNEBAGO                                | 145054(2)         | 85919    | B<br>HENDRICKSON TRUCK SUSPENSION SYSTEMS<br>MC NEILUS TRUCK & MAN.<br>MERITOR<br>WABASH NATIONAL<br>WORKHORSE   | Not Req'd.        | 85955    | W<br>HENDRICKSON TRUCK SUSPENSION SYSTEMS<br>INTERNATIONAL (NAVISTAR)   | Not Req'd.        |
| 85901    | C<br>FREIGHTLINER<br>KENWORTH<br>PETERBILT<br>RIDEWELL CORPORATION   | 401754(4)         | 85920    | B<br>FEDERAL COACH<br>FREIGHTLINER<br>STERLING TRUCK   | Not Req'd.        | 85956    | D<br>FREIGHTLINER<br>STERLING TRUCK<br>VOLVO<br>WESTERN STAR  | Not Req'd.        |
| 85902    | D<br>KENWORTH<br>PETERBILT   | 145054(2)         | 85921    | W<br>FREIGHTLINER  | 145054(1)         | 85957    | C<br>INTERNATIONAL (NAVISTAR)<br>STERLING TRUCK   | Not Req'd.        |
| 85903    | W<br>HENDRICKSON TRUCK SUSPENSION SYSTEMS  | Not Req'd.        | 85923    | D<br>INTERNATIONAL (NAVISTAR)  | Not Req'd.        | 85958    | A<br>DYNAMAX CORP (COUNTRY COACH)<br>FREIGHTLINER<br>RENEGADE RV<br>WESTERN STAR  | Not Req'd.        |
| 85904    | W<br>FREIGHTLINER<br>HENDRICKSON TRUCK SUSPENSION SYSTEMS<br>LINK MANUFACTURING LTD.<br>STERLING TRUCK   | Not Req'd.        | 85924    | B<br>INTERNATIONAL (NAVISTAR)  | Not Req'd.        | 85959    | C<br>BLUEBIRD SCHOOL BUS<br>DYNAMAX CORP (COUNTRY COACH)<br>FEDERAL COACH<br>FREIGHTLINER<br>FREIGHTLINER CUSTOM CHASSIS<br>HENDRICKSON TRUCK SUSPENSION SYSTEMS<br>KENWORTH<br>LION BUS<br>MC NEILUS TRUCK & MAN.<br>PETERBILT<br>RENEGADE RV<br>SPARTAN MOTORS<br>STERLING TRUCK<br>TIFFIN MOTORHOMES INC | Not Req'd.        |
| 85905    | X<br>SAF HOLLAND   | 401754(2)         | 85925    | W<br>INTERNATIONAL (NAVISTAR)  | Not Req'd.        | 85961    | W<br>HENDRICKSON TRUCK SUSPENSION SYSTEMS   | Not Req'd.        |
| 85906    | W<br>FORD<br>KENWORTH<br>MACK<br>MC NEILUS TRUCK & MAN.<br>PETERBILT<br>SAF HOLLAND<br>STERLING TRUCK<br>VOLVO<br>WESTERN STAR                                     | Not Req'd.        | 85926    | D<br>FORD<br>GLAVAL BUS CO.<br>IC CORPORATION<br>INTERNATIONAL (NAVISTAR)<br>STARCRAFT BUS CO.<br>STERLING TRUCK   | Not Req'd.        | 85962    | W<br>HENDRICKSON TRUCK SUSPENSION SYSTEMS<br>MC NEILUS TRUCK & MAN.   | Not Req'd.        |
| 85907    | X<br>SAF HOLLAND   | Not Req'd.        | 85927    | W<br>FORD<br>INTERNATIONAL (NAVISTAR)  | Not Req'd.        | 85963    | W<br>INTERNATIONAL (NAVISTAR)   | Not Req'd.        |
| 85908    | W<br>SAF HOLLAND   | Not Req'd.        | 85928    | D<br>FORD<br>GLAVAL BUS CO.<br>INTERNATIONAL (NAVISTAR)<br>STARCRAFT BUS CO.   | Not Req'd.        | 85964    | W<br>INTERNATIONAL (NAVISTAR)   | Not Req'd.        |
| 85909    | C<br>FORD<br>FREIGHTLINER<br>HENDRICKSON TRUCK SUSPENSION SYSTEMS<br>KENWORTH<br>MACK<br>MC NEILUS TRUCK & MAN.<br>PETERBILT<br>ROADMASTER (MONACO)<br>SAF HOLLAND | Not Req'd.        | 85929    | W<br>INTERNATIONAL (NAVISTAR)  | Not Req'd.        | 85965    | W<br>AUTOCAR<br>HENDRICKSON TRUCK SUSPENSION SYSTEMS<br>INTERNATIONAL (NAVISTAR)<br>KENWORTH<br>MC NEILUS TRUCK & MAN.  | Not Req'd.        |
| 85910    | W<br>BLUEBIRD SCHOOL BUS<br>FREIGHTLINER<br>KENWORTH<br>PETERBILT<br>ROADMASTER (MONACO)<br>SAF HOLLAND  | Not Req'd.        | 85930    | X<br>INTERNATIONAL (NAVISTAR)  | Not Req'd.        | 85966    | X<br>HENDRICKSON TRUCK SUSPENSION SYSTEMS<br>INTERNATIONAL (NAVISTAR)<br>KENWORTH<br>MC NEILUS TRUCK & MAN.   | Not Req'd.        |
| 85911    | W<br>HENDRICKSON TRAILER SUSPENSION SYSTEMS<br>SAF HOLLAND<br>UTILITY TRAILER MANUFACTURING COMPANY  | Not Req'd.        | 85931    | A<br>INTERNATIONAL (NAVISTAR)  | Not Req'd.        | 85967    | W<br>AUTOCAR<br>HENDRICKSON TRUCK SUSPENSION SYSTEMS<br>KENWORTH<br>MC NEILUS TRUCK & MAN.  | Not Req'd.        |
| 85912    | X<br>SAF HOLLAND   | 401754(2)         | 85932    | C<br>FREIGHTLINER<br>HENDRICKSON TRUCK SUSPENSION SYSTEMS<br>MC NEILUS TRUCK & MAN.<br>STERLING TRUCK<br>WESTERN STAR                                    | Not Req'd.        | 85968    | X<br>GILLIG BROS.<br>SAF HOLLAND  | 401754(4)         |
| 85914    | W<br>BLUEBIRD SCHOOL BUS<br>SAF HOLLAND  | Not Req'd.        | 85933    | B<br>HENDRICKSON TRUCK SUSPENSION SYSTEMS<br>MACK<br>MC NEILUS TRUCK & MAN.<br>POWERHOUSE COACH INC.<br>VOLVO  | Not Req'd.        | 85969    | X<br>INTERNATIONAL (NAVISTAR)   | Not Req'd.        |
| 85916    | W<br>HENDRICKSON TRAILER SUSPENSION SYSTEMS<br>HENDRICKSON TRUCK SUSPENSION SYSTEMS<br>MC NEILUS TRUCK & MAN.<br>SAF HOLLAND<br>VOLVO                              | Not Req'd.        | 85934    | A<br>MAECO<br>RIDEWELL CORPORATION<br>WATSON & CHALIN MFG. INC.  | Not Req'd.        | 85970    | W<br>MOTOR COACH INDUSTRIES   | 145089-000(1)     |
| 85918    | A<br>DYNAMAX CORP (COUNTRY COACH)<br>FREIGHTLINER<br>FREIGHTLINER CUSTOM CHASSIS<br>STERLING TRUCK<br>THOMAS SCHOOL BUS<br>VOLVO<br>WESTERN STAR                   | Not Req'd.        | 85935    | W<br>INTERNATIONAL (NAVISTAR)  | 145090(1)         | 85971    | X<br>BLUEBIRD SCHOOL BUS  | Not Req'd.        |
| 85919    | B<br>BLUEBIRD SCHOOL BUS<br>FREIGHTLINER<br>FREIGHTLINER CUSTOM CHASSIS<br>GREAT DANE TRAILER  | Not Req'd.        | 85936    | B<br>KENWORTH<br>PETERBILT   | 145089-200(1)     | 85972    | W<br>MACK   | Not Req'd.        |
|          |  |                   | 85937    | C<br>KENWORTH<br>PETERBILT   | 145089-200(1)     | 85974    | X<br>SAF HOLLAND  | Not Req'd.        |
|          |  |                   | 85938    | B<br>ARVIN MERITOR<br>HENDRICKSON TRAILER SUSPENSION SYSTEMS<br>INGERSOLL AXLES<br>REYCO SUSPENSION<br>TUTHILL TECHNOLOGIES<br>WATSON & CHALIN MFG. INC. | Not Req'd.        | 85975    | X<br>BLUEBIRD SCHOOL BUS<br>REYCO SUSPENSION<br>SAF HOLLAND   | Not Req'd.        |
|          |  |                   | 85939    | D<br>ARVIN MERITOR<br>HENDRICKSON TRAILER SUSPENSION SYSTEMS<br>TIMBREN INDUSTRIES<br>UTILITY TRAILER MANUFACTURING COMPANY<br>WATSON & CHALIN MFG. INC. | Not Req'd.        | 85976    | W<br>AUTOCAR<br>BLUEBIRD SCHOOL BUS<br>FORD<br>HENDRICKSON TRUCK SUSPENSION SYSTEMS<br>INTERNATIONAL (NAVISTAR)<br>MC NEILUS TRUCK & MAN.<br>VOLVO<br>WESTERN STAR  | Not Req'd.        |
|          |  |                   | 85953    | W<br>INTERNATIONAL (NAVISTAR)  | Not Req'd.        |          |   |                   |
|          |  |                   | 85954    | A<br>INTERNATIONAL (NAVISTAR)  | Not Req'd.        |          |   |                   |

*X = Discontinued once inventory is gone*

# NUMERICAL LISTING LISTA NUMÉRICA LISTE NUMÉRIQUE

| GABRIEL# | APPLICATION   | MTG ACC<br>PKG NO     | GABRIEL#                   | APPLICATION   | MTG ACC<br>PKG NO | GABRIEL# | APPLICATION   | MTG ACC<br>PKG NO |
|----------|---|-----------------------|----------------------------|---|-------------------|----------|---|-------------------|
| 85977    | W<br>HENDRICKSON TRUCK SUSPENSION SYSTEMS<br>MC NEILUS TRUCK & MAN.                 | 145128(1)             | 46177                      | A<br>CHALLENGE COOK<br>KENWORTH   | Not Req'd.        | 89407    | W<br>DURA SUSPENSION<br>EAST MANUFACTURING CORP.<br>FORD<br>FOREST RIVER INC<br>GEORGIE BOY MANUFACTURING<br>GILLIG BROS.<br>GMC TRUCK<br>GREAT DANE TRAILER<br>HARDEE MFG<br>HENDRICKSON TRUCK SUSPENSION SYSTEMS<br>HIGHWAY PRODUCT<br>INTERNATIONAL (NAVISTAR)<br>ITASCA<br>KENWORTH<br>MACK<br>MAECO<br>MC NEILUS TRUCK & MAN.<br>MOHAWK<br>MONACO<br>NATIONAL COACH CORP<br>OSHKOSH MOTORS<br>PETERBILT<br>REYCO SUSPENSION<br>RIDEWELL CORPORATION<br>SAF HOLLAND<br>STERLING TRUCK<br>TRAILMOBILE CANADA CORP.<br>TUTHILL TECHNOLOGIES<br>TWIN COACH<br>VOLVO<br>WABASH NATIONAL<br>WESTERN STAR<br>WINNEBAGO<br>WORKHORSE | Not Req'd.        |
| 85978    | D<br>HENDRICKSON TRUCK SUSPENSION SYSTEMS<br>MACK<br>VOLVO                          | Not Req'd.            | 665937                     | C<br>CRANE CARRIER  | Not Req'd.        | 89408    | A<br>KENWORTH<br>PETERBILT<br>VOLVO   | 145080(2)         |
| 85979    | W<br>HENDRICKSON TRUCK SUSPENSION SYSTEMS<br>MC NEILUS TRUCK & MAN.<br>WESTERN STAR | Not Req'd.            | 695406                     | W<br>ABC BUS<br>ARVIN MERITOR<br>VAN HOOL   | 145090(2)         | 89409    | W<br>ARVIN MERITOR<br>FORD<br>KENWORTH<br>OSHKOSH MOTORS<br>PETERBILT<br>PIERCE MANUFACTURING INC.<br>VOLVO   | 140149(1)         |
| 85980    | X<br>HENDRICKSON TRUCK SUSPENSION SYSTEMS<br>MC NEILUS TRUCK & MAN.                 | Not Req'd.            | <b>GasSLX Applications</b> |   |                   | 89410    | C<br>ARVIN MERITOR<br>FORD<br>INTERNATIONAL (NAVISTAR)<br>KENWORTH<br>MACK<br>MAECO<br>PETERBILT<br>REYCO SUSPENSION<br>STERLING TRUCK<br>TUTHILL TECHNOLOGIES<br>VOLVO   | 401754(4)         |
| 85984    | X<br>FREIGHTLINER   | Not Req'd.            | 89401                      | W<br>FORD<br>MAECO<br>STERLING TRUCK<br>VOLVO   | 140149(1)         | 89411    | W<br>ARVIN MERITOR<br>IC CORPORATION<br>INTERNATIONAL (NAVISTAR)<br>KENWORTH<br>MARMON<br>PETERBILT<br>VOLVO  | Not Req'd.        |
| 85985    | W<br>KENWORTH<br>PETERBILT  | 145089-200(1)         | 89402                      | W<br>BLUEBIRD SCHOOL BUS<br>FORD<br>STERLING TRUCK<br>VOLVO   | 140149(1)         | 89412    | X<br>ARVIN MERITOR<br>FREIGHTLINER<br>KENWORTH<br>MACK<br>MAECO<br>PETERBILT<br>REYCO SUSPENSION<br>SPARTAN MOTORS<br>TUTHILL TECHNOLOGIES<br>VOLVO   | 401754(4)         |
| 85986    | N<br>HENDRICKSON TRUCK SUSPENSION SYSTEMS<br>IC CORPORATION                         | Not Req'd.            | 89405                      | W<br>AUTOCAR<br>BLUEBIRD SCHOOL BUS<br>FORD<br>GILLIG BROS.<br>HENDRICKSON TRUCK SUSPENSION SYSTEMS<br>IC CORPORATION<br>INTERNATIONAL (NAVISTAR)<br>KENWORTH<br>LION BUS<br>MACK<br>MAECO<br>MARMON<br>MC NEILUS TRUCK & MAN.<br>PETERBILT<br>REYCO SUSPENSION<br>SAF HOLLAND<br>SPARTAN MOTORS<br>TUTHILL TECHNOLOGIES<br>VOLVO<br>WATSON & CHALIN MFG. INC.  | Not Req'd.        | 89413    | D<br>ARVIN MERITOR<br>BLUEBIRD SCHOOL BUS<br>BROCKWAY SCHOOL BUS<br>CHANCE COACH<br>CHEVROLET TRUCK (Also See GMC Truck)<br>FORD<br>GMC TRUCK<br>INTERNATIONAL (NAVISTAR)<br>ISUZU<br>KENWORTH<br>PETERBILT<br>VOLVO  | 145080(2)         |
| 85988    | N<br>KENWORTH<br>PETERBILT  | 145099(1)             | 89406                      | W<br>ALLCO TRAILER<br>AUTOCAR<br>CHEVROLET TRUCK (Also See GMC Truck)<br>COACHMEN RV<br>COUNTRY COACH<br>DAMON MOTOR COACH<br>ENTEGR A COACH<br>FLEETWOOD RV<br>FORD<br>FOREST RIVER INC<br>FREIGHTLINER<br>FRUEHAUF<br>GEORGIE BOY MANUFACTURING<br>GILLIG BROS.<br>GMC TRUCK<br>GREAT DANE TRAILER<br>HENDRICKSON TRUCK SUSPENSION SYSTEMS<br>HOLIDAY RAMBLER<br>ISUZU<br>ITASCA<br>JAYCO RV INC<br>KENWORTH<br>LODAL, INC.<br>MACK<br>MAECO<br>MARMON<br>MC NEILUS TRUCK & MAN.<br>MONACO<br>NATIONAL RV INC.<br>NEWMAR CORP<br>NEXUS RV<br>OSHKOSH MOTORS<br>PETERBILT<br>REYCO SUSPENSION<br>SAF HOLLAND<br>THOR MOTOR COACH<br>TUTHILL TECHNOLOGIES<br>VOLVO<br>WESTERN STAR<br>WINNEBAGO | Not Req'd.        | 89414    | W<br>ARVIN MERITOR<br>BLUEBIRD SCHOOL BUS   | Not Req'd.        |
| 85989    | D<br>KENWORTH<br>PETERBILT  | Not Req'd.            | 89407                      | W<br>ADVANCE MIXER<br>ARVIN MERITOR<br>BENSON TRUCK BODIES INC.<br>BLUEBIRD SCHOOL BUS<br>BROCKWAY SCHOOL BUS<br>CHANCE COACH<br>CHEVROLET TRUCK (Also See GMC Truck)<br>COACHMEN RV  | Not Req'd.        | 89415    | A<br>CHALLENGE COOK<br>KIMBLE MIXER CO<br>VOLVO   | Not Req'd.        |
| 85994    | N<br>INTERNATIONAL (NAVISTAR)   | Not Req'd.            |                            |   |                   |          |   |                   |
| 85995    | N<br>INTERNATIONAL (NAVISTAR)   | Not Req'd.            |                            |   |                   |          |   |                   |
| 85998    | N<br>INTERNATIONAL (NAVISTAR)   | Not Req'd.            |                            |   |                   |          |   |                   |
| 85999    | N<br>INTERNATIONAL (NAVISTAR)   | Not Req'd.            |                            |   |                   |          |   |                   |
| 86200    | D<br>MERITOR  | Not Req'd.            |                            |   |                   |          |   |                   |
| 86201    | X<br>MERITOR  | Not Req'd.            |                            |   |                   |          |   |                   |
| 86202    | X<br>MERITOR  | Not Req'd.            |                            |   |                   |          |   |                   |
| 86203    | X<br>MERITOR  | Not Req'd.            |                            |   |                   |          |   |                   |
| 87015    | W<br>ARVIN MERITOR<br>EAST MANUFACTURING CORP.<br>MERITOR                           | Not Req'd.            |                            |   |                   |          |   |                   |
| 87016    | X<br>NEW FLYER<br>ORION BUS INDUSTRIES  | 145116(1) & 145090(1) |                            |   |                   |          |   |                   |
| 87017    | X<br>BLUEBIRD SCHOOL BUS<br>OPTIMA BUS CORP<br>RIDEWELL CORPORATION                 | Not Req'd.            |                            |   |                   |          |   |                   |
| 87018    | W<br>ARVIN MERITOR<br>HENDRICKSON TRAILER SUSPENSION SYSTEMS                        | Not Req'd.            |                            |   |                   |          |   |                   |
| 87019    | X<br>NOVA BUS   | Not Req'd.            |                            |   |                   |          |   |                   |
| 89402    | W<br>VOLVO  | 140149(1)             |                            |   |                   |          |   |                   |
| 89414    | W<br>MAECO  | Not Req'd.            |                            |   |                   |          |   |                   |
| 89440    | W<br>MAECO  | Not Req'd.            |                            |   |                   |          |   |                   |
| 89447    | W<br>MUNCIE RECLAMATION   | 141108(1)             |                            |   |                   |          |   |                   |
| 632147   | W<br>CHALLENGE COOK   | Not Req'd.            |                            |   |                   |          |   |                   |

N = New, X = Discontinued once inventory is gone

# NUMERICAL LISTING LISTA NUMÉRICA LISTE NUMÉRIQUE

| GABRIEL# | APPLICATION  | MTG ACC<br>PKG NO | GABRIEL# | APPLICATION  | MTG ACC<br>PKG NO | GABRIEL# | APPLICATION   | MTG ACC<br>PKG NO |
|----------|--|-------------------|----------|--|-------------------|----------|---|-------------------|
| 89414    | W<br>CHEVROLET TRUCK (Also See GMC Truck)<br>COACHMEN RV<br>COUNTRY COACH<br>DAMON MOTOR COACH<br>ENTEGRÁ COACH<br>FLEETWOOD RV<br>FORD<br>FOREST RIVER INC<br>GEORGIE BOY MANUFACTURING<br>GMC TRUCK<br>HENDRICKSON TRAILER SUSPENSION SYSTEMS<br>HENDRICKSON TRUCK SUSPENSION SYSTEMS<br>HOLIDAY RAMBLER<br>INTERNATIONAL (NAVISTAR)<br>ITASCA<br>JAYCO RV INC<br>KENWORTH<br>MACK<br>MAECO<br>MC NEILUS TRUCK & MAN.<br>MONACO<br>NATIONAL RV INC.<br>NEWMAR CORP<br>NEXUS RV<br>PETERBILT<br>REYCO SUSPENSION<br>SAF HOLLAND<br>SPARTAN MOTORS<br>STERLING TRUCK<br>THOR MOTOR COACH<br>TRAILMOBILE CANADA CORP.<br>TUTHILL TECHNOLOGIES<br>VOLVO<br>WESTERN STAR<br>WINNEBAGO | Not Req'd.        | 89422    | W<br>BUS & TRUCK CO.<br>CHEVROLET TRUCK (Also See GMC Truck)<br>CONTINENTAL TRAILWAYS-EAGLE INT'L<br>CRANE CARRIER<br>CROWN COACH<br>EAGLE MOTOR COACH<br>FREIGHTLINER<br>GMC TRUCK<br>GREYHOUND BUS<br>HENDRICKSON TRUCK SUSPENSION SYSTEMS<br>INTERNATIONAL (NAVISTAR)<br>KENWORTH<br>MACK<br>MAECO<br>MATSON SCHOOL BUS<br>MC NEILUS TRUCK & MAN.<br>MOHAWK<br>MOTOR COACH INDUSTRIES<br>ORION BUS INDUSTRIES<br>OSHKOSH MOTORS<br>OTTAWA TRUCK<br>PETERBILT<br>PREVOST<br>THOMAS SCHOOL BUS<br>TRANSPORTATION MFG. CORP<br>VOLVO<br>WESTERN STAR<br>WESTERN UNIT "STABILAIRE" SUSPENSION | 401754(4)         | 89430    | C<br>HENDRICKSON TRAILER SUSPENSION SYSTEMS<br>HENDRICKSON TRUCK SUSPENSION SYSTEMS<br>HINO<br>INTERNATIONAL (NAVISTAR)<br>MACK<br>MAECO<br>MC NEILUS TRUCK & MAN.<br>OSHKOSH MOTORS<br>REYCO SUSPENSION<br>RIDEWELL CORPORATION<br>SAF HOLLAND<br>TUTHILL TECHNOLOGIES<br>VOLVO<br>WABASH NATIONAL<br>WATSON & CHALIN MFG. INC.  | Not Req'd.        |
| 89415    | W<br>INTERNATIONAL (NAVISTAR)<br>KENWORTH<br>MACK<br>PETERBILT<br>VOLVO  | 140149(1)         | 89423    | D<br>ARVIN MERITOR<br>INTERNATIONAL (NAVISTAR)<br>KENWORTH<br>MACK<br>OTTAWA TRUCK<br>PETERBILT<br>VOLVO   | 141108(1)         | 89431    | W<br>BLUEBIRD SCHOOL BUS<br>FREIGHTLINER<br>FREIGHTLINER CUSTOM CHASSIS<br>INTERNATIONAL (NAVISTAR)<br>OSHKOSH MOTORS<br>PIERCE MANUFACTURING INC.<br>THOMAS SCHOOL BUS<br>VOLVO  | Not Req'd.        |
| 89417    | W<br>ARVIN MERITOR<br>AUTOCAR<br>GMC TRUCK<br>VOLVO  | 145054(1)         | 89424    | C<br>ARVIN MERITOR<br>FLXIBLE BUS<br>INTERNATIONAL (NAVISTAR)<br>KENWORTH<br>LEYLAND TRUCK<br>MACK<br>PETERBILT<br>VOLVO   | 141247(1)         | 89432    | W<br>KENWORTH<br>MAECO  | Not Req'd.        |
| 89418    | W<br>ARVIN MERITOR<br>AUTOCAR<br>INTERNATIONAL (NAVISTAR)<br>VOLVO   | 145054(2)         | 89425    | W<br>ARVIN MERITOR<br>AUTOCAR<br>CHALMERS SUSPENSION<br>EAGLE MOTOR COACH<br>FORD<br>KENWORTH<br>MAECO<br>PETERBILT<br>STERLING TRUCK<br>VOLVO   | 401754(4)         | 89434    | W<br>AUTOCAR<br>VOLVO   | 140149(1)         |
| 89419    | W<br>CHEVROLET TRUCK (Also See GMC Truck)<br>FREIGHTLINER<br>FRUEHAUF<br>GMC TRUCK<br>GRANNING SUSPENSION<br>HOBBS TRAILERS<br>INTERNATIONAL (NAVISTAR)<br>MAECO<br>MUNCIE RECLAMATION<br>OSHKOSH MOTORS<br>OSTERLUND TRUCK<br>OTTAWA TRUCK<br>PIERCE MANUFACTURING INC.<br>REYCO SUSPENSION<br>SAF HOLLAND<br>SEAGRAVE FIRE APPARATUS LLC<br>TUTHILL TECHNOLOGIES<br>VOLVO<br>WABASH NATIONAL<br>WATSON & CHALIN MFG. INC.<br>WESTERN UNIT "STABILAIRE" SUSPENSION  | 401754(4)         | 89426    | W<br>INTERNATIONAL (NAVISTAR)<br>MACK<br>MAECO<br>OSHKOSH MOTORS<br>PIERCE MANUFACTURING INC.<br>VOLVO   | 145090(1)         | 89435    | W<br>FORD<br>KENWORTH<br>PETERBILT<br>STERLING TRUCK<br>VOLVO   | 140149(1)         |
| 89420    | W<br>AM GENERAL<br>ARVIN MERITOR<br>CHEVROLET TRUCK (Also See GMC Truck)<br>CRANE CARRIER<br>FORD<br>FREIGHTLINER<br>FWD TRUCK<br>GILLIG BROS.<br>GMC TRUCK<br>KENWORTH<br>MACK<br>MAECO<br>MOTOR COACH INDUSTRIES<br>PETERBILT<br>RIDEWELL CORPORATION<br>VOLVO   | 401754(4)         | 89427    | C<br>INTERNATIONAL (NAVISTAR)<br>KENWORTH<br>MACK<br>PACCAR<br>PETERBILT<br>VOLVO  | 145099(1)         | 89436    | B<br>ARVIN MERITOR<br>BENSON TRUCK BODIES INC.<br>CHANCE COACH<br>CHEVROLET TRUCK (Also See GMC Truck)<br>CUSH CORPORATION<br>DURA SUSPENSION<br>EAST MANUFACTURING CORP.<br>FREIGHTLINER<br>FRUEHAUF<br>GMC TRUCK<br>GREAT DANE TRAILER<br>HENDRICKSON TRAILER SUSPENSION SYSTEMS<br>HIGHWAY PRODUCT<br>HUTCHENS SUSPENSION<br>INGERSOLL AXLES<br>KENWORTH<br>MACK<br>MAECO<br>MC NEILUS TRUCK & MAN.<br>MOHAWK<br>ORION BUS INDUSTRIES<br>PAGE SUSPENSION<br>PETERBILT<br>REYCO SUSPENSION<br>RIDEWELL CORPORATION<br>SAF HOLLAND<br>STOUGHTON TRAILERS INC.<br>THOMAS SCHOOL BUS<br>TRAILMOBILE CANADA CORP.<br>TUTHILL TECHNOLOGIES<br>TWIN COACH<br>UTILITY TRAILER MANUFACTURING COMPANY<br>VOLVO<br>WABASH NATIONAL<br>WATSON & CHALIN MFG. INC. | Not Req'd.        |
| 89422    | W<br>ACF BRILL BUS<br>ARVIN MERITOR<br>BROCKWAY SCHOOL BUS   | 401754(4)         | 89428    | W<br>FREIGHTLINER<br>INTERNATIONAL (NAVISTAR)<br>KENWORTH<br>MACK<br>PETERBILT<br>VOLVO  | 145089-000(1)     | 89437    | W<br>EAST MANUFACTURING CORP.<br>HENDRICKSON TRAILER SUSPENSION SYSTEMS<br>THOMAS SCHOOL BUS  | Not Req'd.        |
|          |  |                   | 89429    | C<br>FREIGHTLINER<br>KENWORTH<br>MAECO<br>PETERBILT<br>VOLVO   | 401754(4)         | 89438    | W<br>FORD<br>STERLING TRUCK   | 145080(2)         |
|          |  |                   | 89430    | C<br>AUTOCAR<br>BLUEBIRD SCHOOL BUS<br>BOYDSTUN EQUIPMENT MANUFACTURING<br>CHEVROLET TRUCK (Also See GMC Truck)<br>EAST MANUFACTURING CORP.<br>FREIGHTLINER<br>FREIGHTLINER CUSTOM CHASSIS<br>GMC TRUCK  | Not Req'd.        | 89439    | W<br>FORD<br>STERLING TRUCK   | 145080(2)         |
|          |  |                   |          |  |                   | 89440    | W<br>ARVIN MERITOR<br>BLUEBIRD SCHOOL BUS<br>CHEVROLET TRUCK (Also See GMC Truck)<br>EAST MANUFACTURING CORP.<br>FORD<br>FRUEHAUF<br>GMC TRUCK<br>HENDRICKSON TRAILER SUSPENSION SYSTEMS  | Not Req'd.        |

*N = New, X = Discontinued once inventory is gone*

# NUMERICAL LISTING LISTA NUMÉRICA LISTE NUMÉRIQUE

| GABRIEL# | APPLICATION  | MTG ACC<br>PKG NO | GABRIEL# | APPLICATION  | MTG ACC<br>PKG NO | GABRIEL# | APPLICATION | MTG ACC<br>PKG NO |
|----------|--|-------------------|----------|--|-------------------|----------|-------------|-------------------|
| 89440    | W  | Not Req'd.        | 89457    | W  | Not Req'd.        |          |             |                   |
|          | HENDRICKSON TRUCK SUSPENSION SYSTEMS<br>INTERNATIONAL (NAVISTAR)<br>KENWORTH<br>MAECO<br>OSHKOSH MOTORS<br>PACIFIC TRUCK & TRAILER<br>PETERBILT<br>PIERCE MANUFACTURING INC.<br>REYCO SUSPENSION<br>SAF HOLLAND<br>STERLING TRUCK<br>THOMAS SCHOOL BUS<br>TUTHILL TECHNOLOGIES<br>VOLVO<br>WABASH NATIONAL |                   |          | INTERNATIONAL (NAVISTAR)   |                   |          |             |                   |
| 89441    | X  | 145054(1)         | 89458    | C  | Not Req'd.        |          |             |                   |
|          | FORD<br>KENWORTH<br>SAF HOLLAND  |                   |          | INTERNATIONAL (NAVISTAR)   |                   |          |             |                   |
| 89442    | W  | 145126(2)         | 89459    | C  | 401754(2)         |          |             |                   |
|          | WESTERN STAR   |                   |          | KENWORTH<br>PETERBILT<br>VOLVO   |                   |          |             |                   |
| 89443    | C  | Not Req'd.        | 89460    | W  | Not Req'd.        |          |             |                   |
|          | DYNAMAX CORP (COUNTRY COACH)<br>FEDERAL COACH<br>FREIGHTLINER<br>FREIGHTLINER CUSTOM CHASSIS<br>RENEGADE RV<br>STERLING TRUCK<br>THOMAS SCHOOL BUS<br>VOLVO<br>WESTERN STAR  |                   |          | KENWORTH<br>PETERBILT  |                   |          |             |                   |
| 89446    | W  | TR0027(4)         | 89461    | W  | Not Req'd.        |          |             |                   |
|          | ARVIN MERITOR<br>FORD<br>INTERNATIONAL (NAVISTAR)<br>STERLING TRUCK<br>VOLVO   |                   |          | GILLIG BROS.   |                   |          |             |                   |
| 89447    | W  | 141108(1)         | 89503    | N  | Not Req'd.        |          |             |                   |
|          | BLUEBIRD SCHOOL BUS<br>FLXIBLE BUS<br>IC CORPORATION<br>INTERNATIONAL (NAVISTAR)<br>MITSUBISHI-FUSO<br>MUNCIE RECLAMATION<br>NEOPLAN BUS<br>VOLVO  |                   |          | DYNAMAX CORP (COUNTRY COACH)<br>FEDERAL COACH<br>FREIGHTLINER<br>RENEGADE RV<br>STERLING TRUCK |                   |          |             |                   |
| 89448    | W  | Not Req'd.        |          |  |                   |          |             |                   |
|          | MACK<br>POWERHOUSE COACH INC.<br>RENEGADE RV<br>VOLVO  |                   |          |  |                   |          |             |                   |
| 89449    | C  | Not Req'd.        |          |  |                   |          |             |                   |
|          | DYNAMAX CORP (COUNTRY COACH)<br>FREIGHTLINER<br>FREIGHTLINER CUSTOM CHASSIS<br>STERLING TRUCK<br>THOMAS SCHOOL BUS<br>VOLVO<br>WESTERN STAR  |                   |          |  |                   |          |             |                   |
| 89450    | W  | Not Req'd.        |          |  |                   |          |             |                   |
|          | MACK<br>POWERHOUSE COACH INC.<br>RENEGADE RV<br>VOLVO  |                   |          |  |                   |          |             |                   |
| 89451    | B  | Not Req'd.        |          |  |                   |          |             |                   |
|          | KENWORTH<br>PETERBILT<br>VOLVO   |                   |          |  |                   |          |             |                   |
| 89453    | W  | Not Req'd.        |          |  |                   |          |             |                   |
|          | FREIGHTLINER<br>HENDRICKSON TRUCK SUSPENSION SYSTEMS<br>MC NEILUS TRUCK & MAN.<br>STERLING TRUCK<br>WESTERN STAR   |                   |          |  |                   |          |             |                   |
| 89454    | W  | Not Req'd.        |          |  |                   |          |             |                   |
|          | HENDRICKSON TRUCK SUSPENSION SYSTEMS<br>MACK<br>MC NEILUS TRUCK & MAN.<br>POWERHOUSE COACH INC.<br>VOLVO   |                   |          |  |                   |          |             |                   |
| 89455    | A  | 141108(1)         |          |  |                   |          |             |                   |
|          | ARVIN MERITOR<br>KENWORTH<br>PETERBILT<br>VOLVO  |                   |          |  |                   |          |             |                   |
| 89456    | D  | 145089-200(1)     |          |  |                   |          |             |                   |
|          | KENWORTH<br>PETERBILT  |                   |          |  |                   |          |             |                   |

N = New, X = Discontinued once inventory is gone



# Fleetline® GasSLX® Interchange

Intercambio  
Échange

| Fleetline | GasSLX |
|-----------|--------|
| 83122     | 89406  |
| 83123     | 89405  |
| 83124     | 89407  |
| 83126     | 89430  |
| 83128     | 89436  |
| 83200     | 89402  |
| 83203     | 89436  |
| 83207     | 89407  |
| 83209     | 89414  |
| 83309     | 89446  |
| 83312     | 89409  |
| 83389     | 89436  |
| 83456     | 89447  |
| 85000     | 89436  |
| 85001     | 89410  |
| 85003     | 89411  |
| 85005     | 89430  |
| 85007     | 89412  |
| 85012     | 89413  |
| 85013     | 89414  |
| 85023     | 89415  |
| 85024     | 89416  |
| 85026     | 89417  |
| 85027     | 89418  |
| 85030     | 89440  |
| 85033     | 89427  |
| 85036     | 89405  |
| 85046     | 89434  |
| 85047     | 89435  |
| 85053     | 89442  |
| 85054     | 89438  |
| 85055     | 89439  |

| Fleetline | GasSLX |
|-----------|--------|
| 85058     | 89431  |
| 85061     | 89450  |
| 85062     | 89408  |
| 85066     | 89448  |
| 85067     | 89451  |
| 85069     | 89455  |
| 85070     | 89459  |
| 85084     | 89460  |
| 85300     | 89419  |
| 85302     | 89420  |
| 85303     | 89422  |
| 85308     | 89422  |
| 85310     | 89423  |
| 85311     | 89424  |
| 85314     | 89425  |
| 85316     | 89426  |
| 85319     | 89428  |
| 85320     | 89429  |
| 85323     | 89436  |
| 85705     | 89447  |
| 85724     | 89443  |
| 85906     | 89407  |
| 85916     | 89430  |
| 85918     | 89449  |
| 85920     | 89503  |
| 85923     | 89458  |
| 85924     | 89457  |
| 85931     | 89458  |
| 85932     | 89453  |
| 85933     | 89454  |
| 85936     | 89456  |



**IMPORTANT NOTE:** Interchange must only be used for FLEETLINE to GAS SLX upgrade. Interchange is **NOT REVERSABLE**.

**NOTA IMPORTANTE:** El intercambio se debe utilizar solamente de FLEETLINE a GAS SLX mejorado. El intercambio **NO ES REVERSIBLE**.

**REMARQUE IMPORTANTE:** L'échange ne peut se faire que pour le surclassement du FLEETLINE au GAS SLX. L'échange **N'EST PAS REVERSIBLE**.



**COMPETITIVE & O.E.M. INTERCHANGE LIST**  
**Lista de Intercambios contra Competidores y Equipo Original.**  
**Liste d'interchange de produits compétitifs & d'équipement original (OEM)**

**ABC BUS**

| O.E.M #   | Gabriel | Upgrade | O.E.M #   | Gabriel | Upgrade | O.E.M #    | Gabriel | Upgrade | O.E.M # | Gabriel | Upgrade |
|-----------|---------|---------|-----------|---------|---------|------------|---------|---------|---------|---------|---------|
| 050134513 | 85732   |         | 12L-5-114 | 85727   |         | 6243-13790 | 85708   |         | 90-2291 | 695406  |         |
| 10685703  | 695406  |         | 12L-5-72  | 85709   |         | 6243-14040 | 85708   |         |         |         |         |
| 12B-5-1   | 85735   |         | 12L-5-88  | 85729   |         | 624314570  | 695406  |         |         |         |         |
| 12J-5-10  | 85733   |         | 3166657   | 85700   |         | 680323     | 85700   |         |         |         |         |

**ACF BRILL BUS**

| O.E.M # | Gabriel | Upgrade | O.E.M # | Gabriel | Upgrade | O.E.M # | Gabriel | Upgrade | O.E.M # | Gabriel | Upgrade |
|---------|---------|---------|---------|---------|---------|---------|---------|---------|---------|---------|---------|
| 610513  | 85307   |         | 641521  | 85308   | 89422   | 659129  | 85303   | 89422   | 661733  | 83225   |         |
| 631237  | 85308   | 89422   | 649648  | 85308   | 89422   | 661732  | 83215   |         | 995891  | 85307   |         |

**ADVANCE MIXER**

| O.E.M #   | Gabriel | Upgrade | O.E.M #   | Gabriel | Upgrade | O.E.M #   | Gabriel | Upgrade | O.E.M # | Gabriel | Upgrade |
|-----------|---------|---------|-----------|---------|---------|-----------|---------|---------|---------|---------|---------|
| 12111 ADV | 646155  |         | 13883     | 85334   |         | 14626 ADV | 83209   |         | 680087  | 85334   |         |
| 13424 ADV | 83207   | 89407   | 13883 ADV | 85334   |         | 23458 ADV | 83112   |         |         |         |         |

**ALLCO TRAILER**

| O.E.M # | Gabriel | Upgrade | O.E.M # | Gabriel | Upgrade | O.E.M # | Gabriel | Upgrade | O.E.M # | Gabriel | Upgrade |
|---------|---------|---------|---------|---------|---------|---------|---------|---------|---------|---------|---------|
| 727602  | 83122   | 89406   |         |         |         |         |         |         |         |         |         |

**AM GENERAL**

| O.E.M # | Gabriel | Upgrade | O.E.M # | Gabriel | Upgrade | O.E.M # | Gabriel | Upgrade | O.E.M # | Gabriel | Upgrade |
|---------|---------|---------|---------|---------|---------|---------|---------|---------|---------|---------|---------|
| 3166657 | 85700   |         | 5957136 | 85700   |         | 5979484 | 85302   | 89420   |         |         |         |
| 4975501 | 85700   |         | 5969438 | 85700   |         | 5979574 | 85700   |         |         |         |         |
| 5565748 | 85700   |         | 5978712 | 85700   |         | 5982537 | 85700   |         |         |         |         |

**ARALMEX**

| Aralmex | Gabriel | Upgrade | Aralmex | Gabriel | Upgrade | Aralmex | Gabriel | Upgrade | Aralmex | Gabriel | Upgrade |
|---------|---------|---------|---------|---------|---------|---------|---------|---------|---------|---------|---------|
| 2AMG037 | G63375  |         | 3AMG007 | G63357  |         | 3AMG023 | G63421  |         | 3AMG031 | G63360  |         |
| 3AMG001 | G63355  |         | 3AMG008 | G63500  |         | 3AMG026 | G63455  |         | 3AMG032 | G63502  |         |
| 3AMG004 | G63306  |         | 3AMG009 | G63406  |         | 3AMG027 | G63426  |         | 3AMG033 | G63614  |         |
| 3AMG005 | G63359  |         | 3AMG021 | G63409  |         | 3AMG029 | G63488  |         | 3AMG034 | G63608  |         |
| 3AMG006 | G63377  |         | 3AMG022 | G63454  |         | 3AMG030 | G63818  |         | 3AMG035 | G63607  |         |

**ARVIN MERITOR**

| O.E.M # | Gabriel | Upgrade | O.E.M # | Gabriel | Upgrade | O.E.M # | Gabriel | Upgrade | O.E.M #     | Gabriel | Upgrade |
|---------|---------|---------|---------|---------|---------|---------|---------|---------|-------------|---------|---------|
| 085009  | 85009   |         | 680347  | 85732   |         | 727631  | 83304   |         | 728619      | 85007   | 89412   |
| 085014  | 85014   |         | 680464  | 85005   |         | 727635  | 83308   |         | 728621      | 85009   |         |
| 085321  | 85321   |         | 680518  | 85700   |         | 727636  | 83309   | 89446   | 728622      | 85010   |         |
| 654907  | 85000   | 89436   | 680584  | 85938   |         | 727639  | 83312   | 89409   | 728623      | 85011   |         |
| 654958  | 83164   |         | 680671  | 85708   |         | 727641  | 83314   |         | 728624      | 85012   | 89413   |
| 659016  | 83064   |         | 695172  | 85707   |         | 727645  | 83318   |         | 728625      | 85013   | 89414   |
| 659222  | 83171   |         | 695180  | 85705   |         | 727671  | 83613   |         | 728626      | 85733   |         |
| 665044  | 83209   |         | 695181  | 85707   |         | 727672  | 83242   |         | 728627      | 85313   |         |
| 665724  | 85000   | 89436   | 695214  | 85722   |         | 728601  | 85001   | 89410   | 728628      | 85314   | 89425   |
| 665746  | 85000   | 89436   | 695348  | 87018   |         | 728603  | 85003   | 89411   | 728631      | 85029   |         |
| 665760  | 85045   |         | 695406  | 695406  |         | 728604  | 85300   |         | 728632      | 85030   | 89440   |
| 665769  | 85052   |         | 727600  | 83200   |         | 728606  | 85302   | 89420   | 728635      | 85318   |         |
| 665804  | 85939   |         | 727607  | 83207   | 89407   | 728608  | 85304   |         | 728639      | 85026   | 89417   |
| 671091  | 85069   | 89455   | 727609  | 83209   |         | 728609  | 85305   |         | 728640      | 85027   | 89418   |
| 671092  | 85012   | 89413   | 727614  | 83214   |         | 728611  | 85307   |         | 728800      | 85711   |         |
| 671507  | 87015   |         | 727615  | 83215   |         | 728612  | 85308   | 89422   | 728806      | 85736   |         |
| 671707  | 85323   | 89436   | 727616  | 83216   |         | 728614  | 85310   | 89423   | 728811      | 85707   |         |
| 680102  | 85712   |         | 727619  | 83219   |         | 728615  | 85311   | 89424   | 728812      | 85705   |         |
| 680322  | 85704   |         | 727625  | 83225   |         | 728616  | 85004   |         | 7805-N-1002 | 85329   |         |
| 680331  | 85702   |         | 727628  | 83301   |         | 728617  | 85005   |         | 7805-S-1007 | 85329   |         |
| 680337  | 85708   |         | 727630  | 83303   |         | 728618  | 85006   |         |             |         |         |

**AUTOCAR**

| O.E.M #    | Gabriel | Upgrade | O.E.M #    | Gabriel | Upgrade | O.E.M #    | Gabriel | Upgrade | O.E.M #    | Gabriel | Upgrade |
|------------|---------|---------|------------|---------|---------|------------|---------|---------|------------|---------|---------|
| 03-1106460 | 85005   | 89430   | 37301-3201 | 85027   | 89418   | 60665-013  | 85965   |         | 60675-003L | 85976   |         |
| 1011839    | 83216   |         | 37301-3202 | 85026   | 89417   | 60665-025  | 85036   | 89405   |            |         |         |
| 28CFG-910  | 83216   |         | 60657-003  | 85072   |         | 60665-025L | 85036   | 89405   |            |         |         |
| 28R010     | 83216   |         | 60657-003L | 85072   |         | 60670-005  | 83137   |         |            |         |         |
| 35901-3201 | 85024   |         | 60665-011  | 85967   |         | 60675-003  | 85976   |         |            |         |         |

**Important Note:** Competitive Interchanges are to be used for stocking purposes only. Where multiple crosses are identified, please reference the applications section of this catalog. / **Remarque importante:** Les interchanges concurrentiels ne s'utilisent qu'aux fins de stocks. Dans le cas de références multiples, consulter la section des applications du catalogue. / **Nota importante:** Dans le cas de références multiples, consulter la section des applications du catalogue. / **Nota importante:** Se pueden usar intercambios competitivos para propósitos de almacenamiento solamente. Cuando se identifican intercambios múltiples, consulte la sección de aplicaciones de este catálogo.

# COMPETITIVE & O.E.M. INTERCHANGE LIST

## Lista de Intercambios contra Competidores y Equipo Original.

### Liste d'interchange de produits compétitifs & d'équipement original (OEM)

#### AUTOCAR... cont'd

| O.E.M #    | Gabriel | Upgrade | O.E.M #    | Gabriel | Upgrade | O.E.M # | Gabriel | Upgrade | O.E.M # | Gabriel | Upgrade |
|------------|---------|---------|------------|---------|---------|---------|---------|---------|---------|---------|---------|
| 60680-003  | 83112   |         | 60680-004L | 83143   |         | 660186  | 83216   |         | 8026658 | 85046   | 89434   |
| 60680-003L | 83112   |         | 60680-005  | 83142   |         | 800670  | 85060   |         | 8071524 | 85024   |         |
| 60680-004  | 83143   |         | 60680-005L | 83142   |         | 800781  | 85314   | 89425   | 849246  | 83216   |         |

#### BATCO

| Batco   | Gabriel | Upgrade | Batco   | Gabriel | Upgrade | Batco   | Gabriel | Upgrade | Batco   | Gabriel | Upgrade |
|---------|---------|---------|---------|---------|---------|---------|---------|---------|---------|---------|---------|
| 1083203 | 83203   | 89436   | 1083225 | 83225   |         | 1085005 | 85005   | 89430   | 1085311 | 85311   | 89424   |
| 1083204 | 83204   |         | 1083310 | 83221   |         | 1085007 | 85007   | 89412   | 1087001 | 85734   |         |
| 1083207 | 83207   | 89407   | 1083317 | 83317   |         | 1085300 | 85300   | 89419   | 1087004 | 85735   |         |
| 1083209 | 83209   | 89414   | 1085003 | 85003   | 89411   | 1085305 | 85305   |         | 1087006 | 85736   |         |

#### BECK BUS

| O.E.M #  | Gabriel | Upgrade | O.E.M #   | Gabriel | Upgrade | O.E.M # | Gabriel | Upgrade | O.E.M # | Gabriel | Upgrade |
|----------|---------|---------|-----------|---------|---------|---------|---------|---------|---------|---------|---------|
| 14QK-140 | 85304   |         | 14QK-2102 | 85304   |         |         |         |         |         |         |         |

#### BENSON TRUCK BODIES INC.

| O.E.M #  | Gabriel | Upgrade | O.E.M # | Gabriel | Upgrade | O.E.M # | Gabriel | Upgrade | O.E.M # | Gabriel | Upgrade |
|----------|---------|---------|---------|---------|---------|---------|---------|---------|---------|---------|---------|
| 90044089 | 83124   | 89407   | A-20002 | 85000   | 89436   |         |         |         |         |         |         |

#### BERING TRUCK CORP.

| O.E.M #  | Gabriel | Upgrade | O.E.M # | Gabriel | Upgrade | O.E.M # | Gabriel | Upgrade | O.E.M # | Gabriel | Upgrade |
|----------|---------|---------|---------|---------|---------|---------|---------|---------|---------|---------|---------|
| 47902-24 | 83137   |         |         |         |         |         |         |         |         |         |         |

#### BERKSHIRE COACH

| O.E.M #  | Gabriel | Upgrade | O.E.M #  | Gabriel | Upgrade | O.E.M # | Gabriel | Upgrade | O.E.M # | Gabriel | Upgrade |
|----------|---------|---------|----------|---------|---------|---------|---------|---------|---------|---------|---------|
| ASH-1136 | 83178   |         | ASH-1154 | 83177   |         |         |         |         |         |         |         |

#### BILSTEIN

| Bilstein | Gabriel | Upgrade | Bilstein | Gabriel | Upgrade | Bilstein | Gabriel | Upgrade | Bilstein | Gabriel | Upgrade |
|----------|---------|---------|----------|---------|---------|----------|---------|---------|----------|---------|---------|
| B46-1594 | 85013   | 89414   | B46-1725 | 85029   |         | B46-2151 | 85007   | 89412   |          |         |         |

#### BLUEBIRD SCHOOL BUS

| O.E.M #  | Gabriel | Upgrade | O.E.M #      | Gabriel | Upgrade | O.E.M #    | Gabriel | Upgrade | O.E.M #       | Gabriel | Upgrade |
|----------|---------|---------|--------------|---------|---------|------------|---------|---------|---------------|---------|---------|
| 00085991 | 85006   |         | 1707405      | 85005   | 89430   | 58913-008  | 85959   |         | 70317         |         | 89402   |
| 00119797 | 85959   |         | 1722214      | 85030   | 89440   | 58913-008L | 85959   |         | 70397         | 85006   |         |
| 00119798 | 85106   |         | 1722222      | 85013   | 89414   | 58913-009  | 85959   |         | 7805-M-1001   | 85919   |         |
| 0014605  | 85036   | 89405   | 1746163      | 85006   |         | 58913-009L | 85959   |         | 7805-N-1002   | 85329   |         |
| 0014985  | 83137   |         | 1750793      | 85712   |         | 58913-010  | 85106   |         | 7805-S-1007   | 85329   |         |
| 0015222  | 85919   |         | 1962422      | 85304   |         | 58913-010L | 85106   |         | 87001-01A     | 85734   |         |
| 0020326  | 85976   |         | 1962430      | 83207   | 89407   | 58913-011  | 85959   |         | 8C24-18045-DA | 83177   |         |
| 0040015  | 85919   |         | 2021459      | 85012   | 89413   | 58913-011L | 85959   |         | 8C24-18080-DB | 83178   |         |
| 0055008  | 85959   |         | 23106-01     | 85975   |         | 59057-001  | 83137   |         | 8C2Z-18124-D  | 83177   |         |
| 0055017  | 85959   |         | 300-0614966  | 85307   |         | 59057-002  | 85036   | 89405   | 8C2Z-18125-D  | 83178   |         |
| 0075916  | 85086   |         | 300-0614974  | 85304   |         | 59483-000  | 85919   |         | 90-1813       | 85712   |         |
| 0085990  | 85959   |         | 300-0823047  | 85736   |         | 60665-005  | 85919   |         | 90-1951-SP1   | 85734   |         |
| 0088035  | 85090   |         | 300-0823054  | 85304   |         | 60665-005L | 85919   |         | 90-1968       | 85712   |         |
| 0106303  | 85106   |         | 300-09612284 | 85734   |         | 609180     | 85304   |         | 90-1968-SP1   | 85712   |         |
| 0110808  | 83124   | 89407   | 300-1316546  | 85006   |         | 60998-001  | 85006   |         | 90-2610 SP1   | 87017   |         |
| 0523047  | 85736   |         | 300-1317767  | 85029   |         | 60998-002  | 85919   |         | 90044448      | 85051   |         |
| 0823054  | 85304   |         | 303-1350628  | 85712   |         | 60998-002L | 85919   |         | 90044915      | 83127   |         |
| 1004167  | 85712   |         | 305-0961284  | 85734   |         | 60998-003  | 85006   |         | 90045050      | 85914   |         |
| 1217934  | 85304   |         | 471700000428 | 85006   |         | 614958     | 85307   |         | 90045083      | 85910   |         |
| 1260008  | 87017   |         | 471700000456 | 85959   |         | 614966     | 85307   |         | A-4890        | 85712   |         |
| 1316546  | 85006   |         | 471700000464 | 85090   |         | 614974     | 85304   |         | AMS65109      | 85058   | 89431   |
| 1317767  | 85029   |         | 471700002919 | 85106   |         | 65992-003  | 85959   |         | AMS65110      | 85005   | 89430   |
| 1526417  | 85052   |         | 471700131545 | 85006   |         | 65992-004  | 85106   |         | AMS65119      | 85029   |         |
| 1658525  | 85971   |         | 4759272      |         | 89447   | 671933     | 85919   |         | ASH-1136      | 83178   |         |
| 1658533  | 85010   |         | 4760958      | 85086   |         | 680102     | 85712   |         | ASH-1154      | 83177   |         |
| 1667831  | 85029   |         | 481700131438 | 85919   |         | 680155     | 85712   |         | AT-163G       | 83177   |         |
| 1668722  | 85030   | 89440   | 58913-007    | 85959   |         | 680667     |         | 89447   | AT-164G       | 83178   |         |
| 1668730  | 85013   | 89414   | 58913-007L   | 85959   |         | 680783     | 85304   |         |               |         |         |

**Important Note:** Competitive Interchanges are to be used for stocking purposes only. Where multiple crosses are identified, please reference the applications section of this catalog. / **Remarque importante:** Les interchanges concurrentiels ne s'utilisent qu'aux fins de stocks. Dans le cas de références multiples, consulter la section des applications du catalogue. / **Nota importante:** Dans le cas de referencias multiples, consultar la sección de aplicaciones del catálogo. / **Nota importante:** Se pueden usar intercambios competitivos para propósitos de almacenamiento solamente. Cuando se identifican intercambios múltiples, consulte la sección de aplicaciones de este catálogo.

**COMPETITIVE & O.E.M. INTERCHANGE LIST**  
**Lista de Intercambios contra Competidores y Equipo Original.**  
**Liste d'interchange de produits compétitifs & d'équipement original (OEM)**

**BOGE**

| Boge     | Gabriel | Upgrade | Boge | Gabriel | Upgrade | Boge | Gabriel | Upgrade | Boge | Gabriel | Upgrade |
|----------|---------|---------|------|---------|---------|------|---------|---------|------|---------|---------|
| 40-A85-0 | 85708   |         |      |         |         |      |         |         |      |         |         |

**BOYDSTUN EQUIPMENT MANUFACTURING**

| O.E.M #     | Gabriel | Upgrade | O.E.M # | Gabriel | Upgrade | O.E.M # | Gabriel | Upgrade | O.E.M # | Gabriel | Upgrade |
|-------------|---------|---------|---------|---------|---------|---------|---------|---------|---------|---------|---------|
| 1253069B000 | 85005   | 89430   |         |         |         |         |         |         |         |         |         |

**BROCKWAY SCHOOL BUS**

| O.E.M #     | Gabriel | Upgrade | O.E.M # | Gabriel | Upgrade | O.E.M # | Gabriel | Upgrade | O.E.M # | Gabriel | Upgrade |
|-------------|---------|---------|---------|---------|---------|---------|---------|---------|---------|---------|---------|
| 14QK-281P10 | 85305   |         | 152398  | 85304   |         | 515231  | 85303   | 89422   |         |         |         |
| 14QK-282P1  | 83216   |         | 152412  | 83215   |         | 530873  | 83207   | 89407   |         |         |         |
| 14QK-282P3  | 83216   |         | 508657  | 85307   |         | 532397  | 85307   |         |         |         |         |

**BUILT RITE**

| O.E.M #    | Gabriel | Upgrade | O.E.M # | Gabriel | Upgrade | O.E.M # | Gabriel | Upgrade | O.E.M # | Gabriel | Upgrade |
|------------|---------|---------|---------|---------|---------|---------|---------|---------|---------|---------|---------|
| 318-06-100 | 85006   |         |         |         |         |         |         |         |         |         |         |

**BUS & TRUCK CO.**

| O.E.M #  | Gabriel | Upgrade | O.E.M # | Gabriel | Upgrade | O.E.M # | Gabriel | Upgrade | O.E.M # | Gabriel | Upgrade |
|----------|---------|---------|---------|---------|---------|---------|---------|---------|---------|---------|---------|
| 0100-905 | 85307   |         | 680091  | 85303   | 89422   | 70039   | 85303   | 89422   | 70041   | 85305   |         |

**CARPENTER BUS**

| O.E.M #  | Gabriel | Upgrade | O.E.M # | Gabriel | Upgrade | O.E.M # | Gabriel | Upgrade | O.E.M # | Gabriel | Upgrade |
|----------|---------|---------|---------|---------|---------|---------|---------|---------|---------|---------|---------|
| 0272-SS5 | 85712   |         | 63-0001 | 85713   |         |         |         |         |         |         |         |

**CASCADE TRAILER**

| O.E.M # | Gabriel | Upgrade | O.E.M # | Gabriel | Upgrade | O.E.M # | Gabriel | Upgrade | O.E.M # | Gabriel | Upgrade |
|---------|---------|---------|---------|---------|---------|---------|---------|---------|---------|---------|---------|
| 120-1   | 83125   |         |         |         |         |         |         |         |         |         |         |

**CATERPILLAR**

| O.E.M #   | Gabriel | Upgrade | O.E.M #    | Gabriel | Upgrade | O.E.M #   | Gabriel | Upgrade | O.E.M #    | Gabriel | Upgrade |
|-----------|---------|---------|------------|---------|---------|-----------|---------|---------|------------|---------|---------|
| 60680-004 | 83143   |         | 60680-004L | 83143   |         | 60680-005 | 83142   |         | 60680-005L | 83142   |         |

**CHALLENGE**

| O.E.M # | Gabriel | Upgrade | O.E.M # | Gabriel | Upgrade | O.E.M # | Gabriel | Upgrade | O.E.M # | Gabriel | Upgrade |
|---------|---------|---------|---------|---------|---------|---------|---------|---------|---------|---------|---------|
| 632147  | 632147  |         | 632155  | 646177  |         |         |         |         |         |         |         |

**CHALLENGE COOK**

| O.E.M # | Gabriel | Upgrade | O.E.M # | Gabriel | Upgrade | O.E.M # | Gabriel | Upgrade | O.E.M # | Gabriel | Upgrade |
|---------|---------|---------|---------|---------|---------|---------|---------|---------|---------|---------|---------|
| 1540212 | 646155  |         | 1540459 | 646155  |         | 632147  | 632147  |         | 632155  | 646177  |         |

**CHALMERS SUSPENSION**

| O.E.M # | Gabriel | Upgrade | O.E.M # | Gabriel | Upgrade | O.E.M # | Gabriel | Upgrade | O.E.M # | Gabriel | Upgrade |
|---------|---------|---------|---------|---------|---------|---------|---------|---------|---------|---------|---------|
| 21335   | G63355  |         | 800781  | 85314   | 89425   | K880247 | 85060   |         |         |         |         |
| 665174  | 85060   |         | K800199 | 85060   |         | K880248 | 85314   | 89425   |         |         |         |
| 800670  | 85060   |         | K880233 | 85060   |         | K880642 | 85060   |         |         |         |         |

**CHAMPION BUS INC**

| O.E.M #  | Gabriel | Upgrade | O.E.M #  | Gabriel | Upgrade | O.E.M #  | Gabriel | Upgrade | O.E.M #  | Gabriel | Upgrade |
|----------|---------|---------|----------|---------|---------|----------|---------|---------|----------|---------|---------|
| 22064230 | 83136   |         | 22064231 | 85324   |         | ASH-1136 | 83178   |         | ASH-1154 | 83177   |         |

**CHANCE COACH**

| O.E.M #  | Gabriel | Upgrade | O.E.M # | Gabriel | Upgrade | O.E.M # | Gabriel | Upgrade | O.E.M # | Gabriel | Upgrade |
|----------|---------|---------|---------|---------|---------|---------|---------|---------|---------|---------|---------|
| 2021459  | 85012   | 89413   | 59039   | 83207   | 89407   | 6892    | 83207   | 89407   | 728600  | 83203   | 89436   |
| 270-6708 | 85014   |         | 665017  | 85014   |         | 6893    | 83203   | 89436   | AS789B  | 85014   |         |

**CHEVROLET TRUCK (Also See GMC Truck)**

| O.E.M #       | Gabriel | Upgrade | O.E.M #  | Gabriel | Upgrade | O.E.M #  | Gabriel | Upgrade | O.E.M #  | Gabriel | Upgrade |
|---------------|---------|---------|----------|---------|---------|----------|---------|---------|----------|---------|---------|
| 1-51630-168-1 | 83515   |         | 15588554 | 83136   |         | 22007703 | 83303   |         | 22012114 | 85700   |         |
| 1-51630-217-0 | 83114   |         | 15642943 | 83136   |         | 22007750 | 83207   | 89407   | 22012131 | 85711   |         |
| 1-51630-217-1 | 83114   |         | 15740554 | 83137   |         | 22007751 | 83303   |         | 22012166 | 83126   | 89430   |
| 1-51630-219-1 | 83114   |         | 15887728 | 83136   |         | 22007752 | 83304   |         | 22012169 | 83221   |         |
| 12474915      | 83122   | 89406   | 15963161 | 83122   | 89406   | 22007753 | 83303   |         | 22017530 | 83303   |         |
| 12474917      | 83137   |         | 19152843 | 83136   |         | 22012065 | 85304   |         | 22017531 | 83303   |         |
| 15123676      | 83136   |         | 21998392 | 85336   |         | 22012067 | 85700   |         | 22024673 | 85710   |         |
| 15174898      | 83136   |         | 22002293 | 83126   | 89430   | 22012082 | 85702   |         | 22045526 | 85702   |         |
| 15174901      | 85342   |         | 22002294 | 83304   |         | 22012083 | 85711   |         | 22046481 | 85702   |         |
| 15174902      | 85071   |         | 22002295 | 83303   |         | 22012090 | 85308   | 89422   |          |         |         |
| 15174903      | 85342   |         | 22007700 | 83207   | 89407   | 22012091 | 85303   | 89422   |          |         |         |
| 15185643      | 83153   |         | 22007701 | 83126   | 89430   | 22012095 | 83126   | 89430   |          |         |         |
| 15185644      | 83155   |         | 22007702 | 83304   |         | 22012096 | 83221   |         |          |         |         |

**Important Note:** Competitive Interchanges are to be used for stocking purposes only. Where multiple crosses are identified, please reference the applications section of this catalog. / **Remarque importante:** Les interchanges concurrentiels ne s'utilisent qu'aux fins de stocks. Dans le cas de références multiples, consulter la section des applications du catalogue. / **Nota importante:** Dans le cas de références multiples, consulter la section des applications du catalogue. / **Nota importante:** Se pueden usar intercambios competitivos para propósitos de almacenamiento solamente. Cuando se identifican intercambios múltiples, consulte la sección de aplicaciones de este catálogo.



**COMPETITIVE & O.E.M. INTERCHANGE LIST**  
**Lista de Intercambios contra Competidores y Equipo Original.**  
**Liste d'interchange de produits compétitifs & d'équipement original (OEM)**

**CHEVROLET TRUCK (Also See GMC Truck)... cont'd**

| O.E.M #  | Gabriel | Upgrade | O.E.M # | Gabriel | Upgrade | O.E.M # | Gabriel | Upgrade | O.E.M #       | Gabriel | Upgrade |
|----------|---------|---------|---------|---------|---------|---------|---------|---------|---------------|---------|---------|
| 22046483 | 85304   |         | 4940627 | 83203   | 89436   | 5374779 | 85308   | 89422   | 5552209       | 83215   |         |
| 22046485 | 85710   |         | 4940640 | 83216   |         | 5374999 | 85307   |         | 5552210       | 85308   | 89422   |
| 22046489 | 85303   | 89422   | 4940650 | 83207   | 89407   | 5385939 | 85307   |         | 5552244       | 85308   | 89422   |
| 22046499 | 85710   |         | 4940654 | 83216   |         | 5392387 | 85303   | 89422   | 5552285       | 83214   |         |
| 2204683  | 85304   |         | 4940660 | 83207   | 89407   | 5394448 | 85305   |         | 5552286       | 83217   |         |
| 22052014 | 85702   |         | 4940662 | 83126   | 89430   | 5394467 | 85305   |         | 5552287       | 83217   |         |
| 22052336 | 85304   |         | 4963844 | 85307   |         | 5394468 | 85735   |         | 5552288       | 83217   |         |
| 22052424 | 85710   |         | 4963853 | 83216   |         | 5455798 | 85307   |         | 5552451       | 85308   | 89422   |
| 22064230 | 83136   |         | 4963854 | 83216   |         | 5513489 | 83216   |         | 5552452       | 85303   | 89422   |
| 22064231 | 85324   |         | 4964853 | 83217   |         | 5513716 | 85304   |         | 5552453       | 85301   |         |
| 22064232 | 85071   |         | 4974401 | 85700   |         | 5516459 | 85305   |         | 5552456       | 85307   |         |
| 22064233 | 83136   |         | 4975429 | 85300   | 89419   | 5522781 | 85735   |         | 5552527       | 85735   |         |
| 22064432 | 85050   |         | 4975467 | 83207   | 89407   | 5522794 | 85308   | 89422   | 5552552       | 85303   | 89422   |
| 22064489 | 85336   |         | 4975479 | 83400   |         | 5522818 | 85305   |         | 5554184       | 85302   | 89420   |
| 22064804 | 83136   |         | 4975480 | 83400   |         | 5527001 | 85300   | 89419   | 5554589       | 85307   |         |
| 22064805 | 83136   |         | 4975494 | 83207   | 89407   | 5527271 | 85700   |         | 5554596       | 85303   | 89422   |
| 22064806 | 83136   |         | 4975497 | 83126   | 89430   | 5527272 | 85700   |         | 5554814       | 85302   | 89420   |
| 22064807 | 83136   |         | 4975510 | 83221   |         | 5527606 | 85305   |         | 5554959       | 83401   |         |
| 22065218 | G63347  |         | 4975516 | 85702   |         | 5531027 | 85301   |         | 5554995       | 85305   |         |
| 22065251 | 85030   | 89440   | 4975518 | 85704   |         | 5531435 | 85307   |         | 5559363       | 83203   | 89436   |
| 22099889 | 85336   |         | 4975538 | 85700   |         | 5531436 | 85307   |         | 5585939       | 85307   |         |
| 22165187 | 83136   |         | 4975549 | 83216   |         | 5531437 | 85307   |         | 684280        | 83209   | 89414   |
| 22165188 | 83136   |         | 4975550 | 85702   |         | 5532026 | 85304   |         | 8-94057-593-0 | 83114   |         |
| 22165189 | 83136   |         | 4984526 | 83216   |         | 5532425 | 83207   | 89407   | 8-94454-986-0 | 83515   |         |
| 22166442 | 83136   |         | 507-22  | 85342   |         | 5532433 | 83207   | 89407   | 8-94454-987-0 | 83515   |         |
| 3171068  | 83216   |         | 507-23  | 85342   |         | 5532675 | 85307   |         | 8-97201-960-0 | 83515   |         |
| 3171069  | 85304   |         | 507-24  | 85336   |         | 5534430 | 85303   | 89422   | 88963409      | 85336   |         |
| 3171462  | 83126   | 89430   | 507-3   | 85307   |         | 5534439 | 85304   |         | 88982682      | 83136   |         |
| 3171696  | 85307   |         | 508-86  | 83136   |         | 5534447 | 85303   | 89422   | 88982684      | 83136   |         |
| 3172948  | 85303   | 89422   | 508-88  | 83153   |         | 5544060 | 85302   | 89420   | 88982685      | 85342   |         |
| 3175509  | 85735   |         | 508-89  | 83155   |         | 5544112 | 83216   |         | 88982686      | 85071   |         |
| 3178157  | 85700   |         | 5171068 | 83216   |         | 5544581 | 85302   | 89420   | 88982687      | 85342   |         |
| 3178233  | 85734   |         | 5316784 | 85700   |         | 5544716 | 85304   |         | 88982688      | 85336   |         |
| 3178507  | 85700   |         | 5316791 | 83219   |         | 5544717 | 85304   |         | 9-51630-647-1 | 83515   |         |
| 3178995  | 85700   |         | 5316792 | 85305   |         | 5544812 | 83308   |         | 9-51630-666-0 | 85012   | 89413   |
| 3188626  | 85300   | 89419   | 5316793 | 85305   |         | 5544818 | 85735   |         | 9-51630-666-2 | 85012   | 89413   |
| 3188729  | 85303   | 89422   | 5321920 | 85307   |         | 5549899 | 83207   | 89407   | 94033786      | 83114   |         |
| 3192657  | 83216   |         | 5321929 | 85307   |         | 5549924 | 85700   |         | 94051090      | 83114   |         |
| 3192890  | 83126   | 89430   | 5348631 | 83203   | 89436   | 5549925 | 85304   |         | 94057593      | 83114   |         |
| 3192892  | 83221   |         | 5352858 | 85305   |         | 5552111 | 85304   |         | 94454987      | 83515   |         |
| 4939852  | 85308   | 89422   | 5353054 | 85303   | 89422   | 5552112 | 85307   |         | 97-2210-00164 | 85708   |         |
| 4939967  | 85308   | 89422   | 5355798 | 85307   |         | 5552114 | 83216   |         | 97-2210-00170 | 85733   |         |
| 4940600  | 83209   | 89414   | 5357955 | 85300   | 89419   | 5552205 | 83217   |         | 97083027      | 83515   |         |
| 4940601  | 83216   |         | 5357956 | 85734   |         | 5552206 | 83214   |         | 97083029      | 83515   |         |
| 4940606  | 83126   | 89430   | 5357959 | 85300   | 89419   | 5552207 | 83217   |         | 97201960      | 83515   |         |
| 4940614  | 83216   |         | 5361994 | 85734   |         | 5552208 | 83217   |         | L-12706       | 83155   |         |

**CHEVROLET TRUCK CAB SHOCKS**

| O.E.M #   | Gabriel | Upgrade | O.E.M #   | Gabriel | Upgrade | O.E.M #   | Gabriel | Upgrade | O.E.M # | Gabriel | Upgrade |
|-----------|---------|---------|-----------|---------|---------|-----------|---------|---------|---------|---------|---------|
| 1202-0012 | 83023   |         | 1202-0032 | 83016   |         | 1202-0054 | 83021   |         |         |         |         |

**CHRYSLER**

| O.E.M # | Gabriel | Upgrade | O.E.M # | Gabriel | Upgrade | O.E.M # | Gabriel | Upgrade | O.E.M # | Gabriel | Upgrade |
|---------|---------|---------|---------|---------|---------|---------|---------|---------|---------|---------|---------|
| 2961043 | G63183  |         | 3633744 | G63183  |         | 3638112 | G63183  |         |         |         |         |

**CLARK EQUIPMENT**

| O.E.M # | Gabriel | Upgrade | O.E.M # | Gabriel | Upgrade | O.E.M # | Gabriel | Upgrade | O.E.M # | Gabriel | Upgrade |
|---------|---------|---------|---------|---------|---------|---------|---------|---------|---------|---------|---------|
| 355778  | 85315   |         | 5532675 | 85307   |         | 680042  | 85301   |         |         |         |         |

**Important Note:** Competitive Interchanges are to be used for stocking purposes only. Where multiple crosses are identified, please reference the applications section of this catalog. / **Remarque importante:** Les interchanges concurrentiels ne s'utilisent qu'aux fins de stocks. Dans le cas de références multiples, consulter la section des applications du catalogue. / **Nota importante:** Dans le cas de références multiples, consulter la section des applications du catalogue. / **Nota importante:** Se pueden usar intercambios competitivos para propósitos de almacenamiento solamente. Cuando se identifican intercambios múltiples, consulte la sección de aplicaciones de este catálogo.

**COMPETITIVE & O.E.M. INTERCHANGE LIST**  
**Lista de Intercambios contra Competidores y Equipo Original.**  
**Liste d'interchange de produits compétitifs & d'équipement original (OEM)**

**CNH GLOBAL N V**

| O.E.M #  | Gabriel | Upgrade | O.E.M #  | Gabriel | Upgrade | O.E.M # | Gabriel | Upgrade | O.E.M # | Gabriel | Upgrade |
|----------|---------|---------|----------|---------|---------|---------|---------|---------|---------|---------|---------|
| 87019546 | 83022   |         | 87268250 | 83021   |         |         |         |         |         |         |         |

**COACH HOUSE RV**

| O.E.M #  | Gabriel | Upgrade | O.E.M #  | Gabriel | Upgrade | O.E.M # | Gabriel | Upgrade | O.E.M # | Gabriel | Upgrade |
|----------|---------|---------|----------|---------|---------|---------|---------|---------|---------|---------|---------|
| ASH-1136 | 83178   |         | ASH-1154 | 83177   |         |         |         |         |         |         |         |

**COACHMEN RV**

| O.E.M #       | Gabriel | Upgrade | O.E.M #       | Gabriel | Upgrade | O.E.M #   | Gabriel | Upgrade | O.E.M #        | Gabriel | Upgrade |
|---------------|---------|---------|---------------|---------|---------|-----------|---------|---------|----------------|---------|---------|
| 141700131809  | 85029   |         | 481700000493  | 85900   |         | ASH-1154  | 83177   |         | ASH-25824      | 83122   | 89406   |
| 141700131810  | 83160   |         | 66153-002     | 83124   | 89407   | ASH-1205  | 83209   | 89414   | ASH-294        | 83209   | 89414   |
| 16-16736-000  | 85029   |         | 9U94-18045-AA | 83209   | 89414   | ASH-1206  | 83122   | 89406   | AT-620         | 83209   | 89414   |
| 16-16737-000  | 83160   |         | 9U94-18080-AA | 83122   | 89406   | ASH-1228  | 83209   | 89414   | AT-621         | 83122   | 89406   |
| 16-16873-000  | 85029   |         | 9U9Z-18124-A  | 83209   | 89414   | ASH-1229  | 83209   | 89414   | AT-766         | 83209   | 89414   |
| 16-16874-000  | 83160   |         | 9U9Z-18125-A  | 83122   | 89406   | ASH-1230  | 83122   | 89406   | F4-BE5-C832-MO | 83124   | 89407   |
| 16-18103-000  | 85900   |         | ASH-1022      | 83209   | 89414   | ASH-137   | 83122   | 89406   |                |         |         |
| 1C34-18045-AA | 83209   | 89414   | ASH-1023      | 83122   | 89406   | ASH-25822 | 83209   | 89414   |                |         |         |
| 1C34-18045-JA | 83209   | 89414   | ASH-1136      | 83178   |         | ASH-25823 | 83209   | 89414   |                |         |         |

**COFAP**

| Cofap | Gabriel | Upgrade | Cofap    | Gabriel | Upgrade | Cofap   | Gabriel | Upgrade | Cofap   | Gabriel | Upgrade |
|-------|---------|---------|----------|---------|---------|---------|---------|---------|---------|---------|---------|
| 45011 | 85702   |         | 45094    | 85949   |         | 45238   | 85949   |         | L-12476 | 85074   |         |
| 45054 | 85301   |         | 45095    | 85948   |         | 45240   | 85981   |         | L-12477 | 85073   |         |
| 45056 | 85315   |         | 45096    | 85951   |         | 8482    | 85026   | 89417   | L-12488 | 85073   |         |
| 45058 | 85301   |         | 45117    | 85918   | 89449   | ATG-046 | G63457  |         | L-12590 | 85074   |         |
| 45058 | 85941   |         | 45137    | 85948   |         | ATG-051 | G63426  |         | L-12601 | 85077   |         |
| 45086 | 85949   |         | 45139C-Y | 85901   |         | ATG-081 | G63502  |         | L-12602 | 85076   |         |
| 45087 | 85943   |         | 45160    | 85946   |         | ATG-084 | G63608  |         | L-12687 | 83030   |         |
| 45089 | 85940   |         | 45174    | 85947   |         | ATG-085 | G63607  |         | L-12703 | 85071   |         |
| 45089 | 85949   |         | 45189    | 85950   |         | L-12039 | 85065   |         | L-12706 | 83155   |         |
| 45090 | 85942   |         | 45200    | 85941   |         | L-12040 | 85073   |         | L-12713 | 83136   |         |
| 45091 | 85944   |         | 45235    | 85946   |         | L-12151 | 85075   |         | L-13092 | 85073   |         |

**COLLINS BUS CORP**

| O.E.M #  | Gabriel | Upgrade | O.E.M #  | Gabriel | Upgrade | O.E.M # | Gabriel | Upgrade | O.E.M # | Gabriel | Upgrade |
|----------|---------|---------|----------|---------|---------|---------|---------|---------|---------|---------|---------|
| ASH-1136 | 83178   |         | ASH-1154 | 83177   |         |         |         |         |         |         |         |

**CONDUMEX**

| Condumex | Gabriel | Upgrade | Condumex | Gabriel | Upgrade | Condumex | Gabriel | Upgrade | Condumex | Gabriel | Upgrade |
|----------|---------|---------|----------|---------|---------|----------|---------|---------|----------|---------|---------|
| 43066    | 83309   | 89446   | 58034    | 85013   | 89414   | 69673    | 83209   | 89414   | 69748    | 85001   | 89410   |
| 43136    | 83017   |         | 58038    | 85001   | 89410   | 69680    | 83200   |         | 69750    | 85314   | 89425   |
| 43137    | 83009   |         | 58040    | 85026   | 89417   | 69685    | 83136   |         | 69752    | 85316   | 89426   |
| 43138    | 83004   |         | 58041    | 83456   |         | 69687    | 83100   |         | 69753    | 85031   |         |
| 43139    | 83021   |         | 58047    | 85381   |         | 69688    | 85302   | 89420   | 78001    | 85314   | 89425   |
| 43145    | 83021   |         | 58048    | 83137   |         | 69705    | 83122   | 89406   | 78002    | 85702   |         |
| 53010    | 83136   |         | 58049    | 85323   | 89436   | 69711    | 83207   | 89407   | 78003    | 85308   | 89422   |
| 53018    | 83317   |         | 58050    | 85061   | 89450   | 69712    | 85013   | 89414   | 78005    | 85310   | 89423   |
| 53019    | 83456   |         | 58055    | 85003   | 89411   | 69713    | 85046   | 89434   | 78007    | 85307   |         |
| 53038    | 85103   |         | 58056    | 83137   |         | 69714    | 83215   |         | 78009    | 85303   | 89422   |
| 53039    | 85006   |         | 58057    | 83456   | 89447   | 69715    | 85000   | 89436   | 78013    | 85323   | 89436   |
| 53040    | 85006   |         | 58058    | 85031   |         | 69716    | 85024   |         | 78015    | 85724   | 89443   |
| 53041    | 85310   | 89423   | 58059    | 85005   |         | 69717    | 85310   | 89423   | 78016    | 85001   | 89410   |
| 53042    | 83309   |         | 58061    | 83122   |         | 69720    | 85736   |         | 78020    | 85712   |         |
| 53043    | 83215   |         | 58061    | 85916   |         | 69725    | 85918   | 89449   | 78023    | 85705   |         |
| 53059    | 85051   |         | 58062    | 85096   |         | 69726    | 85319   |         | 78025    | 85009   |         |
| 53062    | 83009   |         | 58065    | 85949   |         | 69728    | 85055   | 89439   | 78026    | 85706   |         |
| 53063    | 83025   |         | 58067    | 85942   |         | 69729    | 85314   | 89425   | 78027    | 85314   | 89425   |
| 53065    | 83136   |         | 69500    | 83122   | 89406   | 69732    | 85300   | 89419   | 78030    | 85316   | 89426   |
| 53066    | 83124   | 89407   | 69515    | 83124   | 89407   | 69741    | 85906   |         | 78034    | 85920   |         |
| 53078    | 85940   |         | 69669    | 83123   | 89405   | 69743    | 85061   | 89450   |          |         |         |
| 53079    | 85074   |         | 69670    | 85051   |         | 69745    | 85058   | 89431   |          |         |         |
| 53080    | 83015   |         | 69671    | 85006   |         | 69746    | 83137   |         |          |         |         |
| 58012    | 85314   | 89425   | 69672    | 85043   |         | 69747    | 85003   |         |          |         |         |

**Important Note:** Competitive Interchanges are to be used for stocking purposes only. Where multiple crosses are identified, please reference the applications section of this catalog. / **Remarque importante:** Les interchanges concurrentiels ne s'utilisent qu'aux fins de stocks. Dans le cas de références multiples, consulter la section des applications du catalogue. / **Nota importante:** Dans le cas de références multiples, consulter la section des applications du catalogue. / **Nota importante:** Se pueden usar intercambios competitivos para propósitos de almacenamiento solamente. Cuando se identifican intercambios múltiples, consulte la sección aplicaciones de este catálogo.

**COMPETITIVE & O.E.M. INTERCHANGE LIST**  
**Lista de Intercambios contra Competidores y Equipo Original.**  
**Liste d'interchange de produits compétitifs & d'équipement original (OEM)**

**CONDUMEX... cont'd**

| Condumex | Gabriel | Upgrade | Condumex | Gabriel | Upgrade | Condumex | Gabriel | Upgrade | Condumex | Gabriel | Upgrade |
|----------|---------|---------|----------|---------|---------|----------|---------|---------|----------|---------|---------|
| 78039    | 85311   |         | USA53086 | 83511   |         | USA53088 | 83513   |         | USA53092 | 83509   |         |
| USA53085 | 83512   |         | USA53087 | 83506   |         | USA53091 | 83508   |         |          |         |         |

**CONTINENTAL TRAILWAYS-EAGLE INT'L**

| O.E.M #     | Gabriel | Upgrade | O.E.M # | Gabriel | Upgrade | O.E.M # | Gabriel | Upgrade | O.E.M # | Gabriel | Upgrade |
|-------------|---------|---------|---------|---------|---------|---------|---------|---------|---------|---------|---------|
| 01-0100-020 | 85307   |         | 5394467 | 85305   |         | 6-05-5  | 85307   |         | 70039   | 85303   | 89422   |
| 01-0100-905 | 85303   | 89422   | 5532026 | 85304   |         | 680091  | 85303   | 89422   | 70041   | 85305   |         |

**COUNTRY COACH**

| O.E.M # | Gabriel | Upgrade | O.E.M # | Gabriel | Upgrade | O.E.M # | Gabriel | Upgrade | O.E.M # | Gabriel | Upgrade |
|---------|---------|---------|---------|---------|---------|---------|---------|---------|---------|---------|---------|
| 89406   |         | 89406   | 89414   |         | 89414   |         |         |         |         |         |         |

**CRANE CARRIER**

| O.E.M #     | Gabriel | Upgrade | O.E.M # | Gabriel | Upgrade | O.E.M #    | Gabriel | Upgrade | O.E.M # | Gabriel | Upgrade |
|-------------|---------|---------|---------|---------|---------|------------|---------|---------|---------|---------|---------|
| 1265157B000 | 85712   |         | 277A-12 | 85304   |         | 277A-9     | 85307   |         | 680088  | 85713   |         |
| 1310002     | 665937  |         | 277A-13 | 85302   | 89420   | 60680-004  | 83143   |         | 680091  | 85303   | 89422   |
| 227A-14     | 85716   |         | 277A-14 | 85304   |         | 60680-004L | 83143   |         |         |         |         |
| 277A-1      | 85307   |         | 277A-8  | 85303   | 89422   | 64178-001  | 83143   |         |         |         |         |

**CROWN COACH**

| O.E.M # | Gabriel | Upgrade | O.E.M # | Gabriel | Upgrade | O.E.M # | Gabriel | Upgrade | O.E.M # | Gabriel | Upgrade |
|---------|---------|---------|---------|---------|---------|---------|---------|---------|---------|---------|---------|
| 3188729 | 85303   | 89422   | 5532026 | 85304   |         | 5532036 | 85734   |         |         |         |         |

**CUNHA PRODUCTS OHD**

| O.E.M # | Gabriel | Upgrade | O.E.M # | Gabriel | Upgrade | O.E.M # | Gabriel | Upgrade | O.E.M # | Gabriel | Upgrade |
|---------|---------|---------|---------|---------|---------|---------|---------|---------|---------|---------|---------|
| CP-5222 | 85315   |         |         |         |         |         |         |         |         |         |         |

**CUSH CORPORATION**

| O.E.M # | Gabriel | Upgrade | O.E.M # | Gabriel | Upgrade | O.E.M # | Gabriel | Upgrade | O.E.M # | Gabriel | Upgrade |
|---------|---------|---------|---------|---------|---------|---------|---------|---------|---------|---------|---------|
| C0062-D | 85000   | 89436   | C0226   | 85064   |         | C0228   | 85005   |         |         |         |         |
| C0078   | 85000   | 89436   | C0227   | 85014   |         | C04045  | 85045   |         |         |         |         |

**DAMON MOTOR COACH**

| O.E.M #   | Gabriel | Upgrade | O.E.M #   | Gabriel | Upgrade | O.E.M #        | Gabriel | Upgrade | O.E.M #        | Gabriel | Upgrade |
|-----------|---------|---------|-----------|---------|---------|----------------|---------|---------|----------------|---------|---------|
| 24-153249 | 85125   |         | ASH-1229  | 83209   | 89414   | F4-BE5-A011-HO | 85126   |         | F4-BE5-F325-HO | 85124   |         |
| 24-153256 | 85124   |         | ASH-25822 | 83209   | 89414   | F4-BE5-A832-MO | 85125   |         | W0005662       | 85125   |         |
| 24-186537 | 85126   |         | ASH-25823 | 83209   | 89414   | F4-BE5-B492-HO | 85125   |         | W0005663       | 85124   |         |
| 24-186629 | 85125   |         | ASH-25824 | 83122   | 89406   | F4-BE5-F324-HO | 85125   |         | W0006254       | 85125   |         |

**DANA**

| O.E.M #  | Gabriel | Upgrade | O.E.M # | Gabriel | Upgrade | O.E.M # | Gabriel | Upgrade | O.E.M # | Gabriel | Upgrade |
|----------|---------|---------|---------|---------|---------|---------|---------|---------|---------|---------|---------|
| SR1VJ100 | 85078   |         |         |         |         |         |         |         |         |         |         |

**DELCO**

| Delco  | Gabriel | Upgrade | Delco  | Gabriel | Upgrade | Delco  | Gabriel | Upgrade | Delco  | Gabriel | Upgrade |
|--------|---------|---------|--------|---------|---------|--------|---------|---------|--------|---------|---------|
| 501-13 | 83318   |         | 507-7  | 85301   |         | 508-3  | 83400   |         | 508-68 | 83209   | 89414   |
| 501-74 | 83304   |         | 507-8  | 85301   |         | 508-30 | 85005   | 89430   | 508-68 | 85006   |         |
| 501-75 | 83303   |         | 507-9  | 85700   |         | 508-35 | G63306  |         | 508-70 | G63396  |         |
| 507-1  | 85304   |         | 508-13 | 85012   | 89413   | 508-35 | G63371  |         | 508-70 | G63416  |         |
| 507-10 | 85711   |         | 508-14 | 83216   |         | 508-39 | G63347  |         | 508-71 | 83314   |         |
| 507-11 | 85308   | 89422   | 508-14 | 85012   | 89413   | 508-42 | G63353  |         | 508-71 | G63398  |         |
| 507-12 | 85701   |         | 508-15 | 83216   |         | 508-42 | G63389  |         | 508-72 | G63386  |         |
| 507-13 | 85704   |         | 508-16 | 83308   | 89435   | 508-47 | G63350  |         | 508-74 | G63511  |         |
| 507-15 | 85703   |         | 508-17 | 83312   | 89409   | 508-47 | G63377  |         | 508-78 | 83400   |         |
| 507-16 | 85702   |         | 508-18 | 83309   | 89446   | 508-48 | G63409  |         | 508-79 | G63424  |         |
| 507-17 | 85304   |         | 508-19 | 83314   |         | 508-48 | G63427  |         | 508-80 | G63425  |         |
| 507-18 | 85305   |         | 508-20 | 83207   | 89407   | 508-5  | G63359  |         | 508-82 | G63410  |         |
| 507-19 | 85700   |         | 508-21 | 83214   |         | 508-5  | G63360  |         | 508-86 | 83136   |         |
| 507-2  | 85302   | 89420   | 508-22 | 83217   |         | 508-50 | G63299  |         | 508-87 | 85071   |         |
| 507-22 | 85342   |         | 508-23 | 83217   |         | 508-50 | G63907  |         | 508-88 | 83153   |         |
| 507-23 | 85342   |         | 508-23 | 83225   |         | 508-52 | G63405  |         | 508-89 | 83155   |         |
| 507-24 | 85336   |         | 508-24 | 83215   |         | 508-52 | G63419  |         | 508-9  | 85000   | 89436   |
| 507-3  | 85307   |         | 508-26 | 83203   | 89436   | 508-52 | G63492  |         |        |         |         |
| 507-4  | 85303   | 89422   | 508-26 | 85030   | 89440   | 508-56 | G63605  |         |        |         |         |
| 507-5  | 85308   | 89422   | 508-28 | 83207   | 89407   | 508-57 | 83123   | 89405   |        |         |         |
| 507-6  | 85314   | 89425   | 508-29 | 85030   | 89440   | 508-59 | G63183  |         |        |         |         |

**Important Note:** Competitive Interchanges are to be used for stocking purposes only. Where multiple crosses are identified, please reference the applications section of this catalog. / **Remarque importante:** Les interchanges concurrentiels ne s'utilisent qu'aux fins de stocks. Dans le cas de références multiples, consulter la section des applications du catalogue. / **Nota importante:** Dans le cas de références multiples, consulter la section des applications du catalogue. / **Nota importante:** Se pueden usar intercambios competitivos para propósitos de almacenamiento solamente. Cuando se identifican intercambios múltiples, consulte la sección de aplicaciones de este catálogo.

**COMPETITIVE & O.E.M. INTERCHANGE LIST**  
**Lista de Intercambios contra Competidores y Equipo Original.**  
**Liste d'interchange de produits compétitifs & d'équipement original (OEM)**

**DELCO... cont'd**

| Delco  | Gabriel | Upgrade | Delco  | Gabriel | Upgrade | Delco  | Gabriel | Upgrade | Delco  | Gabriel | Upgrade |
|--------|---------|---------|--------|---------|---------|--------|---------|---------|--------|---------|---------|
| 508-90 | 83136   |         | 550-73 | 83303   |         | 550-74 | 83304   |         | 550-77 | 83221   |         |
| 550-13 | 85005   | 89430   | 550-73 | 85005   | 89430   | 550-75 | 83303   |         |        |         |         |

**DEXTER AXLE**

| O.E.M #  | Gabriel | Upgrade | O.E.M # | Gabriel | Upgrade | O.E.M # | Gabriel | Upgrade | O.E.M # | Gabriel | Upgrade |
|----------|---------|---------|---------|---------|---------|---------|---------|---------|---------|---------|---------|
| 18165-01 | 85006   |         |         |         |         |         |         |         |         |         |         |

**DIAMOND COACH**

| O.E.M #  | Gabriel | Upgrade | O.E.M #  | Gabriel | Upgrade | O.E.M # | Gabriel | Upgrade | O.E.M # | Gabriel | Upgrade |
|----------|---------|---------|----------|---------|---------|---------|---------|---------|---------|---------|---------|
| ASH-1136 | 83178   |         | ASH-1154 | 83177   |         |         |         |         |         |         |         |

**DIAMOND T**

| O.E.M # | Gabriel | Upgrade | O.E.M # | Gabriel | Upgrade | O.E.M # | Gabriel | Upgrade | O.E.M # | Gabriel | Upgrade |
|---------|---------|---------|---------|---------|---------|---------|---------|---------|---------|---------|---------|
| 5549925 | 85304   |         |         |         |         |         |         |         |         |         |         |

**DIAMOND-REO**

| O.E.M #  | Gabriel | Upgrade | O.E.M #  | Gabriel | Upgrade | O.E.M #   | Gabriel | Upgrade | O.E.M # | Gabriel | Upgrade |
|----------|---------|---------|----------|---------|---------|-----------|---------|---------|---------|---------|---------|
| 220-55-1 | 83214   |         | 220-55-6 | 83214   |         | 220-55-8  | 83217   |         |         |         |         |
| 220-55-2 | 85304   |         | 220-55-7 | 85304   |         | 220-S5-10 | 85712   |         |         |         |         |

**DINA BUS**

| O.E.M #    | Gabriel | Upgrade | O.E.M #    | Gabriel | Upgrade | O.E.M #    | Gabriel | Upgrade | O.E.M # | Gabriel | Upgrade |
|------------|---------|---------|------------|---------|---------|------------|---------|---------|---------|---------|---------|
| 1520030010 | 83317   |         | 39380353-6 | 85716   |         | 39390340-4 | 85716   |         |         |         |         |
| 152E030030 | 85014   |         | 39390339-6 | 85307   |         |            |         |         |         |         |         |

**DODGE TRUCK**

| O.E.M # | Gabriel | Upgrade | O.E.M # | Gabriel | Upgrade | O.E.M # | Gabriel | Upgrade | O.E.M # | Gabriel | Upgrade |
|---------|---------|---------|---------|---------|---------|---------|---------|---------|---------|---------|---------|
| 2516009 | G63183  |         | 2961043 | G63183  |         | 3633744 | G63183  |         | 3638631 | G63605  |         |
| 2960707 | G63183  |         | 3633643 | G63183  |         | 3638112 | G63183  |         | 4036892 | G63605  |         |

**DUPLEX TRUCK**

| O.E.M # | Gabriel | Upgrade | O.E.M #   | Gabriel | Upgrade | O.E.M # | Gabriel | Upgrade | O.E.M # | Gabriel | Upgrade |
|---------|---------|---------|-----------|---------|---------|---------|---------|---------|---------|---------|---------|
| 59024   | 83204   |         | 7604-3371 | 83204   |         |         |         |         |         |         |         |

**DURA SUSPENSION**

| O.E.M # | Gabriel | Upgrade | O.E.M # | Gabriel | Upgrade | O.E.M # | Gabriel | Upgrade | O.E.M #   | Gabriel | Upgrade |
|---------|---------|---------|---------|---------|---------|---------|---------|---------|-----------|---------|---------|
| 1080099 | 83203   | 89436   | 59024   | 83204   |         | 665133  | 83203   | 89436   | 7604-3371 | 83204   |         |
| 12866   | 83207   | 89407   | 59030   | 83203   | 89436   | 665267  | 85029   |         | A-2212    | 85029   |         |

**DUTCHMEN RV**

| O.E.M #       | Gabriel | Upgrade | O.E.M #      | Gabriel | Upgrade | O.E.M #  | Gabriel | Upgrade | O.E.M # | Gabriel | Upgrade |
|---------------|---------|---------|--------------|---------|---------|----------|---------|---------|---------|---------|---------|
| 8C24-18045-DA | 83177   |         | 8C2Z-18124-D | 83177   |         | ASH-1136 | 83178   |         | AT-163G | 83177   |         |
| 8C24-18080-DB | 83178   |         | 8C2Z-18125-D | 83178   |         | ASH-1154 | 83177   |         | AT-164G | 83178   |         |

**DYNAMAX CORP (COUNTRY COACH)**

| O.E.M #      | Gabriel | Upgrade | O.E.M #       | Gabriel | Upgrade | O.E.M #      | Gabriel | Upgrade | O.E.M #         | Gabriel | Upgrade |
|--------------|---------|---------|---------------|---------|---------|--------------|---------|---------|-----------------|---------|---------|
| 10-13634-000 | 85918   | 89449   | 471700002809  | 85724   | 89443   | 8C2Z-18124-D | 83177   |         | AT-164G         | 83178   |         |
| 10-13760-000 | 85959   | 89503   | 471700002991  | 85959   | 89503   | 8C2Z-18125-D | 83178   |         | SDA471700002991 | 85959   | 89503   |
| 10-13809-000 | 85958   |         | 471700003920  | 85958   |         | ASH-1136     | 83178   |         |                 |         |         |
| 16-18708-000 | 85724   | 89443   | 8C24-18045-DA | 83177   |         | ASH-1154     | 83177   |         |                 |         |         |
| 471700000449 | 85918   | 89449   | 8C24-18080-DB | 83178   |         | AT-163G      | 83177   |         |                 |         |         |

**EAGLE MOTOR COACH**

| O.E.M #      | Gabriel | Upgrade | O.E.M #      | Gabriel | Upgrade | O.E.M # | Gabriel | Upgrade | O.E.M # | Gabriel | Upgrade |
|--------------|---------|---------|--------------|---------|---------|---------|---------|---------|---------|---------|---------|
| 01-0100-020  | 85307   |         | 101364       | 85305   |         | 5394467 | 85305   |         | 690060  | 85713   |         |
| 01-0100-905  | 85303   | 89422   | 12B-5-1      | 85735   |         | 5532026 | 85304   |         | 70039   | 85303   | 89422   |
| 014-0100-905 | 85308   | 89422   | 12J-5-10     | 85733   |         | 6-05-5  | 85307   |         | 70041   | 85305   |         |
| 0140100-905  | 85308   | 89422   | 154-0100-514 | 85314   | 89425   | 680091  | 85303   | 89422   |         |         |         |

**EAST MANUFACTURING CORP.**

| O.E.M #      | Gabriel | Upgrade | O.E.M #      | Gabriel | Upgrade | O.E.M #      | Gabriel | Upgrade | O.E.M #      | Gabriel | Upgrade |
|--------------|---------|---------|--------------|---------|---------|--------------|---------|---------|--------------|---------|---------|
| 517-05001-18 | 87015   |         | 517-05010-07 | 83214   |         | 517-05805-20 | 85000   | 89436   | 517-05916-14 | 83124   | 89407   |
| 517-05001-23 | 85005   | 89430   | 517-05022-07 | 83217   |         | 517-05806-20 | 85029   |         | A-20002      | 85000   | 89436   |
| 517-05006-20 | 85030   | 89440   | 517-05110-20 | 85000   | 89436   | 517-05808-20 | 85738   |         | A-20126      | 85323   | 89436   |
| 517-05009-14 | 83125   |         | 517-05511-14 | 83128   |         | 517-05809-20 |         | 89437   |              |         |         |

**ELDORADO NATIONAL**

| O.E.M #  | Gabriel | Upgrade | O.E.M #  | Gabriel | Upgrade | O.E.M # | Gabriel | Upgrade | O.E.M # | Gabriel | Upgrade |
|----------|---------|---------|----------|---------|---------|---------|---------|---------|---------|---------|---------|
| 13208701 | 85746   |         | ASH-1136 | 83178   |         |         |         |         |         |         |         |
| 13208801 | 85745   |         | ASH-1154 | 83177   |         |         |         |         |         |         |         |

**Important Note:** Competitive Interchanges are to be used for stocking purposes only. Where multiple crosses are identified, please reference the applications section of this catalog. / **Remarque importante:** Les interchanges concurrentiels ne s'utilisent qu'aux fins de stocks. Dans le cas de références multiples, consulter la section des applications du catalogue. / **Nota importante:** Dans le cas de références multiples, consulter la section des applications du catalogue. / **Nota importante:** Se pueden usar intercambios competitivos para propósitos de almacenamiento solamente. Cuando se identifican intercambios múltiples, consulte la sección de aplicaciones de este catálogo.

# COMPETITIVE & O.E.M. INTERCHANGE LIST

## Lista de Intercambios contra Competidores y Equipo Original.

### Liste d'interchange de produits compétitifs & d'équipement original (OEM)

#### ELDORADO NATIONAL... cont'd

#### ELKHART COACH

| O.E.M #  | Gabriel | Upgrade | O.E.M #  | Gabriel | Upgrade | O.E.M # | Gabriel | Upgrade | O.E.M # | Gabriel | Upgrade |
|----------|---------|---------|----------|---------|---------|---------|---------|---------|---------|---------|---------|
| ASH-1136 | 83178   |         | ASH-1154 | 83177   |         |         |         |         |         |         |         |

#### ENTEGR COACH

| O.E.M #  | Gabriel | Upgrade | O.E.M #   | Gabriel | Upgrade | O.E.M #   | Gabriel | Upgrade | O.E.M # | Gabriel | Upgrade |
|----------|---------|---------|-----------|---------|---------|-----------|---------|---------|---------|---------|---------|
| ASH-1136 | 83178   |         | ASH-1229  | 83209   | 89414   | ASH-25823 | 83209   | 89414   |         |         |         |
| ASH-1154 | 83177   |         | ASH-25822 | 83209   | 89414   | ASH-25824 | 83122   | 89406   |         |         |         |

#### EUCLID

| Euclid | Gabriel | Upgrade | Euclid | Gabriel | Upgrade | Euclid | Gabriel | Upgrade | Euclid | Gabriel | Upgrade |
|--------|---------|---------|--------|---------|---------|--------|---------|---------|--------|---------|---------|
| E14009 | 85933   | 89454   | E83219 | 83219   |         | E85005 | 85005   | 89430   | E85313 | 85313   |         |
| E14021 | 85955   |         | E83221 | 83221   |         | E85006 | 85006   |         | E85314 | 85314   | 89425   |
| E14022 | 85955   |         | E83223 | 83223   |         | E85007 | 85007   | 89412   | E85318 | 85318   |         |
| E14037 | 85967   |         | E83225 | 83225   |         | E85008 | 85008   |         | E85700 | 85700   |         |
| E14042 | 85965   |         | E83242 | 83242   |         | E85010 | 85010   |         | E85702 | 85702   |         |
| E14043 | 85966   |         | E83300 | 83300   |         | E85011 | 85011   |         | E85703 | 85703   |         |
| E14045 | 83143   |         | E83301 | 83301   |         | E85012 | 85012   | 89413   | E85704 | 85704   |         |
| E14046 | 83142   |         | E83302 | 83302   |         | E85013 | 85013   | 89414   | E85705 | 85705   |         |
| E83200 | 83200   |         | E83303 | 83303   |         | E85014 | 85014   |         | E85706 | 85706   |         |
| E83201 | 83201   |         | E83304 | 83304   |         | E85024 | 85024   |         | E85709 | 85709   |         |
| E83202 | 83202   |         | E83308 | 83308   | 89435   | E85026 | 85026   | 89417   | E85711 | 85711   |         |
| E83203 | 83203   | 89436   | E83309 | 83309   | 89446   | E85029 | 85029   |         | E85712 | 85712   |         |
| E83204 | 83204   |         | E83310 | 83221   |         | E85030 | 85030   | 89440   | E85713 | 85713   |         |
| E83205 | 83209   | 89414   | E83311 | 83311   |         | E85300 | 85300   | 89419   | E87000 | 85711   |         |
| E83206 | 83206   |         | E83312 | 83312   | 89409   | E85302 | 85302   | 89420   | E87001 | 85734   |         |
| E83207 | 83207   | 89407   | E83314 | 83314   |         | E85303 | 85303   | 89422   | E87003 | 85700   |         |
| E83209 | 83209   | 89414   | E83318 | 83318   |         | E85304 | 85304   |         | E87004 | 85735   |         |
| E83213 | 83213   |         | E83353 | 85740   |         | E85305 | 85305   |         | E87006 | 85736   |         |
| E83214 | 83214   |         | E83400 | 83400   |         | E85307 | 85307   |         | E87011 | 85707   |         |
| E83215 | 83215   |         | E83401 | 83401   |         | E85308 | 85308   | 89422   | E87012 | 85705   |         |
| E83216 | 83216   |         | E85000 | 85000   | 89436   | E85310 | 85310   | 89423   | E87013 | 85706   |         |
| E83217 | 83217   |         | E85001 | 85001   | 89410   | E85311 | 85311   | 89424   |        |         |         |
| E83218 | 83122   | 89406   | E85003 | 85003   | 89411   | E85312 | 85733   |         |        |         |         |

#### FEDERAL COACH

| O.E.M #      | Gabriel | Upgrade | O.E.M #      | Gabriel | Upgrade | O.E.M #         | Gabriel | Upgrade | O.E.M # | Gabriel | Upgrade |
|--------------|---------|---------|--------------|---------|---------|-----------------|---------|---------|---------|---------|---------|
| 10-12388-000 | 85920   | 89503   | 16-18708-000 | 85724   | 89443   | ASH-1136        | 83178   |         |         |         |         |
| 10-12390-000 | 85920   | 89503   | 471700002809 | 85724   | 89443   | ASH-1154        | 83177   |         |         |         |         |
| 10-13760-000 | 85959   | 89503   | 471700002991 | 85959   | 89503   | SDA471700002991 | 85959   | 89503   |         |         |         |

#### FLEETRITR

| Fleetrite | Gabriel | Upgrade | Fleetrite | Gabriel | Upgrade | Fleetrite | Gabriel | Upgrade | Fleetrite | Gabriel | Upgrade |
|-----------|---------|---------|-----------|---------|---------|-----------|---------|---------|-----------|---------|---------|
| AMS600101 | 85003   | 89411   | AMS600120 | G63605  |         | AMS600147 | 83216   |         | AMS600169 | 85051   |         |
| AMS600102 | 85005   | 89430   | AMS600123 | G63183  |         | AMS600148 | 85026   | 89417   | AMS600172 | 85005   | 89430   |
| AMS600103 | 85014   |         | AMS600125 | 83123   | 89405   | AMS600149 | 83217   |         | AMS600173 | 85043   |         |
| AMS600104 | 85000   | 89436   | AMS600126 | 83400   |         | AMS600150 | 85009   |         | AMS600174 | 83125   |         |
| AMS600105 | 83304   |         | AMS600127 | 83161   |         | AMS600151 | 85024   |         | AMS600175 | 83120   |         |
| AMS600106 | 83312   | 89409   | AMS600128 | 83401   |         | AMS600152 | 83242   |         | AMS600202 | 83009   |         |
| AMS600107 | 83309   | 89446   | AMS600129 | 83317   |         | AMS600153 | 85003   | 89411   | AMS650101 | 85062   | 89408   |
| AMS600108 | 83209   | 89414   | AMS600130 | 83204   |         | AMS600154 | 83104   |         | AMS650102 | 85001   | 89410   |
| AMS600109 | 83217   |         | AMS600131 | 83318   |         | AMS600155 | 83103   |         | AMS650103 | 85320   | 89429   |
| AMS600110 | 83303   |         | AMS600132 | 83215   |         | AMS600156 | 83103   |         | AMS650104 | 65104   |         |
| AMS600111 | 83301   |         | AMS600133 | 83362   |         | AMS600157 | 83221   |         | AMS650105 | 85026   | 89417   |
| AMS600112 | 83456   | 89447   | AMS600134 | 83221   |         | AMS600162 | 83103   |         | AMS650106 | 65106   |         |
| AMS600113 | 83215   |         | AMS600136 | 85740   |         | AMS600163 | 83101   |         | AMS650107 | 85316   | 89426   |
| AMS600114 | 83125   |         | AMS600138 | 83100   |         | AMS600164 | 83613   |         | AMS650108 | 85030   | 89432   |
| AMS600116 | 83216   |         | AMS600139 | 85740   |         | AMS600165 | 83636   |         |           |         |         |
| AMS600117 | 83308   | 89435   | AMS600142 | 83209   | 89414   | AMS600166 | 85052   |         |           |         |         |
| AMS600118 | 83219   |         | AMS600145 | 85040   |         | AMS600167 | 83128   |         |           |         |         |
| AMS600119 | 83314   |         | AMS600146 | 83105   |         | AMS600168 | 83635   |         |           |         |         |

**Important Note:** Competitive Interchanges are to be used for stocking purposes only. Where multiple crosses are identified, please reference the applications section of this catalog. / **Remarque importante:** Les interchanges concurrentiels ne s'utilisent qu'aux fins de stocks. Dans le cas de références multiples, consulter la section des applications du catalogue. / **Nota importante:** Dans le cas de références multiples, consulter la section des applications du catalogue. / **Nota importante:** Se pueden usar intercambios competitivos para propósitos de almacenamiento solamente. Cuando se identifican intercambios múltiples, consulte la sección de aplicaciones de este catálogo.

**COMPETITIVE & O.E.M. INTERCHANGE LIST**  
**Lista de Intercambios contra Competidores y Equipo Original.**  
**Liste d'interchange de produits compétitifs & d'équipement original (OEM)**

**FLEETRITE... cont'd**

| Fleetríte | Gabriel | Upgrade | Fleetríte | Gabriel | Upgrade | Fleetríte | Gabriel | Upgrade | Fleetríte | Gabriel | Upgrade |
|-----------|---------|---------|-----------|---------|---------|-----------|---------|---------|-----------|---------|---------|
| AMS650109 | 85058   | 89431   | AMS650440 | 85711   |         | AMS660118 | 85012   | 89413   | AMS660196 | G63610  |         |
| AMS650110 | 85005   | 89430   | AMS650441 | 85704   |         | AMS660119 | 83314   |         | AMS660197 | G63866  |         |
| AMS650111 | 85006   |         | AMS650442 | 85700   |         | AMS660120 | G63605  |         | AMS660198 | 83007   |         |
| AMS650112 | 89402   |         | AMS650443 | 85706   |         | AMS660123 | G63183  |         | AMS660200 | 83008   |         |
| AMS650113 | 85012   | 89413   | AMS650444 | 85311   | 89424   | AMS660125 | 83123   | 89405   | AMS660201 | 83308   | 89435   |
| AMS650114 | 85006   |         | AMS650445 | 85731   |         | AMS660126 | 83400   |         | AMS660202 | 83009   |         |
| AMS650115 | 85027   | 89418   | AMS650446 | 85730   |         | AMS660127 | 83161   |         | AMS660203 | 83112   |         |
| AMS650116 | 85303   | 89422   | AMS650447 | 85703   |         | AMS660128 | 83401   |         | AMS660204 | 83010   |         |
| AMS650118 | 83215   |         | AMS650448 | 85700   |         | AMS660129 | 83317   |         | AMS660205 | 83003   |         |
| AMS650119 | 85029   |         | AMS650449 | 85702   |         | AMS660130 | 83204   |         | AMS660208 | G63616  |         |
| AMS650120 | 85010   |         | AMS650451 | 85029   |         | AMS660131 | 83318   |         | AMS660209 | 83014   |         |
| AMS650121 | 89432   |         | AMS650452 | 85733   |         | AMS660132 | 83215   |         | AMS660211 | 83110   |         |
| AMS650122 | 85063   |         | AMS650453 | 85904   |         | AMS660133 | 83362   |         | AMS660212 | 83015   |         |
| AMS650123 | 85054   | 89438   | AMS650454 | 85713   |         | AMS660134 | 83221   |         | AMS660213 | 85009   |         |
| AMS650124 | 85053   | 89442   | AMS650455 | 85716   |         | AMS660136 | 85740   |         | AMS660214 | 83002   |         |
| AMS650128 | 85031   |         | AMS650456 | 85376   |         | AMS660138 | 83100   |         | AMS660215 | 85059   |         |
| AMS650129 | 85701   |         | AMS650458 | 85908   |         | AMS660142 | 83209   | 89414   | AMS660216 | 83123   | 89405   |
| AMS650130 | 85061   | 89450   | AMS650459 | 85043   |         | AMS660145 | 85040   |         | AMS660218 | 83137   |         |
| AMS650139 | 85918   | 89449   | AMS650462 | 85913   |         | AMS660146 | 83105   |         | AMS660219 | 83215   |         |
| AMS650400 | 85033   | 89427   | AMS650463 | 85040   |         | AMS660147 | 83216   |         | AMS660220 | 83109   |         |
| AMS650401 | 85013   | 89414   | AMS650464 | 85716   |         | AMS660148 | 85026   | 89417   | AMS660223 | 85055   | 89439   |
| AMS650402 | 85311   | 89424   | AMS650465 | 85914   |         | AMS660149 | 85042   |         | AMS660224 | 83111   |         |
| AMS650404 | 85310   | 89423   | AMS650466 | 85047   | 89435   | AMS660150 | G63616  |         | AMS660225 | 83200   |         |
| AMS650405 | 85023   | 89415   | AMS650468 | 85069   | 89455   | AMS660153 | 85003   | 89411   | AMS660232 | 83114   |         |
| AMS650406 | 85024   |         | AMS650471 | 85302   | 89420   | AMS660154 | 83104   |         | AMS660233 | 83023   |         |
| AMS650407 | 85736   |         | AMS650472 | 85330   |         | AMS660155 | 83103   |         | AMS660234 | 83013   |         |
| AMS650408 | 85319   | 89428   | AMS650473 | 85329   |         | AMS660157 | 85030   | 89440   | AMS660236 | 83025   |         |
| AMS650409 | 85003   | 89411   | AMS650474 | 85712   |         | AMS660160 | 83114   |         | AMS660237 | 83005   |         |
| AMS650410 | 85300   | 89419   | AMS650475 | 85065   |         | AMS660161 | G63610  |         | AMS660238 | 83101   |         |
| AMS650411 | 85036   | 89405   | AMS650478 | 85030   | 89440   | AMS660162 | 83103   |         | AMS660244 | 83125   |         |
| AMS650412 | 83122   | 89406   | AMS650479 | 83122   | 89406   | AMS660164 | 83613   |         | AMS660247 | 83116   |         |
| AMS650413 | 65413   |         | AMS650480 | 83109   |         | AMS660165 | 83636   |         | AMS660247 | 83118   |         |
| AMS650414 | 65414   |         | AMS650480 | 83111   |         | AMS660166 | 85052   |         | AMS660248 | 83117   |         |
| AMS650415 | 85046   | 89434   | AMS650481 | 83123   | 89405   | AMS660167 | 83128   |         | AMS660502 | 646155  |         |
| AMS650416 | 85323   | 89436   | AMS650482 | 85006   |         | AMS660168 | 83635   |         | AMS660504 | 632147  |         |
| AMS650417 | 85322   |         | AMS650486 | 85066   | 89448   | AMS660169 | 85051   |         | AMS700101 | 85308   | 89422   |
| AMS650418 | 85906   | 89407   | AMS65107  | 85316   | 89426   | AMS660170 | 83016   |         | AMS700102 | 85303   | 89422   |
| AMS650419 | 85000   | 89436   | AMS65109  | 85058   | 89431   | AMS660171 | 83017   |         | AMS700103 | 85302   | 89420   |
| AMS650420 | 85013   | 89414   | AMS65144  | 85957   |         | AMS660172 | 83126   | 89430   | AMS700104 | 85304   |         |
| AMS650421 | 85916   |         | AMS65146  | 85925   |         | AMS660173 | 85043   |         | AMS700105 | 85314   | 89425   |
| AMS650422 | 85912   |         | AMS65158  | 85954   |         | AMS660174 | 83125   |         | AMS700106 | 85301   |         |
| AMS650423 | 85907   |         | AMS660102 | 85005   | 89430   | AMS660175 | 83120   |         | AMS700107 | 85307   |         |
| AMS650424 | 85905   |         | AMS660103 | 85014   |         | AMS660176 | 83018   |         | AMS700108 | 85315   |         |
| AMS650425 | 89441   |         | AMS660104 | 85000   | 89436   | AMS660177 | 83019   |         | AMS700111 | 85320   | 89429   |
| AMS650426 | 85054   | 89438   | AMS660105 | 83304   |         | AMS660179 | 83162   |         | AMS700112 | 85722   |         |
| AMS650427 | 85903   |         | AMS660106 | 83312   | 89409   | AMS660182 | 83004   |         | AMS700113 | 85736   |         |
| AMS650428 | 85321   |         | AMS660107 | 83309   | 89446   | AMS660183 | 85012   | 89413   | AMS700114 | 85701   |         |
| AMS650429 | 85030   | 89440   | AMS660108 | 83209   | 89414   | AMS660187 | 85071   |         | AMS700115 | 85712   |         |
| AMS650430 | 85712   |         | AMS660109 | 83217   |         | AMS660188 | 85045   |         | AMS700116 | 83136   |         |
| AMS650431 | 85909   |         | AMS660110 | 83303   |         | AMS660189 | 83136   |         | AMS700117 | 85324   |         |
| AMS650432 | 85910   |         | AMS660111 | 83301   |         | AMS660190 | 83107   |         | AMS700119 | 85336   |         |
| AMS650433 | 85910   |         | AMS660112 | 83456   | 89447   | AMS660191 | 83216   |         | AMS700120 | 85332   |         |
| AMS650434 | 85012   | 89413   | AMS660113 | 83215   |         | AMS660192 | 85001   | 89410   | AMS700121 | 83136   |         |
| AMS650435 | 85901   |         | AMS660114 | 85006   |         | AMS660193 | 83001   |         | AMS700401 | 85700   |         |
| AMS650436 | 85900   |         | AMS660116 | 83216   |         | AMS660194 | 83207   | 89407   | AMS700402 | 85310   | 89423   |
| AMS650439 | 85732   |         | AMS660117 | 83308   | 89435   | AMS660195 | 83130   |         | AMS700403 | 85702   |         |

**Important Note:** Competitive Interchanges are to be used for stocking purposes only. Where multiple crosses are identified, please reference the applications section of this catalog. / **Remarque importante:** Les interchanges concurrentiels ne s'utilisent qu'aux fins de stocks. Dans le cas de références multiples, consulter la section des applications du catalogue. / **Nota importante:** Dans le cas de références multiples, consulter la section des applications du catalogue. / **Nota importante:** Se pueden usar intercambios competitivos para propósitos de almacenamiento solamente. Cuando se identifican intercambios múltiples, consulte la sección de aplicaciones de este catálogo.

# COMPETITIVE & O.E.M. INTERCHANGE LIST

## Lista de Intercambios contra Competidores y Equipo Original.

### Liste d'interchange de produits compétitifs & d'équipement original (OEM)

#### FLEETRITE... cont'd

| Fleetrite | Gabriel | Upgrade | Fleetrite | Gabriel | Upgrade | Fleetrite | Gabriel | Upgrade | Fleetrite | Gabriel | Upgrade |
|-----------|---------|---------|-----------|---------|---------|-----------|---------|---------|-----------|---------|---------|
| AMS700404 | 85311   | 89424   | AMS700414 | 85723   |         | AMS700424 | 85333   |         | AMS85895  | 83207   | 89407   |
| AMS700405 | 85300   | 89419   | AMS700415 | 85318   |         | AMS74421  | 85708   |         | AMS85900  | G63386  |         |
| AMS700406 | 85711   |         | AMS700416 | 85709   |         | AMS85722  | 83400   |         | AMS85901  | G63387  |         |
| AMS700407 | 85712   |         | AMS700418 | 85003   | 89411   | AMS85736  | G63394  |         | AMS85904  | G63299  |         |
| AMS700408 | 85704   |         | AMS700419 | 85708   |         | AMS85768  | 83209   | 89414   | AMS85905  | G63405  |         |
| AMS700409 | 85701   |         | AMS700420 | 85733   |         | AMS85802  | 83216   |         | AMS85909  | G63398  |         |
| AMS700410 | 85314   | 89425   | AMS700421 | 85712   |         | AMS85803  | G63306  |         | AMS85932  | G63398  |         |
| AMS700411 | 85703   |         | AMS700422 | 85308   | 89422   | AMS85821  | G63406  |         | AMS85960  | G63366  |         |
| AMS700413 | 85705   | 89447   | AMS700423 | 85724   | 89443   | AMS85853  | G63183  |         |           |         |         |

#### FLEETWOOD RV

| O.E.M #       | Gabriel | Upgrade | O.E.M #       | Gabriel | Upgrade | O.E.M #   | Gabriel | Upgrade | O.E.M #        | Gabriel | Upgrade |
|---------------|---------|---------|---------------|---------|---------|-----------|---------|---------|----------------|---------|---------|
| 141700131809  | 85029   |         | 24-186537     | 85126   |         | ASH-1205  | 83209   | 89414   | AT-621         | 83122   | 89406   |
| 141700131810  | 83160   |         | 24-186629     | 85125   |         | ASH-1206  | 83122   | 89406   | AT-766         | 83209   | 89414   |
| 16-16736-000  | 85029   |         | 481700000493  | 85900   |         | ASH-1228  | 83209   | 89414   | F4-BE5-A011-HO | 85126   |         |
| 16-16737-000  | 83160   |         | 9U94-18045-AA | 83209   | 89414   | ASH-1229  | 83209   | 89414   | F4-BE5-A832-MO | 85125   |         |
| 16-16873-000  | 85029   |         | 9U94-18080-AA | 83122   | 89406   | ASH-1230  | 83122   | 89406   | F4-BE5-B492-HO | 85125   |         |
| 16-16874-000  | 83160   |         | 9U9Z-18124-A  | 83209   | 89414   | ASH-137   | 83122   | 89406   | F4-BE5-F324-HO | 85125   |         |
| 16-18103-000  | 85900   |         | 9U9Z-18125-A  | 83122   | 89406   | ASH-25822 | 83209   | 89414   | F4-BE5-F325-HO | 85124   |         |
| 1C34-18045-AA | 83209   | 89414   | ASH-1022      | 83209   | 89414   | ASH-25823 | 83209   | 89414   | W0005662       | 85125   |         |
| 1C34-18045-JA | 83209   | 89414   | ASH-1023      | 83122   | 89406   | ASH-25824 | 83122   | 89406   | W0005663       | 85124   |         |
| 24-153249     | 85125   |         | ASH-1136      | 83178   |         | ASH-294   | 83209   | 89414   | W0006254       | 85125   |         |
| 24-153256     | 85124   |         | ASH-1154      | 83177   |         | AT-620    | 83209   | 89414   |                |         |         |

#### FLUIDRIVE

| O.E.M # | Gabriel | Upgrade | O.E.M # | Gabriel | Upgrade | O.E.M # | Gabriel | Upgrade | O.E.M # | Gabriel | Upgrade |
|---------|---------|---------|---------|---------|---------|---------|---------|---------|---------|---------|---------|
| 2697    | 85712   |         |         |         |         |         |         |         |         |         |         |

#### FLXIBLE BUS

| O.E.M #       | Gabriel | Upgrade | O.E.M #  | Gabriel | Upgrade | O.E.M #       | Gabriel | Upgrade | O.E.M #       | Gabriel | Upgrade |
|---------------|---------|---------|----------|---------|---------|---------------|---------|---------|---------------|---------|---------|
| 015813        | 85708   |         | 6-05-6   | 85736   |         | 87-2519-00001 | 85703   |         | 97-2210-00009 | 85704   |         |
| 06-0367-00151 | 85700   |         | 6-05-7   | 85736   |         | 87-2519-00002 | 85731   |         | 97-2210-00011 | 85704   |         |
| 06-0367-00156 | 85702   |         | 6-05-8   | 85736   |         | 87-2519-00003 | 85703   |         | 97-2210-00156 | 85702   |         |
| 22012067      | 85700   |         | 6-05-9   | 85304   |         | 87-2519-00004 | 85731   |         | 97-2210-00157 | 85708   |         |
| 22012114      | 85700   |         | 6-367-1  | 85711   |         | 87-2520-00001 | 85704   |         | 97-2210-00160 | 85705   | 89447   |
| 22024061      | 85704   |         | 6-367-11 | 85711   |         | 87-2520-00003 | 85704   |         | 97-2210-00164 | 85708   |         |
| 22024506      | 85703   |         | 6-367-12 | 85700   |         | 97-2201-00001 | 85703   |         | 97-2210-00170 | 85733   |         |
| 22025066      | 85703   |         | 6-367-14 | 85700   |         | 97-2201-00002 | 85703   |         | 97-9999-00732 | 85707   |         |
| 22025067      | 85704   |         | 6-367-16 | 85700   |         | 97-2201-00003 | 85703   |         | 97-9999-00807 | 85307   |         |
| 22025305      | 85704   |         | 6-367-17 | 85700   |         | 97-2201-00004 | 85703   |         | 97-9999-02514 | 85700   |         |
| 3166657       | 85700   |         | 6-367-2  | 85736   |         | 97-2201-00005 | 85703   |         | 97-9999-02515 | 85702   |         |
| 3192333       | 85700   |         | 6-367-3  | 85304   |         | 97-2201-00006 | 85703   |         | 97-9999-02519 | 85707   |         |
| 48-1-239      | 85736   |         | 6-367-4  | 83217   |         | 97-2201-00007 | 85703   |         | 97-9999-02592 | 85710   |         |
| 48-1-241      | 85712   |         | 6-367-6  | 85711   |         | 97-2201-00008 | 85731   |         | 97-9999-02595 | 85313   |         |
| 4975518       | 85704   |         | 6-367-7  | 85305   |         | 97-2201-00009 | 85703   |         | 97-9999-02632 | 85711   |         |
| 6-05-1        | 85736   |         | 6-367-8  | 85700   |         | 97-2201-00151 | 85700   |         | 97-9999-02633 | 85311   | 89424   |
| 6-05-10       | 85734   |         | 6-367-9  | 85711   |         | 97-2210-00001 | 85704   |         | 97-9999-02634 | 85733   |         |
| 6-05-13       | 85304   |         | 680029   | 85301   |         | 97-2210-00002 | 85704   |         | 97-9999-02635 | 85732   |         |
| 6-05-2        | 85736   |         | 680155   | 85712   |         | 97-2210-00003 | 85704   |         | 97-9999-02636 | 85716   |         |
| 6-05-3        | 85736   |         | 680320   | 85703   |         | 97-2210-00004 | 85704   |         |               |         |         |
| 6-05-4        | 85736   |         | 695125   | 85704   |         | 97-2210-00005 | 85704   |         |               |         |         |
| 6-05-5        | 85307   |         | 74412    | 85704   |         | 97-2210-00006 | 85704   |         |               |         |         |

#### FLYER INDUSTRIES

| O.E.M # | Gabriel | Upgrade | O.E.M #  | Gabriel | Upgrade | O.E.M # | Gabriel | Upgrade | O.E.M #  | Gabriel | Upgrade |
|---------|---------|---------|----------|---------|---------|---------|---------|---------|----------|---------|---------|
| 009863  | 85722   |         | 22012067 | 85700   |         | 3192333 | 85700   |         | 592-6568 | 85700   |         |
| 015915  | 85711   |         | 22012114 | 85700   |         | 4975501 | 85700   |         | 5979574  | 85700   |         |
| 15813   | 85708   |         | 3166657  | 85700   |         | 4975552 | 85711   |         |          |         |         |

**Important Note:** Competitive Interchanges are to be used for stocking purposes only. Where multiple crosses are identified, please reference the applications section of this catalog. / **Remarque importante:** Les interchanges concurrentiels ne s'utilisent qu'aux fins de stocks. Dans le cas de références multiples, consulter la section des applications du catalogue. / **Nota importante:** Dans le cas de références multiples, consulter la section des applications du catalogue. / **Nota importante:** Se pueden usar intercambios competitivos para propósitos de almacenamiento solamente. Cuando se identifican intercambios múltiples, consulte la sección de aplicaciones de este catálogo.

**COMPETITIVE & O.E.M. INTERCHANGE LIST**  
**Lista de Intercambios contra Competidores y Equipo Original.**  
**Liste d'interchange de produits compétitifs & d'équipement original (OEM)**

**FORD**

| O.E.M #         | Gabriel | Upgrade | O.E.M #         | Gabriel | Upgrade | O.E.M #      | Gabriel | Upgrade | O.E.M #       | Gabriel | Upgrade |
|-----------------|---------|---------|-----------------|---------|---------|--------------|---------|---------|---------------|---------|---------|
| 0017LA-18080-G  | 83161   |         | 5U2Z-18V124-LA  | G63929  |         | ASH-24446    | 83215   |         | C1TZ-18124-C  | 83312   | 89409   |
| 1C34-18045-AA   | 83209   | 89414   | 5U2Z-18V125-AE  | G63808  |         | ASH-2447     | 83140   |         | C1TZ-18124-D  | 83309   | 89446   |
| 1C34-18045-JA   | 83209   | 89414   | 5U2Z-18V125-AF  | G63810  |         | ASH-24658    | 85181   |         | C1TZ-18124-E  | 83312   | 89409   |
| 1C44-18080-AA   | 83123   | 89405   | 5U2Z-18V125-BDA | G63623  |         | ASH-24659    | 85181   |         | C1TZ-18124-F  | 83312   | 89409   |
| 2C4Z-18124-BA   | 83175   |         | 5U2Z-18V125-BGA | G63778  |         | ASH-24660    | 85180   |         | C1TZ-18124-N  | 83314   |         |
| 2C7Z-18125-AA   | G63837  |         | 5U2Z-18V125-BS  | G63607  |         | ASH-247      | G63461  |         | C1TZ-18124-P  | 83312   | 89409   |
| 2C7Z-18125-CA   | G63607  |         | 5U2Z-18V125-BT  | G63525  |         | ASH-25822    | 83209   | 89414   | C1TZ-18125-B  | 83217   |         |
| 3553628C1       | 85927   |         | 5U2Z-18V125-BU  | G63524  |         | ASH-25823    | 83209   | 89414   | C1VT-18080-B  | 83217   |         |
| 3553628C2       | 85927   |         | 5U2Z-18V125-F   | G63676  |         | ASH-25824    | 83122   | 89406   | C2TA-18045-A  | 83216   |         |
| 3578858C1       | 85926   |         | 5U2Z-18V125-G   | G63837  |         | ASH-294      | 83209   | 89414   | C2TA-18045-B  | 83308   |         |
| 3578858C2       | 85926   |         | 5U2Z-18V125-H   | G63406  |         | ASH-397      | 83131   |         | C2TZ-18124-A  | 83308   |         |
| 3584116C1       | 83175   |         | 60670-008       | 83123   | 89405   | ASH-722      | 85976   |         | C3TA-18045-A  | 83216   |         |
| 3584116C2       | 83175   |         | 60670-008L      | 83123   | 89405   | AT-163G      | 83177   |         | C3TZ-18124-A  | 83308   |         |
| 3584117C2       | 83135   |         | 60675-003       | 85976   |         | AT-164G      | 83178   |         | C4HZ-18124-A  | 83312   | 89409   |
| 3584118C2       | 85928   |         | 60675-003L      | 85976   |         | AT-610       | G63461  |         | C4HZ-18124-B  | 83309   | 89446   |
| 3U2Z-18124-BAA  | G63809  |         | 680029          | 85301   |         | AT-611       | G63461  |         | C4HZ-18124-C  | 83314   |         |
| 3U2Z-18124-BV   | G63614  |         | 6C2Z-18124-B    | G63929  |         | AT-620       | 83209   | 89414   | C4HZ-18124-D  | 83312   | 89409   |
| 3U2Z-18124-BW   | G63614  |         | 6ETZ-18124-AA   | 83145   |         | AT-621       | 83122   | 89406   | C4HZ-18124-E  | 83309   | 89446   |
| 3U2Z-18124-EA   | G63772  |         | 6ETZ-18125-A    | 83146   |         | AT-696       | 83140   |         | C4HZ-18124-F  | 83308   |         |
| 3U2Z-18124-FA   | G63608  |         | 6U2Z-18V125-B   | G63607  |         | AT-766       | 83209   | 89414   | C4PF-18045-H  | 83216   |         |
| 3U2Z-18124-FAA  | G63809  |         | 6U2Z18V125A     | G63837  |         | AT-811       | 83135   |         | C4TZ-18124-AA | 83308   |         |
| 3U2Z-18124-JAA  | G63614  |         | 70127           | 85006   | 89401   | AT-812       | 85928   |         | C4TZ-18124-AB | 83308   |         |
| 3U2Z-18124-MAA  | 83131   |         | 70128           | 85006   | 89401   | AX-267A      | 83309   | 89446   | C4TZ-18124-B  | 83308   |         |
| 3U2Z-18124-YAA  | G63809  |         | 7C34-18045-HB   | G63969  |         | AX-310       | 83215   |         | C5TZ-18124-A  | 83308   |         |
| 3U2Z-18125-AD   | 69575   |         | 7C34-18080-DCB  | 77968   |         | B3Q-18124-A  | 83219   |         | C6PF-18077-A  | G63306  |         |
| 3U2Z-18125-CA   | G63607  |         | 7W7Z-18125-B    | 69574   |         | B3Q-18125-A  | 83217   |         | C6PF-18077-AC | 83161   |         |
| 3U2Z-18125-DA   | G63525  |         | 87HU-18045-AA   | 85301   |         | B3TZ-18125-A | 83217   |         | C6PF-18077-DD | 83216   |         |
| 3U2Z-18125-EA   | G63524  |         | 8C24-18045-DA   | 83177   |         | B6TZ-18124-A | 83219   |         | C6PF-18077-DE | 83219   |         |
| 3U2Z-18125-RA   | G63623  |         | 8C24-18080-DB   | 83178   |         | B6TZ-18125-B | 83161   |         | C6PF-18077-DL | 83312   | 89409   |
| 471700011530    | 85181   |         | 8C2Z-18124-D    | 83177   |         | B6TZ-18125-C | 83161   |         | C6PF-18077-DN | 83314   |         |
| 471700011531    | 85180   |         | 8C2Z-18125-D    | 83178   |         | B6TZ-18125-E | 83161   |         | C6PF-18077-F  | 83225   |         |
| 47902-13        | 83122   | 89406   | 90044769        | 83207   | 89407   | B7C-18125-A  | 83217   |         | C6TA-18045-U  | 85301   |         |
| 47902-28        | 85013   | 89414   | 90044770        | 83207   | 89407   | B7T-18124-C  | 83225   |         | C6TA-18045-V  | 85301   |         |
| 47902-8         | 83122   | 89406   | 90045068        |         | 89441   | B7TZ-18124-B | 83216   |         | C6TA-18045-Y  | 85301   |         |
| 4C4Z-18124-HB   | 83135   |         | 90045099        | 85906   | 89407   | B7TZ-18124-C | 83216   |         | C6TA-18045-Z  | 85301   |         |
| 4C4Z-18124-JB   | 85928   |         | 90045132        | 85909   |         | B7TZ-18124-D | 83219   |         | C6TS-18080-A  | 83217   |         |
| 4C4Z-18124-P    | 83135   |         | 9U94-18045-AA   | 83209   | 89414   | B7TZ-18124-E | 83217   |         | C6TZ-18124-D  | 85301   |         |
| 4C4Z-18124-QA   | 83175   |         | 9U94-18080-AA   | 83122   | 89406   | B7TZ-18125-C | 83217   |         | C6TZ-18124-E  | 85301   |         |
| 4C4Z-18124-RA   | 85928   |         | 9U9Z-18124-A    | 83209   | 89414   | B8Q-18125-A  | 85307   |         | C6TZ-18124-H  | 85301   |         |
| 4C4Z-18125-B    | 83317   |         | 9U9Z-18125-A    | 83122   | 89406   | B8QZ-18124-A | 83312   | 89409   | C6TZ-18124-J  | 85301   |         |
| 4C4Z-18125-CA   | 85976   |         | AA-494          | 83131   |         | B8TZ-18124-A | 83219   |         | C7HZ-18124-A  | 83312   | 89409   |
| 4C4Z-18125-DA   | 85926   |         | AA-615          | 83135   |         | B9TT-18045-C | 83219   |         | C7PF-18077-A  | 83225   |         |
| 4U2Z-18V124-AA  | G63678  |         | AA-616          | 83175   |         | B9TT-18045-D | 83219   |         | C7PF-18077-Z  | 83217   |         |
| 501906C92       | 83317   |         | AA-617          | 85928   |         | B9TT-18080-B | 83161   |         | C7TA-18045-R  | 83216   |         |
| 57241-2         | 83109   |         | ASH-1022        | 83209   | 89414   | B9TZ-18125-B | 83161   |         | C7TA-18045-Z  | 85301   |         |
| 57365-111       | 85006   | 89401   | ASH-1023        | 83122   | 89406   | C0TT-18045-A | 83219   |         | C8HA-18045-A  | 83312   | 89409   |
| 5C3Z-18124-JA   | G63969  |         | ASH-1105        | 85976   |         | C0TT-18045-D | 83216   |         | C8PF-18045-CM | 83216   |         |
| 5C3Z-18125-CF   | 77969   |         | ASH-1136        | 83178   |         | C0TZ-18124-A | 83216   |         | C8PF-18045-S  | 83161   |         |
| 5C3Z-18125-DA   | 77968   |         | ASH-1154        | 83177   |         | C1TT-18045-C | 83312   | 89409   | C8PF-18045-T  | 83161   |         |
| 5U2Z-18V124-AA  | G63714  |         | ASH-1205        | 83209   | 89414   | C1TT-18045-D | G63406  |         | C8TA-18045-AA | G63386  |         |
| 5U2Z-18V124-AHA | G63622  |         | ASH-1206        | 83122   | 89406   | C1TT-18045-E | 83314   |         | C8TA-18080-Y  | 83161   |         |
| 5U2Z-18V124-AU  | G63772  |         | ASH-1228        | 83209   | 89414   | C1TT-18045-G | 83216   |         | C8TA-18080-Z  | 83161   |         |
| 5U2Z-18V124-BA  | G63716  |         | ASH-1229        | 83209   | 89414   | C1TT-18080-B | 83217   |         | C8TZ-18125-D  | 83161   |         |
| 5U2Z-18V124-CAA | G63809  |         | ASH-1230        | 83122   | 89406   | C1TZ-18045-C | 83312   | 89409   | D0HA-18045-D  | 83309   | 89446   |
| 5U2Z-18V124-DB  | G63455  |         | ASH-137         | 83122   | 89406   | C1TZ-18124-A | 83217   |         | D0HA-18045-E  | 83312   | 89409   |
| 5U2Z-18V124-GA  | G63809  |         | ASH-23486       | G63461  |         | C1TZ-18124-B | 83216   |         | D0HZ-18124-A  | 83309   | 89446   |

**Important Note:** Competitive Interchanges are to be used for stocking purposes only. Where multiple crosses are identified, please reference the applications section of this catalog. / **Remarque importante:** Les interchanges concurrentiels ne s'utilisent qu'aux fins de stocks. Dans le cas de références multiples, consulter la section des applications du catalogue. / **Nota importante:** Dans le cas de références multiples, consulter la section des applications du catalogue. / **Nota importante:** Se pueden usar intercambios competitivos para propósitos de almacenamiento solamente. Cuando se identifican intercambios múltiples, consulte la sección de aplicaciones de este catálogo.



**COMPETITIVE & O.E.M. INTERCHANGE LIST**  
**Lista de Intercambios contra Competidores y Equipo Original.**  
**Liste d'interchange de produits compétitifs & d'équipement original (OEM)**

**FORD... cont'd**

| O.E.M #        | Gabriel | Upgrade | O.E.M #       | Gabriel | Upgrade | O.E.M #       | Gabriel | Upgrade | O.E.M #       | Gabriel | Upgrade |
|----------------|---------|---------|---------------|---------|---------|---------------|---------|---------|---------------|---------|---------|
| D0HZ-18124-B   | 83312   | 89409   | D5TZ-18124-C  | 83312   | 89409   | E7XZ-18124-B  | G63500  |         | F2HZ-18124-C  | 85006   | 89401   |
| D0HZ-18124-C   | 83314   |         | D7HA-18080-AA | 83123   | 89405   | E7XZ-18124-C  | G63511  |         | F2HZ-18125-A  | 85712   |         |
| D1TF-18045-LA  | 83312   | 89409   | D7HF-18045-FA | 83312   | 89409   | E7XZ-18124-D  | G63396  |         | F4HT-18045-AB | 83314   |         |
| D1TZ-18124-D   | 83308   |         | D7HF-18080-AA | 83215   |         | E7XZ-18124-F  | G63398  |         | F4HT-18045-AC | 83314   |         |
| D1TZ-18124-E   | 83216   |         | D7HF-18125-AA | 83215   |         | E7XZ-18124-G  | G63398  |         | F4HT-18045-CB | 83107   |         |
| D1TZ-18124-F   | 83312   | 89409   | D7HT-18045-BA | 83312   | 89409   | E7XZ-18125-A  | G63350  |         | F4HT-18045-DA | 85063   |         |
| D1TZ-18125-E   | 83217   |         | D7HT-18045-CA | 83314   |         | E7XZ-18125-B  | G63387  |         | F4HT-18045-EA | 83125   |         |
| D2EF-18045-AA  | 83312   | 89409   | D7HT-18045-DA | 83309   | 89446   | E7XZ-18125-C  | G63409  |         | F4HT-18080-AA | 85314   | 89425   |
| D2EF-18124-AA  | 83312   | 89409   | D7HT-18045-EA | 83312   | 89409   | E7XZ-18125-D  | G63406  |         | F4HT-18080-AB | 85314   | 89425   |
| D2HA-18045-E1A | 85304   |         | D7HT-18045-GA | 83308   |         | E7XZ-18125-E  | G63406  |         | F4HT-18080-BA | 85001   | 89410   |
| D2HA-18045-E1B | 85304   |         | D7HT-18045-HA | 85012   | 89413   | E7XZ-18125-G  | G63811  |         | F4TA-18045-TA | G63455  |         |
| D2HA-18045-E2A | 85304   |         | D7HT-18045-JA | 83308   |         | E7XZ-18125-J  | G63299  |         | F4TA-18080-PA | G63461  |         |
| D2HA-18045-E2B | 85304   |         | D7HT-18045-NA | 85301   |         | E9HS-18045-AA | 83309   | 89446   | F4TZ-18124-D  | G63414  |         |
| D2HA-18045-EB  | 85301   |         | D7HT-18080-AA | 83215   |         | E9HS-18080-AA | 85716   |         | F4TZ-18124-K  | G63455  |         |
| D2HA-18045-F1A | 85301   |         | D7HT-18080-BA | 83225   |         | E9HZ-18124-A  | 83309   | 89446   | F4TZ-18125-E  | G63461  |         |
| D2HA-18045-F1B | 85301   |         | D7HT-18080-CA | 83225   |         | E9HZ-18125-A  | 85716   |         | F4TZ-18125-L  | G63406  |         |
| D2HA-18045-F2A | 85301   |         | D7HT-18080-DA | 83215   |         | E9HZ-18125-AA | 85716   |         | F57Z-18125-BB | G63679  |         |
| D2HA-18045-F2B | 85301   |         | D7HT-18124-BA | 83312   | 89409   | F0HS-18045-AA | 85006   | 89401   | F5HZ-18124-A  | 83314   |         |
| D2HF-18045-A   | 83314   |         | D7HT-18124-CA | 83314   |         | F0HT-18045-AA | 85006   | 89401   | F5HZ-18124-AA | 83314   |         |
| D2HF-18045-AA  | 83314   |         | D7HT-18124-DA | 83309   | 89446   | F0HT-18045-CA | 85006   | 89401   | F5HZ-18124-B  | 83107   |         |
| D2HF-18045-BA  | 83309   | 89446   | D7HT-18124-EA | 83312   | 89409   | F0HT-18080-AA | 83122   | 89406   | F5HZ-18124-C  | 85063   |         |
| D2HF-18045-CA  | 83308   |         | D7HT-18124-FA | 83312   | 89409   | F0HZ-18124-A  | 85006   | 89401   | F5HZ-18124-D  | 83125   |         |
| D2HF-18045-DA  | 83312   | 89409   | D7HT-18124-GA | 83308   |         | F0HZ-18124-B  | 85006   |         | F5HZ-18124-DA | 83125   |         |
| D2HF-18124-AA  | 83314   |         | D7HT-18124-HA | 83219   |         | F0HZ-18125-A  | 83122   | 89406   | F5HZ-18125-A  | 85314   | 89425   |
| D2HT-18045-CA  | 83314   |         | D7HT-18124-JA | 83308   |         | F1HT-18045-AA | 83309   | 89446   | F5HZ-18125-AA | 85314   | 89425   |
| D2HT-18045-EA  | 83312   | 89409   | D7HT-18124-KA | 85301   |         | F1HT-18045-CA | 83308   |         | F5HZ-18125-B  | 85001   | 89410   |
| D2HT-18045-GA  | 83308   |         | D7HT-18125-BA | 83217   |         | F1HT-18045-CB | 83216   |         | F5HZ-18125-BA | 85001   | 89410   |
| D2HT-18080-HA  | 83225   |         | D7HT-18125-CA | 83217   |         | F1HT-18045-DA | 83312   | 89409   | F5HZ-18125-DA | 85314   | 89425   |
| D2HZ-18080-A   | 83209   | 89414   | D7HT-18125-DA | 83215   |         | F1HT-18045-DB | 83308   |         | F5TZ-18124-B  | G63608  |         |
| D2HZ-18125-A   | 83209   | 89414   | D7HT-18125-FA | 83123   | 89405   | F1HT-18045-EA |         | 89402   | F5TZ-18125-BC | G63607  |         |
| D2HZ-18125-B   | 83209   | 89414   | D7HZ-18125-A  | 83215   |         | F1HT-18045-EB |         | 89402   | F5UZ-18124-A  | G63622  |         |
| D2KF-18045-AA  | 83312   | 89409   | D7KF-18045-EA | 83312   | 89409   | F1HT-18045-GA | 85006   | 89401   | F5UZ-18124-B  | G63622  |         |
| D2KF-18124-AA  | 83312   | 89409   | D7TA-18124-GA | 83314   |         | F1HT-18045-GB | 85006   | 89401   | F5UZ-18125-A  | G63623  |         |
| D2TA-18045-AAA | 83219   |         | D7TZ-18125-C  | 83217   |         | F1HT-18045-HB | 85006   | 89401   | F5UZ-18125-C  | G63624  |         |
| D2TA-18045-ZA  | 83219   |         | D8HZ-18124-A  | 85301   |         | F1HT-18045-KB | 85006   | 89401   | F6HT-18045-AA | 85054   | 89438   |
| D2TF-18045-AA  | 83312   | 89409   | D8HZ-18125-A  | 83209   | 89414   | F1HT-18045-LB | 85006   | 89401   | F6HT-18045-AC | 85054   | 89438   |
| D2TF-18045-FA  | 83312   | 89409   | D8HZ-18125-B  | 83123   | 89405   | F1HT-18045-NA | 85040   |         | F6HT-18045-BC | 85047   | 89435   |
| D2TF-18045-GA  | 83308   |         | E0HT-18045-AA | 83309   | 89446   | F1HT-18045-RA |         | 89402   | F6HT-18045-CC | 85055   | 89439   |
| D2TF-18080-HA  | 83225   |         | E0HT-18045-AB | 83309   | 89446   | F1HT-18045-RB |         | 89402   | F6HT-18045-EB | 85055   | 89439   |
| D2TF-18080-NA  | 83217   |         | E0HT-18080-AA | 83215   |         | F1HZ-18124-A  | 83309   | 89446   | F6HT-18045-EC | 85055   | 89439   |
| D2TF-18124-F   | 83309   | 89446   | E0HZ-18124-A  | 83309   | 89446   | F1HZ-18124-AA | 83309   | 89446   | F6HT-18045-GB | 85030   | 89440   |
| D2TZ-18124-A   | 83308   |         | E1TA-18045-AA | 83309   | 89446   | F1HZ-18124-B  | 83308   |         | F6HT-18045-GC | 85030   | 89440   |
| D2TZ-18124-E   | 83312   | 89409   | E1TD-18045-AA | 83309   | 89446   | F1HZ-18124-C  |         | 89402   | F6HT-18045-HB | 85054   | 89438   |
| D2TZ-18124-F   | 83309   | 89446   | E5HT-18045-AA | 85301   |         | F1HZ-18124-D  | 85006   | 89401   | F6HT-18045-HC | 85054   | 89438   |
| D2TZ-18124-G   | 83314   |         | E5HT-18045-DA | 85301   |         | F1HZ-18124-E  | 85006   | 89401   | F6HT-18045-JB | 83200   | 89402   |
| D2TZ-18124-H   | 83308   |         | E5HT-18045-EA | 85301   |         | F1HZ-18124-F  | 85006   | 89401   | F6HT-18045-JC | 83200   | 89402   |
| D2TZ-18124-J   | 83312   | 89409   | E5HT-18080-DA | 85315   |         | F1HZ-18124-G  | 85006   | 89401   | F6HT-18045-KA | 83200   | 89402   |
| D3TA-18045-BA  | 83219   |         | E5HT-18080-EA | 85315   |         | F1HZ-18124-H  | 85040   |         | F6HT-18045-LA | 85376   |         |
| D3TZ-18124-B   | 83219   |         | E6HT-18080-AA | 83215   |         | F1HZ-18124-J  | 83308   |         | F6HT-18045-MA | 85006   | 89401   |
| D3TZ-18125-C   | 83217   |         | E6HZ-18124-A  | 85301   |         | F1HZ-18124-K  |         | 89402   | F6HT-18080-B  | 83109   |         |
| D3TZ-18125-D   | 83217   |         | E6HZ-18124-D  | 85301   |         | F2HT-18045-BA | 85376   |         | F6HT-18080-CA | 85314   | 89425   |
| D4HA-18080-A   | 83209   | 89414   | E6HZ-18125-D  | 83215   |         | F2HT-18045-CA | 85376   |         | F6HT-18080-DA | 83109   |         |
| D4HA-18080-AA  | 83209   | 89414   | E6HZ-18125-E  | 85315   |         | F2HT-18045-DA | 85006   | 89401   | F6HT-18080-EA | 85906   | 89407   |
| D4TF-18045-AA  | 83312   | 89409   | E6HZ-18125-F  | 85315   |         | F2HT-18080-DA | 85712   |         | F6HT-18080-FC | 85013   | 89414   |
| D4TZ-18124-J   | 83308   |         | E7HZ-18124-A  | 85301   |         | F2HZ-18124-A  | 85376   |         | F6HT-18080-JA | 85305   |         |
| D5TZ-18124-B   | 83308   |         | E7XZ-18124-A  | G63386  |         | F2HZ-18124-B  | 85301   |         | F6HZ-18080-FC | 85013   | 89414   |

**Important Note:** Competitive Interchanges are to be used for stocking purposes only. Where multiple crosses are identified, please reference the applications section of this catalog. / **Remarque importante:** Les interchanges concurrentiels ne s'utilisent qu'aux fins de stocks. Dans le cas de références multiples, consulter la section des applications du catalogue. / **Nota importante:** Dans le cas de références multiples, consulter la section des applications du catalogue. / **Nota importante:** Se pueden usar intercambios competitivos para propósitos de almacenamiento solamente. Cuando se identifican intercambios múltiples, consulte la sección de aplicaciones de este catálogo.

**COMPETITIVE & O.E.M. INTERCHANGE LIST**  
**Lista de Intercambios contra Competidores y Equipo Original.**  
**Liste d'interchange de produits compétitifs & d'équipement original (OEM)**

**FORD... cont'd**

| O.E.M #        | Gabriel | Upgrade | O.E.M #        | Gabriel | Upgrade | O.E.M #       | Gabriel | Upgrade | O.E.M #       | Gabriel | Upgrade |
|----------------|---------|---------|----------------|---------|---------|---------------|---------|---------|---------------|---------|---------|
| F6HZ-18124-A   | 85054   | 89438   | F81A-18080-DCA | G63461  |         | LA-18080-F    | 83161   |         | TDBA-18080-C  | 83217   |         |
| F6HZ-18124-B   | 83308   |         | F81A-18080-ZC  | 83140   |         | LA-18080-J    | 83161   |         | TDBE-18045-A  | 83219   |         |
| F6HZ-18124-C   | 85055   | 89439   | F81Z-18124-AL  | G63622  |         | TAAH-18080-A  | 83161   |         | TFAA-18045-B  | 83219   |         |
| F6HZ-18124-D   | 85055   | 89439   | F81Z-18124-BK  | G63809  |         | TAAH-18080-A2 | 83161   |         | TFAA-18045-C  | 83219   |         |
| F6HZ-18124-E   | 85055   | 89439   | F81Z-18124-PA  | 85928   |         | TAAH-18080-A3 | 83161   |         | TFAA-18080-A  | 85307   |         |
| F6HZ-18124-F   | 85055   | 89439   | F81Z-18125-DC  | G63461  |         | TAAK-18080-A  | 83161   |         | THAB-18045-A  | 83219   |         |
| F6HZ-18124-G   | 85054   | 89438   | F81Z-18125-ZA  | 83140   |         | TAAK-18080-A1 | 83161   |         | THAB-18045-B  | 83219   |         |
| F6HZ-18124-H   | 85054   | 89438   | F87Z-18125-CA  | G63773  |         | TAAK-18080-A2 | 83161   |         | TQSH-18045-A  | 83309   | 89446   |
| F6HZ-18124-J   | 83200   | 89402   | F87Z-18125-RA  | G63775  |         | TACAA-18045-A | 83216   |         | XC35-18045-AB | 83131   |         |
| F6HZ-18124-KA  | 83200   | 89402   | FC44-18045-BB  | 85181   |         | TANNA-18045-A | 83312   | 89409   | XC35-18045-AD | 83131   |         |
| F6HZ-18124-MA  | 85006   | 89401   | FC44-18080-AB  | 85180   |         | TBAK-18080-A  | 83161   |         | XC35-18045-JA | 83131   |         |
| F6HZ-18125-A   | 85314   | 89425   | FC4Z-18124-A   | 85181   |         | TBDA-18080-A  | 83217   |         | XC3Z-18124-JA | 83131   |         |
| F6HZ-18125-B   | 83109   |         | FC4Z-18124-B   | 85181   |         | TBDA-18080-B  | 83217   |         | XC45-18045-AA | 83216   |         |
| F6HZ-18125-C   |         | 89441   | FC4Z-18124-HB  | 83135   |         | TDAA-18080-A  | 83161   |         | XL2Z-18124-EA | G63678  |         |
| F6HZ-18125-D   | 85013   | 89414   | FC4Z-18125-A   | 85180   |         | TDAA-18080-B  | 83217   |         | XL2Z-18125-BA | G63679  |         |
| F6HZ-18125-JA  | 85305   |         | LA-18080       | 83161   |         | TDBA-18045-A  | 83219   |         | XL2Z-18125-CA | G63679  |         |
| F7C2Z-18124-BR | G63929  |         | LA-18080-A     | 83161   |         | TDBA-18045-B  | 83219   |         | XL2Z-18125-EA | G63679  |         |
| F7TA-18045-AA  | G63608  |         | LA-18080-B     | 83161   |         | TDBA-18080-A  | 83217   |         | YL5Z-18124-AA | G63772  |         |
| F7TA-18080-BA  | G63607  |         | LA-18080-C     | 83161   |         | TDBA-18080-B  | 83217   |         |               |         |         |

**FORD CAB SHOCKS**

| O.E.M #   | Gabriel | Upgrade | O.E.M #   | Gabriel | Upgrade | O.E.M #       | Gabriel | Upgrade | O.E.M #       | Gabriel | Upgrade |
|-----------|---------|---------|-----------|---------|---------|---------------|---------|---------|---------------|---------|---------|
| 1201-0012 | 83023   |         | 1202-0012 | 83023   |         | 1202-1043     | 83025   |         | F6HZ-5K407-BA | 83033   |         |
| 1201-1043 | 83025   |         | 1202-0032 | 83016   |         | 1202-1044     | 83025   |         | F8HT-5K407-AA | 83033   |         |
| 1201-1044 | 83025   |         | 1202-0042 | 83025   |         | F6HZ-5K407-AB | 83034   |         |               |         |         |

**FOREST RIVER INC**

| O.E.M #       | Gabriel | Upgrade | O.E.M #       | Gabriel | Upgrade | O.E.M #   | Gabriel | Upgrade | O.E.M #        | Gabriel | Upgrade |
|---------------|---------|---------|---------------|---------|---------|-----------|---------|---------|----------------|---------|---------|
| 141700131809  | 85029   |         | 481700000493  | 85900   |         | ASH-1154  | 83177   |         | ASH-25824      | 83122   | 89406   |
| 141700131810  | 83160   |         | 66153-002     | 83124   | 89407   | ASH-1205  | 83209   | 89414   | ASH-294        | 83209   | 89414   |
| 16-16736-000  | 85029   |         | 9U94-18045-AA | 83209   | 89414   | ASH-1206  | 83122   | 89406   | AT-620         | 83209   | 89414   |
| 16-16737-000  | 83160   |         | 9U94-18080-AA | 83122   | 89406   | ASH-1228  | 83209   | 89414   | AT-621         | 83122   | 89406   |
| 16-16873-000  | 85029   |         | 9U9Z-18124-A  | 83209   | 89414   | ASH-1229  | 83209   | 89414   | AT-766         | 83209   | 89414   |
| 16-16874-000  | 83160   |         | 9U9Z-18125-A  | 83122   | 89406   | ASH-1230  | 83122   | 89406   | F4-BE5-C832-MO | 83124   | 89407   |
| 16-18103-000  | 85900   |         | ASH-1022      | 83209   | 89414   | ASH-137   | 83122   | 89406   |                |         |         |
| 1C34-18045-AA | 83209   | 89414   | ASH-1023      | 83122   | 89406   | ASH-25822 | 83209   | 89414   |                |         |         |
| 1C34-18045-JA | 83209   | 89414   | ASH-1136      | 83178   |         | ASH-25823 | 83209   | 89414   |                |         |         |

**FREIGHTLINER**

| O.E.M #      | Gabriel | Upgrade | O.E.M #      | Gabriel | Upgrade | O.E.M #      | Gabriel | Upgrade | O.E.M #      | Gabriel | Upgrade |
|--------------|---------|---------|--------------|---------|---------|--------------|---------|---------|--------------|---------|---------|
| 10-12030-002 | 85320   | 89429   | 10-13684-000 | 85918   | 89449   | 16-15770-000 | 85956   |         | 471700000449 | 85918   | 89449   |
| 10-12032-000 | 85320   | 89429   | 10-13759-000 | 85006   |         | 16-15817-000 | 85724   | 89443   | 471700000470 | 85918   | 89449   |
| 10-12032-001 | 85320   | 89429   | 10-13760-000 | 85959   | 89503   | 16-16442-000 | 83134   |         | 471700002808 | 85724   | 89443   |
| 10-12032-002 | 85320   | 89429   | 10-13776-000 | 85005   | 89430   | 16-16486-000 | 83134   |         | 471700002809 | 85724   | 89443   |
| 10-12032-003 | 85320   | 89429   | 10-13809-000 | 85958   |         | 16-16577-000 | 85335   |         | 471700002990 | 85007   | 89412   |
| 10-12032-004 | 85320   | 89429   | 10-13859-000 | 85005   | 89430   | 16-16765-000 | 85006   |         | 471700002991 | 85959   | 89503   |
| 10-12046-000 | 85320   | 89429   | 10-13934-000 | 85123   |         | 16-16826-000 | 85904   |         | 471700002992 | 85331   |         |
| 10-12388-000 | 85920   | 89503   | 16-10688-000 | 85042   |         | 16-17211-000 | 85909   |         | 471700002993 | 85921   |         |
| 10-12390-000 | 85920   | 89503   | 16-11133-000 | 85007   | 89412   | 16-17759-000 | 85919   |         | 471700002994 | 83134   |         |
| 10-12396-000 | 85918   | 89449   | 16-12117-000 | 85007   | 89412   | 16-18705-000 | 85007   | 89412   | 471700002995 | 83134   |         |
| 10-12542-000 | 85901   |         | 16-13947-000 | 85319   | 89428   | 16-18706-000 | 85331   |         | 471700002996 | 85335   |         |
| 10-12594-000 | 85984   |         | 16-13957-000 | 85724   | 89443   | 16-18707-000 | 85921   |         | 471700003009 | 85006   |         |
| 10-12703-000 | 85918   | 89449   | 16-14259-000 | 85331   |         | 16-18708-000 | 85724   | 89443   | 471700003920 | 85958   |         |
| 10-13021-000 | 85918   | 89449   | 16-14577-000 | 85043   |         | 16-18709-000 | 83134   |         | 471700006269 | 85932   | 89453   |
| 10-13051-001 | 85005   | 89430   | 16-14667-000 | 85005   | 89430   | 16-18710-000 | 83134   |         | 471700006929 | 85123   |         |
| 10-13063-000 | 85918   | 89449   | 16-14668-000 | 83127   |         | 16-18711-000 | 85335   |         | 471700131155 | 85918   | 89449   |
| 10-13205-000 | 85918   | 89449   | 16-14669-000 | G63403  |         | 16-19138-000 | 85058   | 89431   |              |         |         |
| 10-13211-000 | 85918   | 89449   | 16-14759-000 | 85000   | 89436   | 3638112      | G63183  |         |              |         |         |
| 10-13592-000 | 85959   | 89503   | 16-15591-000 | 85043   |         | 4036892      | G63605  |         |              |         |         |
| 10-13634-000 | 85918   | 89449   | 16-15765-000 | 85921   |         | 471700000440 | 85959   | 89503   |              |         |         |

**Important Note:** Competitive Interchanges are to be used for stocking purposes only. Where multiple crosses are identified, please reference the applications section of this catalog. / **Remarque importante:** Les interchanges concurrentiels ne s'utilisent qu'aux fins de stocks. Dans le cas de références multiples, consulter la section des applications du catalogue. / **Nota importante:** Dans le cas de références multiples, consulter la section des applications du catalogue. / **Nota importante:** Se pueden usar intercambios competitivos para propósitos de almacenamiento solamente. Cuando se identifican intercambios múltiples, consulte la sección de aplicaciones de este catálogo.

**COMPETITIVE & O.E.M. INTERCHANGE LIST**  
**Lista de Intercambios contra Competidores y Equipo Original.**  
**Liste d'interchange de produits compétitifs & d'équipement original (OEM)**

**FREIGHTLINER... cont'd**

| O.E.M #      | Gabriel | Upgrade | O.E.M # | Gabriel | Upgrade | O.E.M #      | Gabriel | Upgrade | O.E.M #         | Gabriel | Upgrade |
|--------------|---------|---------|---------|---------|---------|--------------|---------|---------|-----------------|---------|---------|
| 471700131331 | 85932   | 89453   | 650224  | 83225   |         | 680008       | 85300   | 89419   | 6813260200      | 85011   |         |
| 471700131646 | 85918   | 89449   | 651352  | 85042   |         | 680009       | 85302   | 89420   | 70029           | 85308   | 89422   |
| 47902-13     | 83122   | 89406   | 654654  | 85043   |         | 680017       | 85302   | 89420   | 70042           | 85302   | 89420   |
| 481700006848 | 85724   | 89443   | 654875  | 83117   |         | 6803230200   | 85043   |         | 90044162        | 83128   | 89436   |
| 481700125969 | 85956   |         | 654918  | 83118   |         | 6803230300   | 85006   |         | 90045083        | 85910   |         |
| 535228       | 85302   | 89420   | 659060  | 85920   | 89503   | 6803260000   | 83120   |         | GBL654725       | 83120   |         |
| 58913-003    | 85932   | 89453   | 659062  | 83134   |         | 680339       | 85724   | 89443   | GBL665538       | 85006   |         |
| 58913-003L   | 85932   | 89453   | 659063  | 83134   |         | 680442       | 85319   | 89428   | H60680004       | 83143   |         |
| 58913-012    | 85932   | 89453   | 659300  | 85005   | 89430   | 680511       | 85331   |         | H60680005       | 83142   |         |
| 58913-012L   | 85932   | 89453   | 660235  | 85042   |         | 680611       | 85724   | 89443   | SDA471400003920 | 85958   |         |
| 60680-004    | 83143   |         | 665174  | 85060   |         | 680651       | 85335   |         | SDA471700000440 | 85959   | 89503   |
| 60680-004L   | 83143   |         | 665236  | 85007   | 89412   | 680782       | 85302   | 89420   | SDA471700002809 | 85724   | 89443   |
| 60680-005    | 83142   |         | 665409  | 85009   |         | 681-323-0900 | 85009   |         | SDA471700002991 | 85959   | 89503   |
| 60680-005L   | 83142   |         | 671908  | 85918   | 89449   | 681-323-1100 | 85301   |         | SDA481700125969 | 85956   |         |
| 61300224     | 85918   | 89449   | 671945  | 85920   | 89503   | 681-326-0400 | 85319   | 89428   |                 |         |         |
| 61300240     | 85918   | 89449   | 671946  | 85921   |         | 6813230900   | 85009   |         |                 |         |         |

**FREIGHTLINER CAB SHOCKS**

| O.E.M #      | Gabriel | Upgrade | O.E.M #      | Gabriel | Upgrade | O.E.M #      | Gabriel | Upgrade | O.E.M #       | Gabriel | Upgrade |
|--------------|---------|---------|--------------|---------|---------|--------------|---------|---------|---------------|---------|---------|
| 1201-0012    | 83023   |         | 18-31476-000 | 83020   |         | 18-60765-001 | 83047   |         | 659080        | 83039   |         |
| 1201-0054    | 83021   |         | 18-32999-000 | 83001   |         | 18-60765-002 | 83038   |         | 659125        | 83047   |         |
| 1201-1043    | 83025   |         | 18-32999-001 | 83006   |         | 18-60766-000 | 83040   |         | 659178        | 83038   |         |
| 1201-1044    | 83025   |         | 18-37813-000 | 83044   |         | 18-60767-000 | 83039   |         | 659288        | 83006   |         |
| 1202-0012    | 83023   |         | 18-41762-000 | 83038   |         | 18-60768-000 | 83057   |         | 681-891-02-05 | 83017   |         |
| 1202-0032    | 83016   |         | 18-41762-001 | 83047   |         | 18-60769-000 | 83009   |         | 814903003482  | 83040   |         |
| 1202-0042    | 83025   |         | 18-41762-002 | 83038   |         | 18-60772-000 | 83026   |         | 814903003483  | 83039   |         |
| 1202-0043    | 83032   |         | 18-42613-000 | 83033   |         | 18-60773-000 | 83027   |         | 814903003484  | 83057   |         |
| 1202-0044    | 83025   |         | 18-43504-000 | 83057   |         | 18-67845-000 | 83906   |         | 814903003486  | 83047   |         |
| 1202-0054    | 83021   |         | 18-44321-000 | 83009   |         | 18-69674-000 | 83906   |         | 814903003496  | 83009   |         |
| 1202-1043    | 83025   |         | 18-45067-000 | 83034   |         | 654739       | 83009   |         | 814903003528  | 83038   |         |
| 1202-1044    | 83025   |         | 18-47349-000 | 83039   |         | 654819       | 83001   |         | 814903012666  | 83906   |         |
| 18-29846-000 | 83009   |         | 18-47350-000 | 83040   |         | 654831       | 83006   |         | 814903015188  | 83906   |         |
| 18-29846-001 | 83064   |         | 18-60295-000 | 83006   |         | 654841       | 83020   |         | GBL 650361    | 83017   |         |
| 18-30378     | 83006   |         | 18-60764-000 | 83038   |         | 654990       | 83038   |         |               |         |         |
| 18-30378-000 | 83001   |         | 18-60765-000 | 83038   |         | 659079       | 83040   |         |               |         |         |

**FREIGHTLINER CUSTOM CHASSIS**

| O.E.M #      | Gabriel | Upgrade | O.E.M #      | Gabriel | Upgrade | O.E.M #      | Gabriel | Upgrade | O.E.M #      | Gabriel | Upgrade |
|--------------|---------|---------|--------------|---------|---------|--------------|---------|---------|--------------|---------|---------|
| 10-13211-000 | 85918   | 89449   | 16-15676-000 | 85058   | 89431   | 16-17361-000 | 85900   |         | 471700003009 | 85006   |         |
| 10-13358-000 | 85097   |         | 16-15705-000 | 83120   |         | 16-17684-000 | 85058   | 89431   | 471700003011 | 85058   | 89431   |
| 10-13634-000 | 85918   | 89449   | 16-15755-000 | 85043   |         | 16-17759-000 | 85919   |         | 471700003070 | 85122   |         |
| 10-13759-000 | 85006   |         | 16-15805-000 | 83120   |         | 16-17760-000 | 85331   |         | 471700005079 | 85005   | 89430   |
| 10-13859-000 | 85005   | 89430   | 16-15817-000 | 85724   | 89443   | 16-18075-000 | 83174   |         | 471700131775 | 85006   |         |
| 1398980      | 83127   |         | 16-15934-000 | 83120   |         | 16-18076-000 | 83160   |         | 471700131778 | 85331   |         |
| 141700000377 | 83174   |         | 16-16043-000 | 85043   |         | 16-18094-000 | 85959   |         | 471700131974 | 85029   |         |
| 141700000378 | 83160   |         | 16-16082-000 | 85043   |         | 16-18095-000 | 85092   |         | 481700000477 | 85900   |         |
| 141700131809 | 85029   |         | 16-16083-000 | 85331   |         | 16-18103-000 | 85900   |         | 481700000493 | 85900   |         |
| 141700131810 | 83160   |         | 16-16093-000 | 83160   |         | 16-18455-000 | 85918   | 89449   | 481700131919 | 85900   |         |
| 141700131975 | 83160   |         | 16-16262-000 | 83120   |         | 16-18456-000 | 85959   |         | 654918       | 83118   |         |
| 16-14794-000 | 83154   |         | 16-16542-000 | 83154   |         | 16-18708-000 | 85724   | 89443   | 654953       | 85058   | 89431   |
| 16-15064-000 | 83154   |         | 16-16736-000 | 85029   |         | 16-18713-000 | 85122   |         | 659104       | 85097   |         |
| 16-15089-000 | 83164   |         | 16-16737-000 | 83160   |         | 16-19138-000 | 85058   | 89431   | 659227       | 85058   | 89431   |
| 16-15394-000 | 83120   |         | 16-16765-000 | 85006   |         | 1745500      |         | 89430   | 665545401    |         | 89430   |
| 16-15436-000 | 83154   |         | 16-16827-000 | 85331   |         | 471700000447 | 85919   |         | 6803230300   | 85006   |         |
| 16-15473-000 | 83157   |         | 16-16836-000 | 83154   |         | 471700000466 | 85959   |         | 6803260000   | 83120   |         |
| 16-15474-000 | 83157   |         | 16-16873-000 | 85029   |         | 471700000467 | 85092   |         | GBL 651375   | 83119   |         |
| 16-15475-000 | 83164   |         | 16-16874-000 | 83160   |         | 471700002726 | 85918   | 89449   | GBL 654870   | 83116   |         |
| 16-15592-000 | 83154   |         | 16-17144-000 | 85900   |         | 471700002727 | 85959   |         | GBL654725    | 83120   |         |

**Important Note:** Competitive Interchanges are to be used for stocking purposes only. Where multiple crosses are identified, please reference the applications section of this catalog. / **Remarque importante:** Les interchanges concurrentiels ne s'utilisent qu'aux fins de stocks. Dans le cas de références multiples, consulter la section des applications du catalogue. / **Nota Importante:** Dans le cas de références multiples, consulter la section des applications du catalogue. / **Nota Importante:** Se pueden usar intercambios competitivos para propósitos de almacenamiento solamente. Cuando se identifican intercambios múltiples, consulte la sección de aplicaciones de este catálogo.

**COMPETITIVE & O.E.M. INTERCHANGE LIST**  
**Lista de Intercambios contra Competidores y Equipo Original.**  
**Liste d'interchange de produits compétitifs & d'équipement original (OEM)**

**FREIGHTLINER CUSTOM CHASSIS... cont'd**

| O.E.M #   | Gabriel | Upgrade | O.E.M #   | Gabriel | Upgrade | O.E.M # | Gabriel | Upgrade | O.E.M # | Gabriel | Upgrade |
|-----------|---------|---------|-----------|---------|---------|---------|---------|---------|---------|---------|---------|
| GBL654875 | 83117   |         | MAE 16949 | 83120   |         | P116168 | 83117   |         | P117253 | 83116   |         |
| GBL654918 | 83118   |         | MAE 16950 | 83118   |         | P117099 | 83120   |         | RW24285 | 83119   |         |
| GBL665538 | 85006   |         | MAE16950  | 83118   |         | P117146 | 83118   |         |         |         |         |

**FRUEHAUF**

| O.E.M #  | Gabriel | Upgrade | O.E.M #        | Gabriel | Upgrade | O.E.M #      | Gabriel | Upgrade | O.E.M #      | Gabriel | Upgrade |
|----------|---------|---------|----------------|---------|---------|--------------|---------|---------|--------------|---------|---------|
| 144-5910 | 85300   | 89419   | UCA-01113      | 85304   |         | UCE-1295-901 | 85300   | 89419   | UCF-8339-001 | 85321   |         |
| 5116-117 | 83122   | 89406   | UCA-5431       | 85305   |         | UCE-2983-000 | 85322   |         | UCF-8339-002 | 85321   |         |
| 5352858  | 85305   |         | UCD-006216-001 | 83203   | 89436   | UCE-2983-001 | 85322   |         | UEY 1124-001 | 85030   | 89440   |
| 680117   | 85300   | 89419   | UCD-6216-1     | 83203   | 89436   | UCE-2983-1   | 85322   |         |              |         |         |
| 680298   | 85321   |         | UCE-1295-1     | 85300   | 89419   | UCE-9399-1   | 83122   | 89406   |              |         |         |

**FWD TRUCK**

| O.E.M # | Gabriel | Upgrade | O.E.M # | Gabriel | Upgrade | O.E.M # | Gabriel | Upgrade | O.E.M # | Gabriel | Upgrade |
|---------|---------|---------|---------|---------|---------|---------|---------|---------|---------|---------|---------|
| 450739  | 85302   | 89420   |         |         |         |         |         |         |         |         |         |

**GENERAL TRAILER CO**

| O.E.M # | Gabriel | Upgrade | O.E.M # | Gabriel | Upgrade | O.E.M # | Gabriel | Upgrade | O.E.M # | Gabriel | Upgrade |
|---------|---------|---------|---------|---------|---------|---------|---------|---------|---------|---------|---------|
| 120-1   | 83125   |         | 12608   | 83125   |         |         |         |         |         |         |         |

**GEORGIE BOY MANUFACTURING**

| O.E.M #       | Gabriel | Upgrade | O.E.M #  | Gabriel | Upgrade | O.E.M #   | Gabriel | Upgrade | O.E.M #        | Gabriel | Upgrade |
|---------------|---------|---------|----------|---------|---------|-----------|---------|---------|----------------|---------|---------|
| 1C34-18045-AA | 83209   | 89414   | ASH-1022 | 83209   | 89414   | ASH-1229  | 83209   | 89414   | AT-620         | 83209   | 89414   |
| 1C34-18045-JA | 83209   | 89414   | ASH-1023 | 83122   | 89406   | ASH-1230  | 83122   | 89406   | AT-621         | 83122   | 89406   |
| 66153-002     | 83124   | 89407   | ASH-1136 | 83178   |         | ASH-137   | 83122   | 89406   | AT-766         | 83209   | 89414   |
| 9U94-18045-AA | 83209   | 89414   | ASH-1154 | 83177   |         | ASH-25822 | 83209   | 89414   | F4-BE5-C832-MO | 83124   | 89407   |
| 9U94-18080-AA | 83122   | 89406   | ASH-1205 | 83209   | 89414   | ASH-25823 | 83209   | 89414   |                |         |         |
| 9U9Z-18124-A  | 83209   | 89414   | ASH-1206 | 83122   | 89406   | ASH-25824 | 83122   | 89406   |                |         |         |
| 9U9Z-18125-A  | 83122   | 89406   | ASH-1228 | 83209   | 89414   | ASH-294   | 83209   | 89414   |                |         |         |

**GILLIG BROS.**

| O.E.M #      | Gabriel | Upgrade | O.E.M #  | Gabriel | Upgrade | O.E.M #      | Gabriel | Upgrade | O.E.M #         | Gabriel | Upgrade |
|--------------|---------|---------|----------|---------|---------|--------------|---------|---------|-----------------|---------|---------|
| 1583470      | 85051   |         | 57113    | 83219   |         | 82-21542-000 | 85716   |         | 90044683        | 83122   | 89406   |
| 200-171      | 85304   |         | 57131    | 83216   |         | 82-30159-000 | 85708   |         | 90044769        | 83207   | 89407   |
| 53-02132     | 85723   |         | 665568   | 85051   |         | 90-1908      | 85723   |         | 90044770        | 83207   | 89407   |
| 53-02133-000 | 85318   |         | 680009   | 85302   | 89420   | 90-1951-SP1  | 85734   |         | 90045084        | 85968   |         |
| 53-13952-000 | 85722   |         | 680333   | 85708   |         | 90-1968      | 85712   |         | 90F-1912        | 85318   |         |
| 53-14005-000 | 85723   |         | 695109   | 85723   |         | 90-2164 SP1  | 85723   |         | H53-02132-14005 | 85723   |         |
| 53-14010     | 85318   |         | 695110   | 85318   |         | 90-2423      | 85723   |         | H53-20415-006   | 85051   |         |
| 53-176       | 85304   |         | 70034    | 85302   | 89420   | 90-2627      |         | 89461   | MR6394          | 85723   |         |
| 53-24685     | 85723   |         | 82-01878 | 83122   | 89406   | 90044046     | 83123   | 89405   |                 |         |         |

**GLAVAL BUS CO.**

| O.E.M #      | Gabriel | Upgrade | O.E.M #       | Gabriel | Upgrade | O.E.M #   | Gabriel | Upgrade | O.E.M #       | Gabriel | Upgrade |
|--------------|---------|---------|---------------|---------|---------|-----------|---------|---------|---------------|---------|---------|
| 3578858C1    | 85926   |         | 4C4Z-18124-JB | 85928   |         | AA-617    | 85928   |         | FC44-18045-BB | 85181   |         |
| 3578858C2    | 85926   |         | 4C4Z-18124-QA | 83175   |         | ASH-1136  | 83178   |         | FC44-18080-AB | 85180   |         |
| 3584116C1    | 83175   |         | 4C4Z-18124-RA | 85928   |         | ASH-1154  | 83177   |         | FC4Z-18124-A  | 85181   |         |
| 3584116C2    | 83175   |         | 4C4Z-18125-B  | 83317   |         | ASH-24658 | 85181   |         | FC4Z-18124-B  | 85181   |         |
| 3584118C2    | 85928   |         | 4C4Z-18125-DA | 85926   |         | ASH-24659 | 85181   |         | FC4Z-18125-A  | 85180   |         |
| 471700011530 | 85181   |         | 501906C92     | 83317   |         | ASH-24660 | 85180   |         |               |         |         |
| 471700011531 | 85180   |         | AA-616        | 83175   |         | AT-812    | 85928   |         |               |         |         |

**GMC TRUCK**

| O.E.M #       | Gabriel | Upgrade | O.E.M #  | Gabriel | Upgrade | O.E.M #  | Gabriel | Upgrade | O.E.M #  | Gabriel | Upgrade |
|---------------|---------|---------|----------|---------|---------|----------|---------|---------|----------|---------|---------|
| 1-51630-168-1 | 83515   |         | 15174903 | 85342   |         | 21998392 | 85336   |         | 22007753 | 83303   |         |
| 1-51630-217-0 | 83114   |         | 15185643 | 83153   |         | 22002293 | 83126   | 89430   | 22007757 | 83304   |         |
| 1-51630-217-1 | 83114   |         | 15185644 | 83155   |         | 22002294 | 83304   |         | 22012065 | 85304   |         |
| 1-51630-219-1 | 83114   |         | 15588554 | 83136   |         | 22002295 | 83303   |         | 22012067 | 85700   |         |
| 12474915      | 83122   | 89406   | 15642943 | 83136   |         | 22007701 | 83126   | 89430   | 22012082 | 85702   |         |
| 12474917      | 83137   |         | 15740554 | 83137   |         | 22007702 | 83304   |         | 22012083 | 85711   |         |
| 15123676      | 83136   |         | 15887728 | 83136   |         | 22007703 | 83303   |         |          |         |         |
| 15174898      | 83136   |         | 1591501  | 85722   |         | 22007750 | 83207   | 89407   |          |         |         |
| 15174901      | 85342   |         | 15963161 | 83122   | 89406   | 22007751 | 83303   |         |          |         |         |
| 15174902      | 85071   |         | 19152843 | 83136   |         | 22007752 | 83304   |         |          |         |         |

**Important Note:** Competitive Interchanges are to be used for stocking purposes only. Where multiple crosses are identified, please reference the applications section of this catalog. / **Remarque importante:** Les interchanges concurrentiels ne s'utilisent qu'aux fins de stocks. Dans le cas de références multiples, consulter la section des applications du catalogue. / **Nota importante:** Dans le cas de références multiples, consulter la section des applications du catalogue. / **Nota importante:** Se pueden usar intercambios competitivos para propósitos de almacenamiento solamente. Cuando se identifican intercambios múltiples, consulte la sección de aplicaciones de este catálogo.

**COMPETITIVE & O.E.M. INTERCHANGE LIST**  
**Lista de Intercambios contra Competidores y Equipo Original.**  
**Liste d'interchange de produits compétitifs & d'équipement original (OEM)**

**GMC TRUCK... cont'd**

| O.E.M #    | Gabriel | Upgrade | O.E.M #    | Gabriel | Upgrade | O.E.M # | Gabriel | Upgrade | O.E.M #       | Gabriel | Upgrade |
|------------|---------|---------|------------|---------|---------|---------|---------|---------|---------------|---------|---------|
| 22012083GS | 85711   |         | 3182842    | 85711   |         | 507-23  | 85342   |         | 5544716       | 85304   |         |
| 22012090   | 85308   | 89422   | 3188599    | 85711   |         | 507-24  | 85336   |         | 5544717       | 85304   |         |
| 22012091   | 85303   | 89422   | 3188626    | 85300   | 89419   | 508-88  | 83153   |         | 5544812       | 83308   |         |
| 22012095   | 83126   | 89430   | 3188729    | 85303   | 89422   | 508-89  | 83155   |         | 5544818       | 85735   |         |
| 22012096   | 83221   |         | 3189265    | 85700   |         | 5171068 | 83216   |         | 5549899       | 83207   | 89407   |
| 22012114   | 85700   |         | 3192333    | 85700   |         | 5304059 | 85700   |         | 5549924       | 85700   |         |
| 22012131   | 85711   |         | 3192416    | 85711   |         | 5316784 | 85700   |         | 5549925       | 85304   |         |
| 22012166   | 83126   | 89430   | 3192657    | 83216   |         | 5316791 | 83219   |         | 5552111       | 85304   |         |
| 22012169   | 83221   |         | 3192890    | 83126   | 89430   | 5316792 | 85305   |         | 5552112       | 85307   |         |
| 22012196   | 83221   |         | 3192891    | 83221   |         | 5316793 | 85305   |         | 5552114       | 83216   |         |
| 22017530   | 83303   |         | 3192892    | 83221   |         | 5316794 | 85700   |         | 5552205       | 83217   |         |
| 22017531   | 83303   |         | 35901-0001 | 83209   | 89414   | 5316984 | 85313   |         | 5552206       | 83214   |         |
| 22024061   | 85704   |         | 35901-0003 | 85301   |         | 5321920 | 85307   |         | 5552207       | 83217   |         |
| 22024673   | 85710   |         | 35901-0004 | 83219   |         | 5321929 | 85307   |         | 5552208       | 83217   |         |
| 22025067   | 85704   |         | 35901-0005 | 83219   |         | 5348631 | 83203   | 89436   | 5552209       | 83215   |         |
| 22025305   | 85704   |         | 35901-0017 | 83314   |         | 5352857 | 85700   |         | 5552210       | 85308   | 89422   |
| 22045526   | 85702   |         | 37301-0016 | 85026   | 89417   | 5352858 | 85305   |         | 5552244       | 85308   | 89422   |
| 22046481   | 85702   |         | 37301-0021 | 85026   | 89417   | 5353054 | 85303   | 89422   | 5552285       | 83214   |         |
| 22046483   | 85304   |         | 37301-3202 | 85026   | 89417   | 5355798 | 85307   |         | 5552286       | 83217   |         |
| 22046485   | 85710   |         | 4939852    | 85308   | 89422   | 5357955 | 85300   | 89419   | 5552287       | 83217   |         |
| 22046489   | 85303   | 89422   | 4939967    | 85308   | 89422   | 5357956 | 85734   |         | 5552288       | 83217   |         |
| 22046499   | 85710   |         | 4940600    | 83209   | 89414   | 5357959 | 85300   | 89419   | 5552451       | 85308   | 89422   |
| 22052014   | 85702   |         | 4940601    | 83216   |         | 5361994 | 85734   |         | 5552452       | 85303   | 89422   |
| 22052336   | 85304   |         | 4940606    | 83126   | 89430   | 5374779 | 85308   | 89422   | 5552453       | 85301   |         |
| 22052424   | 85710   |         | 4940614    | 83216   |         | 5374999 | 85307   |         | 5552454       | 85302   | 89420   |
| 22064230   | 83136   |         | 4940627    | 83203   | 89436   | 5385939 | 85307   |         | 5552456       | 85307   |         |
| 22064231   | 85324   |         | 4940640    | 83216   |         | 5392387 | 85303   | 89422   | 5552527       | 85735   |         |
| 22064232   | 85071   |         | 4940650    | 83207   | 89407   | 5394448 | 85305   |         | 5554184       | 85302   | 89420   |
| 22064233   | 83136   |         | 4940654    | 83216   |         | 5394467 | 85305   |         | 5554589       | 85307   |         |
| 22064432   | 85050   |         | 4940660    | 83207   | 89407   | 5394468 | 85735   |         | 5554596       | 85303   | 89422   |
| 22064489   | 85336   |         | 4940662    | 83126   | 89430   | 5455798 | 85307   |         | 5554814       | 85302   | 89420   |
| 22064804   | 83136   |         | 4963844    | 85307   |         | 5513489 | 83216   |         | 5554959       | 83401   |         |
| 22064805   | 83136   |         | 4963853    | 83216   |         | 5513716 | 85304   |         | 5554995       | 85305   |         |
| 22064806   | 83136   |         | 4963854    | 83216   |         | 5516459 | 85305   |         | 5559363       | 83203   | 89436   |
| 22064807   | 83136   |         | 4964853    | 83217   |         | 5522781 | 85735   |         | 5585939       | 85307   |         |
| 22065218   | G63347  |         | 4974401    | 85700   |         | 5522794 | 85308   | 89422   | 684280        | 83209   | 89414   |
| 22065251   | 85030   | 89440   | 4975429    | 85300   | 89419   | 5522818 | 85305   |         | 8-51630-666-0 | 85012   | 89413   |
| 22099889   | 85336   |         | 4975467    | 83207   | 89407   | 5527001 | 85300   | 89419   | 8-94057-593-0 | 83114   |         |
| 2212169    | 83221   |         | 4975472    | 83161   |         | 5527271 | 85700   |         | 8-94454-986-0 | 83515   |         |
| 22165187   | 83136   |         | 4975479    | 83400   |         | 5527272 | 85700   |         | 8-94454-987-0 | 83515   |         |
| 22165188   | 83136   |         | 4975480    | 83400   |         | 5527606 | 85305   |         | 8-97083-029-0 | 83515   |         |
| 22165189   | 83136   |         | 4975494    | 83207   | 89407   | 5531027 | 85301   |         | 8-97201-960-0 | 83515   |         |
| 22166442   | 83136   |         | 4975497    | 83126   | 89430   | 5531435 | 85307   |         | 8-97253-620-0 | 83515   |         |
| 3082284    | 83400   |         | 4975501    | 85700   |         | 5531436 | 85307   |         | 8-97253664-0  | 83159   |         |
| 3166657    | 85700   |         | 4975510    | 83221   |         | 5531437 | 85307   |         | 8-97253665-0  | 83159   |         |
| 3171068    | 83216   |         | 4975511    | 83303   |         | 5532026 | 85304   |         | 87-2520-00003 | 85704   |         |
| 3171069    | 85304   |         | 4975516    | 85702   |         | 5532425 | 83207   | 89407   | 88963409      | 85336   |         |
| 3171462    | 83126   | 89430   | 4975518    | 85704   |         | 5532433 | 83207   | 89407   | 88982682      | 83136   |         |
| 3171696    | 85307   |         | 4975538    | 85700   |         | 5532675 | 85307   |         | 88982684      | 83136   |         |
| 3172948    | 85303   | 89422   | 4975549    | 83216   |         | 5533699 | 85302   | 89420   | 88982685      | 85342   |         |
| 3175509    | 85735   |         | 4975550    | 85702   |         | 5534430 | 85303   | 89422   | 88982686      | 85071   |         |
| 3178106    | 85700   |         | 4975552    | 85711   |         | 5534439 | 85304   |         | 88982687      | 85342   |         |
| 3178157    | 85700   |         | 4984526    | 83216   |         | 5534447 | 85303   | 89422   | 88982688      | 85336   |         |
| 3178233    | 85734   |         | 507-16     | 85702   |         | 5544060 | 85302   | 89420   | 898098-0580   | 83159   |         |
| 3178507    | 85700   |         | 507-19     | 85700   |         | 5544112 | 83216   |         | 898098-0581   | 83159   |         |
| 3178995    | 85700   |         | 507-22     | 85342   |         | 5544581 | 85302   | 89420   | 898098-0590   | 83159   |         |

**Important Note:** Competitive Interchanges are to be used for stocking purposes only. Where multiple crosses are identified, please reference the applications section of this catalog. / **Remarque importante:** Les interchanges concurrentiels ne s'utilisent qu'aux fins de stocks. Dans le cas de références multiples, consulter la section des applications du catalogue. / **Nota importante:** Dans le cas de références multiples, consulter la section des applications du catalogue. / **Nota importante:** Se pueden usar intercambios competitivos para propósitos de almacenamiento solamente. Cuando se identifican intercambios múltiples, consulte la sección de aplicaciones de este catálogo.

**COMPETITIVE & O.E.M. INTERCHANGE LIST**  
**Lista de Intercambios contra Competidores y Equipo Original.**  
**Liste d'interchange de produits compétitifs & d'équipement original (OEM)**

**GMC TRUCK... cont'd**

| O.E.M #       | Gabriel | Upgrade | O.E.M #       | Gabriel | Upgrade | O.E.M #  | Gabriel | Upgrade | O.E.M #   | Gabriel | Upgrade |
|---------------|---------|---------|---------------|---------|---------|----------|---------|---------|-----------|---------|---------|
| 898098-1250   | 83515   |         | 94051090      | 83114   |         | 97201960 | 83515   |         | 98098058  | 83159   |         |
| 898098-1270   | 83515   |         | 94057593      | 83114   |         | 97253616 | 83515   |         | 98098059  | 83159   |         |
| 9-51630-647-1 | 83515   |         | 94454987      | 83515   |         | 97253620 | 83515   |         | 98098125  | 83515   |         |
| 9-51630-666-0 | 85012   | 89413   | 97-2210-00156 | 85702   |         | 97253621 | 83515   |         | 98098127  | 83515   |         |
| 9-51630-666-2 | 85012   | 89413   | 97-2210-00164 | 85708   |         | 97253623 | 83515   |         | 98232671  | 83515   |         |
| 90044769      | 83207   | 89407   | 97-2210-00170 | 85733   |         | 97253651 | 83404   |         | L-12706   | 83155   |         |
| 90044770      | 83207   | 89407   | 97083027      | 83515   |         | 97253664 | 83159   |         | U0109-014 | 83400   |         |
| 94033786      | 83114   |         | 97083029      | 83515   |         | 97253665 | 83159   |         |           |         |         |

**GMC TRUCK CAB SHOCKS**

| O.E.M #   | Gabriel | Upgrade | O.E.M #   | Gabriel | Upgrade | O.E.M #   | Gabriel | Upgrade | O.E.M # | Gabriel | Upgrade |
|-----------|---------|---------|-----------|---------|---------|-----------|---------|---------|---------|---------|---------|
| 1201-1043 | 83025   |         | 1202-0032 | 83016   |         | 1202-1043 | 83025   |         |         |         |         |
| 1202-0012 | 83023   |         | 1202-0054 | 83021   |         |           |         |         |         |         |         |

**GOSHEN COACH**

| O.E.M #  | Gabriel | Upgrade | O.E.M #  | Gabriel | Upgrade | O.E.M # | Gabriel | Upgrade | O.E.M # | Gabriel | Upgrade |
|----------|---------|---------|----------|---------|---------|---------|---------|---------|---------|---------|---------|
| ASH-1136 | 83178   |         | ASH-1154 | 83177   |         |         |         |         |         |         |         |

**GRANNING SUSPENSION**

| O.E.M # | Gabriel | Upgrade | O.E.M #   | Gabriel | Upgrade | O.E.M # | Gabriel | Upgrade | O.E.M # | Gabriel | Upgrade |
|---------|---------|---------|-----------|---------|---------|---------|---------|---------|---------|---------|---------|
| 1085    | 83214   |         | 680162    | 85300   | 89419   | OE12425 | 83214   |         |         |         |         |
| 2697    | 85712   |         | 701071-01 | 646155  |         |         |         |         |         |         |         |

**GREAT DANE TRAILER**

| O.E.M #    | Gabriel | Upgrade | O.E.M #    | Gabriel | Upgrade | O.E.M #    | Gabriel | Upgrade | O.E.M #     | Gabriel | Upgrade |
|------------|---------|---------|------------|---------|---------|------------|---------|---------|-------------|---------|---------|
| 18163-01   | 83207   | 89407   | HENS-20002 | 85000   | 89436   | HENS-23649 | 85064   |         | REY18165-01 | 85006   |         |
| 18164-01   | 83122   | 89406   | HENS-20126 | 85323   | 89436   | HENS-24088 | 83128   | 89436   |             |         |         |
| 18165-01   | 85006   |         | HENS-21292 | 85052   |         | HENS-24088 | 85000   | 89436   |             |         |         |
| HENS-20001 | 83128   | 89436   | HENS-23566 | 85000   | 89436   | MER202447  | 85919   |         |             |         |         |

**GRECH MOTORS**

| O.E.M #  | Gabriel | Upgrade | O.E.M #  | Gabriel | Upgrade | O.E.M # | Gabriel | Upgrade | O.E.M # | Gabriel | Upgrade |
|----------|---------|---------|----------|---------|---------|---------|---------|---------|---------|---------|---------|
| ASH-1136 | 83178   |         | ASH-1154 | 83177   |         |         |         |         |         |         |         |

**GREYHOUND BUS**

| O.E.M #     | Gabriel | Upgrade | O.E.M # | Gabriel | Upgrade | O.E.M # | Gabriel | Upgrade | O.E.M # | Gabriel | Upgrade |
|-------------|---------|---------|---------|---------|---------|---------|---------|---------|---------|---------|---------|
| 12B-5-1     | 85735   |         | 3166657 | 85700   |         | 3178157 | 85700   |         | 690029  | 85700   |         |
| 12TA-01-013 | 85303   | 89422   | 3178154 | 85735   |         | 3192333 | 85700   |         | 74413   | 85313   |         |

**GRUMMAN BUS**

| O.E.M #  | Gabriel | Upgrade | O.E.M #       | Gabriel | Upgrade | O.E.M #       | Gabriel | Upgrade | O.E.M #       | Gabriel | Upgrade |
|----------|---------|---------|---------------|---------|---------|---------------|---------|---------|---------------|---------|---------|
| 22024506 | 85703   |         | 690029        | 85700   |         | 97-2201-00004 | 85703   |         | 97-2210-00003 | 85704   |         |
| 22025066 | 85703   |         | 97-2201-00001 | 85703   |         | 97-2201-00005 | 85703   |         | 97-2210-00004 | 85704   |         |
| 22025067 | 85704   |         | 97-2201-00002 | 85703   |         | 97-2210-00001 | 85704   |         | 97-2210-00005 | 85704   |         |
| 22025305 | 85704   |         | 97-2201-00003 | 85703   |         | 97-2210-00002 | 85704   |         |               |         |         |

**GULF STREAM COACH**

| O.E.M #      | Gabriel | Upgrade | O.E.M #      | Gabriel | Upgrade | O.E.M #      | Gabriel | Upgrade | O.E.M #  | Gabriel | Upgrade |
|--------------|---------|---------|--------------|---------|---------|--------------|---------|---------|----------|---------|---------|
| 141700131809 | 85029   |         | 16-16737-000 | 83160   |         | 16-18103-000 | 85900   |         | ASH-1154 | 83177   |         |
| 141700131810 | 83160   |         | 16-16873-000 | 85029   |         | 481700000493 | 85900   |         |          |         |         |
| 16-16736-000 | 85029   |         | 16-16874-000 | 83160   |         | ASH-1136     | 83178   |         |          |         |         |

**HARDEE MFG**

| O.E.M # | Gabriel | Upgrade | O.E.M # | Gabriel | Upgrade | O.E.M # | Gabriel | Upgrade | O.E.M # | Gabriel | Upgrade |
|---------|---------|---------|---------|---------|---------|---------|---------|---------|---------|---------|---------|
| 8030223 | 83207   | 89407   | AS789B  | 85014   |         |         |         |         |         |         |         |

**HAUSMAN**

| O.E.M # | Gabriel | Upgrade | O.E.M # | Gabriel | Upgrade | O.E.M # | Gabriel | Upgrade | O.E.M # | Gabriel | Upgrade |
|---------|---------|---------|---------|---------|---------|---------|---------|---------|---------|---------|---------|
| 695110  | 85318   |         | 695119  | 85702   |         | 695198  | 85706   |         |         |         |         |

**HENDRICKSON TRAILER SUSPENSION SYSTEMS**

| O.E.M #   | Gabriel | Upgrade | O.E.M # | Gabriel | Upgrade | O.E.M # | Gabriel | Upgrade | O.E.M # | Gabriel | Upgrade |
|-----------|---------|---------|---------|---------|---------|---------|---------|---------|---------|---------|---------|
| 57905-2   | 85006   |         | 665246  | 85043   |         | 665532  | 85013   | 89414   | 665698  | 85911   |         |
| 60675-004 | 85006   |         | 665267  | 85029   |         | 665533  | 85005   | 89430   | 665733  | 85045   |         |
| 654951    | 85000   | 89436   | 665405  | 85030   | 89440   | 665536  | 85000   | 89436   | 665756  | 85000   | 89436   |
| 659024    | 85052   |         | 665406  | 85010   |         | 665693  | 85064   |         | 665758  | 85064   |         |
| 665190    | 85006   |         | 665531  | 85000   | 89436   | 665694  | 85052   |         | 665759  | 85052   |         |

**Important Note:** Competitive Interchanges are to be used for stocking purposes only. Where multiple crosses are identified, please reference the applications section of this catalog. / **Remarque importante:** Les interchanges concurrentiels ne s'utilisent qu'aux fins de stocks. Dans le cas de références multiples, consulter la section des applications du catalogue. / **Nota importante:** Dans le cas de références multiples, consulter la section des applications du catalogue. / **Nota importante:** Se pueden usar intercambios competitivos para propósitos de almacenamiento solamente. Cuando se identifican intercambios múltiples, consulte la sección de aplicaciones de este catálogo.

**COMPETITIVE & O.E.M. INTERCHANGE LIST**  
**Lista de Intercambios contra Competidores y Equipo Original.**  
**Liste d'interchange de produits compétitifs & d'équipement original (OEM)**

**HENDRICKSON TRAILER SUSPENSION SYSTEMS... cont'd**

| O.E.M #   | Gabriel | Upgrade | O.E.M #  | Gabriel | Upgrade | O.E.M #  | Gabriel | Upgrade | O.E.M #  | Gabriel | Upgrade |
|-----------|---------|---------|----------|---------|---------|----------|---------|---------|----------|---------|---------|
| 665760    | 85045   |         | A-20887  | 85005   | 89430   | B-23744  | 85344   |         | S-22312  | 85939   |         |
| 665761    | 85911   |         | A-20889  | 85323   | 89436   | B-24023  | 85738   |         | S-2232   | 85005   | 89430   |
| 665763    | 85079   |         | A-21292  | 85052   |         | B-24088  | 83128   | 89436   | S-22345  | 85911   |         |
| 665764    | 85029   |         | A-2160   | 85014   |         | B-24088  | 85000   | 89436   | S-2240   | 85013   | 89414   |
| 665765    | 83150   |         | A-2212   | 85029   |         | B-24125  | 85323   | 89436   | S-22715  | 85000   | 89436   |
| 665766    | 85000   | 89436   | A-2213   | 85010   |         | B-24579  | 85939   |         | S-22862  | 85045   |         |
| 665767    | 85045   |         | A-2218   | 85030   | 89440   | B-25174  | 85029   |         | S-23013  | 85000   | 89436   |
| 671779    |         | 89414   | A-2230   | 85005   | 89430   | B-25436  | 85916   | 89430   | S-23014  | 85738   |         |
| 671948    | 85000   | 89436   | A-2232   | 85005   | 89430   | B-25437  | 85337   |         | S-23290  | 83150   |         |
| 680102    | 85712   |         | A-2240   | 85013   | 89414   | B-25515  | 85338   |         | S-23315  | 85029   |         |
| 680341    | 85323   | 89436   | A-2240-1 | 85043   |         | B-26652  | 85000   | 89436   | S-23316  | 85382   |         |
| 680463    |         | 89440   | A-2471   | 85006   |         | B-27058  | 83128   | 89436   | S-23361  | 85911   |         |
| 680467    | 85323   | 89436   | A-4084   | 85005   | 89430   | B-27747  | 85911   |         | S-23362  |         | 89437   |
| 680509    | 85738   |         | A-4089   | 83209   | 89414   | B-29432  | 85323   | 89436   | S-23548  | 85079   |         |
| 680565    | 85738   |         | A-4890   | 85712   |         | B-29678  | 85911   |         | S-23566  | 85000   | 89436   |
| 680566    | 85938   |         | A-6156   | 85301   |         | B-29826  | 85338   |         | S-23649  | 85064   |         |
| 680568    | 85323   | 89436   | B-20345  | 85345   |         | B-33312  | 85338   |         | S-23650  | 85052   |         |
| 680570    |         | 89437   | B-21553  | 85738   |         | B-33313  | 85338   |         | S-23651  | 85045   |         |
| 680571    | 85738   |         | B-21699  | 87018   |         | NS500699 | 85005   | 89430   | S-23743  | 85938   |         |
| 680573    | 85939   |         | B-21832  | 85323   | 89436   | S-10348  | 85043   |         | S-23744  | 85344   |         |
| 680579    | 85939   |         | B-21936  | 85064   |         | S-14583  | 85000   | 89436   | S-24023  | 85738   |         |
| 680614    | 85338   |         | B-21947  | 85052   |         | S-1667   | 85000   | 89436   | S-24088  | 83128   | 89436   |
| 680616    |         | 89430   | B-21994  | 85938   |         | S-1668   | 85000   | 89436   | S-24088  | 85000   | 89436   |
| 680617    | 85337   |         | B-21995  | 85344   |         | S-20001  | 83128   | 89436   | S-24125  | 85323   | 89436   |
| 680702    | 85323   | 89436   | B-22311  | 85045   |         | S-20002  | 85000   | 89436   | S-24579  | 85939   |         |
| 680756    | 85323   | 89436   | B-22312  | 85939   |         | S-20126  | 85323   | 89436   | S-2471   | 85006   |         |
| 680769    | 85911   |         | B-22345  | 85911   |         | S-20345  | 85345   |         | S-25436  | 85916   | 89430   |
| 680776    | 85338   |         | B-22715  | 85000   | 89436   | S-20886  | 85030   | 89440   | S-25437  | 85337   |         |
| 98583-019 | 85323   | 89436   | B-22862  | 85045   |         | S-20887  | 85005   | 89430   | S-25515  | 85338   |         |
| 98583-020 |         | 89414   | B-23013  | 85000   | 89436   | S-20889  | 85323   | 89436   | S-26652  | 85000   | 89436   |
| A-10023   | 85000   | 89436   | B-23014  | 85738   |         | S-21292  | 85052   |         | S-29432  | 85323   | 89436   |
| A-10348   | 85043   |         | B-23290  | 83150   |         | S-21553  | 85738   |         | S-29678  | 85911   |         |
| A-11931   | 85000   | 89436   | B-23315  | 85029   |         | S-2160   | 85014   |         | S-29826  | 85338   |         |
| A-14496   | 646155  |         | B-23316  | 85382   |         | S-21699  | 87018   |         | S-33312  | 85338   |         |
| A-14583   | 85000   | 89436   | B-23361  | 85911   |         | S-21832  | 85323   | 89436   | S-33313  | 85338   |         |
| A-1667    | 85000   | 89436   | B-23362  |         | 89437   | S-21936  | 85064   |         | S-33313L | 85338   |         |
| A-1668    | 85000   | 89436   | B-23548  | 85079   |         | S-21947  | 85052   |         | S-4084   | 85005   | 89430   |
| A-20001   | 83128   | 89436   | B-23566  | 85000   | 89436   | S-2212   | 85029   |         | S-4089   | 83209   | 89414   |
| A-20002   | 85000   | 89436   | B-23649  | 85064   |         | S-2213   | 85010   |         | S-4890   | 85712   |         |
| A-20126   | 85323   | 89436   | B-23650  | 85052   |         | S-2218   | 85030   | 89440   |          |         |         |
| A-20345   | 85345   |         | B-23651  | 85045   |         | S-2230   | 85005   | 89430   |          |         |         |
| A-20886   | 85030   | 89440   | B-23743  | 85938   |         | S-22311  | 85045   |         |          |         |         |

**HENDRICKSON TRUCK SUSPENSION SYSTEMS**

| O.E.M #      | Gabriel | Upgrade | O.E.M #   | Gabriel | Upgrade | O.E.M #    | Gabriel | Upgrade | O.E.M #    | Gabriel | Upgrade |
|--------------|---------|---------|-----------|---------|---------|------------|---------|---------|------------|---------|---------|
| 12738        | 83225   |         | 47902-25  | 83125   |         | 57241-004  | 83110   |         | 58913-007  | 85959   |         |
| 471700000456 | 85959   |         | 47902-26  | 83144   |         | 57241-006  | 83111   |         | 58913-007L | 85959   |         |
| 471700006269 | 85932   | 89453   | 47902-27  | 83123   | 89405   | 57241-006L | 83111   |         | 58913-008  | 85959   |         |
| 471700131545 | 85006   |         | 47902-28  | 85013   | 89414   | 57324-1    | 85036   | 89405   | 58913-008L | 85959   |         |
| 47902-11     | 83207   | 89407   | 47902-29  | 83149   |         | 57324-11   | 85305   |         | 58913-009  | 85959   |         |
| 47902-13     | 83122   | 89406   | 47902-3   | 85005   | 89430   | 57324-2    | 85976   |         | 58913-009L | 85959   |         |
| 47902-15     | 83137   |         | 47902-8   | 83122   | 89406   | 57324-3    | 85916   | 89430   | 58913-011  | 85959   |         |
| 47902-18     | 85030   | 89440   | 47902-9   | 83123   | 89405   | 57324-5    | 85903   |         | 58913-011L | 85959   |         |
| 47902-19     | 83123   | 89405   | 503610C2  | 83207   | 89407   | 57324-6    | 85904   |         | 58913-012  | 85932   | 89453   |
| 47902-20     | 85036   | 89405   | 5554596   | 85303   | 89422   | 57905-1    | 85976   |         |            |         |         |
| 47902-21     | 85976   |         | 57241-001 | 83111   |         | 58623-1    | 85978   |         |            |         |         |
| 47902-22     | 85916   | 89430   | 57241-002 | 83109   |         | 58913-003  | 85932   | 89453   |            |         |         |
| 47902-24     | 83137   |         | 57241-003 | 83112   |         | 58913-003L | 85932   | 89453   |            |         |         |

**Important Note:** Competitive Interchanges are to be used for stocking purposes only. Where multiple crosses are identified, please reference the applications section of this catalog. / **Remarque importante:** Les interchanges concurrentiels ne s'utilisent qu'aux fins de stocks. Dans le cas de références multiples, consulter la section des applications du catalogue. / **Nota importante:** Dans le cas de références multiples, consulter la section des applications du catalogue. / **Nota importante:** Se pueden usar intercambios competitivos para propósitos de almacenamiento solamente. Cuando se identifican intercambios múltiples, consulte la sección de aplicaciones de este catálogo.

**COMPETITIVE & O.E.M. INTERCHANGE LIST**  
**Lista de Intercambios contra Competidores y Equipo Original.**  
**Liste d'interchange de produits compétitifs & d'équipement original (OEM)**

**HENDRICKSON TRUCK SUSPENSION SYSTEMS... cont'd**

| O.E.M #    | Gabriel | Upgrade | O.E.M #    | Gabriel | Upgrade | O.E.M #    | Gabriel | Upgrade | O.E.M #    | Gabriel | Upgrade |
|------------|---------|---------|------------|---------|---------|------------|---------|---------|------------|---------|---------|
| 58913-012L | 85932   | 89453   | 60670-004  | 83123   | 89405   | 60680-004L | 83143   |         | 65992-002L | 85955   |         |
| 59048-001  | 83148   |         | 60670-005  | 83137   |         | 60680-005  | 83142   |         | 65992-003  | 85959   |         |
| 59057-001  | 83137   |         | 60670-006  | 83147   |         | 60680-005L | 83142   |         | 65992-006  | 85986   |         |
| 59057-002  | 85036   | 89405   | 60670-006L | 83147   |         | 60680-009  | 85083   |         | 665816     | 85072   |         |
| 59305-1    | 85979   |         | 60670-007  | 83144   |         | 60680-012  | 85083   |         | 665892     | 85072   |         |
| 59483-000  | 85919   |         | 60670-007L | 83144   |         | 60680-012L | 85083   |         | 671006     | 85036   | 89405   |
| 59851-1    | 85976   |         | 60670-008  | 83123   | 89405   | 60685-001  | 85977   |         | 671007     | 83137   |         |
| 59852-1    | 85977   |         | 60670-008L | 83123   | 89405   | 60998-001  | 85006   |         | 671009     | 85919   |         |
| 59852-2    | 85977   |         | 60670-009  | 85013   | 89414   | 60998-002  | 85919   |         | 671030     | 85083   |         |
| 60657-003  | 85072   |         | 60670-010  | 83149   |         | 60998-002L | 85919   |         | 671063     | 85083   |         |
| 60657-003L | 85072   |         | 60670-011  | 83148   |         | 60998-003  | 85006   |         | 671105     | 85072   |         |
| 60657-005  | 85087   |         | 60670-012  | 83168   |         | 64838-001  | 85933   | 89454   | 671603     | 85919   |         |
| 60657-005L | 85087   |         | 60670-013  | 83148   |         | 64838-001L | 85933   | 89454   | 671606     | 85955   |         |
| 60657-006  | 85102   |         | 60670-014  | 83166   |         | 64838-002  | 85933   | 89454   | 671611     | 85955   |         |
| 60657-007  | 85072   |         | 60670-017  | 83148   |         | 64838-002L | 85933   | 89454   | 671704     | 85904   |         |
| 60657-010  | 85102   |         | 60670-018  | 83166   |         | 64838-003  | 85933   | 89454   | 671764     | 85967   |         |
| 60657-011  | 85102   |         | 60670-019  | 83166   |         | 64838-003L | 85933   | 89454   | 671792     | 85965   |         |
| 60665-003  | 83137   |         | 60670-020  | 83148   |         | 654890     | 83207   | 89407   | 671793     | 85966   |         |
| 60665-004  | 85036   | 89405   | 60670-12   | 83168   |         | 654891     | 83149   |         | 671798     | 85962   |         |
| 60665-004L | 85036   | 89405   | 60675-001  | 85978   |         | 654894     | 83123   | 89405   | 672009     | 85903   |         |
| 60665-005  | 85919   |         | 60675-001L | 85978   |         | 654895     | 83137   |         | 680091     | 85303   | 89422   |
| 60665-005L | 85919   |         | 60675-002  | 85979   |         | 654896     | 83147   |         | 680600     | 85305   |         |
| 60665-008  | 85978   |         | 60675-002L | 85979   |         | 654897     | 83144   |         | 70018      | 85303   | 89422   |
| 60665-009  | 85904   |         | 60675-003  | 85976   |         | 654898     | 83123   | 89405   | 70021      | 85303   | 89422   |
| 60665-011  | 85967   |         | 60675-003L | 85976   |         | 654899     | 85013   | 89414   | 70088      | 85307   |         |
| 60665-013  | 85965   |         | 60675-005  | 85980   |         | 654900     | 83149   |         | 98583-005  | 83168   |         |
| 60665-014  | 85962   |         | 60675-005L | 85980   |         | 654903     | 83111   |         | 98583-006  | 83148   |         |
| 60665-015  | 85966   |         | 60675-006  | 85909   |         | 654904     | 83109   |         | 98583-016  | 83147   |         |
| 60665-018  | 85961   |         | 60675-006L | 85909   |         | 654905     | 83112   |         | 98583-032  | 85072   |         |
| 60665-018L | 85961   |         | 60675-014  | 85978   |         | 659000     | 83148   |         | A-14496    | 646155  |         |
| 60665-020  | 85919   |         | 60675-12   | 85638   |         | 659004     | 83123   | 89405   | AE76164-3  | 85307   |         |
| 60665-024  | 85903   |         | 60675-8Q   | 85976   |         | 659048     | 83143   |         | AE76164-4  | 83225   |         |
| 60665-025  | 85036   | 89405   | 60680-001  | 83111   |         | 659049     | 83142   |         | BE76164-2  | 85303   | 89422   |
| 60665-025L | 85036   | 89405   | 60680-001L | 83111   |         | 659155     | 83147   |         | BE76164-3  | 85307   |         |
| 60670-001  | 83123   | 89405   | 60680-002  | 83109   |         | 659202     | 83148   |         | BE76164-4  | 83225   |         |
| 60670-002  | 83207   | 89407   | 60680-003  | 83112   |         | 659292     | 83148   |         |            |         |         |
| 60670-002L | 83207   | 89407   | 60680-003L | 83112   |         | 65992-001  | 85955   |         |            |         |         |
| 60670-003  | 83149   |         | 60680-004  | 83143   |         | 65992-002  | 85955   |         |            |         |         |

**HIGHWAY PRODUCT**

| O.E.M #  | Gabriel | Upgrade | O.E.M #  | Gabriel | Upgrade | O.E.M # | Gabriel | Upgrade | O.E.M # | Gabriel | Upgrade |
|----------|---------|---------|----------|---------|---------|---------|---------|---------|---------|---------|---------|
| A1-6-134 | 83207   | 89407   | A1-6-135 | 83203   | 89436   |         |         |         |         |         |         |

**HINO**

| O.E.M #     | Gabriel | Upgrade | O.E.M #     | Gabriel | Upgrade | O.E.M #     | Gabriel | Upgrade | O.E.M #     | Gabriel | Upgrade |
|-------------|---------|---------|-------------|---------|---------|-------------|---------|---------|-------------|---------|---------|
| 34802       | 83216   |         | 48511-37320 | 83518   |         | 48530-2510  | 83216   |         | 66639       | G63610  |         |
| 48500-1800  | 83216   |         | 48511-80162 | 83518   |         | 48530-3280  | G63440  |         | S4850-01941 | 83141   |         |
| 48500-1801  | 83216   |         | 48530-1120  | 83104   |         | 48530E0100  | 83166   |         | S4850-01950 | G63610  |         |
| 48500-1940  | 83141   |         | 48530-1460  | 83215   |         | 48531-37361 | 83519   |         | S4850-02750 | G63610  |         |
| 48500-1941  | 83141   |         | 48530-1620  | 83104   |         | 48531-37362 | 83519   |         | S4850-03710 | 83126   | 89430   |
| 48500-1950  | G63610  |         | 48530-1770  | 83215   |         | 60670-012   | 83168   |         | S4850-03720 | 83140   |         |
| 48500-2750  | G63610  |         | 48530-1880  | 83362   |         | 60670-013   | 83148   |         | S4853-01900 | 83104   |         |
| 48500-3710  | 83126   | 89430   | 48530-1890  | 83104   |         | 60670-014   | 83166   |         | S4853-01910 | 83216   |         |
| 48500-3720  | 83140   |         | 48530-1900  | 83104   |         | 60670-018   | 83166   |         | S4853-02510 | 83216   |         |
| 48500-E0420 | 83391   |         | 48530-1910  | 83216   |         | 60670-019   | 83166   |         | S4853-03280 | G63440  |         |
| 485003710A  | 83126   | 89430   | 48530-2050  | 83217   |         | 60670-020   | 83148   |         |             |         |         |

**Important Note:** Competitive Interchanges are to be used for stocking purposes only. Where multiple crosses are identified, please reference the applications section of this catalog. / **Remarque importante:** Les interchanges concurrentiels ne s'utilisent qu'aux fins de stocks. Dans le cas de références multiples, consulter la section des applications du catalogue. / **Nota importante:** Dans le cas de références multiples, consulter la section des applications du catalogue. / **Nota importante:** Se pueden usar intercambios competitivos para propósitos de almacenamiento solamente. Cuando se identifican intercambios múltiples, consulte la sección de aplicaciones de este catálogo.



# COMPETITIVE & O.E.M. INTERCHANGE LIST

## Lista de Intercambios contra Competidores y Equipo Original.

### Liste d'interchange de produits compétitifs & d'équipement original (OEM)

#### HOBBS TRAILERS

| O.E.M # | Gabriel | Upgrade | O.E.M # | Gabriel | Upgrade | O.E.M # | Gabriel | Upgrade | O.E.M # | Gabriel | Upgrade |
|---------|---------|---------|---------|---------|---------|---------|---------|---------|---------|---------|---------|
| 680117  | 85300   | 89419   |         |         |         |         |         |         |         |         |         |

#### HOLIDAY RAMBLER

| O.E.M #       | Gabriel | Upgrade | O.E.M #      | Gabriel | Upgrade | O.E.M #        | Gabriel | Upgrade | O.E.M #        | Gabriel | Upgrade |
|---------------|---------|---------|--------------|---------|---------|----------------|---------|---------|----------------|---------|---------|
| 1C34-18045-AA | 83209   | 89414   | 9U9Z-18125-A | 83122   | 89406   | ASH-137        | 83122   | 89406   | F4-BE5-B492-HO | 85125   |         |
| 1C34-18045-JA | 83209   | 89414   | ASH-1022     | 83209   | 89414   | ASH-25822      | 83209   | 89414   | F4-BE5-F324-HO | 85125   |         |
| 24-153249     | 85125   |         | ASH-1023     | 83122   | 89406   | ASH-25823      | 83209   | 89414   | F4-BE5-F325-HO | 85124   |         |
| 24-153256     | 85124   |         | ASH-1136     | 83178   |         | ASH-25824      | 83122   | 89406   | U0109-007      | G63183  |         |
| 24-186537     | 85126   |         | ASH-1154     | 83177   |         | ASH-294        | 83209   | 89414   | W0005662       | 85125   |         |
| 24-186629     | 85125   |         | ASH-1205     | 83209   | 89414   | AT-620         | 83209   | 89414   | W0005663       | 85124   |         |
| 90044794      | 83127   |         | ASH-1206     | 83122   | 89406   | AT-621         | 83122   | 89406   | W0006254       | 85125   |         |
| 9U94-18045-AA | 83209   | 89414   | ASH-1228     | 83209   | 89414   | AT-766         | 83209   | 89414   |                |         |         |
| 9U94-18080-AA | 83122   | 89406   | ASH-1229     | 83209   | 89414   | F4-BE5-A011-HO | 85126   |         |                |         |         |
| 9U9Z-18124-A  | 83209   | 89414   | ASH-1230     | 83122   | 89406   | F4-BE5-A832-MO | 85125   |         |                |         |         |

#### HOLLAND - BINKLEY

| O.E.M # | Gabriel | Upgrade | O.E.M # | Gabriel | Upgrade | O.E.M # | Gabriel | Upgrade | O.E.M # | Gabriel | Upgrade |
|---------|---------|---------|---------|---------|---------|---------|---------|---------|---------|---------|---------|
| 680298  | 85321   |         | 6898    | 83125   |         |         |         |         |         |         |         |

#### HUTCHENS SUSPENSION

| O.E.M # | Gabriel | Upgrade | O.E.M # | Gabriel | Upgrade | O.E.M # | Gabriel | Upgrade | O.E.M # | Gabriel | Upgrade |
|---------|---------|---------|---------|---------|---------|---------|---------|---------|---------|---------|---------|
| 9423-00 | 83203   | 89436   |         |         |         |         |         |         |         |         |         |

#### HYSTER

| O.E.M # | Gabriel | Upgrade | O.E.M # | Gabriel | Upgrade | O.E.M # | Gabriel | Upgrade | O.E.M # | Gabriel | Upgrade |
|---------|---------|---------|---------|---------|---------|---------|---------|---------|---------|---------|---------|
| 650150  | 83217   |         | 73516   | 83217   |         |         |         |         |         |         |         |

#### IC CORPORATION

| O.E.M #    | Gabriel | Upgrade | O.E.M #   | Gabriel | Upgrade | O.E.M #   | Gabriel | Upgrade | O.E.M #    | Gabriel | Upgrade |
|------------|---------|---------|-----------|---------|---------|-----------|---------|---------|------------|---------|---------|
| 1660846C92 | 83101   |         | 3578858C2 | 85926   |         | 3902993C3 | 83135   |         | 65992-006  | 85986   |         |
| 1675455C1  | 85003   | 89411   | 3601600C3 | 85082   |         | 472412C91 | 83456   | 89447   | H65992-006 | 85986   |         |
| 2018987C1  | 85003   | 89411   | 3604282C1 | 85351   |         | 501553C91 | 85003   | 89411   | OE13402S   | 83163   |         |
| 2200327C1  | 85332   |         | 3605735C1 | 83156   |         | 501906C91 | 83317   |         | OE13424S   | 83317   |         |
| 3533356C3  | 83169   |         | 3605735C2 | 83156   |         | 501906C92 | 83317   |         |            |         |         |
| 3578105C1  | 83163   |         | 3902993C1 | 83135   |         | 537524C91 | 83123   | 89405   |            |         |         |
| 3578105C2  | 83163   |         | 3902993C2 | 83135   |         | 6127088C1 | 83163   |         |            |         |         |

#### INGERSALL MACHINE

| O.E.M # | Gabriel | Upgrade | O.E.M # | Gabriel | Upgrade | O.E.M # | Gabriel | Upgrade | O.E.M # | Gabriel | Upgrade |
|---------|---------|---------|---------|---------|---------|---------|---------|---------|---------|---------|---------|
| 665472  | 665472  |         | 665904  | 665472  |         |         |         |         |         |         |         |

#### INGERSOLL AXLES

| O.E.M #   | Gabriel | Upgrade | O.E.M #   | Gabriel | Upgrade | O.E.M #   | Gabriel | Upgrade | O.E.M #   | Gabriel | Upgrade |
|-----------|---------|---------|-----------|---------|---------|-----------|---------|---------|-----------|---------|---------|
| 653511-01 | 85323   | 89436   | 653511-02 | 85938   |         | 653511-03 | 85045   |         | 653511-04 | 85052   |         |

#### INTERNATIONAL (NAVISTAR)

| O.E.M #    | Gabriel | Upgrade | O.E.M #   | Gabriel | Upgrade | O.E.M #    | Gabriel | Upgrade | O.E.M #   | Gabriel | Upgrade |
|------------|---------|---------|-----------|---------|---------|------------|---------|---------|-----------|---------|---------|
| 1660846C91 | 83101   |         | 2039549C1 | 85333   |         | 288920C91  | 83225   |         | 320444C91 | 85012   | 89413   |
| 1660846C92 | 83101   |         | 2039565C1 | 83100   |         | 288921C91  | 83225   |         | 329316C92 | 85012   | 89413   |
| 1663471C1  | 83103   |         | 204994R91 | 83225   |         | 288921R92  | 83225   |         | 350425C1  | 85300   | 89419   |
| 1663606C91 | 85027   | 89418   | 206620R91 | 83216   |         | 293009C91  | 85308   | 89422   | 350426C1  | 85734   |         |
| 1664149C1  | 85029   |         | 206621R91 | 83216   |         | 294334C91  | 83216   |         | 350426C91 | 85734   |         |
| 1664524C1  | 85935   |         | 206621R92 | 83216   |         | 3000070C91 | 83456   | 89447   | 3514952C1 | 85976   |         |
| 1664788C2  | 85316   | 89426   | 208664C91 | 85307   |         | 3000098C1  | 83317   |         | 3533356C1 | 83135   |         |
| 1667520C1  | 85058   | 89431   | 210533R91 | 83225   |         | 306444C91  | 85012   | 89413   | 3533356C2 | 83135   |         |
| 1675455C1  | 85003   | 89411   | 210534R92 | 83225   |         | 3085640C92 | 83216   |         | 3533356C3 | 83169   |         |
| 1677707C1  | 85030   | 89440   | 210535R91 | 83225   |         | 308646C91  | 85012   | 89413   | 3533357C1 | 85957   |         |
| 1690035C1  | 85003   | 89411   | 210536R91 | 83225   |         | 308648C91  | 83225   |         | 3533357C2 | 85957   |         |
| 2015556C1  | 85316   | 89426   | 210537R91 | 83225   |         | 308649C91  | 83216   |         | 3533357C3 | 85957   |         |
| 2015557C1  | 85030   | 89440   | 210538R91 | 83225   |         | 308650C91  | 83216   |         | 3541456C1 | 85929   |         |
| 2018987C1  | 85003   | 89411   | 210918R91 | 83215   |         | 308650C92  | 83216   |         | 3544766C1 | 85930   |         |
| 2018987C2  | 85003   | 89411   | 210919R91 | 85307   |         | 308664C91  | 85307   |         |           |         |         |
| 2029200C91 | 83126   | 89430   | 210920R91 | 85308   | 89422   | 308668C91  | 85012   | 89413   |           |         |         |
| 2029200C91 | 85030   | 89440   | 2200327C1 | 85332   |         | 308668C92  | 85012   | 89413   |           |         |         |
| 2032533C1  | 85316   | 89426   | 287318C91 | G63306  |         | 308669C91  | 85012   | 89413   |           |         |         |

**Important Note:** Competitive Interchanges are to be used for stocking purposes only. Where multiple crosses are identified, please reference the applications section of this catalog. / **Remarque importante:** Les interchanges concurrentiels ne s'utilisent qu'aux fins de stocks. Dans le cas de références multiples, consulter la section des applications du catalogue. / **Nota importante:** Dans le cas de referencias multiples, consultar la sección de aplicaciones del catálogo. / **Nota importante:** Se pueden usar intercambios competitivos para propósitos de almacenamiento solamente. Cuando se identifican intercambios múltiples, consulte la sección de aplicaciones de este catálogo.

**COMPETITIVE & O.E.M. INTERCHANGE LIST**  
**Lista de Intercambios contra Competidores y Equipo Original.**  
**Liste d'interchange de produits compétitifs & d'équipement original (OEM)**

**INTERNATIONAL (NAVISTAR)... cont'd**

| O.E.M #   | Gabriel | Upgrade | O.E.M #   | Gabriel | Upgrade | O.E.M #    | Gabriel | Upgrade | O.E.M #       | Gabriel | Upgrade |
|-----------|---------|---------|-----------|---------|---------|------------|---------|---------|---------------|---------|---------|
| 3544768C1 | 85926   |         | 3601600C2 | 85082   |         | 3885832C2  | 83135   |         | 472414C91     | 83318   |         |
| 3549099C1 | 85923   | 89458   | 3601600C3 | 85082   |         | 3892445C3  | 85931   | 89458   | 474002C91     | 83308   |         |
| 3549099C2 | 85923   | 89458   | 3604282C1 | 85351   |         | 3902993C1  | 83167   |         | 477132C1      | 85303   | 89422   |
| 3549099C3 | 85923   | 89458   | 360444C91 | 85012   | 89413   | 3902993C3  | 83135   |         | 47902-24      | 83137   |         |
| 3549100C1 | 85926   |         | 3605735C1 | 83156   |         | 3945165C1  | 83180   |         | 4C4Z-18124-N  | 85957   |         |
| 3553628C1 | 85927   |         | 3605735C2 | 83156   |         | 3977759C2  | 85639   |         | 4C4Z-18125-DA | 85926   |         |
| 3553628C2 | 85927   |         | 3606770C1 | 83163   |         | 3991991C1  | 83135   |         | 501506C91     | 83317   |         |
| 3553628C3 | 85927   |         | 3606770C2 | 83163   |         | 4050340C1  | 85931   | 89458   | 501553C91     | 85003   | 89411   |
| 3553628C4 | 85927   |         | 3606857C1 | 85954   |         | 4050340C2  | 85931   | 89458   | 501905C91     | 83301   |         |
| 3558089C1 | 85925   |         | 3606857C2 | 85954   |         | 4050443C1  | 85994   |         | 501906C91     | 83317   |         |
| 3558089C2 | 85925   |         | 3606857C3 | 85994   |         | 4050443C2  | 85994   |         | 501906C92     | 83317   |         |
| 3558089C3 | 85925   |         | 3606859C1 | 85954   |         | 4050444C1  | 85994   |         | 503550C1      | 83207   | 89407   |
| 3558989C1 | 85925   |         | 3606859C2 | 85954   |         | 4050444C2  | 85994   |         | 503610C1      | 83207   | 89407   |
| 3558989C2 | 85925   |         | 3606859C3 | 85994   |         | 4070336C1  | 85058   | 89431   | 503610C2      | 83207   | 89407   |
| 3571711C1 | 85316   | 89426   | 3609178C1 | 85955   |         | 426744R91  | 85303   | 89422   | 507202C1      | 85030   | 89440   |
| 3571713C1 | 85333   |         | 3609400C1 | 83317   |         | 426744R92  | 85303   | 89422   | 534464C1      | 85734   |         |
| 3573265C1 | 85931   | 89458   | 3609400C2 | 83317   |         | 446-51-211 | 85739   |         | 537524C91     | 83123   | 89405   |
| 3576464C1 | 85957   |         | 3610198C1 | 85963   |         | 452566C91  | 83225   |         | 537525C91     | 83123   | 89405   |
| 3576464C2 | 85957   |         | 3610199C1 | 85964   |         | 453527C91  | 85311   | 89424   | 540395C91     | 83613   |         |
| 3576465C2 | 85999   |         | 3613984C1 | 85955   |         | 453528C91  | 85311   | 89424   | 540395C92     | 83613   |         |
| 3578105C1 | 83163   |         | 3620395C1 | 85931   | 89458   | 453531C91  | G63306  |         | 548532C1      | 83103   |         |
| 3578105C2 | 83163   |         | 3626571C1 | 85072   |         | 453556C91  | 85012   | 89413   | 56101 Z1030   | 85311   | 89424   |
| 3578858C1 | 85926   |         | 3660548C1 | 85955   |         | 453557C91  | G63306  |         | 56101 Z2000   | 85311   | 89424   |
| 3578858C2 | 85926   |         | 3660549C1 | 85955   |         | 453561C91  | 83225   |         | 56101 Z5008   | 83114   |         |
| 3581106C1 | 85924   | 89457   | 3668566C1 | 85954   |         | 453562C91  | 83225   |         | 56101 Z5011   | G63610  |         |
| 3581106C2 | 85924   | 89457   | 3670156C1 | 85954   |         | 453564C91  | 85012   | 89413   | 56110-T8123   | G63432  |         |
| 3581106C3 | 85924   | 89457   | 3674348C1 | 85954   |         | 453565C91  | 83225   |         | 56110-T8129   | G63432  |         |
| 3581107C1 | 85924   | 89457   | 3688614C1 | 85923   | 89458   | 453566C91  | 83225   |         | 57905-001     | 85976   |         |
| 3581107C2 | 85924   | 89457   | 3688616C1 | 85923   | 89458   | 453567C91  | 83216   |         | 586724C91     | 83456   | 89447   |
| 3581107C3 | 85924   | 89457   | 3688729C1 | 85931   | 89458   | 453568C91  | 83225   |         | 596329C1      | 85014   |         |
| 3581109C1 | 85924   | 89457   | 3688732C1 | 85931   | 89458   | 453569C91  | 83225   |         | 60657-003     | 85072   |         |
| 3581109C3 | 85924   | 89457   | 3737574C1 | 85954   |         | 453570C91  | 83216   |         | 60657-003L    | 85072   |         |
| 3581109C4 | 85924   | 89457   | 3737575C1 | 85954   |         | 453571C91  | 83216   |         | 60657-006     | 85102   |         |
| 3584116C1 | 83175   |         | 3737576C1 | 85931   | 89458   | 453572C91  | 83309   | 89446   | 60657-010     | 85102   |         |
| 3584116C2 | 83175   |         | 3806341C3 | 85995   |         | 453574C91  | 85307   |         | 60657-011     | 85102   |         |
| 3584117C1 | 83135   |         | 3806341C4 | 85995   |         | 453575C91  | 83308   |         | 60665-013     | 85965   |         |
| 3584117C2 | 83135   |         | 3810581C3 | 85995   |         | 453576C91  | 85303   | 89422   | 60665-015     | 85966   |         |
| 3584118C1 | 85928   |         | 3810581C4 | 85995   |         | 453576C92  | 85303   | 89422   | 60670-007     | 83144   |         |
| 3584118C2 | 85928   |         | 3812837C1 | 85954   |         | 453577C91  | 85308   | 89422   | 60670-007L    | 83144   |         |
| 3584535C1 | 85924   | 89457   | 3813340C1 | 85964   |         | 453579C91  | 85308   | 89422   | 60675-003     | 85976   |         |
| 3584535C2 | 85924   | 89457   | 3813340C2 | 85964   |         | 453597C91  | 83216   |         | 60675-003L    | 85976   |         |
| 3584535C3 | 85924   | 89457   | 3813340C3 | 85964   |         | 462557C91  | 85300   | 89419   | 60680-003     | 83112   |         |
| 3586883C1 | 85931   | 89458   | 3813340C4 | 85964   |         | 462603C91  | 85705   | 89447   | 60680-003L    | 83112   |         |
| 3586902C2 | 83146   |         | 3813341C1 | 85963   |         | 462753C91  | 83216   |         | 60680-004     | 83143   |         |
| 3586902C3 | 83364   |         | 3813341C2 | 85963   |         | 463926C91  | 85705   | 89447   | 60680-004L    | 83143   |         |
| 3588209C1 | 85957   |         | 3813341C3 | 85963   |         | 467371C91  | 83225   |         | 60680-005     | 83142   |         |
| 3588209C2 | 85957   |         | 3813341C4 | 85963   |         | 467372C91  | 83225   |         | 60680-005L    | 83142   |         |
| 3588591C1 | 85953   |         | 3816234C1 | 85999   |         | 467980C91  | G63306  |         | 6127086C1     | 85637   |         |
| 3588591C2 | 85953   |         | 3819277C1 | 85969   |         | 467983C91  | 85012   | 89413   | 6127087C1     | 83364   |         |
| 3588592C1 | 85953   |         | 3819279C1 | 85969   |         | 467984C91  | 83216   |         | 6127088C1     | 83163   |         |
| 3588592C2 | 85953   |         | 3821760C1 | 85931   | 89458   | 467985C91  | 85012   | 89413   | 6127096C1     | 83180   |         |
| 3596107C1 | 85927   |         | 383379C91 | 83308   |         | 471201C91  | 85012   | 89413   | 6127688C1     | 83169   |         |
| 3596107C2 | 85927   |         | 384435C91 | 83216   |         | 471203C91  | 83308   |         | 6127690C1     | 85923   | 89458   |
| 3596107C3 | 85927   |         | 3868264C1 | 85998   |         | 472367C91  | 83318   |         | 6127700C1     | 83395   |         |
| 3596107C4 | 85927   |         | 3868265C1 | 85998   |         | 472411C91  | 83456   | 89447   | 6127705C1     | 85924   | 89457   |
| 3601600C1 | 85082   |         | 3885832C1 | 83135   |         | 472412C91  | 83456   | 89447   | 6127713C1     | 85926   |         |

**Important Note:** Competitive Interchanges are to be used for stocking purposes only. Where multiple crosses are identified, please reference the applications section of this catalog. / **Remarque importante:** Les interchanges concurrentiels ne s'utilisent qu'aux fins de stocks. Dans le cas de références multiples, consulter la section des applications du catalogue. / **Nota importante:** Dans le cas de références multiples, consulter la section des applications du catalogue. / **Nota importante:** Se pueden usar intercambios competitivos para propósitos de almacenamiento solamente. Cuando se identifican intercambios múltiples, consulte la sección de aplicaciones de este catálogo.

# COMPETITIVE & O.E.M. INTERCHANGE LIST

## Lista de Intercambios contra Competidores y Equipo Original.

### Liste d'interchange de produits compétitifs & d'équipement original (OEM)

#### INTERNATIONAL (NAVISTAR)... cont'd

| O.E.M #      | Gabriel | Upgrade | O.E.M #    | Gabriel | Upgrade | O.E.M #    | Gabriel | Upgrade | O.E.M #    | Gabriel | Upgrade |
|--------------|---------|---------|------------|---------|---------|------------|---------|---------|------------|---------|---------|
| 6127714C1    | 85928   |         | 874695R91  | 85012   | 89413   | AMS650402  | 85311   | 89424   | H60665015  | 85966   |         |
| 65992-001    | 85955   |         | 874695R92  | 85012   | 89413   | AMS650404  | 85310   | 89423   | H60675-003 | 85976   |         |
| 65992-002    | 85955   |         | 874696R91  | 85012   | 89413   | AMS650405  | 85023   | 89415   | H60675003  | 85976   |         |
| 65992-002L   | 85955   |         | 90044025   | 83209   | 89414   | AMS650406  | 85024   |         | H60680004  | 83143   |         |
| 66400        | G63432  |         | 90044626   | 83126   | 89430   | AMS650408  | 85319   | 89428   | H60680005  | 83142   |         |
| 6ETZ-18125-A | 83146   |         | AMS 600102 | 85005   | 89430   | AMS650420  | 85013   | 89414   | OE 18513   | 83135   |         |
| 70334        | 85316   | 89426   | AMS 600172 | 83126   | 89430   | H60657-003 | 85072   |         | OE13402S   | 83163   |         |
| 790335C91    | 83209   | 89414   | AMS 600172 | 85030   | 89440   | H60657-006 | 85102   |         | OE13424S   | 83317   |         |
| 800670       | 85060   |         | AMS 650420 | 85013   | 89414   | H60657-010 | 85102   |         | OE17103    | 83167   |         |
| 873619C92    | 83314   |         | AMS650102  | 85001   | 89410   | H60657-011 | 85102   |         |            |         |         |
| 873619C93    | 83314   |         | AMS650107  | 85316   | 89426   | H60657003  | 85072   |         |            |         |         |
| 873622C91    | 83308   |         | AMS650400  | 85033   | 89427   | H60665013  | 85965   |         |            |         |         |

#### INTERNATIONAL (NAVISTAR) CAB SHOCKS

| O.E.M #   | Gabriel | Upgrade | O.E.M #   | Gabriel | Upgrade | O.E.M #    | Gabriel | Upgrade | O.E.M #    | Gabriel | Upgrade |
|-----------|---------|---------|-----------|---------|---------|------------|---------|---------|------------|---------|---------|
| 1201-0012 | 83023   |         | 1201-9018 | 83062   |         | 2500013C1  | 83013   |         | 2597458C91 | 83062   |         |
| 1201-0154 | 83051   |         | 1201-9021 | 83062   |         | 2503529C1  | 83025   |         | 2600491C91 | 83062   |         |
| 1201-0254 | 83051   |         | 1202-0012 | 83023   |         | 2507409C1  | 83052   |         | 2601488C91 | 83062   |         |
| 1201-1043 | 83025   |         | 1202-0032 | 83016   |         | 2507761C1  | 83052   |         | 2602021C1  | 83062   |         |
| 1201-1044 | 83025   |         | 1202-0042 | 83025   |         | 2507763C1  | 83052   |         | 3557165C1  | 83053   |         |
| 1201-1049 | 83025   |         | 1202-0043 | 83032   |         | 2507948C1  | 83054   |         | 3557166C1  | 83052   |         |
| 1201-1212 | 83013   |         | 1202-0044 | 83025   |         | 2508326C1  | 83021   |         | 3557167C3  | 83053   |         |
| 1201-1213 | 83005   |         | 1202-0054 | 83021   |         | 2508327C1  | 83025   |         | 3557169C1  | 83052   |         |
| 1201-9001 | 83052   |         | 1202-1043 | 83025   |         | 2509221C91 | 83054   |         | 3557169C2  | 83052   |         |
| 1201-9002 | 83052   |         | 1202-1044 | 83025   |         | 2509222C91 | 83053   |         | 3560649C1  | 83052   |         |
| 1201-9003 | 83052   |         | 1202-1212 | 83013   |         | 2509223C91 | 83054   |         | 3560649C2  | 83052   |         |
| 1201-9007 | 83054   |         | 1202-1213 | 83005   |         | 2509224C91 | 83053   |         | 3560705C2  | 83054   |         |
| 1201-9008 | 83054   |         | 2012768C1 | 83013   |         | 2585145C1  | 83051   |         | AMS66160   | 83052   |         |
| 1201-9009 | 83054   |         | 2012769C1 | 83005   |         | 2589922C1  | 83051   |         | AMS66161   | 83053   |         |
| 1201-9010 | 83053   |         | 2012769C2 | 83005   |         | 2590915C1  | 83062   |         | OE14771    | 83062   |         |
| 1201-9011 | 83053   |         | 2023684C1 | 83015   |         | 2590916C1  | 83062   |         |            |         |         |
| 1201-9013 | 83062   |         | 2023685C1 | 83015   |         | 2593803C91 | 83062   |         |            |         |         |
| 1201-9014 | 83062   |         | 2025790C1 | 83013   |         | 2595314C1  | 83062   |         |            |         |         |

#### ISUZU

| O.E.M #       | Gabriel | Upgrade | O.E.M #       | Gabriel | Upgrade | O.E.M #       | Gabriel | Upgrade | O.E.M #       | Gabriel | Upgrade |
|---------------|---------|---------|---------------|---------|---------|---------------|---------|---------|---------------|---------|---------|
| 1-51630-160-0 | 83162   |         | 8-22064-805-0 | 83136   |         | 8-97253-664-0 | 83159   |         | 9-51630-647-1 | 83515   |         |
| 1-51630-167-0 | 83613   |         | 8-22064-806-0 | 83136   |         | 8-97253-665-0 | 83159   |         | 9-51630-666-0 | 85012   | 89413   |
| 1-51630-168-1 | 83515   |         | 8-22064-807-0 | 83136   |         | 8-98098-058-0 | 83159   |         | 9-51630-666-2 | 85012   | 89413   |
| 1-51630-217-0 | 83114   |         | 8-22064231-0  | 85324   |         | 8-98098-058-1 | 83159   |         | 94033786      | 83114   |         |
| 1-51630-217-1 | 83114   |         | 8-22064232-0  | 85071   |         | 8-98098-059-0 | 83159   |         | 94454986      | 83515   |         |
| 1-51630-219-0 | 83114   |         | 8-22064233-0  | 83136   |         | 8-98098-059-1 | 83159   |         | 94454987      | 83515   |         |
| 1-51630-219-1 | 83114   |         | 8-22064489-0  | 85336   |         | 8-98098-125-0 | 83515   |         | 97083027      | 83515   |         |
| 12474915      | 83122   | 89406   | 8-22064804-0  | 83136   |         | 8-98098-127-0 | 83515   |         | 97083029      | 83515   |         |
| 15123676      | 83136   |         | 8-22064805-0  | 83136   |         | 8-98232671-0  | 83515   |         | 97253620      | 83515   |         |
| 15174902      | 85071   |         | 8-22064806-0  | 83136   |         | 8-98232671-1  | 83515   |         | 97253651      | 83404   |         |
| 15887728      | 83136   |         | 8-22064807-0  | 83136   |         | 8-98232672-0  | 83515   |         | 97253664      | 83159   |         |
| 19152843      | 83136   |         | 8-51630-666-0 | 85012   | 89413   | 8-98232672-1  | 83515   |         | 97253665      | 83159   |         |
| 51630168      | 83515   |         | 8-94454-647-1 | 83515   |         | 8-98316-228-0 | 83159   |         | 98098058      | 83159   |         |
| 51630217      | 83114   |         | 8-94454-986-0 | 83515   |         | 8-98316227-0  | 83159   |         | 98098059      | 83159   |         |
| 51630219      | 83114   |         | 8-94454-987-0 | 83515   |         | 8-98343986-0  | 83159   |         | 98098125      | 83515   |         |
| 51630647      | 83515   |         | 8-97083-027-0 | 83515   |         | 88982682      | 83136   |         | 98098127      | 83515   |         |
| 51630666      | 85012   | 89413   | 8-97083-029-0 | 83515   |         | 88982686      | 85071   |         | 98232671      | 83515   |         |
| 60670-005     | 83137   |         | 8-97253-616-0 | 83515   |         | 8972019600    | 83515   |         | 98232672      | 83515   |         |
| 8-22064-231-0 | 85324   |         | 8-97253-620-0 | 83515   |         | 898098-0581   | 83159   |         | 98316227      | 83159   |         |
| 8-22064-232-0 | 85071   |         | 8-97253-620-1 | 83515   |         | 898098-1250   | 83515   |         |               |         |         |
| 8-22064-233-0 | 83136   |         | 8-97253-621-0 | 83515   |         | 898098-1270   | 83515   |         |               |         |         |
| 8-22064-489-0 | 85336   |         | 8-97253-623-0 | 83515   |         | 8982326710    | 83515   |         |               |         |         |
| 8-22064-804-0 | 83136   |         | 8-97253-651-2 | 83404   |         | 8982326720    | 83515   |         |               |         |         |

**Important Note:** Competitive Interchanges are to be used for stocking purposes only. Where multiple crosses are identified, please reference the applications section of this catalog. / **Remarque importante:** Les interchanges concurrentiels ne s'utilisent qu'aux fins de stocks. Dans le cas de références multiples, consulter la section des applications du catalogue. / **Nota importante:** Dans le cas de références multiples, consulter la section des applications du catalogue. / **Nota importante:** Se pueden usar intercambios competitivos para propósitos de almacenamiento solamente. Cuando se identifican intercambios múltiples, consulte la sección de aplicaciones de este catálogo.

**COMPETITIVE & O.E.M. INTERCHANGE LIST**  
**Lista de Intercambios contra Competidores y Equipo Original.**  
**Liste d'interchange de produits compétitifs & d'équipement original (OEM)**

**ISUZU... cont'd**

| O.E.M #  | Gabriel | Upgrade | O.E.M # | Gabriel | Upgrade | O.E.M # | Gabriel | Upgrade | O.E.M # | Gabriel | Upgrade |
|----------|---------|---------|---------|---------|---------|---------|---------|---------|---------|---------|---------|
| 98343986 | 83159   |         |         |         |         |         |         |         |         |         |         |

**ITASCA**

| O.E.M #       | Gabriel | Upgrade | O.E.M #       | Gabriel | Upgrade | O.E.M #   | Gabriel | Upgrade | O.E.M #        | Gabriel | Upgrade |
|---------------|---------|---------|---------------|---------|---------|-----------|---------|---------|----------------|---------|---------|
| 141700131809  | 85029   |         | 481700000493  | 85900   |         | ASH-1154  | 83177   |         | AT-620         | 83209   | 89414   |
| 141700131810  | 83160   |         | 66153-002     | 83124   | 89407   | ASH-1205  | 83209   | 89414   | AT-621         | 83122   | 89406   |
| 16-16736-000  | 85029   |         | 8C24-18045-DA | 83177   |         | ASH-1206  | 83122   | 89406   | AT-766         | 83209   | 89414   |
| 16-16737-000  | 83160   |         | 8C24-18080-DB | 83178   |         | ASH-1228  | 83209   | 89414   | F4-BE5-A011-HO | 85126   |         |
| 16-16873-000  | 85029   |         | 8C2Z-18124-D  | 83177   |         | ASH-1229  | 83209   | 89414   | F4-BE5-A832-MO | 85125   |         |
| 16-16874-000  | 83160   |         | 8C2Z-18125-D  | 83178   |         | ASH-1230  | 83122   | 89406   | F4-BE5-B492-HO | 85125   |         |
| 16-18103-000  | 85900   |         | 9U94-18045-AA | 83209   | 89414   | ASH-137   | 83122   | 89406   | F4-BE5-C832-MO | 83124   | 89407   |
| 1C34-18045-AA | 83209   | 89414   | 9U94-18080-AA | 83122   | 89406   | ASH-25822 | 83209   | 89414   | F4-BE5-F324-HO | 85125   |         |
| 1C34-18045-JA | 83209   | 89414   | 9U9Z-18124-A  | 83209   | 89414   | ASH-25823 | 83209   | 89414   | F4-BE5-F325-HO | 85124   |         |
| 24-153249     | 85125   |         | 9U9Z-18125-A  | 83122   | 89406   | ASH-25824 | 83122   | 89406   | W0005662       | 85125   |         |
| 24-153256     | 85124   |         | ASH-1022      | 83209   | 89414   | ASH-294   | 83209   | 89414   | W0005663       | 85124   |         |
| 24-186537     | 85126   |         | ASH-1023      | 83122   | 89406   | AT-163G   | 83177   |         | W0006254       | 85125   |         |
| 24-186629     | 85125   |         | ASH-1136      | 83178   |         | AT-164G   | 83178   |         |                |         |         |

**JAY MADSEN**

| O.E.M # | Gabriel | Upgrade | O.E.M # | Gabriel | Upgrade | O.E.M # | Gabriel | Upgrade | O.E.M # | Gabriel | Upgrade |
|---------|---------|---------|---------|---------|---------|---------|---------|---------|---------|---------|---------|
| 3166657 | 85700   |         | 3192333 | 85700   |         |         |         |         |         |         |         |

**JAYCO RV INC**

| O.E.M #  | Gabriel | Upgrade | O.E.M #   | Gabriel | Upgrade | O.E.M #   | Gabriel | Upgrade | O.E.M # | Gabriel | Upgrade |
|----------|---------|---------|-----------|---------|---------|-----------|---------|---------|---------|---------|---------|
| ASH-1136 | 83178   |         | ASH-1229  | 83209   | 89414   | ASH-25823 | 83209   | 89414   |         |         |         |
| ASH-1154 | 83177   |         | ASH-25822 | 83209   | 89414   | ASH-25824 | 83122   | 89406   |         |         |         |

**JIFFLOX**

| O.E.M # | Gabriel | Upgrade | O.E.M # | Gabriel | Upgrade | O.E.M # | Gabriel | Upgrade | O.E.M # | Gabriel | Upgrade |
|---------|---------|---------|---------|---------|---------|---------|---------|---------|---------|---------|---------|
| CP-5222 | 85315   |         |         |         |         |         |         |         |         |         |         |

**JOHN DEERE**

| O.E.M # | Gabriel | Upgrade | O.E.M # | Gabriel | Upgrade | O.E.M # | Gabriel | Upgrade | O.E.M # | Gabriel | Upgrade |
|---------|---------|---------|---------|---------|---------|---------|---------|---------|---------|---------|---------|
| 3638112 | G63183  |         | 4036892 | G63605  |         |         |         |         |         |         |         |

**KENWORTH**

| O.E.M #          | Gabriel | Upgrade | O.E.M #       | Gabriel | Upgrade | O.E.M #    | Gabriel | Upgrade | O.E.M #   | Gabriel | Upgrade |
|------------------|---------|---------|---------------|---------|---------|------------|---------|---------|-----------|---------|---------|
| 02-02736PLUS     | 85302   | 89420   | 60665-013     | 85965   |         | 665783     | 83123   | 89405   | 671962SPL | 85936   | 89456   |
| 02-02737PLUS     | 85062   | 89408   | 60665-015     | 85966   |         | 665784     | 83122   | 89406   | 671963    | 85937   |         |
| 02-02738PLUS     | 85012   | 89413   | 60670-004     | 83123   | 89405   | 665785     | 83137   |         | 675122    | 85001   | 89410   |
| 02-02739PLUS     | 85013   | 89414   | 60670-005     | 83137   |         | 665788     | 85000   | 89436   | 680237    | 85303   | 89422   |
| 03-04176PLUS     | 85308   | 89422   | 60670-005L    | 83137   |         | 665828     | 85067   | 89451   | 680239    | 85310   | 89423   |
| 03-06084PLUS     | 85033   | 89427   | 60670-005PLUS | 83137   |         | 665844     | 85069   | 89455   | 680240    | 85302   | 89420   |
| 03-07421PLUS     | 85311   | 89424   | 60670-008     | 83123   | 89405   | 665858     | 85070   | 89459   | 680241    | 85311   | 89424   |
| 03-07423PLUS     | 85033   | 89427   | 60670-008L    | 83123   | 89405   | 665903     | 85900   |         | 680242    | 85308   | 89422   |
| 03-08781         | 85069   | 89455   | 60670-008PLUS | 83123   | 89405   | 665906     | 85902   |         | 680253    | 85314   | 89425   |
| 10-12032-002PLUS | 85320   | 89429   | 60680-004     | 83143   |         | 665918     | 85900   |         | 680261    | 85062   | 89408   |
| 10-12542-000PLUS | 85901   |         | 60680-004L    | 83143   |         | 665926     | 85047   | 89435   | 680279    | 83209   | 89414   |
| 11418            | 646177  |         | 60680-005     | 83142   |         | 665927     | 85901   |         | 680280    | 85906   | 89407   |
| 16-13947-000PLUS | 85319   | 89428   | 60680-005L    | 83142   |         | 665928     | 85062   | 89408   | 680281    | 85003   | 89411   |
| 16725-01         | 83126   |         | 64178-001     | 83143   |         | 665930     | 85001   | 89410   | 680283    | 85740   |         |
| 1707378PAC       | 85182   |         | 665092        | 83312   | 89409   | 665931     | 83312   | 89409   | 680303    | 85007   | 89412   |
| 19495-01         | 83126   |         | 665118        | 83312   | 89409   | 665932     | 85012   | 89413   | 680425    | 85320   | 89429   |
| 19495-01         | 83126   | 89440   | 665174        | 85060   |         | 665944     | 85900   |         | 680435    | 85033   | 89427   |
| 2018987C1PLUS    | 85003   | 89411   | 665331        | 85740   |         | 665945     | 85902   |         | 680473    | 85319   | 89428   |
| 3166657          | 85700   |         | 665453        | 85001   | 89410   | 665950     | 85902   |         | 680475    | 85314   | 89425   |
| 471700004423     | 85109   |         | 665565        | 85007   | 89412   | 671052     | 85070   | 89459   | 680476    | 85310   | 89423   |
| 47902-13PLUS     | 83122   | 89406   | 665565PLUS    | 85007   | 89412   | 671654     | 85936   | 89456   | 680486    | 85310   | 89423   |
| 47902-19         | 83123   | 89405   | 665617        | 85031   |         | 671656     | 85985   |         | 680586    | 85311   | 89424   |
| 47902-24         | 83137   |         | 665632        | 85013   | 89414   | 671699     | 85937   |         |           |         |         |
| 60657-003        | 85072   |         | 665633        | 85033   | 89427   | 671794     | 85067   | 89451   |           |         |         |
| 60657-003L       | 85072   |         | 665670        | 85001   | 89410   | 671962     | 85936   | 89456   |           |         |         |
| 60665-011        | 85967   |         | 665680        | 83312   | 89409   | 671962PLUS | 85936   | 89456   |           |         |         |

**Important Note:** Competitive Interchanges are to be used for stocking purposes only. Where multiple crosses are identified, please reference the applications section of this catalog. / **Remarque importante:** Les interchanges concurrentiels ne s'utilisent qu'aux fins de stocks. Dans le cas de références multiples, consulter la section des applications du catalogue. / **Nota importante:** Dans le cas de références multiples, consulter la section des applications du catalogue. / **Nota importante:** Se pueden usar intercambios competitivos para propósitos de almacenamiento solamente. Cuando se identifican intercambios múltiples, consulte la sección aplicaciones de este catálogo.

# COMPETITIVE & O.E.M. INTERCHANGE LIST

## Lista de Intercambios contra Competidores y Equipo Original.

### Liste d'interchange de produits compétitifs & d'équipement original (OEM)

#### KENWORTH... cont'd

| O.E.M #      | Gabriel | Upgrade | O.E.M #      | Gabriel | Upgrade | O.E.M #       | Gabriel | Upgrade | O.E.M #     | Gabriel | Upgrade |
|--------------|---------|---------|--------------|---------|---------|---------------|---------|---------|-------------|---------|---------|
| 70701        | 85900   |         | B71-6007     | 85062   | 89408   | C71-1015 PLUS | 85937   |         | K374-3      | 83312   | 89409   |
| 70701PLUS    | 85900   |         | B71-6008     | 83312   | 89409   | C71-1015A     | 85937   |         | K374-3-1    | 83312   | 89409   |
| 8086053PLUS  | 85047   | 89435   | B71-6010     | 85023   | 89415   | C71-1016      | 85067   | 89451   | K374-32     | 85310   | 89423   |
| 90044025PLUS | 83209   | 89414   | B71-6011     | 85062   | 89408   | C71-1017      | 85069   | 89455   | K374-33     | 83312   | 89409   |
| 90044089     | 83124   | 89407   | B71-6012     | 85119   |         | C71-6003      | 85988   |         | K374-33PLUS | 83312   | 89409   |
| 90044089PLUS | 83124   | 89407   | B71-6013     | 85012   | 89413   | C71-6004      | 85343   |         | K374-36     |         | 89432   |
| 90045068     |         | 89441   | B71-6015     | 85012   | 89413   | C71-6005      | 85069   | 89455   | K374-4      | 85314   | 89425   |
| 90045099     | 85906   | 89407   | B71-6016     | 85012   | 89413   | C71-6015      | 85067   | 89451   | K374-5      | 83312   | 89409   |
| 90045132     | 85909   |         | B71-6017     | 85910   |         | K374-10       | 83362   |         | K374-7      | 85310   | 89423   |
| 90045605     | 85109   |         | B71-6018     | 85012   | 89413   | K374-11       | 85001   | 89410   | K374-9      | 85310   | 89423   |
| ACHB966      | 83136   |         | B71-6019     | 85989   |         | K374-13       | 85740   |         | K374-C31    | 83312   | 89409   |
| B71-1000     | 85031   |         | B71-6020     | 85989   |         | K374-13-1     | 85740   |         | K374-C7     | 85310   | 89423   |
| B71-1001     | 85070   | 89459   | BFRG 072     | 85182   |         | K374-14       | 83312   | 89409   | R71-6006    | 83063   |         |
| B71-1002     | 85001   | 89410   | C71-1002     | 85067   | 89451   | K374-16       | 85001   | 89410   | R71-6007    | 83008   |         |
| B71-1003     | 83312   | 89409   | C71-1002PLUS | 85067   | 89451   | K374-26       | 85001   | 89410   | R71-6008    | 83035   |         |
| B71-6000     | 85959   |         | C71-1011     | 85069   | 89455   | K374-26PLUS   | 85001   | 89410   | S-20126     | 85323   | 89436   |
| B71-6002     | 85012   | 89413   | C71-1011PLUS | 85069   | 89455   | K374-27       | 85001   | 89410   | TK19679     | 83126   |         |
| B71-6003     | 85029   |         | C71-1011SPL  | 85069   | 89455   | K374-28       | 85314   | 89425   | TK19679     | 83126   | 89440   |
| B71-6004     | 85084   | 89460   | C71-1013     | 85985   |         | K374-28PLUS   | 85314   | 89425   |             |         |         |
| B71-6005     | 85084   | 89460   | C71-1014     | 85936   | 89456   | K374-29       | 85310   | 89423   |             |         |         |
| B71-6006     | 85084   | 89460   | C71-1015     | 85937   |         | K374-29PLUS   | 85310   | 89423   |             |         |         |

#### KENWORTH CAB SHOCKS

| O.E.M #   | Gabriel | Upgrade | O.E.M #   | Gabriel | Upgrade | O.E.M #     | Gabriel | Upgrade | O.E.M #  | Gabriel | Upgrade |
|-----------|---------|---------|-----------|---------|---------|-------------|---------|---------|----------|---------|---------|
| 1201-0012 | 83023   |         | 1202-0054 | 83021   |         | 1202K064    | 83024   |         | R71-6000 | 83067   |         |
| 1201-1043 | 83025   |         | 1202-1043 | 83025   |         | 1202K065    | 83002   |         | R71-6005 | 83042   |         |
| 1201-1044 | 83025   |         | 1202-1046 | 83049   |         | 1202K164    | 83031   |         | R71-6009 | 83081   |         |
| 1201-1046 | 83049   |         | 1202-1064 | 83024   |         | 1202K264    | 83031   |         | R71-6010 | 83067   |         |
| 1201-8002 | 83081   |         | 1202-1065 | 83002   |         | 1202K286    | 83056   |         | T71-1000 | 83031   |         |
| 1202-0012 | 83023   |         | 1202-1164 | 83031   |         | 96027-10545 | 83011   |         | T71-1001 | 83031   |         |
| 1202-0032 | 83016   |         | 1202-1264 | 83031   |         | PP1058870   | 83059   |         | T71-1002 | 83002   |         |
| 1202-0042 | 83025   |         | 1202-1286 | 83056   |         | PP2582870   | 83012   |         | T71-1003 | 83056   |         |
| 1202-0043 | 83032   |         | 1202-K065 | 83002   |         | R71-1004    | 83049   |         |          |         |         |
| 1202-0044 | 83025   |         | 1202K046  | 83049   |         | R71-1005    | 83024   |         |          |         |         |

#### KIMBLE MIXER CO

| O.E.M # | Gabriel | Upgrade | O.E.M #      | Gabriel | Upgrade | O.E.M # | Gabriel | Upgrade | O.E.M # | Gabriel | Upgrade |
|---------|---------|---------|--------------|---------|---------|---------|---------|---------|---------|---------|---------|
| OE10455 | 646155  |         | T91-00002-00 | 646155  |         |         |         |         |         |         |         |

#### KING OF THE ROAD

| O.E.M #      | Gabriel | Upgrade | O.E.M #      | Gabriel | Upgrade | O.E.M #      | Gabriel | Upgrade | O.E.M #      | Gabriel | Upgrade |
|--------------|---------|---------|--------------|---------|---------|--------------|---------|---------|--------------|---------|---------|
| 141700131809 | 85029   |         | 16-16736-000 | 85029   |         | 16-16873-000 | 85029   |         | 16-18103-000 | 85900   |         |
| 141700131810 | 83160   |         | 16-16737-000 | 83160   |         | 16-16874-000 | 83160   |         | 481700000493 | 85900   |         |

#### KONI

| Koni         | Gabriel | Upgrade | Koni    | Gabriel | Upgrade | Koni      | Gabriel | Upgrade | Koni        | Gabriel | Upgrade |
|--------------|---------|---------|---------|---------|---------|-----------|---------|---------|-------------|---------|---------|
| 090-2209-SP2 | 85001   | 89410   | 30-1606 | G63423  |         | 82-1970   | G63350  |         | 88-1457-SP1 | 83209   | 89414   |
| 30-1348      | G63424  |         | 30-1607 | G63422  |         | 82-2158   | G63357  |         | 88-1458-SP1 | 83122   | 89406   |
| 30-1350      | G63511  |         | 30-1614 | G63678  |         | 82-2246   | G63299  |         | 88-1458-SP2 | 83122   | 89406   |
| 30-1351      | G63490  |         | 30-1624 | G63424  |         | 82-2345   | G63413  |         | 88-1468     | 83209   | 89414   |
| 30-1365      | G63611  |         | 30-1627 | G63690  |         | 82-2372   | G63609  |         | 88-1476     | 85740   |         |
| 30-1366      | G63610  |         | 30-1630 | G63425  |         | 82-2384   | G63488  |         | 88-1489     | 85036   | 89405   |
| 30-1381      | G63426  |         | 30-1630 | G63722  |         | 8240-1029 | G63386  |         | 88-1490     | 83124   | 89407   |
| 30-1421      | G63547  |         | 80-2516 | G63421  |         | 8240-1054 | G63375  |         | 88-1499     | 85001   | 89410   |
| 30-1422      | G63548  |         | 80-2517 | G63422  |         | 8240-1055 | G63454  |         | 88-1509     | 85027   | 89418   |
| 30-1456      | G63782  |         | 80-2633 | G63423  |         | 8240-1148 | G63720  |         | 88-1510     | 85708   |         |
| 30-1457      | G63781  |         | 80-2634 | G63422  |         | 84-1168   | 83130   |         | 88-1517     | 85040   |         |
| 30-1501      | G63608  |         | 82-1952 | G63347  |         | 88-1385   | 83105   |         |             |         |         |
| 30-1502      | G63679  |         | 82-1954 | G63355  |         | 88-1417   | 83312   | 89409   |             |         |         |
| 30-1565      | G63707  |         | 82-1955 | G63349  |         | 88-1419   | 83136   |         |             |         |         |
| 30-1566      | G63708  |         | 82-1969 | G63500  |         | 88-1422   | 85030   | 89440   |             |         |         |

**Important Note:** Competitive Interchanges are to be used for stocking purposes only. Where multiple crosses are identified, please reference the applications section of this catalog. / **Remarque importante:** Les interchanges concurrentiels ne s'utilisent qu'aux fins de stocks. Dans le cas de références multiples, consulter la section des applications du catalogue. / **Nota importante:** Dans le cas de références multiples, consulter la section des applications du catalogue. / **Nota importante:** Se pueden usar intercambios competitivos para propósitos de almacenamiento solamente. Cuando se identifican intercambios múltiples, consulte la sección de aplicaciones de este catálogo.

**COMPETITIVE & O.E.M. INTERCHANGE LIST**  
**Lista de Intercambios contra Competidores y Equipo Original.**  
**Liste d'interchange de produits compétitifs & d'équipement original (OEM)**

**KONI... cont'd**

| Koni        | Gabriel | Upgrade | Koni        | Gabriel | Upgrade | Koni        | Gabriel | Upgrade | Koni        | Gabriel | Upgrade |
|-------------|---------|---------|-------------|---------|---------|-------------|---------|---------|-------------|---------|---------|
| 88-1518     | 85040   |         | 8805-1043   | 83178   |         | 90-2089     | 83165   |         | 90-2497S-P1 | 85712   |         |
| 88-1520     | 85040   |         | 90-1400     | 83104   |         | 90-2102-SP1 | 85708   |         | 90-2529     | 85707   |         |
| 88-1525     | 85040   |         | 90-1409-SP1 | 85722   |         | 90-2148     | 85304   |         | 90-2530     | 85707   |         |
| 88-1532     | 85708   |         | 90-1466     | 85707   |         | 90-2164-SP1 | 85723   |         | 90-2563     | 85006   |         |
| 88-1540     | 85051   |         | 90-1577-SP1 | 85310   | 89423   | 90-2166     | 83165   |         | 90-2572     | 85329   |         |
| 88-1541     | 85045   |         | 90-1608     | 83104   |         | 90-2209     | 85308   | 89422   | 90-2573     | 85329   |         |
| 88-1558     | 85013   | 89414   | 90-1811     | 85301   |         | 90-2251     | 85717   |         | 90-2574     | 85330   |         |
| 88-1559-SP1 | 85036   | 89405   | 90-1813-SP1 | 85712   |         | 90-2252     | 85714   |         | 90-2575     | 85700   |         |
| 88-1560     | 85062   | 89408   | 90-1813-SP3 | 85968   |         | 90-2253-SP2 | 85732   |         | 90-2576     | 85700   |         |
| 88-1561     | 85012   | 89413   | 90-1862     | 85708   |         | 90-2254     | 85720   |         | 90-2586     | 85728   |         |
| 88-1562     | 85003   | 89411   | 90-1867     | 85053   | 89442   | 90-2255     | 85719   |         | 90-2587     | 85729   |         |
| 88-1616     | 85014   |         | 90-1868     | 85307   |         | 90-2256     | 85732   |         | 90-2588     | 85339   |         |
| 88-1639     | 83130   |         | 90-1868-SP1 | 85307   |         | 90-2257     | 85716   |         | 90-2589     | 85727   |         |
| 88-1641     | 85029   |         | 90-1896     | 85302   | 89420   | 90-2291     | 695406  |         | 90-2610-SP1 | 87017   |         |
| 88-1642     | 83124   | 89407   | 90-1897     | 85303   | 89422   | 90-2325     | 85340   |         | 90-2627     | 89461   |         |
| 88-1644     | 85000   | 89436   | 90-1898     | 83215   |         | 90-2326     | 85970   |         | 90-2816     | 85711   |         |
| 88-1646     | 83613   |         | 90-1907-SP1 | 85300   | 89419   | 90-2327     | 85341   |         | 90-5055-SP2 | 85318   |         |
| 88-1647     | 83317   |         | 90-1908-SP1 | 85723   |         | 90-2368     | 86203   |         | 90-5180     | 85300   | 89419   |
| 88-1668SP1  | 85097   |         | 90-1909-SP1 | 85722   |         | 90-2368-SP1 | 86203   |         | 9005-1018   | 85970   |         |
| 88-1704     | 85030   | 89440   | 90-1910     | 85704   |         | 90-2368-SP2 | 86203   |         | 9005-1019   | 85341   |         |
| 88-5162     | 83209   | 89414   | 90-1912     | 85318   |         | 90-2396-SP1 | 85000   | 89436   | 9020-1042   | 85708   |         |
| 88-5163     | 83122   | 89406   | 90-1922     | 85900   |         | 90-2396-SP1 | 85323   | 89436   | 90F-1235    | 85700   |         |
| 8805-1001   | 85125   |         | 90-1943     | 85307   |         | 90-2404     | 86203   |         | 91-2368     | 86203   |         |
| 8805-1002   | 85124   |         | 90-1951-SP1 | 85734   |         | 90-2407     | 85709   |         | 91-2400     | 86203   |         |
| 8805-1003   | 85126   |         | 90-1951-SP5 | 85712   |         | 90-2416     | 86202   |         | 91-2527     | 86202   |         |
| 8805-1018   | 83209   |         | 90-1965     | 85304   |         | 90-2416-SP1 | 86202   |         | 92-1227     | 85722   |         |
| 8805-1019   | 83122   | 89406   | 90-1968     | 85720   |         | 90-2433     | 85710   |         | 99B-3178    | 85179   |         |
| 8805-1022   | 85724   | 89443   | 90-1974     | 85311   | 89424   | 90-2434     | 85702   |         |             |         |         |
| 8805-1023   | 83136   |         | 90-2059     | 85722   |         | 90-2477     | 85900   |         |             |         |         |
| 8805-1042   | 83177   |         | 90-2060     | 85722   |         | 90-2478     | 85902   |         |             |         |         |

**KRYSTAL BUS**

| O.E.M #  | Gabriel | Upgrade | O.E.M #  | Gabriel | Upgrade | O.E.M # | Gabriel | Upgrade | O.E.M # | Gabriel | Upgrade |
|----------|---------|---------|----------|---------|---------|---------|---------|---------|---------|---------|---------|
| ASH-1136 | 83178   |         | ASH-1154 | 83177   |         |         |         |         |         |         |         |

**KWK-LOC (JIFFLOX)**

| O.E.M # | Gabriel | Upgrade | O.E.M # | Gabriel | Upgrade | O.E.M # | Gabriel | Upgrade | O.E.M # | Gabriel | Upgrade |
|---------|---------|---------|---------|---------|---------|---------|---------|---------|---------|---------|---------|
| 522217  | 85315   |         | CP-5222 | 85315   |         |         |         |         |         |         |         |

**KYB**

| Kyb    | Gabriel | Upgrade | Kyb    | Gabriel | Upgrade | Kyb    | Gabriel | Upgrade | Kyb    | Gabriel | Upgrade |
|--------|---------|---------|--------|---------|---------|--------|---------|---------|--------|---------|---------|
| 340043 | G63909  |         | 341627 | 85006   |         | 343403 | G63660  |         | 344074 | G63811  |         |
| 341302 | G63678  |         | 341628 | 85724   | 89443   | 344040 | G63421  |         | 344075 | G63413  |         |
| 341312 | G63865  |         | 341629 | 85938   |         | 344041 | G63422  |         | 344076 | G63410  |         |
| 341339 | G63918  |         | 341630 | 85052   |         | 344042 | G63423  |         | 344077 | G63406  |         |
| 341343 | G63893  |         | 341631 | 646155  |         | 344043 | G63813  |         | 344078 | G63683  |         |
| 341374 | G63884  |         | 341632 | 83124   | 89407   | 344044 | G63907  |         | 344079 | G63775  |         |
| 341613 | 85062   | 89408   | 341633 | 83215   |         | 344045 | G63492  |         | 344080 | G63426  |         |
| 341614 | 85001   | 89410   | 343030 | G63949  |         | 344046 | G63491  |         | 344081 | G63375  |         |
| 341615 | 83215   |         | 343127 | G63900  |         | 344047 | G63950  |         | 344082 | G63454  |         |
| 341617 | 85005   | 89430   | 343160 | G63914  |         | 344049 | G63414  |         | 344083 | G63457  |         |
| 341618 | 85918   | 89449   | 343208 | G63909  |         | 344050 | G63773  |         | 344084 | G63490  |         |
| 341619 | 83136   |         | 343209 | G63903  |         | 344051 | G63420  |         | 344085 | G63306  |         |
| 341620 | 85033   | 89427   | 343210 | G63799  |         | 344054 | G63444  |         | 344086 | G63353  |         |
| 341621 | 85311   | 89424   | 343272 | G63860  |         | 344055 | G63484  |         | 344088 | G63424  |         |
| 341622 | 85023   | 89415   | 343353 | G63880  |         | 344066 | G63359  |         | 344089 | G63425  |         |
| 341623 | 85003   | 89411   | 343379 | G63845  |         | 344067 | G63347  |         |        |         |         |
| 341624 | 85036   | 89405   | 343388 | G63712  |         | 344068 | G63355  |         |        |         |         |
| 341625 | 85000   | 89436   | 343395 | G63842  |         | 344069 | G63500  |         |        |         |         |
| 341626 | 85000   | 89436   | 343395 | G64014  |         | 344072 | G63349  |         |        |         |         |

**Important Note:** Competitive Interchanges are to be used for stocking purposes only. Where multiple crosses are identified, please reference the applications section of this catalog. / **Remarque importante:** Les interchanges concurrentiels ne s'utilisent qu'aux fins de stocks. Dans le cas de références multiples, consulter la section des applications du catalogue. / **Nota importante:** Dans le cas de références multiples, consulter la section des applications du catalogue. / **Nota importante:** Se pueden usar intercambios competitivos para propósitos de almacenamiento solamente. Cuando se identifican intercambios múltiples, consulte la sección de aplicaciones de este catálogo.

**COMPETITIVE & O.E.M. INTERCHANGE LIST**  
**Lista de Intercambios contra Competidores y Equipo Original.**  
**Liste d'interchange de produits compétitifs & d'équipement original (OEM)**

**KYB... cont'd**

| Kyb    | Gabriel | Upgrade | Kyb    | Gabriel | Upgrade | Kyb     | Gabriel | Upgrade | Kyb     | Gabriel | Upgrade |
|--------|---------|---------|--------|---------|---------|---------|---------|---------|---------|---------|---------|
| 344090 | G63492  |         | 344399 | G63848  |         | 349010  | G64006  |         | KG5455  | G63456  |         |
| 344091 | G63511  |         | 344401 | G63970  |         | 349119  | 89439   |         | KG5456  | G63416  |         |
| 344092 | G63490  |         | 344402 | G63817  |         | 441600  | 85310   | 89423   | KG5462  | G63494  |         |
| 344093 | G63905  |         | 344404 | G63844  |         | 441601  | 85710   |         | KG5466  | G63492  |         |
| 344094 | G63915  |         | 344410 | G63885  |         | 441602  | 85724   | 89443   | KG5474  | G63479  |         |
| 344095 | G63499  |         | 344419 | G63888  |         | 444058  | 83404   |         | KG5475  | G63432  |         |
| 344096 | G63460  |         | 344426 | G63299  |         | 444328  | 85055   |         | KG5476  | G63611  |         |
| 344097 | G63907  |         | 344427 | G63904  |         | 444329  | 83509   |         | KG5477  | G63906  |         |
| 344098 | G63612  |         | 344428 | G63494  |         | 553360  | G63937  |         | KG5478  | G63489  |         |
| 344202 | G63479  |         | 344430 | G63611  |         | 553361  | G63689  |         | KG5479  | G63488  |         |
| 344263 | G63488  |         | 344431 | G63620  |         | 554347  | G63886  |         | KG5480  | G63609  |         |
| 344264 | G63387  |         | 344435 | G63721  |         | KG4159  | G63892  |         | KG5482  | G63675  |         |
| 344265 | G63489  |         | 344438 | G63869  |         | KG4160  | G64016  |         | KG5484  | G63635  |         |
| 344266 | G63818  |         | 344464 | G63882  |         | KG4613A | G63909  |         | KG5485  | G63639  |         |
| 344267 | G63455  |         | 344466 | G63879  |         | KG4616  | G63798  |         | KG5487  | G63525  |         |
| 344268 | G63614  |         | 344481 | G63894  |         | KG5194  | G64000  |         | KG5488  | G63403  |         |
| 344269 | G63679  |         | 344496 | G64012  |         | KG5196  | G64013  |         | KG5489  | G63614  |         |
| 344272 | G63386  |         | 345005 | G63694  |         | KG5198A | G63606  |         | KG5491  | G63604  |         |
| 344273 | G63638  |         | 345022 | G63832  |         | KG5401  | G63299  |         | KG5494  | G63620  |         |
| 344291 | G63873  |         | 345023 | G63828  |         | KG5406  | G63386  |         | KG5495  | G63929  |         |
| 344299 | G63710  |         | 345024 | G63864  |         | KG5417  | G63371  |         | KG5496  | G63624  |         |
| 344338 | G63776  |         | 345030 | 83304   |         | KG5420  | G63366  |         | KG5497  | G63622  |         |
| 344341 | G63847  |         | 345030 | G63394  |         | KG5421  | G63387  |         | KG5498  | G63623  |         |
| 344342 | G63829  |         | 345042 | G63883  |         | KG5422  | G63183  |         | KG5499  | G63621  |         |
| 344353 | G63877  |         | 345043 | G63878  |         | KG5424  | G63187  |         | KG5534  | G63610  |         |
| 344356 | G63862  |         | 345055 | G63872  |         | KG5426  | G63396  |         | KG5538  | G63484  |         |
| 344359 | G63720  |         | 345080 | 83177   |         | KG5429  | G63398  |         | KG5555  | G63914  |         |
| 344364 | G63673  |         | 345601 | 83613   |         | KG54300 | G63615  |         | KG6001A | 83304   |         |
| 344365 | G63662  |         | 345602 | 85052   |         | KG54301 | G63616  |         | KG6002A | 85030   | 89440   |
| 344366 | G63366  |         | 345604 | 85051   |         | KG54302 | G63782  |         | KG6003  | 83309   |         |
| 344367 | G63714  |         | 345605 | 85012   | 89413   | KG54303 | G63781  |         | KG6004  | 85320   | 89429   |
| 344368 | G63716  |         | 345606 | 83136   |         | KG54304 | G63707  |         | KG6005  | 83216   |         |
| 344369 | G63624  |         | 345607 | 83130   |         | KG54305 | G63640  |         | KG6006  | 85012   | 89413   |
| 344370 | G63622  |         | 345608 | 85060   |         | KG54307 | G63812  |         | KG6007  | 85007   | 89412   |
| 344371 | 83178   |         | 345609 | 83515   |         | KG54308 | G63708  |         | KG6008A | 83122   | 89406   |
| 344372 | G63661  |         | 345611 | 83120   |         | KG5431  | G63511  |         | KG6009A | 83303   |         |
| 344373 | G63675  |         | 345613 | 85005   | 89430   | KG54317 | G63726  |         | KG6010  | 83308   | 89435   |
| 344374 | G63778  |         | 345614 | 83309   | 89446   | KG54330 | G63809  |         | KG6198  | G63616  |         |
| 344375 | G63715  |         | 345615 | 83314   |         | KG54331 | G63837  |         | KG6199  | 85012   | 89413   |
| 344377 | G63717  |         | 345616 | 83125   |         | KG54333 | G63810  |         | KG6201  | 83456   | 89447   |
| 344380 | G63783  |         | 345617 | 83203   | 89436   | KG54335 | G63815  |         | KG6403  | G63605  |         |
| 344381 | G63803  |         | 345618 | 83126   | 89430   | KG5438  | G63492  |         | KG6406  | G63183  |         |
| 344382 | G63887  |         | 345620 | 83456   | 89447   | KG5440  | G63350  |         | KG6412  | G63625  |         |
| 344385 | G63866  |         | 345621 | 85003   | 89411   | KG5442  | G63626  |         | KG6413  | 83177   |         |
| 344387 | G63617  |         | 349004 | G63886  |         | KG5444  | G63904  |         | KG6415  | 85013   | 89414   |
| 344397 | G63772  |         | 349009 | G63897  |         | KG5446  | G63909  |         | KG6416  | 83123   | 89405   |
| 344398 | G63958  |         | 349009 | G63919  |         | KG5447  | G63491  |         |         |         |         |

**LEYLAND TRUCK**

| O.E.M # | Gabriel | Upgrade | O.E.M # | Gabriel | Upgrade | O.E.M # | Gabriel | Upgrade | O.E.M # | Gabriel | Upgrade |
|---------|---------|---------|---------|---------|---------|---------|---------|---------|---------|---------|---------|
| 1456033 | 85311   | 89424   |         |         |         |         |         |         |         |         |         |

**LGE COACHWORKS**

| O.E.M #  | Gabriel | Upgrade | O.E.M #  | Gabriel | Upgrade | O.E.M # | Gabriel | Upgrade | O.E.M # | Gabriel | Upgrade |
|----------|---------|---------|----------|---------|---------|---------|---------|---------|---------|---------|---------|
| ASH-1136 | 83178   |         | ASH-1154 | 83177   |         |         |         |         |         |         |         |

**LINK MANUFACTURING CAB SHOCKS**

| O.E.M #   | Gabriel | Upgrade | O.E.M #   | Gabriel | Upgrade | O.E.M # | Gabriel | Upgrade | O.E.M # | Gabriel | Upgrade |
|-----------|---------|---------|-----------|---------|---------|---------|---------|---------|---------|---------|---------|
| 1201-0012 | 83023   |         | 1201-0254 | 83051   |         |         |         |         |         |         |         |
| 1201-0154 | 83051   |         | 1201-1043 | 83025   |         |         |         |         |         |         |         |

**Important Note:** Competitive Interchanges are to be used for stocking purposes only. Where multiple crosses are identified, please reference the applications section of this catalog. / **Remarque importante:** Les interchanges concurrentiels ne s'utilisent qu'aux fins de stocks. Dans le cas de références multiples, consulter la section des applications du catalogue. / **Nota importante:** Dans le cas de références multiples, consulter la section des applications du catalogue. / **Nota importante:** Se pueden usar intercambios competitivos para propósitos de almacenamiento solamente. Cuando se identifican intercambios múltiples, consulte la sección de aplicaciones de este catálogo.

**COMPETITIVE & O.E.M. INTERCHANGE LIST**  
**Lista de Intercambios contra Competidores y Equipo Original.**  
**Liste d'interchange de produits compétitifs & d'équipement original (OEM)**

**LINK MANUFACTURING CAB SHOCKS... cont'd**

| O.E.M #   | Gabriel | Upgrade | O.E.M #   | Gabriel | Upgrade | O.E.M #   | Gabriel | Upgrade | O.E.M #  | Gabriel | Upgrade |
|-----------|---------|---------|-----------|---------|---------|-----------|---------|---------|----------|---------|---------|
| 1201-1044 | 83025   |         | 1201-9014 | 83062   |         | 1202-1064 | 83024   |         | 654799   | 83025   |         |
| 1201-1046 | 83049   |         | 1201-9018 | 83062   |         | 1202-1065 | 83002   |         | 654811   | 83024   |         |
| 1201-1049 | 83025   |         | 1201-9021 | 83062   |         | 1202-1164 | 83031   |         | 654833   | 83021   |         |
| 1201-1212 | 83013   |         | 1202-0012 | 83023   |         | 1202-1212 | 83013   |         | 654847   | 83002   |         |
| 1201-1213 | 83005   |         | 1202-0032 | 83016   |         | 1202-1213 | 83005   |         | 654849   | 83031   |         |
| 1201-9001 | 83052   |         | 1202-0042 | 83025   |         | 1202-1286 | 83056   |         | 654867   | 83025   |         |
| 1201-9002 | 83052   |         | 1202-0043 | 83032   |         | 1202K065  | 83002   |         | LG40450  | 83016   |         |
| 1201-9003 | 83052   |         | 1202-0044 | 83025   |         | 1202K164  | 83031   |         | LG40470  | 83016   |         |
| 1201-9007 | 83054   |         | 1202-0052 | 83021   |         | 1202K264  | 83031   |         | R71-1004 | 83049   |         |
| 1201-9008 | 83054   |         | 1202-0054 | 83021   |         | 1202K286  | 83056   |         | R71-1005 | 83024   |         |
| 1201-9009 | 83054   |         | 1202-1042 | 83025   |         | 1202P055  | 83061   |         | T71-1000 | 83031   |         |
| 1201-9010 | 83053   |         | 1202-1043 | 83025   |         | 632129    | 83023   |         | T71-1001 | 83031   |         |
| 1201-9011 | 83053   |         | 1202-1044 | 83025   |         | 635705    | 83016   |         | T71-1002 | 83002   |         |
| 1201-9013 | 83062   |         | 1202-1046 | 83049   |         | 654669    | 83021   |         |          |         |         |

**LINK MANUFACTURING LTD.**

| O.E.M #   | Gabriel | Upgrade | O.E.M #   | Gabriel | Upgrade | O.E.M # | Gabriel | Upgrade | O.E.M # | Gabriel | Upgrade |
|-----------|---------|---------|-----------|---------|---------|---------|---------|---------|---------|---------|---------|
| 1210-0005 | 85734   |         | 1210-0528 | 85904   |         | 671093  | 85904   |         |         |         |         |

**LINK/HIGH-STEER**

| O.E.M #   | Gabriel | Upgrade | O.E.M #   | Gabriel | Upgrade | O.E.M #   | Gabriel | Upgrade | O.E.M # | Gabriel | Upgrade |
|-----------|---------|---------|-----------|---------|---------|-----------|---------|---------|---------|---------|---------|
| 1210-0001 | 646155  |         | 1210-0007 | 665937  |         | 1210-0010 | 646155  |         | 632155  | 646177  |         |
| 1210-0002 | 632147  |         | 1210-0009 | 665937  |         | 1210-0012 | 646155  |         | 646168  | 646155  |         |

**LION BUS**

| O.E.M #   | Gabriel | Upgrade | O.E.M #    | Gabriel | Upgrade | O.E.M #   | Gabriel | Upgrade | O.E.M #    | Gabriel | Upgrade |
|-----------|---------|---------|------------|---------|---------|-----------|---------|---------|------------|---------|---------|
| 58913-009 | 85959   |         | 58913-009L | 85959   |         | 60665-025 | 85036   | 89405   | 60665-025L | 85036   | 89405   |

**LODAL, INC.**

| O.E.M # | Gabriel | Upgrade | O.E.M # | Gabriel | Upgrade | O.E.M # | Gabriel | Upgrade | O.E.M # | Gabriel | Upgrade |
|---------|---------|---------|---------|---------|---------|---------|---------|---------|---------|---------|---------|
| 9960257 | 83122   | 89406   |         |         |         |         |         |         |         |         |         |

**LONDON MIXER**

| O.E.M #     | Gabriel | Upgrade | O.E.M # | Gabriel | Upgrade | O.E.M # | Gabriel | Upgrade | O.E.M # | Gabriel | Upgrade |
|-------------|---------|---------|---------|---------|---------|---------|---------|---------|---------|---------|---------|
| MB-37737-30 | 646155  |         |         |         |         |         |         |         |         |         |         |

**M.A.N. BUS**

| O.E.M #         | Gabriel | Upgrade | O.E.M #       | Gabriel | Upgrade | O.E.M #       | Gabriel | Upgrade | O.E.M #    | Gabriel | Upgrade |
|-----------------|---------|---------|---------------|---------|---------|---------------|---------|---------|------------|---------|---------|
| 134             | 85709   |         | 81-43701-6538 | 85708   |         | 81-43701-6572 | 85708   |         | 9020M-1042 | 85709   |         |
| 25-1700-106-654 | 85708   |         | 81-43701-6539 | 85708   |         | 81-43701-6573 | 85722   |         |            |         |         |
| 81-43701-6537   | 85709   |         | 81-43701-6543 | 85708   |         | 81-43701-6609 | 85709   |         |            |         |         |

**MACK**

| O.E.M #       | Gabriel | Upgrade | O.E.M #     | Gabriel | Upgrade | O.E.M #      | Gabriel | Upgrade | O.E.M #     | Gabriel | Upgrade |
|---------------|---------|---------|-------------|---------|---------|--------------|---------|---------|-------------|---------|---------|
| 1252607B000   | 85702   |         | 14QK-2100P6 | 85036   | 89405   | 14QK-2133M2  | 85001   | 89410   | 14QK-366    | 85036   | 89405   |
| 141700000373  | 85061   | 89450   | 14QK-2100P7 | 83221   |         | 14QK-2136M   | 85061   | 89450   | 14QK-366P1  | 85036   | 89405   |
| 141700000380  | 85061   | 89450   | 14QK-2100P8 | 83242   |         | 14QK-282P1   | 83216   |         | 14QK-366P2  | 85036   | 89405   |
| 141700005839  | 85098   |         | 14QK-2102   | 85304   |         | 14QK-282P3   | 83216   |         | 14QK-366P3  | 85036   | 89405   |
| 14QK-1200P4   | 83207   | 89407   | 14QK-2105   | 83209   | 89414   | 14QK-288-P1  | 85007   | 89412   | 14QK-366P4  | 83209   | 89414   |
| 14QK-140      | 85304   |         | 14QK-2107   | 83215   |         | 14QK-288P2   | 83217   |         | 14QK-372M   | 83221   |         |
| 14QK-140P1    | 83225   |         | 14QK-2107P1 | 83215   |         | 14QK-29001P2 | 85303   | 89422   | 14QK-372M2  | 83209   | 89414   |
| 14QK-142      | 85305   |         | 14QK-2107P2 | 83215   |         | 14QK-29301P1 | 83207   | 89407   | 14QK-372M3  | 83122   | 89406   |
| 14QK-142AP1   | 83215   |         | 14QK-2107P3 | 83215   |         | 14QK-29301P2 | 83207   | 89407   | 14QK-373    | 83215   |         |
| 14QK-142P1    | 83215   |         | 14QK-2108   | 83203   | 89436   | 14QK-29302   | 83207   | 89407   | 14QK-375M   | 83123   | 89405   |
| 14QK-143      | 83207   | 89407   | 14QK-2108P1 | 83203   | 89436   | 14QK-29302P1 | 83207   | 89407   | 14QK-377M   | 83215   |         |
| 14QK-145      | 85307   |         | 14QK-2110   | 85305   |         | 14QK-3100    | 85739   |         | 14QK-378    | 83215   |         |
| 14QK-20001P2  | 85308   | 89422   | 14QK-2110P1 | 85305   |         | 14QK-3101M   | 85066   | 89448   | 14QK-378M   | 83215   |         |
| 14QK-2100     | 83221   |         | 14QK-2113   | 85001   | 89410   | 14QK-3107M   | 85061   | 89450   | 14QK-390    | 83105   |         |
| 14QK-2100D-P4 | 83207   | 89407   | 14QK-2113P3 | 85001   | 89410   | 14QK-3108    | 85080   |         | 14QK-392AM  | 85005   | 89430   |
| 14QK-2100P1   | 83221   |         | 14QK-2113P4 | 85007   | 89412   | 14QK-3108M   | 85080   |         | 14QK-392AM2 | 83123   | 89405   |
| 14QK-2100P2   | 83209   | 89414   | 14QK-2113P5 | 85001   | 89410   | 14QK-3114M   | 85061   | 89450   |             |         |         |
| 14QK-2100P3   | 83207   | 89407   | 14QK-2113P6 | 85007   | 89412   | 14QK-3115M   | 85972   |         |             |         |         |
| 14QK-2100P4   | 83207   | 89407   | 14QK-2115   | 85305   |         | 14QK-3116M   | 83101   |         |             |         |         |
| 14QK-2100P5   | 83221   |         | 14QK-2133M  | 85001   | 89410   | 14QK-322M    | 85933   | 89454   |             |         |         |

**Important Note:** Competitive Interchanges are to be used for stocking purposes only. Where multiple crosses are identified, please reference the applications section of this catalog. / **Remarque importante:** Les interchanges concurrentiels ne s'utilisent qu'aux fins de stocks. Dans le cas de références multiples, consulter la section des applications du catalogue. / **Nota importante:** Dans le cas de références multiples, consulter la section des applications du catalogue. / **Nota importante:** Se pueden usar intercambios competitivos para propósitos de almacenamiento solamente. Cuando se identifican intercambios múltiples, consulte la sección de aplicaciones de este catálogo.



**COMPETITIVE & O.E.M. INTERCHANGE LIST**  
**Lista de Intercambios contra Competidores y Equipo Original.**  
**Liste d'interchange de produits compétitifs & d'équipement original (OEM)**

**MACK... cont'd**

| O.E.M #     | Gabriel | Upgrade | O.E.M #  | Gabriel | Upgrade | O.E.M #         | Gabriel | Upgrade | O.E.M #         | Gabriel | Upgrade |
|-------------|---------|---------|----------|---------|---------|-----------------|---------|---------|-----------------|---------|---------|
| 14QK-392AM3 | 85005   | 89430   | 20513881 | 85061   | 89450   | 25625743        | 85005   | 89430   | 60675-001L      | 85978   |         |
| 14QK-392BM  | 85005   | 89430   | 20570098 | 83147   |         | 25626048        | 85080   |         | 60675-13        | 85036   | 89405   |
| 14QK-392BM2 | 85321   |         | 20625775 | 85014   |         | 25626149        | 85080   |         | 60680-003       | 83112   |         |
| 14QK-392BM3 | 85005   | 89430   | 20782199 | 85072   |         | 25632145        | 85001   | 89410   | 60680-003L      | 83112   |         |
| 14QK-392M   | 85005   | 89430   | 20863239 | 85080   |         | 25632147        | 85305   |         | 60680-004       | 83143   |         |
| 14QK-393AM  | 83123   | 89405   | 20897198 | 85061   | 89450   | 25632561        | 83209   | 89414   | 60680-004L      | 83143   |         |
| 14QK-393M   | 85010   |         | 20973993 | 85061   | 89450   | 25633154        | 85906   | 89407   | 60680-005       | 83142   |         |
| 14QK-396    | 85005   | 89430   | 20998401 | 85014   |         | 4103-5000447861 | 83105   |         | 60680-005L      | 83142   |         |
| 14QK-396M   | 85005   | 89430   | 21002497 | 85972   |         | 4103-5000546892 | 83105   |         | 64838-002       | 85933   | 89454   |
| 14QK-410M   | 83125   |         | 21010744 | 83101   |         | 446-51-211      | 85739   |         | 650102          | 85001   | 89410   |
| 14QK-410M2  | 83137   |         | 21155033 | 83101   |         | 471700000426    | 85014   |         | 650107          | 85316   | 89426   |
| 14QK-410M3  | 83125   |         | 21436096 | 85098   |         | 471700000431    | 85066   | 89448   | 650107MT        | 85316   | 89426   |
| 14QK-413M   | 83111   |         | 21462382 | 85088   |         | 471700000445    | 85080   |         | 650400MT        | 85033   | 89427   |
| 14QK-413M4  | 83110   |         | 21462384 | 85088   |         | 471700000451    | 85080   |         | 650402          | 85311   | 89424   |
| 14QK-413M5  | 83138   |         | 21687170 | 85120   |         | 471700002626    | 85061   | 89450   | 650402MT        | 85311   | 89424   |
| 14QK-413M6  | 83111   |         | 21979343 | 85065   |         | 471700002861    | 85014   |         | 650404          | 85310   | 89423   |
| 14QK-413M7  | 83111   |         | 22202559 | 85088   |         | 471700006039    | 85088   |         | 650404MT        | 85310   | 89423   |
| 14QK-414M   | 85906   | 89407   | 22202560 | 85088   |         | 471700008934    | 85065   |         | 650405          | 85023   | 89415   |
| 14QK-414M2  | 85909   |         | 22314111 | 85036   | 89405   | 471700009646    | 85088   |         | 650405MT        | 85023   | 89415   |
| 14QK-415M   | 83112   |         | 25621571 | 83215   |         | 471700009647    | 85088   |         | 650406          | 85024   |         |
| 14QK-415M7  | 83112   |         | 25621955 | 85001   | 89410   | 471700131921    | 85933   | 89454   | 650408          | 85319   | 89428   |
| 14QK-421M   | 85014   |         | 25622221 | 83111   |         | 47902-25        | 83125   |         | 650408MT        | 85319   | 89428   |
| 14QK-422M   | 85933   | 89454   | 25622345 | 83242   |         | 47902-9         | 83123   | 89405   | 651012          | 83221   |         |
| 14QK-423M   | 85978   |         | 25622466 | 85001   | 89410   | 4940654         | 83216   |         | 651103          | 85036   | 89405   |
| 14QK-424M   | 83147   |         | 25623321 | 83215   |         | 5533699         | 85302   | 89420   | 651151          | 83209   | 89414   |
| 14QK-427M   | 85080   |         | 25624241 | 83112   |         | 5554184         | 85302   | 89420   | 70042           | 85302   | 89420   |
| 14QK-428    | 85080   |         | 25624341 | 83110   |         | 57241-004       | 83110   |         | 8083872         | 85978   |         |
| 14QK-428M   | 85080   |         | 25624351 | 85909   |         | 57241-006       | 83111   |         | 90045099        | 85906   | 89407   |
| 14QK-431M   | 85061   | 89450   | 25624365 | 83217   |         | 57241-006L      | 83111   |         | H60680004       | 83143   |         |
| 14QK-434M   | 85014   |         | 25625091 | 83215   |         | 57241-4         | 83110   |         | H60680005       | 83142   |         |
| 14QK-493M   | 83101   |         | 25625151 | 85036   | 89405   | 5966-90044025   | 83209   | 89414   | SDA141700000380 | 85061   | 89450   |
| 20469001    | 85933   | 89454   | 25625187 | 83209   | 89414   | 60657-007       | 85072   |         | SDA471700000431 | 85066   | 89448   |
| 20469002    | 85933   | 89454   | 25625223 | 83111   |         | 60670-006       | 83147   |         | SDA471700002861 | 85014   |         |
| 20485632    | 85933   | 89454   | 25625234 | 83125   |         | 60670-006L      | 83147   |         | V10234121       | 83105   |         |
| 20485633    | 85933   | 89454   | 25625254 | 83125   |         | 60675-001       | 85978   |         | V10242320       | 83105   |         |

**MACK CAB SHOCKS**

| O.E.M #      | Gabriel | Upgrade | O.E.M #     | Gabriel | Upgrade | O.E.M #   | Gabriel | Upgrade | O.E.M #  | Gabriel | Upgrade |
|--------------|---------|---------|-------------|---------|---------|-----------|---------|---------|----------|---------|---------|
| 1201-0012    | 83023   |         | 14QK-391AM  | 83041   |         | 14QK-411M | 83007   |         | 22662259 | 83901   |         |
| 1202-0012    | 83023   |         | 14QK-391AM2 | 83041   |         | 14QK-432M | 83050   |         | 23145372 | 83066   |         |
| 1202-0032    | 83016   |         | 14QK-391BM  | 83041   |         | 14QK-439M | 83050   |         | 25622373 | 83905   |         |
| 14QK-2111    | 83019   |         | 14QK-391BM2 | 83041   |         | 14QK-440M | 83058   |         | 25622612 | 83041   |         |
| 14QK-2111-P2 | 83019   |         | 14QK-391M   | 83041   |         | 20873442  | 83050   |         | 25622613 | 83041   |         |
| 14QK-2111-P4 | 83019   |         | 14QK-391M2  | 83041   |         | 20874147  | 83050   |         | 25624837 | 83041   |         |
| 14QK-303M    | 83050   |         | 14QK-397AM  | 83905   |         | 21154393  | 83050   |         | 25625635 | 83045   |         |
| 14QK-3103M   | 83050   |         | 14QK-399M   | 83045   |         | 21154397  | 83058   |         | 25625636 | 83045   |         |
| 14QK-374     | 83003   |         | 14QK-399M2  | 83045   |         | 21345868  | 83066   |         | 25625637 | 83045   |         |
| 14QK-376     | 83003   |         | 14QK-399M3  | 83045   |         | 21345869  | 83066   |         | 25631922 | 83007   |         |
| 14QK-382     | 83018   |         | 14QK-411    | 83007   |         | 21490486  | 83066   |         |          |         |         |
| 14QK-382-P2  | 83018   |         | 14QK-411AM  | 83007   |         | 22662254  | 83901   |         |          |         |         |

**MAECO**

| O.E.M # | Gabriel | Upgrade | O.E.M # | Gabriel | Upgrade | O.E.M # | Gabriel | Upgrade | O.E.M # | Gabriel | Upgrade |
|---------|---------|---------|---------|---------|---------|---------|---------|---------|---------|---------|---------|
| 1085    | 83214   |         | 16720   | 83107   |         | 16772   | 83122   | 89406   | 16778   | 83203   | 89436   |
| 12608   | 83125   |         | 16767   | 85013   | 89414   | 16773   | 85005   | 89430   | 16779   | 83126   | 89440   |
| 12788   | 83216   |         | 16768   | 83217   |         | 16774   | 83215   |         |         |         |         |
| 12866   | 83207   | 89407   | 16769   | 83221   |         | 16775   | 83207   | 89407   |         |         |         |
| 16385   | 83215   |         | 16770   | 83209   | 89414   | 16776   | 83122   | 89406   |         |         |         |
| 1668722 | 85030   | 89440   | 16771   | 83126   | 89430   | 16777   | 85006   |         |         |         |         |

**Important Note:** Competitive Interchanges are to be used for stocking purposes only. Where multiple crosses are identified, please reference the applications section of this catalog. / **Remarque importante:** Les interchanges concurrentiels ne s'utilisent qu'aux fins de stocks. Dans le cas de références multiples, consulter la section des applications du catalogue. / **Nota importante:** Dans le cas de références multiples, consulter la section des applications du catalogue. / **Nota importante:** Se pueden usar intercambios competitivos para propósitos de almacenamiento solamente. Cuando se identifican intercambios múltiples, consulte la sección de aplicaciones de este catálogo.

**COMPETITIVE & O.E.M. INTERCHANGE LIST**  
**Lista de Intercambios contra Competidores y Equipo Original.**  
**Liste d'interchange de produits compétitifs & d'équipement original (OEM)**

**MAECO... cont'd**

| O.E.M # | Gabriel | Upgrade | O.E.M # | Gabriel | Upgrade | O.E.M # | Gabriel | Upgrade | O.E.M # | Gabriel | Upgrade |
|---------|---------|---------|---------|---------|---------|---------|---------|---------|---------|---------|---------|
| 16780   | 83123   | 89405   | 70041   | 85305   |         | 70317   |         | 89432   | 70652   | 85030   | 89440   |
| 16781   | 85006   |         | 70042   | 85302   | 89420   | 70331   | 85314   | 89425   | 70663   | 85013   | 89414   |
| 16787   | 85030   | 89440   | 70088   | 85307   |         | 70332   | 83314   |         | 70691   | 85007   | 89412   |
| 16949   | 83120   |         | 70123   | 85716   |         | 70334   | 85316   | 89426   | 70720   | 85934   |         |
| 16950   | 83118   |         | 70127   | 85006   | 89401   | 70397   | 85006   |         | 70721   | 83125   |         |
| 6025    | 83122   | 89406   | 70128   | 85006   | 89401   | 70402   | 85305   |         | 74039   | 85303   | 89422   |
| 6026    | 83204   |         | 70162   | 85716   |         | 70642   | 85300   | 89419   | OE10881 | 85711   |         |
| 70018   | 85303   | 89422   | 70163   | 85302   | 89420   | 70644   | 85334   |         | OE10882 | 85740   |         |
| 70021   | 85303   | 89422   | 70164   | 85716   |         | 70646   | 85313   |         | OE10883 | 85339   |         |
| 70029   | 85308   | 89422   | 70300   | 85320   | 89429   | 70648   | 89414   |         | OE12425 | 83214   |         |
| 70034   | 85302   | 89420   | 70312   | 85001   | 89410   | 70650   | 89440   |         | SC-2920 | 83176   |         |
| 70039   | 85303   | 89422   | 70315   | 85063   |         | 70651   | 85013   | 89414   |         |         |         |

**MANDALAY COACH**

| O.E.M #      | Gabriel | Upgrade | O.E.M #      | Gabriel | Upgrade | O.E.M #      | Gabriel | Upgrade | O.E.M #      | Gabriel | Upgrade |
|--------------|---------|---------|--------------|---------|---------|--------------|---------|---------|--------------|---------|---------|
| 141700131809 | 85029   |         | 16-16736-000 | 85029   |         | 16-16873-000 | 85029   |         | 16-18103-000 | 85900   |         |
| 141700131810 | 83160   |         | 16-16737-000 | 83160   |         | 16-16874-000 | 83160   |         | 481700000493 | 85900   |         |

**MARMON**

| O.E.M # | Gabriel | Upgrade | O.E.M #   | Gabriel | Upgrade | O.E.M # | Gabriel | Upgrade | O.E.M # | Gabriel | Upgrade |
|---------|---------|---------|-----------|---------|---------|---------|---------|---------|---------|---------|---------|
| 1-7001  | 83216   |         | 51-139-28 | 85003   | 89411   | 576451  | 83122   | 89406   |         |         |         |
| 37-1-1  | 83122   | 89406   | 51-163-7  | 83123   | 89405   | 665147  | 83216   |         |         |         |         |

**MARMON CAB SHOCKS**

| O.E.M #   | Gabriel | Upgrade | O.E.M # | Gabriel | Upgrade | O.E.M # | Gabriel | Upgrade | O.E.M # | Gabriel | Upgrade |
|-----------|---------|---------|---------|---------|---------|---------|---------|---------|---------|---------|---------|
| 1202-0054 | 83021   |         |         |         |         |         |         |         |         |         |         |

**MATSON SCHOOL BUS**

| O.E.M # | Gabriel | Upgrade | O.E.M # | Gabriel | Upgrade | O.E.M # | Gabriel | Upgrade | O.E.M # | Gabriel | Upgrade |
|---------|---------|---------|---------|---------|---------|---------|---------|---------|---------|---------|---------|
| 5392387 | 85303   | 89422   |         |         |         |         |         |         |         |         |         |

**MAXPRO**

| Maxpro     | Gabriel | Upgrade | Maxpro | Gabriel | Upgrade | Maxpro | Gabriel | Upgrade | Maxpro | Gabriel | Upgrade |
|------------|---------|---------|--------|---------|---------|--------|---------|---------|--------|---------|---------|
| 17E-Z10042 | 85061   | 89450   |        |         |         |        |         |         |        |         |         |

**MC NEILUS TRUCK & MAN.**

| O.E.M #      | Gabriel | Upgrade | O.E.M #     | Gabriel | Upgrade | O.E.M #     | Gabriel | Upgrade | O.E.M #     | Gabriel | Upgrade |
|--------------|---------|---------|-------------|---------|---------|-------------|---------|---------|-------------|---------|---------|
| 1139039 MTM  | 85334   |         | 1398980 MTM | 83127   |         | 1KK552 MTM  | 85967   |         | 600-188206  | 646155  |         |
| 1139046 MTM  | 83112   |         | 1404068 MTM | 85087   |         | 2034140 MTM | 646155  |         | 64442AX MTM | 83128   | 89436   |
| 1139059 MTM  | 83207   | 89407   | 1404068 MTM | 85980   |         | 217330      | 85303   | 89422   | 6HA961 MTM  | 83123   | 89405   |
| 1139069 MTM  | 83209   | 89414   | 1410046 MTM | 85919   |         | 2218640 MTM | 83009   |         | 6HB390 MTM  | 83137   |         |
| 1170719      | 632147  |         | 1411765 MTM | 83148   |         | 3215395 MTM | 83112   |         | 6HD720 MTM  | 85909   |         |
| 12405FX1 MTM | 85303   | 89422   | 1412744 MTM | 85966   |         | 3HR582 MTM  | 85013   | 89414   | 6HS773 MTM  | 83122   | 89406   |
| 1323106 MTM  | 85305   |         | 1429317 MTM | 85919   |         | 3HR916 MTM  | 83207   | 89407   | 6KP857 MTM  | 85000   | 89436   |
| 1333575 MTM  | 85072   |         | 1431085 MTM | 85738   |         | 4HA569 MTM  | 85932   | 89453   | 7HS237 MTM  | 83122   | 89406   |
| 1340975 MTM  | 83142   |         | 1432386 MTM | 85965   |         | 4KP398 MTM  | 85933   | 89454   | 7HS534 MTM  | 85906   | 89407   |
| 1340976 MTM  | 85919   |         | 1433009 MTM | 85962   |         | 5HA994 MTM  | 85916   | 89430   | 8KK524 MTM  | 83168   |         |
| 1340979 MTM  | 83143   |         | 1468783 MTM | 85345   |         | 5HB645 MTM  | 83109   |         | 9HB362 MTM  | 85976   |         |
| 1360386 MTM  | 85323   | 89436   | 1473224     | 646155  |         | 5KK247 MTM  | 85977   |         | 9KK464 MTM  | 85079   |         |
| 1367383 MTM  | 83147   |         | 1485576 MTM | 85979   |         | 600-115994B | 632147  |         |             |         |         |
| 1396513 MTM  | 85959   |         | 1491909 MTM | 83128   | 89436   | 600-11599M  | 632147  |         |             |         |         |

**MERITOR**

| O.E.M #    | Gabriel | Upgrade | O.E.M # | Gabriel | Upgrade | O.E.M #       | Gabriel | Upgrade | O.E.M #      | Gabriel | Upgrade |
|------------|---------|---------|---------|---------|---------|---------------|---------|---------|--------------|---------|---------|
| 14QK-3100  | 85739   |         | 671020  | 87015   |         | 680705        | 85737   |         | A-7805P-1030 | 85737   |         |
| 202447     | 85919   |         | 671500  | 86201   |         | 700115        | 85712   |         | KIT11210     | 87015   |         |
| 21224745   | 86203   |         | 671502  | 86202   |         | 7805-F-1020   | 86200   |         | KIT11375     | 86200   |         |
| 21224778   | 86202   |         | 671503  | 86203   |         | A-3280-M-9711 | 85919   |         | KIT11376     | 86200   |         |
| 21227751   | 87015   |         | 671506  | 86200   |         | A-7805F-1020  | 86200   |         | KIT11389     | 86200   |         |
| 21228392   | 86201   |         | 671507  | 87015   |         | A-7805L-1000  | 85919   |         | KIT11402     | 86200   |         |
| 446-51-211 | 85739   |         | 671907  | 85919   |         | A-7805L-1026  | 87015   |         |              |         |         |

**Important Note:** Competitive Interchanges are to be used for stocking purposes only. Where multiple crosses are identified, please reference the applications section of this catalog. / **Remarque importante:** Les interchanges concurrentiels ne s'utilisent qu'aux fins de stocks. Dans le cas de références multiples, consulter la section des applications du catalogue. / **Nota importante:** Dans le cas de références multiples, consulter la section des applications du catalogue. / **Nota importante:** Se pueden usar intercambios competitivos para propósitos de almacenamiento solamente. Cuando se identifican intercambios múltiples, consulte la sección de aplicaciones de este catálogo.

**COMPETITIVE & O.E.M. INTERCHANGE LIST**  
**Lista de Intercambios contra Competidores y Equipo Original.**  
**Liste d'interchange de produits compétitifs & d'équipement original (OEM)**

**MITSUBISHI-FUSO**

| O.E.M #  | Gabriel | Upgrade | O.E.M #  | Gabriel | Upgrade | O.E.M #  | Gabriel | Upgrade | O.E.M #  | Gabriel | Upgrade |
|----------|---------|---------|----------|---------|---------|----------|---------|---------|----------|---------|---------|
| MB161497 | G63299  |         | MC809390 | 83103   |         | MC813511 | G63398  |         | MC826268 | G63610  |         |
| MC114595 | G63405  |         | MC813135 | 83456   | 89447   | MC814614 | 85009   |         |          |         |         |

**MOHAWK**

| O.E.M #     | Gabriel | Upgrade | O.E.M #  | Gabriel | Upgrade | O.E.M #       | Gabriel | Upgrade | O.E.M #       | Gabriel | Upgrade |
|-------------|---------|---------|----------|---------|---------|---------------|---------|---------|---------------|---------|---------|
| 01-0100-905 | 85303   | 89422   | 10234504 | 85717   |         | 680323        | 85700   |         | 97-9999-02320 | 85704   |         |
| 020273544   | 83203   | 89436   | 1235233  | 85736   |         | 680485        | 85733   |         | MM-6886       | 83207   | 89407   |
| 050134508   | 85732   |         | 22012082 | 85702   |         | 695195        | 85707   |         | MM-6957       | 83225   |         |
| 10134504    | 85715   |         | 22012114 | 85700   |         | 695196        | 85707   |         | MM-74029      | 85308   | 89422   |
| 10134506    | 85715   |         | 4968853  | 83216   |         | 97-2201-00007 | 85703   |         |               |         |         |
| 10234503    | 85715   |         | 6-367-7  | 85305   |         | 97-2201-00011 | 85704   |         |               |         |         |

**MONACO**

| O.E.M #       | Gabriel | Upgrade | O.E.M #      | Gabriel | Upgrade | O.E.M #   | Gabriel | Upgrade | O.E.M #        | Gabriel | Upgrade |
|---------------|---------|---------|--------------|---------|---------|-----------|---------|---------|----------------|---------|---------|
| 1C34-18045-AA | 83209   | 89414   | 9U9Z-18124-A | 83209   | 89414   | ASH-1230  | 83122   | 89406   | AT-766         | 83209   | 89414   |
| 1C34-18045-JA | 83209   | 89414   | 9U9Z-18125-A | 83122   | 89406   | ASH-137   | 83122   | 89406   | F4-BE5-A011-HO | 85126   |         |
| 24-153256     | 85124   |         | ASH-1022     | 83209   | 89414   | ASH-25822 | 83209   | 89414   | F4-BE5-B492-HO | 85125   |         |
| 24-186537     | 85126   |         | ASH-1023     | 83122   | 89406   | ASH-25823 | 83209   | 89414   | F4-BE5-C832-MO | 83124   | 89407   |
| 24-186629     | 85125   |         | ASH-1205     | 83209   | 89414   | ASH-25824 | 83122   | 89406   | F4-BE5-F325-HO | 85124   |         |
| 66153-002     | 83124   | 89407   | ASH-1206     | 83122   | 89406   | ASH-294   | 83209   | 89414   | W0005663       | 85124   |         |
| 9U94-18045-AA | 83209   | 89414   | ASH-1228     | 83209   | 89414   | AT-620    | 83209   | 89414   |                |         |         |
| 9U94-18080-AA | 83122   | 89406   | ASH-1229     | 83209   | 89414   | AT-621    | 83122   | 89406   |                |         |         |

**MONROE**

| Monroe | Gabriel | Upgrade | Monroe | Gabriel | Upgrade | Monroe | Gabriel | Upgrade | Monroe | Gabriel | Upgrade |
|--------|---------|---------|--------|---------|---------|--------|---------|---------|--------|---------|---------|
| 12872  | 83219   |         | 34685  | G63808  |         | 34799  | G63609  |         | 34963  | G63406  |         |
| 16385  | 83215   |         | 34686  | G63809  |         | 34802  | 83216   |         | 34964  | G63456  |         |
| 16721  | 83125   |         | 34687  | G63810  |         | 34803  | G63306  |         | 34972  | G63610  |         |
| 171322 | G63679  |         | 34690  | G63675  |         | 34817  | G63355  |         | 34975  | G63511  |         |
| 171341 | G64014  |         | 34721  | 83103   |         | 34821  | G63406  |         | 34983  | G63489  |         |
| 31029  | G63798  |         | 34722  | 83400   |         | 34822  | G63371  |         | 34985  | 61543   |         |
| 32066  | G63900  |         | 34729  | G63414  |         | 34824  | G63349  |         | 37011  | G63414  |         |
| 32207  | G63949  |         | 34730  | G63386  |         | 34828  | G63510  |         | 37012  | G63603  |         |
| 32217  | G63612  |         | 34732  | G63455  |         | 34831  | G63359  |         | 37013  | G63525  |         |
| 32273  | G63782  |         | 34733  | G63617  |         | 34832  | 61526   |         | 37014  | G63524  |         |
| 32274  | G63781  |         | 34736  | G63394  |         | 34839  | G63671  |         | 37015  | G63614  |         |
| 32314  | G63604  |         | 34741  | G63489  |         | 34868  | 61650   |         | 37016  | G63635  |         |
| 32341  | G63675  |         | 34751  | G63607  |         | 34895  | 83207   | 89407   | 37017  | G63639  |         |
| 32392  | G63848  |         | 34755  | G63812  |         | 34899  | G63500  |         | 37021  | G63422  |         |
| 33049  | G63610  |         | 34756  | G63638  |         | 34900  | G63386  |         | 37022  | G63495  |         |
| 34504  | G63817  |         | 34759  | G63624  |         | 34901  | G63387  |         | 37024  | G63610  |         |
| 34514  | G63958  |         | 34760  | G63622  |         | 34904  | G63299  |         | 37026  | G63424  |         |
| 34515  | G63675  |         | 34761  | G63623  |         | 34905  | G63405  |         | 37027  | G63425  |         |
| 34516  | G63848  |         | 34762  | G63638  |         | 34906  | G63396  |         | 37028  | G63904  |         |
| 34517  | G63837  |         | 34763  | 58638   |         | 34907  | G63511  |         | 37029  | G63928  |         |
| 34518  | G63809  |         | 34767  | G63638  |         | 34909  | G63187  |         | 37030  | G63547  |         |
| 34519  | G63837  |         | 34768  | 83209   | 89414   | 34910  | 61516   |         | 37031  | G63404  |         |
| 34523  | G63969  |         | 34776  | G63661  |         | 34911  | G63350  |         | 37032  | G63494  |         |
| 34524  | 77968   |         | 34777  | G63662  |         | 34912  | 83304   |         | 37033  | G63548  |         |
| 34530  | G63895  |         | 34778  | G63673  |         | 34919  | G63411  |         | 37035  | G63607  |         |
| 34612  | 83017   |         | 34781  | G63675  |         | 34920  | G63675  |         | 37036  | G63410  |         |
| 34617  | 83019   |         | 34782  | G63674  |         | 34927  | G63409  |         | 37038  | G63461  |         |
| 34655  | G63714  |         | 34787  | G63615  |         | 34928  | G63416  |         | 37040  | G63347  |         |
| 34656  | G63778  |         | 34788  | G63616  |         | 34929  | G63403  |         | 37041  | G63349  |         |
| 34657  | G63716  |         | 34791  | G63692  |         | 34930  | G63811  |         | 37042  | G63906  |         |
| 34658  | G63715  |         | 34793  | 61520   |         | 34944  | 61516   |         | 37044  | G63488  |         |
| 34675  | G63783  |         | 34794  | G63360  |         | 34954  | G63484  |         |        |         |         |
| 34676  | G63662  |         | 34796  | G63929  |         | 34958  | G63377  |         |        |         |         |
| 34677  | G63803  |         | 34797  | G63406  |         | 34959  | G63432  |         |        |         |         |
| 34684  | G63622  |         | 34798  | G63609  |         | 34960  | G63366  |         |        |         |         |

**Important Note:** Competitive Interchanges are to be used for stocking purposes only. Where multiple crosses are identified, please reference the applications section of this catalog. / **Remarque importante:** Les interchanges concurrentiels ne s'utilisent qu'aux fins de stocks. Dans le cas de références multiples, consulter la section des applications du catalogue. / **Nota importante:** Dans le cas de références multiples, consulter la section des applications du catalogue. / **Nota importante:** Se pueden usar intercambios competitivos para propósitos de almacenamiento solamente. Cuando se identifican intercambios múltiples, consulte la sección de aplicaciones de este catálogo.

**COMPETITIVE & O.E.M. INTERCHANGE LIST**  
**Lista de Intercambios contra Competidores y Equipo Original.**  
**Liste d'interchange de produits compétitifs & d'équipement original (OEM)**

**MONROE... cont'd**

| Monroe | Gabriel | Upgrade | Monroe | Gabriel | Upgrade | Monroe | Gabriel | Upgrade | Monroe | Gabriel | Upgrade |
|--------|---------|---------|--------|---------|---------|--------|---------|---------|--------|---------|---------|
| 37045  | G63183  |         | 37123  | G63690  |         | 550020 | G63919  |         | 557039 | 85959   |         |
| 37046  | G63389  |         | 37128  | G63929  |         | 550051 | 43140   |         | 557040 | 85092   |         |
| 37047  | G63902  |         | 37129  | G63421  |         | 551001 | 83125   |         | 5777   | G63880  |         |
| 37048  | G63492  |         | 37130  | G63609  |         | 551002 | 83122   | 89406   | 65101  | 85062   | 89408   |
| 37049  | G63355  |         | 37131  | G63714  |         | 553001 | 79900   |         | 65102  | 85001   | 89410   |
| 37050  | G63489  |         | 37132  | G63778  |         | 553002 | G56778  |         | 65103  | 85320   | 89429   |
| 37051  | G63490  |         | 37133  | G63716  |         | 555004 | G63299  |         | 65104  | 85026   | 89417   |
| 37052  | G63406  |         | 37134  | G63715  |         | 555005 | G63689  |         | 65105  | 85026   | 89417   |
| 37053  | G63386  |         | 37135  | G63722  |         | 555006 | G63173  |         | 65106  | 85091   |         |
| 37055  | G63455  |         | 37144  | G63717  |         | 555010 | 77623   |         | 65107  | 85316   | 89426   |
| 37058  | G63457  |         | 37149  | G63783  |         | 555011 | 83119   |         | 65108  | 85030   | 89432   |
| 37060  | G63621  |         | 37151  | G63803  |         | 555012 | G63183  |         | 65109  | 85058   | 89431   |
| 37061  | G63502  |         | 37153  | G63772  |         | 555019 | 85069   | 89455   | 65110  | 85005   | 89430   |
| 37062  | G63818  |         | 37155  | G63676  |         | 555026 | 83124   | 89407   | 65111  | 85006   |         |
| 37063  | G63375  |         | 37156  | G63869  |         | 555027 | 83124   | 89407   | 65112  | 89402   |         |
| 37064  | G63454  |         | 37157  | G63726  |         | 555028 | 83207   | 89407   | 65113  | 85012   | 89413   |
| 37065  | G63426  |         | 37158  | G63712  |         | 555029 | 83144   |         | 65114  | 85036   | 89405   |
| 37066  | G63915  |         | 37160  | G63710  |         | 555031 | 83177   |         | 65115  | 85027   | 89418   |
| 37067  | G63460  |         | 37161  | G63847  |         | 555032 | 83178   |         | 65116  | 85329   |         |
| 37068  | G63905  |         | 37162  | G63829  |         | 555033 | G63386  |         | 65118  | 85001   | 89410   |
| 37069  | G63499  |         | 37163  | G63817  |         | 555034 | G63387  |         | 65119  | 85029   |         |
| 37070  | G63799  |         | 37164  | G63675  |         | 555035 | G63357  |         | 65120  | 85010   |         |
| 37071  | G63914  |         | 37166  | G63866  |         | 555036 | 77403   |         | 65121  | 85971   |         |
| 37072  | G63903  |         | 37178  | G63803  |         | 555037 | G63359  |         | 65122  | 85063   |         |
| 37073  | G63907  |         | 37191  | G63506  |         | 555038 | G63413  |         | 65123  | 85054   | 89438   |
| 37074  | G63620  |         | 37198  | G63694  |         | 555039 | G63359  |         | 65124  | 85053   | 89442   |
| 37075  | G63606  |         | 37199  | G63860  |         | 555041 | G63866  |         | 65128  | 85031   |         |
| 37076  | G63639  |         | 37202  | G64002  |         | 555043 | 83400   |         | 65129  | 85701   |         |
| 37077  | G63909  |         | 37203  | G63844  |         | 555045 | G63394  |         | 65130  | 85061   | 89450   |
| 37080  | G63624  |         | 37204  | G63845  |         | 557001 | 85013   | 89414   | 65133  | 85935   |         |
| 37082  | G63626  |         | 37206  | G63958  |         | 557002 | 85097   |         | 65139  | 85918   | 89449   |
| 37085  | G63896  |         | 37217  | G63862  |         | 557004 | G63866  |         | 65140  | 85918   | 89449   |
| 37086  | G63897  |         | 37218  | G63877  |         | 557005 | 83136   |         | 65141  | 85091   |         |
| 37088  | G63500  |         | 37231  | G63720  |         | 557006 | 83136   |         | 65142  | 83131   |         |
| 37089  | G63350  |         | 37238  | G63815  |         | 557007 | 85099   |         | 65143  | 83163   |         |
| 37090  | G63357  |         | 37240  | G63865  |         | 557008 | 85029   |         | 65144  | 85928   |         |
| 37091  | G63413  |         | 37241  | G63842  |         | 557009 | 85007   | 89412   | 65145  | 85929   |         |
| 37093  | G63359  |         | 37242  | G64014  |         | 557010 | 83144   |         | 65146  | 85925   |         |
| 37094  | G63353  |         | 37243  | G63610  |         | 557011 | 83160   |         | 65147  | 85924   | 89457   |
| 37097  | G63950  |         | 37244  | G63864  |         | 557012 | 85029   |         | 65148  | 85918   | 89449   |
| 37099  | G63423  |         | 37246  | G64003  |         | 557013 | 83127   |         | 65150  | 85953   |         |
| 37100  | G63904  |         | 37249  | G63434  |         | 557014 | 83126   | 89430   | 65151  | 85953   |         |
| 37101  | G63660  |         | 37803  | G63306  |         | 557015 | 83209   | 89414   | 65153  | 85921   |         |
| 37102  | G63661  |         | 38072  | 83043   |         | 557017 | 85029   |         | 65155  | 83175   |         |
| 37103  | G63662  |         | 39052  | G63868  |         | 557018 | 83127   |         | 65156  | 85005   |         |
| 37104  | G63673  |         | 40209  | 83161   |         | 557020 | 83123   | 89405   | 65157  | 85954   |         |
| 37108  | G63707  |         | 54487  | 85073   |         | 557021 | 85051   |         | 65158  | 85954   |         |
| 37109  | G63708  |         | 54488  | 85074   |         | 557022 | 85051   |         | 65159  | 85070   | 89459   |
| 37110  | G63676  |         | 550010 | G63375  |         | 557023 | 83144   |         | 65160  | 85080   |         |
| 37111  | G63937  |         | 550011 | 69606   |         | 557026 | 83127   |         | 65161  | 83136   |         |
| 37112  | G63689  |         | 550012 | G63375  |         | 557027 | 83144   |         | 65162  | 85959   |         |
| 37113  | G64005  |         | 550013 | 69724   |         | 557028 | 85010   |         | 65163  | 85954   |         |
| 37114  | G64004  |         | 550016 | G63424  |         | 557031 | 85010   |         | 65166  | 85090   |         |
| 37120  | G63511  |         | 550017 | G63425  |         | 557032 | 85126   |         | 65167  | G63969  |         |
| 37121  | G63490  |         | 550018 | 69575   |         | 557033 | 85900   |         | 65168  | 77968   |         |
| 37122  | G63678  |         | 550019 | G63918  |         | 557038 | 85125   |         | 65169  | 85342   |         |

**Important Note:** Competitive Interchanges are to be used for stocking purposes only. Where multiple crosses are identified, please reference the applications section of this catalog. / **Remarque importante:** Les interchanges concurrentiels ne s'utilisent qu'aux fins de stocks. Dans le cas de références multiples, consulter la section des applications du catalogue. / **Nota importante:** Dans le cas de références multiples, consulter la section des applications du catalogue. / **Nota importante:** Se pueden usar intercambios competitivos para propósitos de almacenamiento solamente. Cuando se identifican intercambios múltiples, consulte la sección de aplicaciones de este catálogo.

**COMPETITIVE & O.E.M. INTERCHANGE LIST**  
**Lista de Intercambios contra Competidores y Equipo Original.**  
**Liste d'interchange de produits compétitifs & d'équipement original (OEM)**

**MONROE... cont'd**

| Monroe | Gabriel | Upgrade | Monroe | Gabriel | Upgrade | Monroe | Gabriel | Upgrade | Monroe | Gabriel | Upgrade |
|--------|---------|---------|--------|---------|---------|--------|---------|---------|--------|---------|---------|
| 65170  | 85969   |         | 65445  | 85731   |         | 65502  | 85938   |         | 66107  | 83048   |         |
| 65171  | 85964   |         | 65446  | 85730   |         | 65503  | 85919   |         | 66108  | 83028   |         |
| 65172  | 83153   |         | 65447  | 85703   |         | 65504  | 85072   |         | 66109  | 83048   |         |
| 65173  | 85336   |         | 65448  | 85700   |         | 65505  | 85006   |         | 66111  | 83016   |         |
| 65174  | 58942   |         | 65449  | 85702   |         | 65506  | 83168   |         | 66112  | 83017   |         |
| 65175  | 85084   | 89460   | 65450  | 85701   |         | 65507  | 83143   |         | 66113  | 83050   |         |
| 65176  | 85084   | 89460   | 65451  | 85029   |         | 65508  | 83142   |         | 66114  | 83045   |         |
| 65177  | 85012   | 89413   | 65452  | 85733   |         | 65509  | 85079   |         | 66115  | 83045   |         |
| 65178  | 85998   |         | 65453  | 85904   |         | 65510  | 85052   |         | 66116  | 83018   |         |
| 65179  | 85995   |         | 65454  | 85030   | 89440   | 65511  | 85939   |         | 66117  | 83019   |         |
| 65180  | 85639   |         | 65455  | 85716   |         | 65512  | 85938   |         | 66118  | 83001   |         |
| 65183  | 85181   |         | 65456  | 85376   |         | 65513  | 85338   |         | 66120  | 85006   |         |
| 65184  | 85180   |         | 65457  | 85909   |         | 65514  | 85099   |         | 66121  | 83047   |         |
| 65185  | 85180   |         | 65458  | 85908   |         | 65515  | 85097   |         | 66122  | 83038   |         |
| 65400  | 85033   | 89427   | 65459  | 85043   |         | 65516  | 85013   | 89414   | 66123  | 83004   |         |
| 65401  | 85013   | 89414   | 65461  | 85059   |         | 65517  | 83165   |         | 66124  | 83040   |         |
| 65402  | 85311   | 89424   | 65462  | 85913   |         | 65518  | 85089   |         | 66125  | 83035   |         |
| 65404  | 85310   | 89423   | 65463  | 85040   |         | 65519  | 85060   |         | 66126  | 83051   |         |
| 65405  | 85023   | 89415   | 65464  | 85968   |         | 65520  | 85121   |         | 6613   | 83123   | 89405   |
| 65406  | 85024   |         | 65465  | 85939   |         | 65521  | 85014   |         | 66131  | 83062   |         |
| 65407  | 85736   |         | 65466  | 85047   | 89435   | 65522  | 85082   |         | 66132  | 83001   |         |
| 65408  | 85319   | 89428   | 65467  | 85054   | 89438   | 65523  | 85937   |         | 66135  | 83905   |         |
| 65409  | 85003   | 89411   | 65468  | 85069   | 89455   | 65524  | 85936   | 89456   | 6614   | 83125   |         |
| 65410  | 85300   | 89419   | 65469  | 85708   |         | 65525  | 87015   |         | 66142  | 83039   |         |
| 65411  | 85036   | 89405   | 65470  | 85708   |         | 65526  | 85956   |         | 66143  | 83007   |         |
| 65412  | 83122   | 89406   | 65471  | 85302   | 89420   | 65527  | 85955   |         | 66145  | 83008   |         |
| 65413  | 83136   |         | 65472  | 85330   |         | 65528  | 85069   | 89455   | 66147  | 83009   |         |
| 65414  | 85324   |         | 65473  | 85329   |         | 65529  | 85984   |         | 66149  | 83022   |         |
| 65415  | 85046   | 89434   | 65474  | 85712   |         | 65530  | 85932   | 89453   | 6615   | 83120   |         |
| 65416  | 85000   | 89436   | 65475  | 85065   |         | 65531  | 85334   |         | 66150  | 83003   |         |
| 65417  | 85322   |         | 65476  | 85736   |         | 65532  | 85967   |         | 66152  | 83012   |         |
| 65418  | 85906   | 89407   | 65477  | 85702   |         | 65533  | 85120   |         | 66154  | 83014   |         |
| 65419  | 85000   | 89436   | 65478  | 85058   | 89431   | 65534  | 85343   |         | 66157  | 83015   |         |
| 65420  | 85013   | 89414   | 65479  | 83122   | 89406   | 65535  | 85954   |         | 66159  | 83031   |         |
| 65421  | 85916   |         | 65480  | 83111   |         | 65536  | 85965   |         | 66160  | 83052   |         |
| 65422  | 85912   |         | 65481  | 85036   | 89405   | 65537  | 85962   |         | 66161  | 83054   |         |
| 65423  | 85907   |         | 65482  | 85006   |         | 65538  | 85966   |         | 66162  | 83025   |         |
| 65424  | 85905   |         | 65483  | 85978   |         | 65539  | 85961   |         | 66169  | 83027   |         |
| 65425  | 85056   | 89441   | 65484  | 85976   |         | 65541  | 85119   |         | 66178  | 83023   |         |
| 65426  | 85054   | 89438   | 65485  | 85972   |         | 65542  | 85102   |         | 66179  | 83013   |         |
| 65427  | 85903   |         | 65486  | 85066   | 89448   | 65546  | 85986   |         | 66181  | 83025   |         |
| 65428  | 85321   |         | 65487  | 85927   |         | 6603   | 83103   |         | 66182  | 83005   |         |
| 65429  | 85030   | 89440   | 65488  | 85926   |         | 6604   | 83101   |         | 66189  | 83041   |         |
| 65430  | 85968   |         | 65489  | 85331   |         | 6605   | 83613   |         | 66193  | 83034   |         |
| 65431  | 85909   |         | 65490  | 85724   | 89443   | 6606   | 83636   |         | 66195  | 83033   |         |
| 65432  | 85910   |         | 65491  | 85930   |         | 6607   | 85052   |         | 66196  | 83027   |         |
| 65433  | 85910   |         | 65492  | 85931   | 89458   | 6608   | 83128   |         | 66198  | 83158   |         |
| 65434  | 85012   | 89413   | 65493  | 85934   |         | 6609   | 83635   |         | 66199  | 83048   |         |
| 65435  | 85901   |         | 65494  | 85061   | 89450   | 6610   | 85051   |         | 66200  | 83066   |         |
| 65436  | 85900   |         | 65495  | 85067   | 89451   | 66101  | 83042   |         | 66201  | 83081   |         |
| 65439  | 85716   |         | 65496  | 83138   |         | 66102  | 83059   |         | 66203  | 83067   |         |
| 65440  | 85711   |         | 65497  | 85933   | 89454   | 66102  | 83063   |         | 66204  | 83024   |         |
| 65441  | 85704   |         | 65498  | 85964   |         | 66103  | 83046   |         | 66205  | 83063   |         |
| 65442  | 85700   |         | 65499  | 85963   |         | 66104  | 83021   |         | 66400  | G63432  |         |
| 65443  | 85706   |         | 65500  | 85738   |         | 66105  | 83044   |         | 66402  | 83157   |         |
| 65444  | 85311   | 89424   | 65501  | 85323   | 89436   | 66106  | 83016   |         | 66403  | 83154   |         |

**Important Note:** Competitive Interchanges are to be used for stocking purposes only. Where multiple crosses are identified, please reference the applications section of this catalog. / **Remarque importante:** Les interchanges concurrentiels ne s'utilisent qu'aux fins de stocks. Dans le cas de références multiples, consulter la section des applications du catalogue. / **Nota importante:** Dans le cas de références multiples, consulter la section des applications du catalogue. / **Nota importante:** Se pueden usar intercambios competitivos para propósitos de almacenamiento solamente. Cuando se identifican intercambios múltiples, consulte la sección de aplicaciones de este catálogo.

**COMPETITIVE & O.E.M. INTERCHANGE LIST**  
**Lista de Intercambios contra Competidores y Equipo Original.**  
**Liste d'interchange de produits compétitifs & d'équipement original (OEM)**

**MONROE... cont'd**

| Monroe | Gabriel | Upgrade | Monroe | Gabriel | Upgrade | Monroe | Gabriel | Upgrade | Monroe | Gabriel | Upgrade |
|--------|---------|---------|--------|---------|---------|--------|---------|---------|--------|---------|---------|
| 66405  | 83154   |         | 66616  | 83018   |         | 66695  | 83033   |         | 6714   | 83216   |         |
| 66406  | 85920   |         | 66617  | 83019   |         | 66697  | 83164   |         | 6715   | 85026   | 89417   |
| 66407  | 83134   |         | 66618  | 83159   |         | 66699  | 83113   |         | 6716   | 85042   |         |
| 66408  | 83145   |         | 66620  | 83162   |         | 66701  | 83215   |         | 6717   | G63616  |         |
| 66409  | 83146   |         | 66623  | 83004   |         | 66707  | 83215   |         | 6718   | 85024   |         |
| 66412  | 83156   |         | 66624  | 83141   |         | 66708  | 83100   |         | 6719   | 83242   |         |
| 66415  | G63918  |         | 66625  | 83162   |         | 66710  | 83209   | 89414   | 6720   | 85003   | 89411   |
| 66416  | 85085   |         | 66626  | 85071   |         | 66712  | 83100   |         | 6721   | 83103   |         |
| 66417  | G63919  |         | 66627  | 85045   |         | 66713  | 83105   |         | 6801   | G63484  |         |
| 66418  | 85918   | 89449   | 66628  | 83136   |         | 66714  | 83216   |         | 6803   | G63907  |         |
| 66419  | 85931   | 89458   | 66629  | 83107   |         | 66715  | 85026   | 89417   | 6811   | 83312   | 89409   |
| 66422  | 83163   |         | 66630  | 83216   |         | 66716  | 85042   |         | 6817   | G63355  |         |
| 66423  | 85001   | 89410   | 66631  | 83140   |         | 66717  | 83515   |         | 6824   | G63349  |         |
| 66424  | 85310   | 89423   | 66632  | 83006   |         | 66719  | 83242   |         | 6828   | 83219   |         |
| 66425  | 85920   |         | 66633  | 83127   |         | 66720  | 85003   | 89411   | 6829   | 83103   |         |
| 66426  | 85924   | 89457   | 66634  | 83203   | 89436   | 66801  | 83161   |         | 6831   | G63359  |         |
| 66427  | 89441   |         | 66636  | 83127   |         | 66811  | 83312   | 89409   | 6833   | 83126   | 89430   |
| 66428  | 85033   | 89427   | 66637  | 83304   |         | 66813  | 83303   |         | 6839   | G63357  |         |
| 66429  | 85311   | 89424   | 66638  | 83123   | 89405   | 66828  | 83159   |         | 6840   | 83217   |         |
| 66430  | 83309   |         | 66639  | G63610  |         | 66829  | 83103   |         | 6841   | 83216   |         |
| 66431  | 85066   | 89448   | 66642  | G63866  |         | 66833  | 83126   | 89430   | 6860   | 83308   | 89435   |
| 66432  | 85319   | 89428   | 66643  | 83007   |         | 66841  | 83216   |         | 6861   | 83309   | 89446   |
| 66433  | 85918   | 89449   | 66645  | 83008   |         | 66858  | G63183  |         | 6863   | 83314   |         |
| 66434  | 85069   | 89455   | 66646  | 83308   | 89435   | 66860  | 83308   | 89435   | 6864   | 83104   |         |
| 66435  | 83219   |         | 66647  | 83009   |         | 66861  | 83309   | 89446   | 6868   | G63360  |         |
| 66436  | 85067   | 89451   | 66648  | 83112   |         | 66863  | 83314   |         | 6878   | 83221   |         |
| 66438  | 83363   |         | 66649  | 83010   |         | 66864  | 83104   |         | 6886   | 83124   | 89407   |
| 66442  | 83150   |         | 66650  | 83003   |         | 66868  | 83219   |         | 6891   | 83215   |         |
| 66443  | 83150   |         | 66653  | 83515   |         | 66871  | G63605  |         | 6893   | 83203   | 89436   |
| 66445  | 83135   |         | 66654  | 83014   |         | 66878  | 83221   |         | 6894   | 83209   | 89414   |
| 66447  | 83180   |         | 66656  | 83110   |         | 66883  | 83314   |         | 6895   | 83204   |         |
| 66448  | 85058   |         | 66657  | 83015   |         | 66884  | 83125   |         | 6897   | 83126   | 89430   |
| 66454  | 83166   |         | 66658  | 85009   |         | 66886  | 83124   | 89407   | 6898   | 83125   |         |
| 66455  | 83166   |         | 66659  | 83002   |         | 66891  | 83215   |         | 6900   | G63386  |         |
| 66486  | 85066   | 89448   | 66660  | 85059   |         | 66893  | 83203   | 89436   | 6901   | G63387  |         |
| 66502  | 646155  |         | 66661  | 83123   | 89405   | 66894  | 83137   |         | 6902   | 83401   |         |
| 66503  | 646155  |         | 66664  | 83215   |         | 66897  | 83126   | 89430   | 6903   | 83400   |         |
| 66504  | 632147  |         | 66665  | 83109   |         | 66898  | 83125   |         | 6910   | G63413  |         |
| 66506  | 646155  |         | 66666  | G63671  |         | 66902  | 83401   |         | 6911   | G63350  |         |
| 66535  | 85062   | 89408   | 66668  | 83313   | 89439   | 66903  | 83400   |         | 6912   | 83304   |         |
| 6658   | 85009   |         | 66669  | 83111   |         | 66912  | 83304   |         | 6913   | 83303   |         |
| 66601  | 83114   |         | 66670  | 83200   |         | 66913  | 83303   |         | 6916   | 83123   | 89405   |
| 66602  | 83161   |         | 66671  | 83123   | 89405   | 66921  | 83318   |         | 6920   | G63411  |         |
| 66603  | 83103   |         | 66672  | 83209   | 89414   | 66922  | 83301   |         | 6921   | 83318   |         |
| 66604  | 83101   |         | 66677  | 83114   |         | 66923  | 83456   | 89447   | 6922   | 83301   |         |
| 66605  | 83613   |         | 66678  | 83023   |         | 66924  | 83317   |         | 6923   | 83456   | 89447   |
| 66606  | 83636   |         | 66679  | 83013   |         | 66956  | 83101   |         | 6927   | G63409  |         |
| 66607  | 85052   |         | 66680  | 83317   |         | 66957  | 83225   |         | 6945   | G63421  |         |
| 66608  | 83128   |         | 66681  | 83025   |         | 66966  | 85740   |         | 6956   | 83101   |         |
| 66609  | 83635   |         | 66682  | 83005   |         | 66969  | 83126   | 89430   | 6957   | 83225   |         |
| 66610  | 83130   |         | 66683  | 83101   |         | 6701   | 83215   |         | 6960   | G63366  |         |
| 66611  | 83016   |         | 66684  | 85007   | 89412   | 6707   | 83215   |         | 6969   | 83126   | 89430   |
| 66612  | 83017   |         | 66686  | 85014   |         | 6708   | 83100   |         | 6994   | 83122   | 89406   |
| 66613  | 83123   | 89405   | 66691  | 83118   |         | 6710   | 83209   | 89414   | 70039  | 85303   | 89422   |
| 66614  | 83125   |         | 66692  | 83120   |         | 6712   | 85040   |         | 70166  | 85301   |         |
| 66615  | 83120   |         | 66693  | 83034   |         | 6713   | 83105   |         | 70300  | 85320   | 89429   |

**Important Note:** Competitive Interchanges are to be used for stocking purposes only. Where multiple crosses are identified, please reference the applications section of this catalog. / **Remarque importante:** Les interchanges concurrentiels ne s'utilisent qu'aux fins de stocks. Dans le cas de références multiples, consulter la section des applications du catalogue. / **Nota importante:** Dans le cas de références multiples, consulter la section des applications du catalogue. / **Nota importante:** Se pueden usar intercambios competitivos para propósitos de almacenamiento solamente. Cuando se identifican intercambios múltiples, consulte la sección de aplicaciones de este catálogo.

**COMPETITIVE & O.E.M. INTERCHANGE LIST**  
**Lista de Intercambios contra Competidores y Equipo Original.**  
**Liste d'interchange de produits compétitifs & d'équipement original (OEM)**

**MONROE... cont'd**

| Monroe | Gabriel | Upgrade | Monroe | Gabriel | Upgrade | Monroe | Gabriel | Upgrade | Monroe  | Gabriel | Upgrade |
|--------|---------|---------|--------|---------|---------|--------|---------|---------|---------|---------|---------|
| 70312  | 85001   | 89410   | 74400  | 85700   |         | 74440  | 85729   |         | 911222  | G63970  |         |
| 70331  | 85314   | 89425   | 74402  | 85711   |         | 74441  | 85339   |         | 911228  | G63882  |         |
| 70332  | 83314   |         | 74405  | 85300   | 89419   | 74442  | 85727   |         | 911229  | G63884  |         |
| 70334  | 85316   | 89426   | 74406  | 85712   |         | 74443  | 85377   |         | 911230  | G63879  |         |
| 70402  | 85305   |         | 74408  | 85702   |         | 74444  | 85378   |         | 911251  | G63878  |         |
| 70447  | 85940   |         | 74409  | 85310   | 89423   | 74445  | 85381   |         | 911252  | G63883  |         |
| 70447  | 85949   |         | 74410  | 85701   |         | 74446  | 85352   |         | 911253  | G63875  |         |
| 70448  | 85943   |         | 74411  | 85703   |         | 74451  | 85711   |         | 911255  | G63894  |         |
| 70449  | 85942   |         | 74412  | 85704   |         | 74452  | 85740   |         | 911256  | G63893  |         |
| 70454  | 85941   |         | 74413  | 85313   |         | 74453  | 85339   |         | 911257  | G63895  |         |
| 70459  | 85948   |         | 74414  | 85723   |         | 74454  | 85314   | 89425   | 911258  | G63872  |         |
| 70459  | 85951   |         | 74415  | 85318   |         | 74457  | 695406  |         | 911259  | G64016  |         |
| 70477  | 85949   |         | 74416  | 85705   | 89447   | 74458  | 695406  |         | 911260  | G63892  |         |
| 70720  | 85934   |         | 74417  | 85311   | 89424   | 74461  | 87019   |         | 911265  | G64010  |         |
| 74001  | 85307   |         | 74418  | 85709   |         | 74462  | 85346   |         | 911266  | G63886  |         |
| 74003  | 85314   | 89425   | 74420  | 85003   | 89411   | 74463  | 85347   |         | 911267  | G63887  |         |
| 74004  | 85315   |         | 74421  | 85708   |         | 74464  | 85318   |         | 911268  | G63888  |         |
| 74006  | 85304   |         | 74422  | 85733   |         | 74465  | 85708   |         | 911270  | G63885  |         |
| 74012  | 85736   |         | 74423  | 85712   |         | 74466  | 85318   |         | 911277  | G63890  |         |
| 74024  | 85308   | 89422   | 74424  | 85308   | 89422   | 74467  | 85723   |         | 911278  | G64012  |         |
| 74025  | 85303   | 89422   | 74425  | 85724   | 89443   | 74469  | 85345   |         | 911279  | G63889  |         |
| 74028  | 85302   | 89420   | 74426  | 85333   |         | 74470  | 89461   |         | 911280  | G64007  |         |
| 74029  | 85308   | 89422   | 74427  | 85308   | 89422   | 74471  | 85736   |         | 911508  | G64000  |         |
| 74069  | 85301   |         | 74429  | 85919   |         | 74472  | 85303   | 89422   | 911527  | G64001  |         |
| 74070  | 85716   |         | 74430  | 85340   |         | 74473  | 85716   |         | 911528  | G63965  |         |
| 74073  | 85320   | 89429   | 74431  | 85341   |         | 74475  | 85746   |         | 911533  | G63959  |         |
| 74074  | 85722   |         | 74432  | 85970   |         | 74476  | 85745   |         | 911534  | G64011  |         |
| 74075  | 85712   |         | 74433  | 85331   |         | 74477  | 83165   |         | 911535  | G64013  |         |
| 74076  | 85706   |         | 74434  | 85711   |         | 74478  | 85089   |         | 911536  | G64008  |         |
| 74077  | 85324   |         | 74435  | 87017   |         | 911030 | G63479  |         | 911538  | G63966  |         |
| 74078  | 85027   | 89418   | 74436  | 85334   |         | 911171 | G63813  |         | 911539  | G63967  |         |
| 74079  | 85336   |         | 74437  | 89461   |         | 911172 | G63491  |         | SC-2920 | 83176   |         |
| 74080  | 85332   |         | 74438  | 85734   |         | 911183 | G63832  |         |         |         |         |
| 74081  | 85727   |         | 74439  | 85728   |         | 911184 | G63828  |         |         |         |         |

**MOR-RYDE SUSPENSION**

| O.E.M #   | Gabriel | Upgrade | O.E.M #   | Gabriel | Upgrade | O.E.M #   | Gabriel | Upgrade | O.E.M #   | Gabriel | Upgrade |
|-----------|---------|---------|-----------|---------|---------|-----------|---------|---------|-----------|---------|---------|
| U0109-006 | G63866  |         | U0109-007 | G63183  |         | U0109-014 | 83400   |         | U0109-018 | G63866  |         |

**MOTOR COACH INDUSTRIES**

| O.E.M #    | Gabriel | Upgrade | O.E.M #    | Gabriel | Upgrade | O.E.M #    | Gabriel | Upgrade | O.E.M #   | Gabriel | Upgrade |
|------------|---------|---------|------------|---------|---------|------------|---------|---------|-----------|---------|---------|
| 01-205219  | 85727   |         | 12-05-1176 | 85728   |         | 12-05-6000 | 85711   |         | 12J-5-3   | 85313   |         |
| 12-05-1021 | 85340   |         | 12-05-1177 | 85729   |         | 12-05-6001 | 85740   |         | 12J-5-4   | 85733   |         |
| 12-05-1022 | 85970   |         | 12-05-1178 | 85339   |         | 12-05-6002 | 85339   |         | 12J-5-6   | 85313   |         |
| 12-05-1023 | 85341   |         | 12-05-1179 | 85727   |         | 12-05-6033 | 85339   |         | 12J-5-7   | 85733   |         |
| 12-05-1101 | 85340   |         | 12-05-1188 | 85970   |         | 12-05-6053 | 85711   |         | 12J-5-71  | 85733   |         |
| 12-05-1102 | 85970   |         | 12-05-1194 | 85339   |         | 12-05-6054 | 85740   |         | 12J-5-9   | 85700   |         |
| 12-05-1103 | 85341   |         | 12-05-1199 | 85729   |         | 12-05-6055 | 85339   |         | 12L-4-170 | 83158   |         |
| 12-05-1137 | 85340   |         | 12-05-1228 | 85711   |         | 12-05-6068 | 85727   |         | 12L-5-100 | 85727   |         |
| 12-05-1138 | 85970   |         | 12-05-1242 | 85728   |         | 12-5-1-G   | 85700   |         | 12L-5-114 | 85727   |         |
| 12-05-1139 | 85341   |         | 12-05-1243 | 85729   |         | 12-5-1-GS  | 85700   |         | 12L-5-58  | 85728   |         |
| 12-05-1142 | 85340   |         | 12-05-1244 | 85727   |         | 12B-5-1    | 85735   |         | 12L-5-67  | 85728   |         |
| 12-05-1146 | 85340   |         | 12-05-1260 | 85728   |         | 12B-5-1-G  | 85700   |         | 12L-5-69  | 85700   |         |
| 12-05-1147 | 85341   |         | 12-05-1261 | 85729   |         | 12B-5-1-GS | 85700   |         | 12L-5-70  | 85700   |         |
| 12-05-1148 | 85970   |         | 12-05-1262 | 85727   |         | 12G-5-1    | 85700   |         | 12L-5-71  | 85708   |         |
| 12-05-1150 | 85711   |         | 12-05-1264 | 85727   |         | 12J-5-10   | 85733   |         |           |         |         |
| 12-05-1165 | 85711   |         | 12-05-1327 | 85728   |         | 12J-5-10GS | 85733   |         |           |         |         |
| 12-05-1166 | 85341   |         | 12-05-1328 | 85729   |         | 12J-5-11   | 85313   |         |           |         |         |
| 12-05-1170 | 85340   |         | 12-05-1329 | 85727   |         | 12J-5-2    | 85733   |         |           |         |         |

**Important Note:** Competitive Interchanges are to be used for stocking purposes only. Where multiple crosses are identified, please reference the applications section of this catalog. / **Remarque importante:** Les interchanges concurrentiels ne s'utilisent qu'aux fins de stocks. Dans le cas de références multiples, consulter la section des applications du catalogue. / **Nota importante:** Dans le cas de références multiples, consulter la section des applications du catalogue. / **Nota importante:** Se pueden usar intercambios competitivos para propósitos de almacenamiento solamente. Cuando se identifican intercambios múltiples, consulte la sección de aplicaciones de este catálogo.

**COMPETITIVE & O.E.M. INTERCHANGE LIST**  
**Lista de Intercambios contra Competidores y Equipo Original.**  
**Liste d'interchange de produits compétitifs & d'équipement original (OEM)**

**MOTOR COACH INDUSTRIES... cont'd**

| O.E.M #     | Gabriel | Upgrade | O.E.M #   | Gabriel | Upgrade | O.E.M #       | Gabriel | Upgrade | O.E.M #    | Gabriel | Upgrade |
|-------------|---------|---------|-----------|---------|---------|---------------|---------|---------|------------|---------|---------|
| 12L-5-72    | 85709   |         | 22052014  | 85702   |         | 680470        | 85713   |         | G1101590   | 85713   |         |
| 12L-5-88    | 85729   |         | 3178154   | 85735   |         | 680482        | 85727   |         | G1101590GS | 85713   |         |
| 12L-5-89    | 85729   |         | 3178157   | 85700   |         | 680485        | 85733   |         | G1201338   | 85710   |         |
| 12L-5-96    | 85728   |         | 5316984   | 85313   |         | 680544        | 85711   |         | G1201339   | 85702   |         |
| 12L-5-97    | 85728   |         | 63-0127GS | 85303   | 89422   | 680546        | 85339   |         | G5008069   | 85700   |         |
| 12L-5-98    | 85339   |         | 6314933   | 85708   |         | 680602        | 85339   |         | OE10086S   | 85702   |         |
| 12L-5-99    | 85339   |         | 654789    | 83158   |         | 680677        | 85728   |         | OE10881    | 85711   |         |
| 12T-1-13    | 85303   | 89422   | 680231    | 85313   |         | 680680        | 85729   |         | OE10882    | 85740   |         |
| 12TA-01-013 | 85303   | 89422   | 680232    | 85733   |         | 680681        | 85727   |         | OE10883    | 85339   |         |
| 1497835     | 85711   |         | 680322    | 85704   |         | 690029        | 85700   |         | T12-1208   | 85727   |         |
| 1498200     | 85740   |         | 680323    | 85700   |         | 695125        | 85704   |         | T14-1045GS | 85700   |         |
| 1498565     | 85339   |         | 680333    | 85708   |         | 85729         | 85729   |         | T14-1048   | 85302   | 89420   |
| 22012066    | 85707   |         | 680350    | 85710   |         | 97-2201-00151 | 85700   |         | T14-1080   | 85728   |         |
| 22012067    | 85700   |         | 680369    | 85708   |         | 97-2210-00164 | 85708   |         | T14-1081   | 85729   |         |
| 22024061    | 85704   |         | 680374    | 85728   |         | 97-9999-02514 | 85700   |         | T14-1082   | 85727   |         |
| 22024673    | 85710   |         | 680441    | 85729   |         | 97-9999-02585 | 85723   |         |            |         |         |
| 22045526    | 85702   |         | 680452    | 85339   |         | 97-9999-02634 | 85733   |         |            |         |         |
| 22046485    | 85710   |         | 680462    | 85728   |         | G1011822      | 85702   |         |            |         |         |

**MOTORCRAFT**

| Motorcraft | Gabriel | Upgrade | Motorcraft | Gabriel | Upgrade | Motorcraft | Gabriel | Upgrade | Motorcraft | Gabriel | Upgrade |
|------------|---------|---------|------------|---------|---------|------------|---------|---------|------------|---------|---------|
| AA-229     | G63773  |         | ASH-122    | G63614  |         | ASH-684    | G63623  |         | AT-568     | G63622  |         |
| AA-450     | G63773  |         | ASH-1228   | 83209   | 89414   | ASH-69     | 83175   |         | AT-579     | G63809  |         |
| AA-456     | G63772  |         | ASH-1230   | 83122   | 89406   | ASH-706    | G63614  |         | AT-610     | G63461  |         |
| AA-457     | G63678  |         | ASH-132    | G63614  |         | ASH-707    | G63614  |         | AT-611     | G63461  |         |
| AA-483     | G63837  |         | ASH-137    | 83122   | 89406   | ASH-712    | 69575   |         | AT-620     | 83209   | 89414   |
| AA-484     | G63837  |         | ASH-23454  | G63614  |         | ASH-824    | G63929  |         | AT-621     | 83122   | 89406   |
| AA-485     | G63837  |         | ASH-23458  | G63614  |         | ASHV-1     | G63678  |         | AT-682     | G63678  |         |
| AA-486     | G63607  |         | ASH-24401  | G63809  |         | ASHV-1015  | G63622  |         | AT-683     | G63679  |         |
| AA-494     | 83131   |         | ASH-24402  | 85928   |         | ASHV-1025  | G63623  |         | AT-684     | G63679  |         |
| AA-500     | G63809  |         | ASH-24433  | G63837  |         | ASHV-1028  | G63778  |         | AT-685     | G63679  |         |
| AA-501     | G63809  |         | ASH-24434  | G63607  |         | ASHV-1046  | G63772  |         | AT-696     | 83140   |         |
| AA-502     | G63614  |         | ASH-24492  | 83175   |         | ASHV-1047  | G63607  |         | AT-710     | G63809  |         |
| AA-503     | G63614  |         | ASH-24659  | 85181   |         | ASHV-1048  | G63525  |         | AT-713     | G63614  |         |
| AA-504     | G63614  |         | ASH-24660  | 85180   |         | ASHV-1049  | G63524  |         | AT-715     | G63614  |         |
| AA-615     | 83135   |         | ASH-25     | 83309   | 89446   | ASHV-1050  | G63608  |         | AT-716     | G63809  |         |
| AA-616     | 83175   |         | ASH-29     | 83314   |         | ASHV-1051  | G63837  |         | AT-764     | G63678  |         |
| AA-617     | 85928   |         | ASH-294    | 83209   | 89414   | ASHV-13    | G63676  |         | AT-765     | G63772  |         |
| AS-1086    | G63678  |         | ASH-32     | 83125   |         | ASHV-14    | G63837  |         | AT-766     | 83209   | 89414   |
| AS-413     | G63414  |         | ASH-322    | 77969   |         | ASHV-3     | G63714  |         | AT-811     | 83135   |         |
| AS-433     | G63406  |         | ASH-324    | 77968   |         | ASHV-4     | G63716  |         | AX-131A    | 83217   |         |
| AS-485G    | G63622  |         | ASH-335    | G63969  |         | ASHV-6     | G63809  |         | AX-135A    | G63406  |         |
| AS-498G    | G63608  |         | ASH-36     | 85716   |         | ASHV-864   | G63929  |         | AX-267A    | 83309   | 89446   |
| AS-500G    | G63624  |         | ASH-362    | G63607  |         | ASHV-865   | G63808  |         | AX-269A    | 83308   | 89435   |
| ASH-1022   | 83209   | 89414   | ASH-363    | G63525  |         | ASHV-866   | G63810  |         | AX-269A    | 83312   | 89409   |
| ASH-1023   | 83122   | 89406   | ASH-364    | G63524  |         | ASHV-867   | G63455  |         | AX-277A    | 83219   |         |
| ASH-1130   | G63622  |         | ASH-365    | G63772  |         | ASHV-868   | G63406  |         | AX-282A    | 85010   |         |
| ASH-1131   | G63622  |         | ASH-366    | G63608  |         | ASHV-871   | G63809  |         | AX-310     | 83215   |         |
| ASH-1132   | G63622  |         | ASH-38     | 85314   | 89425   | ASHV-879   | G63455  |         | AX-327     | G63773  |         |
| ASH-1135   | G63623  |         | ASH-387    | G63809  |         | AST-260    | G63929  |         | AX-332     | 85928   |         |
| ASH-1136   | 83178   |         | ASH-39     | 85001   | 89410   | AT-163G    | 83177   |         | AX-79A     | 83221   |         |
| ASH-1154   | 83177   |         | ASH-391    | G63809  |         | AT-164G    | 83178   |         | AX-79A     | 85030   | 89440   |
| ASH-1155   | G63623  |         | ASH-394    | G63614  |         | AT-504G    | G63679  |         | AX-97A     | 83122   | 89406   |
| ASH-119    | G63809  |         | ASH-397    | 83131   |         | AT-506G    | G63679  |         | AX-97A     | 85005   | 89430   |
| ASH-120    | G63837  |         | ASH-398    | 85928   |         | AT-507G    | G63607  |         |            |         |         |
| ASH-1205   | 83209   | 89414   | ASH-407    | G63809  |         | AT-546     | G63678  |         |            |         |         |
| ASH-1206   | 83122   |         | ASH-408    | G63809  |         | AT-547     | G63775  |         |            |         |         |
| ASH-121    | G63607  |         | ASH-51     | G63773  |         | AT-554     | 85305   |         |            |         |         |

**Important Note:** Competitive Interchanges are to be used for stocking purposes only. Where multiple crosses are identified, please reference the applications section of this catalog. / **Remarque importante:** Les interchanges concurrentiels ne s'utilisent qu'aux fins de stocks. Dans le cas de références multiples, consulter la section des applications du catalogue. / **Nota importante:** Dans le cas de références multiples, consulter la section des applications du catalogue. / **Nota importante:** Se pueden usar intercambios competitivos para propósitos de almacenamiento solamente. Cuando se identifican intercambios múltiples, consulte la sección de aplicaciones de este catálogo.



**COMPETITIVE & O.E.M. INTERCHANGE LIST**  
**Lista de Intercambios contra Competidores y Equipo Original.**  
**Liste d'interchange de produits compétitifs & d'équipement original (OEM)**

**MOTORCRAFT... cont'd**

| Motorcraft | Gabriel | Upgrade | Motorcraft | Gabriel | Upgrade | Motorcraft | Gabriel | Upgrade | Motorcraft | Gabriel | Upgrade |
|------------|---------|---------|------------|---------|---------|------------|---------|---------|------------|---------|---------|
| CAH-001    | 85307   |         | CAT-777    | G63662  |         | CAT-935    | G63424  |         | CAX-841    | 83216   |         |
| CAH-001    | 85711   |         | CAT-778    | G63673  |         | CAT-936    | G63425  |         | CAX-860    | 83308   | 89435   |
| CAH-003    | 83215   |         | CAT-793    | G63414  |         | CAT-944    | G63347  |         | CAX-861    | 83309   | 89446   |
| CAH-006    | 85304   |         | CAT-802    | G63419  |         | CAT-944    | G63908  |         | CAX-863    | 83314   |         |
| CAH-012    | 85736   |         | CAT-802    | G63492  |         | CAT-945    | G63421  |         | CAX-878    | 83221   |         |
| CAH-025    | 85007   | 89412   | CAT-802    | G63928  |         | CAT-945    | G63457  |         | CAX-886    | 83207   | 89407   |
| CAH-028    | 85302   | 89420   | CAT-803    | G63306  |         | CAT-948    | G63909  |         | CAX-886    | 85014   |         |
| CAH-029    | 85308   | 89422   | CAT-817    | G63355  |         | CAT-953    | G63375  |         | CAX-891    | 83215   |         |
| CAH-069    | 83219   |         | CAT-824    | G63349  |         | CAT-953    | G63900  |         | CAX-891    | 85314   | 89425   |
| CAH-069    | 85301   |         | CAT-826    | G63187  |         | CAT-953    | G63903  |         | CAX-893    | 83203   | 89436   |
| CAHL-400   | 85303   | 89422   | CAT-828    | G63494  |         | CAT-955    | G63454  |         | CAX-893    | 85000   | 89436   |
| CAHL-400   | 85700   |         | CAT-831    | G63359  |         | CAT-958    | G63377  |         | CAX-893    | 85043   |         |
| CAHL-405   | 85300   | 89419   | CAT-832    | G63353  |         | CAT-960    | G63366  |         | CAX-894    | 83209   | 89414   |
| CAHL-406   | 85004   |         | CAT-839    | G63357  |         | CAT-963    | G63427  |         | CAX-894    | 85005   | 89430   |
| CAHL-409   | 85310   | 89423   | CAT-853    | G63183  |         | CAT-963    | G63525  |         | CAX-894    | 85013   | 89414   |
| CAHL-417   | 85311   | 89424   | CAT-854    | G63389  |         | CAT-964    | G63420  |         | CAX-898    | 83125   |         |
| CAT-722    | 83400   |         | CAT-868    | G63360  |         | CAT-964    | G63456  |         | CAX-898    | 85006   |         |
| CAT-729    | G63414  |         | CAT-895    | 83207   | 89407   | CAT-972    | G63610  |         | CAX-912    | 83304   |         |
| CAT-730    | G63386  |         | CAT-899    | G63500  |         | CAT-975    | G63511  |         | CAX-913    | 83303   |         |
| CAT-731    | G63409  |         | CAT-900    | G63386  |         | CAT-976    | G63490  |         | CAX-916    | 83123   | 89405   |
| CAT-732    | G63455  |         | CAT-901    | G63387  |         | CAT-977    | G63915  |         | CAX-916    | 85036   | 89405   |
| CAT-733    | G63617  |         | CAT-904    | G63299  |         | CAT-978    | G63460  |         | CAX-921    | 83318   |         |
| CAT-736    | G63394  |         | CAT-905    | G63405  |         | CAT-983    | G63489  |         | CAX-923    | 83102   |         |
| CAT-737    | G63502  |         | CAT-906    | G63396  |         | CAT-984    | G63609  |         | CAX-923    | 83456   | 89447   |
| CAT-739    | G63603  |         | CAT-907    | G63511  |         | CAT-984    | G63818  |         | CAX-924    | 83317   |         |
| CAT-740    | G63423  |         | CAT-909    | G63398  |         | CAT-985    | G63488  |         | CAX-957    | 83217   |         |
| CAT-741    | G63489  |         | CAT-910    | G63413  |         | CAT-986    | G63489  |         | CAX-957    | 83225   |         |
| CAT-745    | G63608  |         | CAT-911    | G63350  |         | CAT-990    | G63906  |         | CAX-969    | 83221   |         |
| CAT-745    | G63614  |         | CAT-912    | G63625  |         | CAX-001    | 85307   |         | CAX-969    | 85011   |         |
| CAT-750    | G63359  |         | CAT-919    | G63411  |         | CAX-707    | 83215   |         | CAX-969    | 85030   | 89440   |
| CAT-751    | G63607  |         | CAT-920    | G63675  |         | CAX-707    | 85001   | 89410   | CLT-109    | G63614  |         |
| CAT-758    | G63909  |         | CAT-926    | G63410  |         | CAX-710    | 83209   | 89414   | CLT-112    | G63525  |         |
| CAT-759    | G63624  |         | CAT-927    | G63409  |         | CAX-720    | 85003   | 89411   | CLT-113    | G63524  |         |
| CAT-760    | G63622  |         | CAT-927    | G63690  |         | CAX-811    | 83312   | 89409   | CLT-114    | G63635  |         |
| CAT-761    | G63623  |         | CAT-928    | G63410  |         | CAX-828    | 83207   | 89407   | CLT-116    | G63902  |         |
| CAT-762    | G63638  |         | CAT-929    | G63403  |         | CAX-828    | 85012   | 89413   | CLT-124    | G63610  |         |
| CAT-768    | 83209   | 89414   | CAT-930    | G63461  |         | CAX-833    | 83303   |         | CLT-138    | G63502  |         |
| CAT-776    | G63661  |         | CAT-932    | G63398  |         | CAX-833    | 85005   | 89430   |            |         |         |

**MUNCIE RECLAMATION**

| O.E.M #       | Gabriel | Upgrade | O.E.M # | Gabriel | Upgrade | O.E.M # | Gabriel | Upgrade | O.E.M # | Gabriel | Upgrade |
|---------------|---------|---------|---------|---------|---------|---------|---------|---------|---------|---------|---------|
| 665459        | 89447   |         | MR1623  | 85700   |         | MR2996  | 85704   |         | MR3650  | 85707   |         |
| 665568        | 85051   |         | MR1710  | 85713   |         | MR2997  | 85703   |         | MR6394  | 85723   |         |
| 665569        | 85045   |         | MR1751  | 85713   |         | MR3303  | 85709   |         | MR6535  | 85708   |         |
| 680334        | 85709   |         | MR1763  | 85300   | 89419   | MR3304  | 85710   |         | MR6536  | 85722   |         |
| 97-2210-00164 | 85708   |         | MR1765  | 85713   |         | MR3304H | 85709   |         | MR7388  | 85710   |         |
| H53-20415-006 | 85051   |         | MR25767 | 85702   |         | MR3306  | 85705   | 89447   |         |         |         |
| H53-21144-004 | 85045   |         | MR2960  | 85702   |         | MR3307  | 85707   |         |         |         |         |

**NATIONAL COACH CORP**

| O.E.M # | Gabriel | Upgrade | O.E.M # | Gabriel | Upgrade | O.E.M # | Gabriel | Upgrade | O.E.M # | Gabriel | Upgrade |
|---------|---------|---------|---------|---------|---------|---------|---------|---------|---------|---------|---------|
| C800853 | 83207   | 89407   |         |         |         |         |         |         |         |         |         |

**NATIONAL RV INC.**

| O.E.M #       | Gabriel | Upgrade | O.E.M #       | Gabriel | Upgrade | O.E.M #  | Gabriel | Upgrade | O.E.M #  | Gabriel | Upgrade |
|---------------|---------|---------|---------------|---------|---------|----------|---------|---------|----------|---------|---------|
| 1C34-18045-AA | 83209   | 89414   | 24-186629     | 85125   |         | ASH-1022 | 83209   | 89414   | ASH-1229 | 83209   | 89414   |
| 1C34-18045-JA | 83209   | 89414   | 9U94-18045-AA | 83209   | 89414   | ASH-1023 | 83122   | 89406   |          |         |         |
| 24-153249     | 85125   |         | 9U94-18080-AA | 83122   | 89406   | ASH-1205 | 83209   | 89414   |          |         |         |
| 24-153256     | 85124   |         | 9U9Z-18124-A  | 83209   | 89414   | ASH-1206 | 83122   | 89406   |          |         |         |
| 24-186537     | 85126   |         | 9U9Z-18125-A  | 83122   | 89406   | ASH-1228 | 83209   | 89414   |          |         |         |

**Important Note:** Competitive Interchanges are to be used for stocking purposes only. Where multiple crosses are identified, please reference the applications section of this catalog. / **Remarque importante:** Les interchanges concurrentiels ne s'utilisent qu'aux fins de stocks. Dans le cas de références multiples, consulter la section des applications du catalogue. / **Nota importante:** Dans le cas de références multiples, consulter la section des applications du catalogue. / **Nota importante:** Se pueden usar intercambios competitivos para propósitos de almacenamiento solamente. Cuando se identifican intercambios múltiples, consulte la sección de aplicaciones de este catálogo.

**COMPETITIVE & O.E.M. INTERCHANGE LIST**  
**Lista de Intercambios contra Competidores y Equipo Original.**  
**Liste d'interchange de produits compétitifs & d'équipement original (OEM)**

**NATIONAL RV INC.... cont'd**

| O.E.M #   | Gabriel | Upgrade | O.E.M #        | Gabriel | Upgrade | O.E.M #        | Gabriel | Upgrade | O.E.M #  | Gabriel | Upgrade |
|-----------|---------|---------|----------------|---------|---------|----------------|---------|---------|----------|---------|---------|
| ASH-1230  | 83122   | 89406   | ASH-294        | 83209   | 89414   | F4-BE5-A832-MO | 85125   |         | W0005663 | 85124   |         |
| ASH-137   | 83122   | 89406   | AT-620         | 83209   | 89414   | F4-BE5-B492-HO | 85125   |         | W0006254 | 85125   |         |
| ASH-25822 | 83209   | 89414   | AT-621         | 83122   | 89406   | F4-BE5-F324-HO | 85125   |         |          |         |         |
| ASH-25823 | 83209   | 89414   | AT-766         | 83209   | 89414   | F4-BE5-F325-HO | 85124   |         |          |         |         |
| ASH-25824 | 83122   | 89406   | F4-BE5-A011-HO | 85126   |         | W0005662       | 85125   |         |          |         |         |

**NEOPLAN BUS**

| O.E.M #         | Gabriel | Upgrade | O.E.M #     | Gabriel | Upgrade | O.E.M #    | Gabriel | Upgrade | O.E.M #   | Gabriel | Upgrade |
|-----------------|---------|---------|-------------|---------|---------|------------|---------|---------|-----------|---------|---------|
| 24-1700-106-149 | 83216   |         | AA1002002   | 85705   | 89447   | BN1002002  | 85009   |         | DZ1002002 | 85705   | 89447   |
| 24-1700-999-362 | 85009   |         | AA1002003   | 85705   | 89447   | BT1002011  | 83216   |         | GJ1002002 | 85706   |         |
| 25-1700-101-426 | 85705   | 89447   | AA1802002   | 85705   | 89447   | CI 1002003 | 85705   | 89447   | GJ1002003 | 85705   | 89447   |
| 680307          | 85705   | 89447   | AC1002002   | 85705   | 89447   | CL1002003  | 85705   | 89447   | MM1002002 | 85705   | 89447   |
| 680308          | 85706   |         | AC1002002GS | 85705   | 89447   | DT1002002  | 85707   |         | MM1002003 | 85705   | 89447   |
| 97-9999-02519   | 85707   |         | AC1002003   | 85705   | 89447   | DT1802002  | 85705   | 89447   |           |         |         |

**NEW FLYER**

| O.E.M # | Gabriel | Upgrade | O.E.M #   | Gabriel | Upgrade | O.E.M #   | Gabriel | Upgrade | O.E.M #       | Gabriel | Upgrade |
|---------|---------|---------|-----------|---------|---------|-----------|---------|---------|---------------|---------|---------|
| 009863  | 85722   |         | 203398    | 85346   |         | 68037840B | 85720   |         | 69536640Y     | 85732   |         |
| 015813  | 85708   |         | 204428    | 85347   |         | 68050440X | 85716   |         | 97-2210-00164 | 85708   |         |
| 015915  | 85711   |         | 68027440Y | 85716   |         | 68050640Y | 85732   |         | G1011823      | 85710   |         |
| 016415  | 85722   |         | 680346    | 85722   |         | 680671    | 85708   |         |               |         |         |
| 064845  | 85711   |         | 68035041Y | 85710   |         | 690102    | 85711   |         |               |         |         |
| 152959  | 85708   |         | 680352    | 85711   |         | 69536140Y | 87016   |         |               |         |         |

**NEWMAR CORP**

| O.E.M #      | Gabriel | Upgrade | O.E.M #      | Gabriel | Upgrade | O.E.M #      | Gabriel | Upgrade | O.E.M #   | Gabriel | Upgrade |
|--------------|---------|---------|--------------|---------|---------|--------------|---------|---------|-----------|---------|---------|
| 141700131809 | 85029   |         | 16-16737-000 | 83160   |         | 481700000493 | 85900   |         | ASH-25823 | 83209   | 89414   |
| 141700131810 | 83160   |         | 16-16874-000 | 83160   |         | ASH-1229     | 83209   | 89414   | ASH-25824 | 83122   | 89406   |
| 16-16736-000 | 85029   |         | 16-18103-000 | 85900   |         | ASH-25822    | 83209   | 89414   |           |         |         |

**NEXUS RV**

| O.E.M #  | Gabriel | Upgrade | O.E.M #   | Gabriel | Upgrade | O.E.M #   | Gabriel | Upgrade | O.E.M # | Gabriel | Upgrade |
|----------|---------|---------|-----------|---------|---------|-----------|---------|---------|---------|---------|---------|
| ASH-1136 | 83178   |         | ASH-1229  | 83209   | 89414   | ASH-25823 | 83209   | 89414   |         |         |         |
| ASH-1154 | 83177   |         | ASH-25822 | 83209   | 89414   | ASH-25824 | 83122   | 89406   |         |         |         |

**NISSAN**

| O.E.M #     | Gabriel | Upgrade | O.E.M #     | Gabriel | Upgrade | O.E.M #     | Gabriel | Upgrade | O.E.M #     | Gabriel | Upgrade |
|-------------|---------|---------|-------------|---------|---------|-------------|---------|---------|-------------|---------|---------|
| 561000T825  | 83515   |         | 56101-Z5017 | 83162   |         | 56110-Z5008 | 83114   |         | 56210-Z5001 | 85085   |         |
| 56101-30Z01 | 83161   |         | 56110-30Z01 | 83161   |         | 56110-Z5011 | G63610  |         | 66400       | G63432  |         |
| 56101-30Z02 | G63610  |         | 56110-30Z02 | G63610  |         | 56110-Z5014 | 83162   |         | E61000T825  | 83515   |         |
| 56101-Z5008 | 83114   |         | 56110-T8123 | G63432  |         | 56110-Z5017 | 83162   |         |             |         |         |
| 56101-Z5014 | 83162   |         | 56110-T8129 | G63432  |         | 56201-Z5001 | 85085   |         |             |         |         |

**NOVA BUS**

| O.E.M #      | Gabriel | Upgrade | O.E.M #       | Gabriel | Upgrade | O.E.M #      | Gabriel | Upgrade | O.E.M #   | Gabriel | Upgrade |
|--------------|---------|---------|---------------|---------|---------|--------------|---------|---------|-----------|---------|---------|
| 12J-5-10     | 85733   |         | 680323        | 85700   |         | G1011823     | 85710   |         | N16249    | 85378   |         |
| 12J-5-11     | 85313   |         | 680326        | 85700   |         | G1101590     | 85713   |         | N21543    | 85378   |         |
| 22024673     | 85710   |         | 680470        | 85713   |         | G1201338     | 85710   |         | N22212    | 85700   |         |
| 22045526     | 85702   |         | 680480        | 85377   |         | G1201339     | 85702   |         | N31830    | 85378   |         |
| 22052014     | 85702   |         | 680481        | 85378   |         | G1203223     | 85702   |         | N31831    | 85377   |         |
| 481700131250 | 85377   |         | 695393        | 85377   |         | G1205763     | 87019   |         | OE 10086S | 85702   |         |
| 481700131252 | 85378   |         | 97-2201-00151 | 85700   |         | G1205763-001 | 87019   |         |           |         |         |
| 680231       | 85313   |         | 97-9999-02514 | 85700   |         | G5008070     | 85700   |         |           |         |         |
| 680232       | 85733   |         | G1011822      | 85702   |         | N16248       | 85377   |         |           |         |         |

**OLE GRANNING**

| O.E.M # | Gabriel | Upgrade | O.E.M # | Gabriel | Upgrade | O.E.M # | Gabriel | Upgrade | O.E.M # | Gabriel | Upgrade |
|---------|---------|---------|---------|---------|---------|---------|---------|---------|---------|---------|---------|
| 1086    | 83217   |         |         |         |         |         |         |         |         |         |         |

**OPTIMA BUS CORP**

| O.E.M # | Gabriel | Upgrade | O.E.M #     | Gabriel | Upgrade | O.E.M # | Gabriel | Upgrade | O.E.M # | Gabriel | Upgrade |
|---------|---------|---------|-------------|---------|---------|---------|---------|---------|---------|---------|---------|
| 1260008 | 87017   |         | 90-2610-SP1 | 87017   |         |         |         |         |         |         |         |

**Important Note:** Competitive Interchanges are to be used for stocking purposes only. Where multiple crosses are identified, please reference the applications section of this catalog. / **Remarque importante:** Les interchanges concurrentiels ne s'utilisent qu'aux fins de stocks. Dans le cas de références multiples, consulter la section des applications du catalogue. / **Nota importante:** Dans le cas de références multiples, consulter la section des applications du catalogue. / **Nota importante:** Se pueden usar intercambios competitivos para propósitos de almacenamiento solamente. Cuando se identifican intercambios múltiples, consulte la sección aplicaciones de este catálogo.

**COMPETITIVE & O.E.M. INTERCHANGE LIST**  
**Lista de Intercambios contra Competidores y Equipo Original.**  
**Liste d'interchange de produits compétitifs & d'équipement original (OEM)**

**ORION BUS INDUSTRIES**

| O.E.M #     | Gabriel | Upgrade | O.E.M #     | Gabriel | Upgrade | O.E.M #  | Gabriel | Upgrade | O.E.M #       | Gabriel | Upgrade |
|-------------|---------|---------|-------------|---------|---------|----------|---------|---------|---------------|---------|---------|
| 010134501-4 | 85307   |         | 050134508   | 85732   |         | 20117503 | 85720   |         | 695327        | 85732   |         |
| 010134504-4 | 85715   |         | 050134509   | 85732   |         | 20117504 | 85720   |         | 695343        | 85732   |         |
| 010134505-4 | 85715   |         | 050134510   | 85732   |         | 20117505 | 85720   |         | 695347        | 85732   |         |
| 010134506-4 | 85717   |         | 050134513   | 85732   |         | 680091   | 85303   | 89422   | 695366        | 85732   |         |
| 010134508-4 | 85732   |         | 050230501   | 85716   |         | 680102   | 85712   |         | 695389        | 87016   |         |
| 010134509   | 85717   |         | 050231502-4 | 85716   |         | 680271   | 85715   |         | 695420        | 85729   |         |
| 010234503-4 | 85308   | 89422   | 050231505   | 85716   |         | 680274   | 85716   |         | 695421        | 87016   |         |
| 010234506   | 85715   |         | 050231507   | 85716   |         | 680328   | 85717   |         | 695440        | 85729   |         |
| 020117504   | 85720   |         | 060131507   | 87016   |         | 680352   | 85711   |         | 97-9999-02635 | 85732   |         |
| 020273541   | 83203   | 89436   | 060131508   | 87016   |         | 680378   | 85720   |         | 97-9999-02636 | 85716   |         |
| 020273541-4 | 85000   | 89436   | 060231508   | 85717   |         | 680501   | 85715   |         | A-4890        | 85712   |         |
| 020273544   | 83203   | 89436   | 070131502   | 87016   |         | 680502   | 85715   |         | OB020570      | 85711   |         |
| 0501345-11  | 85732   |         | 070131506   | 87016   |         | 680504   | 85716   |         | OB020764      | 85716   |         |
| 050134501-4 | 85716   |         | 070231514   | 85729   |         | 680505   | 85717   |         | OB3166657     | 85700   |         |
| 050134502-4 | 85732   |         | 070231527   | 85729   |         | 680506   | 85732   |         |               |         |         |
| 050134506-4 | 85732   |         | 20117501    | 85720   |         | 690102   | 85711   |         |               |         |         |

**OSHKOSH MOTORS**

| O.E.M #  | Gabriel | Upgrade | O.E.M # | Gabriel | Upgrade | O.E.M # | Gabriel | Upgrade | O.E.M #   | Gabriel | Upgrade |
|----------|---------|---------|---------|---------|---------|---------|---------|---------|-----------|---------|---------|
| 12405F   | 85734   |         | 1745500 |         | 89430   | 40-4951 | 85316   | 89426   | 665060    | 83122   | 89406   |
| 12405F-1 | 85303   | 89422   | 2034140 | 646177  |         | 40-5348 | 85058   | 89431   | 690049    | 85303   | 89422   |
| 12405FX1 | 85303   | 89422   | 2173340 | 85303   | 89422   | 40-6967 | 85030   | 89440   | 90044448  | 85051   |         |
| 1398980  | 83127   |         | 26228-A | 83122   | 89406   | 4036892 | G63605  |         | GBL654875 | 83117   |         |
| 1445910  | 85300   | 89419   | 2JD137  | 83119   |         | 5353054 | 85303   | 89422   | GBL654918 | 83118   |         |
| 1573270  | 83207   | 89407   | 3638112 | G63183  |         | 5361994 | 85734   |         | P117099   | 83120   |         |
| 1573280  | 83221   |         | 40-0242 | 83312   | 89409   | 651444  | 83221   |         | P117146   | 83118   |         |
| 1583470  | 85051   |         | 40-4845 | 85304   |         | 665040  | 85303   | 89422   | RW24285   | 83119   |         |

**OSHKOSH MOTORS CAB SHOCKS**

| O.E.M #   | Gabriel | Upgrade | O.E.M # | Gabriel | Upgrade | O.E.M # | Gabriel | Upgrade | O.E.M # | Gabriel | Upgrade |
|-----------|---------|---------|---------|---------|---------|---------|---------|---------|---------|---------|---------|
| 1202-0054 | 83021   |         | 2218640 | 83009   |         |         |         |         |         |         |         |

**OSTERLUND TRUCK**

| O.E.M #   | Gabriel | Upgrade | O.E.M # | Gabriel | Upgrade | O.E.M # | Gabriel | Upgrade | O.E.M # | Gabriel | Upgrade |
|-----------|---------|---------|---------|---------|---------|---------|---------|---------|---------|---------|---------|
| 220-S5-10 | 85712   |         | 59011   | 83214   |         | 680117  | 85300   | 89419   |         |         |         |

**OTTAWA TRUCK**

| O.E.M #  | Gabriel | Upgrade | O.E.M # | Gabriel | Upgrade | O.E.M #  | Gabriel | Upgrade | O.E.M # | Gabriel | Upgrade |
|----------|---------|---------|---------|---------|---------|----------|---------|---------|---------|---------|---------|
| 53540451 | 85300   | 89419   | 59011   | 83214   |         | 90013787 | 85310   | 89423   | 9007342 | 85303   | 89422   |
| 59009    | 83217   |         | 680117  | 85300   | 89419   | 90027577 | 85720   |         |         |         |         |

**PACCAR**

| O.E.M # | Gabriel | Upgrade | O.E.M # | Gabriel | Upgrade | O.E.M # | Gabriel | Upgrade | O.E.M # | Gabriel | Upgrade |
|---------|---------|---------|---------|---------|---------|---------|---------|---------|---------|---------|---------|
| 665633  | 85033   | 89427   |         |         |         |         |         |         |         |         |         |

**PACIFIC TRUCK & TRAILER**

| O.E.M #  | Gabriel | Upgrade | O.E.M #  | Gabriel | Upgrade | O.E.M # | Gabriel | Upgrade | O.E.M # | Gabriel | Upgrade |
|----------|---------|---------|----------|---------|---------|---------|---------|---------|---------|---------|---------|
| 3178157C | 85735   |         | 507202C1 | 85030   | 89440   |         |         |         |         |         |         |

**PAGE SUSPENSION**

| O.E.M # | Gabriel | Upgrade | O.E.M # | Gabriel | Upgrade | O.E.M # | Gabriel | Upgrade | O.E.M # | Gabriel | Upgrade |
|---------|---------|---------|---------|---------|---------|---------|---------|---------|---------|---------|---------|
| 1080099 | 83203   | 89436   | 665133  | 83203   | 89436   | A-2212  | 85029   |         |         |         |         |
| 1081933 | 83204   |         | 665267  | 85029   |         |         |         |         |         |         |         |

**PAI CORP**

| O.E.M #  | Gabriel | Upgrade | O.E.M #  | Gabriel | Upgrade | O.E.M #  | Gabriel | Upgrade | O.E.M # | Gabriel | Upgrade |
|----------|---------|---------|----------|---------|---------|----------|---------|---------|---------|---------|---------|
| HSA-5067 | 85305   |         | HSA-5080 | 83221   |         | HSA-5095 | 83215   |         |         |         |         |

**PEERLESS TRAILER**

| O.E.M # | Gabriel | Upgrade | O.E.M # | Gabriel | Upgrade | O.E.M # | Gabriel | Upgrade | O.E.M # | Gabriel | Upgrade |
|---------|---------|---------|---------|---------|---------|---------|---------|---------|---------|---------|---------|
| 120-1   | 83125   |         | 72-61   | 83125   |         |         |         |         |         |         |         |

**PETERBILT**

| O.E.M #  | Gabriel | Upgrade | O.E.M #  | Gabriel | Upgrade | O.E.M #  | Gabriel | Upgrade | O.E.M # | Gabriel | Upgrade |
|----------|---------|---------|----------|---------|---------|----------|---------|---------|---------|---------|---------|
| 02-00376 | 85302   | 89420   | 02-01787 | 85062   | 89408   | 02-02142 | 85036   | 89405   |         |         |         |
| 02-00495 | 85302   | 89420   | 02-01890 | 85012   | 89413   | 02-02225 | 85012   | 89413   |         |         |         |
| 02-01759 | 83312   | 89409   | 02-02061 | 85013   | 89414   |          |         |         |         |         |         |

**Important Note:** Competitive Interchanges are to be used for stocking purposes only. Where multiple crosses are identified, please reference the applications section of this catalog. / **Remarque importante:** Les interchanges concurrentiels ne s'utilisent qu'aux fins de stocks. Dans le cas de références multiples, consulter la section des applications du catalogue. / **Nota importante:** Dans le cas de références multiples, consulter la section des applications du catalogue. / **Nota importante:** Se pueden usar intercambios competitivos para propósitos de almacenamiento solamente. Cuando se identifican intercambios múltiples, consulte la sección de aplicaciones de este catálogo.

**COMPETITIVE & O.E.M. INTERCHANGE LIST**  
**Lista de Intercambios contra Competidores y Equipo Original.**  
**Liste d'interchange de produits compétitifs & d'équipement original (OEM)**

**PETERBILT... cont'd**

| O.E.M #          | Gabriel | Upgrade | O.E.M #       | Gabriel | Upgrade | O.E.M #      | Gabriel | Upgrade | O.E.M #      | Gabriel | Upgrade |
|------------------|---------|---------|---------------|---------|---------|--------------|---------|---------|--------------|---------|---------|
| 02-02736         | 85302   | 89420   | 23-10393      | 85308   | 89422   | 665945       | 85902   |         | B71-1001     | 85070   | 89459   |
| 02-02736PLUS     | 85302   | 89420   | 23-12262      | 85012   | 89413   | 665950       | 85902   |         | B71-1002     | 85001   | 89410   |
| 02-02737         | 85062   | 89408   | 471700004423  | 85109   |         | 671052       | 85070   | 89459   | B71-1003     | 83312   | 89409   |
| 02-02737PLUS     | 85062   | 89408   | 47902-13PLUS  | 83122   | 89406   | 671091       | 85069   | 89455   | B71-6000     | 85959   |         |
| 02-02738         | 85012   | 89413   | 60670-005PLUS | 83137   |         | 671092       | 85012   | 89413   | B71-6002     | 85012   | 89413   |
| 02-02738PLUS     | 85012   | 89413   | 60670-008     | 83123   | 89405   | 671654       | 85936   | 89456   | B71-6003     | 85029   |         |
| 02-02739         | 85013   | 89414   | 60670-008L    | 83123   | 89405   | 671699       | 85937   |         | B71-6004     | 85084   | 89460   |
| 02-02739PLUS     | 85013   | 89414   | 60670-008PLUS | 83123   | 89405   | 671794       | 85067   | 89451   | B71-6005     | 85084   | 89460   |
| 02-02740         | 85036   | 89405   | 60680-003     | 83112   |         | 671962PLUS   | 85936   | 89456   | B71-6006     | 85084   | 89460   |
| 02-02741         | 85012   | 89413   | 60680-003L    | 83112   |         | 671962SPL    | 85936   | 89456   | B71-6007     | 85062   | 89408   |
| 02-02742         | 85062   | 89408   | 60680-004     | 83143   |         | 671963       | 85937   |         | B71-6008     | 83312   | 89409   |
| 02-03020         | 85910   |         | 60680-004L    | 83143   |         | 680026       | 85302   | 89420   | B71-6009     | 83219   | 89408   |
| 02-04010         | 85012   | 89413   | 60680-005     | 83142   |         | 680027       | 85308   | 89422   | B71-6009     | 85062   | 89408   |
| 03-01635         | 85308   | 89422   | 60680-005L    | 83142   |         | 680185       | 85308   | 89422   | B71-6010     | 85023   | 89415   |
| 03-04176         | 85308   | 89422   | 665133        | 83203   | 89436   | 680237       | 85303   | 89422   | B71-6011     | 85062   | 89408   |
| 03-04176PLUS     | 85308   | 89422   | 665174        | 85060   |         | 680239       | 85310   | 89423   | B71-6012     | 85119   |         |
| 03-04628         | 85336   |         | 665565PLUS    | 85007   | 89412   | 680240       | 85302   | 89420   | B71-6013     | 85012   | 89413   |
| 03-04629         | 85311   | 89424   | 665617        | 85031   |         | 680241       | 85311   | 89424   | B71-6015     | 85012   | 89413   |
| 03-05106         | 85033   | 89427   | 665632        | 85013   | 89414   | 680242       | 85308   | 89422   | B71-6016     | 85012   | 89413   |
| 03-05384         | 85033   | 89427   | 665633        | 85033   | 89427   | 680253       | 85314   | 89425   | B71-6016A    | 85012   | 89413   |
| 03-06084         | 85033   | 89427   | 665655        | 85062   | 89408   | 680261       | 85062   | 89408   | B71-6017     | 85910   |         |
| 03-06084PLUS     | 85033   | 89427   | 665656        | 85012   | 89413   | 680279       | 83209   | 89414   | B71-6018     | 85012   | 89413   |
| 03-07281         | 85311   | 89424   | 665657        | 85013   | 89414   | 680280       | 85906   | 89407   | B71-6019     | 85989   |         |
| 03-07420         | 85336   |         | 665658        | 85036   | 89405   | 680281       | 85003   | 89411   | B71-6020     | 85989   |         |
| 03-07421         | 85311   | 89424   | 665660        | 85033   | 89427   | 680303       | 85007   | 89412   | BFRG072      | 85182   |         |
| 03-07421PLUS     | 85311   | 89424   | 665662        | 85012   | 89413   | 680348       | 85012   | 89413   | C71-1002     | 85067   | 89451   |
| 03-07421SPL      | 85311   | 89424   | 665738        | 85910   |         | 680425       | 85320   | 89429   | C71-1002PLUS | 85067   | 89451   |
| 03-07423         | 85033   | 89427   | 665752        | 85067   | 89451   | 680435       | 85033   | 89427   | C71-1011     | 85069   | 89455   |
| 03-07423PLUS     | 85033   | 89427   | 665762        | 85012   | 89413   | 680457       | 85302   | 89420   | C71-1011PLUS | 85069   | 89455   |
| 03-07424         | 85311   | 89424   | 665783        | 83123   | 89405   | 680458       | 85336   |         | C71-1011SPL  | 85069   | 89455   |
| 03-07424PLUS     | 85311   | 89424   | 665784        | 83122   | 89406   | 680459       | 85311   | 89424   | C71-1013     | 85985   |         |
| 03-08350         | 85343   |         | 665785        | 83137   |         | 680473       | 85319   | 89428   | C71-1014     | 85936   | 89456   |
| 03-08781         | 85069   | 89455   | 665788        | 85000   | 89436   | 680586       | 85311   | 89424   | C71-1016     | 85067   | 89451   |
| 10-12032-002PLUS | 85320   | 89429   | 665826        | 85069   | 89455   | 70701PLUS    | 85900   |         | C71-1017     | 85069   | 89455   |
| 10-12542-000PLUS | 85901   |         | 665844        | 85069   | 89455   | 800670       | 85060   |         | C71-6000     | 85067   | 89451   |
| 12887-01         | 85013   | 89414   | 665858        | 85070   | 89459   | 8086053PLUS  | 85047   | 89435   | C71-6002     | 85311   | 89424   |
| 12887-02         | 85013   | 89414   | 665876        | 85959   |         | 85013A0C     | 85013   | 89414   | C71-6003     | 85988   |         |
| 16-13947-000PLUS | 85319   | 89428   | 665918        | 85900   |         | 90044011     | 85004   |         | C71-6004     | 85343   |         |
| 16725-01         | 83126   |         | 665926        | 85047   | 89435   | 90044025PLUS | 83209   | 89414   | C71-6005     | 85069   | 89455   |
| 1707378PAC       | 85182   |         | 665927        | 85901   |         | 90044089PLUS | 83124   | 89407   | C71-6015     | 85067   | 89451   |
| 19495-01         | 83126   |         | 665928        | 85062   | 89408   | 90045132     | 85909   |         | K374-26PLUS  | 85001   | 89410   |
| 19495-01         | 83126   | 89440   | 665930        | 85001   | 89410   | 90045605     | 85109   |         | K374-28PLUS  | 85314   | 89425   |
| 2018987C1PLUS    | 85003   | 89411   | 665931        | 83312   | 89409   | ACHB966      | 83136   |         | K374-29PLUS  | 85310   | 89423   |
| 23-08233         | 85308   | 89422   | 665932        | 85012   | 89413   | B71-1000     | 85031   |         | K374-33PLUS  | 83312   | 89409   |

**PETERBILT CAB SHOCKS**

| O.E.M #   | Gabriel | Upgrade | O.E.M #  | Gabriel | Upgrade | O.E.M #    | Gabriel | Upgrade | O.E.M #  | Gabriel | Upgrade |
|-----------|---------|---------|----------|---------|---------|------------|---------|---------|----------|---------|---------|
| 1201-0012 | 83023   |         | 20-16755 | 83042   |         | 654919     | 83035   |         | R71-6005 | 83042   |         |
| 1201-8002 | 83081   |         | 20-19140 | 83063   |         | 96027-1054 | 83011   |         | R71-6006 | 83063   |         |
| 1201-8006 | 83081   |         | 25523024 | 83081   |         | PP1058870  | 83059   |         | R71-6007 | 83008   |         |
| 1202-0012 | 83023   |         | 29-02455 | 83008   |         | PP1059870  | 83060   |         | R71-6008 | 83035   |         |
| 1202-0032 | 83016   |         | 29-06005 | 83035   |         | PP2582870  | 83012   |         | R71-6009 | 83081   |         |
| 1202-0054 | 83021   |         | 29-06032 | 83035   |         | R71-1004   | 83049   |         | R71-6010 | 83067   |         |
| 1202-1044 | 83025   |         | 654782   | 83008   |         | R71-1005   | 83024   |         |          |         |         |
| 1202P055  | 83061   |         | 654812   | 83042   |         | R71-6000   | 83067   |         |          |         |         |

**Important Note:** Competitive Interchanges are to be used for stocking purposes only. Where multiple crosses are identified, please reference the applications section of this catalog. / **Remarque importante:** Les interchanges concurrentiels ne s'utilisent qu'aux fins de stocks. Dans le cas de références multiples, consulter la section des applications du catalogue. / **Nota importante:** Dans le cas de références multiples, consulter la section des applications du catalogue. / **Nota importante:** Se pueden usar intercambios competitivos para propósitos de almacenamiento solamente. Cuando se identifican intercambios múltiples, consulte la sección de aplicaciones de este catálogo.

# COMPETITIVE & O.E.M. INTERCHANGE LIST

## Lista de Intercambios contra Competidores y Equipo Original.

### Liste d'interchange de produits compétitifs & d'équipement original (OEM)

#### PHOENIX CRUISER RV

| O.E.M #  | Gabriel | Upgrade | O.E.M #  | Gabriel | Upgrade | O.E.M # | Gabriel | Upgrade | O.E.M # | Gabriel | Upgrade |
|----------|---------|---------|----------|---------|---------|---------|---------|---------|---------|---------|---------|
| ASH-1136 | 83178   |         | ASH-1154 | 83177   |         |         |         |         |         |         |         |

#### PIERCE MANUFACTURING INC.

| O.E.M # | Gabriel | Upgrade | O.E.M # | Gabriel | Upgrade | O.E.M # | Gabriel | Upgrade | O.E.M # | Gabriel | Upgrade |
|---------|---------|---------|---------|---------|---------|---------|---------|---------|---------|---------|---------|
| 1445910 | 85300   | 89419   | 40-0242 | 83312   | 89409   | 40-4951 | 85316   | 89426   | 40-6967 | 85030   | 89440   |
| 2034140 | 646177  |         | 40-4845 | 85304   |         | 40-5348 | 85058   | 89431   | 680401  | 85307   |         |

#### POWERHOUSE COACH INC.

| O.E.M #      | Gabriel | Upgrade | O.E.M #  | Gabriel | Upgrade | O.E.M #      | Gabriel | Upgrade | O.E.M #    | Gabriel | Upgrade |
|--------------|---------|---------|----------|---------|---------|--------------|---------|---------|------------|---------|---------|
| 141700005838 | 85098   |         | 20551628 | 85066   | 89448   | 471700000443 | 85066   | 89448   | 64838-003L | 85933   | 89454   |
| 20433424     | 85061   | 89450   | 21137330 | 85933   | 89454   | 471700003832 | 85933   | 89454   |            |         |         |
| 20485632     | 85933   | 89454   | 21436086 | 85098   |         | 471700006040 | 85088   |         |            |         |         |
| 20485633     | 85933   | 89454   | 21462380 | 85088   |         | 64838-003    | 85933   | 89454   |            |         |         |

#### POWERPACKER CAB SHOCKS

| O.E.M #   | Gabriel | Upgrade | O.E.M #   | Gabriel | Upgrade | O.E.M # | Gabriel | Upgrade | O.E.M # | Gabriel | Upgrade |
|-----------|---------|---------|-----------|---------|---------|---------|---------|---------|---------|---------|---------|
| PP1058870 | 83059   |         | PP1059870 | 83060   |         |         |         |         |         |         |         |

#### PREVOST

| O.E.M #     | Gabriel | Upgrade | O.E.M #      | Gabriel | Upgrade | O.E.M # | Gabriel | Upgrade | O.E.M #  | Gabriel | Upgrade |
|-------------|---------|---------|--------------|---------|---------|---------|---------|---------|----------|---------|---------|
| 01-0100-905 | 85303   | 89422   | 481700000206 | 85380   |         | 630127  | 85736   |         | 680323   | 85700   |         |
| 0822045526  | 85702   |         | 481700000207 | 85329   |         | 630134  | 85329   |         | 680422   | 85329   |         |
| 12B-5-1     | 85735   |         | 481700000208 | 85379   |         | 630136  | 85330   |         | 680492   | 85713   |         |
| 12L-5-89    | 85729   |         | 481700000209 | 85713   |         | 630161  | 85736   |         | 680510   | 85330   |         |
| 12T-1-13    | 85303   | 89422   | 481700999376 | 85329   |         | 630163  | 85330   |         | 680555   | 85330   |         |
| 19501288    | 85729   |         | 481700999377 | 85330   |         | 630228  | 85380   |         | 680583   | 85380   |         |
| 19501289    | 85728   |         | 481700999386 | 85736   |         | 630234  | 85329   |         | 690060   | 85713   |         |
| 19501547    | 85740   |         | 481700999427 | 85380   |         | 630235  | 85330   |         | 74939852 | 85308   | 89422   |
| 19501669    | 85339   |         | 52001        | 85708   |         | 630236  | 85329   |         | G1011822 | 85702   |         |
| 19502711    | 85702   |         | 63-1013      | 85329   |         | 630251  | 85379   |         | G5008070 | 85700   |         |
| 19506846    | 85339   |         | 630001       | 85713   |         | 630252  | 85329   |         | N16249   | 85378   |         |
| 196347      | 85710   |         | 630080       | 85713   |         | 630253  | 85713   |         | N22212   | 85700   |         |
| 196533      | 85708   |         | 630091       | 85736   |         | 630254  | 85380   |         |          |         |         |
| 3166657     | 85700   |         | 630103       | 85329   |         | 650407  | 85736   |         |          |         |         |

#### RAMERIZ TRAILER

| O.E.M #  | Gabriel | Upgrade | O.E.M # | Gabriel | Upgrade | O.E.M # | Gabriel | Upgrade | O.E.M # | Gabriel | Upgrade |
|----------|---------|---------|---------|---------|---------|---------|---------|---------|---------|---------|---------|
| 18165-01 | 85006   |         |         |         |         |         |         |         |         |         |         |

#### RAYDAN MANUFACTURING

| O.E.M #   | Gabriel | Upgrade | O.E.M #    | Gabriel | Upgrade | O.E.M # | Gabriel | Upgrade | O.E.M # | Gabriel | Upgrade |
|-----------|---------|---------|------------|---------|---------|---------|---------|---------|---------|---------|---------|
| 14QK-3100 | 85739   |         | 446-51-211 | 85739   |         | 700115  | 85712   |         |         |         |         |

#### RED LION TRAILER

| O.E.M #  | Gabriel | Upgrade | O.E.M # | Gabriel | Upgrade | O.E.M # | Gabriel | Upgrade | O.E.M # | Gabriel | Upgrade |
|----------|---------|---------|---------|---------|---------|---------|---------|---------|---------|---------|---------|
| 90044978 | 85059   |         |         |         |         |         |         |         |         |         |         |

#### RENEGADE RV

| O.E.M #      | Gabriel | Upgrade | O.E.M #  | Gabriel | Upgrade | O.E.M #      | Gabriel | Upgrade | O.E.M #         | Gabriel | Upgrade |
|--------------|---------|---------|----------|---------|---------|--------------|---------|---------|-----------------|---------|---------|
| 10-13760-000 | 85959   | 89503   | 20433424 | 85061   | 89450   | 471700000443 | 85066   | 89448   | SDA471400003920 | 85958   |         |
| 10-13809-000 | 85958   |         | 20551628 | 85066   | 89448   | 471700002991 | 85959   | 89503   | SDA471700002809 | 85724   | 89443   |
| 141700005838 | 85098   |         | 21436086 | 85098   |         | 471700003920 | 85958   |         | SDA471700002991 | 85959   | 89503   |
| 16-18708-000 | 85724   | 89443   | 21462380 | 85088   |         | 471700006040 | 85088   |         |                 |         |         |

#### REX MIXER

| O.E.M #      | Gabriel | Upgrade | O.E.M # | Gabriel | Upgrade | O.E.M # | Gabriel | Upgrade | O.E.M # | Gabriel | Upgrade |
|--------------|---------|---------|---------|---------|---------|---------|---------|---------|---------|---------|---------|
| 102-13441-10 | 646155  |         |         |         |         |         |         |         |         |         |         |

#### REYCO SUSPENSION

| O.E.M #  | Gabriel | Upgrade | O.E.M #  | Gabriel | Upgrade | O.E.M #  | Gabriel | Upgrade | O.E.M #  | Gabriel | Upgrade |
|----------|---------|---------|----------|---------|---------|----------|---------|---------|----------|---------|---------|
| 12885-01 | 85300   | 89419   | 16230-01 | 85702   |         | 17403-01 | 83122   | 89406   | 18165-01 | 85006   |         |
| 12885-03 | 85300   | 89419   | 16725-01 | 83126   |         | 17408-01 | 85005   | 89430   | 18166-01 | 85704   |         |
| 12886-01 | 85334   |         | 16824-01 | 85006   |         | 17794-01 | 83215   |         | 18286-01 |         | 89414   |
| 12887-01 | 85013   | 89414   | 17142-01 | 85001   | 89410   | 18146-01 | 85313   |         | 18800-01 | 83203   | 89436   |
| 12887-02 | 85013   | 89414   | 17146-01 | 83209   | 89414   | 18163-01 | 83207   | 89407   | 19495-01 | 83126   |         |
| 14954-01 | 83217   |         | 17358-01 | 83126   | 89430   | 18164-01 | 83122   | 89406   | 19495-01 | 83126   | 89440   |

**Important Note:** Competitive Interchanges are to be used for stocking purposes only. Where multiple crosses are identified, please reference the applications section of this catalog. / **Remarque importante:** Les interchanges concurrentiels ne s'utilisent qu'aux fins de stocks. Dans le cas de références multiples, consulter la section des applications du catalogue. / **Nota importante:** Dans le cas de références multiples, consulter la section des applications du catalogue. / **Nota importante:** Se pueden usar intercambios competitivos para propósitos de almacenamiento solamente. Cuando se identifican intercambios múltiples, consulte la sección de aplicaciones de este catálogo.

**COMPETITIVE & O.E.M. INTERCHANGE LIST**  
**Lista de Intercambios contra Competidores y Equipo Original.**  
**Liste d'interchange de produits compétitifs & d'équipement original (OEM)**

**REYCO SUSPENSION... cont'd**

| O.E.M #  | Gabriel | Upgrade | O.E.M #  | Gabriel | Upgrade | O.E.M # | Gabriel | Upgrade | O.E.M #   | Gabriel | Upgrade |
|----------|---------|---------|----------|---------|---------|---------|---------|---------|-----------|---------|---------|
| 19623-01 | 83123   | 89405   | 22062-01 | 85007   | 89412   | 665748  | 85086   |         | 700098-01 | 83128   | 89436   |
| 19824-01 | 85006   |         | 23106-01 | 85975   |         | 665813  | 85051   |         | 700098-03 | 85052   |         |
| 20125-01 | 85030   | 89440   | 23523-01 | 85086   |         | 665830  | 85045   |         | 701071-01 | 665937  |         |
| 20126-01 |         | 89440   | 23524-01 | 85738   |         | 665833  | 85052   |         | 702135-01 | 85045   |         |
| 20129-01 | 85007   | 89412   | 23553-01 | 85938   |         | 671707  | 85323   | 89436   | 702136-01 | 85052   |         |
| 20960-01 | 83204   |         | 23614-01 | 85717   |         | 680551  | 85738   |         | 702209-01 | 85014   |         |
| 21310-01 | 85307   |         | 24392-01 | 85051   |         | 680552  | 85938   |         | 704672-01 | 85938   |         |
| 21497-01 | 85005   | 89430   | 665519   |         | 89414   | 680700  | 85938   |         |           |         |         |

**RIDEWELL CORPORATION**

| O.E.M #     | Gabriel | Upgrade | O.E.M #     | Gabriel | Upgrade | O.E.M #     | Gabriel | Upgrade | O.E.M #   | Gabriel | Upgrade |
|-------------|---------|---------|-------------|---------|---------|-------------|---------|---------|-----------|---------|---------|
| 1250005     | 85901   |         | 1267249B000 | 85712   |         | 665267      | 85029   |         | AS789B000 | 85014   |         |
| 1250546B000 | 85006   |         | 1267395B000 | 85302   | 89420   | 665526      | 85014   |         | S2607B    | 85702   |         |
| 1250563B000 | 85000   | 89436   | 1270007     | 85045   |         | 680101      | 85702   |         | S4025B    | 85712   |         |
| 1250789B000 | 85014   |         | 1270563B000 | 85000   | 89436   | 70654       | 85000   | 89436   | S5477B    | 85307   |         |
| 1252607B000 | 85702   |         | 1270563B003 | 85934   |         | 90-1813     | 85712   |         | S5478B    | 85307   |         |
| 1253069B000 | 85005   | 89430   | 1270789B000 | 85014   |         | 90-2610 SP1 | 87017   |         | S5813B    | 85704   |         |
| 1254025B000 | 85712   |         | 1275813B000 | 85704   |         | AS 4025B    | 85712   |         | S5878B    | 83207   | 89407   |
| 1254190B000 | 85302   | 89420   | 1275943B    | 85005   | 89430   | AS30698     | 85005   | 89430   | S6009B    | 83203   | 89436   |
| 1260008     | 87017   |         | 1310002     | 665937  |         | AS3069B     | 85005   | 89430   | S7120B    | 85304   |         |
| 1265157B000 | 85712   |         | 1310004     | 665937  |         | AS546B      | 85006   |         | S7172B    | 83207   | 89407   |
| 1265478B000 | 85736   |         | 1317570B001 | 646155  |         | AS563B      | 83203   | 89436   | S7249B    | 85307   |         |
| 1266009B000 | 83130   |         | 57645       | 85005   | 89430   | AS575B      | 85005   | 89430   | S7365B    | 85305   |         |
| 1267120B000 | 85734   |         | 665198      | 85005   | 89430   | AS789B      | 85014   |         |           |         |         |

**ROADMASTER (MONACO)**

| O.E.M #  | Gabriel | Upgrade | O.E.M #  | Gabriel | Upgrade | O.E.M # | Gabriel | Upgrade | O.E.M # | Gabriel | Upgrade |
|----------|---------|---------|----------|---------|---------|---------|---------|---------|---------|---------|---------|
| 90045132 | 85909   |         | 90045188 | 85910   |         |         |         |         |         |         |         |

**SABO**

| Sabo    | Gabriel | Upgrade | Sabo    | Gabriel | Upgrade | Sabo    | Gabriel | Upgrade | Sabo    | Gabriel | Upgrade |
|---------|---------|---------|---------|---------|---------|---------|---------|---------|---------|---------|---------|
| 690459  | 86203   |         | 8901026 | 85064   |         | 8901032 | 85901   |         | 890165B | 85121   |         |
| 8901020 | 85300   |         | 8901027 | 85310   |         | 8901033 | 85918   |         | 890414  | 85323   |         |
| 8901021 | 85320   |         | 8901028 | 85316   |         | 8901037 | 86202   |         | 890449  | 85300   |         |
| 8901023 | 85066   | 89448   | 8901029 | 85319   |         | 8901038 | 86201   |         | 890612  | 86202   |         |
| 8901024 | 85314   |         | 8901029 | 85724   | 89443   | 8901156 | G63299  |         | 895315  | 83009   |         |
| 8901025 | 83128   | 89436   | 8901030 | 85323   | 89436   | 890120  | 85300   |         | 895316  | 83002   |         |
| 8901025 | 85000   | 89436   | 8901031 | 85900   |         | 890164B | 85179   |         |         |         |         |

**SACHS**

| Sachs        | Gabriel | Upgrade | Sachs        | Gabriel | Upgrade | Sachs  | Gabriel | Upgrade | Sachs  | Gabriel | Upgrade |
|--------------|---------|---------|--------------|---------|---------|--------|---------|---------|--------|---------|---------|
| 101892       | 85708   |         | 141700131809 | 85029   |         | 313708 | 85378   |         | 315414 | 85959   |         |
| 101968       | 85708   |         | 141700131810 | 83160   |         | 313709 | 85377   |         | 315415 | 85933   | 89454   |
| 106282       | 85722   |         | 141700131975 | 83160   |         | 315389 | 85090   |         | 315416 | 85003   | 89411   |
| 106884       | 85708   |         | 170210       | 83104   |         | 315390 | 85918   | 89449   | 315417 | 85923   |         |
| 106885       | 85722   |         | 170211       | 83104   |         | 315391 | 85956   |         | 315418 | 83456   | 89447   |
| 112885       | 85709   |         | 280499       | 85300   | 89419   | 315392 | 85007   | 89412   | 315420 | 85014   |         |
| 124693       | 85708   |         | 290146       | 85012   | 89413   | 315393 | 85331   |         | 315421 | 85088   |         |
| 141700000373 | 85061   | 89450   | 290460       | 85005   | 89430   | 315394 | 85921   |         | 315423 | 83127   |         |
| 141700000377 | 83174   |         | 290465       | 83125   |         | 315395 | 85724   | 89443   | 315424 | 85067   | 89451   |
| 141700000378 | 83160   |         | 290488       | 85040   |         | 315396 | 85335   |         | 315425 | 85330   |         |
| 141700000380 | 85061   | 89450   | 311229       | 85918   | 89449   | 315397 | 83120   |         | 315426 | 85329   |         |
| 141700000443 | 85066   | 89448   | 311230       | 85956   |         | 315398 | 85058   | 89431   | 315427 | 85713   |         |
| 141700000800 | 85179   |         | 311631       | 85906   | 89407   | 315399 | 85005   | 89430   | 315428 | 85380   |         |
| 141700000901 | 83165   |         | 311632       | 85909   |         | 315400 | 85006   |         | 315430 | 85099   |         |
| 141700002626 | 85061   | 89450   | 311633       | 85900   |         | 315401 | 85331   |         | 315431 | 85014   |         |
| 141700005838 | 85098   |         | 311634       | 85001   | 89410   | 315402 | 85900   |         | 315432 | 89414   |         |
| 141700005839 | 85098   |         | 311635       | 85030   | 89440   | 315403 | 85919   |         |        |         |         |
| 141700125243 | 85089   |         | 311793       | 85975   |         | 315404 | 85900   |         |        |         |         |
| 141700125275 | 83165   |         | 311794       | 85974   |         | 315406 | 85918   | 89449   |        |         |         |
| 141700125757 | 85089   |         | 312724       | 85311   |         | 315411 | 83128   |         |        |         |         |

**Important Note:** Competitive Interchanges are to be used for stocking purposes only. Where multiple crosses are identified, please reference the applications section of this catalog. / **Remarque importante:** Les interchanges concurrentiels ne s'utilisent qu'aux fins de stocks. Dans le cas de références multiples, consulter la section des applications du catalogue. / **Nota importante:** Dans le cas de références multiples, consulter la section des applications du catalogue. / **Nota importante:** Se pueden usar intercambios competitivos para propósitos de almacenamiento solamente. Cuando se identifican intercambios múltiples, consulte la sección de aplicaciones de este catálogo.

**COMPETITIVE & O.E.M. INTERCHANGE LIST**  
**Lista de Intercambios contra Competidores y Equipo Original.**  
**Liste d'interchange de produits compétitifs & d'équipement original (OEM)**

**SACHS... cont'd**

| Sachs  | Gabriel | Upgrade | Sachs        | Gabriel | Upgrade | Sachs        | Gabriel | Upgrade | Sachs        | Gabriel | Upgrade |
|--------|---------|---------|--------------|---------|---------|--------------|---------|---------|--------------|---------|---------|
| 315434 | 85065   |         | 315658       | 83057   |         | 471700000451 | 85080   |         | 481700000207 | 85329   |         |
| 315435 | 85088   |         | 315659       | 83047   |         | 471700000458 | 85014   |         | 481700000208 | 85379   |         |
| 315540 | 83613   |         | 315660       | 83009   |         | 471700000459 | 85030   | 89440   | 481700000209 | 85713   |         |
| 315541 | 85052   |         | 315661       | 85932   | 89453   | 471700000460 | 85097   |         | 481700000477 | 85900   |         |
| 315542 | 83122   | 89406   | 40-A85-0     | 85708   |         | 471700000461 | 89414   |         | 481700000483 | 85975   |         |
| 315543 | 83125   |         | 410010       | 83317   |         | 471700000464 | 85090   |         | 481700000484 | 85974   |         |
| 315544 | 85014   |         | 410011       | 83173   |         | 471700000466 | 85959   |         | 481700000485 | 85975   |         |
| 315545 | 85333   |         | 410011       | 85093   |         | 471700000470 | 85918   | 89449   | 481700000493 | 85900   |         |
| 315546 | 85005   | 89430   | 410021       | 83125   |         | 471700000802 | 85121   |         | 481700004271 | 85993   |         |
| 315547 | 85924   | 89457   | 410022       | 85006   |         | 471700002580 | 83165   |         | 481700004476 | 85982   |         |
| 315548 | 85070   | 89459   | 410023       | 85103   |         | 471700002627 | 85066   | 89448   | 481700005414 | 85179   |         |
| 315549 | 85033   | 89427   | 410024       | 85302   | 89420   | 471700002726 | 85918   | 89449   | 481700008558 | 85347   |         |
| 315550 | 85311   | 89424   | 410025       | 83215   |         | 471700002727 | 85959   |         | 481700008666 | 87020   |         |
| 315551 | 85310   | 89423   | 410026       | 85918   | 89449   | 471700002809 | 85724   | 89443   | 481700125969 | 85956   |         |
| 315552 | 83128   |         | 410032       | 85320   | 89429   | 471700002861 | 85014   |         | 481700131250 | 85377   |         |
| 315553 | 85900   |         | 410035       | 85001   | 89410   | 471700002919 | 85106   |         | 481700131252 | 85378   |         |
| 315554 | 85006   |         | 410035       | 85337   |         | 471700002990 | 85007   | 89412   | 481700131438 | 85919   |         |
| 315555 | 83038   |         | 410036       | 85061   | 89450   | 471700002991 | 85959   |         | 481700131919 | 85900   |         |
| 315556 | 85314   | 89425   | 410037       | 85081   |         | 471700002992 | 85331   |         | 481700999376 | 85329   |         |
| 315593 | 85029   |         | 410038       | 85100   |         | 471700002993 | 85921   |         | 481700999377 | 85330   |         |
| 315594 | 85029   |         | 410040       | 85005   | 89430   | 471700002994 | 83134   |         | 481700999386 | 85376   |         |
| 315597 | 85959   |         | 410042       | 85310   | 89423   | 471700002995 | 83134   |         | 481700999427 | 85380   |         |
| 315598 | 85933   | 89454   | 410043       | 85957   |         | 471700002996 | 85335   |         | 510001       | 85716   |         |
| 315599 | 85109   |         | 410044       | 85031   |         | 471700003009 | 85006   |         | 510002       | 85302   | 89420   |
| 315600 | 85959   |         | 410046       | 83136   |         | 471700003011 | 85058   |         | 510002       | 85983   |         |
| 315601 | 85920   |         | 410047       | 85071   |         | 471700003832 | 85933   | 89454   | 510003       | 85004   |         |
| 315602 | 85092   |         | 410048       | 83207   |         | 471700003920 | 85958   |         | 510004       | 85307   |         |
| 315603 | 83134   |         | 410048       | 83304   |         | 471700004270 | 85117   |         | 510005       | 85303   |         |
| 315606 | 85061   | 89450   | 410048       | 85014   |         | 471700004423 | 85109   |         | 510006       | 85705   |         |
| 315607 | 85061   | 89450   | 410050       | 85121   |         | 471700005079 | 85005   | 89430   | 510006       | 85706   |         |
| 315608 | 85066   | 89448   | 410051       | 85108   |         | 471700006039 | 85088   |         | 510009       | 85711   |         |
| 315609 | 85066   | 89448   | 410052       | 85096   |         | 471700006040 | 85088   |         | 510011       | 87020   |         |
| 315610 | 83026   |         | 410053       | 85095   |         | 471700006048 | 83165   |         | 510014       | 85352   |         |
| 315611 | 85337   |         | 410056       | 85000   | 89436   | 471700006269 | 85932   | 89453   | 510017       | 85323   | 89436   |
| 315612 | 85006   |         | 410057       | 85013   |         | 471700009646 | 85088   |         | 510018       | 85724   | 89443   |
| 315613 | 85030   | 89440   | 410058       | 83122   |         | 471700009647 | 85088   |         | 510019       | 85916   |         |
| 315614 | 85097   |         | 410068       | 85030   | 89440   | 471700011530 | 85181   |         | 510023       | 85316   | 89426   |
| 315615 | 83027   |         | 410068       | 85054   |         | 471700011531 | 85180   |         | 510024       | 85381   |         |
| 315616 | 83038   |         | 410069       | 83165   |         | 471700125245 | 85089   |         | 510039       | 85982   |         |
| 315617 | 85918   | 89449   | 410069       | 85094   |         | 471700131155 | 85918   | 89449   | 510040       | 85110   |         |
| 315618 | 83160   |         | 410070       | 85089   |         | 471700131256 | 85065   |         | 814903003482 | 83040   |         |
| 315619 | 83160   |         | 471700000426 | 85014   |         | 471700131258 | 85081   |         | 814903003483 | 83039   |         |
| 315620 | 85080   |         | 471700000428 | 85006   |         | 471700131331 | 85932   | 89453   | 814903003484 | 83057   |         |
| 315621 | 85080   |         | 471700000431 | 85066   | 89448   | 471700131545 | 85006   |         | 814903003486 | 83047   |         |
| 315622 | 85081   |         | 471700000433 | 85099   |         | 471700131646 | 85918   | 89449   | 814903003496 | 83009   |         |
| 315623 | 85918   | 89449   | 471700000436 | 85030   | 89440   | 471700131775 | 85006   |         | 814903003500 | 83026   |         |
| 315624 | 85959   |         | 471700000440 | 85959   |         | 471700131778 | 85331   |         | 814903003501 | 83027   |         |
| 315625 | 85975   |         | 471700000443 | 85066   | 89448   | 471700131920 | 85933   | 89454   | 814903003528 | 83038   |         |
| 315626 | 85933   | 89454   | 471700000445 | 85080   |         | 471700131921 | 85933   | 89454   | 823196420    | 85100   |         |
| 315656 | 83040   |         | 471700000447 | 85919   |         | 471700131974 | 85029   |         |              |         |         |
| 315657 | 83039   |         | 471700000449 | 85918   | 89449   | 481700000206 | 85380   |         |              |         |         |

**SAF HOLLAND**

| O.E.M #      | Gabriel | Upgrade | O.E.M #      | Gabriel | Upgrade | O.E.M #      | Gabriel | Upgrade | O.E.M # | Gabriel | Upgrade |
|--------------|---------|---------|--------------|---------|---------|--------------|---------|---------|---------|---------|---------|
| 471700000433 | 85099   |         | 471700000460 | 85097   |         | 481700000485 | 85975   |         |         |         |         |
| 471700000436 | 85030   | 89440   | 471700000461 |         | 89414   | 57639        | 85000   | 89436   |         |         |         |
| 471700000458 | 85014   |         | 481700000483 | 85975   |         | 57643        | 85013   | 89414   |         |         |         |
| 471700000459 | 85030   | 89440   | 481700000484 | 85974   |         | 6025         | 83122   | 89406   |         |         |         |

**Important Note:** Competitive Interchanges are to be used for stocking purposes only. Where multiple crosses are identified, please reference the applications section of this catalog. / **Remarque importante:** Les interchanges concurrentiels ne s'utilisent qu'aux fins de stocks. Dans le cas de références multiples, consulter la section des applications du catalogue. / **Nota importante:** Dans le cas de références multiples, consulter la section des applications du catalogue. / **Nota importante:** Se pueden usar intercambios competitivos para propósitos de almacenamiento solamente. Cuando se identifican intercambios múltiples, consulte la sección de aplicaciones de este catálogo.

**COMPETITIVE & O.E.M. INTERCHANGE LIST**  
**Lista de Intercambios contra Competidores y Equipo Original.**  
**Liste d'interchange de produits compétitifs & d'équipement original (OEM)**

**SAF HOLLAND... cont'd**

| O.E.M #   | Gabriel | Upgrade | O.E.M #  | Gabriel | Upgrade | O.E.M #  | Gabriel | Upgrade | O.E.M #       | Gabriel | Upgrade |
|-----------|---------|---------|----------|---------|---------|----------|---------|---------|---------------|---------|---------|
| 6026      | 83204   |         | 90044681 | 83204   |         | 90045068 |         | 89441   | 90045535      | 85097   |         |
| 632155    | 646177  |         | 90044682 | 83209   | 89414   | 90045075 | 85911   |         | 90045536      |         | 89414   |
| 646201    | 646177  |         | 90044683 | 83122   | 89406   | 90045080 | 85912   |         | 90045563      | 85014   |         |
| 665002    | 85004   |         | 90044684 | 83124   | 89407   | 90045083 | 85910   |         | 90045564      | 83128   | 89436   |
| 665003    | 85300   | 89419   | 90044685 | 83389   | 89436   | 90045084 | 85968   |         | 90045568      | 85060   |         |
| 665197    | 85051   |         | 90044686 | 85051   |         | 90045096 | 85916   | 89430   | 90045572      | 85045   |         |
| 665454    | 85045   |         | 90044687 | 83125   |         | 90045099 | 85906   | 89407   | 90045574      | 83130   |         |
| 665514    | 83127   |         | 90044688 | 83122   | 89406   | 90045110 | 83137   |         | 90045575      | 85051   |         |
| 665969    |         | 89430   | 90044769 | 83207   | 89407   | 90045132 | 85909   |         | 90045576      | 83150   |         |
| 671921    | 85916   | 89430   | 90044770 | 83207   | 89407   | 90045138 | 85910   |         | 90045605      | 85109   |         |
| 671922    |         | 89405   | 90044794 | 83127   |         | 90045175 | 85916   | 89430   | 90045607      | 83150   |         |
| 671923    |         | 89440   | 90044833 | 85052   |         | 90045188 | 85910   |         | 90045608      | 83363   |         |
| 671931    | 85916   | 89430   | 90044834 | 85052   |         | 90045207 |         | 89405   | 90045665      | 85029   |         |
| 680234    | 85906   | 89407   | 90044868 | 85045   |         | 90045277 | 85030   | 89440   | 90045666      | 83130   |         |
| 680268    | 85323   | 89436   | 90044878 | 83635   |         | 90045298 | 83363   |         | 90045666      | 85051   |         |
| 680645    | 85321   |         | 90044907 | 83635   |         | 90045299 | 83389   | 89436   | 90045667      | 85060   |         |
| 90044001  | 85005   | 89430   | 90044915 | 83127   |         | 90045331 | 646155  |         | 90045669      | 83389   | 89436   |
| 90044008  | 85000   | 89436   | 90044977 | 83115   |         | 90045336 | 85014   |         | AR-1008       | 85006   |         |
| 90044011  | 85004   |         | 90044978 | 85059   |         | 90045337 | 85911   |         | AR-1141       | 83204   |         |
| 90044012  | 85006   |         | 90044979 | 83113   |         | 90045338 | 85060   |         | AR-1141-C     | 83204   |         |
| 90044016  | 85300   | 89419   | 90044980 | 85907   |         | 90045381 | 83150   |         | AR-1202       | 85300   | 89419   |
| 90044017  | 83204   |         | 90044981 | 85000   | 89436   | 90045384 |         | 89430   | AR-134-C      | 85005   | 89430   |
| 90044025  | 83209   | 89414   | 90044982 | 85000   | 89436   | 90045418 | 85916   | 89430   | AR-1404       | 85301   |         |
| 90044046  | 83123   | 89405   | 90044991 | 85000   | 89436   | 90045419 |         | 89405   | AR-1425       | 85301   |         |
| 90044071  | 85000   | 89436   | 90044992 | 85000   | 89436   | 90045420 |         | 89440   | AR-1434       | 83203   | 89436   |
| 90044081  | 85000   | 89436   | 90045000 | 85906   | 89407   | 90045432 | 85321   |         | AR-1654       | 83209   | 89414   |
| 90044086  | 85000   | 89436   | 90045001 | 85323   | 89436   | 90045433 | 85916   | 89430   | AR-1822       | 85304   |         |
| 90044089  | 83124   | 89407   | 90045002 | 85906   | 89407   | 90045455 | 85909   |         | AR-2451       | 83203   | 89436   |
| 90044089C | 83124   | 89407   | 90045003 | 85323   | 89436   | 90045466 |         | 89406   | AR-2598       | 83123   | 89405   |
| 90044095  | 83203   | 89436   | 90045028 | 85907   |         | 90045471 | 83150   |         | AR-718-C      | 83203   | 89436   |
| 90044162  | 83128   | 89436   | 90045031 | 85968   |         | 90045499 | 85974   |         | AR-718-C-HD   | 85000   | 89436   |
| 90044448  | 85051   |         | 90045040 | 83130   |         | 90045500 | 85975   |         | AR-781        | 83203   | 89436   |
| 90044625  | 83125   |         | 90045048 | 85905   |         | 90045503 | 85975   |         | AR-958        | 83207   | 89407   |
| 90044626  | 83126   | 89430   | 90045049 | 85905   |         | 90045504 | 85030   | 89440   | AR-995        | 85734   |         |
| 90044642  | 83127   |         | 90045050 | 85914   |         | 90045532 | 85030   | 89440   | XB-SPN-053-36 | 83125   |         |
| 90044679  | 83122   | 89406   | 90045053 | 85908   |         | 90045533 | 85099   |         |               |         |         |
| 90044680  | 83125   |         | 90045054 | 85051   |         | 90045534 | 85014   |         |               |         |         |

**SEAGRAVE FIRE APPARATUS LLC**

| O.E.M # | Gabriel | Upgrade | O.E.M #  | Gabriel | Upgrade | O.E.M # | Gabriel | Upgrade | O.E.M # | Gabriel | Upgrade |
|---------|---------|---------|----------|---------|---------|---------|---------|---------|---------|---------|---------|
| 680117  | 85300   | 89419   | P0025500 | 85300   | 89419   |         |         |         |         |         |         |

**SHASTA RV**

| O.E.M #  | Gabriel | Upgrade | O.E.M #  | Gabriel | Upgrade | O.E.M # | Gabriel | Upgrade | O.E.M # | Gabriel | Upgrade |
|----------|---------|---------|----------|---------|---------|---------|---------|---------|---------|---------|---------|
| ASH-1136 | 83178   |         | ASH-1154 | 83177   |         |         |         |         |         |         |         |

**SICARD**

| O.E.M # | Gabriel | Upgrade | O.E.M # | Gabriel | Upgrade | O.E.M # | Gabriel | Upgrade | O.E.M # | Gabriel | Upgrade |
|---------|---------|---------|---------|---------|---------|---------|---------|---------|---------|---------|---------|
| 3166657 | 85700   |         |         |         |         |         |         |         |         |         |         |

**SPARTAN MOTORS**

| O.E.M #  | Gabriel | Upgrade | O.E.M #      | Gabriel | Upgrade | O.E.M #    | Gabriel | Upgrade | O.E.M #  | Gabriel | Upgrade |
|----------|---------|---------|--------------|---------|---------|------------|---------|---------|----------|---------|---------|
| 0272-SS5 | 85712   |         | 471700000456 | 85959   |         | 60665-025  | 85036   | 89405   | B46-1594 | 85013   | 89414   |
| 0346-SS5 | 85013   | 89414   | 58913-009    | 85959   |         | 60665-025L | 85036   | 89405   | B46-1725 | 85029   |         |
| 0377-SS5 | 85029   |         | 58913-009L   | 85959   |         | 78068      | 85304   |         | B46-2151 | 85007   | 89412   |
| 21310-01 | 85307   |         | 59011        | 83214   |         | AS 4025B   | 85712   |         |          |         |         |

**SPRING VALLEY**

| O.E.M # | Gabriel | Upgrade | O.E.M # | Gabriel | Upgrade | O.E.M # | Gabriel | Upgrade | O.E.M # | Gabriel | Upgrade |
|---------|---------|---------|---------|---------|---------|---------|---------|---------|---------|---------|---------|
| 632155  | 646177  |         |         |         |         |         |         |         |         |         |         |

**Important Note:** Competitive Interchanges are to be used for stocking purposes only. Where multiple crosses are identified, please reference the applications section of this catalog. / **Remarque importante:** Les interchanges concurrentiels ne s'utilisent qu'aux fins de stocks. Dans le cas de références multiples, consulter la section des applications du catalogue. / **Nota importante:** Dans le cas de références multiples, consulter la section des applications du catalogue. / **Nota importante:** Se pueden usar intercambios competitivos para propósitos de almacenamiento solamente. Cuando se identifican intercambios múltiples, consulte la sección de aplicaciones de este catálogo.



# COMPETITIVE & O.E.M. INTERCHANGE LIST

## Lista de Intercambios contra Competidores y Equipo Original.

### Liste d'interchange de produits compétitifs & d'équipement original (OEM)

#### STARCRAFT BUS CO.

| O.E.M #      | Gabriel | Upgrade | O.E.M #       | Gabriel | Upgrade | O.E.M #   | Gabriel | Upgrade | O.E.M #       | Gabriel | Upgrade |
|--------------|---------|---------|---------------|---------|---------|-----------|---------|---------|---------------|---------|---------|
| 3578858C1    | 85926   |         | 4C4Z-18124-JB | 85928   |         | AA-617    | 85928   |         | FC44-18045-BB | 85181   |         |
| 3578858C2    | 85926   |         | 4C4Z-18124-QA | 83175   |         | ASH-1136  | 83178   |         | FC44-18080-AB | 85180   |         |
| 3584116C1    | 83175   |         | 4C4Z-18124-RA | 85928   |         | ASH-1154  | 83177   |         | FC4Z-18124-A  | 85181   |         |
| 3584116C2    | 83175   |         | 4C4Z-18125-B  | 83317   |         | ASH-24658 | 85181   |         | FC4Z-18124-B  | 85181   |         |
| 3584118C2    | 85928   |         | 4C4Z-18125-DA | 85926   |         | ASH-24659 | 85181   |         | FC4Z-18125-A  | 85180   |         |
| 471700011530 | 85181   |         | 501906C92     | 83317   |         | ASH-24660 | 85180   |         |               |         |         |
| 471700011531 | 85180   |         | AA-616        | 83175   |         | AT-812    | 85928   |         |               |         |         |

#### STERLING TRUCK

| O.E.M #       | Gabriel | Upgrade | O.E.M #       | Gabriel | Upgrade | O.E.M #       | Gabriel | Upgrade | O.E.M #         | Gabriel | Upgrade |
|---------------|---------|---------|---------------|---------|---------|---------------|---------|---------|-----------------|---------|---------|
| 10-12388-000  | 85920   | 89503   | 90045099      | 85906   | 89407   | F4HT-18080-AB | 85314   | 89425   | F6HT-18080-DA   | 83109   |         |
| 10-12390-000  | 85920   | 89503   | AT-560        | G63809  |         | F4HT-18080-BA | 85001   | 89410   | F6HT-18080-EA   | 85906   | 89407   |
| 10-13205-000  | 85918   | 89449   | AX-267A       | 83309   | 89446   | F5HZ-18124-A  | 83314   |         | F6HT-18080-FC   | 85013   | 89414   |
| 10-13592-000  | 85959   |         | AX-310        | 83215   |         | F5HZ-18124-B  | 83107   |         | F6HT-18124-JC   | 83200   | 89402   |
| 1210-0528     | 85904   |         | C4HZ-18124-E  | 83309   | 89446   | F5HZ-18124-C  | 85063   |         | F6HT-18124-KA   | 83200   | 89402   |
| 16-13957-000  | 85724   | 89443   | C4TZ-18124-AB | 83308   |         | F5HZ-18124-D  | 83125   |         | F6HZ-18124-A    | 85054   | 89438   |
| 16-15770-000  | 85956   |         | D8HZ-18124-A  | 85301   |         | F5HZ-18125-A  | 85314   | 89425   | F6HZ-18124-B    | 83308   |         |
| 16-15817-000  | 85724   | 89443   | E6HZ-18124-A  | 85301   |         | F5HZ-18125-B  | 85001   | 89410   | F6HZ-18124-C    | 85055   | 89439   |
| 16-18708-000  | 85724   | 89443   | E6HZ-18124-D  | 85301   |         | F6HT-18045-AA | 85054   | 89438   | F6HZ-18124-D    | 85055   | 89439   |
| 471700002809  | 85724   | 89443   | E6HZ-18125-D  | 83215   |         | F6HT-18045-AC | 85054   | 89438   | F6HZ-18124-E    | 85055   | 89439   |
| 471700131646  | 85918   | 89449   | E7HZ-18124-A  | 85301   |         | F6HT-18045-BC | 85047   | 89435   | F6HZ-18124-F    | 85055   | 89439   |
| 47902-28      | 85013   | 89414   | E7XZ-18124-A  | G63386  |         | F6HT-18045-CC | 85055   | 89439   | F6HZ-18124-G    | 85054   | 89438   |
| 481700006848  | 85724   | 89443   | E7XZ-18125-B  | G63387  |         | F6HT-18045-EB | 85055   | 89439   | F6HZ-18124-H    | 85054   | 89438   |
| 481700125969  | 85956   |         | E9HZ-18124-A  | 83309   | 89446   | F6HT-18045-EC | 85055   | 89439   | F6HZ-18124-J    | 83200   | 89402   |
| 4C4Z-18124-N  | 85957   |         | F0HZ-18124-B  | 85006   |         | F6HT-18045-EB | 85055   | 89439   | F6HZ-18124-K    | 83109   |         |
| 4C4Z-18125-DA | 85926   |         | F1HZ-18124-A  | 83309   | 89446   | F6HT-18045-GB | 85030   | 89440   | F6HZ-18125-B    | 83109   |         |
| 57241-2       | 83109   |         | F1HZ-18124-B  | 83308   |         | F6HT-18045-GC | 85030   | 89440   | F6HZ-18125-D    | 85013   | 89414   |
| 58913-003     | 85932   | 89453   | F1HZ-18124-D  | 85006   | 89401   | F6HT-18045-HB | 85054   | 89438   | F81A-18045-AGB  | G63809  |         |
| 58913-003L    | 85932   | 89453   | F1HZ-18124-E  | 85006   | 89401   | F6HT-18045-HC | 85054   | 89438   | SDA47170000440  | 85959   |         |
| 6803230200    | 85043   |         | F1HZ-18124-H  | 85040   |         | F6HT-18045-JB | 83200   | 89402   | SDA471700002809 | 85724   | 89443   |
| 6803230300    | 85006   |         | F1HZ-18124-J  | 83308   |         | F6HT-18045-JC | 83200   | 89402   | XC45-18045-AA   | 83216   |         |
| 6803260000    | 83120   |         | F1HZ-18124-K  |         | 89402   | F6HT-18045-KA | 83200   | 89402   | XC45-18080-BA   | 85724   | 89443   |
| 680611        | 85724   | 89443   | F2HZ-18124-A  | 85376   |         | F6HT-18045-LA | 85376   |         |                 |         |         |
| 6E7Z-18125-A  | 83146   |         | F2HZ-18124-B  | 85301   |         | F6HT-18080-B  | 83109   |         |                 |         |         |
|               |         |         |               |         |         | F6HT-18080-CA | 85314   | 89425   |                 |         |         |

#### STERLING TRUCK CAB SHOCKS

| O.E.M #      | Gabriel | Upgrade | O.E.M #      | Gabriel | Upgrade | O.E.M #         | Gabriel | Upgrade | O.E.M #       | Gabriel | Upgrade |
|--------------|---------|---------|--------------|---------|---------|-----------------|---------|---------|---------------|---------|---------|
| 1202-1043    | 83025   |         | 18-45067-000 | 83034   |         | 18-814903003484 | 83057   |         | F6HZ-5K407-BA | 83033   |         |
| 18-43504-000 | 83057   |         | 18-60768-000 | 83057   |         | F6HZ-5K407-AB   | 83034   |         | F8HT-5K407-AA | 83033   |         |

#### STOUGHTON TRAILERS INC.

| O.E.M #  | Gabriel | Upgrade | O.E.M #    | Gabriel | Upgrade | O.E.M #    | Gabriel | Upgrade | O.E.M #    | Gabriel | Upgrade |
|----------|---------|---------|------------|---------|---------|------------|---------|---------|------------|---------|---------|
| HTA20001 | 83128   | 89436   | NW90044162 | 83128   | 89436   | NW90044978 | 85059   |         | RT18165-01 | 85006   |         |
| HTA20002 | 85000   | 89436   | NW90044448 | 85051   |         | NW90044979 | 83113   |         |            |         |         |

#### SUSPENSIONS INC.

| O.E.M # | Gabriel | Upgrade | O.E.M # | Gabriel | Upgrade | O.E.M # | Gabriel | Upgrade | O.E.M # | Gabriel | Upgrade |
|---------|---------|---------|---------|---------|---------|---------|---------|---------|---------|---------|---------|
| 200188  | 646155  |         |         |         |         |         |         |         |         |         |         |

#### SUSPENSYS

| O.E.M #   | Gabriel | Upgrade | O.E.M # | Gabriel | Upgrade | O.E.M # | Gabriel | Upgrade | O.E.M # | Gabriel | Upgrade |
|-----------|---------|---------|---------|---------|---------|---------|---------|---------|---------|---------|---------|
| 218004872 | 85737   |         |         |         |         |         |         |         |         |         |         |

#### TEREX CORPORATION

| O.E.M # | Gabriel | Upgrade | O.E.M # | Gabriel | Upgrade | O.E.M # | Gabriel | Upgrade | O.E.M # | Gabriel | Upgrade |
|---------|---------|---------|---------|---------|---------|---------|---------|---------|---------|---------|---------|
| 12111   | 646155  |         |         |         |         |         |         |         |         |         |         |

#### THE BINKLEY COMPANY

| O.E.M # | Gabriel | Upgrade | O.E.M # | Gabriel | Upgrade | O.E.M # | Gabriel | Upgrade | O.E.M # | Gabriel | Upgrade |
|---------|---------|---------|---------|---------|---------|---------|---------|---------|---------|---------|---------|
| 16965   | 85006   |         | 6898    | 83125   |         |         |         |         |         |         |         |

#### THOMAS SCHOOL BUS

| O.E.M #      | Gabriel | Upgrade | O.E.M #      | Gabriel | Upgrade | O.E.M # | Gabriel | Upgrade | O.E.M # | Gabriel | Upgrade |
|--------------|---------|---------|--------------|---------|---------|---------|---------|---------|---------|---------|---------|
| 10-13211-000 | 85918   | 89449   | 128745       | 83102   |         |         |         |         |         |         |         |
| 10-13634-000 | 85918   | 89449   | 16-15817-000 | 85724   | 89443   |         |         |         |         |         |         |

**Important Note:** Competitive Interchanges are to be used for stocking purposes only. Where multiple crosses are identified, please reference the applications section of this catalog. / **Remarque importante:** Les interchanges concurrentiels ne s'utilisent qu'aux fins de stocks. Dans le cas de références multiples, consulter la section des applications du catalogue. / **Nota importante:** Dans le cas de références multiples, consulter la section des applications du catalogue. / **Nota importante:** Se pueden usar intercambios competitivos para propósitos de almacenamiento solamente. Cuando se identifican intercambios múltiples, consulte la sección de aplicaciones de este catálogo.

**COMPETITIVE & O.E.M. INTERCHANGE LIST**  
**Lista de Intercambios contra Competidores y Equipo Original.**  
**Liste d'interchange de produits compétitifs & d'équipement original (OEM)**

**THOMAS SCHOOL BUS... cont'd**

| O.E.M #      | Gabriel | Upgrade | O.E.M #  | Gabriel | Upgrade | O.E.M #       | Gabriel | Upgrade | O.E.M #       | Gabriel | Upgrade |
|--------------|---------|---------|----------|---------|---------|---------------|---------|---------|---------------|---------|---------|
| 16-18708-000 | 85724   | 89443   | 61300223 | 85091   |         | 63-0001       | 85713   |         | 8C24-18080-DB | 83178   |         |
| 16-18713-000 | 85122   |         | 61300224 | 85918   | 89449   | 651442        | 83102   |         | 8C2Z-18124-D  | 83177   |         |
| 16-19138-000 | 85058   | 89431   | 61300240 | 85918   | 89449   | 659287        | 83102   |         | 8C2Z-18125-D  | 83178   |         |
| 300-0614966  | 85307   |         | 61300285 | 83102   |         | 680-323-0300  | 85006   |         | 90045504      | 85030   | 89440   |
| 47170003070  | 85122   |         | 6130029  | 85712   |         | 680-326-0000  | 83120   |         | A-4890        | 85712   |         |
| 471700131545 | 85006   |         | 61310101 | 85736   |         | 680010        | 85304   |         | ASH-1136      | 83178   |         |
| 60670-006    | 83147   |         | 61310102 | 85308   | 89422   | 680054        | 85307   |         | ASH-1154      | 83177   |         |
| 60670-006L   | 83147   |         | 61310103 | 85308   | 89422   | 680088        | 85713   |         | AT-163G       | 83177   |         |
| 60998-001    | 85006   |         | 61310104 | 85713   |         | 680102        | 85712   |         | AT-164G       | 83178   |         |
| 60998-003    | 85006   |         | 61310232 | 85000   | 89436   | 6803260000    | 83120   |         | GBL651442     | 83102   |         |
| 6130-0114    |         | 89437   | 61310434 | 85724   | 89443   | 70445         | 85091   |         | GBL654725     | 83120   |         |
| 61300112     | 83613   |         | 61310478 | 85724   | 89443   | 728802        | 85736   |         | GBL665538     | 85006   |         |
| 61300219     | 85091   |         | 614966   | 85307   |         | 87002         | 85736   |         |               |         |         |
| 61300222     | 85091   |         | 614974   | 85304   |         | 8C24-18045-DA | 83177   |         |               |         |         |

**THOR MOTOR COACH**

| O.E.M #      | Gabriel | Upgrade | O.E.M #      | Gabriel | Upgrade | O.E.M #   | Gabriel | Upgrade | O.E.M #   | Gabriel | Upgrade |
|--------------|---------|---------|--------------|---------|---------|-----------|---------|---------|-----------|---------|---------|
| 141700131809 | 85029   |         | 16-16873-000 | 85029   |         | ASH-1136  | 83178   |         | ASH-25823 | 83209   | 89414   |
| 141700131810 | 83160   |         | 16-16874-000 | 83160   |         | ASH-1154  | 83177   |         | ASH-25824 | 83122   | 89406   |
| 16-16736-000 | 85029   |         | 16-18103-000 | 85900   |         | ASH-1229  | 83209   | 89414   |           |         |         |
| 16-16737-000 | 83160   |         | 481700000493 | 85900   |         | ASH-25822 | 83209   | 89414   |           |         |         |

**TIFFIN MOTORHOMES INC**

| O.E.M #   | Gabriel | Upgrade | O.E.M #    | Gabriel | Upgrade | O.E.M # | Gabriel | Upgrade | O.E.M # | Gabriel | Upgrade |
|-----------|---------|---------|------------|---------|---------|---------|---------|---------|---------|---------|---------|
| 58913-009 | 85959   |         | 58913-009L | 85959   |         |         |         |         |         |         |         |

**TIMBREN INDUSTRIES**

| O.E.M # | Gabriel | Upgrade | O.E.M # | Gabriel | Upgrade | O.E.M # | Gabriel | Upgrade | O.E.M # | Gabriel | Upgrade |
|---------|---------|---------|---------|---------|---------|---------|---------|---------|---------|---------|---------|
| 665804  | 85939   |         |         |         |         |         |         |         |         |         |         |

**TRAILMOBILE CANADA CORP.**

| O.E.M #  | Gabriel | Upgrade | O.E.M #  | Gabriel | Upgrade | O.E.M #  | Gabriel | Upgrade | O.E.M #  | Gabriel | Upgrade |
|----------|---------|---------|----------|---------|---------|----------|---------|---------|----------|---------|---------|
| 43-4-235 | 85051   |         | 43-6-028 | 85000   | 89436   | 43-8-014 | 85013   | 89414   | 90044978 | 85059   |         |
| 43-4-236 | 85029   |         | 43-6-118 | 85000   | 89436   | 43-8-015 | 85006   |         | 90044979 | 83113   |         |
| 43-4-237 | 85000   | 89436   | 43-6-137 | 85006   |         | 43-8-022 | 83225   |         | 90044992 | 85000   | 89436   |
| 43-4-239 | 83207   | 89407   | 43-6-158 | 85013   | 89414   | 43-8-031 | 85029   |         | 90045054 | 85051   |         |
| 43-4-241 | 85006   |         | 43-6-164 | 83207   | 89407   | 90044089 | 83124   | 89407   | A-2212   | 85029   |         |
| 43-4-277 | 85000   | 89436   | 43-8-002 | 83209   | 89414   | 90044625 | 83125   |         |          |         |         |
| 43-4-278 | 85059   |         | 43-8-011 | 83207   | 89407   | 90044642 | 83127   |         |          |         |         |
| 43-4-279 | 83204   |         | 43-8-013 | 85000   | 89436   | 90044977 | 83115   |         |          |         |         |

**TRANSPORTATION MFG. CORP**

| O.E.M #    | Gabriel | Upgrade | O.E.M #  | Gabriel | Upgrade | O.E.M #    | Gabriel | Upgrade | O.E.M #  | Gabriel | Upgrade |
|------------|---------|---------|----------|---------|---------|------------|---------|---------|----------|---------|---------|
| 12-05-6000 | 85711   |         | 12J-5-2  | 85733   |         | 12L-5-99   | 85339   |         | 680349   | 85702   |         |
| 12-05-6002 | 85339   |         | 12J-5-3  | 85313   |         | 12T-1-13   | 85303   | 89422   | 680350   | 85710   |         |
| 12-05-6033 | 85339   |         | 12J-5-4  | 85733   |         | 12TA-01-13 | 85303   | 89422   | 680470   | 85713   |         |
| 12B-5-1    | 85735   |         | 12J-5-6  | 85313   |         | 22024673   | 85710   |         | 695273   | 85710   |         |
| 12G-5-1    | 85700   |         | 12J-5-9  | 85700   |         | 22045526   | 85702   |         | 695279   | 85710   |         |
| 12J-5-10   | 85733   |         | 12L-5-69 | 85700   |         | 22046485   | 85710   |         | G1011822 | 85702   |         |
| 12J-5-11   | 85313   |         | 12L-5-70 | 85700   |         | 22052014   | 85702   |         | G1101590 | 85713   |         |

**TRUCKMASTER**

| Truckmaster | Gabriel | Upgrade | Truckmaster | Gabriel | Upgrade | Truckmaster | Gabriel | Upgrade | Truckmaster | Gabriel | Upgrade |
|-------------|---------|---------|-------------|---------|---------|-------------|---------|---------|-------------|---------|---------|
| 665632      | 85013   | 89414   | 665928      | 85062   | 89408   | 680237      | 85303   | 89422   | 680280      | 85906   | 89407   |
| 665633      | 85033   | 89427   | 665930      | 85001   | 89410   | 680239      | 85310   | 89423   | 680281      | 85003   | 89411   |
| 665783      | 83123   | 89405   | 665931      | 83312   | 89409   | 680240      | 85302   | 89420   | 680283      | 85740   |         |
| 665784      | 83122   | 89406   | 665932      | 85012   | 89413   | 680241      | 85311   | 89424   | 680303      | 85007   | 89412   |
| 665785      | 83137   |         | 665950      | 85902   |         | 680242      | 85308   | 89422   | 680348      | 85012   | 89413   |
| 665844      | 85069   | 89455   | 671052      | 85070   | 89459   | 680243      | 85001   | 89410   | 680385      | 85311   | 89424   |
| 665918      | 85900   |         | 671654      | 85936   | 89456   | 680253      | 85314   | 89425   | 680425      | 85320   | 89429   |
| 665926      | 85047   | 89435   | 671699      | 85937   |         | 680261      | 85062   | 89408   | 680435      | 85033   | 89427   |
| 665927      | 85901   |         | 671794      | 85067   | 89451   | 680279      | 83209   | 89414   | 680473      | 85319   | 89428   |

**Important Note:** Competitive Interchanges are to be used for stocking purposes only. Where multiple crosses are identified, please reference the applications section of this catalog. / **Remarque importante:** Les interchanges concurrentiels ne s'utilisent qu'aux fins de stocks. Dans le cas de références multiples, consulter la section des applications du catalogue. / **Nota importante:** Dans le cas de références multiples, consulter la section des applications du catalogue. / **Nota importante:** Se pueden usar intercambios competitivos para propósitos de almacenamiento solamente. Cuando se identifican intercambios múltiples, consulte la sección de aplicaciones de este catálogo.

# COMPETITIVE & O.E.M. INTERCHANGE LIST

## Lista de Intercambios contra Competidores y Equipo Original.

### Liste d'interchange de produits compétitifs & d'équipement original (OEM)

#### TRUCKMASTER... cont'd

| Truckmaster | Gabriel | Upgrade | Truckmaster | Gabriel | Upgrade | Truckmaster | Gabriel | Upgrade | Truckmaster | Gabriel | Upgrade |
|-------------|---------|---------|-------------|---------|---------|-------------|---------|---------|-------------|---------|---------|
| 680586      | 85311   | 89424   | 680601      | 85012   | 89413   |             |         |         |             |         |         |

#### TURTLETOP BUS

| O.E.M #  | Gabriel | Upgrade | O.E.M #  | Gabriel | Upgrade | O.E.M # | Gabriel | Upgrade | O.E.M # | Gabriel | Upgrade |
|----------|---------|---------|----------|---------|---------|---------|---------|---------|---------|---------|---------|
| ASH-1136 | 83178   |         | ASH-1154 | 83177   |         |         |         |         |         |         |         |

#### TUTHILL TECHNOLOGIES

| O.E.M #  | Gabriel | Upgrade | O.E.M #  | Gabriel | Upgrade | O.E.M #  | Gabriel | Upgrade | O.E.M #   | Gabriel | Upgrade |
|----------|---------|---------|----------|---------|---------|----------|---------|---------|-----------|---------|---------|
| 1085     | 83214   |         | 17358-01 | 83126   | 89430   | 19495-01 | 83126   |         | 23614-01  | 85717   |         |
| 12885-01 | 85300   | 89419   | 17403-01 | 83122   | 89406   | 19495-01 | 83126   | 89440   | 24392-01  | 85051   |         |
| 12885-03 | 85300   | 89419   | 17408-01 | 85005   | 89430   | 19623-01 | 83123   | 89405   | 2697      | 85712   |         |
| 12887-01 | 85013   | 89414   | 17794-01 | 83215   |         | 19824-01 | 85006   |         | 66502     | 646155  |         |
| 12887-02 | 85013   | 89414   | 18146-01 | 85313   |         | 20125-01 | 85030   | 89440   | 680162    | 85300   | 89419   |
| 14954-01 | 83217   |         | 18163-01 | 83207   | 89407   | 20126-01 |         | 89440   | 702135-01 | 85045   |         |
| 16230-01 | 85702   |         | 18164-01 | 83122   | 89406   | 20129-01 | 85007   | 89412   | 702136-01 | 85052   |         |
| 16725-01 | 83126   |         | 18165-01 | 85006   |         | 20960-01 | 83204   |         | 702209-01 | 85014   |         |
| 16824-01 | 85006   |         | 18166-01 | 85704   |         | 21497-01 | 85005   | 89430   | OE12425   | 83214   |         |
| 17142-01 | 85001   | 89410   | 18286-01 |         | 89414   | 23524-01 | 85738   |         |           |         |         |
| 17146-01 | 83209   | 89414   | 18800-01 | 83203   | 89436   | 23553-01 | 85938   |         |           |         |         |

#### TWIN COACH

| O.E.M #   | Gabriel | Upgrade | O.E.M #     | Gabriel | Upgrade | O.E.M # | Gabriel | Upgrade | O.E.M # | Gabriel | Upgrade |
|-----------|---------|---------|-------------|---------|---------|---------|---------|---------|---------|---------|---------|
| 90044089  | 83124   | 89407   | 90044162    | 83128   | 89436   | AR-958  | 83207   | 89407   |         |         |         |
| 90044089C | 83124   | 89407   | AR-718-C-HD | 85000   | 89436   |         |         |         |         |         |         |

#### UNITED MANUFACTURING

| O.E.M # | Gabriel | Upgrade | O.E.M # | Gabriel | Upgrade | O.E.M # | Gabriel | Upgrade | O.E.M # | Gabriel | Upgrade |
|---------|---------|---------|---------|---------|---------|---------|---------|---------|---------|---------|---------|
| K-96-41 | 85304   |         |         |         |         |         |         |         |         |         |         |

#### UNIVERSAL COACH

| O.E.M #    | Gabriel | Upgrade | O.E.M # | Gabriel | Upgrade | O.E.M # | Gabriel | Upgrade | O.E.M # | Gabriel | Upgrade |
|------------|---------|---------|---------|---------|---------|---------|---------|---------|---------|---------|---------|
| 12-05-1199 | 85729   |         | 680777  | 85729   |         |         |         |         |         |         |         |

#### UPS TRUCK

| O.E.M # | Gabriel | Upgrade | O.E.M # | Gabriel | Upgrade | O.E.M # | Gabriel | Upgrade | O.E.M # | Gabriel | Upgrade |
|---------|---------|---------|---------|---------|---------|---------|---------|---------|---------|---------|---------|
| P117099 | 83120   |         | P117146 | 83118   |         |         |         |         |         |         |         |

#### UTILITY TRAILER MANUFACTURING COMPANY

| O.E.M # | Gabriel | Upgrade | O.E.M # | Gabriel | Upgrade | O.E.M # | Gabriel | Upgrade | O.E.M # | Gabriel | Upgrade |
|---------|---------|---------|---------|---------|---------|---------|---------|---------|---------|---------|---------|
| B-23361 | 85911   |         | B-24023 | 85738   |         | B-24125 | 85323   | 89436   | S-24088 | 83128   | 89436   |
| B-23566 | 85000   | 89436   | B-24088 | 83128   | 89436   | B-24579 | 85939   |         | S-24088 | 85000   | 89436   |
| B-23651 | 85045   |         | B-24088 | 85000   | 89436   | B-25515 | 85338   |         |         |         |         |

#### VAN HOOL

| O.E.M #    | Gabriel | Upgrade | O.E.M #    | Gabriel | Upgrade | O.E.M # | Gabriel | Upgrade | O.E.M # | Gabriel | Upgrade |
|------------|---------|---------|------------|---------|---------|---------|---------|---------|---------|---------|---------|
| 10685703   | 695406  |         | 6243-14040 | 85708   |         | 665562  | 85708   |         | 90-2291 | 695406  |         |
| 6243-13790 | 85708   |         | 624314570  | 695406  |         | 665563  | 85708   |         |         |         |         |

#### VARIOUS

| O.E.M # | Gabriel | Upgrade | O.E.M # | Gabriel | Upgrade | O.E.M # | Gabriel | Upgrade | O.E.M # | Gabriel | Upgrade |
|---------|---------|---------|---------|---------|---------|---------|---------|---------|---------|---------|---------|
| SC-2920 | 83176   |         |         |         |         |         |         |         |         |         |         |

#### VOLVO

| O.E.M #         | Gabriel | Upgrade | O.E.M # | Gabriel | Upgrade | O.E.M # | Gabriel | Upgrade | O.E.M #      | Gabriel | Upgrade |
|-----------------|---------|---------|---------|---------|---------|---------|---------|---------|--------------|---------|---------|
| 02-7005976      | 83400   |         | 1091358 | 83456   | 89447   | 1091372 | 85301   |         | 1093180      | 85030   | 89440   |
| 02-7005977      | 83400   |         | 1091359 | 83123   | 89405   | 1091373 | 85302   | 89420   | 14170000373  | 85061   | 89450   |
| 03-1106460      | 85005   | 89430   | 1091360 | 83303   |         | 1091374 | 85303   | 89422   | 141700005838 | 85098   |         |
| 1-0200-32-888-1 | 83104   |         | 1091361 | 83304   |         | 1091375 | 85304   |         | 1505190      | 85722   |         |
| 1091347         | 83125   |         | 1091362 | 83309   | 89446   | 1091376 | 85305   |         | 1590439      | 83104   |         |
| 1091348         | 83122   | 89406   | 1091363 | 83221   |         | 1091377 | 85307   |         | 1591501      | 85722   |         |
| 1091349         | 83204   |         | 1091364 | 83312   | 89409   | 1091378 | 85308   | 89422   | 1591735      | 83104   |         |
| 1091350         | 83207   | 89407   | 1091365 | 83400   |         | 1091379 | 85310   | 89423   | 1593843      | 83215   |         |
| 1091351         | 83209   | 89414   | 1091366 | 83401   |         | 1091384 | 85735   |         | 1716824      | 85304   |         |
| 1091353         | 83215   |         | 1091367 | 85000   | 89436   | 1093100 | 85027   | 89418   |              |         |         |
| 1091354         | 83216   |         | 1091368 | 85003   | 89411   | 1093176 | 85024   |         |              |         |         |
| 1091355         | 83217   |         | 1091370 | 85006   |         | 1093177 | 85025   |         |              |         |         |
| 1091357         | 83219   |         | 1091371 | 85300   | 89419   | 1093178 | 85026   | 89417   |              |         |         |

**Important Note:** Competitive Interchanges are to be used for stocking purposes only. Where multiple crosses are identified, please reference the applications section of this catalog. / **Remarque importante:** Les interchanges concurrentiels ne s'utilisent qu'aux fins de stocks. Dans le cas de références multiples, consulter la section des applications du catalogue. / **Nota importante:** Dans le cas de références multiples, consulter la section des applications du catalogue. / **Nota importante:** Se pueden usar intercambios competitivos para propósitos de almacenamiento solamente. Cuando se identifican intercambios múltiples, consulte la sección de aplicaciones de este catálogo.

**COMPETITIVE & O.E.M. INTERCHANGE LIST**  
**Lista de Intercambios contra Competidores y Equipo Original.**  
**Liste d'interchange de produits compétitifs & d'équipement original (OEM)**

**VOLVO... cont'd**

| O.E.M #  | Gabriel | Upgrade | O.E.M #    | Gabriel | Upgrade | O.E.M # | Gabriel | Upgrade | O.E.M # | Gabriel | Upgrade |
|----------|---------|---------|------------|---------|---------|---------|---------|---------|---------|---------|---------|
| 19501669 | 85339   |         | 3199965    | 85736   |         | 3919561 | 85314   | 89425   | 3919935 | 85026   | 89417   |
| 19502711 | 85702   |         | 3199966    | 85303   | 89422   | 3919565 | 83103   |         | 3919936 | 83207   | 89407   |
| 19506846 | 85339   |         | 3199967    | 85302   | 89420   | 3919567 | 83613   |         | 3919937 | 85316   | 89426   |
| 20353932 | 85081   |         | 3199968    | 85308   | 89422   | 3919569 | 85052   |         | 3919938 | 85030   | 89440   |
| 20414440 | 85081   |         | 3199972    | 85320   | 89429   | 3919570 | 83128   | 89436   | 3919939 | 85058   | 89431   |
| 20433424 | 85061   | 89450   | 3199973    | 85722   |         | 3919571 | 83635   |         | 3919940 | 85005   | 89430   |
| 20433425 | 85066   | 89448   | 3199974    | 85712   |         | 3919572 | 83130   |         | 3919941 | 85006   |         |
| 20433426 | 85081   |         | 3199975    | 85700   |         | 3919573 | 83123   | 89405   | 3919942 | 89402   |         |
| 20433427 | 85065   |         | 3199976    | 85711   |         | 3919574 | 85006   | 89401   | 3919943 | 85012   | 89413   |
| 20434880 | 85081   |         | 3199977    | 85711   |         | 3919575 | 83120   |         | 3919944 | 85036   | 89405   |
| 20469001 | 85933   | 89454   | 3199978    | 85712   |         | 3919582 | 83215   |         | 3919945 | 85027   | 89418   |
| 20469002 | 85933   | 89454   | 3199979    | 85702   |         | 3919583 | 83100   |         | 3919946 | 85033   | 89427   |
| 20485632 | 85933   | 89454   | 3199980    | 85310   | 89423   | 3919585 | 83209   | 89414   | 3919947 | 85013   | 89414   |
| 20485633 | 85933   | 89454   | 3199982    | 85703   |         | 3919586 | 83100   |         | 3919948 | 85311   | 89424   |
| 20513881 | 85061   | 89450   | 3199983    | 85704   |         | 3919587 | 83105   |         | 3919949 | 85310   | 89423   |
| 20551628 | 85066   | 89448   | 3199984    | 85314   | 89425   | 3919588 | 83216   |         | 3919950 | 83219   |         |
| 20782199 | 85072   |         | 3199985    | 85723   |         | 3919589 | 85026   | 89417   | 3919951 | 83309   | 89446   |
| 20863239 | 85080   |         | 3199986    | 85318   |         | 3919590 | 85042   |         | 3919952 | 85736   |         |
| 21137330 | 85933   | 89454   | 3199987    | 85705   |         | 3919591 | 83515   |         | 3919953 | 85319   | 89428   |
| 21436086 | 85098   |         | 3199988    | 85311   | 89424   | 3919592 | 85024   |         | 3919954 | 85003   | 89411   |
| 21462378 | 85088   |         | 3199989    | 85709   |         | 3919593 | 83242   |         | 3919955 | 85300   | 89419   |
| 21462380 | 85088   |         | 3199990    | 85003   | 89411   | 3919594 | 85003   | 89411   | 3919956 | 85036   | 89405   |
| 22012065 | 85304   |         | 3199991    | 85708   |         | 3919596 | G63484  |         | 3919957 | 83122   | 89406   |
| 22046483 | 85304   |         | 3199992    | 85733   |         | 3919598 | 83312   | 89409   | 3919958 | 85046   | 89434   |
| 22052336 | 85304   |         | 3199993    | 85712   |         | 3919900 | 85012   | 89413   | 3919959 | 85000   | 89436   |
| 3082284  | 83400   |         | 3199994    | 85308   | 89422   | 3919901 | 83103   |         | 3919960 | 85322   |         |
| 3092842  | 85061   | 89450   | 35901-0001 | 83209   | 89414   | 3919902 | 83126   | 89430   | 3919961 | 85302   | 89420   |
| 3130140  | 85315   |         | 35901-0003 | 85301   |         | 3919903 | 83216   |         | 3919962 | 85700   |         |
| 3171696  | 85307   |         | 35901-0004 | 83219   |         | 3919904 | G63183  |         | 3919964 | 85304   |         |
| 3172948  | 85303   | 89422   | 35901-0005 | 83219   |         | 3919906 | 83308   |         | 3919965 | 85702   |         |
| 3199937  | 85316   | 89426   | 35901-0008 | 85060   |         | 3919907 | 83309   | 89446   | 3919966 | 85736   |         |
| 3199938  | 85030   | 89440   | 35901-0011 | 83123   | 89405   | 3919908 | 83104   |         | 3919967 | 85302   | 89420   |
| 3199939  | 85058   | 89431   | 35901-0017 | 83314   |         | 3919909 | G63605  |         | 3919968 | 85736   |         |
| 3199940  | 85005   | 89430   | 35901-0022 | 83635   |         | 3919910 | 83221   |         | 3919972 | 85320   | 89429   |
| 3199941  | 85006   |         | 35901-3201 | 85024   |         | 3919911 | 83124   | 89407   | 3919973 | 85956   |         |
| 3199942  |         | 89402   | 35901-3406 | 85305   |         | 3919912 | 83215   |         | 3919974 | 85712   |         |
| 3199943  | 85012   | 89413   | 35901-3409 | 85304   |         | 3919913 | 83203   | 89436   | 3919975 | 85700   |         |
| 3199944  | 85006   |         | 35901-3410 | 85307   |         | 3919914 | 83209   | 89414   | 3919976 | 85033   | 89427   |
| 3199945  | 85027   | 89418   | 35901-3413 | 85006   |         | 3919915 | 83127   |         | 3919977 | 85033   | 89427   |
| 3199946  | 85033   | 89427   | 35901-3420 | 85303   | 89422   | 3919916 | 83126   | 89430   | 3919978 | 85702   |         |
| 3199947  | 85013   | 89414   | 37001-5    | 83401   |         | 3919917 | 83125   |         | 3919979 | 85702   |         |
| 3199948  | 85311   | 89424   | 37301-0001 | 85013   | 89414   | 3919918 | 83401   |         | 3919980 | 85702   |         |
| 3199949  | 85310   | 89423   | 37301-0008 | 83400   |         | 3919919 | G63625  |         | 3919982 | 85703   |         |
| 3199950  | 85023   | 89415   | 37301-0016 | 85026   | 89417   | 3919920 | 83303   |         | 3919983 | 85704   |         |
| 3199951  | 85024   |         | 37301-0018 | 85005   | 89430   | 3919921 | 83123   | 89405   | 3919984 | 85700   |         |
| 3199952  | 85736   |         | 37301-0021 | 85026   | 89417   | 3919922 | 83318   |         | 3919985 | 85723   |         |
| 3199953  | 85319   | 89428   | 37301-3201 | 85027   | 89418   | 3919923 | 83301   |         | 3919987 | 85706   |         |
| 3199954  | 85003   | 89411   | 37301-3202 | 85026   | 89417   | 3919924 | 83456   | 89447   | 3919988 | 85311   | 89424   |
| 3199955  | 85300   | 89419   | 3915917    | 85319   | 89428   | 3919925 | 83317   |         | 3919989 | 85709   |         |
| 3199956  | 85036   | 89405   | 3915947    | 85001   | 89410   | 3919926 | G63403  |         | 3919990 | 85003   | 89411   |
| 3199957  | 83122   | 89406   | 3915948    | 85311   | 89424   | 3919927 | 83101   |         | 3919991 | 85708   |         |
| 3199959  | 85323   | 89436   | 3916352    | 85013   | 89414   | 3919928 | 83225   |         | 3919992 | 85733   |         |
| 3199960  | 85322   |         | 3919055    | 85007   | 89412   | 3919931 | 83126   | 89430   | 3919993 | 85712   |         |
| 3199961  | 85307   |         | 3919056    | 83203   | 89436   | 3919932 | 85062   | 89408   | 3919994 | 85310   | 89423   |
| 3199962  | 85314   | 89425   | 3919057    | 83225   |         | 3919933 | 85001   | 89410   | 3945806 |         | 89417   |
| 3199963  | 85315   |         | 3919526    | 83314   |         | 3919934 | 85320   | 89429   | 3945808 |         | 89407   |

**Important Note:** Competitive Interchanges are to be used for stocking purposes only. Where multiple crosses are identified, please reference the applications section of this catalog. / **Remarque importante:** Les interchanges concurrentiels ne s'utilisent qu'aux fins de stocks. Dans le cas de références multiples, consulter la section des applications du catalogue. / **Nota importante:** Dans le cas de références multiples, consulter la section des applications du catalogue. / **Nota importante:** Se pueden usar intercambios competitivos para propósitos de almacenamiento solamente. Cuando se identifican intercambios múltiples, consulte la sección de aplicaciones de este catálogo.

**COMPETITIVE & O.E.M. INTERCHANGE LIST**  
**Lista de Intercambios contra Competidores y Equipo Original.**  
**Liste d'interchange de produits compétitifs & d'équipement original (OEM)**

**VOLVO... cont'd**

| O.E.M #      | Gabriel | Upgrade | O.E.M #     | Gabriel | Upgrade | O.E.M #   | Gabriel | Upgrade | O.E.M #   | Gabriel | Upgrade |
|--------------|---------|---------|-------------|---------|---------|-----------|---------|---------|-----------|---------|---------|
| 3945809      |         | 89410   | 629501      | 85307   |         | 83176205  | 83136   |         | RC SA3203 | 83203   | 89436   |
| 3945810      |         | 89420   | 646220      | 85734   |         | 83176206  | 83148   |         | RC SA3216 | 83216   |         |
| 3945811      |         | 89409   | 64838-001   | 85933   | 89454   | 83176207  | 83203   | 89436   | RC SA5000 | 85000   | 89436   |
| 3945812      |         | 89423   | 64838-002   | 85933   | 89454   | 83176208  | 83209   | 89414   | RC SA5001 | 85001   | 89410   |
| 3945813      |         | 89428   | 64838-003   | 85933   | 89454   | 83176209  | 83215   |         | RC SA5003 | 85003   | 89411   |
| 3945814      |         | 89424   | 64838-003L  | 85933   | 89454   | 83176210  | 83216   |         | RC SA5005 | 85005   | 89430   |
| 3945815      |         | 89406   | 66010-0016  | 85025   |         | 83176211  | 85000   | 89436   | RC SA5047 | 85047   | 89435   |
| 3945816      |         | 89430   | 66221140I   | 83215   |         | 83176212  | 85001   | 89410   | RC SA5052 | 85052   |         |
| 3945817      |         | 89422   | 665410      | 85027   | 89418   | 83176213  | 85003   | 89411   | RC SA5061 | 85061   | 89450   |
| 3945818      |         | 89415   | 665539      | 85026   | 89417   | 83176214  | 85005   | 89430   | RC SA5062 | 85062   | 89408   |
| 3945819      |         | 89411   | 665607      | 85047   | 89435   | 83176215  | 85023   | 89415   | RC SA5066 | 85066   | 89448   |
| 3945820      |         | 89413   | 665623      | 85046   | 89434   | 83176216  | 85026   | 89417   | RC SA5067 | 85067   | 89451   |
| 3945821      |         | 89419   | 665739      | 85047   | 89435   | 83176217  | 85033   | 89427   | RC SA5070 | 85070   | 89459   |
| 3946210      | 83103   |         | 668302      | 83216   |         | 83176218  | 85036   | 89405   | RC SA5310 | 85310   | 89423   |
| 3946217      | 83125   |         | 676081      | 83401   |         | 83176219  | 85045   |         | RC SA5320 | 85320   | 89429   |
| 3946219      | 83400   |         | 676082      | 83401   |         | 83176220  | 85046   | 89434   | RC SA5724 | 85724   | 89443   |
| 3946239      | 85724   | 89443   | 6771501     | 85040   |         | 83176221  | 85047   | 89435   | RC SA5900 | 85900   |         |
| 3949240      | 85047   | 89435   | 6772218     | 85040   |         | 83176222  | 85052   |         | RC SA5918 | 85918   | 89449   |
| 3949241      | 85061   | 89450   | 6775411     | 85040   |         | 83176223  | 85061   | 89450   | RC SA5933 | 85933   | 89454   |
| 3953643      | 85040   |         | 6775412     | 85040   |         | 83176224  | 85062   | 89408   | RC SA6155 | 646155  |         |
| 3971703      | 83112   |         | 6790756     | 83215   |         | 83176225  | 85066   | 89448   | SA3019    | 83019   |         |
| 3972662      | 85976   |         | 6794358     | 85040   |         | 83176226  | 85067   | 89451   | SA3041    | 83041   |         |
| 471700000443 | 85066   | 89448   | 6857668     | 83105   |         | 83176227  | 85069   | 89455   | SA3045    | 83045   |         |
| 471700002627 | 85066   | 89448   | 6876828     | 83105   |         | 83176228  | 85070   | 89459   | SA3048    | 83048   |         |
| 471700003832 | 85933   | 89454   | 70042       | 85302   | 89420   | 83176229  | 85303   | 89422   | SA3103    | 83103   |         |
| 471700004423 | 85109   |         | 8026658     | 85046   | 89434   | 83176230  | 85310   | 89423   | SA3110    | 83110   |         |
| 471700006038 | 85088   |         | 8056892     | 85023   | 89415   | 83176231  | 85311   | 89424   | SA3111    | 83111   |         |
| 471700006040 | 85088   |         | 8060026     | 85065   |         | 83176232  | 85320   | 89429   | SA3112    | 83112   |         |
| 471700131256 | 85065   |         | 8065787     | 85026   | 89417   | 83176233  | 85321   |         | SA3123    | 83123   |         |
| 471700131258 | 85081   |         | 8071524     | 85024   |         | 83176234  | 85323   | 89436   | SA3124    | 83124   |         |
| 471700131920 | 85933   | 89454   | 8071881     | 85061   | 89450   | 83176235  | 85724   | 89443   | SA3125    | 83125   |         |
| 471700131921 | 85933   | 89454   | 8073212     | 85065   |         | 83176236  | 85900   |         | SA3126    | 83126   |         |
| 47902-24     | 83137   |         | 8075257     | 85065   |         | 83176237  | 85916   | 89430   | SA3127    | 83127   |         |
| 494-660      | 83219   |         | 8075287     | 85065   |         | 83176238  | 85918   | 89449   | SA3128    | 83128   | 89436   |
| 4940640      | 83216   |         | 8077874     | 85047   | 89435   | 83176239  | 85933   | 89454   | SA3136    | 83136   |         |
| 4975479      | 83400   |         | 8077874-P01 | 85047   | 89435   | 83176240  | 646155  |         | SA3148    | 83148   |         |
| 4975480      | 83400   |         | 8078195     | 85061   | 89450   | 85104186  | 85006   |         | SA5000    | 85000   | 89436   |
| 4975549      | 83216   |         | 8083872     | 85978   |         | 85104221  | 85066   | 89448   | SA5001    | 85001   | 89410   |
| 530596       | 85308   | 89422   | 8086053     | 85047   | 89435   | 85106580  | 85918   | 89449   | SA5003    | 85003   | 89411   |
| 5322338      | 83214   |         | 8086651     | 85066   | 89448   | 85107238  | 85976   |         | SA5005    | 85005   | 89430   |
| 5513989      | 83216   |         | 8169859     | 85047   | 89435   | 85134402  | 85061   | 89450   | SA5023    | 85023   | 89415   |
| 5531435      | 85307   |         | 8174749     | 85906   | 89407   | 85137234  | 83125   |         | SA5026    | 85026   | 89417   |
| 5531436      | 85307   |         | 83176191    | 83019   |         | 85137420  | 85000   | 89436   | SA5033    | 85033   | 89427   |
| 5531437      | 85307   |         | 83176192    | 83041   |         | 90045605  | 85109   |         | SA5036    | 85036   | 89405   |
| 5534430      | 85303   | 89422   | 83176193    | 83045   |         | RC SA3041 | 83041   |         | SA5045    | 85045   |         |
| 5534447      | 85303   | 89422   | 83176194    | 83048   |         | RC SA3045 | 83045   |         | SA5046    | 85046   | 89434   |
| 5549899      | 83207   | 89407   | 83176195    | 83103   |         | RC SA3048 | 83048   |         | SA5047    | 85047   | 89435   |
| 5549925      | 85304   |         | 83176196    | 83110   |         | RC SA3103 | 83103   |         | SA5052    | 85052   |         |
| 5554959      | 83401   |         | 83176197    | 83111   |         | RC SA3111 | 83111   |         | SA5061    | 85061   | 89450   |
| 57241-3      | 83112   |         | 83176198    | 83112   |         | RC SA3112 | 83112   |         | SA5062    | 85062   | 89408   |
| 60657-007    | 85072   |         | 83176199    | 83123   |         | RC SA3124 | 83124   |         | SA5066    | 85066   | 89448   |
| 60675-001    | 85978   |         | 83176200    | 83124   |         | RC SA3125 | 83125   |         | SA5067    | 85067   | 89451   |
| 60675-001L   | 85978   |         | 83176201    | 83125   |         | RC SA3127 | 83127   |         | SA5069    | 85069   | 89455   |
| 60680-003    | 83112   |         | 83176202    | 83126   |         | RC SA3128 | 83128   | 89436   | SA5070    | 85070   | 89459   |
| 60680-003L   | 83112   |         | 83176203    | 83127   |         | RC SA3136 | 83136   |         | SA5303    | 85303   | 89422   |
| 629398       | 85307   |         | 83176204    | 83128   | 89436   | RC SA3148 | 83148   |         | SA5310    | 85310   | 89423   |

**Important Note:** Competitive Interchanges are to be used for stocking purposes only. Where multiple crosses are identified, please reference the applications section of this catalog. / **Remarque importante:** Les interchanges concurrentiels ne s'utilisent qu'aux fins de stocks. Dans le cas de références multiples, consulter la section des applications du catalogue. / **Nota importante:** Dans le cas de références multiples, consulter la section des applications du catalogue. / **Nota importante:** Se pueden usar intercambios competitivos para propósitos de almacenamiento solamente. Cuando se identifican intercambios múltiples, consulte la sección de aplicaciones de este catálogo.

**COMPETITIVE & O.E.M. INTERCHANGE LIST**  
**Lista de Intercambios contra Competidores y Equipo Original.**  
**Liste d'interchange de produits compétitifs & d'équipement original (OEM)**

**VOLVO... cont'd**

| O.E.M # | Gabriel | Upgrade | O.E.M # | Gabriel | Upgrade | O.E.M # | Gabriel | Upgrade | O.E.M #         | Gabriel | Upgrade |
|---------|---------|---------|---------|---------|---------|---------|---------|---------|-----------------|---------|---------|
| SA5311  | 85311   | 89424   | SA5323  | 85323   | 89436   | SA5916  | 85916   | 89430   | SA6155          | 646155  |         |
| SA5320  | 85320   |         | SA5724  | 85724   | 89443   | SA5918  | 85918   | 89449   | SDA471700131258 | 85081   |         |
| SA5321  | 85321   |         | SA5900  | 85900   |         | SA5933  | 85933   | 89454   |                 |         |         |

**VOLVO CAB SHOCKS**

| O.E.M #   | Gabriel | Upgrade | O.E.M #  | Gabriel | Upgrade | O.E.M #    | Gabriel | Upgrade | O.E.M #  | Gabriel | Upgrade |
|-----------|---------|---------|----------|---------|---------|------------|---------|---------|----------|---------|---------|
| 1201-0012 | 83023   |         | 20874147 | 83050   |         | 22662235   | 83905   |         | 8078547  | 83029   |         |
| 1202-0012 | 83023   |         | 21368411 | 83905   |         | 22662237   | 83905   |         | 8162662  | 83004   |         |
| 1202-0032 | 83016   |         | 21368413 | 83048   |         | 3945842    | 83009   |         | 8168617  | 83030   |         |
| 20496215  | 83048   |         | 21391412 | 83048   |         | 635869     | 83004   |         | 85107095 | 83009   |         |
| 20496217  | 83029   |         | 22662125 | 83048   |         | 66010-0007 | 83004   |         |          |         |         |
| 20704334  | 83048   |         | 22662224 | 83048   |         | 66010-0008 | 83004   |         |          |         |         |
| 20721254  | 83048   |         | 22662230 | 83905   |         | 8078546    | 83028   |         |          |         |         |

**WABASH NATIONAL**

| O.E.M #      | Gabriel | Upgrade | O.E.M #        | Gabriel | Upgrade | O.E.M #       | Gabriel | Upgrade | O.E.M #       | Gabriel | Upgrade |
|--------------|---------|---------|----------------|---------|---------|---------------|---------|---------|---------------|---------|---------|
| 202447       | 85919   |         | FRUUCE1295-901 | 85300   | 89419   | HENS-24088    | 83128   | 89436   | NEW900-44-868 | 85045   |         |
| 203447       | 85919   |         | FRUUCE2983-1   | 85322   |         | HENS-24088    | 85000   | 89436   | NEW900-44-978 | 85059   |         |
| DANSR1VJ100  | 85078   |         | FRUUCF8339-1   | 85321   |         | NEW900-44-089 | 83124   | 89407   | NEW900-44-979 | 83113   |         |
| FLL83203-07I | 83203   | 89436   | HENS-20001     | 83128   | 89436   | NEW900-44-162 | 83128   | 89436   | NEW900-45-040 | 83130   |         |
| FLL83207-07I | 83207   | 89407   | HENS-20002     | 85000   | 89436   | NEW900-44-625 | 83125   |         | NEW900-45-054 | 85051   |         |
| FLL85000-07I | 85000   | 89436   | HENS-20126     | 85323   | 89436   | NEW900-44-626 | 83126   | 89430   | NEW900-45-298 | 83128   | 89436   |
| FLL85030-07I | 85030   | 89440   | HENS-21292     | 85052   |         | NEW900-44-642 | 83127   |         | NEW900-45-299 | 85000   | 89436   |
| FRUUCE1295-1 | 85300   | 89419   | HENS-23566     | 85000   | 89436   | NEW900-44-794 | 83127   |         |               |         |         |

**WATSON & CHALIN MFG. INC.**

| O.E.M # | Gabriel | Upgrade | O.E.M #  | Gabriel | Upgrade | O.E.M # | Gabriel | Upgrade | O.E.M # | Gabriel | Upgrade |
|---------|---------|---------|----------|---------|---------|---------|---------|---------|---------|---------|---------|
| 10147   | 83203   | 89436   | 17186-01 | 85323   | 89436   | 19250   | 85382   |         | 680714  | 85934   |         |
| 10147HD | 85000   | 89436   | 17218    | 85029   |         | 19603   | 85939   |         | 727603  | 83203   | 89436   |
| 10148   | 83204   |         | 17297    | 85064   |         | 3946219 | 83400   |         | 727604  | 83204   |         |
| 10634   | G63357  |         | 17300    | 85052   |         | 665724  | 85000   | 89436   | A-20345 | 85345   |         |
| 11418   | 646155  |         | 17306    | 85938   |         | 665727  | 85005   | 89430   | B-23649 | 85064   |         |
| 11604   | 83125   |         | 17317    | 85344   |         | 665728  | 85060   |         | B-23650 | 85052   |         |
| 11724   | 83123   | 89405   | 17382    | 85014   |         | 665769  | 85052   |         | B-23651 | 85045   |         |
| 12128   | 85005   | 89430   | 17430    | 85321   |         | 665770  | 85064   |         | B-23743 | 85938   |         |
| 17069   | 632147  |         | 17474    | 85009   |         | 665862  | 85000   | 89436   |         |         |         |
| 17079   | 85300   | 89419   | 19036    | 85934   |         | 680547  | 85323   | 89436   |         |         |         |
| 17186   | 85323   | 89436   | 19249    | 85939   |         | 680584  | 85938   |         |         |         |         |

**WESTERN STAR**

| O.E.M #      | Gabriel | Upgrade | O.E.M #      | Gabriel | Upgrade | O.E.M #      | Gabriel | Upgrade | O.E.M #         | Gabriel | Upgrade |
|--------------|---------|---------|--------------|---------|---------|--------------|---------|---------|-----------------|---------|---------|
| 02-7005976   | 83400   |         | 35901-3413   | 85006   |         | 47902-13     | 83122   | 89406   | 60680-003L      | 83112   |         |
| 02-7005977   | 83400   |         | 35901-3420   | 85303   | 89422   | 47902-24     | 83137   |         | 60680-004       | 83143   |         |
| 04-9041375   | 85315   |         | 35901-4403   | 85060   |         | 47902-8      | 83122   | 89406   | 60680-004L      | 83143   |         |
| 10-13684-000 | 85918   | 89449   | 37301-3401   | 85053   | 89442   | 481700125969 | 85956   |         | 60680-005       | 83142   |         |
| 10-13809-000 | 85958   |         | 37301-3404   | 85053   | 89442   | 57241-1      | 83111   |         | 60680-005L      | 83142   |         |
| 1011839      | 83216   |         | 37301-3405   | 85053   | 89442   | 57252        | 85308   | 89422   | 615016          | 83401   |         |
| 16-15770-000 | 85956   |         | 37301-3409   | 85053   | 89442   | 57905-1      | 85976   |         | 665682          | 85053   | 89442   |
| 16-18706-000 | 85331   |         | 37301-3412   | 85053   | 89442   | 57905-2      | 85006   |         | 676081          | 83401   |         |
| 16-18708-000 | 85724   | 89443   | 37390-4401   | 85053   | 89442   | 58913-003    | 85932   | 89453   | 676082          | 83401   |         |
| 16725-01     | 83126   |         | 37390-4402   | 85053   | 89442   | 58913-003L   | 85932   | 89453   | 90044025        | 83209   | 89414   |
| 19495-01     | 83126   |         | 37390-4403   | 85053   | 89442   | 58913-012    | 85932   | 89453   | 90044907        | 83635   |         |
| 28R010       | 83216   |         | 471700000470 | 85918   | 89449   | 58913-012L   | 85932   | 89453   | 90045099        | 85906   | 89407   |
| 35066-4413   | 83122   | 89406   | 471700002809 | 85724   | 89443   | 60657-003    | 85072   |         | 90045605        | 85109   |         |
| 35901-0001   | 83209   | 89414   | 471700003920 | 85958   |         | 60657-003L   | 85072   |         | CP-5222         | 85315   |         |
| 35901-3406   | 85305   |         | 471700004423 | 85109   |         | 60675-002    | 85979   |         | SDA471700003920 | 85958   |         |
| 35901-3409   | 85304   |         | 471700006269 | 85932   | 89453   | 60675-002L   | 85979   |         | SDA481700125969 | 85956   |         |
| 35901-3410   | 85307   |         | 471700131331 | 85932   | 89453   | 60680-003    | 83112   |         |                 |         |         |

**Important Note:** Competitive Interchanges are to be used for stocking purposes only. Where multiple crosses are identified, please reference the applications section of this catalog. / **Remarque importante:** Les interchanges concurrentiels ne s'utilisent qu'aux fins de stocks. Dans le cas de références multiples, consulter la section des applications du catalogue. / **Nota importante:** Dans le cas de références multiples, consulter la section des applications du catalogue. / **Nota importante:** Se pueden usar intercambios competitivos para propósitos de almacenamiento solamente. Cuando se identifican intercambios múltiples, consulte la sección de aplicaciones de este catálogo.

**COMPETITIVE & O.E.M. INTERCHANGE LIST**  
**Lista de Intercambios contra Competidores y Equipo Original.**  
**Liste d'interchange de produits compétitifs & d'équipement original (OEM)**

**WESTERN STAR CAB SHOCKS**

| O.E.M #      | Gabriel | Upgrade | O.E.M #    | Gabriel | Upgrade | O.E.M #       | Gabriel | Upgrade | O.E.M #      | Gabriel | Upgrade |
|--------------|---------|---------|------------|---------|---------|---------------|---------|---------|--------------|---------|---------|
| 1201-0012    | 83023   |         | 617547     | 83022   |         | 66010-3405    | 83026   |         | 814903003501 | 83027   |         |
| 1202-0012    | 83023   |         | 654846     | 83027   |         | 66010-3406    | 83027   |         | GBL 654916   | 83026   |         |
| 1202-0032    | 83016   |         | 66010-3402 | 83022   |         | 66010-3407    | 83065   |         |              |         |         |
| 18-60772-000 | 83026   |         | 66010-3403 | 83022   |         | 725470        | 83010   |         |              |         |         |
| 18-60773-000 | 83027   |         | 66010-3404 | 83022   |         | 81-4903003500 | 83026   |         |              |         |         |

**WESTERN UNIT ``STABILAIR" SUSPENSION**

| O.E.M # | Gabriel | Upgrade | O.E.M # | Gabriel | Upgrade | O.E.M # | Gabriel | Upgrade | O.E.M # | Gabriel | Upgrade |
|---------|---------|---------|---------|---------|---------|---------|---------|---------|---------|---------|---------|
| 101030  | 85307   |         | 4939967 | 85308   | 89422   | 80600   | 85300   | 89419   |         |         |         |
| 101364  | 85305   |         | 80370   | 85304   |         |         |         |         |         |         |         |

**WESTPORT AXLE CORP**

| O.E.M #     | Gabriel | Upgrade | O.E.M # | Gabriel | Upgrade | O.E.M # | Gabriel | Upgrade | O.E.M # | Gabriel | Upgrade |
|-------------|---------|---------|---------|---------|---------|---------|---------|---------|---------|---------|---------|
| 143699-0185 | 646177  |         | 646124  | 646177  |         |         |         |         |         |         |         |

**WHEELED COACH IND**

| O.E.M #  | Gabriel | Upgrade | O.E.M #  | Gabriel | Upgrade | O.E.M # | Gabriel | Upgrade | O.E.M # | Gabriel | Upgrade |
|----------|---------|---------|----------|---------|---------|---------|---------|---------|---------|---------|---------|
| ASH-1136 | 83178   |         | ASH-1154 | 83177   |         |         |         |         |         |         |         |

**WINNEBAGO**

| O.E.M #       | Gabriel | Upgrade | O.E.M #       | Gabriel | Upgrade | O.E.M #   | Gabriel | Upgrade | O.E.M #        | Gabriel | Upgrade |
|---------------|---------|---------|---------------|---------|---------|-----------|---------|---------|----------------|---------|---------|
| 141700131809  | 85029   |         | 24-186629     | 85125   |         | ASH-1206  | 83122   | 89406   | F4-BE5-A011-HO | 85126   |         |
| 141700131810  | 83160   |         | 481700000493  | 85900   |         | ASH-1228  | 83209   | 89414   | F4-BE5-A832-MO | 85125   |         |
| 16-16736-000  | 85029   |         | 66153-002     | 83124   | 89407   | ASH-1229  | 83209   | 89414   | F4-BE5-B492-HO | 85125   |         |
| 16-16737-000  | 83160   |         | 9U94-18045-AA | 83209   | 89414   | ASH-1230  | 83122   | 89406   | F4-BE5-C832-MO | 83124   | 89407   |
| 16-16873-000  | 85029   |         | 9U94-18080-AA | 83122   | 89406   | ASH-137   | 83122   | 89406   | F4-BE5-F324-HO | 85125   |         |
| 16-16874-000  | 83160   |         | 9U9Z-18124-A  | 83209   | 89414   | ASH-25822 | 83209   | 89414   | F4-BE5-F325-HO | 85124   |         |
| 16-18103-000  | 85900   |         | 9U9Z-18125-A  | 83122   | 89406   | ASH-25823 | 83209   | 89414   | W0005662       | 85125   |         |
| 1C34-18045-AA | 83209   | 89414   | ASH-1022      | 83209   | 89414   | ASH-25824 | 83122   | 89406   | W0005663       | 85124   |         |
| 1C34-18045-JA | 83209   | 89414   | ASH-1023      | 83122   | 89406   | ASH-294   | 83209   | 89414   | W0006254       | 85125   |         |
| 24-153249     | 85125   |         | ASH-1136      | 83178   |         | AT-620    | 83209   | 89414   |                |         |         |
| 24-153256     | 85124   |         | ASH-1154      | 83177   |         | AT-621    | 83122   | 89406   |                |         |         |
| 24-186537     | 85126   |         | ASH-1205      | 83209   | 89414   | AT-766    | 83209   | 89414   |                |         |         |

**WORKHORSE**

| O.E.M #   | Gabriel | Upgrade | O.E.M #        | Gabriel | Upgrade | O.E.M #        | Gabriel | Upgrade | O.E.M #  | Gabriel | Upgrade |
|-----------|---------|---------|----------------|---------|---------|----------------|---------|---------|----------|---------|---------|
| 24-153249 | 85125   |         | 66153-002      | 83124   | 89407   | F4-BE5-C832-MO | 83124   | 89407   | W0007363 | 83171   |         |
| 24-153256 | 85124   |         | 680672         | 85919   |         | F4-BE5-F324-HO | 85125   |         | W0007365 | G63866  |         |
| 24-186537 | 85126   |         | 7805-X-1012    | 85919   |         | F4-BE5-F325-HO | 85124   |         | W0011635 | 83221   |         |
| 24-186629 | 85125   |         | F4-BE5-A011-HO | 85126   |         | W0005662       | 85125   |         | W0011636 | G63366  |         |
| 659222    | 83171   |         | F4-BE5-A832-MO | 85125   |         | W0005663       | 85124   |         | W8007000 | 83171   |         |
| 659223    | G63866  |         | F4-BE5-B492-HO | 85125   |         | W0006254       | 85125   |         |          |         |         |

**WORLD TRANS BUS CO.**

| O.E.M #  | Gabriel | Upgrade | O.E.M #  | Gabriel | Upgrade | O.E.M # | Gabriel | Upgrade | O.E.M # | Gabriel | Upgrade |
|----------|---------|---------|----------|---------|---------|---------|---------|---------|---------|---------|---------|
| ASH-1136 | 83178   |         | ASH-1154 | 83177   |         |         |         |         |         |         |         |

**Important Note:** Competitive Interchanges are to be used for stocking purposes only. Where multiple crosses are identified, please reference the applications section of this catalog. / **Remarque importante:** Les interchanges concurrentiels ne s'utilisent qu'aux fins de stocks. Dans le cas de références multiples, consulter la section des applications du catalogue. / **Nota Importante:** Dans le cas de références multiples, consulter la section des applications du catalogue. / **Nota Importante:** Se pueden usar intercambios competitivos para propósitos de almacenamiento solamente. Cuando se identifican intercambios múltiples, consulte la sección de aplicaciones de este catálogo.

# HOW TO DETERMINE THE CORRECT SHOCK FOR YOUR TRUCK

## CÓMO ESCOGER EL MEJOR AMORTIGUADOR PARA SU CAMIÓN

### COMMENT CHOISIR LE BON AMORTISSEUR POUR VOTRE CAMION

**Part Number:** The catalog number for the individual shock absorber.

**Extended Length\*:** The length of the shock absorber when it is fully extended. See "How to Measure" instructions.

**Collapsed Length\*:** The length of the shock absorber when it is fully collapsed. See "How to Measure" instructions

**Stroke:** This is the approximate length of the stroke of the individual shock absorber being described.

**Mounting Codes:** Indicates the type of mounting ends for the upper and lower end of each shock absorber.

They are listed as follows:

- Stud type mounts ("S" & "DS")
- Eye ring and bushing mounts ("EB")
- Eye ring and bushing with sleeve mounts ("ES")
- Eye ring and bushing with bar pin mounts ("BP")
- Special mounting codes ("SP")

**Número de parte:** El número de catálogo para el amortiguador individual.

**Longitud extendida\*:** La longitud del amortiguador cuando está totalmente extendido. Consulte las instrucciones "Cómo medir".

**Longitud colapsada\*:** La longitud del amortiguador cuando está totalmente colapsado. Consulte las instrucciones "Cómo medir".

**Carrera:** Esta es la longitud aproximada de la carrera del amortiguador individual que se está describiendo.

**Códigos de montura:** Indica el tipo de extremos de montura para el extremo superior e inferior de cada amortiguador.

Se enumeran de la siguiente manera:

- Monturas tipo perno ("S" y "DS")
- Monturas de anillo y casquillo ("EB")
- Monturas de anillo y casquillo con funda ("ES")
- Monturas de anillo y casquillo con pasador de barra ("BP")
- Códigos especiales de montura ("SP")

**Numéro de pièce :** Le numéro de catalogue pour l'amortisseur individuel.

**Longueur en extension\*:** La longueur de l'amortisseur lorsqu'il est en extension complète. Voir les instructions « Comment mesurer ».

**Longueur plié\*:** La longueur de l'amortisseur lorsqu'il est complètement plié. Voir les instructions « Comment mesurer ».

**Course:** Ceci est la longueur approximative de la course de l'amortisseur individuel décrit ici.

**Codes de fixation:** Indique le type d'extrémité de fixation pour l'extrémité supérieure et inférieure de chaque amortisseur.

Ils sont classés comme suit :

- Fixations à goujons (« S » et « DS »)
- Fixations à œillet et à douille (« EB »)
- Fixations à œillet et douille de glissement (« ES »)
- Fixations à œillet et à douille avec broche (« BP »)
- Codes de fixations spéciales (« SP »)

#### CONVERSION CHART | TABLA DE CONVERSIÓN | TABLEAU DE CONVERSION

| Fraction   Fracción | Decimal   Décimal | Metric   Métrico   Métrique | Fraction   Fracción | Decimal   Décimal | Metric   Métrico   Métrique |
|---------------------|-------------------|-----------------------------|---------------------|-------------------|-----------------------------|
| (INCHES)            | (INCHES)          | (MM)                        | (INCHES)            | (INCHES)          | (MM)                        |
| 1/64                | 0.016             | 0.397                       | 33/64               | 0.516             | 13.097                      |
| 1/32                | 0.031             | 0.794                       | 17/32               | 0.531             | 13.494                      |
| 3/64                | 0.047             | 1.191                       | 35/64               | 0.547             | 13.891                      |
| 1/16                | 0.063             | 1.588                       | 9/16                | 0.563             | 14.288                      |
| 5/64                | 0.078             | 1.984                       | 37/64               | 0.578             | 14.684                      |
| 3/32                | 0.094             | 2.381                       | 19/32               | 0.594             | 15.081                      |
| 7/64                | 0.109             | 2.778                       | 39/64               | 0.609             | 15.478                      |
| 1/8                 | 0.125             | 3.175                       | 5/8                 | 0.625             | 15.875                      |
| 9/64                | 0.141             | 3.572                       | 41/64               | 0.641             | 16.272                      |
| 5/32                | 0.156             | 3.969                       | 21/32               | 0.656             | 16.669                      |
| 11/64               | 0.172             | 4.366                       | 43/64               | 0.672             | 17.066                      |
| 3/16                | 0.188             | 4.763                       | 11/16               | 0.688             | 17.463                      |
| 13/64               | 0.203             | 5.159                       | 45/64               | 0.703             | 17.859                      |
| 7/32                | 0.219             | 5.556                       | 23/32               | 0.719             | 18.256                      |
| 15/64               | 0.234             | 5.953                       | 47/64               | 0.734             | 18.653                      |
| 1/4                 | 0.250             | 6.350                       | 3/4                 | 0.750             | 19.050                      |
| 17/64               | 0.266             | 6.747                       | 49/64               | 0.766             | 19.447                      |
| 9/32                | 0.281             | 7.144                       | 25/32               | 0.781             | 19.844                      |
| 19/64               | 0.297             | 7.541                       | 51/64               | 0.797             | 20.241                      |
| 5/16                | 0.313             | 7.938                       | 13/16               | 0.813             | 20.638                      |
| 21/64               | 0.328             | 8.334                       | 53/64               | 0.828             | 21.034                      |
| 11/32               | 0.344             | 8.731                       | 27/32               | 0.844             | 21.431                      |
| 23/64               | 0.359             | 9.128                       | 55/64               | 0.859             | 21.828                      |
| 3/8                 | 0.375             | 9.525                       | 7/8                 | 0.875             | 22.225                      |
| 25/64               | 0.391             | 9.922                       | 57/64               | 0.891             | 22.622                      |
| 13/32               | 0.406             | 10.319                      | 29/32               | 0.906             | 23.019                      |
| 27/64               | 0.422             | 10.716                      | 59/64               | 0.922             | 23.416                      |
| 7/16                | 0.438             | 11.113                      | 15/16               | 0.938             | 23.813                      |
| 29/64               | 0.453             | 11.509                      | 61/64               | 0.953             | 24.209                      |
| 15/32               | 0.469             | 11.906                      | 31/32               | 0.969             | 24.606                      |
| 31/64               | 0.484             | 12.303                      | 63/64               | 0.984             | 25.003                      |
| 1/2                 | 0.500             | 12.700                      | 1                   | 1.000             | 25.400                      |

#### METRIC CONVERSION CHART | TABLA DE CONVERSIÓN MÉTRICA | TABLEAU DE CONVERSION

| (MM) | (INCHES) | (MM) | (INCHES) | (MM) | (INCHES) |
|------|----------|------|----------|------|----------|
| 1    | 0.03937  | 10   | 0.39370  | 19   | 0.74803  |
| 2    | 0.07874  | 11   | 0.43307  | 20   | 0.78740  |
| 3    | 0.11811  | 12   | 0.47244  | 21   | 0.82677  |
| 4    | 0.15748  | 13   | 0.51181  | 22   | 0.86614  |
| 5    | 0.19685  | 14   | 0.55118  | 23   | 0.90551  |
| 6    | 0.23622  | 15   | 0.59055  | 24   | 0.94488  |
| 7    | 0.27559  | 16   | 0.62992  | 25   | 0.98425  |
| 8    | 0.31496  | 17   | 0.66929  |      |          |
| 9    | 0.35433  | 18   | 0.70866  |      |          |



# HOW TO DETERMINE THE CORRECT SHOCK FOR YOUR TRUCK

## CÓMO ESCOGER EL MEJOR AMORTIGUADOR PARA SU CAMIÓN COMMENT CHOISIR LE BON AMORTISSEUR POUR VOTRE CAMION

**STEP 1:** Measure the diameter of the dust tube and cylinder to determine the series.

**1<sup>ER</sup> PASO:** Mida el diámetro del tubo de polvo y del cilindro para determinar la serie.

**1<sup>RE</sup> ÉTAPE:** Mesurez le diamètre du tube de poussière et du cylindre pour déterminer la série.

### EXTERNAL DIMENSIONS DIMENSIONES EXTERNAS DIMENSIONS EXTÉRIEURES

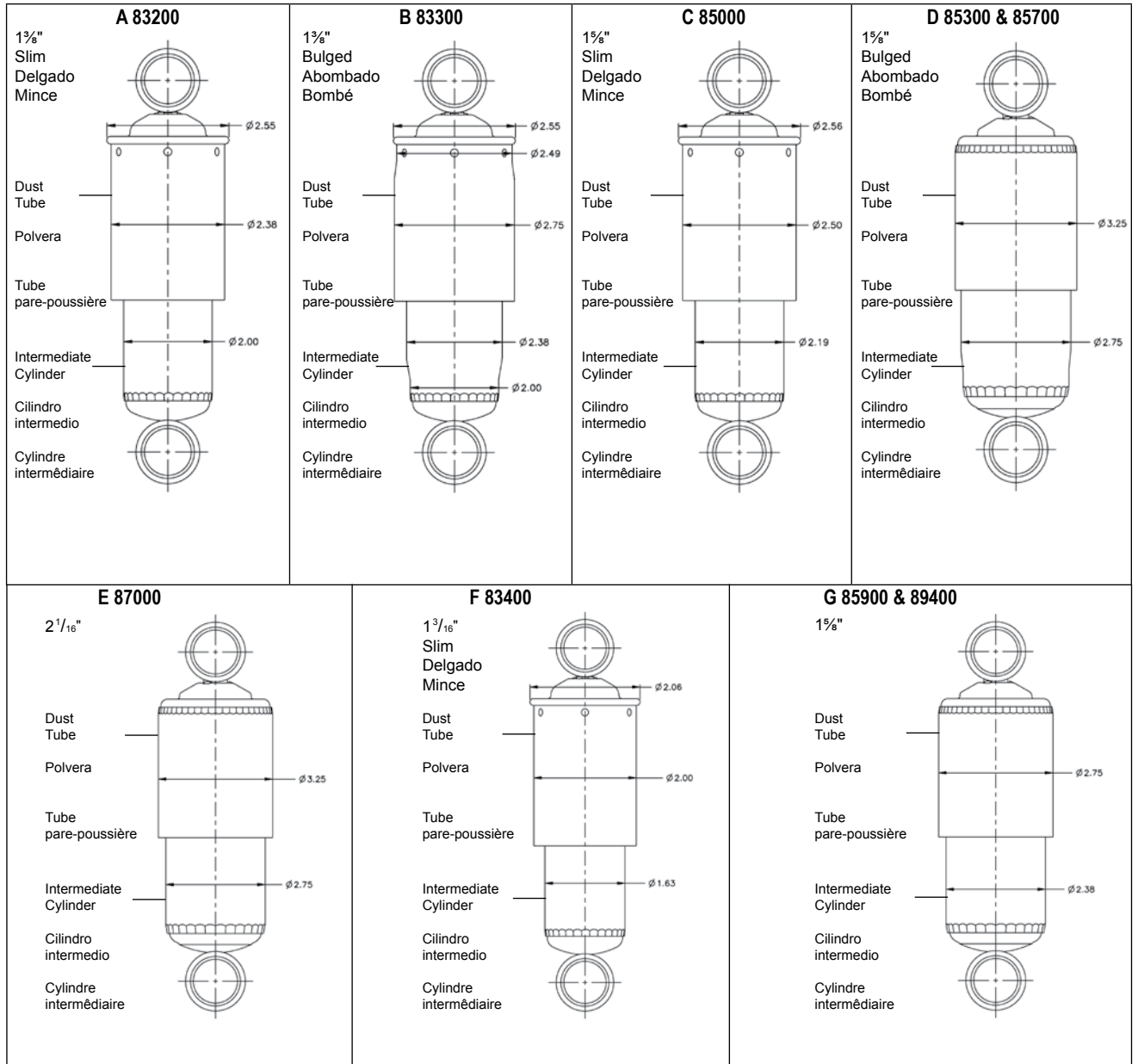

# HOW TO DETERMINE THE CORRECT SHOCK FOR YOUR TRUCK

## CÓMO ESCOGER EL MEJOR AMORTIGUADOR PARA SU CAMIÓN COMMENT CHOISIR LE BON AMORTISSEUR POUR VOTRE CAMION

- STEP 2:** Identify the mounting style. Measure fully extended and fully collapsed lengths at the locations indicated for mounting style.
- 2º PASO:** Identifique el tipo de montaje. Mida la longitud totalmente extendida y totalmente comprimida, en los puntos indicados para cada tipo de montaje.
- 2È ÉTAPE:** Identifiez la méthode de fixation. Mesurez la longueur en pleine extension et en pleine compression, aux endroits indiqués pour la méthode de fixation.

### HOW TO MEASURE EXTENDED & COLLAPSED LENGTHS OF SHOCK ABSORBERS COMO MEDIR LAS LONGITUDES EXTENDIDA Y COMPRIMIDA DE LOS AMORTIGUADORES COMMENT MESURER LES LONGUEURS ALLONGÉ ET COMPRIMÉ DES AMORTISSEURS

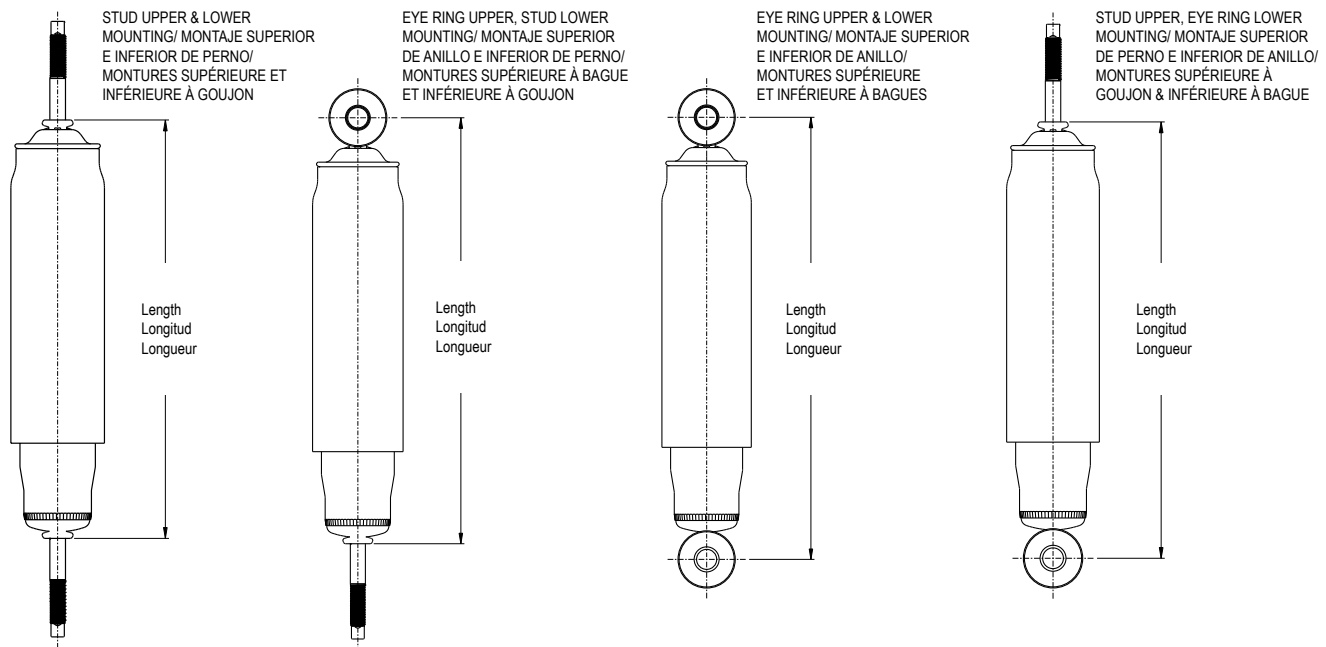

#### INSTRUCTIONS:

- Using the proper measuring points as shown above find the nearest replacement shock absorber from the listing by increments of extended length.
- Identify the proper mounting from the mounting codes and match these requirements by carefully measuring the mounting dimensions (top and bottom) of the shock absorber to be replaced.
- Carefully take note of the following requirements:
  - Dust tubes** - This requirement should be noted in comparison with the shock absorber to be replaced. Shock absorber environment in its application makes this requirement necessary for piston rod protection and extended shock absorber life.
  - Recoil Cutoff and Compression Bumper** - Carefully note these specifications - deviation of length requirements should not exceed  $\pm 1/4$ ". These shock absorber designs are footnoted for easy identification.

**Note:** Shock absorbers used for installations other than those recommended in our catalog are **not subject to warranty**.

#### INSTRUCCIONES:

- Usando los puntos de medida adecuados como mencionado, encuentre el amortiguador más cercano en la lista por incrementos de la longitud extendida.
- Identifique la montaje adecuado por medio de los códigos de fijación y compare estas especificaciones, midiendo cuidadosamente las dimensiones de la montaje (superior e inferior) del amortiguador por reemplazar.
- Note cuidadosamente las exigencias siguientes:
  - Polvera** - Este componente debe estar presente en el amortiguador por reemplazar. El ambiente de trabajo del amortiguador hacen a la polvera necesaria para proteger la barra del pistón y extender la vida del producto.
  - Tope de retorno y tope de compresión** - Note cuidadosamente las especificaciones siguientes : las exigencias de longitud no deben de ser excedidas  $\pm 1/4$ ". Estos diseños de amortiguadores están marcados para facilitar su identificación.

**Nota:** Los amortiguadores usados para instalaciones otras que las recomendadas en nuestro catálogo **no son garantizados**.

#### INSTRUCTIONS:

- En utilisant les points de mesure appropriés comme indiqués ci-dessus, trouvez l'amortisseur de rechange le plus près de cette mesure d'après la longueur allongée.
- Repérez les montures appropriées sur les codes des montures et faites correspondre ces exigences en mesurant attentivement les dimensions des montures (haut et bas) de l'amortisseur à replacer.
- Avec soin, prenez note des exigences suivantes:
  - Tubes pare-poussière** - Cette exigence devrait être notée en comparaison de l'amortisseur à remplacer. Le milieu de service rend cette exigence nécessaire pour la protection de la tige de piston et une meilleure longévité de l'amortisseur.
  - Arrêt de retour et butée de compression** - Notez avec soin ces spécifications. La déviation par rapport aux exigences de longueurs ne doit pas dépasser  $\pm 1/4$  po. Ces modèles d'amortisseurs portent une note pour une identification facile.

**Note:** Les amortisseurs utilisés pour des installations autres que celles recommandées dans notre catalogue **ne sont pas couverts par la garantie**.

# HOW TO DETERMINE THE CORRECT SHOCK FOR YOUR TRUCK

## CÓMO ESCOGER EL MEJOR AMORTIGUADOR PARA SU CAMIÓN COMMENT CHOISIR LE BON AMORTISSEUR POUR VOTRE CAMION

**STEP 3:** Measure end mount diameters, widths, and lengths. Refer to the following end mount tables to determine the appropriate or matching mounting code.

**3ER PASO:** Mida las dimensiones del tubo, así como el diámetro, la anchura y la longitud de las fijaciones. Consulte las tablas siguientes de conteras para determinar el código de montaje apropiado o concorde.

**3E ÉTAPE:** Mesurez le diamètre, la largeur et la longueur des bagues. Consultez les tableaux d'embouts suivants afin d'établir le code de montage approprié ou concordant.

### MOUNTING CODE "EB" EYE RING AND BUSHING CODIGO DE FIJACION «EB» ANILLO Y BUJE CODE DE MONTURE "EB" À BAGUE ET MANCHON

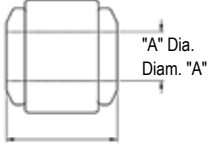
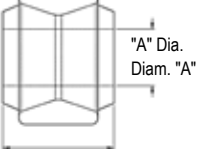
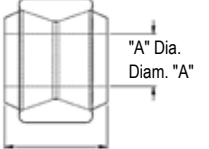
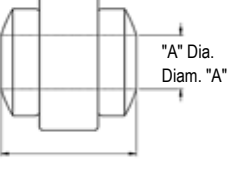
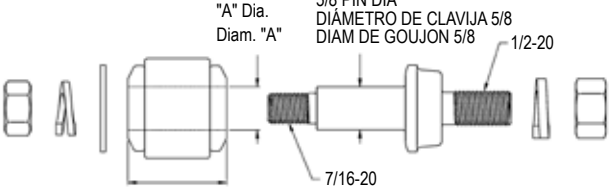
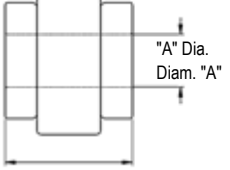
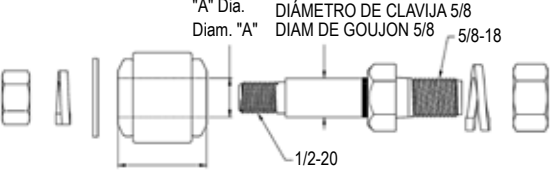
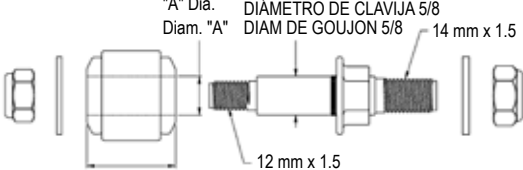
|   |  |   |  |
|---|--|---|--|
| <p><b>EB1</b></p>  <p>"A" Dia.<br/>Diam. "A"</p> <p>FREE LENGTH "B"<br/>COMP LENGTH "C"<br/>LONGITUD LIBRE "B"<br/>LONGITUD COMPRIMIDA "C"<br/>LONGUEUR NON COMP "B"<br/>LONGUEUR COMP "C"</p>   | <p><b>EB2</b></p>  <p>"A" Dia.<br/>Diam. "A"</p> <p>FREE LENGTH "B"<br/>COMP LENGTH "C"<br/>LONGITUD LIBRE "B"<br/>LONGITUD COMPRIMIDA "C"<br/>LONGUEUR NON COMP "B"<br/>LONGUEUR COMP "C"</p>   | <p><b>EB3</b></p>  <p>"A" Dia.<br/>Diam. "A"</p> <p>FREE LENGTH "B"<br/>COMP LENGTH "C"<br/>LONGITUD LIBRE "B"<br/>LONGITUD COMPRIMIDA "C"<br/>LONGUEUR NON COMP "B"<br/>LONGUEUR COMP "C"</p> |  |
| <p><b>EB4</b></p>  <p>"A" Dia.<br/>Diam. "A"</p> <p>FREE LENGTH "B"<br/>COMP LENGTH "C"<br/>LONGITUD LIBRE "B"<br/>LONGITUD COMPRIMIDA "C"<br/>LONGUEUR NON COMP "B"<br/>LONGUEUR COMP "C"</p>  | <p><b>EB6</b></p>  <p>"A" Dia.<br/>Diam. "A"</p> <p>5/8 PIN DIA<br/>DIÁMETRO DE CLAVIJA 5/8<br/>DIAM DE GOUJON 5/8</p> <p>1/2-20</p> <p>7/16-20</p> <p>FREE LENGTH "B"<br/>COMP LENGTH "C"<br/>LONGITUD LIBRE "B"<br/>LONGITUD COMPRIMIDA "C"<br/>LONGUEUR NON COMP "B"<br/>LONGUEUR COMP "C"</p> |   |  |
| <p><b>EB5</b></p>  <p>"A" Dia.<br/>Diam. "A"</p> <p>FREE LENGTH "B"<br/>COMP LENGTH "C"<br/>LONGITUD LIBRE "B"<br/>LONGITUD COMPRIMIDA "C"<br/>LONGUEUR NON COMP "B"<br/>LONGUEUR COMP "C"</p>   | <p><b>EB7</b></p>  <p>"A" Dia.<br/>Diam. "A"</p> <p>5/8 PIN DIA<br/>DIÁMETRO DE CLAVIJA 5/8<br/>DIAM DE GOUJON 5/8</p> <p>1/2-20</p> <p>5/8-18</p> <p>FREE LENGTH "B"<br/>COMP LENGTH "C"<br/>LONGITUD LIBRE "B"<br/>LONGITUD COMPRIMIDA "C"<br/>LONGUEUR NON COMP "B"<br/>LONGUEUR COMP "C"</p> |   |  |
| <p><b>EB8</b></p>  <p>"A" Dia.<br/>Diam. "A"</p> <p>5/8 PIN DIA<br/>DIÁMETRO DE CLAVIJA 5/8<br/>DIAM DE GOUJON 5/8</p> <p>12 mm x 1.5</p> <p>14 mm x 1.5</p> <p>FREE LENGTH "B"<br/>COMP LENGTH "C"<br/>LONGITUD LIBRE "B"<br/>LONGITUD COMPRIMIDA "C"<br/>LONGUEUR NON COMP "B"<br/>LONGUEUR COMP "C"</p> |  |   |  |

# HOW TO DETERMINE THE CORRECT SHOCK FOR YOUR TRUCK

## CÓMO ESCOGER EL MEJOR AMORTIGUADOR PARA SU CAMIÓN COMMENT CHOISIR LE BON AMORTISSEUR POUR VOTRE CAMION

### MOUNTING CODE "EB" EYE RING AND BUSHING (Cont'd)

#### CÓDIGO DE MONTAJE «EB» ANILLO Y BUJE

#### CODE DE MONTURE "EB" A BAGUE ET MANCHON

| Mounting Code<br>Código de montaje<br>Code de monture | "A" Dia.<br>Diámetro "A"<br>Diam. "A" | B<br>Free Length<br>Longitud libre<br>Long. non comp. | C<br>Comp. Length<br>Longitud comprimida<br>Long. comp. | Vehicle Mounting Pin Dia.<br>Diámetro de clavija de montaje del vehículo<br>Diam. du goujon de montage du véhicule  |
|---|---------------------------------------|---|---|---|
| EB1   | 5/8                                   | 1.44  | 1.31  | 5/8   |
| EB2   | 3/4                                   | 1.75  | 1.50  | 3/4   |
| EB3   | 1.00                                  | 1.91  | 1.75  | 1.00  |
| EB4   | 11/16                                 | 1.72  | 1.55  | 11/16   |
| EB5   | 5/8                                   | 1.51  | 1.25  | 5/8   |
| EB6   | 5/8                                   | 1.44  | 1.31  | Mounting pin furnished with shock absorber for 1/2" dia. vehicle mounting hole.<br>Perno proveído con el amortiguador para orificio de montaje de 1/2" de diámetro.<br>Goujon de montage fourni avec l'amortisseur pour trou de montage de 1/2 po de diam. sur véhicule.  |
| EB7   | 5/8                                   | 1.44  | 1.31  | Mounting pin furnished with shock absorber for 5/8" dia. vehicle mounting hole.<br>Perno proveído con el amortiguador para orificio de montaje de 5/8" de diámetro.<br>Goujon de montage fourni avec l'amortisseur pour trou de montage de 5/8 po de diam. sur véhicule.  |
| EB8   | 5/8                                   | 1.44  | 1.31  | Mounting pin furnished with shock absorber for 14 mm dia. vehicle mounting hole.<br>Perno proveído con el amortiguador para orificio de montaje de 14 mm de diámetro.<br>Goujon de montage fourni avec l'amortisseur pour trou de montage de 14 mm de diam. sur véhicule. |
| EB9   | 1                                     | 1.75  | --  | 1   |
| EB10  | 1.00                                  | 1.00  | --  | 1.00  |
| EB11  | 3/8                                   | 0.83  | --  | 3/8   |
| EB12  | 10MM                                  | 1.18  | --  | 10MM  |
| EB13  | 12MM                                  | 1.03  | --  | 12MM  |
| EB14  | 15MM                                  | 1.41  | --  | 15MM  |
| EB15  | 15MM                                  | 1.76  | --  | 15MM  |
| EB16  | 16MM                                  | 1.5   | --  | 16MM  |
| EB17  | 17MM                                  | 1.18  | --  | 17MM  |
| EB18  | 19MM                                  | 1.65  | --  | 19MM  |
| EB19  | 20MM                                  | 1.75  | --  | 20MM  |
| EB20  | 45/64                                 | 1.05  | --  | 45/64   |
| EB21  | 45/64                                 | 1.39  | --  | 45/64   |

# HOW TO DETERMINE THE CORRECT SHOCK FOR YOUR TRUCK

## CÓMO ESCOGER EL MEJOR AMORTIGUADOR PARA SU CAMIÓN

### COMMENT CHOISIR LE BON AMORTISSEUR POUR VOTRE CAMION

#### MOUNTING CODE "ES" & "CB" EYE RING AND BUSHING WITH STEEL SLEEVE

CÓDIGO DE MONTAJE «ES» Y «CB» ANILLO Y BUJE CON CAMISA DE ACERO

CODE DE MONTURE "ES" & "CB" BAGUE ET MANCHON AVEC COLLET EN ACIER

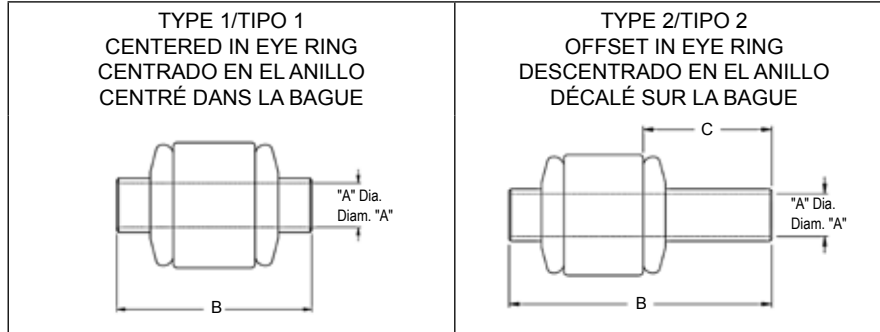

| MOUNTING CODE | TYPE | DIMENSION |      |      | MOUNTING CODE | TYPE | DIMENSION |      |      | MOUNTING CODE | TYPE | DIMENSION |      |      |
|---------------|------|-----------|------|------|---------------|------|-----------|------|------|---------------|------|-----------|------|------|
|               |      | A         | B    | C    |               |      | A         | B    | C    |               |      | A         | B    | C    |
| ES1           | 1    | 10MM      | 1.25 | --   | ES48          | 1    | 14MM      | 1.42 | --   | ES95          | 1    | 41/64     | 2    | --   |
| ES2           | 1    | 10MM      | 1.42 | --   | ES49          | 1    | 14MM      | 1.66 | --   | ES96          | 1    | 45/64     | 1.57 | --   |
| ES3           | 1    | 10MM      | 1.56 | --   | ES50          | 1    | 14MM      | 1.81 | --   | ES99          | 1    | 14MM      | 1.42 | --   |
| ES4           | 2    | 1/2       | 2.20 | 0.77 | ES51          | 1    | 14MM      | 1.89 | --   | ES102         | 1    | 10MM      | 1.77 | --   |
| ES5           | 1    | 10MM      | 2.07 | --   | ES52          | 1    | 14MM      | 1.96 | --   | ES104         | 1    | 20MM      | 1.58 | --   |
| ES6           | 1    | 10MM      | 2.35 | --   | ES53          | 1    | 10MM      | 1.38 | --   | ES106         | 1    | 10MM      | 1.48 | --   |
| ES7           | 1    | 9/16      | 1.25 | --   | ES54          | 1    | 12MM      | 2.91 | --   | ES107         | 1    | 12MM      | 2.15 | --   |
| ES8           | 1    | 7/16      | 1.25 | --   | ES55          | 1    | 14MM      | 2    | --   | ES109         | 1    | 10MM      | 0.95 | --   |
| ES9           | 1    | 7/16      | 1.31 | --   | ES56          | 1    | 14MM      | 1.58 | --   | ES110         | 1    | 16MM      | 1.61 | --   |
| ES10          | 1    | 7/16      | 1.38 | --   | ES57          | 1    | 10MM      | 1.03 | --   | ES111         | 1    | 9MM       | 1.78 | --   |
| ES11          | 1    | 7/16      | 1.50 | --   | ES58          | 1    | 14MM      | 2.13 | --   | ES112         | 1    | 12MM      | 1.08 | --   |
| ES12          | 1    | 7/16      | 1.62 | --   | ES59          | 1    | 15MM      | 1.56 | --   | ES113         | 1    | 16MM      | 1.49 | --   |
| ES13          | 1    | 9/16      | 1.89 | --   | ES60          | 1    | 14MM      | 1.26 | --   | ES114         | 1    | 12MM      | 2.04 | --   |
| ES14          | 1    | 7/16      | 1.88 | --   | ES61          | 1    | 12MM      | 1.76 | --   | ES115         | 1    | 10MM      | 2.02 | --   |
| ES15          | 1    | 9/16      | 2.79 | --   | ES62          | 1    | 12MM      | 0.98 | --   | ES118         | 1    | 12MM      | 1.31 | --   |
| ES16          | 1    | 7/16      | 3.15 | --   | ES63          | 1    | 15MM      | 2.28 | --   | ES120         | 1    | 3/4       | 2.76 | --   |
| ES17          | 1    | 12MM      | 1.25 | --   | ES64          | 1    | 16MM      | 1.25 | --   | ES121         | 1    | 3/4       | 2.06 | --   |
| ES18          | 1    | 12MM      | 1.65 | --   | ES65          | 1    | 12MM      | 1.38 | --   | ES123         | 1    | 16MM      | 1.57 | --   |
| ES19          | 1    | 12MM      | 1.88 | --   | ES66          | 1    | 16MM      | 1.38 | --   | ES126         | 1    | 1/2       | 2.44 | --   |
| ES20          | 1    | 12MM      | 1.95 | --   | ES67          | 1    | 16MM      | 1.56 | --   | ES128         | 1    | 1/2       | 1.66 | --   |
| ES21          | 1    | 12MM      | 2.28 | --   | ES68          | 1    | 9/16      | 1.35 | --   | ES130         | 1    | 1/2       | 1.56 | --   |
| ES22          | 1    | 1/2       | 1.25 | --   | ES69          | 1    | 12MM      | 1.58 | --   | ES133         | 1    | 12MM      | 1.93 | --   |
| ES23          | 1    | 1/2       | 1.31 | --   | ES70          | 2    | 7/16      | 1.88 | 0.70 | ES136         | 1    | 5/8       | 1.75 | --   |
| ES24          | 1    | 1/2       | 1.38 | --   | ES71          | 1    | 15MM      | 2.15 | --   | ES137         | 1    | 1/2       | 1.73 | --   |
| ES25          | 1    | 1/2       | 1.50 | --   | ES72          | 1    | 16MM      | 1.65 | --   | ES138         | 1    | 5/8       | 1.70 | --   |
| ES26          | 1    | 1/2       | 1.56 | --   | ES73          | 1    | 16MM      | 1.74 | --   | ES139         | 1    | 12MM      | 1.35 | --   |
| ES27          | 1    | 1/2       | 1.62 | --   | ES74          | 1    | 16MM      | 1.93 | --   | ES141         | 1    | 12MM      | 1.61 | --   |
| ES28          | 1    | 9/16      | 3.15 | --   | ES75          | 1    | 16MM      | 2.04 | --   | ES142         | 1    | 16MM      | 1.43 | --   |
| ES29          | 1    | 10MM      | 2.95 | --   | ES76          | 1    | 17/32     | 1.49 | --   | ES143         | 1    | 9/16      | 1.60 | --   |
| ES30          | 1    | 12MM      | 2.57 | --   | ES77          | 1    | 20MM      | 2.35 | --   | ES145         | 1    | 7/16      | 2.25 | --   |
| ES31          | 2    | 1/2       | 2.25 | 1.00 | ES78          | 1    | 10MM      | 1.92 | --   | ES146         | 1    | 12MM      | 1.37 | --   |
| ES32          | 1    | 1/2       | 3.34 | --   | ES79          | 1    | 21/32     | 1.58 | --   | ES147         | 1    | 12MM      | 1.97 | --   |
| ES33          | 1    | 12MM      | 3.15 | --   | ES80          | 2    | 25/32     | 1.69 | 0.07 | ES149         | 1    | 1/2       | 2.36 | --   |
| ES34          | 1    | 9/16      | 1.66 | --   | ES81          | 1    | 31/64     | 1.26 | --   | ES150         | 1    | 3/4       | 2.24 | --   |
| ES35          | 1    | 5/8       | 1.38 | --   | ES82          | 1    | 31/64     | 1.53 | --   | ES152         | 1    | 20MM      | 1.69 | --   |
| ES36          | 1    | 3/4       | 1.75 | --   | ES83          | 1    | 12MM      | 1.48 | --   | ES153         | 1    | 14MM      | 1.55 | --   |
| ES37          | 1    | 12MM      | 1.01 | --   | ES84          | 1    | 10MM      | 1.62 | --   | ES157         | 2    | 1/2       | 2.05 | 0.95 |
| ES38          | 1    | 7/16      | 2.18 | --   | ES85          | 1    | 12MM      | 2.36 | --   | ES158         | 1    | 3/4       | 3.80 | --   |
| ES39          | 1    | 10MM      | 1.31 | --   | ES86          | 1    | 14MM      | 2.44 | --   | ES159         | 2    | 3/4       | 3.21 | 1.03 |
| ES40          | 1    | 7/16      | 3.38 | --   | ES87          | 1    | 31/64     | 1.65 | --   | ES160         | 1    | 1.00      | 2.01 | --   |
| ES41          | 1    | 12MM      | 3.48 | --   | ES88          | 1    | 12MM      | 1.81 | --   | ES161         | 1    | 16MM      | 3.95 | --   |
| ES42          | 1    | 12MM      | 3.77 | --   | ES89          | 1    | 39/64     | 2.16 | --   | ES162         | 1    | 16MM      | 2.60 | --   |
| ES43          | 1    | 13MM      | 1.31 | --   | ES90          | 1    | 5/8       | 2.00 | --   | ES163         | 1    | 7/16      | 2.50 | --   |
| ES44          | 1    | 10MM      | 2.28 | --   | ES91          | 1    | 1/2       | 2.10 | --   | ES164         | 1    | 1/2       | 2.26 | --   |
| ES45          | 1    | 13MM      | 1.68 | --   | ES92          | 2    | 39/64     | 2.20 | 0.88 | ES165         | 1    | 1/2       | 1.75 | --   |
| ES46          | 1    | 13MM      | 1.73 | --   | ES93          | 2    | 39/64     | 2.57 | 0.79 | ES166         | 1    | 5/8       | 2.97 | --   |
| ES47          | 1    | 13MM      | 2.50 | --   | ES94          | 1    | 1/2       | 2.15 | --   | ES167         | 1    | 14MM      | 2.31 | --   |

# HOW TO DETERMINE THE CORRECT SHOCK FOR YOUR TRUCK

## CÓMO ESCOGER EL MEJOR AMORTIGUADOR PARA SU CAMIÓN COMMENT CHOISIR LE BON AMORTISSEUR POUR VOTRE CAMION

### MOUNTING CODE "ES" & "CB" EYE RING AND BUSHING WITH STEEL SLEEVE (Cont'd)

CÓDIGO DE MONTAJE «ES» Y «CB» ANILLO Y BUJE CON CAMISA DE ACERO

CODE DE MONTURE "ES" & "CB" BAGUE ET MANCHON AVEC COLLET EN ACIER

| MOUNTING CODE | TYPE | DIMENSION |      |    | MOUNTING CODE | TYPE | DIMENSION |      |    | MOUNTING CODE | TYPE | DIMENSION |      |    |
|---------------|------|-----------|------|----|---------------|------|-----------|------|----|---------------|------|-----------|------|----|
|               |      | A         | B    | C  |               |      | A         | B    | C  |               |      | A         | B    | C  |
| ES168         | 1    | 14MM      | 2.62 | -- | ES177         | 1    | 16MM      | 3.55 | -- | ES187         | 1    | 1.00      | 1.75 | -- |
| ES169         | 1    | 14MM      | 1.91 | -- | ES178         | 1    | 3/4       | 1.96 | -- | ES188         | 1    | 16MM      | 1.81 | -- |
| ES171         | 1    | 1/2       | 1.88 | -- | ES179         | 1    | 20MM      | 1.75 | -- | ES190         | 1    | 22MM      | 1.75 | -- |
| ES172         | 1    | 1/2       | 2.72 | -- | ES181         | 1    | 7/16      | 1.98 | -- | ES191         | 1    | 1.00      | 2.44 | -- |
| ES173         | 1    | 7/8       | 2.28 | -- | ES182         | 1    | 20MM      | 1.96 | -- | ES192         | 1    | 24MM      | 2.44 | -- |
| ES174         | 1    | 5/8       | 3.25 | -- | ES183         | 1    | 20MM      | 3.80 | -- | ES193         | 1    | 24MM      | 2.28 | -- |
| ES175         | 1    | 16MM      | 1.96 | -- | ES184         | 1    | 20MM      | 2.44 | -- | ES194         | 1    | 7/8       | 2.28 | -- |
| ES176         | 1    | 16MM      | 3.72 | -- | ES185         | 1    | 12MM      | 2.44 | -- | ES195         | 1    | 20MM      | 4.07 | -- |

### MOUNTING CODE "BP" EYE RING AND BUSHING WITH BAR PIN

CÓDIGO DE MONTAJE «BP» ANILLO Y BUJE CON CLAVIJA TIPO BARRA

CODE DE MONTURE "BP" BAGUE ET MANCHON AVEC GOUPILLE

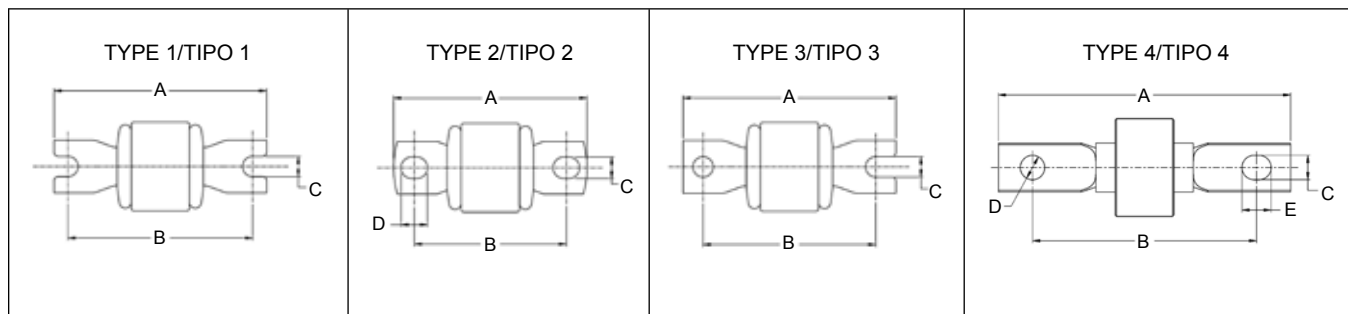

| MOUNTING CODE | TYPE | A    | B    | C    | D    | E    | MOUNTING CODE | TYPE | A    | B    | C    | D    | E  |
|---------------|------|------|------|------|------|------|---------------|------|------|------|------|------|----|
| BP1           | 1    | 2.72 | 2.20 | 0.33 | --   | --   | BP17          | 1    | 3.11 | 2.61 | 0.33 | --   | -- |
| BP2           | 1    | 3.59 | 3.12 | 0.32 | --   | --   | BP18          | 1    | 3.75 | 3.14 | 0.39 | --   | -- |
| BP3           | 1    | 2.82 | 2.38 | 0.33 | --   | --   | BP19          | 1    | 3.19 | 2.62 | 0.33 | --   | -- |
| BP4           | 1    | 3.19 | 2.38 | 0.33 | --   | --   | BP20          | 1    | 3.59 | 3.12 | 0.33 | --   | -- |
| BP5           | 1    | 3.19 | 2.75 | 0.33 | --   | --   | BP26          | 3    | 3.06 | 2.37 | 0.26 | --   | -- |
| BP6           | 1    | 4.25 | 3.62 | 0.33 | --   | --   | BP27          | 2    | 4.00 | 2.95 | 0.52 | 0.50 | -- |
| BP7           | 2    | 3.13 | 2.50 | 0.35 | 0.42 | --   | BP29          | 2    | 4.00 | 2.95 | 0.37 | 0.49 | -- |
| BP8           | 2    | 3.50 | 2.87 | 0.35 | 0.42 | --   | BP30          | 1    | 3.00 | 2.25 | 0.34 | --   | -- |
| BP9           | 1    | 3.38 | 2.60 | 0.35 | 0.57 | --   | BP31          | 3    | 3.50 | 2.87 | 0.35 | --   | -- |
| BP10          | 2    | 3.5  | 2.74 | 0.50 | 0.50 | --   | BP32          | 2    | 3.45 | 2.83 | 0.42 | --   | -- |
| BP11          | 1    | 2.96 | 2.52 | 0.33 | --   | --   | BP33          | 2    | 4.44 | 3.62 | 0.39 | 0.47 | -- |
| BP12          | 1    | 3.75 | 3.14 | 0.33 | --   | --   | BP34          | 1    | 3.81 | 2.99 | 0.41 | --   | -- |
| BP13          | 1    | 3.45 | 3.00 | 0.33 | --   | --   | BP35          | 2    | 3.53 | 2.73 | 0.38 | 0.38 | -- |
| BP14          | 2    | 3.43 | 2.87 | 0.45 | --   | --   | BP36          | 2    | 4.72 | 3.38 | 0.52 | 0.52 | -- |
| BP15          | 4    | 4.56 | 3.62 | 0.39 | 0.47 | 0.39 |               |      |      |      |      |      |    |

# HOW TO DETERMINE THE CORRECT SHOCK FOR YOUR TRUCK

## CÓMO ESCOGER EL MEJOR AMORTIGUADOR PARA SU CAMIÓN

### COMMENT CHOISIR LE BON AMORTISSEUR POUR VOTRE CAMION

#### MOUNTING CODES "S" & "DS" STUD MOUNTS

#### CÓDIGOS DE MONTAJE «S» Y «DS» MONTAJES DE DOBLE PERNO

#### CODES DE MONTURE "S" & "DS" À GOUJON

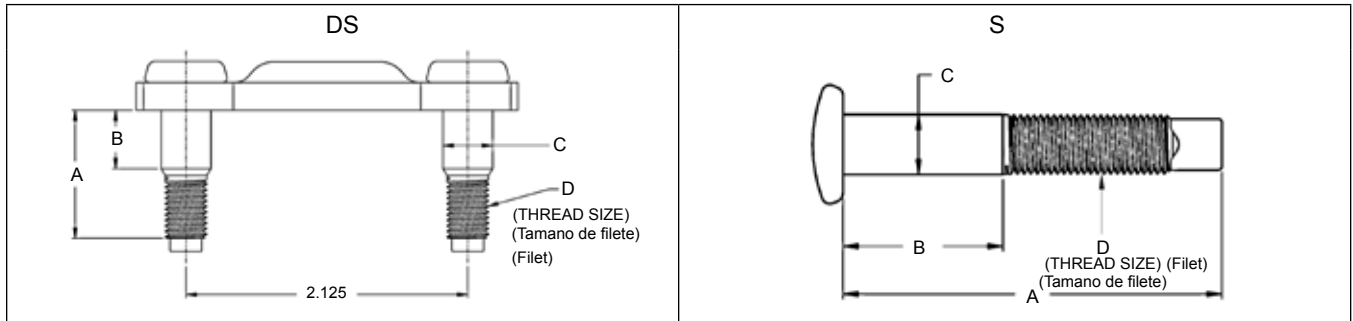

| MOUNTING CODE | A    | B    | C    | D        |
|---------------|------|------|------|----------|
| <b>DS1</b>    | 1.27 | 0.66 | 3/8  | 5/16-24  |
| <b>S1</b>     | 2.37 | 1.00 | 3/8  | 3/8-24   |
| <b>S2</b>     | 2.06 | 1.00 | 3/8  | 3/8-24   |
| <b>S3</b>     | 2.67 | 1.37 | 10MM | 3/8-16   |
| <b>S4</b>     | 1.85 | 1.00 | 3/8  | 3/8-24   |
| <b>S5</b>     | 1.29 | 1.14 | 13MM | 3/8-24   |
| <b>S6</b>     | 2.47 | 1.47 | 7/16 | 3/8-24   |
| <b>S7</b>     | 1.97 | 1.00 | 3/8  | 3/8-24   |
| <b>S8</b>     | 1.75 | 1.00 | 10MM | 3/8-24   |
| <b>S9</b>     | 1.84 | 1.05 | 7/16 | 3/8-24   |
| <b>S10</b>    | 2.37 | 1.33 | 7/16 | 3/8-24   |
| <b>S11</b>    | 3.00 | 1.12 | 3/8  | 3/8-24   |
| <b>S12</b>    | 2.37 | 1.15 | 7/16 | 3/8-24   |
| <b>S13</b>    | 2.06 | 1.35 | 3/8  | 3/8-24   |
| <b>S14</b>    | 2.25 | 1.33 | 7/16 | 3/8-24   |
| <b>S15</b>    | 3.29 | 1.98 | 3/8  | 3/8-24   |
| <b>S16</b>    | 2.95 | 1.45 | 16MM | 16MM     |
| <b>S17</b>    | 2.15 | 1.03 | 7/16 | 3/8-24   |
| <b>S18</b>    | 2.67 | 1.81 | 10MM | M10x1.25 |
| <b>S19</b>    | 1.34 | 0.41 | 7/16 | M10x1    |
| <b>S20</b>    | 1.34 | 0.41 | 10MM | M10x1    |
| <b>S21</b>    | 3.28 | 1.75 | 5/8  | 5/8-18   |
| <b>S22</b>    | 0.75 | 0.35 | 10MM | M10x1    |
| <b>S23</b>    | 1.84 | 1.05 | 3/8  | 3/8-24   |
| <b>S24</b>    | 1.22 | 0.31 | 11MM | M10x1    |
| <b>S25</b>    | 1.81 | 1.50 | 3/8  | M10x1    |
| <b>S26</b>    | 2.02 | 0.82 | 12MM | M10x1    |
| <b>S27</b>    | 2.36 | 1.14 | 10MM | M10x1    |
| <b>S28</b>    | 2.44 | 1.37 | 12MM | M10x1    |
| <b>S29</b>    | 2.99 | 1.87 | 3/8  | 3/8-24   |
| <b>S30</b>    | 2.59 | 1.41 | 10MM | M10x1    |
| <b>S31</b>    | 0.79 | 0.40 | 17MM | 10MM     |
| <b>S32</b>    | 2.31 | 1.38 | 14MM | 12MM     |
| <b>S33</b>    | 3.44 | 2.17 | 10MM | M10x1    |
| <b>S34</b>    | 1.06 | 0.59 | 5/16 | M8x1.25  |
| <b>S35</b>    | 2.60 | 1.12 | 7/16 | 3/8-24   |

| MOUNTING CODE | A    | B    | C     | D        |
|---------------|------|------|-------|----------|
| <b>S36</b>    | 2.49 | 1.33 | 7/16  | 3/8-24   |
| <b>S37</b>    | 3.18 | 1.41 | 12MM  | M10x1    |
| <b>S38</b>    | 2.75 | 1.70 | 14MM  | 12MM     |
| <b>S39</b>    | 2.20 | 1.31 | 10MM  | 10MM     |
| <b>S40</b>    | 2.52 | 1.33 | 7/16  | 3/8-24   |
| <b>S41</b>    | 3.48 | 2.32 | 5/8   | 1/2-20   |
| <b>S42</b>    | 3.50 | 2.00 | 5/8   | 5/8-18   |
| <b>S43</b>    | 2.75 | 1.25 | 5/8   | 5/8-18   |
| <b>S44</b>    | 1.57 | 0.39 | 10MM  | M10x1.25 |
| <b>S45</b>    | 2.36 | 1.00 | 10MM  | M10x1.25 |
| <b>S46</b>    | 1.57 | 1.18 | 10MM  | M10x1.25 |
| <b>S47</b>    | 2.20 | 1.31 | 10MM  | M10x1.25 |
| <b>S48</b>    | 2.55 | 1.51 | 10MM  | M10x1.25 |
| <b>S49</b>    | 2.67 | 1.29 | 10MM  | M10x1.25 |
| <b>S50</b>    | 2.95 | 1.57 | 10MM  | M10x1.25 |
| <b>S51</b>    | 3.00 | 1.65 | 10MM  | M10x1.25 |
| <b>S52</b>    | 1.18 | 0.74 | 10MM  | M10x1.5  |
| <b>S53</b>    | 2.16 | 1.89 | 10MM  | M10x1.5  |
| <b>S54</b>    | 2.42 | 1.28 | 15MM  | M10x1.5  |
| <b>S55</b>    | 2.51 | 1.39 | 10MM  | M10x1.5  |
| <b>S56</b>    | 2.67 | 1.53 | 11MM  | M10x1.5  |
| <b>S57</b>    | 2.95 | 1.40 | 27/64 | M10x1.5  |
| <b>S58</b>    | 2.98 | 1.68 | 10MM  | M10x1.5  |
| <b>S59</b>    | 2.98 | 1.68 | 12MM  | M10x1.5  |
| <b>S60</b>    | 3.46 | 1.96 | 9/16  | M10x1.5  |
| <b>S61</b>    | 3.11 | 1.45 | 14MM  | M12x1.25 |
| <b>S62</b>    | 3.24 | 1.70 | 9/16  | M12x1.25 |
| <b>S63</b>    | 3.54 | 2.24 | 17MM  | M12x1.25 |
| <b>S64</b>    | 2.36 | 1.18 | 12MM  | M12x1.5  |
| <b>S65</b>    | 2.89 | 1.65 | 12MM  | M12x1.5  |
| <b>S66</b>    | 1.39 | 0.15 | 12MM  | M12x1.75 |
| <b>S67</b>    | 2.40 | 1.53 | 9/16  | M14x1.5  |
| <b>S68</b>    | 2.95 | 1.45 | 5/8   | M16x1.5  |
| <b>S69</b>    | 1.32 | 1.37 | 39/64 | M16x2    |
| <b>S70</b>    | 1.88 | 0.90 | 7/16  | M8x1.25  |

# HOW TO DETERMINE THE CORRECT SHOCK FOR YOUR TRUCK

## CÓMO ESCOGER EL MEJOR AMORTIGUADOR PARA SU CAMIÓN

### COMMENT CHOISIR LE BON AMORTISSEUR POUR VOTRE CAMION

#### EXPLANATION OF COLUMN HEADINGS

#### EXPLICACIÓN DE LOS TÍTULOS DE LAS COLUMNAS

#### EXPLICATION DES EN-TÊTES DE COLONNES

|   |  |   |
|---|--|---|
| <b>SHOCK ABSORBER PART NUMBER:</b><br>The catalog number for the individual shock absorber.   | <b>Número de parte del amortiguador:</b><br>El número de catálogo para el amortiguador individual.   | <b>Numéro de pièce de l'amortisseur:</b><br>Le numéro de catalogue pour l'amortisseur individuel.   |
| <b>EXTENDED LENGTH:*</b><br>The length of the shock absorber when it is fully extended. See "How to Measure" instructions.  | <b>Longitud extendida :*</b><br>La longitud del amortiguador cuando está totalmente extendido.<br>Ver instrucciones «Cómo medir».  | <b>Longueur étirée:*</b><br>La longueur de l'amortisseur entièrement étiré.<br>Voir "Comment mesurer".  |
| <b>COLLAPSED LENGTH:*</b><br>The length of the shock absorber when it is fully compressed. See "How to Measure" instructions.   | <b>Longitud comprimida :*</b><br>La longitud del amortiguador cuando está totalmente comprimido.<br>Ver instrucciones «Cómo medir».  | <b>Longueur comprimée:*</b><br>La longueur de l'amortisseur entièrement comprimé.<br>Voir "Comment mesurer".  |
| <b>STROKE:</b><br>This is the approximate length of the stroke of the individual shock absorber being described.  | <b>Carrera :</b><br>Es la longitud aproximada del recorrido del amortiguador descrito.   | <b>Course:</b><br>C'est la longueur approximative de la course de l'amortisseur individuel décrit.  |
| <b>MOUNTING CODES:</b><br>Indicates the type of mounting ends for the upper and lower end of each shock absorber.<br>They are listed as follows:<br>Stud Type Mounts ("S" & "DS")<br>Eye Ring and Bushing Mounts ("EB")<br>Eye Ring and Bushing with Sleeve Mounts ("ES")<br>Eye Ring and Bushing with Bar Pin Mounts ("BP")<br>Special Mounting Codes ("SP") | <b>Códigos de montaje :</b><br>Indica el tipo de montantes de montaje superior e inferior para cada amortiguador.<br>Se enlistan como sigue :<br>Montajes tipo perno («S» y «DS»)<br>Montajes anillo y buje («EB»)<br>Montajes anillo y buje con camisa («ES»)<br>Montajes anillo y buje con clavija («BP»)<br>Códigos de montajes especiales («SP») | <b>Codes de montage:</b><br>Indique le type de montures supérieure et inférieure de chaque amortisseur.<br>Ils sont énumérés comme suit:<br>Montures de type goujon ("S" et "DS")<br>Montures à bague et manchon ("EB")<br>Montures à bague et manchon avec collet ("ES")<br>Montures à bague et manchon avec goupille ("BP")<br>Codes de montures spéciales ("SP") |
| <b>DUST TUBE:</b><br>Indicates whether the shock absorber is supplied with a dust tube.   | <b>Polvera:</b><br>Indica si el amortiguador cuenta un polvera.  | <b>Tube pare-poussière:</b><br>Indique que l'amortisseur est fourni avec un tube pare-poussière.  |
| <b>MOUNTING ACCESSORY PACKAGE NUMBER:</b><br>The part number of the Mount Accessory Package supplied with the shock absorber.   | <b>Número de paquete de accesorios de montaje:</b><br>El número de parte del paquete de accesorios de montaje proveído con el amortiguador.  | <b>Numéro d'emballage d'accessoires de montage:</b><br>Le numéro de pièce de l'emballage d'accessoires de montage fourni avec l'amortisseur.  |
| <b>*NOTE:</b><br>All dimensions shown are in inches   | <b>*Nota :</b><br>Todas las dimensiones son en pulgadas  | <b>*Note:</b><br>Toutes les dimensions indiquées sont en pouces   |

**STEP 4:** Refer to shock absorber specifications by end mount. Start first by finding the appropriate series. Next, match the extended/collapsed length and find the correct mounting codes. Refer to the far left column of the chart for the correct Gabriel shock absorber part number.

**4º PASO:** Consulte las especificaciones del amortiguador mostradas al final del catálogo. Encuentre primero la serie adecuada. Luego, compare las longitudes de extensión y de compresión, y encuentre los códigos de montaje correctos. Consulte la columna del extremo izquierdo de la tabla para identificar el número de parte del amortiguador Gabriel correcto.

**4E ÉTAPE:** Reportez-vous aux spécifications d'amortisseur énoncées à la fin du catalogue. Trouvez d'abord la série appropriée. Comparez ensuite les longueurs d'extension et de compression et trouvez les bons codes de fixation. Reportez-vous à la colonne située à la extrême gauche de tableau pour identifier le bon numéro de pièce pour un amortisseur Gabriel.



**SPECIFICATIONS BY END MOUNT**  
**ESPECIFICACIONES POR TIPO DE MONTAJE**  
**SPÉCIFICATIONS PAR FIXATION DES EXTRÉMITÉS**

| Gabriel | Mounting |       | Bore    | External Diameter Illustration | Lengths  |           |        | Dust Tube | Recoil Cutoff | Controls* |             |
|---------|----------|-------|---------|--------------------------------|----------|-----------|--------|-----------|---------------|-----------|-------------|
|         | Upper    | Lower |         |                                | Extended | Collapsed | Stroke |           |               | Rebound   | Compression |
| 83013   | BP8      | BP8   | 1-3/16" | 2" D/T                         | 7.66     | 6.63†     | 1.7    | YES       | NO            | 646       | 480         |
| G63837  | BP8      | ES83  | 1-3/8"  |                                | 28.23    | 17.95     | 10.28  |           |               |           |             |
| G63679  | BP8      | ES83  | 1-3/8"  |                                | 25       | 14.97     | 10.03  | YES       | NO            |           |             |
| 83015   | BP8      | S1    | 1-3/8"  | A                              | 9.84     | 7.59      | 2.25   | YES       | YES           | 735       | 430         |
| 83005   | BP8      | S10   | 1-3/16" | 2" D/T                         | 7.34     | 5.87      | 1.47   | YES       | NO            | 858       | 216         |
| 83041   | BP27     | S10   | 1-3/8"  | A                              | 10.51†   | 8.34†     | 3.02   | YES       | YES           | 486       | 189         |
| G63607  | BP33     | ES83  | 1-3/8"  |                                | 25.58    | 15.3      | 10.28  | YES       | NO            |           |             |
| 83060   | EB       | BP7   | 1-3/8"  | A                              | 9.76     | 7.98†     | 2.25   | NO        | YES           | 431       | 441         |
| 83011   | EB1      | EB1   | 1-3/8"  | A                              | 11.55†   | 8.48      | 3.61   | YES       | YES           | 738       | 330         |
| 83012   | EB1      | EB1   | 1-3/8"  | A                              | 11.07†   | 8.21      | 3.37   | YES       | YES           | 738       | 330         |
| G63440  | EB1      | EB1   | 1-3/8"  |                                | 26.33    | 15.55     | 10.78  | NO        | NO            |           |             |
| 83401   | EB1      | EB1   | 1-3/16" | F                              | 24.09    | 14.26     | 9.83   | YES       | NO            | 341       | 252         |
| G63419  | EB1      | EB1   | 1-3/8"  |                                | 24.08    | 14.55     | 9.53   | YES       | NO            |           |             |
| G63405  | EB1      | EB1   | 1-3/8"  |                                | 20       | 12.47     | 7.53   | YES       | NO            | 572       | 115         |
| 83007   | EB1      | EB1   | 1-3/8"  | A                              | 18.55    | 11.67     | 6.87   | NO        | NO            | 489       | 343         |
| G63299  | EB1      | EB1   | 1-3/8"  |                                | 18.08    | 11.55     | 6.53   | YES       | NO            | 396       | 109         |
| G63810  | EB1      | ES83  | 1-3/8"  |                                | 31.51    | 18.48     | 13.03  | YES       | NO            |           |             |
| G63808  | EB1      | ES83  | 1-3/8"  |                                | 28.86    | 17.08     | 11.78  | YES       | NO            |           |             |
| G63524  | EB1      | ES83  | 1-3/8"  |                                | 27.08    | 16.05     | 11.03  | YES       | NO            |           |             |
| G63775  | EB1      | ES83  | 1-3/8"  |                                | 27.08    | 16.05     | 11.03  | YES       | NO            |           |             |
| G63461  | EB1      | ES83  | 1-3/8"  |                                | 25.5     | 15.22     | 10.28  | YES       | NO            |           |             |
| G63811  | EB1      | ES83  | 1-3/8"  |                                | 25.5     | 15.22     | 10.28  | YES       | NO            |           |             |
| G63525  | EB1      | ES83  | 1-3/8"  |                                | 23.08    | 14.05     | 9.03   | YES       | NO            |           |             |
| G63773  | EB1      | ES83  | 1-3/8"  |                                | 23.08    | 14.05     | 9.03   | YES       | NO            |           |             |
| G63406  | EB1      | ES83  | 1-3/8"  |                                | 23       | 13.97     | 9.03   | YES       | NO            |           |             |
| G63809  | EB1      | ES83  | 1-3/8"  |                                | 23       | 13.97     | 9.03   | YES       | NO            |           |             |
| G63409  | EB1      | ES83  | 1-3/8"  |                                | 21.58    | 13.3      | 8.28   | YES       | NO            |           |             |
| 85063   | EB2      | EB2   | 1-5/8"  | C                              | 32.01    | 18.85     | 13.16  | YES       | NO            | 762       | 174         |
| 83107   | EB2      | EB2   | 1-3/8"  | A                              | 31.66    | 18.4      | 13.25  | YES       | NO            | 352       | 77          |
| 83314   | EB2      | EB2   | 1-3/8"  | B                              | 30.64    | 18.11     | 12.53  | YES       | YES           | 633       | 143         |
| 85024   | EB2      | EB2   | 1-5/8"  | C                              | 28.77    | 17.25     | 11.52  | YES       | YES           | 1008      | 539         |
| 83309   | EB2      | EB2   | 1-3/8"  | B                              | 28.64    | 17.11     | 11.53  | YES       | YES           | 589       | 135         |
| 89416   | EB2      | EB2   | 1-5/8"  | G                              | 28.62    | 17.54     | 11.08  | YES       | YES           | 1155†     | 514         |
| 89401   | EB2      | EB2   | 1-5/8"  | G                              | 28.41    | 17.16     | 11.25  | YES       | NO            | 665†      | 194         |
| 89446   | EB2      | EB2   | 1-5/8"  | G                              | 28.36    | 17.41     | 10.95  | YES       | YES           | 702†      | 204         |
| 85046   | EB2      | EB2   | 1-5/8"  | C                              | 27.55    | 16.62     | 10.93  | YES       | YES           | 1008      | 539         |
| 89409   | EB2      | EB2   | 1-5/8"  | G                              | 27.13    | 16.92     | 10.2   | YES       | YES           | 567†      | 165         |

\* Damping force, in pounds, to either extend or collapse the shock absorber at an average operating velocity. Fuerza de amortiguación en libras para extender o comprimir el amortiguador a una velocidad de operación promedio. La puissance d'amortissement en poids de l'amortisseur, soit comprimé, doit détendu, à une vitesse de fonctionnement moyenne.

† At bumper contact / Al contacto cone el tope de goma / Au contact avec le butoir

**SPECIFICATIONS BY END MOUNT**  
**ESPECIFICACIONES POR TIPO DE MONTAJE**  
**SPÉCIFICATIONS PAR FIXATION DES EXTRÉMITÉS**

| Gabriel | Mounting |       | Bore    | External Diameter Illustration | Lengths  |           |        | Dust Tube | Recoil Cutoff | Controls* |             |
|---------|----------|-------|---------|--------------------------------|----------|-----------|--------|-----------|---------------|-----------|-------------|
|         | Upper    | Lower |         |                                | Extended | Collapsed | Stroke |           |               | Rebound   | Compression |
| 89434   | EB2      | EB2   | 1-5/8"  | G                              | 27.12    | 16.79     | 10.33  | YES       | YES           | 1155‡     | 514         |
| 89403   | EB2      | EB2   | 1-5/8"  | G                              | 26.86    | 17.16     | 9.7    | YES       | YES           | 929‡      | 281         |
| 83312   | EB2      | EB2   | 1-3/8"  | B                              | 26.64    | 16.11     | 10.53  | YES       | YES           | 527       | 152         |
| 89439   | EB2      | EB2   | 1-5/8"  | G                              | 25.67    | 15.79     | 9.88   | YES       | NO            | 518‡      | 103         |
| 85055   | EB2      | EB2   | 1-5/8"  | C                              | 25.63    | 15.63     | 10     | YES       | NO            | 577       | 102         |
| 85047   | EB2      | EB2   | 1-5/8"  | C                              | 25.31    | 15.52     | 9.79   | YES       | YES           | 1008      | 539         |
| 83308   | EB2      | EB2   | 1-3/8"  | B                              | 25.14    | 15.36     | 9.78   | YES       | YES           | 445       | 180         |
| 89435   | EB2      | EB2   | 1-5/8"  | G                              | 24.92    | 15.82     | 9.1    | YES       | YES           | 1155‡     | 514         |
| 83200   | EB2      | EB2   | 1-3/8"  | A                              | 24.51    | 15.1      | 9.53   | YES       | NO            | 806       | 370         |
| 89402   | EB2      | EB2   | 1-5/8"  | G                              | 24.41    | 15.16     | 9.25   | YES       | NO            | 874‡      | 206         |
| 83519   | EB2      | EB2   | 1-3/16" | F                              | 23.83    | 14.35     | 9.48   | YES       | NO            | 292       | 132         |
| 83216   | EB2      | EB2   | 1-3/8"  | A                              | 23.51    | 14.48     | 9.03   | YES       | YES           | 776       | 262         |
| 85054   | EB2      | EB2   | 1-5/8"  | C                              | 23.26    | 14.37     | 8.89   | YES       | NO            | 602       | 104         |
| 89438   | EB2      | EB2   | 1-5/8"  | G                              | 23.17    | 14.54     | 8.63   | YES       | NO            | 583‡      | 103         |
| 83404   | EB2      | EB2   | 1-3/16" | F                              | 22.01    | 13.44     | 8.58   | YES       | NO            | 545       | 171         |
| 83159   | EB2      | EB2   | 1-3/8"  | A                              | 21.85    | 13.56     | 8.29   | YES       | NO            | 658       | 149         |
| 85012   | EB2      | EB2   | 1-5/8"  | C                              | 21.02    | 13.23     | 7.79   | YES       | NO            | 523       | 199         |
| 89413   | EB2      | EB2   | 1-5/8"  | G                              | 20.94    | 13.53     | 7.41   | YES       | NO            | 536‡      | 201         |
| 85023   | EB2      | EB2   | 1-5/8"  | C                              | 20.27    | 13        | 7.27   | YES       | YES           | 1008      | 539         |
| 89415   | EB2      | EB2   | 1-5/8"  | G                              | 20.12    | 13.29     | 6.83   | YES       | YES           | 1155‡     | 514         |
| 83219   | EB2      | EB2   | 1-3/8"  | A                              | 20.01    | 12.73     | 7.28   | YES       | YES           | 299       | 125         |
| 85062   | EB2      | EB2   | 1-5/8"  | C                              | 19.76    | 12.6      | 7.16   | YES       | NO            | 523       | 199         |
| 89408   | EB2      | EB2   | 1-5/8"  | G                              | 19.68    | 12.9      | 6.78   | YES       | NO            | 536‡      | 201         |
| G63605  | EB2      | ES27  | 1-3/8"  |                                | 24.24    | 14.71     | 9.53   | YES       | NO            |           |             |
| 85025   | EB2      | S21   | 1-5/8"  | C                              | 23.02    | 14.01     | 9.01   | YES       | NO            | 1079      | 539         |
| 85376   | EB3      | EB3   | 1-5/8"  | D                              | 33.27    | 19.73     | 13.54  | YES       | NO            | 668       | 134         |
| 85301   | EB3      | EB3   | 1-5/8"  | D                              | 31.92    | 19.03     | 12.89  | YES       | NO            | 1442      | 455         |
| 85339   | EB3      | EB3   | 1-5/8"  | D                              | 31.68    | 19.02     | 12.66  | YES       | YES           | 804       | 463         |
| 85040   | EB3      | EB3   | 1-5/8"  | C                              | 30.91    | 18.51     | 12.4   | YES       | NO            | 889       | 114         |
| 85730   | EB3      | EB3   | 1-5/8"  | D                              | 30.75    | 18.72     | 12.03  | YES       | YES           | 1517      | 293         |
| 85315   | EB3      | EB3   | 1-5/8"  | D                              | 29.61    | 18.07     | 11.53  | YES       | NO            | 380       | 142         |
| 85901   | EB3      | EB3   | 1-5/8"  | G                              | 29.09    | 17.68     | 11.42  | YES       | NO            | 1830      | 418         |
| 85704   | EB3      | EB3   | 1-5/8"  | D                              | 28.75    | 18.72     | 10.03  | YES       | YES           | 1435      | 186         |
| 83104   | EB3      | EB3   | 1-3/8"  | A                              | 28.24    | 17.12     | 11.12  | YES       | NO            | 698       | 133         |
| 85305   | EB3      | EB3   | 1-5/8"  | D                              | 27.25    | 16.7      | 10.55  | YES       | NO            | 1120      | 225         |
| 83362   | EB3      | EB3   | 1-3/8"  | B                              | 27       | 16.25     | 10.75  | YES       | NO            | 539       | 202         |
| 87004   | EB3      | EB3   | 2-1/16" | E                              | 26.76    | 16.76     | 10     | YES       | YES           | 1158      | 190         |

\* Damping force, in pounds, to either extend or collapse the shock absorber at an average operating velocity. Fuerza de amortiguación en libras para extender o comprimir el amortiguador a una velocidad de operación promedio. La puissance d'amortissement en poids de l'amortisseur, soit comprimé, doit détendu, à une vitesse de fonctionnement moyenne.

**SPECIFICATIONS BY END MOUNT**  
**ESPECIFICACIONES POR TIPO DE MONTAJE**  
**SPÉCIFICATIONS PAR FIXATION DES EXTRÉMITÉS**

| Gabriel | Mounting |       | Bore    | External Diameter Illustration | Lengths  |           |        | Dust Tube | Recoil Cutoff | Controls* |             |
|---------|----------|-------|---------|--------------------------------|----------|-----------|--------|-----------|---------------|-----------|-------------|
|         | Upper    | Lower |         |                                | Extended | Collapsed | Stroke |           |               | Rebound   | Compression |
| 85735   | EB3      | EB3   | 1-5/8"  | D                              | 26.72    | 16.7      | 10.02  | YES       | YES           | 1288      | 227         |
| 83215   | EB3      | EB3   | 1-3/8"  | A                              | 26.64    | 16.36     | 10.28  | YES       | YES           | 697       | 108         |
| 89425   | EB3      | EB3   | 1-5/8"  | G                              | 26.5     | 16.93     | 9.57   | YES       | YES           | 1352†     | 167         |
| 85314   | EB3      | EB3   | 1-5/8"  | D                              | 26.49    | 16.46     | 10.03  | YES       | YES           | 1216      | 169         |
| 89410   | EB3      | EB3   | 1-5/8"  | G                              | 26.34    | 16.57     | 9.77   | YES       | NO            | 1185†     | 182         |
| 85001   | EB3      | EB3   | 1-5/8"  | C                              | 26.3     | 16.39     | 9.92   | YES       | NO            | 1202      | 186         |
| 85313   | EB3      | EB3   | 1-5/8"  | D                              | 26.26    | 16.35     | 9.91   | YES       | YES           | 717       | 111         |
| 87003   | EB3      | EB3   | 2-1/16" | E                              | 26.26    | 16.51     | 9.75   | YES       | YES           | 1332      | 395         |
| 89429   | EB3      | EB3   | 1-5/8"  | G                              | 26.22    | 16.57     | 9.65   | YES       | NO            | 941†      | 266         |
| 85320   | EB3      | EB3   | 1-5/8"  | D                              | 26.15    | 16.35     | 9.8    | YES       | NO            | 970       | 308         |
| 85700   | EB3      | EB3   | 1-5/8"  | D                              | 26.09    | 16.58     | 9.51   | YES       | YES           | 1446      | 328         |
| 83140   | EB3      | EB3   | 1-3/8"  | A                              | 25.28    | 15.53     | 9.75   | YES       | NO            | 738       | 88          |
| 83141   | EB3      | EB3   | 1-3/8"  | A                              | 25.27    | 15.52     | 9.75   | YES       | NO            | 408       | 113         |
| 83132   | EB3      | EB3   | 1-3/8"  | A                              | 25.24    | 15.5      | 9.74   | YES       | NO            | 828       | 150         |
| 85714   | EB3      | EB3   | 1-5/8"  | D                              | 25.13    | 15.85     | 9.28   | YES       | YES           | 1220      | 175         |
| 85715   | EB3      | EB3   | 1-5/8"  | D                              | 25.13    | 15.85     | 9.28   | YES       | YES           | 1915      | 200         |
| 85717   | EB3      | EB3   | 1-5/8"  | D                              | 25.13    | 15.85     | 9.28   | YES       | YES           | 1915      | 200         |
| 89422   | EB3      | EB3   | 1-5/8"  | G                              | 25.12    | 16.3      | 8.83   | YES       | YES           | 794†      | 253         |
| 85308   | EB3      | EB3   | 1-5/8"  | D                              | 25.11    | 15.83     | 9.28   | YES       | YES           | 764       | 254         |
| 85303   | EB3      | EB3   | 1-5/8"  | D                              | 24.76    | 15.48     | 9.29   | YES       | NO            | 1019      | 221         |
| 89442   | EB3      | EB3   | 1-5/8"  | G                              | 24.72    | 15.74     | 8.98   | YES       | NO            | 1055†     | 224         |
| 85053   | EB3      | EB3   | 1-5/8"  | C                              | 24.69    | 15.52     | 9.17   | YES       | NO            | 1019      | 227         |
| 85329   | EB3      | EB3   | 1-5/8"  | D                              | 24.52    | 15.48     | 9.04   | YES       | YES           | 1550      | 232         |
| 85713   | EB3      | EB3   | 1-5/8"  | D                              | 24.51    | 15.48     | 9.04   | YES       | YES           | 1157      | 180         |
| 85007   | EB3      | EB3   | 1-5/8"  | C                              | 24.33    | 15.4      | 8.93   | YES       | YES           | 1008      | 171         |
| 89412   | EB3      | EB3   | 1-5/8"  | G                              | 24.26    | 15.68     | 8.58   | YES       | YES           | 1155†     | 169         |
| 83225   | EB3      | EB3   | 1-3/8"  | A                              | 24.14    | 15.11     | 9.03   | YES       | YES           | 482       | 159         |
| 85307   | EB3      | EB3   | 1-5/8"  | D                              | 23.98    | 15.08     | 8.89   | YES       | NO            | 1094      | 173         |
| 85702   | EB3      | EB3   | 1-5/8"  | D                              | 23.76    | 15.85     | 7.91   | YES       | YES           | 1093      | 825         |
| 87006   | EB3      | EB3   | 2-1/16" | E                              | 23.75    | 15.25     | 8.5    | YES       | YES           | 1158      | 272         |
| 85736   | EB3      | EB3   | 1-5/8"  | D                              | 23.61    | 15.2      | 8.41   | YES       | YES           | 1155      | 352         |
| 87002   | EB3      | EB3   | 2-1/16" | E                              | 23.5     | 15.41     | 8.09   | YES       | YES           | 879       | 203         |
| 89420   | EB3      | EB3   | 1-5/8"  | G                              | 22.8     | 14.8      | 8      | YES       | NO            | 862†      | 258         |
| 83217   | EB3      | EB3   | 1-3/8"  | A                              | 22.77    | 14.49     | 8.28   | YES       | YES           | 633       | 159         |
| 85302   | EB3      | EB3   | 1-5/8"  | D                              | 22.75    | 14.61     | 8.14   | YES       | NO            | 836       | 253         |
| 85304   | EB3      | EB3   | 1-5/8"  | D                              | 22.25    | 14.22     | 8.03   | YES       | NO            | 767       | 325         |
| 85718   | EB3      | EB3   | 1-5/8"  | D                              | 22.13    | 15.04     | 7.09   | YES       | YES           | 2506      | 206         |

\* Damping force, in pounds, to either extend or collapse the shock absorber at an average operating velocity. Fuerza de amortiguación en libras para extender o comprimir el amortiguador a una velocidad de operación promedio. La puissance d'amortissement en poids de l'amortisseur, soit comprimé, doit détendu, à une vitesse de fonctionnement moyenne.

† At bumper contact / Al contacto cone el tope de goma / Au contact avec le butoir

**SPECIFICATIONS BY END MOUNT**  
**ESPECIFICACIONES POR TIPO DE MONTAJE**  
**SPÉCIFICATIONS PAR FIXATION DES EXTRÉMITÉS**

| Gabriel | Mounting |       | Bore    | External Diameter Illustration | Lengths  |           |        | Dust Tube | Recoil Cutoff | Controls* |             |
|---------|----------|-------|---------|--------------------------------|----------|-----------|--------|-----------|---------------|-----------|-------------|
|         | Upper    | Lower |         |                                | Extended | Collapsed | Stroke |           |               | Rebound   | Compression |
| 85732   | EB3      | EB3   | 2-1/16" | E                              | 22.13    | 15.11     | 7.03   | YES       | YES           | 2632      | 382         |
| 85716   | EB3      | EB3   | 1-5/8"  | D                              | 21.99    | 14.33     | 7.66   | YES       | YES           | 1220      | 175         |
| 87001   | EB3      | EB3   | 2-1/16" | E                              | 20.76    | 13.76     | 7      | YES       | YES           | 1158      | 190         |
| 85734   | EB3      | EB3   | 1-5/8"  | D                              | 20.73    | 13.7      | 7.03   | YES       | YES           | 1288      | 227         |
| 85004   | EB3      | EB3   | 1-5/8"  | C                              | 20.68    | 13.67     | 7.01   | YES       | YES           | 1019      | 219         |
| 85042   | EB3      | EB3   | 1-5/8"  | C                              | 20.64    | 13.61     | 7.03   | YES       | YES           | 333       | 161         |
| 85712   | EB3      | EB3   | 1-5/8"  | D                              | 20.5     | 13.47     | 7.04   | YES       | YES           | 1435      | 562         |
| 85720   | EB3      | EB3   | 1-5/8"  | D                              | 20.5     | 13.47     | 7.03   | YES       | YES           | 1435      | 562         |
| 85968   | EB3      | EB3   | 1-5/8"  | G                              | 19.87    | 13.39     | 6.48   | YES       | YES           | 1069      | 227         |
| 83214   | EB3      | EB3   | 1-3/8"  | A                              | 19.64    | 12.86     | 6.78   | YES       | YES           | 269       | 90          |
| 89419   | EB3      | EB3   | 1-5/8"  | G                              | 18.04    | 12.67     | 5.36   | YES       | YES           | 1352±     | 636         |
| 85300   | EB3      | EB3   | 1-5/8"  | D                              | 17.98    | 12.21     | 5.78   | YES       | YES           | 1435      | 676         |
| 85719   | EB3      | EB3   | 1-5/8"  | D                              | 17.25    | 11.97     | 5.28   | YES       | YES           | 1517      | 213         |
| 85334   | EB3      | EB3   | 1-5/8"  | D                              | 14.52    | 10.48     | 4.04   | YES       | YES           | 1271      | 319         |
| 85912   | EB3      | ES36  | 1-5/8"  | G                              | 18.68    | 12.57     | 6.11   | YES       | YES           | 1020      | 219         |
| 85327   | EB3      | ES160 | 1-5/8"  | D                              | 16.01    | 12.1      | 3.91   | YES       | YES           | 764       | 162         |
| 85322   | EB3      | ES160 | 1-5/8"  | D                              | 15.26    | 11.85     | 3.41   | YES       | YES           | 764       | 162         |
| 83353   | EB3      | S21   | 1-3/8"  | B                              | 24.84    | 15.06     | 9.78   | YES       | NO            | 432       | 214         |
| 85740   | EB3      | S21   | 1-5/8"  | D                              | 24.7     | 15.15     | 9.55   | YES       | YES           | 848       | 305         |
| 85380   | EB3      | S21   | 1-5/8"  | D                              | 23.95    | 14.79     | 9.15   | YES       | YES           | 1568      | 227         |
| 85312   | EB3      | S21   | 1-5/8"  | D                              | 23.68    | 14.8      | 8.88   | YES       | YES           | 717       | 111         |
| 85733   | EB3      | S21   | 1-5/8"  | D                              | 23.57    | 14.73     | 8.84   | YES       | YES           | 717       | 111         |
| 85379   | EB3      | S21   | 1-5/8"  | D                              | 22.69    | 14.4      | 8.29   | YES       | YES           | 1658      | 176         |
| 85330   | EB3      | S21   | 1-5/8"  | D                              | 22.44    | 14.16     | 8.28   | YES       | YES           | 1140      | 176         |
| 85729   | EB3      | S21   | 1-5/8"  | D                              | 21.55    | 13.77     | 7.78   | YES       | YES           | 783       | 111         |
| 85723   | EB3      | S21   | 1-5/8"  | D                              | 19.93    | 12.9      | 7.03   | YES       | YES           | 1318      | 248         |
| 83117   | EB4      | EB1   | 1-3/8"  | A                              | 23.98    | 14.47     | 9.51   | YES       | NO            | 354       | 300         |
| G63183  | EB4      | EB4   | 1-3/8"  |                                | 20.89    | 13.11     | 7.78   | YES       | NO            |           |             |
| 83119   | EB4      | ES165 | 1-3/8"  | A                              | 23.96    | 14.84     | 9.12   | YES       | NO            | 354       | 300         |
| G63355  | EB7      | ES24  | 1-3/8"  |                                | 15       | 9.97      | 5.03   | YES       | NO            |           |             |
| 83303   | EB7      | ES36  | 1-3/8"  | B                              | 24.86    | 15.08     | 9.78   | YES       | YES           | 470       | 122         |
| 83304   | EB7      | ES36  | 1-3/8"  | B                              | 22.86    | 14.08     | 8.78   | YES       | YES           | 470       | 122         |
| G63625  | EB7      | ES36  | 1-3/8"  |                                | 22.48    | 13.96     | 8.53   | YES       | NO            |           |             |
| G63306  | ES2      | ES24  | 1-3/8"  |                                | 19.86    | 12.58     | 7.28   | YES       | NO            |           |             |
| G63347  | ES3      | ES24  | 1-3/8"  |                                | 18.08    | 11.55     | 6.53   | YES       | NO            |           |             |
| G63455  | ES8      | ES83  | 1-3/8"  |                                | 23       | 13.97     | 9.03   | YES       | NO            |           |             |
| 83002   | ES10     | ES10  | 1-3/8"  | A                              | 11.65    | 8.66      | 3      | YES       | YES           | 3112      | 590         |

\* Damping force, in pounds, to either extend or collapse the shock absorber at an average operating velocity. Fuerza de amortiguación en libras para extender o comprimir el amortiguador a una velocidad de operación promedio. La puissance d'amortissement en poids de l'amortisseur, soit comprimé, doit détendu, à une vitesse de fonctionnement moyenne.

**SPECIFICATIONS BY END MOUNT**  
**ESPECIFICACIONES POR TIPO DE MONTAJE**  
**SPÉCIFICATIONS PAR FIXATION DES EXTRÉMITÉS**

| Gabriel | Mounting |       | Bore    | External Diameter Illustration | Lengths  |           |        | Dust Tube | Recoil Cutoff | Controls* |             |
|---------|----------|-------|---------|--------------------------------|----------|-----------|--------|-----------|---------------|-----------|-------------|
|         | Upper    | Lower |         |                                | Extended | Collapsed | Stroke |           |               | Rebound   | Compression |
| 83024   | ES10     | ES10  | 1-3/8"  | 2-1/2" D/T                     | 11.65    | 8.66      | 3      | YES       | YES           | 811       | 320         |
| 83031   | ES10     | ES10  | 1-3/8"  | 2-1/2" D/T                     | 11.54    | 8.66      | 2.88   | YES       | YES           | 811       | 314         |
| 83016   | ES10     | ES10  | 1"      | 1-5/8"                         | 11.51    | 8.14      | 3.37   | NO        | YES           | 506       | 139         |
| 83021   | ES10     | ES10  | 1-3/8"  | A                              | 9.41     | 7.4       | 2.01   | YES       | YES           | 745       | 315         |
| 83051   | ES10     | ES10  | 1-3/8"  | 2-1/2" D/T                     | 9.41     | 7.4       | 2.01   | YES       | YES           | 579       | 163         |
| 83061   | ES10     | ES10  | 1-3/8"  | 2-1/2" D/T                     | 9.41     | 7.4       | 2.01   | YES       | YES           | 1030      | 220         |
| 83046   | ES10     | ES181 | 1-3/16" |                                | 9.23†    | 7.62†     | 2.73   | NO        | YES           | 514       | 173         |
| 83023   | ES10     | ES181 | 1"      | 1-5/8"                         | 8.7      | 7.09†     | 2.14   | NO        | YES           | 484       | 157         |
| 83045   | ES19     | S10   | 1-3/8"  | A                              | 11.53†   | 8.58†     | 3.81   | YES       | NO            | 510       | 153         |
| 83050   | ES19     | S10   | 1-3/8"  | A                              | 10.43†   | 8.38†     | 2.9    | YES       | YES           | 599       | 321         |
| 83058   | ES19     | S10   | 1-3/8"  | A                              | 10.43†   | 8.38†     | 2.9    | YES       | YES           | 742       | 243         |
| 83158   | ES22     | ES22  | 1-3/8"  | A                              | 12.96    | 8.97      | 4      | YES       | NO            | 783       | 484         |
| 83010   | ES24     | ES24  | 1"      | 2" D/T                         | 14.15†   | 9.33      | 5.07   | YES       | YES           | 188       | 70          |
| G63357  | ES24     | ES24  | 1-3/8"  |                                | 15       | 9.97      | 5.03   | YES       | NO            |           |             |
| 83022   | ES24     | ES24  | 1"      | 2" D/T                         | 14.28    | 9.33      | 4.95   | YES       | NO            | 840       | 152         |
| 83026   | ES24     | ES24  | 1-3/8"  | A                              | 13.11    | 9.12      | 3.99   | YES       | YES           | 602       | 104         |
| 83018   | ES24     | S10   | 1-3/8"  | A                              | 10.3†    | 8.42†     | 3.24   | YES       | YES           | 515       | 174         |
| 83027   | ES24     | S10   | 1-3/8"  | A                              | 13.82    | 9.2       | 4.61   | YES       | YES           | 602       | 104         |
| 83019   | ES24     | S10   | 1-3/8"  | A                              | 9.48     | 8.21†     | 2.29   | YES       | YES           | 509       | 121         |
| 83044   | ES27     | ES164 | 1-3/8"  | A                              | 10.91    | 7.93      | 2.98   | YES       | YES           | 789       | 296         |
| G63366  | ES34     | ES34  | 1-3/8"  |                                | 23.36    | 14.33     | 9.03   | YES       | NO            |           |             |
| G63866  | ES34     | ES34  | 1-3/8"  |                                | 22.81    | 14.12     | 8.69   |           |               |           |             |
| 83153   | ES34     | ES34  | 1-3/8"  | A                              | 21.69    | 13.62     | 8.07   | YES       | YES           | 974       | 206         |
| 83155   | ES34     | ES34  | 1-3/8"  | A                              | 21.69    | 13.62     | 8.07   | YES       | YES           | 507       | 80          |
| 83059   | ES35     | ES35  | 1-3/8"  | A                              | 12.06†   | 8.68      | 3.88   | YES       | YES           | 738       | 350         |
| 83004   | ES35     | ES136 | 1"      | 2" D/T                         | 9.36†    | 7.29      | 2.32   | YES       | YES           | 539       | 324         |
| 85905   | ES36     | EB3   | 1-5/8"  | G                              | 23.81    | 16.16     | 7.66   | YES       | YES           | 1020      | 219         |
| 85913   | ES36     | EB3   | 1-5/8"  | G                              | 22.56    | 15.2      | 7.36   | YES       | YES           | 1020      | 219         |
| 85057   | ES36     | EB3   | 1-5/8"  | C                              | 21.45    | 14.23     | 7.22   | YES       | YES           | 1216      | 115         |
| 85907   | ES36     | EB3   | 1-5/8"  | G                              | 21.43    | 14.2      | 7.23   | YES       | YES           | 1216      | 251         |
| 83113   | ES36     | EB3   | 1-3/8"  | A                              | 20.47    | 13.46     | 7.01   | YES       | YES           | 997       | 238         |
| 85059   | ES36     | EB3   | 1-5/8"  | C                              | 19.09    | 12.8      | 6.29   | YES       | YES           | 928       | 151         |
| 85915   | ES36     | EB3   | 1-5/8"  | G                              | 19.06    | 12.7      | 6.36   | YES       | YES           | 1020      | 219         |
| 83115   | ES36     | EB3   | 1-3/8"  | A                              | 16.19    | 13.32     | 4.87   | YES       | YES           | 997       | 238         |
| 83242   | ES36     | ES36  | 1-3/8"  | A                              | 33.73    | 20.98     | 12.75  | YES       | YES           | 721       | 135         |
| 85903   | ES36     | ES36  | 1-5/8"  | G                              | 31.99    | 19.13     | 12.86  | YES       | YES           | 666       | 113         |
| 85979   | ES36     | ES36  | 1-5/8"  | G                              | 31.18    | 18.66     | 12.52  | YES       | YES           | 582       | 138         |

\* Damping force, in pounds, to either extend or collapse the shock absorber at an average operating velocity. Fuerza de amortiguación en libras para extender o comprimir el amortiguador a una velocidad de operación promedio. La puissance d'amortissement en poids de l'amortisseur, soit comprimé, doit détendu, à une vitesse de fonctionnement moyenne.

† At bumper contact / Al contacto cone el tope de goma / Au contact avec le butoir

**SPECIFICATIONS BY END MOUNT**  
**ESPECIFICACIONES POR TIPO DE MONTAJE**  
**SPÉCIFICATIONS PAR FIXATION DES EXTRÉMITÉS**

| Gabriel | Mounting |       | Bore   | External Diameter Illustration | Lengths  |           |        | Dust Tube | Recoil Cutoff | Controls* |             |
|---------|----------|-------|--------|--------------------------------|----------|-----------|--------|-----------|---------------|-----------|-------------|
|         | Upper    | Lower |        |                                | Extended | Collapsed | Stroke |           |               | Rebound   | Compression |
| 85972   | ES36     | ES36  | 1-5/8" | G                              | 30.78    | 18.26     | 12.52  | YES       | NO            | 1493      | 261         |
| 83121   | ES36     | ES36  | 1-3/8" | A                              | 30.25    | 18.32     | 11.93  | YES       | YES           | 689       | 126         |
| 83137   | ES36     | ES36  | 1-3/8" | A                              | 30.04    | 17.79     | 12.25  | YES       | YES           | 517       | 132         |
| 85976   | ES36     | ES36  | 1-5/8" | G                              | 29.92    | 18.12     | 11.8   | YES       | YES           | 582       | 138         |
| 85013   | ES36     | ES36  | 1-5/8" | C                              | 29.79    | 17.76     | 12.04  | YES       | YES           | 1019      | 219         |
| 83205   | ES36     | ES36  | 1-3/8" | A                              | 29.69    | 17.69     | 12     | YES       | YES           | 660       | 76          |
| 89414   | ES36     | ES36  | 1-5/8" | G                              | 29.65    | 18.18     | 11.46  | YES       | YES           | 1045‡     | 217         |
| 83209   | ES36     | ES36  | 1-3/8" | A                              | 29.64    | 17.61     | 12.03  | YES       | YES           | 670       | 78          |
| 85337   | ES36     | ES36  | 1-5/8" | D                              | 28.72    | 17.44     | 11.28  | YES       | YES           | 1318      | 374         |
| 85006   | ES36     | ES36  | 1-5/8" | C                              | 28.54    | 17.13     | 11.41  | YES       | YES           | 1019      | 219         |
| 83125   | ES36     | ES36  | 1-3/8" | A                              | 28.15    | 17.16     | 10.99  | YES       | YES           | 625       | 115         |
| 85097   | ES36     | ES36  | 1-5/8" | C                              | 27.95    | 17.11     | 10.84  | YES       | YES           | 1086      | 109         |
| 85043   | ES36     | ES36  | 1-5/8" | C                              | 27.63    | 16.85     | 10.78  | YES       | YES           | 628       | 163         |
| 85904   | ES36     | ES36  | 1-5/8" | G                              | 27.61    | 16.88     | 10.73  | YES       | YES           | 666       | 113         |
| 85010   | ES36     | ES36  | 1-5/8" | C                              | 26.8     | 16.26     | 10.54  | YES       | YES           | 1019      | 219         |
| 83123   | ES36     | ES36  | 1-3/8" | A                              | 26.65    | 16.41     | 10.24  | YES       | YES           | 589       | 119         |
| 83176   | ES36     | ES36  | 1-3/8" | A                              | 26.62    | 15.96     | 10.66  | NO        | NO            | 406       | 275         |
| 85036   | ES36     | ES36  | 1-5/8" | C                              | 26.38    | 16.29     | 10.09  | YES       | YES           | 633       | 119         |
| 89405   | ES36     | ES36  | 1-5/8" | G                              | 26.3     | 16.57     | 9.73   | YES       | YES           | 1009‡     | 249         |
| 85099   | ES36     | ES36  | 1-5/8" | C                              | 26.02    | 15.93     | 10.09  | YES       | YES           | 1152      | 135         |
| 85974   | ES36     | ES36  | 1-5/8" | G                              | 26.02    | 16.11     | 9.91   | YES       | YES           | 3087      | 230         |
| 85321   | ES36     | ES36  | 1-5/8" | D                              | 25.38    | 15.59     | 9.79   | YES       | YES           | 1435      | 676         |
| 83122   | ES36     | ES36  | 1-3/8" | A                              | 25.28    | 15.79     | 9.49   | YES       | YES           | 661       | 201         |
| 83149   | ES36     | ES36  | 1-3/8" | A                              | 25.28    | 15.78     | 9.49   | YES       | YES           | 332       | 101         |
| 83218   | ES36     | ES36  | 1-3/8" | A                              | 25.19    | 15.44     | 9.75   | YES       | YES           | 721       | 194         |
| 665472  | ES36     | ES36  | 1-5/8" | G                              | 25.14    | 15.61     | 9.53   | NO        | NO            | 925       | 977         |
| 85005   | ES36     | ES36  | 1-5/8" | C                              | 24.76    | 15.24     | 9.52   | YES       | YES           | 1019      | 219         |
| 89406   | ES36     | ES36  | 1-5/8" | G                              | 24.76    | 15.82     | 8.93   | YES       | YES           | 658‡      | 125         |
| 85916   | ES36     | ES36  | 1-5/8" | G                              | 24.65    | 15.55     | 9.1    | YES       | YES           | 1149      | 219         |
| 89430   | ES36     | ES36  | 1-5/8" | G                              | 24.61    | 15.66     | 8.94   | YES       | YES           | 1462‡     | 279         |
| 83126   | ES36     | ES36  | 1-3/8" | A                              | 24.41    | 15.27     | 9.14   | YES       | YES           | 625       | 115         |
| 85909   | ES36     | ES36  | 1-5/8" | G                              | 24.25    | 15.19     | 9.06   | YES       | YES           | 700       | 255         |
| 85975   | ES36     | ES36  | 1-5/8" | G                              | 24.24    | 15.15     | 9.09   | YES       | YES           | 1658      | 219         |
| 83310   | ES36     | ES36  | 1-3/8" | B                              | 24.06    | 14.69     | 9.37   | YES       | NO            | 559       | 153         |
| 85030   | ES36     | ES36  | 1-5/8" | C                              | 24.05    | 14.89     | 9.16   | YES       | YES           | 1019      | 219         |
| 83221   | ES36     | ES36  | 1-3/8" | A                              | 24.01    | 14.73     | 9.28   | YES       | YES           | 599       | 153         |
| 89440   | ES36     | ES36  | 1-5/8" | G                              | 23.9     | 15.31     | 8.59   | YES       | YES           | 1498‡     | 561         |

\* Damping force, in pounds, to either extend or collapse the shock absorber at an average operating velocity. Fuerza de amortiguación en libras para extender o comprimir el amortiguador a una velocidad de operación promedio. La puissance d'amortissement en poids de l'amortisseur, soit comprimé, soit détendu, à une vitesse de fonctionnement moyenne.

**SPECIFICATIONS BY END MOUNT**  
**ESPECIFICACIONES POR TIPO DE MONTAJE**  
**SPÉCIFICATIONS PAR FIXATION DES EXTRÉMITÉS**

| Gabriel | Mounting |       | Bore    | External Diameter Illustration | Lengths  |           |        | Dust Tube | Recoil Cutoff | Controls* |             |
|---------|----------|-------|---------|--------------------------------|----------|-----------|--------|-----------|---------------|-----------|-------------|
|         | Upper    | Lower |         |                                | Extended | Collapsed | Stroke |           |               | Rebound   | Compression |
| 83144   | ES36     | ES36  | 1-3/8"  | A                              | 23.78    | 15.03     | 8.74   | YES       | YES           | 596       | 93          |
| 89432   | ES36     | ES36  | 1-5/8"  | G                              | 23.42    | 14.79     | 8.63   | YES       | NO            | 1507‡     | 561         |
| 85050   | ES36     | ES36  | 1-5/8"  | C                              | 23.28    | 14.5      | 9.03   | YES       | NO            | 525       | 138         |
| 665937  | ES36     | ES36  | 1-5/8"  | G                              | 22.91    | 16.09     | 6.82   | YES       | NO            |           |             |
| 85058   | ES36     | ES36  | 1-5/8"  | C                              | 22.67    | 14.26     | 8.41   | YES       | YES           | 722       | 114         |
| 85044   | ES36     | ES36  | 1-5/8"  | C                              | 22.63    | 14.1      | 8.53   | YES       | NO            | 722       | 212         |
| 85971   | ES36     | ES36  | 1-5/8"  | G                              | 22.56    | 14.17     | 8.39   | YES       | NO            | 2315      | 451         |
| 85919   | ES36     | ES36  | 1-5/8"  | G                              | 22.52    | 14.33     | 8.19   | YES       | YES           | 1265      | 121         |
| 632155  | ES36     | ES36  | 1-3/16" |                                | 22.45    | 14.1      | 8.35   | NO        | NO            |           |             |
| 646155  | ES36     | ES36  | 1-3/16" |                                | 22.45    | 14.1      | 8.35   | YES       | NO            |           |             |
| 646177  | ES36     | ES36  | 1-3/16" |                                | 22.45    | 14.1      | 8.35   | NO        | NO            |           |             |
| 89431   | ES36     | ES36  | 1-5/8"  | G                              | 22.41    | 14.16     | 8.25   | YES       | NO            | 751‡      | 211         |
| 85345   | ES36     | ES36  | 1-5/8"  | D                              | 21.83    | 13.82     | 8.01   | YES       | YES           | 1093      | 219         |
| 85906   | ES36     | ES36  | 1-5/8"  | G                              | 21.77    | 14.05     | 7.72   | YES       | YES           | 700       | 255         |
| 85014   | ES36     | ES36  | 1-5/8"  | C                              | 21.76    | 13.74     | 8.02   | YES       | YES           | 1019      | 219         |
| 83124   | ES36     | ES36  | 1-3/8"  | A                              | 21.65    | 13.77     | 7.88   | YES       | YES           | 750       | 137         |
| 83207   | ES36     | ES36  | 1-3/8"  | A                              | 21.64    | 13.61     | 8.03   | YES       | YES           | 553       | 143         |
| 89407   | ES36     | ES36  | 1-5/8"  | G                              | 21.61    | 14.17     | 7.45   | YES       | YES           | 652‡      | 218         |
| 85091   | ES36     | ES36  | 1-5/8"  | C                              | 21.38    | 13.56     | 7.82   | YES       | NO            | 1121      | 331         |
| 85910   | ES36     | ES36  | 1-5/8"  | G                              | 20.79    | 13.54     | 7.25   | YES       | YES           | 1074      | 219         |
| 85029   | ES36     | ES36  | 1-5/8"  | C                              | 20.54    | 13.11     | 7.43   | YES       | YES           | 1019      | 219         |
| 85382   | ES36     | ES36  | 1-5/8"  | D                              | 20.22    | 13.07     | 7.15   | YES       | YES           | 1658      | 420         |
| 83127   | ES36     | ES36  | 1-3/8"  | A                              | 20.16    | 13.14     | 7.01   | YES       | YES           | 940       | 218         |
| 83204   | ES36     | ES36  | 1-3/8"  | A                              | 20.14    | 12.86     | 7.28   | YES       | YES           | 451       | 110         |
| 89437   | ES36     | ES36  | 1-5/8"  | G                              | 20.12    | 13.42     | 6.7    | YES       | YES           | 1155‡     | 514         |
| 85060   | ES36     | ES36  | 1-5/8"  | C                              | 19.79    | 12.76     | 7.04   | YES       | YES           | 943       | 405         |
| 85338   | ES36     | ES36  | 1-5/8"  | D                              | 19.47    | 12.68     | 6.79   | YES       | YES           | 1664      | 420         |
| 85051   | ES36     | ES36  | 1-5/8"  | C                              | 18.54    | 12.13     | 6.41   | YES       | YES           | 1019      | 139         |
| 85908   | ES36     | ES36  | 1-5/8"  | G                              | 18.48    | 12.25     | 6.23   | YES       | YES           | 1020      | 219         |
| 83130   | ES36     | ES36  | 1-3/8"  | A                              | 18.03    | 12.04     | 5.99   | YES       | YES           | 871       | 177         |
| 85934   | ES36     | ES36  | 1-5/8"  | G                              | 17.8     | 12.04     | 5.75   | YES       | YES           | 3511      | 1063        |
| 85086   | ES36     | ES36  | 1-5/8"  | C                              | 17.55    | 11.63     | 5.92   | YES       | YES           | 2027      | 389         |
| 85738   | ES36     | ES36  | 1-5/8"  | D                              | 17.46    | 11.69     | 5.77   | YES       | YES           | 1830      | 416         |
| 85323   | ES36     | ES36  | 1-5/8"  | D                              | 17.36    | 11.58     | 5.78   | YES       | YES           | 1085      | 163         |
| 87018   | ES36     | ES36  | 2-1/16" | E                              | 17.36    | 11.71     | 5.65   | YES       | YES           | 2479      | 1000        |
| 83389   | ES36     | ES36  | 1-3/8"  | A                              | 17.32    | 11.57     | 5.75   | YES       | YES           | 1084      | 228         |
| 85000   | ES36     | ES36  | 1-5/8"  | C                              | 17.28    | 11.5      | 5.78   | YES       | YES           | 1019      | 219         |

\* Damping force, in pounds, to either extend or collapse the shock absorber at an average operating velocity. Fuerza de amortiguación en libras para extender o comprimir el amortiguador a una velocidad de operación promedio. La puissance d'amortissement en poids de l'amortisseur, soit comprimé, doit détendu, à une vitesse de fonctionnement moyenne.

† At bumper contact / Al contacto cone el tope de goma / Au contact avec le butoir

**SPECIFICATIONS BY END MOUNT**  
**ESPECIFICACIONES POR TIPO DE MONTAJE**  
**SPÉCIFICATIONS PAR FIXATION DES EXTRÉMITÉS**

| Gabriel | Mounting |       | Bore   | External Diameter Illustration | Lengths  |           |        | Dust Tube | Recoil Cutoff | Controls* |             |
|---------|----------|-------|--------|--------------------------------|----------|-----------|--------|-----------|---------------|-----------|-------------|
|         | Upper    | Lower |        |                                | Extended | Collapsed | Stroke |           |               | Rebound   | Compression |
| 89436   | ES36     | ES36  | 1-5/8" | G                              | 17.24    | 12.04     | 5.2    | YES       | YES           | 998‡      | 217         |
| 83203   | ES36     | ES36  | 1-3/8" | A                              | 17.1     | 11.36     | 5.74   | YES       | YES           | 609       | 114         |
| 83128   | ES36     | ES36  | 1-3/8" | A                              | 16.89    | 11.53     | 5.36   | YES       | YES           | 940       | 218         |
| 85911   | ES36     | ES36  | 1-5/8" | G                              | 16.89    | 11.53     | 5.36   | YES       | YES           | 1020      | 219         |
| 83363   | ES36     | ES36  | 1-3/8" | A                              | 16.46    | 11.35     | 5.11   | YES       | YES           | 1084      | 201         |
| 85938   | ES36     | ES36  | 1-5/8" | G                              | 16.06    | 10.82     | 5.24   | YES       | YES           | 1581      | 432         |
| 85064   | ES36     | ES36  | 1-5/8" | C                              | 16.02    | 10.75     | 5.27   | YES       | YES           | 1481      | 340         |
| 83150   | ES36     | ES36  | 1-3/8" | A                              | 15.24    | 10.43     | 4.81   | YES       | YES           | 940       | 216         |
| 85078   | ES36     | ES36  | 1-5/8" | C                              | 14.76    | 10.12     | 4.64   | YES       | YES           | 1409      | 282         |
| 85045   | ES36     | ES36  | 1-5/8" | C                              | 14.52    | 10.12     | 4.4    | YES       | YES           | 1020      | 219         |
| 85939   | ES36     | ES36  | 1-5/8" | G                              | 14.44    | 10.04     | 4.41   | YES       | YES           | 1719      | 420         |
| 85914   | ES36     | ES36  | 1-5/8" | G                              | 14.36    | 10.25     | 4.11   | YES       | YES           | 1020      | 219         |
| 85052   | ES36     | ES36  | 1-5/8" | C                              | 13.26    | 9.49      | 3.77   | YES       | YES           | 1429      | 335         |
| 85344   | ES36     | ES36  | 1-5/8" | D                              | 13.22    | 9.45      | 3.77   | YES       | YES           | 1581      | 443         |
| 85079   | ES36     | ES36  | 1-5/8" | C                              | 12.04    | 8.87      | 3.17   | YES       | YES           | 1494      | 325         |
| 83157   | ES36     | ES90  | 1-3/8" | A                              | 26.38    | 15.76     | 10.61  | YES       | NO            | 446       | 303         |
| 85102   | ES36     | ES136 | 1-5/8" | C                              | 21.52    | 14.93     | 6.59   | YES       | YES           | 1224      | 342         |
| 83164   | ES36     | ES165 | 1-3/8" | C                              | 24.22    | 14.59     | 9.63   | YES       | NO            | 426       | 274         |
| 85072   | ES36     | ES176 | 1-5/8" | C                              | 24.17    | 14.81     | 9.36   | YES       | YES           | 1387      | 305         |
| 85087   | ES36     | ES176 | 1-5/8" | C                              | 22.78    | 14.7      | 8.08   | YES       | YES           | 1568      | 403         |
| 85109   | ES36     | ES195 | 1-5/8" | C                              | 24.21    | 15.14     | 9.07   | YES       | YES           | 1123      | 149         |
| 83635   | ES36     | S21   | 1-3/8" | A                              | 21.74    | 13.25     | 8.49   | YES       | NO            | 558       | 119         |
| 85977   | ES36     | S42   | 1-5/8" | G                              | 26.2     | 15.91     | 10.29  | YES       | YES           | 582       | 138         |
| 83109   | ES36     | S42   | 1-3/8" | A                              | 26.17    | 15.93     | 10.24  | YES       | YES           | 345       | 78          |
| 83111   | ES36     | S42   | 1-3/8" | A                              | 26.17    | 15.93     | 10.24  | YES       | YES           | 560       | 141         |
| 83138   | ES36     | S42   | 1-3/8" | A                              | 23.55    | 14.42     | 9.12   | YES       | YES           | 997       | 231         |
| 83110   | ES36     | S42   | 1-3/8" | A                              | 22.94    | 14.31     | 8.63   | YES       | YES           | 450       | 143         |
| 83112   | ES36     | S42   | 1-3/8" | A                              | 21.52    | 13.41     | 8.11   | YES       | YES           | 1064      | 343         |
| 83033   | ES53     | ES53  | 1-3/8" | A                              | 13.99    | 10.37     | 3.62   | YES       | YES           | 494       | 312         |
| G63676  | ES69     | ES69  | 1-3/8" |                                | 15.58    | 10.55     | 5.03   | YES       | YES           |           |             |
| G63403  | ES82     | ES82  | 1-3/8" |                                | 24.58    | 14.8      | 9.78   | YES       | NO            |           |             |
| 83131   | ES83     | ES83  | 1-3/8" | A                              | 27.8     | 18.18     | 9.62   | YES       | NO            | 212       | 129         |
| 83145   | ES83     | ES83  | 1-3/8" | A                              | 19.93    | 12.32     | 7.54   | YES       | NO            | 479       | 153         |
| 83906   | ES85     | EB1   | 1-3/8" | 2-1/2" D/T                     | 10.45†   | 8.41†     | 3.01   | YES       | YES           | 586       | 320         |
| 83905   | ES86     | ES167 | 1-3/8" | 2-1/2" D/T                     | 9.3†     | 7.81†     | 2.21   | YES       | YES           | 1105      | 170         |
| 83048   | ES86     | ES167 | 1-3/8" | A                              | 9.97     | 8.43†     | 2.37   | YES       | YES           | 904       | 415         |
| 83028   | ES86     | ES167 | 1-3/8" | A                              | 9.96     | 7.6       | 2.33   | YES       | YES           | 445       | 531         |
| 85639   | ES90     | ES36  | 1-5/8" | G                              | 27.08    | 17.79     | 9.29   | YES       | NO            | 795       | 109         |

\* Damping force, in pounds, to either extend or collapse the shock absorber at an average operating velocity. Fuerza de amortiguación en libras para extender o comprimir el amortiguador a una velocidad de operación promedio. La puissance d'amortissement en poids de l'amortisseur, soit comprimé, doit détendu, à une vitesse de fonctionnement moyenne.



**SPECIFICATIONS BY END MOUNT**  
**ESPECIFICACIONES POR TIPO DE MONTAJE**  
**SPÉCIFICATIONS PAR FIXATION DES EXTRÉMITÉS**

| Gabriel | Mounting |       | Bore    | External Diameter Illustration | Lengths  |           |        | Dust Tube | Recoil Cutoff | Controls* |             |
|---------|----------|-------|---------|--------------------------------|----------|-----------|--------|-----------|---------------|-----------|-------------|
|         | Upper    | Lower |         |                                | Extended | Collapsed | Stroke |           |               | Rebound   | Compression |
| 85963   | ES90     | ES36  | 1-5/8"  | G                              | 25.49    | 18.68     | 6.81   | YES       | YES           | 1490      | 206         |
| 85964   | ES90     | ES36  | 1-5/8"  | G                              | 25.49    | 18.68     | 6.81   | YES       | YES           | 1981      | 205         |
| 85995   | ES90     | ES36  | 1-5/8"  | G                              | 23.5     | 14.52     | 8.98   | YES       | NO            | 1830      | 173         |
| 85994   | ES90     | ES36  | 1-5/8"  | G                              | 21.21    | 13.4      | 7.81   | YES       | NO            | 1824      | 263         |
| 85637   | ES90     | ES36  | 1-5/8"  | G                              | 20.74    | 13.19     | 7.55   | YES       | NO            | 2256      | 327         |
| 85954   | ES90     | ES36  | 1-5/8"  | G                              | 20.43    | 13        | 7.43   | YES       | NO            | 1812      | 148         |
| 85924   | ES90     | ES36  | 1-5/8"  | G                              | 20.39    | 12.99     | 7.41   | YES       | NO            | 1036      | 122         |
| 89457   | ES90     | ES36  | 1-5/8"  | G                              | 19.92    | 13.02     | 6.89   | YES       | NO            | 941‡      | 156         |
| 85969   | ES90     | ES36  | 1-5/8"  | G                              | 18.38    | 11.93     | 6.45   | YES       | NO            | 1612      | 125         |
| 83180   | ES90     | ES83  | 1-3/8"  |                                | 30.2     | 21.24     | 8.96   | YES       | NO            | 909       | 204         |
| 83364   | ES90     | ES83  | 1-3/8"  | A                              | 24.06    | 15.07     | 8.99   | YES       | YES           | 855       | 206         |
| 83146   | ES90     | ES83  | 1-3/8"  | A                              | 24.02    | 14.68     | 9.33   | YES       | YES           | 479       | 119         |
| 85082   | ES90     | ES90  | 1-5/8"  | C                              | 28.6     | 20.64     | 7.97   | YES       | YES           | 1435      | 266         |
| 83636   | ES90     | ES90  | 1-3/8"  | A                              | 27.72    | 16.95     | 10.77  | YES       | YES           | 505       | 148         |
| 83100   | ES90     | ES90  | 1-3/8"  | A                              | 26.6     | 16.11     | 10.49  | YES       | YES           | 481       | 142         |
| 85926   | ES90     | ES90  | 1-5/8"  | G                              | 26.5     | 17.96     | 8.54   | YES       | YES           | 1387      | 279         |
| 85953   | ES90     | ES90  | 1-5/8"  | G                              | 26.13    | 15.86     | 10.27  | YES       | NO            | 2001      | 153         |
| 85003   | ES90     | ES90  | 1-5/8"  | C                              | 25.42    | 15.63     | 9.79   | YES       | YES           | 437       | 182         |
| 89411   | ES90     | ES90  | 1-5/8"  | G                              | 25.39    | 16.06     | 9.34   | YES       | YES           | 436‡      | 186         |
| 85927   | ES90     | ES90  | 1-5/8"  | G                              | 24.76    | 15.47     | 9.3    | YES       | YES           | 1288      | 388         |
| 83101   | ES90     | ES90  | 1-3/8"  | A                              | 24.63    | 15.13     | 9.49   | YES       | YES           | 481       | 142         |
| 85998   | ES90     | ES90  | 1-5/8"  | G                              | 22.83    | 14.17     | 8.66   | YES       | NO            | 1345      | 178         |
| 85925   | ES90     | ES90  | 1-5/8"  | G                              | 22.56    | 15.6      | 6.95   | YES       | NO            | 761       | 144         |
| 85957   | ES90     | ES90  | 1-5/8"  | G                              | 20.78    | 13.19     | 7.6    | YES       | NO            | 1583      | 138         |
| 85928   | ES90     | ES90  | 1-5/8"  | G                              | 20.31    | 13.24     | 7.07   | YES       | NO            | 957       | 229         |
| 85929   | ES90     | ES90  | 1-5/8"  | G                              | 20.28    | 13.21     | 7.08   | YES       | NO            | 2214      | 267         |
| 85999   | ES90     | ES90  | 1-5/8"  | G                              | 19.84    | 12.79     | 7.05   | YES       | NO            | 2214      | 259         |
| 83135   | ES90     | ES90  | 1-3/8"  | A                              | 19.49    | 12.38     | 7.11   | YES       | NO            | 519       | 121         |
| 83167   | ES90     | ES90  | 1-3/8"  | A                              | 19.49    | 12.38     | 7.11   | YES       | NO            | 285       | 90          |
| 83156   | ES90     | ES90  | 1-3/8"  | A                              | 18.55    | 11.91     | 6.64   | YES       | NO            | 778       | 135         |
| 83169   | ES90     | ES90  | 1-3/8"  | A                              | 18.55    | 11.91     | 6.64   | YES       | NO            | 599       | 171         |
| 83020   | ES91     | ES91  | 1-3/8"  | A                              | 9.41     | 7.17      | 2.24   | YES       | YES           | 796       | 255         |
| 83034   | ES115    | ES115 | 1-3/16" | 1-5/8"                         | 10.04†   | 7.32      | 2.97   | NO        | YES           | 430       | 129         |
| 83634   | ES120    | ES120 | 1-3/8"  | A                              | 27.48    | 16.23     | 11.25  | YES       | YES           | 779       | 157         |
| 85011   | ES120    | ES121 | 1-5/8"  | C                              | 27.49    | 16.46     | 11.03  | YES       | NO            | 1268      | 186         |
| 85122   | ES120    | S21   | 1-5/8"  | C                              | 22.22    | 13.78     | 8.44   | YES       | YES           | 926       | 162         |
| 83120   | ES120    | S21   | 1-3/8"  | A                              | 22.17    | 13.66     | 8.51   | YES       | YES           | 779       | 164         |
| 85123   | ES120    | S21   | 1-5/8"  | C                              | 21.49    | 13.26     | 8.23   | YES       | NO            | 1809      | 246         |

\* Damping force, in pounds, to either extend or collapse the shock absorber at an average operating velocity. Fuerza de amortiguación en libras para extender o comprimir el amortiguador a una velocidad de operación promedio. La puissance d'amortissement en poids de l'amortisseur, soit comprimé, doit détendu, à une vitesse de fonctionnement moyenne.

† At bumper contact / Al contacto cone el tope de goma / Au contact avec le butoir

**SPECIFICATIONS BY END MOUNT**  
**ESPECIFICACIONES POR TIPO DE MONTAJE**  
**SPÉCIFICATIONS PAR FIXATION DES EXTRÉMITÉS**

| Gabriel | Mounting |       | Bore   | External Diameter Illustration | Lengths  |           |        | Dust Tube | Recoil Cutoff | Controls* |             |
|---------|----------|-------|--------|--------------------------------|----------|-----------|--------|-----------|---------------|-----------|-------------|
|         | Upper    | Lower |        |                                | Extended | Collapsed | Stroke |           |               | Rebound   | Compression |
| 83154   | ES120    | S21   | 1-3/8" | A                              | 20.78    | 12.72     | 8.06   | YES       | YES           | 599       | 140         |
| 83081   | ES126    | ES172 | 1-3/8" | A                              | 13.39    | 9.98†     | 4      | YES       | YES           | 1004      | 232         |
| 83160   | ES128    | ES36  | 1-3/8" | A                              | 24.31    | 14.9      | 9.37   | YES       | YES           | 920       | 161         |
| 83174   | ES128    | ES36  | 1-3/8" | A                              | 24.31    | 14.9      | 9.37   | YES       | YES           | 795       | 160         |
| 83042   | ES136    | ES136 | 1-3/8" | A                              | 9.89†    | 8.52†     | 2.39   | YES       | YES           | 954       | 541         |
| 83030   | ES136    | ES136 | 1-3/8" | A                              | 9.61†    | 7.61      | 2.5    | YES       | YES           | 308       | 87          |
| 83008   | ES136    | ES136 | 1-3/8" | A                              | 13†      | 10.13†    | 4      | YES       | YES           | 699       | 307         |
| 83056   | ES136    | ES136 | 1-5/8" | C                              | 11.53    | 8.63      | 2.89   | YES       | YES           | 3830      | 737         |
| 85026   | ES136    | S21   | 1-5/8" | C                              | 23.02    | 14.01     | 9.01   | YES       | NO            | 1079      | 539         |
| 89417   | ES136    | S21   | 1-5/8" | G                              | 22.94    | 14.31     | 8.63   | YES       | NO            | 1226‡     | 515         |
| 83047   | ES149    | EB1   | 1-3/8" | A                              | 11.78†   | 9.74†     | 3      | YES       | YES           | 364       | 314         |
| 83001   | ES149    | EB1   | 1-3/8" | A                              | 10.45†   | 8.41†     | 3      | YES       | YES           | 793       | 363         |
| 83038   | ES149    | EB1   | 1-3/8" | A                              | 10.45†   | 8.41†     | 3      | YES       | YES           | 336       | 242         |
| 83006   | ES149    | EB1   | 1-3/8" | A                              | 10.71    | 8.52†     | 2.78   | YES       | YES           | 525       | 182         |
| 83009   | ES149    | ES149 | 1-3/8" | A                              | 10.45†   | 8.41†     | 3      | YES       | YES           | 793       | 363         |
| 83039   | ES149    | ES149 | 1-3/8" | A                              | 10.44†   | 8.4†      | 3      | YES       | YES           | 876       | 326         |
| 83064   | ES149    | ES149 | 1-3/8" | A                              | 10.41†   | 8.36†     | 2.99   | YES       | YES           | 635       | 323         |
| 83017   | ES149    | ES149 | 1-3/8" | A                              | 10.95    | 8.41†     | 3.13   | YES       | YES           | 353       | 138         |
| 85090   | ES150    | ES36  | 1-5/8" | C                              | 25.31    | 15.52     | 9.79   | YES       | YES           | 943       | 99          |
| 85180   | ES150    | ES36  | 1-5/8" | C                              | 20.94    | 13.83     | 7.11   | YES       | YES           | 681       | 283         |
| 85181   | ES150    | ES150 | 1-5/8" | C                              | 26.33    | 17.06     | 9.27   | YES       | YES           | 681       | 285         |
| 89449   | ES150    | ES150 | 1-5/8" | G                              | 23.25    | 14.9      | 8.35   | YES       | NO            | 1519‡     | 324         |
| 85918   | ES150    | ES150 | 1-5/8" | G                              | 22.97    | 14.58     | 8.39   | YES       | NO            | 1726      | 412         |
| 85958   | ES150    | ES150 | 1-5/8" | G                              | 22.89    | 14.5      | 8.39   | YES       | YES           | 1926      | 281         |
| 89503   | ES150    | ES150 | 1-5/8" | G                              | 21.28    | 13.72     | 7.56   | YES       | NO            | 1033‡     | 123         |
| 85106   | ES150    | ES150 | 1-5/8" | C                              | 20.03    | 12.89     | 7.14   | YES       | YES           | 1054      | 109         |
| 85119   | ES150    | ES150 | 1-5/8" | C                              | 21.39    | 13.81     | 7.68   | YES       | YES           | 1387      | 185         |
| 85922   | ES150    | ES150 | 1-5/8" | G                              | 21.19    | 13.53     | 7.66   | YES       | NO            | 878       | 185         |
| 85920   | ES150    | ES150 | 1-5/8" | G                              | 21.16    | 13.57     | 7.59   | YES       | NO            | 845       | 49          |
| 85959   | ES150    | ES150 | 1-5/8" | G                              | 21.16    | 13.57     | 7.59   | YES       | YES           | 1021      | 123         |
| 85092   | ES150    | S21   | 1-5/8" | C                              | 21.95    | 15.04     | 6.89   | YES       | YES           | 1597      | 138         |
| 83066   | ES153    | ES153 | 1-3/8" | A                              | 11.15†   | 9.2†      | 2.78   | YES       | YES           | 599       | 221         |
| 83901   | ES153    | ES153 | 1-3/8" | A                              | 11.15†   | 9.2†      | 2.78   | YES       | YES           | 509       | 204         |
| 85984   | ES158    | ES150 | 1-5/8" | G                              | 25.44    | 15.96     | 9.48   | YES       | YES           | 2248      | 1168        |
| 85125   | ES158    | ES159 | 1-5/8" | C                              | 26.9     | 16.64     | 10.26  | YES       | YES           | 1479      | 183         |
| 85724   | ES158    | ES159 | 1-5/8" | D                              | 22.81    | 14.51     | 8.3    | YES       | YES           | 1235      | 454         |
| 89443   | ES158    | ES159 | 1-5/8" | G                              | 22.19    | 14.66     | 7.53   | YES       | YES           | 1206‡     | 466         |
| 85331   | ES158    | ES159 | 1-5/8" | D                              | 19.62    | 12.85     | 6.77   | YES       | YES           | 1757      | 396         |

\* Damping force, in pounds, to either extend or collapse the shock absorber at an average operating velocity. Fuerza de amortiguación en libras para extender o comprimir el amortiguador a una velocidad de operación promedio. La puissance d'amortissement en poids de l'amortisseur, soit comprimé, doit détendu, à une vitesse de fonctionnement moyenne.

**SPECIFICATIONS BY END MOUNT**  
**ESPECIFICACIONES POR TIPO DE MONTAJE**  
**SPÉCIFICATIONS PAR FIXATION DES EXTRÉMITÉS**

| Gabriel | Mounting |       | Bore    | External Diameter Illustration | Lengths  |           |        | Dust Tube | Recoil Cutoff | Controls* |             |
|---------|----------|-------|---------|--------------------------------|----------|-----------|--------|-----------|---------------|-----------|-------------|
|         | Upper    | Lower |         |                                | Extended | Collapsed | Stroke |           |               | Rebound   | Compression |
| 85335   | ES158    | ES159 | 1-5/8"  | D                              | 19.62    | 12.85     | 6.77   | YES       | YES           | 827       | 107         |
| 85126   | ES158    | S21   | 1-5/8"  | C                              | 21.76    | 13.63     | 8.13   | YES       | YES           | 1086      | 215         |
| 87019   | ES160    | ES160 | 2-1/16" | E                              | 24.84    | 15.85     | 8.9    | YES       | YES           | 2972      | 665         |
| 87017   | ES160    | ES160 | 2-1/16" | E                              | 23.35    | 15.31     | 8.07   | YES       | YES           | 1876      | 220         |
| 89461   | ES160    | ES160 | 1-5/8"  | G                              | 19.96    | 13.58     | 6.38   | YES       | YES           | 897‡      | 103         |
| 85088   | ES161    | ES162 | 1-5/8"  | C                              | 25.31    | 15.52     | 9.79   | YES       | YES           | 616       | 178         |
| 85061   | ES161    | ES162 | 1-5/8"  | C                              | 24.76    | 15.25     | 9.51   | YES       | YES           | 1216      | 195         |
| 85066   | ES161    | ES162 | 1-5/8"  | C                              | 24.64    | 15.25     | 9.39   | YES       | YES           | 812       | 322         |
| 85098   | ES161    | ES162 | 1-5/8"  | C                              | 24.64    | 15.24     | 9.4    | YES       | YES           | 747       | 158         |
| 89448   | ES161    | ES162 | 1-5/8"  | G                              | 24.61    | 15.66     | 8.94   | YES       | YES           | 782‡      | 323         |
| 89450   | ES161    | ES162 | 1-5/8"  | G                              | 24.61    | 15.66     | 8.94   | YES       | YES           | 1282‡     | 193         |
| 85065   | ES161    | S21   | 1-5/8"  | C                              | 28.05    | 17        | 11.05  | YES       | YES           | 1059      | 300         |
| 85083   | ES162    | S42   | 1-5/8"  | C                              | 27.81    | 16.53     | 11.28  | YES       | YES           | 1429      | 184         |
| 83142   | ES162    | S42   | 1-3/8"  | A                              | 23.92    | 14.49     | 9.43   | YES       | YES           | 367       | 131         |
| 83143   | ES162    | S42   | 1-3/8"  | A                              | 21.92    | 13.51     | 8.41   | YES       | YES           | 403       | 137         |
| 83025   | ES163    | ES163 | 1-3/8"  | A                              | 8.02     | 6.53      | 1.48   | YES       | YES           | 710       | 230         |
| 83049   | ES163    | ES163 | 1-3/8"  | A                              | 8.02     | 6.53      | 1.48   | YES       | YES           | 2879      | 705         |
| 83032   | ES163    | ES163 | 1-3/8"  | A                              | 7.85     | 6.36      | 1.49   | NO        | YES           | 779       | 135         |
| 83118   | ES164    | ES90  | 1-3/8"  | A                              | 24.45    | 14.71     | 9.74   | YES       | NO            | 410       | 311         |
| 83116   | ES164    | ES165 | 1-3/8"  | A                              | 23.81    | 14.68     | 9.12   | YES       | NO            | 354       | 300         |
| 83035   | ES166    | ES136 | 1-3/8"  | A                              | 13.04†   | 9.33      | 4.22   | YES       | YES           | 320       | 100         |
| 83067   | ES166    | ES136 | 1-3/16" | 2" D/T                         | 12.33†   | 9.27      | 3.56   | YES       | YES           | 424       | 101         |
| 83029   | ES168    | ES169 | 1-5/8"  | C                              | 10.35    | 7.87      | 2.41   | YES       | NO            | 1303      | 1349        |
| 83040   | ES171    | ES172 | 1-3/8"  | A                              | 10.44†   | 8.4†      | 3      | YES       | YES           | 876       | 326         |
| 83057   | ES171    | ES172 | 1-3/8"  | 2-1/2" D/T                     | 10.44†   | 8.4†      | 2.99   | YES       | YES           | 364       | 242         |
| 87015   | ES173    | ES173 | 45MM    | E                              | 15.51    | 11.18     | 4.33   | YES       | YES           | 4950      | 900         |
| 85737   | ES173    | ES173 | 1-5/8"  | D                              | 15.11    | 10.84     | 4.27   | YES       | YES           | 3066      | 782         |
| 89459   | ES174    | EB3   | 1-5/8"  | G                              | 25.63    | 16.14     | 9.49   | YES       | NO            | 1179‡     | 314         |
| 85070   | ES174    | EB3   | 1-5/8"  | C                              | 25.59    | 15.83     | 9.76   | YES       | NO            | 1100      | 310         |
| 85067   | ES174    | ES136 | 1-5/8"  | C                              | 30.54    | 18.15     | 12.39  | YES       | YES           | 676       | 170         |
| 89451   | ES174    | ES136 | 1-5/8"  | G                              | 30.39    | 18.54     | 11.86  | YES       | YES           | 645‡      | 172         |
| 85989   | ES174    | ES136 | 1-5/8"  | G                              | 20.78    | 13.15     | 7.63   | YES       | NO            | 1812      | 351         |
| 85084   | ES174    | ES136 | 1-5/8"  | C                              | 20.59    | 13.03     | 7.57   | YES       | NO            | 1145      | 407         |
| 89460   | ES174    | ES136 | 1-5/8"  | G                              | 20.58    | 13.03     | 7.55   | YES       | NO            | 997‡      | 384         |
| 85937   | ES174    | S43   | 1-5/8"  | G                              | 19.04    | 12.35     | 6.7    | YES       | YES           | 1479      | 337         |
| 85985   | ES174    | S43   | 1-5/8"  | G                              | 19.04    | 12.31     | 6.73   | YES       | YES           | 2068      | 723         |
| 85936   | ES174    | S43   | 1-5/8"  | G                              | 17.27    | 11.48     | 5.79   | YES       | YES           | 1479      | 337         |
| 89456   | ES174    | S43   | 1-5/8"  | G                              | 17.04    | 11.63     | 5.4    | YES       | YES           | 975‡      | 377         |

\* Damping force, in pounds, to either extend or collapse the shock absorber at an average operating velocity. Fuerza de amortiguación en libras para extender o comprimir el amortiguador a una velocidad de operación promedio. La puissance d'amortissement en poids de l'amortisseur, soit comprimé, doit détendu, à une vitesse de fonctionnement moyenne.

† At bumper contact / Al contacto cone el tope de goma / Au contact avec le butoir

**SPECIFICATIONS BY END MOUNT**  
**ESPECIFICACIONES POR TIPO DE MONTAJE**  
**SPÉCIFICATIONS PAR FIXATION DES EXTRÉMITÉS**

| Gabriel | Mounting |       | Bore   | External Diameter Illustration | Lengths  |           |        | Dust Tube | Recoil Cutoff | Controls* |             |
|---------|----------|-------|--------|--------------------------------|----------|-----------|--------|-----------|---------------|-----------|-------------|
|         | Upper    | Lower |        |                                | Extended | Collapsed | Stroke |           |               | Rebound   | Compression |
| 83063   | ES175    | ES136 | 1-3/8" | A                              | 10.76†   | 9.26†     | 3.01   | YES       | YES           | 954       | 541         |
| 85955   | ES175    | ES150 | 1-5/8" | G                              | 21.25    | 13.66     | 7.59   | YES       | YES           | 1034      | 397         |
| 85986   | ES175    | ES150 | 1-5/8" | G                              | 21.25    | 13.66     | 7.59   | YES       | YES           | 1754      | 221         |
| 85120   | ES175    | ES175 | 1-5/8" | C                              | 23.67    | 15.06     | 8.61   | YES       | NO            | 2083      | 519         |
| 83163   | ES175    | ES175 | 1-3/8" | A                              | 20.75    | 13.01     | 7.74   | YES       | NO            | 828       | 98          |
| 83175   | ES175    | ES175 | 1-3/8" | A                              | 20.48    | 13.19     | 7.29   | YES       | NO            | 1245      | 156         |
| 85933   | ES175    | ES175 | 1-5/8" | G                              | 18.27    | 12.72     | 5.54   | YES       | YES           | 1089      | 383         |
| 89454   | ES175    | ES175 | 1-5/8" | G                              | 18.27    | 12.91     | 5.36   | YES       | YES           | 938‡      | 388         |
| 85081   | ES175    | S21   | 1-5/8" | C                              | 23.44    | 14.33     | 9.11   | YES       | YES           | 1658      | 250         |
| 85080   | ES175    | S21   | 1-5/8" | C                              | 22.51    | 13.77     | 8.74   | YES       | NO            | 447       | 138         |
| 85031   | ES176    | EB2   | 1-5/8" | C                              | 25.63    | 15.87     | 9.76   | YES       | NO            | 941       | 257         |
| 85923   | ES177    | ES161 | 1-5/8" | G                              | 22.52    | 14.52     | 8      | YES       | YES           | 1940      | 221         |
| 85931   | ES177    | ES161 | 1-5/8" | G                              | 22.52    | 14.52     | 8      | YES       | YES           | 1435      | 220         |
| 89458   | ES177    | ES161 | 1-5/8" | G                              | 22.48    | 14.6      | 7.88   | YES       | YES           | 1575‡     | 222         |
| 85930   | ES177    | ES161 | 1-5/8" | G                              | 17.86    | 12        | 5.86   | YES       | YES           | 1617      | 342         |
| 85932   | ES178    | ES150 | 1-5/8" | G                              | 21.26    | 13.7      | 7.56   | YES       | YES           | 1102      | 430         |
| 89453   | ES178    | ES150 | 1-5/8" | G                              | 21.14    | 13.93     | 7.21   | YES       | YES           | 860‡      | 435         |
| 85965   | ES178    | ES161 | 1-5/8" | G                              | 24.24    | 15.15     | 9.09   | YES       | YES           | 2206      | 238         |
| 85966   | ES178    | ES161 | 1-5/8" | G                              | 23.25    | 14.64     | 8.62   | YES       | YES           | 2206      | 238         |
| 85967   | ES178    | ES176 | 1-5/8" | G                              | 23.93    | 14.86     | 9.07   | YES       | YES           | 2206      | 238         |
| 85961   | ES178    | ES176 | 1-5/8" | G                              | 22.83    | 14.17     | 8.66   | YES       | YES           | 2206      | 240         |
| 85962   | ES178    | ES176 | 1-5/8" | G                              | 21.8     | 13.66     | 8.15   | YES       | YES           | 2206      | 240         |
| 85980   | ES179    | ES179 | 1-5/8" | G                              | 31.17    | 18.66     | 12.52  | YES       | YES           | 582       | 138         |
| 83148   | ES179    | ES179 | 1-3/8" | A                              | 30       | 17.83     | 12.17  | YES       | YES           | 604       | 149         |
| 85978   | ES179    | ES179 | 1-5/8" | G                              | 29.84    | 18.16     | 11.69  | YES       | YES           | 582       | 138         |
| 85638   | ES179    | ES179 | 1-5/8" | G                              | 28.58    | 17.4      | 11.18  | YES       | YES           | 643       | 138         |
| 83147   | ES179    | ES179 | 1-3/8" | A                              | 28.54    | 17.4      | 11.15  | YES       | YES           | 358       | 128         |
| 83166   | ES179    | ES179 | 1-3/8" | A                              | 25.28    | 15.78     | 9.49   | YES       | YES           | 622       | 132         |
| 83168   | ES179    | ES179 | 1-3/8" | A                              | 25.28    | 15.78     | 9.49   | YES       | YES           | 246       | 88          |
| 85377   | ES182    | ES182 | 1-5/8" | D                              | 23.8     | 14.84     | 8.96   | YES       | YES           | 1937      | 570         |
| 85378   | ES182    | ES182 | 1-5/8" | D                              | 23.8     | 14.84     | 8.96   | YES       | YES           | 1110      | 240         |
| 85956   | ES183    | ES184 | 1-5/8" | G                              | 30.65    | 18.77     | 11.88  | YES       | YES           | 979       | 373         |
| 83053   | ES185    | ES185 | 1-3/8" | A                              | 10.91    | 7.93      | 2.98   | YES       | YES           | 968       | 214         |
| 83054   | ES185    | ES185 | 1-3/8" | A                              | 10.28    | 7.56      | 2.72   | YES       | YES           | 1004      | 184         |
| 83052   | ES185    | ES185 | 1-3/8" | 2-1/2" D/T                     | 9.41     | 7.19      | 2.23   | YES       | NO            | 1101      | 149         |
| 83062   | ES185    | S42   | 1-3/8" | A                              | 12.71    | 9.18      | 3.53   | YES       | NO            | 704       | 153         |
| 85739   | ES187    | ES187 | 1-5/8" | D                              | 20.73    | 13.54     | 7.19   | YES       | YES           | 3247      | 334         |

\* Damping force, in pounds, to either extend or collapse the shock absorber at an average operating velocity. Fuerza de amortiguación en libras para extender o comprimir el amortiguador a una velocidad de operación promedio. La puissance d'amortissement en poids de l'amortisseur, soit comprimé, doit détendu, à une vitesse de fonctionnement moyenne.

**SPECIFICATIONS BY END MOUNT**  
**ESPECIFICACIONES POR TIPO DE MONTAJE**  
**SPÉCIFICATIONS PAR FIXATION DES EXTRÉMITÉS**

| Gabriel | Mounting |       | Bore    | External Diameter Illustration | Lengths  |           |        | Dust Tube | Recoil Cutoff | Controls* |             |
|---------|----------|-------|---------|--------------------------------|----------|-----------|--------|-----------|---------------|-----------|-------------|
|         | Upper    | Lower |         |                                | Extended | Collapsed | Stroke |           |               | Rebound   | Compression |
| 85341   | ES188    | S21   | 1-5/8"  | D                              | 30.96    | 18.1      | 12.86  | YES       | YES           | 1807      | 333         |
| 85970   | ES188    | S21   | 1-5/8"  | G                              | 27.23    | 16.44     | 10.79  | YES       | YES           | 1092      | 147         |
| 85340   | ES188    | S21   | 1-5/8"  | D                              | 26.46    | 15.85     | 10.61  | YES       | YES           | 1807      | 165         |
| 83391   | ES190    | ES190 | 1-3/8"  | A                              | 25.52    | 15.61     | 9.91   | YES       | NO            | 590       | 105         |
| 86203   | ES193    | ES193 | 45 MM   | D                              | 16.88    | 11.61     | 5.27   | YES       | YES           | 4238      | 910         |
| 86202   | ES193    | ES193 | 45 MM   | D                              | 14.52    | 10.43     | 4.09   | YES       | YES           | 4238      | 688         |
| 86201   | ES193    | ES193 | 45 MM   | D                              | 13.26    | 9.94      | 3.32   | YES       | YES           | 4238      | 688         |
| 86200   | ES194    | ES194 | 45 MM   | D                              | 14.24    | 10.45     | 3.79   | YES       | YES           | 4238      | 688         |
| 83065   | ES206    | ES171 | 1-5/8"  | G                              | 12.52    | 9.32      | 3.2    | YES       | YES           | 680       | 184         |
| 83003   | S1       | BP7   | 1-3/8"  | A                              | 11.76    | 8.95†     | 3.4    | YES       | YES           | 248       | 100         |
| G63610  | S1       | EB1   | 1-3/8"  |                                | 21.55    | 13.27     | 8.28   | YES       | NO            |           |             |
| 83161   | S1       | EB1   | 1-3/8"  | A                              | 20.82    | 12.56     | 8.25   | YES       | NO            | 400       | 70          |
| 83518   | S1       | EB2   | 1-3/16" |                                | 24.4     | 14.26     | 10.14  | YES       | NO            | 153       | 82          |
| 83515   | S1       | EB2   | 1-3/16" |                                | 23.34    | 13.89     | 9.45   | YES       | NO            | 643       | 205         |
| G63432  | S1       | EB2   | 1-3/8"  |                                | 21.21    | 12.93     | 8.28   | YES       | NO            |           |             |
| G63387  | S1       | ES25  | 1-3/8"  |                                | 23.33    | 14.05     | 9.28   | YES       | NO            |           |             |
| G63511  | S1       | ES25  | 1-3/8"  |                                | 22.55    | 13.52     | 9.03   | YES       | NO            |           |             |
| G63350  | S1       | ES25  | 1-3/8"  |                                | 18.83    | 11.8      | 7.03   | YES       | NO            |           |             |
| 83400   | S1       | S1    | 1-3/16" | F                              | 22.02    | 12.82     | 9.2    | YES       | NO            | 301       | 120         |
| G63398  | S1       | S1    | 1-3/8"  |                                | 20.52    | 12.24     | 8.28   | YES       | NO            |           |             |
| 83014   | S1       | S1    | 1-3/8"  | A                              | 10.48    | 7.11      | 3.37   | NO        | NO            | 544       | 501         |
| G63396  | S10      | ES25  | 1-3/8"  |                                | 16.55    | 10.77     | 5.78   | YES       | NO            |           |             |
| G63778  | S12      | ES25  | 1-3/8"  |                                | 24.55    | 14.52     | 10.03  | YES       | NO            |           |             |
| G63716  | S12      | ES26  | 1-3/8"  |                                | 15.54    | 10.01     | 5.53   | YES       | NO            |           |             |
| 83317   | S16      | ES90  | 1-3/8"  | B                              | 27.03    | 16        | 11.34  | YES       | YES           |           |             |
| 83301   | S16      | ES90  | 1-3/8"  | B                              | 24.52    | 14.74     | 9.78   | YES       | YES           | 653       | 86          |
| 83318   | S16      | S16   | 1-3/8"  | B                              | 22.53    | 13.5      | 9.03   | YES       | YES           | 323       | 77          |
| 83613   | S16      | S16   | 1-3/8"  | A                              | 21.04    | 12.76     | 8.28   | YES       | YES           | 601       | 242         |
| 85731   | S21      | EB3   | 1-5/8"  | D                              | 30.57    | 18.54     | 12.03  | YES       | YES           | 1517      | 293         |
| 85703   | S21      | EB3   | 1-5/8"  | D                              | 29.57    | 18.54     | 11.03  | YES       | YES           | 1435      | 186         |
| 85033   | S21      | EB3   | 1-5/8"  | C                              | 27.26    | 17.4      | 9.86   | YES       | YES           | 764       | 254         |
| 89427   | S21      | EB3   | 1-5/8"  | G                              | 27.19    | 17.62     | 9.57   | YES       | YES           | 794‡      | 253         |
| 85317   | S21      | EB3   | 1-5/8"  | D                              | 27.18    | 17.42     | 9.76   | YES       | YES           | 764       | 254         |
| 85711   | S21      | EB3   | 1-5/8"  | D                              | 24.54    | 15.26     | 9.27   | YES       | YES           | 1435      | 208         |
| 87000   | S21      | EB3   | 2-1/16" | E                              | 24.46    | 15.21     | 9.25   | YES       | YES           | 1332      | 300         |
| 85311   | S21      | EB3   | 1-5/8"  | D                              | 23.95    | 14.79     | 9.16   | YES       | YES           | 764       | 254         |
| 85988   | S21      | EB3   | 1-5/8"  | G                              | 23.84    | 14.87     | 8.97   | YES       | YES           | 1200      | 138         |

\* Damping force, in pounds, to either extend or collapse the shock absorber at an average operating velocity. Fuerza de amortiguación en libras para extender o comprimir el amortiguador a una velocidad de operación promedio. La puissance d'amortissement en poids de l'amortisseur, soit comprimé, doit détendu, à une vitesse de fonctionnement moyenne.

† At bumper contact / Al contacto cone el tope de goma / Au contact avec le butoir

**SPECIFICATIONS BY END MOUNT**  
**ESPECIFICACIONES POR TIPO DE MONTAJE**  
**SPÉCIFICATIONS PAR FIXATION DES EXTRÉMITÉS**

| Gabriel | Mounting |       | Bore    | External Diameter Illustration | Lengths  |           |        | Dust Tube | Recoil Cutoff | Controls* |             |
|---------|----------|-------|---------|--------------------------------|----------|-----------|--------|-----------|---------------|-----------|-------------|
|         | Upper    | Lower |         |                                | Extended | Collapsed | Stroke |           |               | Rebound   | Compression |
| 89424   | S21      | EB3   | 1-5/8"  | G                              | 23.73    | 15.14     | 8.59   | YES       | YES           | 794‡      | 253         |
| 85710   | S21      | EB3   | 1-5/8"  | D                              | 23.45    | 15.1      | 8.34   | YES       | YES           | 994       | 248         |
| 85343   | S21      | EB3   | 1-5/8"  | D                              | 22.96    | 14.79     | 8.17   | YES       | YES           | 858       | 289         |
| 87016   | S21      | EB3   | 2-1/16" | E                              | 21.17    | 13.91     | 7.26   | YES       | YES           | 1808      | 238         |
| 85009   | S21      | ES36  | 1-5/8"  | C                              | 23.56    | 14.4      | 9.16   | YES       | YES           | 857       | 144         |
| 83134   | S21      | ES36  | 1-3/8"  | A                              | 22.27    | 13.51     | 8.77   | YES       | NO            | 430       | 49          |
| 85921   | S21      | ES36  | 1-5/8"  | G                              | 22.07    | 13.57     | 8.5    | YES       | NO            | 2053      | 339         |
| 85316   | S21      | ES36  | 1-5/8"  | D                              | 20.61    | 12.82     | 7.8    | YES       | NO            | 943       | 443         |
| 85351   | S21      | ES36  | 1-5/8"  | D                              | 20.61    | 12.82     | 7.79   | YES       | NO            | 1887      | 259         |
| 89426   | S21      | ES36  | 1-5/8"  | G                              | 20.46    | 13.05     | 7.41   | YES       | NO            | 926‡      | 419         |
| 85056   | S21      | ES36  | 1-5/8"  | C                              | 20.15    | 12.87     | 7.28   | YES       | YES           | 732       | 114         |
| 89441   | S21      | ES36  | 1-5/8"  | G                              | 20.14    | 13.06     | 7.08   | YES       | YES           | 761‡      | 126         |
| 85935   | S21      | ES36  | 1-5/8"  | G                              | 18.7     | 11.92     | 6.78   | YES       | NO            | 1054      | 419         |
| 85319   | S21      | ES150 | 1-5/8"  | D                              | 22.22    | 13.93     | 8.3    | YES       | YES           | 988       | 454         |
| 89428   | S21      | ES150 | 1-5/8"  | G                              | 22       | 14.27     | 7.72   | YES       | YES           | 958‡      | 446         |
| 83395   | S21      | ES178 | 1-3/8"  | A                              | 27.19    | 16.28     | 10.91  | YES       | NO            | 616       | 105         |
| 85709   | S21      | S21   | 1-5/8"  | D                              | 31.64    | 18.36     | 13.28  | YES       | YES           | 700       | 203         |
| 85727   | S21      | S21   | 1-5/8"  | D                              | 29.88    | 17.34     | 12.54  | YES       | YES           | 783       | 111         |
| 83136   | S21      | S21   | 1-3/8"  | A                              | 29.31    | 16.8      | 12.51  | YES       | NO            | 914       | 65          |
| 83106   | S21      | S21   | 1-3/8"  | A                              | 29.25    | 16.76     | 12.49  | YES       | NO            | 451       | 80          |
| 85048   | S21      | S21   | 1-5/8"  | C                              | 29.16    | 16.88     | 12.28  | YES       | NO            | 432       | 106         |
| 85318   | S21      | S21   | 1-5/8"  | D                              | 27.37    | 16.36     | 11.01  | YES       | YES           | 1372      | 192         |
| 85722   | S21      | S21   | 1-5/8"  | D                              | 27.16    | 16.41     | 10.76  | YES       | YES           | 1264      | 369         |
| 85069   | S21      | S21   | 1-5/8"  | C                              | 26.31    | 15.97     | 10.33  | YES       | YES           | 762       | 255         |
| 89455   | S21      | S21   | 1-5/8"  | G                              | 26.31    | 16.03     | 10.28  | YES       | YES           | 791‡      | 276         |
| 85328   | S21      | S21   | 1-5/8"  | D                              | 25.64    | 15.36     | 10.28  | YES       | NO            | 930       | 383         |
| 85071   | S21      | S21   | 1-5/8"  | C                              | 25.57    | 15.02     | 10.55  | YES       | NO            | 610       | 107         |
| 85049   | S21      | S21   | 1-5/8"  | C                              | 25.53    | 15        | 10.53  | YES       | NO            | 597       | 107         |
| 85085   | S21      | S21   | 1-5/8"  | C                              | 24.95    | 14.67     | 10.23  | YES       | NO            | 970       | 101         |
| 85728   | S21      | S21   | 1-5/8"  | D                              | 24.37    | 14.86     | 9.51   | YES       | YES           | 1435      | 510         |
| 83456   | S21      | S21   | 1-3/8"  | B                              | 24.03    | 14.25     | 9.78   | YES       | YES           | 566       | 80          |
| 85706   | S21      | S21   | 1-5/8"  | D                              | 23.65    | 14.24     | 9.41   | YES       | YES           | 1086      | 696         |
| 85707   | S21      | S21   | 2-1/16" | D                              | 23.65    | 14.4      | 9.25   | YES       | YES           | 1761      | 986         |
| 87011   | S21      | S21   | 2-1/16" | E                              | 23.65    | 14.4      | 9.25   | YES       | YES           | 1750      | 1050        |
| 87012   | S21      | S21   | 2-1/16" | E                              | 23.65    | 14.4      | 9.25   | YES       | YES           | 650       | 364         |
| 87013   | S21      | S21   | 2-1/16" | E                              | 23.65    | 14.4      | 9.25   | YES       | YES           | 1075      | 585         |
| 85325   | S21      | S21   | 1-5/8"  | D                              | 23.64    | 14.36     | 9.28   | YES       | NO            | 1024      | 240         |
| 89447   | S21      | S21   | 1-5/8"  | G                              | 23.63    | 14.69     | 8.94   | YES       | YES           | 702‡      | 241         |

\* Damping force, in pounds, to either extend or collapse the shock absorber at an average operating velocity. Fuerza de amortiguación en libras para extender o comprimir el amortiguador a una velocidad de operación promedio. La puissance d'amortissement en poids de l'amortisseur, soit comprimé, doit détendu, à une vitesse de fonctionnement moyenne.

**SPECIFICATIONS BY END MOUNT**  
**ESPECIFICACIONES POR TIPO DE MONTAJE**  
**SPÉCIFICATIONS PAR FIXATION DES EXTRÉMITÉS**

| Gabriel | Mounting |       | Bore    | External Diameter Illustration | Lengths  |           |        | Dust Tube | Recoil Cutoff | Controls* |             |
|---------|----------|-------|---------|--------------------------------|----------|-----------|--------|-----------|---------------|-----------|-------------|
|         | Upper    | Lower |         |                                | Extended | Collapsed | Stroke |           |               | Rebound   | Compression |
| 85347   | S21      | S21   | 1-5/8"  | D                              | 23.62    | 14.22     | 9.4    | YES       | YES           | 961       | 122         |
| 85705   | S21      | S21   | 1-5/8"  | D                              | 23.62    | 14.23     | 9.39   | YES       | YES           | 639       | 436         |
| 85342   | S21      | S21   | 1-5/8"  | D                              | 23.28    | 13.99     | 9.29   | YES       | NO            | 893       | 188         |
| 83102   | S21      | S21   | 1-3/8"  | A                              | 22.89    | 13.54     | 9.35   | YES       | YES           | 513       | 333         |
| 85324   | S21      | S21   | 1-5/8"  | D                              | 22.14    | 13.61     | 8.53   | YES       | NO            | 579       | 114         |
| 85346   | S21      | S21   | 1-5/8"  | D                              | 22.12    | 13.48     | 8.64   | YES       | YES           | 2016      | 285         |
| 85027   | S21      | S21   | 1-5/8"  | C                              | 21.59    | 13.05     | 8.54   | YES       | NO            | 1008      | 539         |
| 89418   | S21      | S21   | 1-5/8"  | G                              | 21.44    | 13.19     | 8.25   | YES       | NO            | 1266‡     | 515         |
| 695406  | S21      | S21   | 2-1/16" | E                              | 21.39    | 13.26     | 8.13   | YES       | YES           | 1854      | 274         |
| 85124   | S21      | S21   | 1-5/8"  | C                              | 20.91    | 12.9      | 8.01   | YES       | YES           | 1086      | 222         |
| 85708   | S21      | S21   | 1-5/8"  | D                              | 20.63    | 12.85     | 7.78   | YES       | YES           | 914       | 204         |
| 85745   | S21      | S21   | 1-5/8"  | D                              | 19.88    | 12.34     | 7.54   | YES       | YES           | 3064      | 231         |
| 85746   | S21      | S21   | 1-5/8"  | D                              | 19.88    | 12.34     | 7.54   | YES       | YES           | 1754      | 167         |
| 83103   | S21      | S21   | 1-3/8"  | A                              | 19.66    | 11.93     | 7.74   | YES       | YES           | 517       | 301         |
| 85326   | S21      | S21   | 1-5/8"  | D                              | 19.64    | 12.36     | 7.28   | YES       | NO            | 799       | 142         |
| 85902   | S21      | S21   | 1-5/8"  | G                              | 19.03    | 12.09     | 6.93   | YES       | YES           | 1441      | 267         |
| 85336   | S21      | S21   | 1-5/8"  | D                              | 18.76    | 11.86     | 6.9    | YES       | NO            | 861       | 200         |
| 89423   | S21      | S21   | 1-5/8"  | G                              | 18.67    | 12.21     | 6.46   | YES       | YES           | 1352‡     | 573         |
| 85310   | S21      | S21   | 1-5/8"  | D                              | 18.63    | 11.71     | 6.92   | YES       | YES           | 1379      | 578         |
| 85900   | S21      | S21   | 1-5/8"  | G                              | 17.33    | 11.23     | 6.11   | YES       | YES           | 1467      | 337         |
| 87007   | S21      | S21   | 2-1/16" | E                              | 15.65    | 10.4      | 5.25   | YES       | YES           | 879       | 253         |
| 85701   | S21      | S21   | 1-5/8"  | D                              | 15.64    | 10.36     | 5.28   | YES       | YES           | 914       | 204         |
| G63500  | S28      | ES25  | 1-3/8"  |                                | 15.09    | 10.06     | 5.03   | NO        | YES           |           |             |
| G63414  | S28      | ES83  | 1-3/8"  |                                | 15.09    | 10.06     | 5.03   | NO        | YES           |           |             |
| G63678  | S36      | BP7   | 1-3/8"  |                                | 18.09    | 13.56     | 4.53   | YES       | NO            |           |             |
| G63622  | S36      | EB1   | 1-3/8"  |                                | 15.42    | 10.39     | 5.03   | YES       | YES           |           |             |
| G63614  | S36      | EB1   | 1-3/8"  |                                | 15.12    | 10.09     | 5.03   | NO        | YES           |           |             |
| G63929  | S36      | EB1   | 1-3/8"  |                                | 14.72    | 9.71      | 5.01   | YES       | YES           |           |             |
| G63608  | S36      | EB1   | 1-3/8"  |                                | 14.58    | 9.81      | 4.78   | YES       | YES           |           |             |
| G63386  | S36      | ES25  | 1-3/8"  |                                | 17.19    | 11.16     | 6.03   | NO        | YES           |           |             |
| G63623  | S36      | ES83  | 1-3/8"  |                                | 22.67    | 14.39     | 8.28   | YES       | YES           |           |             |
| G63624  | S36      | ES83  | 1-3/8"  |                                | 20.17    | 12.64     | 7.53   | YES       | YES           |           |             |
| 83178   | S38      | ES83  | 1-3/8"  | A                              | 21.95    | 13.26     | 8.69   | YES       | NO            | 690       | 275         |
| G63484  | S4       | EB1   | 1-3/8"  |                                | 20.05    | 12.52     | 7.53   | YES       | NO            |           |             |
| 83177   | S40      | EB1   | 1-3/8"  | A                              | 14.99†   | 10.12     | 5.38   | YES       | NO            | 690       | 275         |
| 83114   | S40      | ES35  | 1-3/8"  | A                              | 23.02    | 13.78     | 9.24   | YES       | NO            | 450       | 102         |
| 83105   | S40      | ES179 | 1-3/8"  | A                              | 31.91    | 18.3      | 13.61  | YES       | NO            | 559       | 150         |
| 83162   | S40      | ES190 | 1-3/8"  | A                              | 24.35    | 14.69     | 9.67   | YES       | NO            | 877       | 52          |

\* Damping force, in pounds, to either extend or collapse the shock absorber at an average operating velocity. Fuerza de amortiguación en libras para extender o comprimir el amortiguador a una velocidad de operación promedio. La puissance d'amortissement en poids de l'amortisseur, soit comprimé, doit détendu, à une vitesse de fonctionnement moyenne.

† At bumper contact / Al contacto cone el tope de goma / Au contact avec le butoir

**SPECIFICATIONS BY END MOUNT  
ESPECIFICACIONES POR TIPO DE MONTAJE  
SPÉCIFICATIONS PAR FIXATION DES EXTRÉMITÉS**

| Gabriel | Mounting |       | Bore    | External Diameter Illustration | Lengths  |           |        | Dust Tube | Recoil Cutoff | Controls* |             |
|---------|----------|-------|---------|--------------------------------|----------|-----------|--------|-----------|---------------|-----------|-------------|
|         | Upper    | Lower |         |                                | Extended | Collapsed | Stroke |           |               | Rebound   | Compression |
| 85333   | S42      | ES36  | 1-5/8"  | D                              | 20.65    | 12.98     | 7.67   | YES       | YES           | 1241      | 534         |
| 85332   | S42      | ES36  | 1-5/8"  | D                              | 20.64    | 12.98     | 7.66   | YES       | YES           | 2351      | 967         |
| 85182   | S43      | S43   | 1-5/8"  | C                              | 26.86    | 16.04     | 10.82  | YES       | NO            | 708       | 232         |
| G63714  | S6       | BP7   | 1-3/8"  |                                | 15.54    | 10.01     | 5.53   | YES       | NO            |           |             |
| G63772  | S6       | BP35  | 1-3/8"  |                                | 13.83    | 9.55      | 4.28   | YES       | YES           |           |             |
| 83171   |          | ES36  | 1-3/8"  | A                              | 23.98    | 14.51     | 9.47   | YES       | YES           | 513       | 146         |
| 630811  | 0        | 0     | 1-3/16" |                                | 22.45    | 14.1      | 8.35   | NO        | NO            |           |             |
| 632147  | 0        | 0     | 1-3/16" |                                | 22.45    | 14.1      | 8.35   | NO        | NO            |           |             |
| G63969  | 412847   | ES34  | 1-3/8"  |                                | 20.75    | 13.31     | 7.44   |           |               |           |             |

\* Damping force, in pounds, to either extend or collapse the shock absorber at an average operating velocity. Fuerza de amortiguación en libras para extender o comprimir el amortiguador a una velocidad de operación promedio. La puissance d'amortissement en poids de l'amortisseur, soit comprimé, doit détendu, à une vitesse de fonctionnement moyenne.



**SPECIFICATIONS BY PART NUMBER**  
**ESPECIFICACIONES POR NÚMERO DE PARTE**  
**SPÉCIFICATIONS PAR NUMÉRO DE PIÈCE**

| Gabriel | Mounting |       | Bore    | External Diameter Illustration | Lengths  |           |        | Dust Tube | Recoil Cutoff | Controls* |             |
|---------|----------|-------|---------|--------------------------------|----------|-----------|--------|-----------|---------------|-----------|-------------|
|         | Upper    | Lower |         |                                | Extended | Collapsed | Stroke |           |               | Rebound   | Compression |
| 83001   | ES149    | EB1   | 1-3/8"  | A                              | 10.45†   | 8.41†     | 3      | YES       | YES           | 793       | 363         |
| 83002   | ES10     | ES10  | 1-3/8"  | A                              | 11.65    | 8.66      | 3      | YES       | YES           | 3112      | 590         |
| 83003   | S1       | BP7   | 1-3/8"  | A                              | 11.76    | 8.95†     | 3.4    | YES       | YES           | 248       | 100         |
| 83004   | ES35     | ES136 | 1"      | 2" D/T                         | 9.36†    | 7.29      | 2.32   | YES       | YES           | 539       | 324         |
| 83005   | BP8      | S10   | 1-3/16" | 2" D/T                         | 7.34     | 5.87      | 1.47   | YES       | NO            | 858       | 216         |
| 83006   | ES149    | EB1   | 1-3/8"  | A                              | 10.71    | 8.52†     | 2.78   | YES       | YES           | 525       | 182         |
| 83007   | EB1      | EB1   | 1-3/8"  | A                              | 18.55    | 11.67     | 6.87   | NO        | NO            | 489       | 343         |
| 83008   | ES136    | ES136 | 1-3/8"  | A                              | 13†      | 10.13†    | 4      | YES       | YES           | 699       | 307         |
| 83009   | ES149    | ES149 | 1-3/8"  | A                              | 10.45†   | 8.41†     | 3      | YES       | YES           | 793       | 363         |
| 83010   | ES24     | ES24  | 1"      | 2" D/T                         | 14.15†   | 9.33      | 5.07   | YES       | YES           | 188       | 70          |
| 83011   | EB1      | EB1   | 1-3/8"  | A                              | 11.55†   | 8.48      | 3.61   | YES       | YES           | 738       | 330         |
| 83012   | EB1      | EB1   | 1-3/8"  | A                              | 11.07†   | 8.21      | 3.37   | YES       | YES           | 738       | 330         |
| 83013   | BP8      | BP8   | 1-3/16" | 2" D/T                         | 7.66     | 6.63†     | 1.7    | YES       | NO            | 646       | 480         |
| 83014   | S1       | S1    | 1-3/8"  | A                              | 10.48    | 7.11      | 3.37   | NO        | NO            | 544       | 501         |
| 83015   | BP8      | S1    | 1-3/8"  | A                              | 9.84     | 7.59      | 2.25   | YES       | YES           | 735       | 430         |
| 83016   | ES10     | ES10  | 1"      | 1-5/8"                         | 11.51    | 8.14      | 3.37   | NO        | YES           | 506       | 139         |
| 83017   | ES149    | ES149 | 1-3/8"  | A                              | 10.95    | 8.41†     | 3.13   | YES       | YES           | 353       | 138         |
| 83018   | ES24     | S10   | 1-3/8"  | A                              | 10.3†    | 8.42†     | 3.24   | YES       | YES           | 515       | 174         |
| 83019   | ES24     | S10   | 1-3/8"  | A                              | 9.48     | 8.21†     | 2.29   | YES       | YES           | 509       | 121         |
| 83020   | ES91     | ES91  | 1-3/8"  | A                              | 9.41     | 7.17      | 2.24   | YES       | YES           | 796       | 255         |
| 83021   | ES10     | ES10  | 1-3/8"  | A                              | 9.41     | 7.4       | 2.01   | YES       | YES           | 745       | 315         |
| 83022   | ES24     | ES24  | 1"      | 2" D/T                         | 14.28    | 9.33      | 4.95   | YES       | NO            | 840       | 152         |
| 83023   | ES10     | ES181 | 1"      | 1-5/8"                         | 8.7      | 7.09†     | 2.14   | NO        | YES           | 484       | 157         |
| 83024   | ES10     | ES10  | 1-3/8"  | 2-1/2" D/T                     | 11.65    | 8.66      | 3      | YES       | YES           | 811       | 320         |
| 83025   | ES163    | ES163 | 1-3/8"  | A                              | 8.02     | 6.53      | 1.48   | YES       | YES           | 710       | 230         |
| 83026   | ES24     | ES24  | 1-3/8"  | A                              | 13.11    | 9.12      | 3.99   | YES       | YES           | 602       | 104         |
| 83027   | ES24     | S10   | 1-3/8"  | A                              | 13.82    | 9.2       | 4.61   | YES       | YES           | 602       | 104         |
| 83028   | ES86     | ES167 | 1-3/8"  | A                              | 9.96     | 7.6       | 2.33   | YES       | YES           | 445       | 531         |
| 83029   | ES168    | ES169 | 1-5/8"  | C                              | 10.35    | 7.87      | 2.41   | YES       | NO            | 1303      | 1349        |
| 83030   | ES136    | ES136 | 1-3/8"  | A                              | 9.61†    | 7.61      | 2.5    | YES       | YES           | 308       | 87          |
| 83031   | ES10     | ES10  | 1-3/8"  | 2-1/2" D/T                     | 11.54    | 8.66      | 2.88   | YES       | YES           | 811       | 314         |
| 83032   | ES163    | ES163 | 1-3/8"  | A                              | 7.85     | 6.36      | 1.49   | NO        | YES           | 779       | 135         |
| 83033   | ES53     | ES53  | 1-3/8"  | A                              | 13.99    | 10.37     | 3.62   | YES       | YES           | 494       | 312         |
| 83034   | ES115    | ES115 | 1-3/16" | 1-5/8"                         | 10.04†   | 7.32      | 2.97   | NO        | YES           | 430       | 129         |
| 83035   | ES166    | ES136 | 1-3/8"  | A                              | 13.04†   | 9.33      | 4.22   | YES       | YES           | 320       | 100         |
| 83038   | ES149    | EB1   | 1-3/8"  | A                              | 10.45†   | 8.41†     | 3      | YES       | YES           | 336       | 242         |
| 83039   | ES149    | ES149 | 1-3/8"  | A                              | 10.44†   | 8.4†      | 3      | YES       | YES           | 876       | 326         |
| 83040   | ES171    | ES172 | 1-3/8"  | A                              | 10.44†   | 8.4†      | 3      | YES       | YES           | 876       | 326         |
| 83041   | BP27     | S10   | 1-3/8"  | A                              | 10.51†   | 8.34†     | 3.02   | YES       | YES           | 486       | 189         |

\* Damping force, in pounds, to either extend or collapse the shock absorber at an average operating velocity. Fuerza de amortiguación en libras para extender o comprimir el amortiguador a una velocidad de operación promedio. La puissance d'amortissement en poids de l'amortisseur, soit comprimé, doit détendu, à une vitesse de fonctionnement moyenne.

† At bumper contact / Al contacto con el tope de goma / Au contact avec le butoir

**SPECIFICATIONS BY PART NUMBER**  
**ESPECIFICACIONES POR NÚMERO DE PARTE**  
**SPÉCIFICATIONS PAR NUMÉRO DE PIÈCE**

| Gabriel | Mounting |       | Bore    | External Diameter Illustration | Lengths  |           |        | Dust Tube | Recoil Cutoff | Controls* |             |
|---------|----------|-------|---------|--------------------------------|----------|-----------|--------|-----------|---------------|-----------|-------------|
|         | Upper    | Lower |         |                                | Extended | Collapsed | Stroke |           |               | Rebound   | Compression |
| 83042   | ES136    | ES136 | 1-3/8"  | A                              | 9.89†    | 8.52†     | 2.39   | YES       | YES           | 954       | 541         |
| 83044   | ES27     | ES164 | 1-3/8"  | A                              | 10.91    | 7.93      | 2.98   | YES       | YES           | 789       | 296         |
| 83045   | ES19     | S10   | 1-3/8"  | A                              | 11.53†   | 8.58†     | 3.81   | YES       | NO            | 510       | 153         |
| 83046   | ES10     | ES181 | 1-3/16" |                                | 9.23†    | 7.62†     | 2.73   | NO        | YES           | 514       | 173         |
| 83047   | ES149    | EB1   | 1-3/8"  | A                              | 11.78†   | 9.74†     | 3      | YES       | YES           | 364       | 314         |
| 83048   | ES86     | ES167 | 1-3/8"  | A                              | 9.97     | 8.43†     | 2.37   | YES       | YES           | 904       | 415         |
| 83049   | ES163    | ES163 | 1-3/8"  | A                              | 8.02     | 6.53      | 1.48   | YES       | YES           | 2879      | 705         |
| 83050   | ES19     | S10   | 1-3/8"  | A                              | 10.43†   | 8.38†     | 2.9    | YES       | YES           | 599       | 321         |
| 83051   | ES10     | ES10  | 1-3/8"  | 2-1/2" D/T                     | 9.41     | 7.4       | 2.01   | YES       | YES           | 579       | 163         |
| 83052   | ES185    | ES185 | 1-3/8"  | 2-1/2" D/T                     | 9.41     | 7.19      | 2.23   | YES       | NO            | 1101      | 149         |
| 83053   | ES185    | ES185 | 1-3/8"  | A                              | 10.91    | 7.93      | 2.98   | YES       | YES           | 968       | 214         |
| 83054   | ES185    | ES185 | 1-3/8"  | A                              | 10.28    | 7.56      | 2.72   | YES       | YES           | 1004      | 184         |
| 83056   | ES136    | ES136 | 1-5/8"  | C                              | 11.53    | 8.63      | 2.89   | YES       | YES           | 3830      | 737         |
| 83057   | ES171    | ES172 | 1-3/8"  | 2-1/2" D/T                     | 10.44†   | 8.4†      | 2.99   | YES       | YES           | 364       | 242         |
| 83058   | ES19     | S10   | 1-3/8"  | A                              | 10.43†   | 8.38†     | 2.9    | YES       | YES           | 742       | 243         |
| 83059   | ES35     | ES35  | 1-3/8"  | A                              | 12.06†   | 8.68      | 3.88   | YES       | YES           | 738       | 350         |
| 83060   | EB       | BP7   | 1-3/8"  | A                              | 9.76     | 7.98†     | 2.25   | NO        | YES           | 431       | 441         |
| 83061   | ES10     | ES10  | 1-3/8"  | 2-1/2" D/T                     | 9.41     | 7.4       | 2.01   | YES       | YES           | 1030      | 220         |
| 83062   | ES185    | S42   | 1-3/8"  | A                              | 12.71    | 9.18      | 3.53   | YES       | NO            | 704       | 153         |
| 83063   | ES175    | ES136 | 1-3/8"  | A                              | 10.76†   | 9.26†     | 3.01   | YES       | YES           | 954       | 541         |
| 83064   | ES149    | ES149 | 1-3/8"  | A                              | 10.41†   | 8.36†     | 2.99   | YES       | YES           | 635       | 323         |
| 83065   | ES206    | ES171 | 1-5/8"  | G                              | 12.52    | 9.32      | 3.2    | YES       | YES           | 680       | 184         |
| 83066   | ES153    | ES153 | 1-3/8"  | A                              | 11.15†   | 9.2†      | 2.78   | YES       | YES           | 599       | 221         |
| 83067   | ES166    | ES136 | 1-3/16" | 2" D/T                         | 12.33†   | 9.27      | 3.56   | YES       | YES           | 424       | 101         |
| 83081   | ES126    | ES172 | 1-3/8"  | A                              | 13.39    | 9.98†     | 4      | YES       | YES           | 1004      | 232         |
| 83100   | ES90     | ES90  | 1-3/8"  | A                              | 26.6     | 16.11     | 10.49  | YES       | YES           | 481       | 142         |
| 83101   | ES90     | ES90  | 1-3/8"  | A                              | 24.63    | 15.13     | 9.49   | YES       | YES           | 481       | 142         |
| 83102   | S21      | S21   | 1-3/8"  | A                              | 22.89    | 13.54     | 9.35   | YES       | YES           | 513       | 333         |
| 83103   | S21      | S21   | 1-3/8"  | A                              | 19.66    | 11.93     | 7.74   | YES       | YES           | 517       | 301         |
| 83104   | EB3      | EB3   | 1-3/8"  | A                              | 28.24    | 17.12     | 11.12  | YES       | NO            | 698       | 133         |
| 83105   | S40      | ES179 | 1-3/8"  | A                              | 31.91    | 18.3      | 13.61  | YES       | NO            | 559       | 150         |
| 83106   | S21      | S21   | 1-3/8"  | A                              | 29.25    | 16.76     | 12.49  | YES       | NO            | 451       | 80          |
| 83107   | EB2      | EB2   | 1-3/8"  | A                              | 31.66    | 18.4      | 13.25  | YES       | NO            | 352       | 77          |
| 83109   | ES36     | S42   | 1-3/8"  | A                              | 26.17    | 15.93     | 10.24  | YES       | YES           | 345       | 78          |
| 83110   | ES36     | S42   | 1-3/8"  | A                              | 22.94    | 14.31     | 8.63   | YES       | YES           | 450       | 143         |
| 83111   | ES36     | S42   | 1-3/8"  | A                              | 26.17    | 15.93     | 10.24  | YES       | YES           | 560       | 141         |
| 83112   | ES36     | S42   | 1-3/8"  | A                              | 21.52    | 13.41     | 8.11   | YES       | YES           | 1064      | 343         |
| 83113   | ES36     | EB3   | 1-3/8"  | A                              | 20.47    | 13.46     | 7.01   | YES       | YES           | 997       | 238         |

\* Damping force, in pounds, to either extend or collapse the shock absorber at an average operating velocity. Fuerza de amortiguación en libras para extender o comprimir el amortiguador a una velocidad de operación promedio. La puissance d'amortissement en poids de l'amortisseur, soit comprimé, doit détendu, à une vitesse de fonctionnement moyenne.

**SPECIFICATIONS BY PART NUMBER  
ESPECIFICACIONES POR NÚMERO DE PARTE  
SPÉCIFICATIONS PAR NUMÉRO DE PIÈCE**

| Gabriel | Mounting |       | Bore   | External Diameter Illustration | Lengths  |           |        | Dust Tube | Recoil Cutoff | Controls* |             |
|---------|----------|-------|--------|--------------------------------|----------|-----------|--------|-----------|---------------|-----------|-------------|
|         | Upper    | Lower |        |                                | Extended | Collapsed | Stroke |           |               | Rebound   | Compression |
| 83114   | S40      | ES35  | 1-3/8" | A                              | 23.02    | 13.78     | 9.24   | YES       | NO            | 450       | 102         |
| 83115   | ES36     | EB3   | 1-3/8" | A                              | 16.19    | 13.32     | 4.87   | YES       | YES           | 997       | 238         |
| 83116   | ES164    | ES165 | 1-3/8" | A                              | 23.81    | 14.68     | 9.12   | YES       | NO            | 354       | 300         |
| 83117   | EB4      | EB1   | 1-3/8" | A                              | 23.98    | 14.47     | 9.51   | YES       | NO            | 354       | 300         |
| 83118   | ES164    | ES90  | 1-3/8" | A                              | 24.45    | 14.71     | 9.74   | YES       | NO            | 410       | 311         |
| 83119   | EB4      | ES165 | 1-3/8" | A                              | 23.96    | 14.84     | 9.12   | YES       | NO            | 354       | 300         |
| 83120   | ES120    | S21   | 1-3/8" | A                              | 22.17    | 13.66     | 8.51   | YES       | YES           | 779       | 164         |
| 83121   | ES36     | ES36  | 1-3/8" | A                              | 30.25    | 18.32     | 11.93  | YES       | YES           | 689       | 126         |
| 83122   | ES36     | ES36  | 1-3/8" | A                              | 25.28    | 15.79     | 9.49   | YES       | YES           | 661       | 201         |
| 83123   | ES36     | ES36  | 1-3/8" | A                              | 26.65    | 16.41     | 10.24  | YES       | YES           | 589       | 119         |
| 83124   | ES36     | ES36  | 1-3/8" | A                              | 21.65    | 13.77     | 7.88   | YES       | YES           | 750       | 137         |
| 83125   | ES36     | ES36  | 1-3/8" | A                              | 28.15    | 17.16     | 10.99  | YES       | YES           | 625       | 115         |
| 83126   | ES36     | ES36  | 1-3/8" | A                              | 24.41    | 15.27     | 9.14   | YES       | YES           | 625       | 115         |
| 83127   | ES36     | ES36  | 1-3/8" | A                              | 20.16    | 13.14     | 7.01   | YES       | YES           | 940       | 218         |
| 83128   | ES36     | ES36  | 1-3/8" | A                              | 16.89    | 11.53     | 5.36   | YES       | YES           | 940       | 218         |
| 83130   | ES36     | ES36  | 1-3/8" | A                              | 18.03    | 12.04     | 5.99   | YES       | YES           | 871       | 177         |
| 83131   | ES83     | ES83  | 1-3/8" | A                              | 27.8     | 18.18     | 9.62   | YES       | NO            | 212       | 129         |
| 83132   | EB3      | EB3   | 1-3/8" | A                              | 25.24    | 15.5      | 9.74   | YES       | NO            | 828       | 150         |
| 83134   | S21      | ES36  | 1-3/8" | A                              | 22.27    | 13.51     | 8.77   | YES       | NO            | 430       | 49          |
| 83135   | ES90     | ES90  | 1-3/8" | A                              | 19.49    | 12.38     | 7.11   | YES       | NO            | 519       | 121         |
| 83136   | S21      | S21   | 1-3/8" | A                              | 29.31    | 16.8      | 12.51  | YES       | NO            | 914       | 65          |
| 83137   | ES36     | ES36  | 1-3/8" | A                              | 30.04    | 17.79     | 12.25  | YES       | YES           | 517       | 132         |
| 83138   | ES36     | S42   | 1-3/8" | A                              | 23.55    | 14.42     | 9.12   | YES       | YES           | 997       | 231         |
| 83140   | EB3      | EB3   | 1-3/8" | A                              | 25.28    | 15.53     | 9.75   | YES       | NO            | 738       | 88          |
| 83141   | EB3      | EB3   | 1-3/8" | A                              | 25.27    | 15.52     | 9.75   | YES       | NO            | 408       | 113         |
| 83142   | ES162    | S42   | 1-3/8" | A                              | 23.92    | 14.49     | 9.43   | YES       | YES           | 367       | 131         |
| 83143   | ES162    | S42   | 1-3/8" | A                              | 21.92    | 13.51     | 8.41   | YES       | YES           | 403       | 137         |
| 83144   | ES36     | ES36  | 1-3/8" | A                              | 23.78    | 15.03     | 8.74   | YES       | YES           | 596       | 93          |
| 83145   | ES83     | ES83  | 1-3/8" | A                              | 19.93    | 12.32     | 7.54   | YES       | NO            | 479       | 153         |
| 83146   | ES90     | ES83  | 1-3/8" | A                              | 24.02    | 14.68     | 9.33   | YES       | YES           | 479       | 119         |
| 83147   | ES179    | ES179 | 1-3/8" | A                              | 28.54    | 17.4      | 11.15  | YES       | YES           | 358       | 128         |
| 83148   | ES179    | ES179 | 1-3/8" | A                              | 30       | 17.83     | 12.17  | YES       | YES           | 604       | 149         |
| 83149   | ES36     | ES36  | 1-3/8" | A                              | 25.28    | 15.78     | 9.49   | YES       | YES           | 332       | 101         |
| 83150   | ES36     | ES36  | 1-3/8" | A                              | 15.24    | 10.43     | 4.81   | YES       | YES           | 940       | 216         |
| 83153   | ES34     | ES34  | 1-3/8" | A                              | 21.69    | 13.62     | 8.07   | YES       | YES           | 974       | 206         |
| 83154   | ES120    | S21   | 1-3/8" | A                              | 20.78    | 12.72     | 8.06   | YES       | YES           | 599       | 140         |
| 83155   | ES34     | ES34  | 1-3/8" | A                              | 21.69    | 13.62     | 8.07   | YES       | YES           | 507       | 80          |
| 83156   | ES90     | ES90  | 1-3/8" | A                              | 18.55    | 11.91     | 6.64   | YES       | NO            | 778       | 135         |
| 83157   | ES36     | ES90  | 1-3/8" | A                              | 26.38    | 15.76     | 10.61  | YES       | NO            | 446       | 303         |

\* Damping force, in pounds, to either extend or collapse the shock absorber at an average operating velocity. Fuerza de amortiguación en libras para extender o comprimir el amortiguador a una velocidad de operación promedio. La puissance d'amortissement en poids de l'amortisseur, soit comprimé, doit détendu, à une vitesse de fonctionnement moyenne.

† At bumper contact / Al contacto con el tope de goma / Au contact avec le butoir

**SPECIFICATIONS BY PART NUMBER**  
**ESPECIFICACIONES POR NÚMERO DE PARTE**  
**SPÉCIFICATIONS PAR NUMÉRO DE PIÈCE**

| Gabriel | Mounting |       | Bore   | External Diameter Illustration | Lengths  |           |        | Dust Tube | Recoil Cutoff | Controls* |             |
|---------|----------|-------|--------|--------------------------------|----------|-----------|--------|-----------|---------------|-----------|-------------|
|         | Upper    | Lower |        |                                | Extended | Collapsed | Stroke |           |               | Rebound   | Compression |
| 83158   | ES22     | ES22  | 1-3/8" | A                              | 12.96    | 8.97      | 4      | YES       | NO            | 783       | 484         |
| 83159   | EB2      | EB2   | 1-3/8" | A                              | 21.85    | 13.56     | 8.29   | YES       | NO            | 658       | 149         |
| 83160   | ES128    | ES36  | 1-3/8" | A                              | 24.31    | 14.9      | 9.37   | YES       | YES           | 920       | 161         |
| 83161   | S1       | EB1   | 1-3/8" | A                              | 20.82    | 12.56     | 8.25   | YES       | NO            | 400       | 70          |
| 83162   | S40      | ES190 | 1-3/8" | A                              | 24.35    | 14.69     | 9.67   | YES       | NO            | 877       | 52          |
| 83163   | ES175    | ES175 | 1-3/8" | A                              | 20.75    | 13.01     | 7.74   | YES       | NO            | 828       | 98          |
| 83164   | ES36     | ES165 | 1-3/8" | C                              | 24.22    | 14.59     | 9.63   | YES       | NO            | 426       | 274         |
| 83166   | ES179    | ES179 | 1-3/8" | A                              | 25.28    | 15.78     | 9.49   | YES       | YES           | 622       | 132         |
| 83167   | ES90     | ES90  | 1-3/8" | A                              | 19.49    | 12.38     | 7.11   | YES       | NO            | 285       | 90          |
| 83168   | ES179    | ES179 | 1-3/8" | A                              | 25.28    | 15.78     | 9.49   | YES       | YES           | 246       | 88          |
| 83169   | ES90     | ES90  | 1-3/8" | A                              | 18.55    | 11.91     | 6.64   | YES       | NO            | 599       | 171         |
| 83171   |          | ES36  | 1-3/8" | A                              | 23.98    | 14.51     | 9.47   | YES       | YES           | 513       | 146         |
| 83174   | ES128    | ES36  | 1-3/8" | A                              | 24.31    | 14.9      | 9.37   | YES       | YES           | 795       | 160         |
| 83175   | ES175    | ES175 | 1-3/8" | A                              | 20.48    | 13.19     | 7.29   | YES       | NO            | 1245      | 156         |
| 83176   | ES36     | ES36  | 1-3/8" | A                              | 26.62    | 15.96     | 10.66  | NO        | NO            | 406       | 275         |
| 83177   | S40      | EB1   | 1-3/8" | A                              | 14.99†   | 10.12     | 5.38   | YES       | NO            | 690       | 275         |
| 83178   | S38      | ES83  | 1-3/8" | A                              | 21.95    | 13.26     | 8.69   | YES       | NO            | 690       | 275         |
| 83180   | ES90     | ES83  | 1-3/8" |                                | 30.2     | 21.24     | 8.96   | YES       | NO            | 909       | 204         |
| 83200   | EB2      | EB2   | 1-3/8" | A                              | 24.51    | 15.1      | 9.53   | YES       | NO            | 806       | 370         |
| 83203   | ES36     | ES36  | 1-3/8" | A                              | 17.1     | 11.36     | 5.74   | YES       | YES           | 609       | 114         |
| 83204   | ES36     | ES36  | 1-3/8" | A                              | 20.14    | 12.86     | 7.28   | YES       | YES           | 451       | 110         |
| 83205   | ES36     | ES36  | 1-3/8" | A                              | 29.69    | 17.69     | 12     | YES       | YES           | 660       | 76          |
| 83207   | ES36     | ES36  | 1-3/8" | A                              | 21.64    | 13.61     | 8.03   | YES       | YES           | 553       | 143         |
| 83209   | ES36     | ES36  | 1-3/8" | A                              | 29.64    | 17.61     | 12.03  | YES       | YES           | 670       | 78          |
| 83214   | EB3      | EB3   | 1-3/8" | A                              | 19.64    | 12.86     | 6.78   | YES       | YES           | 269       | 90          |
| 83215   | EB3      | EB3   | 1-3/8" | A                              | 26.64    | 16.36     | 10.28  | YES       | YES           | 697       | 108         |
| 83216   | EB2      | EB2   | 1-3/8" | A                              | 23.51    | 14.48     | 9.03   | YES       | YES           | 776       | 262         |
| 83217   | EB3      | EB3   | 1-3/8" | A                              | 22.77    | 14.49     | 8.28   | YES       | YES           | 633       | 159         |
| 83218   | ES36     | ES36  | 1-3/8" | A                              | 25.19    | 15.44     | 9.75   | YES       | YES           | 721       | 194         |
| 83219   | EB2      | EB2   | 1-3/8" | A                              | 20.01    | 12.73     | 7.28   | YES       | YES           | 299       | 125         |
| 83221   | ES36     | ES36  | 1-3/8" | A                              | 24.01    | 14.73     | 9.28   | YES       | YES           | 599       | 153         |
| 83225   | EB3      | EB3   | 1-3/8" | A                              | 24.14    | 15.11     | 9.03   | YES       | YES           | 482       | 159         |
| 83242   | ES36     | ES36  | 1-3/8" | A                              | 33.73    | 20.98     | 12.75  | YES       | YES           | 721       | 135         |
| 83301   | S16      | ES90  | 1-3/8" | B                              | 24.52    | 14.74     | 9.78   | YES       | YES           | 653       | 86          |
| 83303   | EB7      | ES36  | 1-3/8" | B                              | 24.86    | 15.08     | 9.78   | YES       | YES           | 470       | 122         |
| 83304   | EB7      | ES36  | 1-3/8" | B                              | 22.86    | 14.08     | 8.78   | YES       | YES           | 470       | 122         |
| 83308   | EB2      | EB2   | 1-3/8" | B                              | 25.14    | 15.36     | 9.78   | YES       | YES           | 445       | 180         |
| 83309   | EB2      | EB2   | 1-3/8" | B                              | 28.64    | 17.11     | 11.53  | YES       | YES           | 589       | 135         |

\* Damping force, in pounds, to either extend or collapse the shock absorber at an average operating velocity. Fuerza de amortiguación en libras para extender o comprimir el amortiguador a una velocidad de operación promedio. La puissance d'amortissement en poids de l'amortisseur, soit comprimé, doit détendu, à une vitesse de fonctionnement moyenne.

**SPECIFICATIONS BY PART NUMBER**  
**ESPECIFICACIONES POR NÚMERO DE PARTE**  
**SPÉCIFICATIONS PAR NUMÉRO DE PIÈCE**

| Gabriel | Mounting |       | Bore    | External Diameter Illustration | Lengths  |           |        | Dust Tube | Recoil Cutoff | Controls* |             |
|---------|----------|-------|---------|--------------------------------|----------|-----------|--------|-----------|---------------|-----------|-------------|
|         | Upper    | Lower |         |                                | Extended | Collapsed | Stroke |           |               | Rebound   | Compression |
| 83310   | ES36     | ES36  | 1-3/8"  | B                              | 24.06    | 14.69     | 9.37   | YES       | NO            | 559       | 153         |
| 83312   | EB2      | EB2   | 1-3/8"  | B                              | 26.64    | 16.11     | 10.53  | YES       | YES           | 527       | 152         |
| 83314   | EB2      | EB2   | 1-3/8"  | B                              | 30.64    | 18.11     | 12.53  | YES       | YES           | 633       | 143         |
| 83317   | S16      | ES90  | 1-3/8"  | B                              | 27.03    | 16        | 11.34  | YES       | YES           |           |             |
| 83318   | S16      | S16   | 1-3/8"  | B                              | 22.53    | 13.5      | 9.03   | YES       | YES           | 323       | 77          |
| 83353   | EB3      | S21   | 1-3/8"  | B                              | 24.84    | 15.06     | 9.78   | YES       | NO            | 432       | 214         |
| 83362   | EB3      | EB3   | 1-3/8"  | B                              | 27       | 16.25     | 10.75  | YES       | NO            | 539       | 202         |
| 83363   | ES36     | ES36  | 1-3/8"  | A                              | 16.46    | 11.35     | 5.11   | YES       | YES           | 1084      | 201         |
| 83364   | ES90     | ES83  | 1-3/8"  | A                              | 24.06    | 15.07     | 8.99   | YES       | YES           | 855       | 206         |
| 83389   | ES36     | ES36  | 1-3/8"  | A                              | 17.32    | 11.57     | 5.75   | YES       | YES           | 1084      | 228         |
| 83391   | ES190    | ES190 | 1-3/8"  | A                              | 25.52    | 15.61     | 9.91   | YES       | NO            | 590       | 105         |
| 83395   | S21      | ES178 | 1-3/8"  | A                              | 27.19    | 16.28     | 10.91  | YES       | NO            | 616       | 105         |
| 83400   | S1       | S1    | 1-3/16" | F                              | 22.02    | 12.82     | 9.2    | YES       | NO            | 301       | 120         |
| 83401   | EB1      | EB1   | 1-3/16" | F                              | 24.09    | 14.26     | 9.83   | YES       | NO            | 341       | 252         |
| 83404   | EB2      | EB2   | 1-3/16" | F                              | 22.01    | 13.44     | 8.58   | YES       | NO            | 545       | 171         |
| 83456   | S21      | S21   | 1-3/8"  | B                              | 24.03    | 14.25     | 9.78   | YES       | YES           | 566       | 80          |
| 83515   | S1       | EB2   | 1-3/16" |                                | 23.34    | 13.89     | 9.45   | YES       | NO            | 643       | 205         |
| 83518   | S1       | EB2   | 1-3/16" |                                | 24.4     | 14.26     | 10.14  | YES       | NO            | 153       | 82          |
| 83519   | EB2      | EB2   | 1-3/16" | F                              | 23.83    | 14.35     | 9.48   | YES       | NO            | 292       | 132         |
| 83613   | S16      | S16   | 1-3/8"  | A                              | 21.04    | 12.76     | 8.28   | YES       | YES           | 601       | 242         |
| 83634   | ES120    | ES120 | 1-3/8"  | A                              | 27.48    | 16.23     | 11.25  | YES       | YES           | 779       | 157         |
| 83635   | ES36     | S21   | 1-3/8"  | A                              | 21.74    | 13.25     | 8.49   | YES       | NO            | 558       | 119         |
| 83636   | ES90     | ES90  | 1-3/8"  | A                              | 27.72    | 16.95     | 10.77  | YES       | YES           | 505       | 148         |
| 83901   | ES153    | ES153 | 1-3/8"  | A                              | 11.15†   | 9.2†      | 2.78   | YES       | YES           | 509       | 204         |
| 83905   | ES86     | ES167 | 1-3/8"  | 2-1/2" D/T                     | 9.3†     | 7.81†     | 2.21   | YES       | YES           | 1105      | 170         |
| 83906   | ES85     | EB1   | 1-3/8"  | 2-1/2" D/T                     | 10.45†   | 8.41†     | 3.01   | YES       | YES           | 586       | 320         |
| 85000   | ES36     | ES36  | 1-5/8"  | C                              | 17.28    | 11.5      | 5.78   | YES       | YES           | 1019      | 219         |
| 85001   | EB3      | EB3   | 1-5/8"  | C                              | 26.3     | 16.39     | 9.92   | YES       | NO            | 1202      | 186         |
| 85003   | ES90     | ES90  | 1-5/8"  | C                              | 25.42    | 15.63     | 9.79   | YES       | YES           | 437       | 182         |
| 85004   | EB3      | EB3   | 1-5/8"  | C                              | 20.68    | 13.67     | 7.01   | YES       | YES           | 1019      | 219         |
| 85005   | ES36     | ES36  | 1-5/8"  | C                              | 24.76    | 15.24     | 9.52   | YES       | YES           | 1019      | 219         |
| 85006   | ES36     | ES36  | 1-5/8"  | C                              | 28.54    | 17.13     | 11.41  | YES       | YES           | 1019      | 219         |
| 85007   | EB3      | EB3   | 1-5/8"  | C                              | 24.33    | 15.4      | 8.93   | YES       | YES           | 1008      | 171         |
| 85009   | S21      | ES36  | 1-5/8"  | C                              | 23.56    | 14.4      | 9.16   | YES       | YES           | 857       | 144         |
| 85010   | ES36     | ES36  | 1-5/8"  | C                              | 26.8     | 16.26     | 10.54  | YES       | YES           | 1019      | 219         |
| 85011   | ES120    | ES121 | 1-5/8"  | C                              | 27.49    | 16.46     | 11.03  | YES       | NO            | 1268      | 186         |
| 85012   | EB2      | EB2   | 1-5/8"  | C                              | 21.02    | 13.23     | 7.79   | YES       | NO            | 523       | 199         |
| 85013   | ES36     | ES36  | 1-5/8"  | C                              | 29.79    | 17.76     | 12.04  | YES       | YES           | 1019      | 219         |
| 85014   | ES36     | ES36  | 1-5/8"  | C                              | 21.76    | 13.74     | 8.02   | YES       | YES           | 1019      | 219         |

\* Damping force, in pounds, to either extend or collapse the shock absorber at an average operating velocity. Fuerza de amortiguación en libras para extender o comprimir el amortiguador a una velocidad de operación promedio. La puissance d'amortissement en poids de l'amortisseur, soit comprimé, doit détendu, à une vitesse de fonctionnement moyenne.

† At bumper contact / Al contacto con el tope de goma / Au contact avec le butoir

**SPECIFICATIONS BY PART NUMBER**  
**ESPECIFICACIONES POR NÚMERO DE PARTE**  
**SPÉCIFICATIONS PAR NUMÉRO DE PIÈCE**

| Gabriel | Mounting |       | Bore   | External Diameter Illustration | Lengths  |           |        | Dust Tube | Recoil Cutoff | Controls* |             |
|---------|----------|-------|--------|--------------------------------|----------|-----------|--------|-----------|---------------|-----------|-------------|
|         | Upper    | Lower |        |                                | Extended | Collapsed | Stroke |           |               | Rebound   | Compression |
| 85023   | EB2      | EB2   | 1-5/8" | C                              | 20.27    | 13        | 7.27   | YES       | YES           | 1008      | 539         |
| 85024   | EB2      | EB2   | 1-5/8" | C                              | 28.77    | 17.25     | 11.52  | YES       | YES           | 1008      | 539         |
| 85025   | EB2      | S21   | 1-5/8" | C                              | 23.02    | 14.01     | 9.01   | YES       | NO            | 1079      | 539         |
| 85026   | ES136    | S21   | 1-5/8" | C                              | 23.02    | 14.01     | 9.01   | YES       | NO            | 1079      | 539         |
| 85027   | S21      | S21   | 1-5/8" | C                              | 21.59    | 13.05     | 8.54   | YES       | NO            | 1008      | 539         |
| 85029   | ES36     | ES36  | 1-5/8" | C                              | 20.54    | 13.11     | 7.43   | YES       | YES           | 1019      | 219         |
| 85030   | ES36     | ES36  | 1-5/8" | C                              | 24.05    | 14.89     | 9.16   | YES       | YES           | 1019      | 219         |
| 85031   | ES176    | EB2   | 1-5/8" | C                              | 25.63    | 15.87     | 9.76   | YES       | NO            | 941       | 257         |
| 85033   | S21      | EB3   | 1-5/8" | C                              | 27.26    | 17.4      | 9.86   | YES       | YES           | 764       | 254         |
| 85036   | ES36     | ES36  | 1-5/8" | C                              | 26.38    | 16.29     | 10.09  | YES       | YES           | 633       | 119         |
| 85040   | EB3      | EB3   | 1-5/8" | C                              | 30.91    | 18.51     | 12.4   | YES       | NO            | 889       | 114         |
| 85042   | EB3      | EB3   | 1-5/8" | C                              | 20.64    | 13.61     | 7.03   | YES       | YES           | 333       | 161         |
| 85043   | ES36     | ES36  | 1-5/8" | C                              | 27.63    | 16.85     | 10.78  | YES       | YES           | 628       | 163         |
| 85044   | ES36     | ES36  | 1-5/8" | C                              | 22.63    | 14.1      | 8.53   | YES       | NO            | 722       | 212         |
| 85045   | ES36     | ES36  | 1-5/8" | C                              | 14.52    | 10.12     | 4.4    | YES       | YES           | 1020      | 219         |
| 85046   | EB2      | EB2   | 1-5/8" | C                              | 27.55    | 16.62     | 10.93  | YES       | YES           | 1008      | 539         |
| 85047   | EB2      | EB2   | 1-5/8" | C                              | 25.31    | 15.52     | 9.79   | YES       | YES           | 1008      | 539         |
| 85048   | S21      | S21   | 1-5/8" | C                              | 29.16    | 16.88     | 12.28  | YES       | NO            | 432       | 106         |
| 85049   | S21      | S21   | 1-5/8" | C                              | 25.53    | 15        | 10.53  | YES       | NO            | 597       | 107         |
| 85050   | ES36     | ES36  | 1-5/8" | C                              | 23.28    | 14.5      | 9.03   | YES       | NO            | 525       | 138         |
| 85051   | ES36     | ES36  | 1-5/8" | C                              | 18.54    | 12.13     | 6.41   | YES       | YES           | 1019      | 139         |
| 85052   | ES36     | ES36  | 1-5/8" | C                              | 13.26    | 9.49      | 3.77   | YES       | YES           | 1429      | 335         |
| 85053   | EB3      | EB3   | 1-5/8" | C                              | 24.69    | 15.52     | 9.17   | YES       | NO            | 1019      | 227         |
| 85054   | EB2      | EB2   | 1-5/8" | C                              | 23.26    | 14.37     | 8.89   | YES       | NO            | 602       | 104         |
| 85055   | EB2      | EB2   | 1-5/8" | C                              | 25.63    | 15.63     | 10     | YES       | NO            | 577       | 102         |
| 85056   | S21      | ES36  | 1-5/8" | C                              | 20.15    | 12.87     | 7.28   | YES       | YES           | 732       | 114         |
| 85057   | ES36     | EB3   | 1-5/8" | C                              | 21.45    | 14.23     | 7.22   | YES       | YES           | 1216      | 115         |
| 85058   | ES36     | ES36  | 1-5/8" | C                              | 22.67    | 14.26     | 8.41   | YES       | YES           | 722       | 114         |
| 85059   | ES36     | EB3   | 1-5/8" | C                              | 19.09    | 12.8      | 6.29   | YES       | YES           | 928       | 151         |
| 85060   | ES36     | ES36  | 1-5/8" | C                              | 19.79    | 12.76     | 7.04   | YES       | YES           | 943       | 405         |
| 85061   | ES161    | ES162 | 1-5/8" | C                              | 24.76    | 15.25     | 9.51   | YES       | YES           | 1216      | 195         |
| 85062   | EB2      | EB2   | 1-5/8" | C                              | 19.76    | 12.6      | 7.16   | YES       | NO            | 523       | 199         |
| 85063   | EB2      | EB2   | 1-5/8" | C                              | 32.01    | 18.85     | 13.16  | YES       | NO            | 762       | 174         |
| 85064   | ES36     | ES36  | 1-5/8" | C                              | 16.02    | 10.75     | 5.27   | YES       | YES           | 1481      | 340         |
| 85065   | ES161    | S21   | 1-5/8" | C                              | 28.05    | 17        | 11.05  | YES       | YES           | 1059      | 300         |
| 85066   | ES161    | ES162 | 1-5/8" | C                              | 24.64    | 15.25     | 9.39   | YES       | YES           | 812       | 322         |
| 85067   | ES174    | ES136 | 1-5/8" | C                              | 30.54    | 18.15     | 12.39  | YES       | YES           | 676       | 170         |
| 85069   | S21      | S21   | 1-5/8" | C                              | 26.31    | 15.97     | 10.33  | YES       | YES           | 762       | 255         |

\* Damping force, in pounds, to either extend or collapse the shock absorber at an average operating velocity. Fuerza de amortiguación en libras para extender o comprimir el amortiguador a una velocidad de operación promedio. La puissance d'amortissement en poids de l'amortisseur, soit comprimé, doit détendu, à une vitesse de fonctionnement moyenne.

**SPECIFICATIONS BY PART NUMBER**  
**ESPECIFICACIONES POR NÚMERO DE PARTE**  
**SPÉCIFICATIONS PAR NUMÉRO DE PIÈCE**

| Gabriel | Mounting |       | Bore   | External Diameter Illustration | Lengths  |           |        | Dust Tube | Recoil Cutoff | Controls* |             |
|---------|----------|-------|--------|--------------------------------|----------|-----------|--------|-----------|---------------|-----------|-------------|
|         | Upper    | Lower |        |                                | Extended | Collapsed | Stroke |           |               | Rebound   | Compression |
| 85070   | ES174    | EB3   | 1-5/8" | C                              | 25.59    | 15.83     | 9.76   | YES       | NO            | 1100      | 310         |
| 85071   | S21      | S21   | 1-5/8" | C                              | 25.57    | 15.02     | 10.55  | YES       | NO            | 610       | 107         |
| 85072   | ES36     | ES176 | 1-5/8" | C                              | 24.17    | 14.81     | 9.36   | YES       | YES           | 1387      | 305         |
| 85078   | ES36     | ES36  | 1-5/8" | C                              | 14.76    | 10.12     | 4.64   | YES       | YES           | 1409      | 282         |
| 85079   | ES36     | ES36  | 1-5/8" | C                              | 12.04    | 8.87      | 3.17   | YES       | YES           | 1494      | 325         |
| 85080   | ES175    | S21   | 1-5/8" | C                              | 22.51    | 13.77     | 8.74   | YES       | NO            | 447       | 138         |
| 85081   | ES175    | S21   | 1-5/8" | C                              | 23.44    | 14.33     | 9.11   | YES       | YES           | 1658      | 250         |
| 85082   | ES90     | ES90  | 1-5/8" | C                              | 28.6     | 20.64     | 7.97   | YES       | YES           | 1435      | 266         |
| 85083   | ES162    | S42   | 1-5/8" | C                              | 27.81    | 16.53     | 11.28  | YES       | YES           | 1429      | 184         |
| 85084   | ES174    | ES136 | 1-5/8" | C                              | 20.59    | 13.03     | 7.57   | YES       | NO            | 1145      | 407         |
| 85085   | S21      | S21   | 1-5/8" | C                              | 24.95    | 14.67     | 10.23  | YES       | NO            | 970       | 101         |
| 85086   | ES36     | ES36  | 1-5/8" | C                              | 17.55    | 11.63     | 5.92   | YES       | YES           | 2027      | 389         |
| 85087   | ES36     | ES176 | 1-5/8" | C                              | 22.78    | 14.7      | 8.08   | YES       | YES           | 1568      | 403         |
| 85088   | ES161    | ES162 | 1-5/8" | C                              | 25.31    | 15.52     | 9.79   | YES       | YES           | 616       | 178         |
| 85090   | ES150    | ES36  | 1-5/8" | C                              | 25.31    | 15.52     | 9.79   | YES       | YES           | 943       | 99          |
| 85091   | ES36     | ES36  | 1-5/8" | C                              | 21.38    | 13.56     | 7.82   | YES       | NO            | 1121      | 331         |
| 85092   | ES150    | S21   | 1-5/8" | C                              | 21.95    | 15.04     | 6.89   | YES       | YES           | 1597      | 138         |
| 85097   | ES36     | ES36  | 1-5/8" | C                              | 27.95    | 17.11     | 10.84  | YES       | YES           | 1086      | 109         |
| 85098   | ES161    | ES162 | 1-5/8" | C                              | 24.64    | 15.24     | 9.4    | YES       | YES           | 747       | 158         |
| 85099   | ES36     | ES36  | 1-5/8" | C                              | 26.02    | 15.93     | 10.09  | YES       | YES           | 1152      | 135         |
| 85102   | ES36     | ES136 | 1-5/8" | C                              | 21.52    | 14.93     | 6.59   | YES       | YES           | 1224      | 342         |
| 85106   | ES150    | ES150 | 1-5/8" | C                              | 20.03    | 12.89     | 7.14   | YES       | YES           | 1054      | 109         |
| 85109   | ES36     | ES195 | 1-5/8" | C                              | 24.21    | 15.14     | 9.07   | YES       | YES           | 1123      | 149         |
| 85119   | ES150    | ES150 | 1-5/8" | C                              | 21.39    | 13.81     | 7.68   | YES       | YES           | 1387      | 185         |
| 85120   | ES175    | ES175 | 1-5/8" | C                              | 23.67    | 15.06     | 8.61   | YES       | NO            | 2083      | 519         |
| 85122   | ES120    | S21   | 1-5/8" | C                              | 22.22    | 13.78     | 8.44   | YES       | YES           | 926       | 162         |
| 85123   | ES120    | S21   | 1-5/8" | C                              | 21.49    | 13.26     | 8.23   | YES       | NO            | 1809      | 246         |
| 85124   | S21      | S21   | 1-5/8" | C                              | 20.91    | 12.9      | 8.01   | YES       | YES           | 1086      | 222         |
| 85125   | ES158    | ES159 | 1-5/8" | C                              | 26.9     | 16.64     | 10.26  | YES       | YES           | 1479      | 183         |
| 85126   | ES158    | S21   | 1-5/8" | C                              | 21.76    | 13.63     | 8.13   | YES       | YES           | 1086      | 215         |
| 85180   | ES150    | ES36  | 1-5/8" | C                              | 20.94    | 13.83     | 7.11   | YES       | YES           | 681       | 283         |
| 85181   | ES150    | ES150 | 1-5/8" | C                              | 26.33    | 17.06     | 9.27   | YES       | YES           | 681       | 285         |
| 85182   | S43      | S43   | 1-5/8" | C                              | 26.86    | 16.04     | 10.82  | YES       | NO            | 708       | 232         |
| 85300   | EB3      | EB3   | 1-5/8" | D                              | 17.98    | 12.21     | 5.78   | YES       | YES           | 1435      | 676         |
| 85301   | EB3      | EB3   | 1-5/8" | D                              | 31.92    | 19.03     | 12.89  | YES       | NO            | 1442      | 455         |
| 85302   | EB3      | EB3   | 1-5/8" | D                              | 22.75    | 14.61     | 8.14   | YES       | NO            | 836       | 253         |
| 85303   | EB3      | EB3   | 1-5/8" | D                              | 24.76    | 15.48     | 9.29   | YES       | NO            | 1019      | 221         |
| 85304   | EB3      | EB3   | 1-5/8" | D                              | 22.25    | 14.22     | 8.03   | YES       | NO            | 767       | 325         |

\* Damping force, in pounds, to either extend or collapse the shock absorber at an average operating velocity. Fuerza de amortiguación en libras para extender o comprimir el amortiguador a una velocidad de operación promedio. La puissance d'amortissement en poids de l'amortisseur, soit comprimé, doit détendu, à une vitesse de fonctionnement moyenne.

† At bumper contact / Al contacto cone el tope de goma / Au contact avec le butoir

**SPECIFICATIONS BY PART NUMBER**  
**ESPECIFICACIONES POR NÚMERO DE PARTE**  
**SPÉCIFICATIONS PAR NUMÉRO DE PIÈCE**

| Gabriel | Mounting |       | Bore   | External Diameter Illustration | Lengths  |           |        | Dust Tube | Recoil Cutoff | Controls* |             |
|---------|----------|-------|--------|--------------------------------|----------|-----------|--------|-----------|---------------|-----------|-------------|
|         | Upper    | Lower |        |                                | Extended | Collapsed | Stroke |           |               | Rebound   | Compression |
| 85305   | EB3      | EB3   | 1-5/8" | D                              | 27.25    | 16.7      | 10.55  | YES       | NO            | 1120      | 225         |
| 85307   | EB3      | EB3   | 1-5/8" | D                              | 23.98    | 15.08     | 8.89   | YES       | NO            | 1094      | 173         |
| 85308   | EB3      | EB3   | 1-5/8" | D                              | 25.11    | 15.83     | 9.28   | YES       | YES           | 764       | 254         |
| 85310   | S21      | S21   | 1-5/8" | D                              | 18.63    | 11.71     | 6.92   | YES       | YES           | 1379      | 578         |
| 85311   | S21      | EB3   | 1-5/8" | D                              | 23.95    | 14.79     | 9.16   | YES       | YES           | 764       | 254         |
| 85312   | EB3      | S21   | 1-5/8" | D                              | 23.68    | 14.8      | 8.88   | YES       | YES           | 717       | 111         |
| 85313   | EB3      | EB3   | 1-5/8" | D                              | 26.26    | 16.35     | 9.91   | YES       | YES           | 717       | 111         |
| 85314   | EB3      | EB3   | 1-5/8" | D                              | 26.49    | 16.46     | 10.03  | YES       | YES           | 1216      | 169         |
| 85315   | EB3      | EB3   | 1-5/8" | D                              | 29.61    | 18.07     | 11.53  | YES       | NO            | 380       | 142         |
| 85316   | S21      | ES36  | 1-5/8" | D                              | 20.61    | 12.82     | 7.8    | YES       | NO            | 943       | 443         |
| 85317   | S21      | EB3   | 1-5/8" | D                              | 27.18    | 17.42     | 9.76   | YES       | YES           | 764       | 254         |
| 85318   | S21      | S21   | 1-5/8" | D                              | 27.37    | 16.36     | 11.01  | YES       | YES           | 1372      | 192         |
| 85319   | S21      | ES150 | 1-5/8" | D                              | 22.22    | 13.93     | 8.3    | YES       | YES           | 988       | 454         |
| 85320   | EB3      | EB3   | 1-5/8" | D                              | 26.15    | 16.35     | 9.8    | YES       | NO            | 970       | 308         |
| 85321   | ES36     | ES36  | 1-5/8" | D                              | 25.38    | 15.59     | 9.79   | YES       | YES           | 1435      | 676         |
| 85322   | EB3      | ES160 | 1-5/8" | D                              | 15.26    | 11.85     | 3.41   | YES       | YES           | 764       | 162         |
| 85323   | ES36     | ES36  | 1-5/8" | D                              | 17.36    | 11.58     | 5.78   | YES       | YES           | 1085      | 163         |
| 85324   | S21      | S21   | 1-5/8" | D                              | 22.14    | 13.61     | 8.53   | YES       | NO            | 579       | 114         |
| 85325   | S21      | S21   | 1-5/8" | D                              | 23.64    | 14.36     | 9.28   | YES       | NO            | 1024      | 240         |
| 85326   | S21      | S21   | 1-5/8" | D                              | 19.64    | 12.36     | 7.28   | YES       | NO            | 799       | 142         |
| 85327   | EB3      | ES160 | 1-5/8" | D                              | 16.01    | 12.1      | 3.91   | YES       | YES           | 764       | 162         |
| 85328   | S21      | S21   | 1-5/8" | D                              | 25.64    | 15.36     | 10.28  | YES       | NO            | 930       | 383         |
| 85329   | EB3      | EB3   | 1-5/8" | D                              | 24.52    | 15.48     | 9.04   | YES       | YES           | 1550      | 232         |
| 85330   | EB3      | S21   | 1-5/8" | D                              | 22.44    | 14.16     | 8.28   | YES       | YES           | 1140      | 176         |
| 85331   | ES158    | ES159 | 1-5/8" | D                              | 19.62    | 12.85     | 6.77   | YES       | YES           | 1757      | 396         |
| 85332   | S42      | ES36  | 1-5/8" | D                              | 20.64    | 12.98     | 7.66   | YES       | YES           | 2351      | 967         |
| 85333   | S42      | ES36  | 1-5/8" | D                              | 20.65    | 12.98     | 7.67   | YES       | YES           | 1241      | 534         |
| 85334   | EB3      | EB3   | 1-5/8" | D                              | 14.52    | 10.48     | 4.04   | YES       | YES           | 1271      | 319         |
| 85335   | ES158    | ES159 | 1-5/8" | D                              | 19.62    | 12.85     | 6.77   | YES       | YES           | 827       | 107         |
| 85336   | S21      | S21   | 1-5/8" | D                              | 18.76    | 11.86     | 6.9    | YES       | NO            | 861       | 200         |
| 85337   | ES36     | ES36  | 1-5/8" | D                              | 28.72    | 17.44     | 11.28  | YES       | YES           | 1318      | 374         |
| 85338   | ES36     | ES36  | 1-5/8" | D                              | 19.47    | 12.68     | 6.79   | YES       | YES           | 1664      | 420         |
| 85339   | EB3      | EB3   | 1-5/8" | D                              | 31.68    | 19.02     | 12.66  | YES       | YES           | 804       | 463         |
| 85340   | ES188    | S21   | 1-5/8" | D                              | 26.46    | 15.85     | 10.61  | YES       | YES           | 1807      | 165         |
| 85341   | ES188    | S21   | 1-5/8" | D                              | 30.96    | 18.1      | 12.86  | YES       | YES           | 1807      | 333         |
| 85342   | S21      | S21   | 1-5/8" | D                              | 23.28    | 13.99     | 9.29   | YES       | NO            | 893       | 188         |
| 85343   | S21      | EB3   | 1-5/8" | D                              | 22.96    | 14.79     | 8.17   | YES       | YES           | 858       | 289         |
| 85344   | ES36     | ES36  | 1-5/8" | D                              | 13.22    | 9.45      | 3.77   | YES       | YES           | 1581      | 443         |

\* Damping force, in pounds, to either extend or collapse the shock absorber at an average operating velocity. Fuerza de amortiguación en libras para extender o comprimir el amortiguador a una velocidad de operación promedio. La puissance d'amortissement en poids de l'amortisseur, soit comprimé, doit détendu, à une vitesse de fonctionnement moyenne.



**SPECIFICATIONS BY PART NUMBER**  
**ESPECIFICACIONES POR NÚMERO DE PARTE**  
**SPÉCIFICATIONS PAR NUMÉRO DE PIÈCE**

| Gabriel | Mounting |       | Bore    | External Diameter Illustration | Lengths  |           |        | Dust Tube | Recoil Cutoff | Controls* |             |
|---------|----------|-------|---------|--------------------------------|----------|-----------|--------|-----------|---------------|-----------|-------------|
|         | Upper    | Lower |         |                                | Extended | Collapsed | Stroke |           |               | Rebound   | Compression |
| 85345   | ES36     | ES36  | 1-5/8"  | D                              | 21.83    | 13.82     | 8.01   | YES       | YES           | 1093      | 219         |
| 85346   | S21      | S21   | 1-5/8"  | D                              | 22.12    | 13.48     | 8.64   | YES       | YES           | 2016      | 285         |
| 85347   | S21      | S21   | 1-5/8"  | D                              | 23.62    | 14.22     | 9.4    | YES       | YES           | 961       | 122         |
| 85351   | S21      | ES36  | 1-5/8"  | D                              | 20.61    | 12.82     | 7.79   | YES       | NO            | 1887      | 259         |
| 85376   | EB3      | EB3   | 1-5/8"  | D                              | 33.27    | 19.73     | 13.54  | YES       | NO            | 668       | 134         |
| 85377   | ES182    | ES182 | 1-5/8"  | D                              | 23.8     | 14.84     | 8.96   | YES       | YES           | 1937      | 570         |
| 85378   | ES182    | ES182 | 1-5/8"  | D                              | 23.8     | 14.84     | 8.96   | YES       | YES           | 1110      | 240         |
| 85379   | EB3      | S21   | 1-5/8"  | D                              | 22.69    | 14.4      | 8.29   | YES       | YES           | 1658      | 176         |
| 85380   | EB3      | S21   | 1-5/8"  | D                              | 23.95    | 14.79     | 9.15   | YES       | YES           | 1568      | 227         |
| 85382   | ES36     | ES36  | 1-5/8"  | D                              | 20.22    | 13.07     | 7.15   | YES       | YES           | 1658      | 420         |
| 85637   | ES90     | ES36  | 1-5/8"  | G                              | 20.74    | 13.19     | 7.55   | YES       | NO            | 2256      | 327         |
| 85638   | ES179    | ES179 | 1-5/8"  | G                              | 28.58    | 17.4      | 11.18  | YES       | YES           | 643       | 138         |
| 85639   | ES90     | ES36  | 1-5/8"  | G                              | 27.08    | 17.79     | 9.29   | YES       | NO            | 795       | 109         |
| 85700   | EB3      | EB3   | 1-5/8"  | D                              | 26.09    | 16.58     | 9.51   | YES       | YES           | 1446      | 328         |
| 85701   | S21      | S21   | 1-5/8"  | D                              | 15.64    | 10.36     | 5.28   | YES       | YES           | 914       | 204         |
| 85702   | EB3      | EB3   | 1-5/8"  | D                              | 23.76    | 15.85     | 7.91   | YES       | YES           | 1093      | 825         |
| 85703   | S21      | EB3   | 1-5/8"  | D                              | 29.57    | 18.54     | 11.03  | YES       | YES           | 1435      | 186         |
| 85704   | EB3      | EB3   | 1-5/8"  | D                              | 28.75    | 18.72     | 10.03  | YES       | YES           | 1435      | 186         |
| 85705   | S21      | S21   | 1-5/8"  | D                              | 23.62    | 14.23     | 9.39   | YES       | YES           | 639       | 436         |
| 85706   | S21      | S21   | 1-5/8"  | D                              | 23.65    | 14.24     | 9.41   | YES       | YES           | 1086      | 696         |
| 85707   | S21      | S21   | 2-1/16" | D                              | 23.65    | 14.4      | 9.25   | YES       | YES           | 1761      | 986         |
| 85708   | S21      | S21   | 1-5/8"  | D                              | 20.63    | 12.85     | 7.78   | YES       | YES           | 914       | 204         |
| 85709   | S21      | S21   | 1-5/8"  | D                              | 31.64    | 18.36     | 13.28  | YES       | YES           | 700       | 203         |
| 85710   | S21      | EB3   | 1-5/8"  | D                              | 23.45    | 15.1      | 8.34   | YES       | YES           | 994       | 248         |
| 85711   | S21      | EB3   | 1-5/8"  | D                              | 24.54    | 15.26     | 9.27   | YES       | YES           | 1435      | 208         |
| 85712   | EB3      | EB3   | 1-5/8"  | D                              | 20.5     | 13.47     | 7.04   | YES       | YES           | 1435      | 562         |
| 85713   | EB3      | EB3   | 1-5/8"  | D                              | 24.51    | 15.48     | 9.04   | YES       | YES           | 1157      | 180         |
| 85714   | EB3      | EB3   | 1-5/8"  | D                              | 25.13    | 15.85     | 9.28   | YES       | YES           | 1220      | 175         |
| 85715   | EB3      | EB3   | 1-5/8"  | D                              | 25.13    | 15.85     | 9.28   | YES       | YES           | 1915      | 200         |
| 85716   | EB3      | EB3   | 1-5/8"  | D                              | 21.99    | 14.33     | 7.66   | YES       | YES           | 1220      | 175         |
| 85717   | EB3      | EB3   | 1-5/8"  | D                              | 25.13    | 15.85     | 9.28   | YES       | YES           | 1915      | 200         |
| 85718   | EB3      | EB3   | 1-5/8"  | D                              | 22.13    | 15.04     | 7.09   | YES       | YES           | 2506      | 206         |
| 85719   | EB3      | EB3   | 1-5/8"  | D                              | 17.25    | 11.97     | 5.28   | YES       | YES           | 1517      | 213         |
| 85720   | EB3      | EB3   | 1-5/8"  | D                              | 20.5     | 13.47     | 7.03   | YES       | YES           | 1435      | 562         |
| 85722   | S21      | S21   | 1-5/8"  | D                              | 27.16    | 16.41     | 10.76  | YES       | YES           | 1264      | 369         |
| 85723   | EB3      | S21   | 1-5/8"  | D                              | 19.93    | 12.9      | 7.03   | YES       | YES           | 1318      | 248         |
| 85724   | ES158    | ES159 | 1-5/8"  | D                              | 22.81    | 14.51     | 8.3    | YES       | YES           | 1235      | 454         |
| 85727   | S21      | S21   | 1-5/8"  | D                              | 29.88    | 17.34     | 12.54  | YES       | YES           | 783       | 111         |

\* Damping force, in pounds, to either extend or collapse the shock absorber at an average operating velocity. Fuerza de amortiguación en libras para extender o comprimir el amortiguador a una velocidad de operación promedio. La puissance d'amortissement en poids de l'amortisseur, soit comprimé, doit détendu, à une vitesse de fonctionnement moyenne.

† At bumper contact / Al contacto con el tope de goma / Au contact avec le butoir

**SPECIFICATIONS BY PART NUMBER**  
**ESPECIFICACIONES POR NÚMERO DE PARTE**  
**SPÉCIFICATIONS PAR NUMÉRO DE PIÈCE**

| Gabriel | Mounting |       | Bore    | External Diameter Illustration | Lengths  |           |        | Dust Tube | Recoil Cutoff | Controls* |             |
|---------|----------|-------|---------|--------------------------------|----------|-----------|--------|-----------|---------------|-----------|-------------|
|         | Upper    | Lower |         |                                | Extended | Collapsed | Stroke |           |               | Rebound   | Compression |
| 85728   | S21      | S21   | 1-5/8"  | D                              | 24.37    | 14.86     | 9.51   | YES       | YES           | 1435      | 510         |
| 85729   | EB3      | S21   | 1-5/8"  | D                              | 21.55    | 13.77     | 7.78   | YES       | YES           | 783       | 111         |
| 85730   | EB3      | EB3   | 1-5/8"  | D                              | 30.75    | 18.72     | 12.03  | YES       | YES           | 1517      | 293         |
| 85731   | S21      | EB3   | 1-5/8"  | D                              | 30.57    | 18.54     | 12.03  | YES       | YES           | 1517      | 293         |
| 85732   | EB3      | EB3   | 2-1/16" | E                              | 22.13    | 15.11     | 7.03   | YES       | YES           | 2632      | 382         |
| 85733   | EB3      | S21   | 1-5/8"  | D                              | 23.57    | 14.73     | 8.84   | YES       | YES           | 717       | 111         |
| 85734   | EB3      | EB3   | 1-5/8"  | D                              | 20.73    | 13.7      | 7.03   | YES       | YES           | 1288      | 227         |
| 85735   | EB3      | EB3   | 1-5/8"  | D                              | 26.72    | 16.7      | 10.02  | YES       | YES           | 1288      | 227         |
| 85736   | EB3      | EB3   | 1-5/8"  | D                              | 23.61    | 15.2      | 8.41   | YES       | YES           | 1155      | 352         |
| 85737   | ES173    | ES173 | 1-5/8"  | D                              | 15.11    | 10.84     | 4.27   | YES       | YES           | 3066      | 782         |
| 85738   | ES36     | ES36  | 1-5/8"  | D                              | 17.46    | 11.69     | 5.77   | YES       | YES           | 1830      | 416         |
| 85739   | ES187    | ES187 | 1-5/8"  | D                              | 20.73    | 13.54     | 7.19   | YES       | YES           | 3247      | 334         |
| 85740   | EB3      | S21   | 1-5/8"  | D                              | 24.7     | 15.15     | 9.55   | YES       | YES           | 848       | 305         |
| 85745   | S21      | S21   | 1-5/8"  | D                              | 19.88    | 12.34     | 7.54   | YES       | YES           | 3064      | 231         |
| 85746   | S21      | S21   | 1-5/8"  | D                              | 19.88    | 12.34     | 7.54   | YES       | YES           | 1754      | 167         |
| 85900   | S21      | S21   | 1-5/8"  | G                              | 17.33    | 11.23     | 6.11   | YES       | YES           | 1467      | 337         |
| 85901   | EB3      | EB3   | 1-5/8"  | G                              | 29.09    | 17.68     | 11.42  | YES       | NO            | 1830      | 418         |
| 85902   | S21      | S21   | 1-5/8"  | G                              | 19.03    | 12.09     | 6.93   | YES       | YES           | 1441      | 267         |
| 85903   | ES36     | ES36  | 1-5/8"  | G                              | 31.99    | 19.13     | 12.86  | YES       | YES           | 666       | 113         |
| 85904   | ES36     | ES36  | 1-5/8"  | G                              | 27.61    | 16.88     | 10.73  | YES       | YES           | 666       | 113         |
| 85905   | ES36     | EB3   | 1-5/8"  | G                              | 23.81    | 16.16     | 7.66   | YES       | YES           | 1020      | 219         |
| 85906   | ES36     | ES36  | 1-5/8"  | G                              | 21.77    | 14.05     | 7.72   | YES       | YES           | 700       | 255         |
| 85907   | ES36     | EB3   | 1-5/8"  | G                              | 21.43    | 14.2      | 7.23   | YES       | YES           | 1216      | 251         |
| 85908   | ES36     | ES36  | 1-5/8"  | G                              | 18.48    | 12.25     | 6.23   | YES       | YES           | 1020      | 219         |
| 85909   | ES36     | ES36  | 1-5/8"  | G                              | 24.25    | 15.19     | 9.06   | YES       | YES           | 700       | 255         |
| 85910   | ES36     | ES36  | 1-5/8"  | G                              | 20.79    | 13.54     | 7.25   | YES       | YES           | 1074      | 219         |
| 85911   | ES36     | ES36  | 1-5/8"  | G                              | 16.89    | 11.53     | 5.36   | YES       | YES           | 1020      | 219         |
| 85912   | EB3      | ES36  | 1-5/8"  | G                              | 18.68    | 12.57     | 6.11   | YES       | YES           | 1020      | 219         |
| 85913   | ES36     | EB3   | 1-5/8"  | G                              | 22.56    | 15.2      | 7.36   | YES       | YES           | 1020      | 219         |
| 85914   | ES36     | ES36  | 1-5/8"  | G                              | 14.36    | 10.25     | 4.11   | YES       | YES           | 1020      | 219         |
| 85915   | ES36     | EB3   | 1-5/8"  | G                              | 19.06    | 12.7      | 6.36   | YES       | YES           | 1020      | 219         |
| 85916   | ES36     | ES36  | 1-5/8"  | G                              | 24.65    | 15.55     | 9.1    | YES       | YES           | 1149      | 219         |
| 85918   | ES150    | ES150 | 1-5/8"  | G                              | 22.97    | 14.58     | 8.39   | YES       | NO            | 1726      | 412         |
| 85919   | ES36     | ES36  | 1-5/8"  | G                              | 22.52    | 14.33     | 8.19   | YES       | YES           | 1265      | 121         |
| 85920   | ES150    | ES150 | 1-5/8"  | G                              | 21.16    | 13.57     | 7.59   | YES       | NO            | 845       | 49          |
| 85921   | S21      | ES36  | 1-5/8"  | G                              | 22.07    | 13.57     | 8.5    | YES       | NO            | 2053      | 339         |
| 85922   | ES150    | ES150 | 1-5/8"  | G                              | 21.19    | 13.53     | 7.66   | YES       | NO            | 878       | 185         |
| 85923   | ES177    | ES161 | 1-5/8"  | G                              | 22.52    | 14.52     | 8      | YES       | YES           | 1940      | 221         |

\* Damping force, in pounds, to either extend or collapse the shock absorber at an average operating velocity. Fuerza de amortiguación en libras para extender o comprimir el amortiguador a una velocidad de operación promedio. La puissance d'amortissement en poids de l'amortisseur, soit comprimé, doit détendu, à une vitesse de fonctionnement moyenne.

**SPECIFICATIONS BY PART NUMBER**  
**ESPECIFICACIONES POR NÚMERO DE PARTE**  
**SPÉCIFICATIONS PAR NUMÉRO DE PIÈCE**

| Gabriel | Mounting |       | Bore   | External Diameter Illustration | Lengths  |           |        | Dust Tube | Recoil Cutoff | Controls* |             |
|---------|----------|-------|--------|--------------------------------|----------|-----------|--------|-----------|---------------|-----------|-------------|
|         | Upper    | Lower |        |                                | Extended | Collapsed | Stroke |           |               | Rebound   | Compression |
| 85924   | ES90     | ES36  | 1-5/8" | G                              | 20.39    | 12.99     | 7.41   | YES       | NO            | 1036      | 122         |
| 85925   | ES90     | ES90  | 1-5/8" | G                              | 22.56    | 15.6      | 6.95   | YES       | NO            | 761       | 144         |
| 85926   | ES90     | ES90  | 1-5/8" | G                              | 26.5     | 17.96     | 8.54   | YES       | YES           | 1387      | 279         |
| 85927   | ES90     | ES90  | 1-5/8" | G                              | 24.76    | 15.47     | 9.3    | YES       | YES           | 1288      | 388         |
| 85928   | ES90     | ES90  | 1-5/8" | G                              | 20.31    | 13.24     | 7.07   | YES       | NO            | 957       | 229         |
| 85929   | ES90     | ES90  | 1-5/8" | G                              | 20.28    | 13.21     | 7.08   | YES       | NO            | 2214      | 267         |
| 85930   | ES177    | ES161 | 1-5/8" | G                              | 17.86    | 12        | 5.86   | YES       | YES           | 1617      | 342         |
| 85931   | ES177    | ES161 | 1-5/8" | G                              | 22.52    | 14.52     | 8      | YES       | YES           | 1435      | 220         |
| 85932   | ES178    | ES150 | 1-5/8" | G                              | 21.26    | 13.7      | 7.56   | YES       | YES           | 1102      | 430         |
| 85933   | ES175    | ES175 | 1-5/8" | G                              | 18.27    | 12.72     | 5.54   | YES       | YES           | 1089      | 383         |
| 85934   | ES36     | ES36  | 1-5/8" | G                              | 17.8     | 12.04     | 5.75   | YES       | YES           | 3511      | 1063        |
| 85935   | S21      | ES36  | 1-5/8" | G                              | 18.7     | 11.92     | 6.78   | YES       | NO            | 1054      | 419         |
| 85936   | ES174    | S43   | 1-5/8" | G                              | 17.27    | 11.48     | 5.79   | YES       | YES           | 1479      | 337         |
| 85937   | ES174    | S43   | 1-5/8" | G                              | 19.04    | 12.35     | 6.7    | YES       | YES           | 1479      | 337         |
| 85938   | ES36     | ES36  | 1-5/8" | G                              | 16.06    | 10.82     | 5.24   | YES       | YES           | 1581      | 432         |
| 85939   | ES36     | ES36  | 1-5/8" | G                              | 14.44    | 10.04     | 4.41   | YES       | YES           | 1719      | 420         |
| 85953   | ES90     | ES90  | 1-5/8" | G                              | 26.13    | 15.86     | 10.27  | YES       | NO            | 2001      | 153         |
| 85954   | ES90     | ES36  | 1-5/8" | G                              | 20.43    | 13        | 7.43   | YES       | NO            | 1812      | 148         |
| 85955   | ES175    | ES150 | 1-5/8" | G                              | 21.25    | 13.66     | 7.59   | YES       | YES           | 1034      | 397         |
| 85956   | ES183    | ES184 | 1-5/8" | G                              | 30.65    | 18.77     | 11.88  | YES       | YES           | 979       | 373         |
| 85957   | ES90     | ES90  | 1-5/8" | G                              | 20.78    | 13.19     | 7.6    | YES       | NO            | 1583      | 138         |
| 85958   | ES150    | ES150 | 1-5/8" | G                              | 22.89    | 14.5      | 8.39   | YES       | YES           | 1926      | 281         |
| 85959   | ES150    | ES150 | 1-5/8" | G                              | 21.16    | 13.57     | 7.59   | YES       | YES           | 1021      | 123         |
| 85961   | ES178    | ES176 | 1-5/8" | G                              | 22.83    | 14.17     | 8.66   | YES       | YES           | 2206      | 240         |
| 85962   | ES178    | ES176 | 1-5/8" | G                              | 21.8     | 13.66     | 8.15   | YES       | YES           | 2206      | 240         |
| 85963   | ES90     | ES36  | 1-5/8" | G                              | 25.49    | 18.68     | 6.81   | YES       | YES           | 1490      | 206         |
| 85964   | ES90     | ES36  | 1-5/8" | G                              | 25.49    | 18.68     | 6.81   | YES       | YES           | 1981      | 205         |
| 85965   | ES178    | ES161 | 1-5/8" | G                              | 24.24    | 15.15     | 9.09   | YES       | YES           | 2206      | 238         |
| 85966   | ES178    | ES161 | 1-5/8" | G                              | 23.25    | 14.64     | 8.62   | YES       | YES           | 2206      | 238         |
| 85967   | ES178    | ES176 | 1-5/8" | G                              | 23.93    | 14.86     | 9.07   | YES       | YES           | 2206      | 238         |
| 85968   | EB3      | EB3   | 1-5/8" | G                              | 19.87    | 13.39     | 6.48   | YES       | YES           | 1069      | 227         |
| 85969   | ES90     | ES36  | 1-5/8" | G                              | 18.38    | 11.93     | 6.45   | YES       | NO            | 1612      | 125         |
| 85970   | ES188    | S21   | 1-5/8" | G                              | 27.23    | 16.44     | 10.79  | YES       | YES           | 1092      | 147         |
| 85971   | ES36     | ES36  | 1-5/8" | G                              | 22.56    | 14.17     | 8.39   | YES       | NO            | 2315      | 451         |
| 85972   | ES36     | ES36  | 1-5/8" | G                              | 30.78    | 18.26     | 12.52  | YES       | NO            | 1493      | 261         |
| 85974   | ES36     | ES36  | 1-5/8" | G                              | 26.02    | 16.11     | 9.91   | YES       | YES           | 3087      | 230         |
| 85975   | ES36     | ES36  | 1-5/8" | G                              | 24.24    | 15.15     | 9.09   | YES       | YES           | 1658      | 219         |
| 85976   | ES36     | ES36  | 1-5/8" | G                              | 29.92    | 18.12     | 11.8   | YES       | YES           | 582       | 138         |
| 85977   | ES36     | S42   | 1-5/8" | G                              | 26.2     | 15.91     | 10.29  | YES       | YES           | 582       | 138         |

\* Damping force, in pounds, to either extend or collapse the shock absorber at an average operating velocity. Fuerza de amortiguación en libras para extender o comprimir el amortiguador a una velocidad de operación promedio. La puissance d'amortissement en poids de l'amortisseur, soit comprimé, doit détendu, à une vitesse de fonctionnement moyenne.

† At bumper contact / Al contacto con el tope de goma / Au contact avec le butoir

**SPECIFICATIONS BY PART NUMBER**  
**ESPECIFICACIONES POR NÚMERO DE PARTE**  
**SPÉCIFICATIONS PAR NUMÉRO DE PIÈCE**

| Gabriel | Mounting |       | Bore    | External Diameter Illustration | Lengths  |           |        | Dust Tube | Recoil Cutoff | Controls* |             |
|---------|----------|-------|---------|--------------------------------|----------|-----------|--------|-----------|---------------|-----------|-------------|
|         | Upper    | Lower |         |                                | Extended | Collapsed | Stroke |           |               | Rebound   | Compression |
| 85978   | ES179    | ES179 | 1-5/8"  | G                              | 29.84    | 18.16     | 11.69  | YES       | YES           | 582       | 138         |
| 85979   | ES36     | ES36  | 1-5/8"  | G                              | 31.18    | 18.66     | 12.52  | YES       | YES           | 582       | 138         |
| 85980   | ES179    | ES179 | 1-5/8"  | G                              | 31.17    | 18.66     | 12.52  | YES       | YES           | 582       | 138         |
| 85984   | ES158    | ES150 | 1-5/8"  | G                              | 25.44    | 15.96     | 9.48   | YES       | YES           | 2248      | 1168        |
| 85985   | ES174    | S43   | 1-5/8"  | G                              | 19.04    | 12.31     | 6.73   | YES       | YES           | 2068      | 723         |
| 85986   | ES175    | ES150 | 1-5/8"  | G                              | 21.25    | 13.66     | 7.59   | YES       | YES           | 1754      | 221         |
| 85988   | S21      | EB3   | 1-5/8"  | G                              | 23.84    | 14.87     | 8.97   | YES       | YES           | 1200      | 138         |
| 85989   | ES174    | ES136 | 1-5/8"  | G                              | 20.78    | 13.15     | 7.63   | YES       | NO            | 1812      | 351         |
| 85994   | ES90     | ES36  | 1-5/8"  | G                              | 21.21    | 13.4      | 7.81   | YES       | NO            | 1824      | 263         |
| 85995   | ES90     | ES36  | 1-5/8"  | G                              | 23.5     | 14.52     | 8.98   | YES       | NO            | 1830      | 173         |
| 85998   | ES90     | ES90  | 1-5/8"  | G                              | 22.83    | 14.17     | 8.66   | YES       | NO            | 1345      | 178         |
| 85999   | ES90     | ES90  | 1-5/8"  | G                              | 19.84    | 12.79     | 7.05   | YES       | NO            | 2214      | 259         |
| 86200   | ES194    | ES194 | 45 MM   | D                              | 14.24    | 10.45     | 3.79   | YES       | YES           | 4238      | 688         |
| 86201   | ES193    | ES193 | 45 MM   | D                              | 13.26    | 9.94      | 3.32   | YES       | YES           | 4238      | 688         |
| 86202   | ES193    | ES193 | 45 MM   | D                              | 14.52    | 10.43     | 4.09   | YES       | YES           | 4238      | 688         |
| 86203   | ES193    | ES193 | 45 MM   | D                              | 16.88    | 11.61     | 5.27   | YES       | YES           | 4238      | 910         |
| 87000   | S21      | EB3   | 2-1/16" | E                              | 24.46    | 15.21     | 9.25   | YES       | YES           | 1332      | 300         |
| 87001   | EB3      | EB3   | 2-1/16" | E                              | 20.76    | 13.76     | 7      | YES       | YES           | 1158      | 190         |
| 87002   | EB3      | EB3   | 2-1/16" | E                              | 23.5     | 15.41     | 8.09   | YES       | YES           | 879       | 203         |
| 87003   | EB3      | EB3   | 2-1/16" | E                              | 26.26    | 16.51     | 9.75   | YES       | YES           | 1332      | 395         |
| 87004   | EB3      | EB3   | 2-1/16" | E                              | 26.76    | 16.76     | 10     | YES       | YES           | 1158      | 190         |
| 87006   | EB3      | EB3   | 2-1/16" | E                              | 23.75    | 15.25     | 8.5    | YES       | YES           | 1158      | 272         |
| 87007   | S21      | S21   | 2-1/16" | E                              | 15.65    | 10.4      | 5.25   | YES       | YES           | 879       | 253         |
| 87011   | S21      | S21   | 2-1/16" | E                              | 23.65    | 14.4      | 9.25   | YES       | YES           | 1750      | 1050        |
| 87012   | S21      | S21   | 2-1/16" | E                              | 23.65    | 14.4      | 9.25   | YES       | YES           | 650       | 364         |
| 87013   | S21      | S21   | 2-1/16" | E                              | 23.65    | 14.4      | 9.25   | YES       | YES           | 1075      | 585         |
| 87015   | ES173    | ES173 | 45MM    | E                              | 15.51    | 11.18     | 4.33   | YES       | YES           | 4950      | 900         |
| 87016   | S21      | EB3   | 2-1/16" | E                              | 21.17    | 13.91     | 7.26   | YES       | YES           | 1808      | 238         |
| 87017   | ES160    | ES160 | 2-1/16" | E                              | 23.35    | 15.31     | 8.07   | YES       | YES           | 1876      | 220         |
| 87018   | ES36     | ES36  | 2-1/16" | E                              | 17.36    | 11.71     | 5.65   | YES       | YES           | 2479      | 1000        |
| 87019   | ES160    | ES160 | 2-1/16" | E                              | 24.84    | 15.85     | 8.9    | YES       | YES           | 2972      | 665         |
| 89401   | EB2      | EB2   | 1-5/8"  | G                              | 28.41    | 17.16     | 11.25  | YES       | NO            | 665‡      | 194         |
| 89402   | EB2      | EB2   | 1-5/8"  | G                              | 24.41    | 15.16     | 9.25   | YES       | NO            | 874‡      | 206         |
| 89403   | EB2      | EB2   | 1-5/8"  | G                              | 26.86    | 17.16     | 9.7    | YES       | YES           | 929‡      | 281         |
| 89405   | ES36     | ES36  | 1-5/8"  | G                              | 26.3     | 16.57     | 9.73   | YES       | YES           | 1009‡     | 249         |
| 89406   | ES36     | ES36  | 1-5/8"  | G                              | 24.76    | 15.82     | 8.93   | YES       | YES           | 658‡      | 125         |
| 89407   | ES36     | ES36  | 1-5/8"  | G                              | 21.61    | 14.17     | 7.45   | YES       | YES           | 652‡      | 218         |
| 89408   | EB2      | EB2   | 1-5/8"  | G                              | 19.68    | 12.9      | 6.78   | YES       | NO            | 536‡      | 201         |

\* Damping force, in pounds, to either extend or collapse the shock absorber at an average operating velocity. Fuerza de amortiguación en libras para extender o comprimir el amortiguador a una velocidad de operación promedio. La puissance d'amortissement en poids de l'amortisseur, soit comprimé, doit détendu, à une vitesse de fonctionnement moyenne.

**SPECIFICATIONS BY PART NUMBER**  
**ESPECIFICACIONES POR NÚMERO DE PARTE**  
**SPÉCIFICATIONS PAR NUMÉRO DE PIÈCE**

| Gabriel | Mounting |       | Bore   | External Diameter Illustration | Lengths  |           |        | Dust Tube | Recoil Cutoff | Controls* |             |
|---------|----------|-------|--------|--------------------------------|----------|-----------|--------|-----------|---------------|-----------|-------------|
|         | Upper    | Lower |        |                                | Extended | Collapsed | Stroke |           |               | Rebound   | Compression |
| 89409   | EB2      | EB2   | 1-5/8" | G                              | 27.13    | 16.92     | 10.2   | YES       | YES           | 567†      | 165         |
| 89410   | EB3      | EB3   | 1-5/8" | G                              | 26.34    | 16.57     | 9.77   | YES       | NO            | 1185†     | 182         |
| 89411   | ES90     | ES90  | 1-5/8" | G                              | 25.39    | 16.06     | 9.34   | YES       | YES           | 436†      | 186         |
| 89412   | EB3      | EB3   | 1-5/8" | G                              | 24.26    | 15.68     | 8.58   | YES       | YES           | 1155†     | 169         |
| 89413   | EB2      | EB2   | 1-5/8" | G                              | 20.94    | 13.53     | 7.41   | YES       | NO            | 536†      | 201         |
| 89414   | ES36     | ES36  | 1-5/8" | G                              | 29.65    | 18.18     | 11.46  | YES       | YES           | 1045†     | 217         |
| 89415   | EB2      | EB2   | 1-5/8" | G                              | 20.12    | 13.29     | 6.83   | YES       | YES           | 1155†     | 514         |
| 89416   | EB2      | EB2   | 1-5/8" | G                              | 28.62    | 17.54     | 11.08  | YES       | YES           | 1155†     | 514         |
| 89417   | ES136    | S21   | 1-5/8" | G                              | 22.94    | 14.31     | 8.63   | YES       | NO            | 1226†     | 515         |
| 89418   | S21      | S21   | 1-5/8" | G                              | 21.44    | 13.19     | 8.25   | YES       | NO            | 1266†     | 515         |
| 89419   | EB3      | EB3   | 1-5/8" | G                              | 18.04    | 12.67     | 5.36   | YES       | YES           | 1352†     | 636         |
| 89420   | EB3      | EB3   | 1-5/8" | G                              | 22.8     | 14.8      | 8      | YES       | NO            | 862†      | 258         |
| 89422   | EB3      | EB3   | 1-5/8" | G                              | 25.12    | 16.3      | 8.83   | YES       | YES           | 794†      | 253         |
| 89423   | S21      | S21   | 1-5/8" | G                              | 18.67    | 12.21     | 6.46   | YES       | YES           | 1352†     | 573         |
| 89424   | S21      | EB3   | 1-5/8" | G                              | 23.73    | 15.14     | 8.59   | YES       | YES           | 794†      | 253         |
| 89425   | EB3      | EB3   | 1-5/8" | G                              | 26.5     | 16.93     | 9.57   | YES       | YES           | 1352†     | 167         |
| 89426   | S21      | ES36  | 1-5/8" | G                              | 20.46    | 13.05     | 7.41   | YES       | NO            | 926†      | 419         |
| 89427   | S21      | EB3   | 1-5/8" | G                              | 27.19    | 17.62     | 9.57   | YES       | YES           | 794†      | 253         |
| 89428   | S21      | ES150 | 1-5/8" | G                              | 22       | 14.27     | 7.72   | YES       | YES           | 958†      | 446         |
| 89429   | EB3      | EB3   | 1-5/8" | G                              | 26.22    | 16.57     | 9.65   | YES       | NO            | 941†      | 266         |
| 89430   | ES36     | ES36  | 1-5/8" | G                              | 24.61    | 15.66     | 8.94   | YES       | YES           | 1462†     | 279         |
| 89431   | ES36     | ES36  | 1-5/8" | G                              | 22.41    | 14.16     | 8.25   | YES       | NO            | 751†      | 211         |
| 89432   | ES36     | ES36  | 1-5/8" | G                              | 23.42    | 14.79     | 8.63   | YES       | NO            | 1507†     | 561         |
| 89434   | EB2      | EB2   | 1-5/8" | G                              | 27.12    | 16.79     | 10.33  | YES       | YES           | 1155†     | 514         |
| 89435   | EB2      | EB2   | 1-5/8" | G                              | 24.92    | 15.82     | 9.1    | YES       | YES           | 1155†     | 514         |
| 89436   | ES36     | ES36  | 1-5/8" | G                              | 17.24    | 12.04     | 5.2    | YES       | YES           | 998†      | 217         |
| 89437   | ES36     | ES36  | 1-5/8" | G                              | 20.12    | 13.42     | 6.7    | YES       | YES           | 1155†     | 514         |
| 89438   | EB2      | EB2   | 1-5/8" | G                              | 23.17    | 14.54     | 8.63   | YES       | NO            | 583†      | 103         |
| 89439   | EB2      | EB2   | 1-5/8" | G                              | 25.67    | 15.79     | 9.88   | YES       | NO            | 518†      | 103         |
| 89440   | ES36     | ES36  | 1-5/8" | G                              | 23.9     | 15.31     | 8.59   | YES       | YES           | 1498†     | 561         |
| 89441   | S21      | ES36  | 1-5/8" | G                              | 20.14    | 13.06     | 7.08   | YES       | YES           | 761†      | 126         |
| 89442   | EB3      | EB3   | 1-5/8" | G                              | 24.72    | 15.74     | 8.98   | YES       | NO            | 1055†     | 224         |
| 89443   | ES158    | ES159 | 1-5/8" | G                              | 22.19    | 14.66     | 7.53   | YES       | YES           | 1206†     | 466         |
| 89446   | EB2      | EB2   | 1-5/8" | G                              | 28.36    | 17.41     | 10.95  | YES       | YES           | 702†      | 204         |
| 89447   | S21      | S21   | 1-5/8" | G                              | 23.63    | 14.69     | 8.94   | YES       | YES           | 702†      | 241         |
| 89448   | ES161    | ES162 | 1-5/8" | G                              | 24.61    | 15.66     | 8.94   | YES       | YES           | 782†      | 323         |
| 89449   | ES150    | ES150 | 1-5/8" | G                              | 23.25    | 14.9      | 8.35   | YES       | NO            | 1519†     | 324         |
| 89450   | ES161    | ES162 | 1-5/8" | G                              | 24.61    | 15.66     | 8.94   | YES       | YES           | 1282†     | 193         |

\* Damping force, in pounds, to either extend or collapse the shock absorber at an average operating velocity. Fuerza de amortiguación en libras para extender o comprimir el amortiguador a una velocidad de operación promedio. La puissance d'amortissement en poids de l'amortisseur, soit comprimé, doit détendu, à une vitesse de fonctionnement moyenne.

† At bumper contact / Al contacto con el tope de goma / Au contact avec le butoir

**SPECIFICATIONS BY PART NUMBER**  
**ESPECIFICACIONES POR NÚMERO DE PARTE**  
**SPÉCIFICATIONS PAR NUMÉRO DE PIÈCE**

| Gabriel | Mounting |       | Bore    | External Diameter Illustration | Lengths  |           |        | Dust Tube | Recoil Cutoff | Controls* |             |
|---------|----------|-------|---------|--------------------------------|----------|-----------|--------|-----------|---------------|-----------|-------------|
|         | Upper    | Lower |         |                                | Extended | Collapsed | Stroke |           |               | Rebound   | Compression |
| 89451   | ES174    | ES136 | 1-5/8"  | G                              | 30.39    | 18.54     | 11.86  | YES       | YES           | 645‡      | 172         |
| 89453   | ES178    | ES150 | 1-5/8"  | G                              | 21.14    | 13.93     | 7.21   | YES       | YES           | 860‡      | 435         |
| 89454   | ES175    | ES175 | 1-5/8"  | G                              | 18.27    | 12.91     | 5.36   | YES       | YES           | 938‡      | 388         |
| 89455   | S21      | S21   | 1-5/8"  | G                              | 26.31    | 16.03     | 10.28  | YES       | YES           | 791‡      | 276         |
| 89456   | ES174    | S43   | 1-5/8"  | G                              | 17.04    | 11.63     | 5.4    | YES       | YES           | 975‡      | 377         |
| 89457   | ES90     | ES36  | 1-5/8"  | G                              | 19.92    | 13.02     | 6.89   | YES       | NO            | 941‡      | 156         |
| 89458   | ES177    | ES161 | 1-5/8"  | G                              | 22.48    | 14.6      | 7.88   | YES       | YES           | 1575‡     | 222         |
| 89459   | ES174    | EB3   | 1-5/8"  | G                              | 25.63    | 16.14     | 9.49   | YES       | NO            | 1179‡     | 314         |
| 89460   | ES174    | ES136 | 1-5/8"  | G                              | 20.58    | 13.03     | 7.55   | YES       | NO            | 997‡      | 384         |
| 89461   | ES160    | ES160 | 1-5/8"  | G                              | 19.96    | 13.58     | 6.38   | YES       | YES           | 897‡      | 103         |
| 89503   | ES150    | ES150 | 1-5/8"  | G                              | 21.28    | 13.72     | 7.56   | YES       | NO            | 1033‡     | 123         |
| 630811  | 0        | 0     | 1-3/16" |                                | 22.45    | 14.1      | 8.35   | NO        | NO            |           |             |
| 632147  | 0        | 0     | 1-3/16" |                                | 22.45    | 14.1      | 8.35   | NO        | NO            |           |             |
| 632155  | ES36     | ES36  | 1-3/16" |                                | 22.45    | 14.1      | 8.35   | NO        | NO            |           |             |
| 646155  | ES36     | ES36  | 1-3/16" |                                | 22.45    | 14.1      | 8.35   | YES       | NO            |           |             |
| 646177  | ES36     | ES36  | 1-3/16" |                                | 22.45    | 14.1      | 8.35   | NO        | NO            |           |             |
| 665472  | ES36     | ES36  | 1-5/8"  | G                              | 25.14    | 15.61     | 9.53   | NO        | NO            | 925       | 977         |
| 665937  | ES36     | ES36  | 1-5/8"  | G                              | 22.91    | 16.09     | 6.82   | YES       | NO            |           |             |
| 695406  | S21      | S21   | 2-1/16" | E                              | 21.39    | 13.26     | 8.13   | YES       | YES           | 1854      | 274         |
| G63183  | EB4      | EB4   | 1-3/8"  |                                | 20.89    | 13.11     | 7.78   | YES       | NO            |           |             |
| G63299  | EB1      | EB1   | 1-3/8"  |                                | 18.08    | 11.55     | 6.53   | YES       | NO            | 396       | 109         |
| G63306  | ES2      | ES24  | 1-3/8"  |                                | 19.86    | 12.58     | 7.28   | YES       | NO            |           |             |
| G63347  | ES3      | ES24  | 1-3/8"  |                                | 18.08    | 11.55     | 6.53   | YES       | NO            |           |             |
| G63350  | S1       | ES25  | 1-3/8"  |                                | 18.83    | 11.8      | 7.03   | YES       | NO            |           |             |
| G63355  | EB7      | ES24  | 1-3/8"  |                                | 15       | 9.97      | 5.03   | YES       | NO            |           |             |
| G63357  | ES24     | ES24  | 1-3/8"  |                                | 15       | 9.97      | 5.03   | YES       | NO            |           |             |
| G63366  | ES34     | ES34  | 1-3/8"  |                                | 23.36    | 14.33     | 9.03   | YES       | NO            |           |             |
| G63386  | S36      | ES25  | 1-3/8"  |                                | 17.19    | 11.16     | 6.03   | NO        | YES           |           |             |
| G63387  | S1       | ES25  | 1-3/8"  |                                | 23.33    | 14.05     | 9.28   | YES       | NO            |           |             |
| G63396  | S10      | ES25  | 1-3/8"  |                                | 16.55    | 10.77     | 5.78   | YES       | NO            |           |             |
| G63398  | S1       | S1    | 1-3/8"  |                                | 20.52    | 12.24     | 8.28   | YES       | NO            |           |             |
| G63403  | ES82     | ES82  | 1-3/8"  |                                | 24.58    | 14.8      | 9.78   | YES       | NO            |           |             |
| G63405  | EB1      | EB1   | 1-3/8"  |                                | 20       | 12.47     | 7.53   | YES       | NO            | 572       | 115         |
| G63406  | EB1      | ES83  | 1-3/8"  |                                | 23       | 13.97     | 9.03   | YES       | NO            |           |             |
| G63409  | EB1      | ES83  | 1-3/8"  |                                | 21.58    | 13.3      | 8.28   | YES       | NO            |           |             |
| G63414  | S28      | ES83  | 1-3/8"  |                                | 15.09    | 10.06     | 5.03   | NO        | YES           |           |             |
| G63419  | EB1      | EB1   | 1-3/8"  |                                | 24.08    | 14.55     | 9.53   | YES       | NO            |           |             |
| G63432  | S1       | EB2   | 1-3/8"  |                                | 21.21    | 12.93     | 8.28   | YES       | NO            |           |             |

\* Damping force, in pounds, to either extend or collapse the shock absorber at an average operating velocity. Fuerza de amortiguación en libras para extender o comprimir el amortiguador a una velocidad de operación promedio. La puissance d'amortissement en poids de l'amortisseur, soit comprimé, doit détendu, à une vitesse de fonctionnement moyenne.

**SPECIFICATIONS BY PART NUMBER**  
**ESPECIFICACIONES POR NÚMERO DE PARTE**  
**SPÉCIFICATIONS PAR NUMÉRO DE PIÈCE**

| Gabriel | Mounting |       | Bore   | External Diameter Illustration | Lengths  |           |        | Dust Tube | Recoil Cutoff | Controls* |             |
|---------|----------|-------|--------|--------------------------------|----------|-----------|--------|-----------|---------------|-----------|-------------|
|         | Upper    | Lower |        |                                | Extended | Collapsed | Stroke |           |               | Rebound   | Compression |
| G63440  | EB1      | EB1   | 1-3/8" |                                | 26.33    | 15.55     | 10.78  | NO        | NO            |           |             |
| G63455  | ES8      | ES83  | 1-3/8" |                                | 23       | 13.97     | 9.03   | YES       | NO            |           |             |
| G63461  | EB1      | ES83  | 1-3/8" |                                | 25.5     | 15.22     | 10.28  | YES       | NO            |           |             |
| G63484  | S4       | EB1   | 1-3/8" |                                | 20.05    | 12.52     | 7.53   | YES       | NO            |           |             |
| G63500  | S28      | ES25  | 1-3/8" |                                | 15.09    | 10.06     | 5.03   | NO        | YES           |           |             |
| G63511  | S1       | ES25  | 1-3/8" |                                | 22.55    | 13.52     | 9.03   | YES       | NO            |           |             |
| G63524  | EB1      | ES83  | 1-3/8" |                                | 27.08    | 16.05     | 11.03  | YES       | NO            |           |             |
| G63525  | EB1      | ES83  | 1-3/8" |                                | 23.08    | 14.05     | 9.03   | YES       | NO            |           |             |
| G63605  | EB2      | ES27  | 1-3/8" |                                | 24.24    | 14.71     | 9.53   | YES       | NO            |           |             |
| G63607  | BP33     | ES83  | 1-3/8" |                                | 25.58    | 15.3      | 10.28  | YES       | NO            |           |             |
| G63608  | S36      | EB1   | 1-3/8" |                                | 14.58    | 9.81      | 4.78   | YES       | YES           |           |             |
| G63610  | S1       | EB1   | 1-3/8" |                                | 21.55    | 13.27     | 8.28   | YES       | NO            |           |             |
| G63614  | S36      | EB1   | 1-3/8" |                                | 15.12    | 10.09     | 5.03   | NO        | YES           |           |             |
| G63622  | S36      | EB1   | 1-3/8" |                                | 15.42    | 10.39     | 5.03   | YES       | YES           |           |             |
| G63623  | S36      | ES83  | 1-3/8" |                                | 22.67    | 14.39     | 8.28   | YES       | YES           |           |             |
| G63624  | S36      | ES83  | 1-3/8" |                                | 20.17    | 12.64     | 7.53   | YES       | YES           |           |             |
| G63625  | EB7      | ES36  | 1-3/8" |                                | 22.48    | 13.96     | 8.53   | YES       | NO            |           |             |
| G63676  | ES69     | ES69  | 1-3/8" |                                | 15.58    | 10.55     | 5.03   | YES       | YES           |           |             |
| G63678  | S36      | BP7   | 1-3/8" |                                | 18.09    | 13.56     | 4.53   | YES       | NO            |           |             |
| G63679  | BP8      | ES83  | 1-3/8" |                                | 25       | 14.97     | 10.03  | YES       | NO            |           |             |
| G63714  | S6       | BP7   | 1-3/8" |                                | 15.54    | 10.01     | 5.53   | YES       | NO            |           |             |
| G63716  | S12      | ES26  | 1-3/8" |                                | 15.54    | 10.01     | 5.53   | YES       | NO            |           |             |
| G63772  | S6       | BP35  | 1-3/8" |                                | 13.83    | 9.55      | 4.28   | YES       | YES           |           |             |
| G63773  | EB1      | ES83  | 1-3/8" |                                | 23.08    | 14.05     | 9.03   | YES       | NO            |           |             |
| G63775  | EB1      | ES83  | 1-3/8" |                                | 27.08    | 16.05     | 11.03  | YES       | NO            |           |             |
| G63778  | S12      | ES25  | 1-3/8" |                                | 24.55    | 14.52     | 10.03  | YES       | NO            |           |             |
| G63808  | EB1      | ES83  | 1-3/8" |                                | 28.86    | 17.08     | 11.78  | YES       | NO            |           |             |
| G63809  | EB1      | ES83  | 1-3/8" |                                | 23       | 13.97     | 9.03   | YES       | NO            |           |             |
| G63810  | EB1      | ES83  | 1-3/8" |                                | 31.51    | 18.48     | 13.03  | YES       | NO            |           |             |
| G63811  | EB1      | ES83  | 1-3/8" |                                | 25.5     | 15.22     | 10.28  | YES       | NO            |           |             |
| G63837  | BP8      | ES83  | 1-3/8" |                                | 28.23    | 17.95     | 10.28  |           |               |           |             |
| G63866  | ES34     | ES34  | 1-3/8" |                                | 22.81    | 14.12     | 8.69   |           |               |           |             |
| G63929  | S36      | EB1   | 1-3/8" |                                | 14.72    | 9.71      | 5.01   | YES       | YES           |           |             |
| G63969  | 412847   | ES34  | 1-3/8" |                                | 20.75    | 13.31     | 7.44   |           |               |           |             |

\* Damping force, in pounds, to either extend or collapse the shock absorber at an average operating velocity. Fuerza de amortiguación en libras para extender o comprimir el amortiguador a una velocidad de operación promedio. La puissance d'amortissement en poids de l'amortisseur, soit comprimé, doit détendu, à une vitesse de fonctionnement moyenne.

† At bumper contact / Al contacto con el tope de goma / Au contact avec le butoir

**MOUNTING ACCESSORY PACKAGES AND COMPONENT PARTS**  
**KITS DE ACCESORIOS Y COMPONENTES**  
**ENSEMBLES D'ACCESSOIRES DE MONTURES ET DE PIÈCES DÉTACHÉES**

|               |            |   |  |  |
|---------------|------------|---|--|--|
| <b>140126</b> | 401006     | 1 | Hex nut / Tuerca hexagonal / Écrou hexagonal             | 3/8" x 24 UNF thread                                   |
|               | 401383     | 2 | Retainer (washer) / Seguro (arandela) / Arrêt (rondelle) | 3/8 in. I.D. x 1-1/2 in. O.D. x .093 in. thick         |
|               | 402263     | 2 | Bushing / Buje / Bague                                   | 7/8" centering lip for 3/8" O.D. stud                  |
| <b>140149</b> | 401011     | 4 | Bushing / Buje / Bague                                   | EB2 style - for 1-3/4" O.D. eye ring - 3/4" diam. Stud |
| <b>140169</b> | 401011     | 2 | Bushing / Buje / Bague                                   | EB2 style - for 1-3/4" O.D. eye ring - 3/4" diam. Stud |
| <b>140357</b> | 401164     | 1 | Hex nut / Tuerca hexagonal / Écrou hexagonal             | 1/2" x 20 UNF Thread                                   |
|               | 401166     | 1 | Lock washer / Arandela de seguridad / Rondelle-frein     | 1/2" lock washer                                       |
|               | 401174     | 1 | Hex nut / Tuerca hexagonal / Écrou hexagonal             | 5/8" x 18 thread                                       |
|               | 401193     | 1 | Lock washer / Arandela de seguridad / Rondelle-frein     | 5/8" I.D. (thin)                                       |
|               | 401266     | 1 | Retainer (washer) / Seguro (arandela) / Arrêt (rondelle) | 5/8" I.D. x 1-1/4" O.D. x .075" thick                  |
|               | 402519     | 1 | Retainer (washer) / Seguro (arandela) / Arrêt (rondelle) | 1/2" I.D. x 1-1/4" O.D. x .104" thick                  |
|               | 403050     | 1 | Stud / Perno / Goujon                                    | 1/2" x 20 and 5/8" x 18 thread                         |
| <b>140455</b> | 401006     | 1 | Hex nut / Tuerca hexagonal / Écrou hexagonal             | 3/8" x 24 UNF thread                                   |
|               | 401008     | 2 | Retainer (washer) / Seguro (arandela) / Arrêt (rondelle) | 3/8 in. I.D. x 1-1/4 in. O.D. x .075 in. thick         |
|               | 403489     | 2 | Bushing / Buje / Bague                                   | 5/8" centering lip for 3/8" O.D. stud                  |
| <b>140524</b> | 401006     | 1 | Hex nut / Tuerca hexagonal / Écrou hexagonal             | 3/8" x 24 UNF thread                                   |
|               | 401376     | 2 | Retainer (washer) / Seguro (arandela) / Arrêt (rondelle) | 3/8 in. I.D. x 1-3/8 in. O.D. x .089 in. thick         |
|               | 402294     | 2 | Bushing / Buje / Bague                                   | 5/8" lip for 3/8" dia. stud-5/8" or 7/8" holes         |
| <b>140526</b> | 403813     | 2 | Boot / Bota / Gaine                                      |  |
|               | 403815     | 2 | Cotter pin / Chaveta / Goupille                          |  |
|               | 404046     | 2 | Nut / Tuerca / Écrou                                     | 1/2" x 20 UNF Thread                                   |
| <b>140673</b> | 401006     | 1 | Hex nut / Tuerca hexagonal / Écrou hexagonal             | 3/8" x 24 UNF thread                                   |
|               | 401008     | 2 | Retainer (washer) / Seguro (arandela) / Arrêt (rondelle) | 3/8 in. I.D. x 1-1/4 in. O.D. x .075 in. thick         |
|               | 403962     | 2 | Bushing / Buje / Bague                                   | 1/2" centering lip for 3/8" O.D. stud                  |
| <b>140689</b> | 401006     | 3 | Hex nut / Tuerca hexagonal / Écrou hexagonal             | 3/8" x 24 UNF thread                                   |
|               | 402263     | 2 | Bushing / Buje / Bague                                   | 7/8" centering lip for 3/8" O.D. stud                  |
|               | 404001     | 2 | Retainer (washer) / Seguro (arandela) / Arrêt (rondelle) | 10 mm I.D. x 1-1/2" O.D. x .120" thick                 |
| <b>140702</b> | 401174     | 1 | Hex nut / Tuerca hexagonal / Écrou hexagonal             | 5/8" x 18 thread                                       |
|               | 401184     | 1 | Lock washer / Arandela de seguridad / Rondelle-frein     | 7/16" Lock washer                                      |
|               | 401193     | 1 | Lock washer / Arandela de seguridad / Rondelle-frein     | 5/8" I.D. (thin)                                       |
|               | 402844     | 1 | Hex nut / Tuerca hexagonal / Écrou hexagonal             | 7/16" x 20 UNF Thread                                  |
|               | 403878     | 1 | Washer / Arandela / Rondelle                             | 0.453" I.D. x 1.25" O.D. x .075" thick                 |
|               | 404782     | 1 | Stud / Perno / Goujon                                    | 5/8" x 18 and 7/16" x 20                               |
| <b>140719</b> | 402653-001 | 2 | Lock washer / Arandela de seguridad / Rondelle-frein     | 5/16" I.D. (med.)                                      |
|               | 403870-001 | 2 | Bolt / Tornillo / Boulon                                 | Hex Head 5/16" x 18 x 3/4 in. long                     |
|               | 403871-001 | 2 | Hex nut / Tuerca hexagonal / Écrou hexagonal             | 5/16" x 18 thread                                      |
| <b>140780</b> | 401006     | 1 | Hex nut / Tuerca hexagonal / Écrou hexagonal             | 3/8" x 24 UNF thread                                   |
|               | 402943     | 1 | Retainer (washer) / Seguro (arandela) / Arrêt (rondelle) | 0.457" I.D. x 1.68" O.D. x .120" thick                 |
|               | 403298     | 1 | Retainer (washer) / Seguro (arandela) / Arrêt (rondelle) | 0.390" I.D. x 1.68" O.D. x .120" thick                 |
|               | 403299     | 2 | Bushing / Buje / Bague                                   | 7/8" centering lip for 7/16" O.D. stud                 |
| <b>140857</b> | 401006     | 1 | Hex nut / Tuerca hexagonal / Écrou hexagonal             | 3/8" x 24 UNF thread                                   |
|               | 401008     | 1 | Retainer (washer) / Seguro (arandela) / Arrêt (rondelle) | 3/8 in. I.D. x 1-1/4 in. O.D. x .075 in. thick         |
|               | 401383     | 1 | Retainer (washer) / Seguro (arandela) / Arrêt (rondelle) | 3/8 in. I.D. x 1-1/2 in. O.D. x .093 in. thick         |
|               | 403489     | 2 | Bushing / Buje / Bague                                   | 5/8" centering lip for 3/8" O.D. stud                  |
|               | 429680-030 | 1 | Instruction sheet / Hoja de instr. / Feuillet d'instr.   |  |
| <b>140884</b> | 401267     | 1 | Retainer (washer) / Seguro (arandela) / Arrêt (rondelle) | 5/8" I.D. x 1-1/4" O.D. x .075" thick                  |
|               | 402662     | 1 | Spacer / Espaciador / Entretoise                         | 5/8" I.D. x 1-1/4" O.D. x 1/4" thick                   |
|               | 412016     | 1 | Extn nut / Tuerca ext. / Écrou ext.                      | 7/16" x 20 UNF Thread                                  |
|               | 427030     | 1 | Instruction sheet / Hoja de instr. / Feuillet d'instr.   |  |



**MOUNTING ACCESSORY PACKAGES AND COMPONENT PARTS**  
**KITS DE ACCESORIOS Y COMPONENTES**  
**ENSEMBLES D'ACCESSOIRES DE MONTURES ET DE PIÈCES DÉTACHÉES**

|               |            |   |  |  |
|---------------|------------|---|--|--|
| <b>140885</b> | 401267     | 1 | Retainer (washer) / Seguro (arandela) / Arrêt (rondelle) | 5/8" I.D. x 1-1/4" O.D. x .075" thick                  |
|               | 402662     | 1 | Spacer / Espaciador / Entretoise                         | 5/8" I.D. x 1-1/4" O.D. x 1/4" thick                   |
|               | 403189     | 2 | Spacer / Espaciador / Entretoise                         | 1/2" I.D. x 1-1/4" O.D.                                |
|               | 411012     | 2 | Sleeve / Camisa / Manchon                                | 13 mm I.D. x 5/8 in. O.D. x 1-5/16 in. long            |
|               | 412016     | 1 | Extn nut / Tuerca ext. / Écrou ext.                      | 7/16" x 20 UNF Thread                                  |
|               | 427031     | 1 | Instruction sheet / Hoja de instr. / Feuillet d'instr.   |  |
| <b>140921</b> | 401006     | 1 | Hex nut / Tuerca hexagonal / Écrou hexagonal             | 3/8" x 24 UNF thread                                   |
|               | 401007     | 1 | Pal nut / Tuerca de cierre / Écrou Pal                   | 3/8" x 24 UNF thread                                   |
|               | 401011     | 2 | Bushing / Buje / Bague                                   | EB2 style - for 1-3/4" O.D. eye ring - 3/4" diam. Stud |
|               | 401377     | 1 | Retainer (washer) / Seguro (arandela) / Arrêt (rondelle) | 1/2" I.D. x 1-3/8" O.D. x .075" thick                  |
|               | 401383     | 1 | Retainer (washer) / Seguro (arandela) / Arrêt (rondelle) | 3/8 in. I.D. x 1-1/2 in. O.D. x .093 in. thick         |
|               | 402267     | 2 | Bushing / Buje / Bague                                   | 9/16" centering lip for 7/16" O.D. stud                |
| <b>140947</b> | 401193     | 1 | Lock washer / Arandela de seguridad / Rondelle-frein     | 5/8" I.D. (thin)                                       |
|               | 404451     | 2 | Hex nut / Tuerca hexagonal / Écrou hexagonal             | 16 x 1.5 metric thread                                 |
|               | 404452     | 4 | Retainer (washer) / Seguro (arandela) / Arrêt (rondelle) | 5/8" I.D. x 2-3/4" O.D. x .180" thick                  |
|               | 404453     | 2 | Sleeve / Camisa / Manchon                                | 16 mm I.D. x 1-3/16" O.D. x 1-1/2" long                |
|               | 404454     | 4 | Bushing / Buje / Bague                                   | 1-3/16" centering lip for 13/16" O.D. stud             |
| <b>141041</b> | 401006     | 1 | Hex nut / Tuerca hexagonal / Écrou hexagonal             | 3/8" x 24 UNF thread                                   |
|               | 401376     | 2 | Retainer (washer) / Seguro (arandela) / Arrêt (rondelle) | 3/8 in. I.D. x 1-3/8 in. O.D. x .089 in. thick         |
|               | 404652     | 2 | Bushing / Buje / Bague                                   | Used with 5/8" dia. hole or 7/8" dia. Hole             |
| <b>141045</b> | 401006     | 1 | Hex nut / Tuerca hexagonal / Écrou hexagonal             | 3/8" x 24 UNF thread                                   |
|               | 401377     | 1 | Retainer (washer) / Seguro (arandela) / Arrêt (rondelle) | 1/2" I.D. x 1-3/8" O.D. x .075" thick                  |
|               | 401383     | 1 | Retainer (washer) / Seguro (arandela) / Arrêt (rondelle) | 3/8 in. I.D. x 1-1/2 in. O.D. x .093 in. thick         |
|               | 402284     | 2 | Bushing / Buje / Bague                                   | 5/8" centering lip for 3/8" O.D. stud                  |
| <b>141047</b> | 401006     | 1 | Hex nut / Tuerca hexagonal / Écrou hexagonal             | 3/8" x 24 UNF thread                                   |
|               | 401164     | 1 | Hex nut / Tuerca hexagonal / Écrou hexagonal             | 1/2" x 20 UNF Thread                                   |
|               | 401166     | 1 | Lock washer / Arandela de seguridad / Rondelle-frein     | 1/2" lock washer                                       |
|               | 401184     | 1 | Lock washer / Arandela de seguridad / Rondelle-frein     | 7/16" Lock washer                                      |
|               | 402844     | 1 | Hex nut / Tuerca hexagonal / Écrou hexagonal             | 7/16" x 20 UNF Thread                                  |
|               | 402943     | 1 | Retainer (washer) / Seguro (arandela) / Arrêt (rondelle) | 0.457" I.D. x 1.68" O.D. x .120" thick                 |
|               | 403298     | 1 | Retainer (washer) / Seguro (arandela) / Arrêt (rondelle) | 0.390" I.D. x 1.68" O.D. x .120" thick                 |
|               | 403299     | 2 | Bushing / Buje / Bague                                   | 7/8" centering lip for 7/16" O.D. stud                 |
|               | 403877     | 1 | Stud / Perno / Goujon                                    | 1/2" x 20 and 7/16" x 20                               |
|               | 403878     | 1 | Washer / Arandela / Rondelle                             | 0.453" I.D. x 1.25" O.D. x .075" thick                 |
| <b>141083</b> | 401193     | 1 | Lock washer / Arandela de seguridad / Rondelle-frein     | 5/8" I.D. (thin)                                       |
|               | 404451     | 1 | Hex nut / Tuerca hexagonal / Écrou hexagonal             | 16 x 1.5 metric thread                                 |
|               | 404452     | 2 | Retainer (washer) / Seguro (arandela) / Arrêt (rondelle) | 5/8" I.D. x 2-3/4" O.D. x .180" thick                  |
|               | 404453     | 1 | Sleeve / Camisa / Manchon                                | 16 mm I.D. x 1-3/16" O.D. x 1-1/2" long                |
|               | 404454     | 2 | Bushing / Buje / Bague                                   | 1-3/16" centering lip for 13/16" O.D. stud             |
| <b>141108</b> | 401174     | 2 | Hex nut / Tuerca hexagonal / Écrou hexagonal             | 5/8" x 18 thread                                       |
|               | 405360     | 4 | Retainer (washer) / Seguro (arandela) / Arrêt (rondelle) | 5/8" I.D. x 2-3/16" O.D. x .120" thick                 |
|               | 405361-000 | 4 | Bushing / Buje / Bague                                   | 1" centering lip for 5/8" O.D. stud (1.00" thick)      |
| <b>141137</b> | 402812     | 1 | Sleeve / Camisa / Manchon                                | 13 mm I.D. x 5/8 in. O.D. x 1-5/16 in. long            |
| <b>141138</b> | 401006     | 2 | Hex nut / Tuerca hexagonal / Écrou hexagonal             | 3/8" x 24 UNF thread                                   |
|               | 403489     | 4 | Bushing / Buje / Bague                                   | 5/8" centering lip for 3/8" O.D. stud                  |
|               | 403575     | 4 | Retainer (washer) / Seguro (arandela) / Arrêt (rondelle) | 25/64" I.D. x 1-1/4" O.D. x .12" thick                 |
|               | 404949     | 4 | Washer / Arandela / Rondelle                             | 1/2" I.D. x 1-1/2" O.D. x .04" thick                   |

**MOUNTING ACCESSORY PACKAGES AND COMPONENT PARTS**  
**KITS DE ACCESORIOS Y COMPONENTES**  
**ENSEMBLES D'ACCESSOIRES DE MONTURES ET DE PIÈCES DÉTACHÉES**

|               |            |   |  |  |
|---------------|------------|---|--|--|
| <b>141168</b> | 401006     | 1 | Hex nut / Tuerca hexagonal / Écrou hexagonal             | 3/8" x 24 UNF thread                                   |
|               | 401008     | 1 | Retainer (washer) / Seguro (arandela) / Arrêt (rondelle) | 3/8 in. I.D. x 1-1/4 in. O.D. x .075 in. thick         |
|               | 404350     | 1 | Retainer (washer) / Seguro (arandela) / Arrêt (rondelle) | 3/8 in. I.D. x 1-5/8 in. O.D. x .119 in. thick         |
|               | 404985     | 1 | Bushing / Buje / Bague                                   | 5/8" centering lip for 3/8" O.D. stud                  |
|               | 404986     | 1 | Bushing / Buje / Bague                                   | 5/8" centering lip for 3/8" O.D. stud                  |
|               | 429680-015 | 1 | Instruction sheet / Hoja de instr. / Feuillet d'instr.   |  |
| <b>141247</b> | 401174     | 1 | Hex nut / Tuerca hexagonal / Écrou hexagonal             | 5/8" x 18 thread                                       |
|               | 401754     | 2 | Bushing / Buje / Bague                                   | EB3 - style for 2.39 in. O.D. eye ring - 1" diam. Stud |
|               | 405360     | 2 | Retainer (washer) / Seguro (arandela) / Arrêt (rondelle) | 5/8" I.D. x 2-3/16" O.D. x .120" thick                 |
|               | 405361     | 2 | Bushing / Buje / Bague                                   | 1" centering lip for 5/8" O.D. stud                    |
| <b>141349</b> | 401006     | 1 | Hex nut / Tuerca hexagonal / Écrou hexagonal             | 3/8" x 24 UNF thread                                   |
|               | 401007     | 1 | Pal nut / Tuerca de cierre / Écrou Pal                   | 3/8" x 24 UNF thread                                   |
|               | 401376     | 2 | Retainer (washer) / Seguro (arandela) / Arrêt (rondelle) | 3/8 in. I.D. x 1-3/8 in. O.D. x .089 in. thick         |
|               | 404652     | 2 | Bushing / Buje / Bague                                   | Used with 5/8" dia. hole or 7/8" dia. Hole             |
|               | 429680-030 | 1 | Instruction sheet / Hoja de instr. / Feuillet d'instr.   |  |
| <b>141350</b> | 401006     | 1 | Hex nut / Tuerca hexagonal / Écrou hexagonal             | 3/8" x 24 UNF thread                                   |
|               | 401376     | 2 | Retainer (washer) / Seguro (arandela) / Arrêt (rondelle) | 3/8 in. I.D. x 1-3/8 in. O.D. x .089 in. thick         |
|               | 402294     | 2 | Bushing / Buje / Bague                                   | 5/8" lip for 3/8" dia. stud-5/8" or 7/8" holes         |
|               | 411520     | 1 | Jam nut / Contratuerca / Contre-Écrou                    | 3/8" x 24 UNF thread                                   |
| <b>141353</b> | 401006     | 1 | Hex nut / Tuerca hexagonal / Écrou hexagonal             | 3/8" x 24 UNF thread                                   |
|               | 401007     | 1 | Jam nut / Contratuerca / Contre-Écrou                    | 3/8" x 24 UNF thread                                   |
|               | 401383     | 2 | Retainer (washer) / Seguro (arandela) / Arrêt (rondelle) | 3/8 in. I.D. x 1-1/2 in. O.D. x .093 in. thick         |
|               | 402263     | 2 | Bushing / Buje / Bague                                   | 7/8" centering lip for 3/8" O.D. stud                  |
| <b>141354</b> | 401006     | 1 | Hex nut / Tuerca hexagonal / Écrou hexagonal             | 3/8" x 24 UNF thread                                   |
|               | 401007     | 1 | Pal nut / Tuerca de cierre / Écrou Pal                   | 3/8" x 24 UNF thread                                   |
|               | 404350     | 1 | Retainer (washer) / Seguro (arandela) / Arrêt (rondelle) | 3/8 in. I.D. x 1-5/8 in. O.D. x .119 in. thick         |
|               | 404485     | 1 | Retainer (washer) / Seguro (arandela) / Arrêt (rondelle) | 0.453" I.D. x 1.63" O.D. x 0.120" thick                |
|               | 404959     | 2 | Bushing / Buje / Bague                                   | 3/4" centering lip for 7/16" O.D. stud                 |
| <b>141356</b> | 401006     | 1 | Hex nut / Tuerca hexagonal / Écrou hexagonal             | 3/8" x 24 UNF thread                                   |
|               | 401007     | 1 | Pal nut / Tuerca de cierre / Écrou Pal                   | 3/8" x 24 UNF thread                                   |
|               | 401008     | 2 | Retainer (washer) / Seguro (arandela) / Arrêt (rondelle) | 3/8 in. I.D. x 1-1/4 in. O.D. x .075 in. thick         |
|               | 403962     | 2 | Bushing / Buje / Bague                                   | 1/2" centering lip for 3/8" O.D. stud                  |
| <b>141368</b> | 401006     | 1 | Hex nut / Tuerca hexagonal / Écrou hexagonal             | 3/8" x 24 UNF thread                                   |
|               | 401007     | 1 | Jam nut / Contratuerca / Contre-Écrou                    | 3/8" x 24 UNF thread                                   |
|               | 401008     | 1 | Retainer (washer) / Seguro (arandela) / Arrêt (rondelle) | 3/8 in. I.D. x 1-1/4 in. O.D. x .075 in. thick         |
|               | 401383     | 1 | Retainer (washer) / Seguro (arandela) / Arrêt (rondelle) | 3/8 in. I.D. x 1-1/2 in. O.D. x .093 in. thick         |
|               | 403489     | 2 | Bushing / Buje / Bague                                   | 5/8" centering lip for 3/8" O.D. stud                  |
|               | 429680-030 | 1 | Instruction sheet / Hoja de instr. / Feuillet d'instr.   |  |
| <b>141376</b> | 401006     | 1 | Hex nut / Tuerca hexagonal / Écrou hexagonal             | 3/8 in.-24 thread                                      |
|               | 401007     | 1 | Pal nut / Tuerca de cierre / Écrou Pal                   | 3/8" x 24 UNF thread                                   |
|               | 401008     | 2 | Retainer (washer) / Seguro (arandela) / Arrêt (rondelle) | 3/8 in. I.D. x 1-1/4 in. O.D. x .075 in. thick         |
|               | 403489     | 2 | Bushing / Buje / Bague                                   | 5/8" centering lip for 3/8" O.D. stud                  |
| <b>141439</b> | 401011     | 2 | Bushing / Buje / Bague                                   | EB2 style - for 1-3/4" O.D. eye ring - 3/4" diam. Stud |
|               | 411165     | 1 | Lock nut / Contratuerca / Contre-Écrou                   | 12 x 1.25 metric thread                                |
|               | 411445     | 2 | Bushing / Buje / Bague                                   | Flat Bushing for 9/16" O.D. stud                       |
|               | 411446     | 2 | Retainer (washer) / Seguro (arandela) / Arrêt (rondelle) | 3/4" I.D. x 1 7/8" O.D. x .047" thick                  |
|               | 411447     | 1 | Retainer (washer) / Seguro (arandela) / Arrêt (rondelle) | 9/16" I.D. x 1-3/4" O.D. x .087" thick                 |
|               | 412554     | 1 | Retainer (washer) / Seguro (arandela) / Arrêt (rondelle) | 0.485" O.D. x 1.76" O.D. x .089" thick                 |

**MOUNTING ACCESSORY PACKAGES AND COMPONENT PARTS**  
**KITS DE ACCESORIOS Y COMPONENTES**  
**ENSEMBLES D'ACCESSOIRES DE MONTURES ET DE PIÈCES DÉTACHÉES**

|               |        |   |  |  |
|---------------|--------|---|--|--|
| <b>141448</b> | 404715 | 1 | Spacer / Espaciador / Entretoise                         | 0.737" I.D x 1.75" O.D. x .120 thick           |
|               | 411165 | 1 | Lock nut / Contratuerca / Contre-Écrou                   | 12 x 1.25 metric thread                        |
|               | 411445 | 2 | Bushing / Buje / Bague                                   | Flat Bushing for 9/16" O.D. stud               |
|               | 411446 | 1 | Retainer (washer) / Seguro (arandela) / Arrêt (rondelle) | 3/4" I.D. x 1 7/8" O.D. x .047" thick          |
|               | 411447 | 1 | Washer / Arandela / Rondelle                             | 9/16" I.D. x 1-3/4" O.D. x .087" thick         |
|               | 412554 | 1 | Retainer (washer) / Seguro (arandela) / Arrêt (rondelle) | 0.485" O.D x 1.76" O.D. x .089" thick          |
| <b>141514</b> | 401006 | 1 | Hex nut / Tuerca hexagonal / Écrou hexagonal             | 3/8" x 24 UNF thread                           |
|               | 401007 | 1 | Pal nut / Tuerca de cierre / Écrou Pal                   | 3/8" x 24 UNF thread                           |
|               | 401383 | 2 | Retainer (washer) / Seguro (arandela) / Arrêt (rondelle) | 3/8 in. I.D. x 1-1/2 in. O.D. x .093 in. thick |
|               | 404947 | 2 | Bushing / Buje / Bague                                   | 3/8 in. I.D. x 1-3/16 in. x 9/16 in. thick     |
| <b>141537</b> | 401006 | 1 | Hex nut / Tuerca hexagonal / Écrou hexagonal             | 3/8" x 24 UNF thread                           |
|               | 404350 | 2 | Retainer (washer) / Seguro (arandela) / Arrêt (rondelle) | 3/8 in. I.D. x 1-5/8 in. O.D. x .119 in. thick |
|               | 404985 | 2 | Bushing / Buje / Bague                                   | 5/8" centering lip for 3/8" O.D. stud          |
| <b>141665</b> | 401006 | 1 | Hex nut / Tuerca hexagonal / Écrou hexagonal             | 3/8" x 24 UNF thread                           |
|               | 402943 | 1 | Retainer (washer) / Seguro (arandela) / Arrêt (rondelle) | 0.457" I.D. x 1.68" O.D. x .120" thick         |
|               | 403298 | 1 | Retainer (washer) / Seguro (arandela) / Arrêt (rondelle) | 0.390" I.D. x 1.68" O.D. x .120" thick         |
|               | 404959 | 2 | Bushing / Buje / Bague                                   | 3/4" centering lip for 7/16" O.D. stud         |
|               | 411520 | 1 | Jam nut / Contratuerca / Contre-Écrou                    | 3/8" x 24 UNF thread                           |
| <b>142036</b> | 411497 | 1 | Lock nut / Contratuerca / Contre-Écrou                   | 10 x 1.25 metric thread                        |
| <b>142069</b> | 411165 | 2 | Lock nut / Contratuerca / Contre-Écrou                   | 12 x 1.25 metric thread                        |
|               | 411447 | 2 | Washer / Arandela / Rondelle                             | 9/16" I.D. x 1-3/4" O.D. x .087" thick         |
|               | 412103 | 2 | Retainer (washer) / Seguro (arandela) / Arrêt (rondelle) | 9/16" I.D. x 1-3/4" O.D. x 1/4" thick          |
|               | 412116 | 4 | Bushing / Buje / Bague                                   | Flat bushing for 9/16" O.D. Stud               |
|               | 412554 | 2 | Retainer (washer) / Seguro (arandela) / Arrêt (rondelle) | 0.485" O.D x 1.76" O.D. x .089" thick          |
| <b>142095</b> | 411165 | 1 | Lock nut / Contratuerca / Contre-Écrou                   | 12 x 1.25 metric thread                        |
|               | 411447 | 2 | Retainer (washer) / Seguro (arandela) / Arrêt (rondelle) | 9/16" I.D. x 1-3/4" O.D. x .087" thick         |
|               | 412103 | 1 | Retainer (washer) / Seguro (arandela) / Arrêt (rondelle) | 9/16" I.D. x 1-3/4" O.D. x 1/4" thick          |
|               | 412116 | 2 | Bushing / Buje / Bague                                   | Flat bushing for 9/16" O.D. Stud               |
| <b>142280</b> | 411633 | 2 | Bushing / Buje / Bague                                   | 0.810" centering lip for 7/16" O.D. stud       |
|               | 411672 | 1 | Retainer (washer) / Seguro (arandela) / Arrêt (rondelle) | 0.410" I.D. x 2.05" O.D. x 0.175" thick        |
|               | 412046 | 1 | Lock nut / Contratuerca / Contre-Écrou                   | 10 x 1.5 metric thread                         |
|               | 412479 | 1 | Retainer (washer) / Seguro (arandela) / Arrêt (rondelle) | 0.490" I.D. x 2.15" O.D. x 0.180" thick        |
| <b>142389</b> | 404287 | 2 | Retainer (washer) / Seguro (arandela) / Arrêt (rondelle) | 0.453" I.D x 1.50" O.D x 0.090" thick          |
|               | 404947 | 2 | Bushing / Buje / Bague                                   | For 3/8" O.D. stud- no centering lip           |
|               | 411497 | 1 | Lock nut / Contratuerca / Contre-Écrou                   | 10 x 1.25 metric thread                        |
| <b>142592</b> | 402539 | 2 | Bolt / Tornillo / Boulon                                 | 5/16" x 24 UNF thread x 1" long                |
|               | 402573 | 2 | Nut / Tuerca / Écrou                                     | 5/16" x 24 UNF thread                          |
|               | 402653 | 2 | Lock washer / Arandela de seguridad / Rondelle-frein     | 5/16" Lock washer                              |
|               | 411385 | 2 | Retainer (washer) / Seguro (arandela) / Arrêt (rondelle) | 0.355" I.D x 0.74" O.D. x 0.075" thick         |
| <b>142615</b> | 401006 | 1 | Hex nut / Tuerca hexagonal / Écrou hexagonal             | 3/8" x 24 UNF thread                           |
|               | 401376 | 1 | Retainer (washer) / Seguro (arandela) / Arrêt (rondelle) | 3/8 in. I.D. x 1-3/8 in. O.D. x .089 in. thick |
|               | 402943 | 1 | Retainer (washer) / Seguro (arandela) / Arrêt (rondelle) | 0.457" I.D. x 1.68" O.D. x .120" thick         |
|               | 404652 | 2 | Bushing / Buje / Bague                                   | Used with 5/8" dia. hole or 7/8" dia. Hole     |
| <b>142617</b> | 401006 | 1 | Hex nut / Tuerca hexagonal / Écrou hexagonal             | 3/8" x 24 UNF thread                           |
|               | 402943 | 1 | Retainer (washer) / Seguro (arandela) / Arrêt (rondelle) | 0.457" I.D. x 1.68" O.D. x .120" thick         |
|               | 403298 | 1 | Retainer (washer) / Seguro (arandela) / Arrêt (rondelle) | 0.390" I.D. x 1.68" O.D. x .120" thick         |
|               | 412661 | 2 | Bushing / Buje / Bague                                   | 0.790" centering lip for 7/16" O.D. stud       |

**MOUNTING ACCESSORY PACKAGES AND COMPONENT PARTS**  
**KITS DE ACCESORIOS Y COMPONENTES**  
**ENSEMBLES D'ACCESSOIRES DE MONTURES ET DE PIÈCES DÉTACHÉES**

|               |            |   |  |   |
|---------------|------------|---|--|---|
| <b>142656</b> | 411165     | 1 | Lock nut / Contratuerca / Contre-Écrou                       | 12 x 1.25 metric thread                           |
|               | 411446     | 1 | Retainer (washer) / Seguro (arandela) / Arrêt (rondelle)     | 3/4" I.D. x 1 7/8" O.D. x .047" thick             |
|               | 411447     | 1 | Retainer (washer) / Seguro (arandela) / Arrêt (rondelle)     | 9/16" I.D. x 1-3/4" O.D. x .087" thick            |
|               | 412103     | 1 | Retainer (washer) / Seguro (arandela) / Arrêt (rondelle)     | 9/16" I.D. x 1-3/4" O.D. x 1/4" thick             |
|               | 412116     | 2 | Bushing / Buje / Bague                                       | Flat bushing for 9/16" O.D. Stud                  |
|               | 412554     | 1 | Retainer (washer) / Seguro (arandela) / Arrêt (rondelle)     | 0.485" O.D x 1.76" O.D. x .089" thick             |
| <b>142657</b> | 411165     | 2 | Lock nut / Contratuerca / Contre-Écrou                       | 12 x 1.25 metric thread                           |
|               | 411446     | 2 | Retainer (washer) / Seguro (arandela) / Arrêt (rondelle)     | 3/4" I.D. x 1 7/8" O.D. x .047" thick             |
|               | 411447     | 2 | Retainer (washer) / Seguro (arandela) / Arrêt (rondelle)     | 9/16" I.D. x 1-3/4" O.D. x .087" thick            |
|               | 412103     | 2 | Retainer (washer) / Seguro (arandela) / Arrêt (rondelle)     | 9/16" I.D. x 1-3/4" O.D. x 1/4" thick             |
|               | 412116     | 4 | Bushing / Buje / Bague                                       | Flat bushing for 9/16" O.D. Stud                  |
|               | 412554     | 2 | Retainer (washer) / Seguro (arandela) / Arrêt (rondelle)     | 0.485" O.D x 1.76" O.D. x .089" thick             |
| <b>142700</b> | 401006     | 1 | Hex nut / Tuerca hexagonal / Écrou hexagonal                 | 3/8" x 24 UNF thread                              |
|               | 402943     | 1 | Retainer (washer) / Seguro (arandela) / Arrêt (rondelle)     | 0.457" I.D. x 1.68" O.D. x .120" thick            |
|               | 403298     | 1 | Retainer (washer) / Seguro (arandela) / Arrêt (rondelle)     | 0.390" I.D. x 1.68" O.D. x .120" thick            |
|               | 404959     | 2 | Bushing / Buje / Bague                                       | 3/4" centering lip for 7/16" O.D. stud            |
|               | 411520     | 1 | Jam nut / Contratuerca / Contre-Écrou                        | 3/8" x 24 UNF thread                              |
|               | 412682     | 1 | Sleeve / Camisa / Manchon                                    | 0.479" I.D. x 0.548" O.D. x 1.48" long            |
|               | 429680-008 | 1 | Instruction sheet / Hoja de instr. / Feuillet d'instr.       |   |
| <b>142731</b> | 411165     | 1 | Lock nut / Contratuerca / Contre-Écrou                       | 12 x 1.25 metric thread                           |
|               | 411447     | 1 | Retainer (washer) / Seguro (arandela) / Arrêt (rondelle)     | 9/16" I.D. x 1-3/4" O.D. x .087" thick            |
|               | 412554     | 1 | Retainer (washer) / Seguro (arandela) / Arrêt (rondelle)     | 0.485" O.D x 1.76" O.D. x .089" thick             |
|               | 412675     | 2 | Bushing / Buje / Bague                                       | 0.950" centering lip for 9/16" O.D. stud          |
| <b>142973</b> | 411633     | 2 | Bushing / Buje / Bague                                       | 0.810" centering lip for 7/16" O.D. stud          |
|               | 411672     | 1 | Retainer (washer) / Seguro (arandela) / Arrêt (rondelle)     | 0.410" I.D. x 2.05" O.D. x 0.175" thick           |
|               | 412046     | 1 | Lock nut / Contratuerca / Contre-Écrou                       | 10 x 1.5 metric thread                            |
|               | 412479     | 1 | Retainer (washer) / Seguro (arandela) / Arrêt (rondelle)     | 0.490" I.D. x 2.15" O.D. x 0.180" thick           |
| <b>142976</b> | 401174     | 1 | Hex nut / Tuerca hexagonal / Écrou hexagonal                 | 5/8" x 18 thread                                  |
|               | 405360     | 2 | Retainer (washer) / Seguro (arandela) / Arrêt (rondelle)     | 5/8" I.D. x 2-3/16" O.D. x .120" thick            |
|               | 405361-000 | 2 | Bushing / Buje / Bague                                       | 1" centering lip for 5/8" O.D. stud (1.00" thick) |
|               | 429680-031 | 1 | Instruction sheet / Hoja de instr. / Feuillet d'instr.       |   |
| <b>142998</b> | 404452     | 2 | Retainer (washer) / Seguro (arandela) / Arrêt (rondelle)     | 5/8" I.D. x 2-3/4" O.D. x .180" thick             |
|               | 404454     | 2 | Bushing / Buje / Bague                                       | 1-3/16" centering lip for 13/16" O.D. stud        |
|               | 405862     | 1 | Self locking nut / Tuerca de seguridad / Écrou indesserrable | 5/8" x 18 thread                                  |
|               | 412872     | 1 | Sleeve / Camisa / Manchon                                    | 0.643" I.D. x .815" O.D. x 1.44" long             |
| <b>143000</b> | 404695     | 1 | Retainer (washer) / Seguro (arandela) / Arrêt (rondelle)     | 0.709" centering lip x 1.97" O.D. x .060" thick   |
|               | 404715     | 1 | Spacer / Espaciador / Entretoise                             | 0.737" I.D x 1.75" O.D. x .120 thick              |
|               | 411165     | 1 | Lock nut / Contratuerca / Contre-Écrou                       | 12 x 1.25 metric thread                           |
|               | 411447     | 1 | Retainer (washer) / Seguro (arandela) / Arrêt (rondelle)     | 9/16" I.D. x 1-3/4" O.D. x .087" thick            |
|               | 412116     | 2 | Bushing / Buje / Bague                                       | Flat bushing for 9/16" O.D. Stud                  |
|               | 412554     | 1 | Retainer (washer) / Seguro (arandela) / Arrêt (rondelle)     | 0.485" O.D x 1.76" O.D. x .089" thick             |
|               | 429680-033 | 1 | Instruction sheet / Hoja de instr. / Feuillet d'instr.       |   |
|               |            |   |  |   |
| <b>143078</b> | 401006     | 1 | Hex nut / Tuerca hexagonal / Écrou hexagonal                 | 3/8" x 24 UNF thread                              |
|               | 404969     | 1 | Sleeve / Camisa / Manchon                                    | 0.400" I.D. x .620" O.D. x 1.48" long             |
|               | 412554     | 2 | Retainer (washer) / Seguro (arandela) / Arrêt (rondelle)     | 0.485" O.D x 1.76" O.D. x .089" thick             |
|               | 412675     | 2 | Bushing / Buje / Bague                                       | 0.950" centering lip for 9/16" O.D. stud          |
| <b>143146</b> | 411165     | 1 | Lock nut / Contratuerca / Contre-Écrou                       | 12 x 1.25 metric thread                           |
|               | 411447     | 2 | Retainer (washer) / Seguro (arandela) / Arrêt (rondelle)     | 9/16" I.D. x 1-3/4" O.D. x .087" thick            |
|               | 412675     | 2 | Bushing / Buje / Bague                                       | 0.950" centering lip for 9/16" O.D. stud          |

**MOUNTING ACCESSORY PACKAGES AND COMPONENT PARTS**  
**KITS DE ACCESORIOS Y COMPONENTES**  
**ENSEMBLES D'ACCESSOIRES DE MONTURES ET DE PIÈCES DÉTACHÉES**

|                   |            |   |  |   |
|-------------------|------------|---|--|---|
| <b>145054</b>     | 401174     | 1 | Hex nut / Tuerca hexagonal / Écrou hexagonal                 | 5/8 in. -18 thread  |
|                   | 401175     | 1 | Lock washer / Arandela de seguridad / Rondelle-frein         |   |
|                   | 405360     | 2 | Retainer (washer) / Seguro (arandela) / Arrêt (rondelle)     | 5/8" I.D. x 2-3/16" O.D. x .120" thick                          |
|                   | 405361-000 | 2 | Bushing / Buje / Bague                                       | 1" centering lip for 5/8" O.D. stud (1.00" thick)               |
| <b>145075</b>     | 401750     | 1 | Retainer (washer) / Seguro (arandela) / Arrêt (rondelle)     | 3/4" I.D. x 2-3/8" O.D. x .105" thick                           |
|                   | 401752     | 1 | Retainer (washer) / Seguro (arandela) / Arrêt (rondelle)     | 1" I.D. x 2-3/8" O.D. x .105" thick                             |
|                   | 401754     | 2 | Bushing / Buje / Bague                                       | EB3 - style for 2.39 in. O.D. eye ring - 1" diam. Stud          |
|                   | 405360     | 2 | Retainer (washer) / Seguro (arandela) / Arrêt (rondelle)     | 5/8" I.D. x 2-3/16" O.D. x .120" thick                          |
|                   | 405361-000 | 2 | Bushing / Buje / Bague                                       | 1" centering lip for 5/8" O.D. stud (1.00" thick)               |
| <b>145080</b>     | 401011     | 2 | Bushing / Buje / Bague                                       | EB2 style - for 1-3/4" O.D. eye ring - 3/4" diam. Stud          |
|                   | 401429     | 1 | Retainer (washer) / Seguro (arandela) / Arrêt (rondelle)     | 1/2" I.D. x 1-5/8" O.D. x .090" thick                           |
|                   | 401430     | 1 | Retainer (washer) / Seguro (arandela) / Arrêt (rondelle)     | 3/4" I.D. x 1-5/8" O.D. x .090" thick                           |
| <b>145089-000</b> | 405360     | 2 | Retainer (washer) / Seguro (arandela) / Arrêt (rondelle)     | 5/8" I.D. x 2-3/16" O.D. x .120" thick                          |
|                   | 405361-000 | 2 | Bushing / Buje / Bague                                       | 1" centering lip for 5/8" O.D. stud (1.00" thick)               |
|                   | 405862     | 1 | Self locking nut / Tuerca de seguridad / Écrou indesserrable | 5/8" x 18 thread  |
| <b>145089-200</b> | 405360     | 2 | Retainer (washer) / Seguro (arandela) / Arrêt (rondelle)     | 5/8" I.D. x 2-3/16" O.D. x .120" thick                          |
|                   | 405361-100 | 2 | Bushing / Buje / Bague                                       | 1" centering lip for 5/8" O.D. stud (0.75" thick)               |
|                   | 415196-001 | 1 | Nylon lock nut / Contratuerca / Contre-Écrou                 | 5/8" x 18 thread  |
| <b>145090</b>     | 405643     | 1 | Sleeve / Camisa / Manchon                                    | 0.645" I.D. x 0.810" O.D. x 2.00" long                          |
|                   | 405859     | 2 | Bushing / Buje / Bague                                       | 0.815" I.D. x 2.35" O.D. x 1.05" thick with 1.15" centering lip |
|                   | 405860     | 2 | Retainer (washer) / Seguro (arandela) / Arrêt (rondelle)     | 0.650" I.D. x 2.75" O.D. x .180" thick                          |
|                   | 405862     | 1 | Self locking nut / Tuerca de seguridad / Écrou indesserrable | 5/8" x 18 thread  |
|                   | 424276     | 1 | Instruction sheet / Hoja de instr. / Feuillet d'instr.       |   |
| <b>145093</b>     | 401750     | 2 | Retainer (washer) / Seguro (arandela) / Arrêt (rondelle)     | 3/4" I.D. x 2-3/8" O.D. x .105" thick                           |
|                   | 401752     | 2 | Retainer (washer) / Seguro (arandela) / Arrêt (rondelle)     | 1" I.D. x 2-3/8" O.D. x .105" thick                             |
|                   | 401754     | 4 | Bushing / Buje / Bague                                       | EB3 - style for 2.39 in. O.D. eye ring - 1" diam. Stud          |
| <b>145099</b>     | 401174     | 1 | Hex nut / Tuerca hexagonal / Écrou hexagonal                 | 5/8" x 18 thread  |
|                   | 401175     | 1 | Lock washer / Arandela de seguridad / Rondelle-frein         |   |
|                   | 401754     | 2 | Bushing / Buje / Bague                                       | EB3 - style for 2.39 in. O.D. eye ring - 1" diam. Stud          |
|                   | 405360     | 2 | Retainer (washer) / Seguro (arandela) / Arrêt (rondelle)     | 5/8" I.D. x 2-3/16" O.D. x .120" thick                          |
|                   | 405361-000 | 2 | Bushing / Buje / Bague                                       | 1" centering lip for 5/8" O.D. stud (1.00" thick)               |
|                   | 424274     | 1 | Instruction sheet / Hoja de instr. / Feuillet d'instr.       |   |
| <b>145112</b>     | 401164     | 1 | Hex nut / Tuerca hexagonal / Écrou hexagonal                 | 1/2" x 20 UNF Thread  |
|                   | 401165     | 1 | Lock washer / Arandela de seguridad / Rondelle-frein         | 1/2" lock washer  |
|                   | 405360     | 1 | Retainer (washer) / Seguro (arandela) / Arrêt (rondelle)     | 5/8" I.D. x 2-3/16" O.D. x .120" thick                          |
|                   | 405361-000 | 2 | Bushing / Buje / Bague                                       | 1" centering lip for 5/8" O.D. stud (1.00" thick)               |
|                   | 405934     | 1 | Retainer (washer) / Seguro (arandela) / Arrêt (rondelle)     | 0.530" I.D. x 2-3/16" O.D. x .120" thick                        |
| <b>145116</b>     | 401750     | 1 | Retainer (washer) / Seguro (arandela) / Arrêt (rondelle)     | 3/4" I.D. x 2-3/8" O.D. x .105" thick                           |
|                   | 401752     | 1 | Retainer (washer) / Seguro (arandela) / Arrêt (rondelle)     | 1" I.D. x 2-3/8" O.D. x .105" thick                             |
|                   | 415169     | 2 | Bushing / Buje / Bague (Durometer 80)                        | EB3 - style for 2.39 in. O.D. eye ring - 1" diam. Stud          |
| <b>145123</b>     | 405360     | 2 | Retainer (washer) / Seguro (arandela) / Arrêt (rondelle)     | 5/8" I.D. x 2-3/16" O.D. x .120" thick                          |
|                   | 405862     | 1 | Self locking nut / Tuerca de seguridad / Écrou indesserrable | 5/8" x 18 thread  |
|                   | 415017-001 | 2 | Bushing / Buje / Bague                                       | 1" centering lip for a 5/8" O.D. stud                           |
| <b>145126</b>     | 401750     | 2 | Retainer (washer) / Seguro (arandela) / Arrêt (rondelle)     | 3/4" I.D. x 2-3/8" O.D. x .105" thick                           |
|                   | 401754     | 2 | Bushing / Buje / Bague                                       | EB3 - style for 2.39 in. O.D. eye ring - 1" diam. Stud          |
|                   | 403752     | 1 | Sleeve / Camisa / Manchon                                    | 3/4" I.D. x 15/16" O.D. x 1-3/4" long                           |
|                   | 415277     | 1 | Spacer / Espaciador / Entretoise                             | 1-3/16" I.D. x 1-1/4" O.D. x .200" thick                        |
|                   | 424281     | 1 | Instruction sheet / Hoja de instr. / Feuillet d'instr.       |   |

**MOUNTING ACCESSORY PACKAGES AND COMPONENT PARTS**  
**KITS DE ACCESORIOS Y COMPONENTES**  
**ENSEMBLES D'ACCESSOIRES DE MONTURES ET DE PIÈCES DÉTACHÉES**

|                   |            |   |  |   |
|-------------------|------------|---|--|---|
| <b>145128</b>     | 405360     | 2 | Retainer (washer) / Seguro (arandela) / Arrêt (rondelle)     | 5/8" I.D. x 2-3/16" O.D. x .120" thick                                      |
|                   | 405361-000 | 2 | Bushing / Buje / Bague                                       | 1" centering lip for 5/8" O.D. stud (1.00" thick)                           |
|                   | 415196-001 | 1 | Nylon lock nut / Contratuerca / Contre-Écrou                 | 5/8" x 18 thread  |
| <b>145132</b>     | 415305-000 | 2 | Rubber spacer / Espaciador de goma / Entretoise de caout.    | 0.910" I.D. x 1.58" O.D. x 1.1" long  |
|                   | 415305-001 | 2 | Rubber spacer / Espaciador de goma / Entretoise de caout.    | 0.910" I.D. x 1.58" O.D. x 0.427" long                                      |
|                   | 424282     | 1 | Instruction sheet / Hoja de instr. / Feuillet d'instr.       |   |
| <b>145140</b>     | 405360     | 2 | Retainer (washer) / Seguro (arandela) / Arrêt (rondelle)     | 5/8" I.D. x 2-3/16" O.D. x .120" thick                                      |
|                   | 405862     | 1 | Self locking nut / Tuerca de seguridad / Écrou indesserrable | 5/8" x 18 thread  |
|                   | 415326-001 | 2 | Urethane bushing / Buje de uretano / Bague urÉthane          | 1" centering lip for 5/8" O.D. stud (replacing Bushing P/N 415017)          |
| <b>145143</b>     | 415305-001 | 2 | Rubber spacer / Espaciador de goma / Entretoise de caout.    | 0.910" I.D. x 1.58" O.D. x 0.427" long                                      |
|                   | 424284     | 1 | Instruction sheet / Hoja de instr. / Feuillet d'instr.       |   |
| <b>145144</b>     | 415305-000 | 2 | Rubber spacer / Espaciador de goma / Entretoise de caout.    | 0.910" I.D. x 1.58" O.D. x 1.1" long  |
|                   | 424284     | 1 | Instruction sheet / Hoja de instr. / Feuillet d'instr.       |   |
| <b>145147</b>     | 401429     | 1 | Retainer (washer) / Seguro (arandela) / Arrêt (rondelle)     | 1/2" I.D. x 1-5/8" O.D. x .090" thick                                       |
|                   | 401430     | 1 | Retainer (washer) / Seguro (arandela) / Arrêt (rondelle)     | 3/4" I.D. x 1-5/8" O.D. x .090" thick                                       |
| <b>145148</b>     | 401750     | 1 | Retainer (washer) / Seguro (arandela) / Arrêt (rondelle)     | 3/4" I.D. x 2-3/8" O.D. x .105" thick                                       |
|                   | 401752     | 1 | Retainer (washer) / Seguro (arandela) / Arrêt (rondelle)     | 1" I.D. x 2-3/8" O.D. x .105" thick   |
| <b>145149</b>     | 401265     | 1 | Retainer (washer) / Seguro (arandela) / Arrêt (rondelle)     | 1/2" I.D. x 1-1/4" O.D. x .075" thick                                       |
|                   | 401266     | 1 | Retainer (washer) / Seguro (arandela) / Arrêt (rondelle)     | 5/8" I.D. x 1-1/4" O.D. x .075" thick                                       |
| <b>145168</b>     | 405643-100 | 1 | Sleeve / Camisa / Manchon                                    | 0.645" I.D x 0.810" O.D. x 1.50" long                                       |
|                   | 405859-100 | 2 | Bushing / Buje / Bague                                       | 0.815" I.D. x 2.35" O.D x 0.800" thick with 1.15" centering lip             |
|                   | 405860     | 2 | Retainer (washer) / Seguro (arandela) / Arrêt (rondelle)     | 0.650" I.D. x 2.75" O.D. x .180" thick                                      |
|                   | 405862     | 1 | Self locking nut / Tuerca de seguridad / Écrou indesserrable | 5/8" x 18 thread  |
|                   | 424276     | 1 | Instruction sheet / Hoja de instr. / Feuillet d'instr.       |   |
| <b>145177</b>     | 401754     | 2 | Bushing / Buje / Bague                                       | EB3 - style for 2.39 in. O.D. eye ring - 1" diam. Stud                      |
|                   | 406422-000 | 2 | Retainer (washer) / Seguro (arandela) / Arrêt (rondelle)     | 22 mm I.D. x 60.2 mm O.D. x 2.7 mm thick                                    |
|                   | 415010-802 | 1 | Sleeve / Camisa / Manchon                                    | 22 mm I.D. x 1.00" O.D. x 1-3/4" long                                       |
|                   | 424296-000 | 1 | Instruction sheet / Hoja de instr. / Feuillet d'instr.       |   |
| <b>401011</b>     |            | 1 | Bushing / Buje / Bague                                       | EB2 style - for 1-3/4" O.D. eye ring - 3/4" diam. Stud - Replaced by TR0027 |
| <b>401754</b>     |            | 1 | Bushing / Buje / Bague                                       | EB3 - style for 2.39 in. O.D. eye ring - 1" diam. Stud                      |
| <b>404702</b>     |            | 1 | Bushing / Buje / Bague                                       | EB1 style - 1 pc Spool shaped bushing (5/8" I.D.)                           |
| <b>405360</b>     |            | 1 | Retainer (washer) / Seguro (arandela) / Arrêt (rondelle)     | 5/8" I.D. x 2-3/16" O.D. x .120" thick                                      |
| <b>405361-000</b> |            | 1 | Bushing / Buje / Bague                                       | 1" centering lip for 5/8" O.D. stud (1.00" thick)                           |
| <b>406422</b>     |            | 1 | Retainer (washer) / Seguro (arandela) / Arrêt (rondelle)     | 22 mm I.D. x 60.2 mm O.D. x 2.7 mm thick                                    |
| <b>415010-802</b> |            | 1 | Sleeve / Camisa / Manchon                                    | 22 mm I.D. x 1.00" O.D. x 1-3/4" long                                       |
| <b>415015-001</b> |            | 1 | Urethane bushing / Buje de uretano / Bague urÉthane          | EB3 - style for 2.39 in. O.D. eye ring - 1" diam. Stud                      |
| <b>415017</b>     |            | 1 | Urethane bushing / Buje de uretano / Bague urÉthane          | 1" centering lip for 5/8" O.D. stud   |
| <b>415025-001</b> |            | 1 | Urethane bushing / Buje de uretano / Bague urÉthane          | EB2 style for 1-3/4" O.D. eye ring - 3/4" diam. Stud                        |
| <b>415326-001</b> |            | 1 | Urethane bushing / Buje de uretano / Bague urÉthane          | 1" centering lip for 5/8" O.D. stud (replacing Bushing P/N 415017)          |
| <b>TR0027</b>     |            | 1 | Bushing / Buje / Bague                                       | EB2 style - for 1-3/4" O.D. eye ring - 3/4" diam. Stud - (Replaces 401011)  |

**MOUNTING ACCESSORY PACKAGES - BUYER'S GUIDE**  
**KITS DE ACCESORIOS – GUÍA DEL COMPRADOR**  
**ENSEMBLE D'ACCESSOIRES POUR LA FIXATION - GUIDE DE L'ACHETEUR**

| Kit #         | Gabriel #     |       |
|---------------|---------------|-------|
| <b>140126</b> | 34052         |       |
|               | 43099         |       |
|               | 58350         |       |
|               | 58359         |       |
|               | 58360         |       |
|               | 58387         |       |
|               | 61518         |       |
|               | 61523         |       |
|               | 61540         |       |
|               | 61647         |       |
|               | 61650         |       |
|               | 77359         |       |
|               | G63350        |       |
|               | G63359        |       |
|               | G63360        |       |
|               | G63387        |       |
|               | G63457        |       |
|               | 14016         |       |
|               | 83027         |       |
|               | G63350        |       |
|               | G63359        |       |
|               | G63360        |       |
|               | G63387        |       |
|               | G63457        |       |
|               | G63881        |       |
|               | <b>140149</b> | 61510 |
|               |               | 61699 |
| 61700         |               |       |
| 77494         |               |       |
| G63494        |               |       |
| 83200         |               |       |
| 83216         |               |       |
| 83219         |               |       |
| 83308         |               |       |
| 83309         |               |       |
| 83312         |               |       |
| 83314         |               |       |
| 85023         |               |       |
| 85024         |               |       |
| 85046         |               |       |
| 85047         |               |       |
| 89401         |               |       |
| 89402         |               |       |

| Kit #               | Gabriel # |
|---------------------|-----------|
| <b>140149 Cont.</b> | 89403     |
|                     | 89409     |
|                     | 89415     |
|                     | 89416     |
|                     | 89434     |
|                     | 89435     |
|                     | G63494    |
|                     | G63510    |
|                     | 61597     |
|                     | G63605    |
|                     | G63639    |
|                     | G63616    |
|                     | 85025     |
|                     | G63605    |
|                     | G63708    |
|                     | 85031     |
|                     | G63432    |
| <b>140357</b>       | 34036     |
|                     | 58349     |
|                     | 58438     |
|                     | 61524     |
|                     | 77349     |
| <b>140455</b>       | G63349    |
|                     | G63438    |
|                     | G63349    |
|                     | G63438    |
|                     | G63349    |
|                     | G63438    |
|                     | 34051     |
|                     | 58421     |
|                     | 61504     |
|                     | 61509     |
|                     | 69900     |
|                     | 77421     |
|                     | G63421    |
| G63862              |           |
| 83003               |           |
| 83005               |           |
| 83014               |           |
| 83015               |           |
| 83400               |           |
| G63421              |           |
| G63798              |           |
| G63860              |           |
| G63862              |           |

| Kit #               | Gabriel #     |       |
|---------------------|---------------|-------|
| <b>140455 Cont.</b> | G63950        |       |
| <b>140505</b>       | 69574         |       |
|                     | 69575         |       |
| <b>140523</b>       | 61502         |       |
| <b>140524</b>       | 61513         |       |
|                     | 61552         |       |
|                     | 61593         |       |
|                     | 61596         |       |
|                     | 77479         |       |
|                     | G63479        |       |
|                     | G63484        |       |
|                     | G63635        |       |
|                     | 83161         |       |
|                     | 83507         |       |
|                     | G63479        |       |
|                     | G63484        |       |
|                     | G63491        |       |
|                     | G63611        |       |
|                     | G63635        |       |
|                     | <b>140629</b> | 69604 |
|                     |               | 69724 |
| <b>140630</b>       | 6851SE        |       |
|                     | 43049         |       |
| <b>140630</b>       | 43060         |       |
|                     | <b>140673</b> | 61529 |
| 61606               |               |       |
| 77937               |               |       |
| <b>140702</b>       | G63900        |       |
|                     | G63937        |       |
|                     | G63900        |       |
|                     | G63937        |       |
|                     | 43111         |       |
|                     | 58355         |       |
|                     | 58394         |       |
|                     | 61525         |       |
|                     | 77355         |       |
|                     | G63355        |       |
| G63394              |               |       |
| G63625              |               |       |
| 83303               |               |       |
| 83304               |               |       |
| G63355              |               |       |
| G63394              |               |       |



**MOUNTING ACCESSORY PACKAGES - BUYER'S GUIDE**  
**KITS DE ACCESORIOS – GUÍA DEL COMPRADOR**  
**ENSEMBLE D'ACCESSOIRES POUR LA FIXATION - GUIDE DE L'ACHETEUR**

| Kit #               | Gabriel # |
|---------------------|-----------|
| <b>140702 Cont.</b> | G63625    |
|                     | 83007     |
| <b>140719</b>       | 43171     |
|                     | 43172     |
|                     | 61590     |
|                     | 61624     |
|                     | 77607     |
|                     | 77679     |
|                     | G63607    |
|                     | G63679    |
|                     | G63607    |
|                     | G63679    |
| <b>140724</b>       | 43085     |
| <b>140739</b>       | 43058     |
| <b>140780</b>       | 34057     |
|                     | 34058     |
|                     | 34076     |
|                     | 58386     |
|                     | 58414     |
|                     | 58416     |
|                     | 58500     |
|                     | 58609     |
|                     | 58624     |
|                     | 58929     |
|                     | 61520     |
|                     | 61521     |
|                     | 61553     |
|                     | 61561     |
|                     | 61569     |
|                     | 61591     |
|                     | 61595     |
|                     | 77375     |
|                     | 77414     |
|                     | 77608     |
|                     | 77614     |
|                     | 77772     |
|                     | G63386    |
|                     | G63396    |
|                     | G63414    |
|                     | G63416    |
|                     | G63445    |
|                     | G63447    |
|                     | G63500    |
|                     | G63603    |
|                     | G63608    |
|                     | G63614    |
|                     | G63621    |
|                     | G63624    |
|                     | G63929    |
|                     | 83162     |
|                     | 63432     |
|                     | 63448     |
| <b>140857</b>       | 61501     |
|                     | 61508     |
|                     | 77902     |
|                     | G63902    |
|                     | G63902    |
| <b>140873</b>       | 43138     |
|                     | 69703     |

| Kit #               | Gabriel # |
|---------------------|-----------|
| <b>140780 Cont.</b> | G63603    |
|                     | G63608    |
|                     | G63614    |
|                     | G63621    |
|                     | G63624    |
|                     | G63929    |
|                     | G63375    |
|                     | G63375    |
|                     | 83177     |
|                     | 63130     |
|                     | 63211     |
|                     | 63350     |
|                     | 83018     |
|                     | 83019     |
|                     | 83041     |
|                     | 83045     |
|                     | 83050     |
|                     | 83058     |
|                     | 83105     |
|                     | 83114     |
|                     | G63386    |
|                     | G63396    |
|                     | G63414    |
|                     | G63416    |
|                     | G63445    |
|                     | G63447    |
|                     | G63500    |
|                     | G63603    |
|                     | G63608    |
|                     | G63614    |
|                     | G63621    |
|                     | G63624    |
|                     | G63929    |
|                     | 83162     |
|                     | 63432     |
|                     | 63448     |
| <b>140857</b>       | 61501     |
|                     | 61508     |
|                     | 77902     |
|                     | G63902    |
|                     | G63902    |
| <b>140873</b>       | 43138     |
|                     | 69703     |

| Kit #         | Gabriel # |
|---------------|-----------|
| <b>140884</b> | 77405     |
|               | G63405    |
|               | G63405    |
| <b>140885</b> | G63299    |
|               | 63178     |
|               | 63299     |
|               | G63299    |
| <b>140896</b> | G55507    |
| <b>140921</b> | 61588     |
|               | 77726     |
|               | G63548    |
|               | G63726    |
|               | G63548    |
|               | G63726    |
| <b>140953</b> | G51760    |
|               | G51761    |
| <b>141041</b> | 34073     |
|               | 69675     |
|               | G63444    |
|               | G63889    |
|               | G64004    |
|               | G64005    |
|               | G64006    |
|               | G64007    |
|               | 83509     |
|               | G63444    |
|               | G63889    |
|               | G64004    |
|               | G64005    |
|               | G64006    |
|               | G64007    |
|               | 63451     |
|               | 63548     |
|               | 83513     |
|               | 83514     |
|               | 83515     |
| <b>141047</b> | 58410     |
|               | 61546     |
|               | 77410     |
|               | G63410    |
|               | G63446    |
|               | 63220     |
|               | 63320     |



**MOUNTING ACCESSORY PACKAGES - BUYER'S GUIDE**  
**KITS DE ACCESORIOS – GUÍA DEL COMPRADOR**  
**ENSEMBLE D'ACCESSOIRES POUR LA FIXATION - GUIDE DE L'ACHETEUR**

| Kit #               | Gabriel # |
|---------------------|-----------|
| <b>141047 Cont.</b> | G63410    |
|                     | G63446    |
| <b>141058</b>       | 43093     |
| <b>141083</b>       | 83301     |
|                     | 83317     |
|                     | 83318     |
|                     | 83613     |
| <b>141108</b>       | 85310     |
|                     | 89423     |
|                     | 89447     |
|                     | 89455     |
| <b>141137</b>       | 61506     |
|                     | 61519     |
|                     | 77377     |
|                     | 77492     |
|                     | G63377    |
|                     | G63492    |
|                     | G63377    |
|                     | G63492    |
|                     | G63712    |
| <b>141138</b>       | G63187    |
|                     | G63398    |
|                     | G63187    |
|                     | G63398    |
| <b>141150</b>       | 43140     |
|                     | 69606     |
| <b>141191</b>       | 69861     |
| <b>141247</b>       | 85703     |
|                     | 85710     |
|                     | 85711     |
|                     | 85311     |
|                     | 85312     |
|                     | 89424     |
| <b>141277</b>       | 61544     |
|                     | 77489     |
|                     | G63489    |
|                     | G63489    |
| <b>141349</b>       | 61545     |
|                     | G63404    |
|                     | G63612    |
|                     | G63432    |
|                     | G63404    |
| <b>141350</b>       | G63495    |

| Kit #               | Gabriel # |
|---------------------|-----------|
| <b>141350 Cont.</b> | G63547    |
|                     | G63495    |
|                     | G63547    |
|                     | G63781    |
|                     | G63782    |
| <b>141353</b>       | 61535     |
|                     | 61551     |
|                     | 77424     |
|                     | G63511    |
|                     | 61664     |
|                     | G63424    |
|                     | G63847    |
|                     | 77847     |
|                     | G63847    |
|                     | G63424    |
|                     | G63511    |
| <b>141354</b>       | G63707    |
| <b>141356</b>       | 77418     |
|                     | 77904     |
|                     | G63418    |
|                     | G63904    |
|                     | G63418    |
|                     | G63904    |
| <b>141368</b>       | 77909     |
|                     | G63909    |
|                     | G63909    |
| <b>141376</b>       | 77903     |
|                     | G63903    |
|                     | G63903    |
| <b>141387</b>       | 85107     |
| <b>141397</b>       | 6805SE    |
|                     | 6804SE    |
| <b>141405</b>       | G63620    |
| <b>141439</b>       | G63434    |
| <b>141448</b>       | G63506    |
|                     | G63694    |
| <b>141514</b>       | G63799    |
| <b>141537</b>       | 58489     |
| <b>141665</b>       | 58783     |
|                     | 58803     |
|                     | 58817     |
|                     | 61615     |
|                     | 61626     |

| Kit #               | Gabriel # |
|---------------------|-----------|
| <b>141665 Cont.</b> | 61641     |
|                     | 61643     |
|                     | 61663     |
|                     | 77783     |
|                     | 77817     |
|                     | G63721    |
|                     | G63772    |
|                     | G63783    |
|                     | G63803    |
|                     | G63817    |
|                     | G63721    |
|                     | G63772    |
|                     | G63783    |
|                     | G63803    |
| <b>141682</b>       | G52081    |
|                     | G52082    |
| <b>141716</b>       | G51842    |
| <b>141727</b>       | G56807    |
|                     | G56838    |
|                     | G56839    |
| <b>141998</b>       | 6802SE    |
|                     | 6803SE    |
|                     | 6826SE    |
|                     | 6805SE    |
|                     | 6805SE    |
| <b>142000</b>       | 6805SE    |
|                     | 6805SE    |
| <b>142036</b>       | G63884    |
| <b>142037</b>       | 6801SE    |
| <b>142038</b>       | 6807SE    |
| <b>142095</b>       | 63104     |
|                     | 63600     |
|                     | 83178     |
| <b>142101</b>       | G51047    |
| <b>142154</b>       | G51721    |
| <b>142169</b>       | G55948    |
|                     | G55949    |
| <b>142277</b>       | 61623     |
|                     | 77678     |
|                     | G63678    |
| <b>142280</b>       | G63885    |
| <b>142387</b>       | 14017     |
| <b>142389</b>       | 61662     |

**MOUNTING ACCESSORY PACKAGES - BUYER'S GUIDE**  
**KITS DE ACCESORIOS – GUÍA DEL COMPRADOR**  
**ENSEMBLE D'ACCESSOIRES POUR LA FIXATION - GUIDE DE L'ACHETEUR**

| Kit #               | Gabriel # |
|---------------------|-----------|
| <b>142389 Cont.</b> | 77815     |
|                     | G63813    |
|                     | G63815    |
|                     | G63610    |
|                     | G63865    |
| <b>142467</b>       | G51077    |
| <b>142486</b>       | 77955     |
| <b>142491</b>       | 85101     |
| <b>142592</b>       | 77847     |
|                     | 61664     |
|                     | G63424    |
|                     | G63847    |
|                     | G63847    |
| <b>142615</b>       | 61555     |
|                     | G63375    |
|                     | G63375    |
| <b>142617</b>       | 58622     |
|                     | 58623     |
|                     | 58807     |
|                     | 61646     |
|                     | 77807     |
|                     | G63622    |
|                     | G63623    |
|                     | G63622    |
|                     | G63623    |
| <b>142656</b>       | 83512     |
|                     | G63616    |
| <b>142657</b>       | G63615    |
| <b>142700</b>       | 58715     |
|                     | 58778     |
|                     | 61612     |
|                     | 61638     |
|                     | 77715     |
|                     | 77778     |
|                     | G63715    |
|                     | G63778    |
|                     | G63715    |
|                     | G63778    |
| <b>142718</b>       | 6828SE    |
|                     | 6854SE    |
| <b>142731</b>       | 58673     |
|                     | 58674     |
|                     | 58714     |

| Kit #               | Gabriel # |
|---------------------|-----------|
| <b>142731 Cont.</b> | 58716     |
|                     | 61611     |
|                     | 61613     |
|                     | 61634     |
|                     | 61635     |
|                     | 61680     |
|                     | 61712     |
|                     | 61714     |
|                     | 77623     |
|                     | 77673     |
|                     | 77674     |
|                     | 77714     |
|                     | 77716     |
|                     | 77947     |
|                     | 77948     |
|                     | 77951     |
|                     | G63674    |
|                     | G63714    |
|                     | G63716    |
|                     | G63848    |
|                     | G63886    |
|                     | G64009    |
|                     | G64011    |
|                     | G64029    |
|                     | G64030    |
|                     | G63674    |
|                     | G63714    |
|                     | G63716    |
|                     | G63848    |
|                     | G63886    |
|                     | G64009    |
|                     | G64011    |
| <b>142973</b>       | 61711     |
|                     | G64008    |
|                     | G64008    |
| <b>142976</b>       | G63828    |
|                     | G63832    |
| <b>142998</b>       | 83456     |
| <b>143000</b>       | 58661     |
|                     | 61599     |
|                     | 77949     |
|                     | G63661    |
|                     | G63673    |

| Kit #               | Gabriel # |
|---------------------|-----------|
| <b>143000 Cont.</b> | G63661    |
|                     | G63673    |
| <b>143008</b>       | G51477    |
| <b>143077</b>       | 6856SE    |
| <b>143078</b>       | 61685     |
|                     | G63893    |
|                     | G63894    |
|                     | G63895    |
|                     | G63958    |
|                     | G64001    |
| <b>143146</b>       | 77967     |
|                     | G63969    |
|                     | G63969    |
| <b>143154</b>       | 6855SE    |
| <b>143155</b>       | 6853SE    |
| <b>143156</b>       | 6856SE    |
| <b>143157</b>       | 6857SE    |
| <b>143159</b>       | 6862SE    |
| <b>143160</b>       | 6861SE    |
| <b>143161</b>       | 6858SE    |
| <b>143162</b>       | 6860SE    |
| <b>143163</b>       | 6848SE    |
| <b>143164</b>       | 6863SE    |
| <b>143165</b>       | 6852SE    |
| <b>143166</b>       | 6859SE    |
| <b>143167</b>       | 6849SE    |
| <b>143168</b>       | 6850SE    |
| <b>143172</b>       | G56778    |
| <b>143177</b>       | 6851SE    |
| <b>143248</b>       | G57021    |
| <b>143276</b>       | 61683     |
|                     | 61684     |
|                     | 77803     |
|                     | 77954     |
|                     | G63893    |
|                     | G63894    |
|                     | G63895    |
|                     | G63958    |
|                     | G64001    |
| <b>143312</b>       | G63884    |
| <b>143340</b>       | G64038    |
| <b>145054</b>       | 85729     |
|                     | 85731     |

**MOUNTING ACCESSORY PACKAGES - BUYER'S GUIDE**  
**KITS DE ACCESORIOS – GUÍA DEL COMPRADOR**  
**ENSEMBLE D'ACCESSOIRES POUR LA FIXATION - GUIDE DE L'ACHETEUR**

| Kit #               | Gabriel # |
|---------------------|-----------|
| <b>145054 Cont.</b> | 83103     |
|                     | 83134     |
|                     | 83136     |
|                     | 83635     |
|                     | 85009     |
|                     | 85026     |
|                     | 85027     |
|                     | 85071     |
|                     | 85080     |
|                     | 85085     |
|                     | 85092     |
|                     | 85096     |
|                     | 85318     |
|                     | 85324     |
|                     | 85330     |
|                     | 85336     |
|                     | 85342     |
|                     | 85379     |
|                     | 85701     |
|                     | 85900     |
|                     | 85902     |
|                     | 85921     |
|                     | 89417     |
|                     | 89418     |
|                     | 89441     |
|                     | 85025     |
| <b>145075</b>       | 85723     |
| <b>145080</b>       | 83107     |
|                     | 85012     |
|                     | 85054     |
|                     | 85055     |
|                     | 85062     |
|                     | 85063     |
|                     | 89408     |
|                     | 89413     |
|                     | 89438     |
|                     | 89439     |
| <b>145090</b>       | 85380     |
|                     | 85740     |
|                     | 695406    |
|                     | 85081     |
|                     | 85093     |
|                     | 85103     |

| Kit #               | Gabriel # |
|---------------------|-----------|
| <b>145090 Cont.</b> | 85110     |
|                     | 85117     |
|                     | 85123     |
|                     | 85316     |
|                     | 85346     |
|                     | 85347     |
|                     | 85705     |
|                     | 85706     |
|                     | 85707     |
|                     | 85708     |
|                     | 85709     |
|                     | 85722     |
|                     | 85745     |
|                     | 85746     |
|                     | 85935     |
|                     | 85973     |
|                     | 85982     |
|                     | 85993     |
|                     | 87020     |
|                     | 89426     |
|                     | 85987     |
|                     | 87016     |
| <b>145093</b>       | 85714     |
|                     | 85715     |
|                     | 85716     |
|                     | 85717     |
|                     | 85718     |
|                     | 85719     |
| <b>145099</b>       | 83353     |
|                     | 85033     |
|                     | 85988     |
|                     | 89427     |
| <b>145116</b>       | 87016     |
|                     | 85732     |
|                     | 83162     |
| <b>145126</b>       | 85053     |
|                     | 89442     |
| <b>145128</b>       | 85065     |
|                     | 83062     |
|                     | 83109     |
|                     | 83110     |
|                     | 83111     |
|                     | 83112     |

| Kit #               | Gabriel # |
|---------------------|-----------|
| <b>145128 Cont.</b> | 83138     |
|                     | 83142     |
|                     | 83143     |
|                     | 85083     |
|                     | 85332     |
|                     | 85333     |
|                     | 85977     |
| <b>145140</b>       | 85727     |
|                     | 85728     |
| <b>145143</b>       | 83120     |
| <b>145144</b>       | 85065     |
| <b>145148</b>       | 83140     |
|                     | 83141     |
| <b>145158</b>       | 63322     |
| <b>145168</b>       | 83173     |
|                     | 85981     |
| <b>145177</b>       | 85118     |
| <b>401011</b>       | 83179     |
|                     | 83404     |
|                     | 83505     |
|                     | 83506     |
| <b>401754</b>       | 83214     |
|                     | 83215     |
|                     | 83217     |
|                     | 83225     |
|                     | 83362     |
|                     | 85001     |
|                     | 85004     |
|                     | 85007     |
|                     | 85040     |
|                     | 85042     |
|                     | 85070     |
|                     | 85300     |
|                     | 85301     |
|                     | 85302     |
|                     | 85303     |
|                     | 85304     |
|                     | 85305     |
|                     | 85307     |
|                     | 85308     |
|                     | 85313     |
|                     | 85314     |
|                     | 85315     |

**MOUNTING ACCESSORY PACKAGES - BUYER'S GUIDE**  
**KITS DE ACCESORIOS – GUÍA DEL COMPRADOR**  
**ENSEMBLE D'ACCESSOIRES POUR LA FIXATION - GUIDE DE L'ACHETEUR**

| Kit #               | Gabriel # |
|---------------------|-----------|
| <b>401754 Cont.</b> | 85320     |
|                     | 85322     |
|                     | 85327     |
|                     | 85329     |
|                     | 85334     |
|                     | 85339     |
|                     | 85376     |
|                     | 85700     |
|                     | 85702     |
|                     | 85704     |
|                     | 85712     |
|                     | 85713     |
|                     | 85720     |
|                     | 85730     |
|                     | 85734     |
|                     | 85735     |
|                     | 85736     |
|                     | 85901     |
|                     | 85905     |
|                     | 85912     |
|                     | 85913     |
|                     | 85940     |
|                     | 85941     |
|                     | 85942     |
|                     | 85943     |
|                     | 85944     |
|                     | 85948     |
|                     | 85949     |
|                     | 85951     |
|                     | 85968     |
|                     | 85983     |
|                     | 89410     |
|                     | 89412     |
|                     | 89419     |
|                     | 89420     |
|                     | 89422     |
|                     | 89425     |
|                     | 89429     |
|                     | 89459     |
|                     | 85703     |
|                     | 85710     |
|                     | 85711     |
|                     | 85729     |

| Kit #               | Gabriel # |
|---------------------|-----------|
| <b>401754 Cont.</b> | 85731     |
|                     | 85343     |
|                     | 85380     |
|                     | 85740     |
| <b>404702</b>       | 83007     |
|                     | 83001     |
|                     | 83006     |
|                     | 83011     |
|                     | 83012     |
|                     | 83038     |
|                     | 83047     |
|                     | 83117     |
|                     | 83401     |
|                     | 83508     |
|                     | 83510     |
|                     | 83161     |
|                     | 83177     |
|                     | 83509     |
| <b>405360</b>       | 85727     |
| <b>406422</b>       | 83162     |
| <b>500498</b>       | 14040     |
|                     | 6804SE    |
|                     | 6801SE    |
|                     | 6807SE    |
| <b>415010-802</b>   | 83162     |
| <b>142280</b>       |           |
| <b>142280</b>       | G63885    |
| <b>145089-000</b>   | 83120     |
|                     | 85343     |
|                     | 83102     |
|                     | 83154     |
|                     | 85069     |
|                     | 85073     |
|                     | 85122     |
|                     | 85319     |
|                     | 85340     |
|                     | 85341     |
|                     | 85733     |
|                     | 85970     |
|                     | 89428     |
| <b>145089-200</b>   | 85936     |
| <b>145089-200</b>   | 85937     |
| <b>145089-200</b>   | 85985     |

| Kit #                   | Gabriel # |
|-------------------------|-----------|
| <b>145089-200 Cont.</b> | 89456     |
| <b>145168-000</b>       | 85996     |
|                         | 85997     |
| <b>415010-802</b>       | 83140     |
|                         | 83141     |
|                         | 63322     |
| <b>415015-001</b>       | 85987     |
|                         | 63449     |
|                         | 63449     |
| <b>TR0027</b>           | 63450     |
|                         | 83159     |
|                         | 83511     |
|                         | 85074     |
|                         | 85077     |
|                         | 89446     |
|                         | 85031     |
|                         | 63432     |
|                         | 63448     |
|                         | 63451     |
|                         | 63548     |
|                         | 83513     |
|                         | 83514     |
|                         | 83515     |
|                         | 83512     |