

Connecting Dreams with Wisdom
智慧连接梦想



目录

Product catalog >>

 适用于五十铃D-MAX系列 For ISUZU D-MAX Series	01-12
 适用于丰田海拉克斯VIGO/REVO系列 For TOYOTA HILUX VIGO/REVO Series	13-48
 适用于丰田FORTUNER/SW4系列 For TOYOTA FORTUNER/SW4 Series	49-59
 适用于三菱L200系列 For MITSUBISHI L200 Series	60-71
 适用于福特RANGER系列 For FORD RANGER Series	72-75
 适用于大众AMAROK 12系列 For VOLKSWAGEN AMAROK 12 Series	76-78
 适用于尼桑NAVARA系列 For NISSAN NAVARA Series	79-82
 适用于LC76 系列 FOR LC76 Series	83-84
 适用于普拉多PRADO 2014/2018系列 For PRADO 2014/2018 Series	85-91
 适用于兰德酷路泽LANDCRUISER 2016系列 For LANDCRUISER 2016 Series	92-95

五十铃D-MAX系列 ISUZUD-MAX



<p>ZCXK-A-001 02 大灯(中东版) 02 HEAD LAMP (MID EAST) 213-1131 SIZE:77x41x70.5CM/8PCS N.W.:15KG G.W.:17KG</p> 	<p>ZCXK-A-002 06-11大灯带电机 06-11 HEAD LAMP WITH MOTOR SIZE:82x63x45CM/8PCS N.W.:18KG G.W.:20KG</p> 
<p>ZCXK-A-003 06-11大灯普通 06-11 HEAD LAMP NORMAL 213-1138 SIZE:82x63x45CM/8PCS N.W.:18KG G.W.:20KG</p> 	<p>ZCXK-A-004 D-MAX 轻卡花纹尾灯 D-MAX TRUCK COMMON TAIL LAMP 213-1901 SIZE:73x37x55CM/40PCS N.W.:18KG G.W.:20KG</p> 
<p>ZCXK-A-005 D-MAX 轻卡水晶尾灯 D-MAX TRUCK CRYSTAL TAIL LAMP 213-1901 SIZE:73x37x55CM/40PCS N.W.:18KG G.W.:20KG</p> 	<p>ZCXK-A-006 02尾灯 02 TAIL LAMP 213-1926-AE SIZE:90x36x54CM/20PCS N.W.:11.5KG G.W.:13KG</p> 
<p>ZCXK-A-007 06尾灯 06 TAIL LAMP 213-1929 SIZE:90x36x54CM/20PCS N.W.:11.5KG G.W.:13KG</p> 	<p>ZCXK-A-008 02-05 黑色手动车镜 02-05 MIRROR BLACK MANUAL SIZE:68x35x47CM/10PCS N.W.:20KGS G.W.:21 KGS</p> 
<p>ZCXK-A-009 06 黑色手动车镜 06 MIRROR BLACK MANUAL SIZE:68x35x47CM/10PCS N.W.:20KGS G.W.:21 KGS</p> 	<p>ZCXK-A-010 06 电镀手动车镜 06 MIRROR CHROME MANUAL SIZE:68x35x47CM/10PCS N.W.:20KGS G.W.:21 KGS</p> 

五十铃D-MAX系列 ISUZUD-MAX



<p>ZCXK-A-011 06 电镀电动车镜 06 MIRROR CHROME ELECTRIC SIZE:68x35x47CM/10PCS N.W.:20KGS G.W.:21 KGS</p> 	<p>ZCXK-A-012 08 LED 车镜 08 LED MIRROR SIZE:68x35x47CM/10PCS N.W.:22KG G.W.:23KG</p> 
<p>ZCXK-A-013 08 中网 (雪佛兰款) 08 GRILLE (CHEVROLET) SIZE:115x33x38CM/5PCS N.W.:9.5KG G.W.:12.5KG</p> 	<p>ZCXK-A-014 08 中网(五十铃) 08 GRILLE (ISUZU) SIZE:115x33x38CM/5PCS N.W.:9.5KG G.W.:12.5KG</p> 
<p>ZCXK-A-015 06-11前保险杠 06-11 FRONT BUMPER SIZE: N.W.:3.6KG G.W.:3.7KG</p> 	<p>ZCXK-A-016 风扇叶 FAN SIZE:82x45x44CM/20PCS N.W.:16KG G.W.:17KG</p> 
<p>ZCXK-A-017 轴头盖 SHAFT COVER SIZE: N.W.: G.W.:</p> 	<p>ZCXK-A-018 02-05雾灯 02-05 FOG LAMP 213-2016 SIZE:88x44x39CM/60PCS N.W.:23KG G.W.:24KG</p> 
<p>ZCXK-A-019 06-16雾灯 06-16 FOG LAMP 213-2019 SIZE:50x49x27CM/40PCS N.W.:20KG G.W.:21.5KG</p> 	<p>ZCXK-A-020 外门拉手 OUT HANDLE SIZE:56x52x45.5CM/100PCS N.W.: G.W.:</p> 

五十铃D-MAX系列 ISUZUD-MAX



ZCXXK-A-021

风扇罩

FAN SHROUD

SIZE:82.5x67x50CM/20PCS

N.W.:7KG G.W.:8KG



ZCXXK-A-022

保险丝盒

FUSE BOX

SIZE:69.5x37x66.5CM/20PCS

N.W.:10KG G.W.:13KG



ZCXXK-A-023

06 中网 (雪佛兰款)

06 GRILLE (CHEVROLET)

SIZE:108x31x41CM/5PCS

N.W.: 10KG G.W.:11KG



ZCXXK-A-024

D-MAX 06 翼子板D

-MAX 06 FENDER

SIZE:

N.W.: G.W.:



ZCXXK-A-025

06-12 前保险杠内铁杠

06-12 FRONT BUMPER INNER IRON BUMPER

SIZE:

N.W.:4.5KG G.W.:4.6KG



ZCXXK-A-026

D-MAX 06 机盖

D-MAX 06 HOOD

SIZE:

N.W.: G.W.:



ZCXXK-A-027

D-MAX 06 前门

D-MAX 06 FRONT DOOR

SIZE:

N.W.: G.W.:



ZCXXK-A-027-2

D-MAX 06 后门

D-MAX 06 REAR DOOR

SIZE:

N.W.: G.W.:



ZCXXK-A-028

09-11 车镜

09-11 MIRROR

SIZE:68x35x47CM/10PCS

N.W.:22KG G.W.:23KG



ZCXXK-A-029

前车门合页

FRONT DOOR HINGE

SIZE:

N.W.: G.W.:



五十铃D-MAX系列 ISUZUD-MAX



<p>ZCXX-A-030 拦板扣 TAIL GATE BUCKLE SIZE: N.W.: G.W.:</p> 	<p>ZCXX-A-031 机盖锁 HOOD LOCK SIZE:38x34x25CM/20PCS N.W.: G.W.:</p> 
<p>ZCXX-A-032 08-11 HID 大灯 08-11 D-MAX HID HEAD LAMP SIZE: N.W.: G.W.:</p> 	<p>ZCXX-A-033 前护杠 FRONT OVERBUMPER SIZE:117x20x42CM/1PCS N.W.:3.8 KG G.W.:4.8 KG</p> 
<p>ZCXX-A-034 D-MAX'06雾灯框 D-MAX 06 FOG LAMP FRAME SIZE: N.W.: G.W.:</p> 	<p>ZCXX-A-035 09-11 中网 09-11 GRILLE SIZE:115x33x38CM/5PCS N.W.: 9.5KG G.W.:12.5KG</p> 
<p>ZCXX-A-036 D-MAX 轻卡 LED尾灯 D-MAX TRUCK LED TAIL LAMP SIZE:56x47.5x39CM/40PCS N.W.:17 KG G.W.:18 KG</p> 	<p>ZCXX-A-037 08 D-MAX中网 08 D-MAX GRILLE SIZE: N.W.: G.W.:</p> 
<p>ZCXX-A-038 02-11 D-MAX翼子板内衬 02-11 D-MAX INNER LINING OF FENDER SIZE: N.W.: G.W.:</p> 	<p>ZCXX-A-039 2002-2011 D-MAX车门内拉手 2002-2011 D-MAX INNER DOOR HANDLE SIZE: N.W.: G.W.:</p> 









五十铃D-MAX系列 ISUZUD-MAX



<p>ZCXK-A-040 02-11 D-MAX挡泥板 02-11 D-MAX MUDGUARD SIZE: N.W.: G.W.:</p> 	<p>ZCXK-A-041 02-11 D-MAX 空滤 02-11 D-MAX AIR FILTER</p> 
<p>ZCXK-A-042 D-MAX 02-11 小边灯 D-MAX 02-11 SIDE LAMP SIZE: N.W.: G.W.:</p> 	<p>ZCXK-A-043 D-MAX 02-11 喷水壶 D-MAX 02-11 WIPER TANK SIZE: N.W.: G.W.:</p> 
<p>ZCXK-A-044 12 D-MAX 风扇罩 12 D-MAX FAN SHROUD SIZE:96.5x79.5x64CM/1TS N.W.: G.W.:</p> 	<p>ZCXK-A-045 12 D-MAX 喷水壶 12 D-MAX WIPER TANK SIZE: N.W.: G.W.:</p> 
<p>ZCXK-A-046 12 全电镀中网 4WD 12 GRILLE CHROME 4WD SIZE:109x55x40CM/5PCS N.W.: G.W.:</p> 	<p>ZCXK-A-046-2 12 普通中网(黑色) 12 GRILLE COMMON BLACK 2WD SIZE: N.W.: G.W.:</p> 
<p>ZCXK-A-046-3 12 普通中网(电镀) D-MAX 12 GRILLE CHROME 2WD</p> 	<p>ZCXK-A-047 12 大灯 12 HEAD LAMP SIZE:74x61x54CM/4PCS N.W.: G.W.:</p> 

五十铃D-MAX系列 ISUZUD-MAX

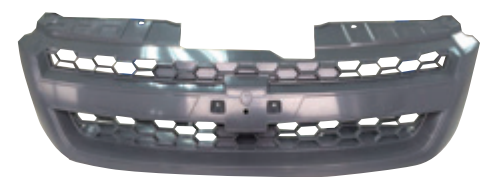

<p>ZCXXK-A-048 12-16 LED尾灯 12-16 LED TAIL LAMP SIZE:84x44x42CM/10PCS N.W.: G.W.:</p> 	<p>ZCXXK-A-049 12 LED 车镜 12 LED MIRROR SIZE:93x53x39CM/10PCS N.W.: G.W.:</p> 
<p>ZCXXK-A-050 D-MAX 12 后保险杠 D-MAX 12 REAR BUMPER SIZE:168x23x21CM/1PCS N.W.: G.W.:</p> 	<p>ZCXXK-A-051 D-MAX'12大灯(普通) D-MAX'12 HEAD LAMP SIZE:74x59x55CM/4PCS N.W.: G.W.:</p> 
<p>ZCXXK-A-052 D-MAX'12普通 后灯 D-MAX'12 TAIL LAMP SIZE:84x44x42CM/10PCS N.W.: G.W.:</p> 	<p>ZCXXK-A-053 D-MAX'12雾灯框(黑色) D-MAX'12 FOG LAMP COVER BLACK</p> 
<p>ZCXXK-A-053-2 D-MAX'12雾灯框(电镀) D-MAX 2012 FOG LAMP COVER CHROME</p> 	<p>ZCXXK-A-054 D-MAX'12中网(黑色) D-MAX 2012 CHEVROLET GRILLE BLACK</p> 
<p>ZCXXK-A-054-2 D-MAX'12中网(电镀) D-MAX 2012 GRILLE CHROME</p> 	<p>ZCXXK-A-055 D-MAX'12前杠 D-MAX'12 FRONT BUMPER 8981965730</p> 

五十铃D-MAX系列 ISUZUD-MAX



ZCXK-A-056
12 D-MAX 挡泥板
12 D-MAX MUD GUARD



ZCXK-A-057
12 D-MAX 空滤
12 D-MAX AIR FILTER
SIZE:68x66x77CM/8PCS
N.W.: G.W.:



ZCXK-A-058
12 普通车镜
12 COMMON MIRROR



ZCXK-A-059
12 D-MAX 前保险杠内铁杠
12 D-MAX FRONT BUMPER INNER IRON BUMPER



ZCXK-A-060
D-MAX '2012 行李架
D-MAX'2012 ROOF RACK
SIZE:
N.W.: G.W.:



ZCXK-A-061
D-MAX '2012 叶子板内衬
12 D-MAX INNER LINING 4WD



ZCXK-A-061-2
D-MAX '2012 叶子板内衬
12 D-MAX INNER LINING 2WD



ZCXK-A-062
D-MAX '2012 油壶
12 D-MAX POWER OIL TANK



ZCXK-A-063
D-MAX '2012 机盖亮条电镀
12 D-MAX HOOD STRIP CHROME

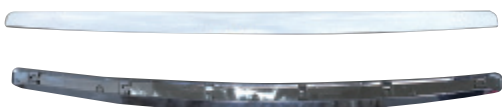

ZCXK-A-063-2
D-MAX '2012 机盖亮条黑色
12 D-MAX HOOD STRIP BLACK



五十铃D-MAX系列 ISUZUD-MAX



ZCXX-A-064
D-MAX '2012 雾灯框带灯
12 D-MAX FOG LAMP COVER WITH LED 2WD



ZCXX-A-064-2
12 D-MAX 雾灯框不带灯
12 D-MAX FOG LAMP COVER WITHOUT LED 2WD



ZCXX-A-065
17 D-MAX 高配大灯
17 D-MAX HEAD LAMP HIGH LEVEL



ZCXX-A-066
17 D-MAX 低配大灯
17 D-MAX HEAD LAMP LOW LEVEL



ZCXX-A-067
17 D-MAX 中网
17 D-MAX GRILLE



ZCXX-A-067-2
2017D-MAX 中网黑色
2017 D-MAX GRILLE BLACK



ZCXX-A-067-3
017 D-MAX 中网灰色
2017 D-MAX GRILLE BLACK 2017 D-MAX GRILLE GREY



ZCXX-A-067-4
2017 D-MAX TRD 中网
2017 D-MAX TRD GRILLE



ZCXX-A-068
17 D-MAX 前保险杠 4WD
17 D-MAX FRONT BUMPER 4WD



ZCXX-A-068-2
17 D-MAX 前保险杠 2WD
17 D-MAX FRONT BUMPER 2WD



五十铃D-MAX系列 ISUZUD-MAX



ZCXXK-A-069
17 D-MAX 雾灯
17 D-MAX FOG LAMP 4WD



ZCXXK-A-069-2
17 D-MAX 雾灯
17 D-MAX FOG LAMP 2WD



ZCXXK-A-070
17 D-MAX 挡泥板
17 D-MAX MUDGUARD



ZCXXK-A-071
17 D-MAX 尾灯
17 D-MAX TAIL LAMP



ZCXXK-A-072
2017D-MAX 中网电镀 (雪佛兰款)
2017 D-MAX CHEVROLET GRILLE



ZCXXK-A-073
2017 D-MAX 前杠小
2017 D-MAX FRONT SMALL BUMPER



ZCXXK-A-074
2017 D-MAX雾灯杠带 LED
2017 D-MAX FOG LAMP COVER WITH LED



ZCXXK-A-075
2017 D-MAX前护杠
2017 D-MAX FRONT OVERGUARD



ZCXXK-A-076
2017 D-MAX TRD护杠
2017 D-MAX TRD OVER BUMPER



ZCXXK-A-077
12 D-MAX 机盖
12 D-MAX HOOD



五十铃D-MAX系列 ISUZUD-MAX



<p>ZCXK-A-078 18 D-MAX 机盖 18 D-MAX HOOD</p> 	<p>ZCXK-A-079 12 D-MAX 叶子板 12 D-MAX FENDER 4X2.</p> 
<p>ZCXK-A-079-2 12 D-MAX 叶子板 12 D-MAX FENDER 4X4</p> 	<p>ZCXK-A-080 12 D-MAX 前门 12 D-MAX FRONT DOOR SINGLE CAB</p> 
<p>ZCXK-A-080-2 12 D-MAX 前门 12 D-MAX FRONT DOOR DOUBLE CAB</p> 	<p>ZCXK-A-081 12 D-MAX 后门 12 D-MAX REAR DOOR</p> 
<p>ZCXK-A-082 12 D-MAX 后背门 12 D-MAX TAILGATE THAILAND TYPE</p> 	<p>ZCXK-A-083 12 D-MAX水箱框架 12 D-MAX RADIATOR SUPPORT</p> 
<p>ZCXK-A-084 A 2020 高配大灯左驾 2020 D-MAX HIGH LEVEL HEAD LAMP LEFT HAND DRIVE</p> 	<p>ZCXK-A-084 B 2020 高配大灯右驾 2020 D-MAX HIGH LEVEL HEAD LAMP RIGHT HAND DRIVE</p> 

五十铃D-MAX系列 ISUZUD-MAX



ZCXK-A-084 C
2020 高配大灯低升高 左驾
2020 D-MAX HIGH LEVEL HEAD LAMP LEFT HAND DRIVE UPGRADE TYPE



ZCXK-A-084 D
2020 高配大灯低升高 右架
2020 D-MAX HIGH LEVEL HEAD LAMP RIGHT HAND DRIVE UPGRADE TYPE



ZCXK-A-084-2
2020 低配大灯
2020 D-MAX LOW LEVEL HEAD LAMP



ZCXK-A-085 A
2020 高配尾灯
2020 D-MAX HIGH LEVEL TAIL LAMP



ZCXK-A-085 B
2020 D-MAX 高配尾灯烟灰色
2020 D-MAX HIGH LEVEL TAIL LAMP SMOKE



ZCXK-A-085-2
2020 低配尾灯
2020 D-MAX LOW LEVEL TAIL LAMP



ZCXK-A-086
2020 四驱中网
2020 D-MAX 4WD GRILLE



ZCXK-A-086-2
2020 两驱中网
D-MAX 2WD GRILLE



ZCXK-A-087
2020 高配倒车镜
2020 D-MAX HIGH LEVEL MIRROR



ZCXK-A-087-2
2020 低配倒车镜
2020 D-MAX LOW LEVEL MIRROR



ZCXK-A-088
2020 四驱雾灯带转向灯带雾灯框高配
2020 D-MAX 4WD FOG LAMP WITH TURNING LAMP WITH FOG LAMP COVER HIGH LEVEL



五十铃D-MAX系列 ISUZUD-MAX



<p>ZCXXK-A-089 2020 两驱转向灯带雾灯框低配 2020 D-MAX 2WD TURNING LAMP WITH FOG LAMP COVER LOW LEVEL</p> 	<p>ZCXXK-A-090 2020 两驱雾灯带转向灯带雾灯框高配 2020 D-MAX 2WD FOG LAMP+FOG LAMP COVER+TURNING LAMP HIGH LEVEL</p> 
<p>ZCXXK-A-091 2020 四驱前杠 2020 D-MAX 4WD FRONT BUMPER</p> 	<p>ZCXXK-A-091-2 2020 两驱前杠 2020 D-MAX 2WD FRONT BUMPER</p> 
<p>ZCXXK-A-092 2020 水箱盖板 2020 D-MAX UPPER PLASTIC COVER OF RADIATOR</p> 	<p>ZCXXK-A-093 2020 D-MAX机盖 2020 D-MAX HOOD</p> 
<p>ZCXXK-A-094 2020 D-MAX 叶子板 2020 D-MAX FENDER</p> 	<p>ZCXXK-A-095 2020 D-MAX水箱框架 2020 D-MAX RADIATOR SUPPORT</p> 
<p>ZCXXK-A-096 2020 D-MAX高配前杠支架 2020 D-MAX HIGH LEVEL FRONT BUMPER BRACKET</p> 	<p>ZCXXK-A-096-2 2020 D-MAX低配前杠支架 2020 D-MAX LOW LEVEL FRONT BUMPER BRACKET</p> 

五十铃D-MAX系列 ISUZUD-MAX



<p>ZCXX-A-097 2020 D-MAX空滤 2020 D-MAX AIR CLEANER</p> 	<p>ZCXX-A-098 2020 D-MAX滤清器 2020 D-MAX AIR FILTER CORE</p> 
<p>ZCXX-A-099 2020 D-MAX风扇叶 2020 D-MAX FAN</p> 	<p>ZCXX-A-100 2020 D-MAX柴油版水壶 2020 D-MAX WATER TANK DIESEL</p> 
<p>ZCXX-A-101 2020 D-MAX喷水壶 2020 D-MAX WIPER TANK</p> 	<p>ZCXX-A-102 2020 D-MAX外门拉手左驾 2020 D-MAX OUT DOOR HANDLE LEFT HAND DRIVE</p> 
<p>ZCXX-A-102-2 2020 D-MAX外门拉手右驾 2020 D-MAX OUT DOOR HANDLE RIGHT HAND DRIVE</p> 	<p>ZCXX-A-103 2020 D-MAX尾门把手 2020 D-MAX TAIL GATE HANDLE</p> 
<p>ZCXX-A-104 2020 D-MAX机盖铰链 2020 D-MAX HOOD HINGE</p> 	<p>ZCXX-A-105 2020 D-MAX后杠 2020 D-MAX REAR BUMPER</p> 

五十铃D-MAX系列 ISUZUD-MAX



<p>ZCXXK-A-106 2020 D-MAX风扇罩3.0 2020 D-MAX FAN SHROUD 3.0 TYPE 8975534420</p> 	<p>ZCXXK-A-106-2 2020 D-MAX风扇罩1.9 2020 D-MAX FAN SHROUD 1.9 TYPE 8975534440</p> 
<p>ZCXXK-A-107 2020 D-MAX前翼子板内衬 2020 D-MAX FRONT INNER LINING OF FENDER 8975534420</p> 	<p>ZCXXK-A-108 2020 D-MAX挡泥板2WD D-MAX 2020 MUD GUARD 2WD SMALL LH:8983561980 RH:8983561970 BIG LH:8983561960 RH:8983561950</p> 
<p>ZCXXK-A-108-2 2020 D-MAX挡泥板4WD D-MAX 2020 MUD GUARD 4WD SMALL LH:8983562180 RH:8983562170 BIG LH:8983562160 RH:8983562150</p> 	<p>ZCXXK-A-109 2020 D-MAX边灯 D-MAX 2020 SIDE LAMP</p> 
<p>ZCXXK-A-110 2022 D-MAX高配中网 D-MAX 2022 GRILLE HIGH LEVEL</p>  	<p>ZCXXK-A-110-2 2022 D-MAX低配中网 D-MAX 2022 GRILLE LOW LEVEL</p>  
<p>ZCXXK-A-111 2022 D-MAX高配尾灯 D-MAX 2022 TAIL LAMP</p>  	



2012 CHANGE TO 2021 BODY KIT



2021 LOW LEVEL CHANGE TO 2021 HIGH LEVEL BODY KIT



丰田海拉克斯VIGO/REVO系列 TOYOTA HILUX VIGO/REVO



<p>ZCXK-B-001 04-07大灯 04-07 HEAD LAMP 212-11G9 SIZE:64x54x51CM/4PCS N.W.: 10KG G.W.:11KG</p> 	<p>ZCXK-B-002 04-11 尾灯 04-11 TAIL LAMP 212-19K1-A/U SIZE:75x35x40CM/10PCS N.W.: 6.5KG G.W.:7.5KG</p> 
<p>ZCXK-B-003 05-12 LED 尾灯 05-12 LED TAIL LAMP SIZE:75x35x40CM/10PCS N.W.: 6.5KG G.W.:7.5KG</p> 	<p>ZCXK-B-004 04-07黑色中网 04-07 GRILLE BLACK SIZE:106x35x42CM/5PCS N.W.: 10KG G.W.:11KG</p> 
<p>ZCXK-B-005 04-07电镀中网 04-07 GRILLE CHROME SIZE:106x35x42CM/5PCS N.W.: 10KG G.W.:11KG</p> 	<p>ZCXK-B-006 04-07前保险杠(带雾灯孔、不带轮眉孔) 04-07 FRONT BUMPER(WITH FOG LAMP HOLE,WITHOUT WHEEL BROW HOLE) SIZE: N.W.: 3.7KG G.W.:3.8KG</p> 
<p>ZCXK-B-007 04-07前保险杠(带雾灯孔、带轮眉孔) 04-07 FRONT BUMPER (WITH FOG LAMP HOLE,WITH WHEEL BROW HOLE) SIZE: N.W.: 3.7KG G.W.:3.8KG</p> 	<p>ZCXK-B-008 04-07黑色后视镜 04-07 MIRROR BLACK SIZE:67x33x47CM/10PCS N.W.: 17KG G.W.:19KG</p> <p>ZCXK-B-008-2 04-07黑色电动后视镜 04-07 MIRROR BLACK(ELECTRIC)</p> 
<p>ZCXK-B-009 04-07雾灯 04-07 FOG LAMP SIZE:64x56x34CM/16PCS N.W.: 8KG G.W.:10KG</p> 	<p>ZCXK-B-009-2 04-07雾灯LED 04-07 VIGO FOG LAMP LED</p> 

丰田海拉克斯VIGO/REVO系列 TOYOTA HILUX VIGO/REVO



<p>ZCXK-B-010 08大灯 08 HEAD LAMP SIZE:64x54x51CM/4PCS N.W.: 10KG G.W.:11KG</p> 	<p>ZCXK-B-011 08电镀电动后视镜 08 MIRROR CHROME(ELECTRIC) SIZE:67x33x47CM/10PCS N.W.: 17KG G.W.:19KG</p> <p>ZCXK-B-011-2 08电镀手动后视镜 08 MIRROR CHROME(HANDLE)</p> 	
<p>ZCXK-B-012 08雾灯 08 FOG LAMP SIZE:68x49x40CM/40PCS N.W.: 7KG G.W.:9KG</p> 	<p>ZCXK-B-012-2 08 雾灯LED VIGO 08 FOG LAMP LED</p> 	
<p>ZCXK-B-013 05-11 边灯(白) 05-11 SIDE LAMP WHITE SIZE: N.W.: G.W.:</p> 	<p>ZCXK-B-013-2 12 边灯(黄) 12 SIDE LAMP YELLOW SIZE: N.W.: G.W.:</p> 	
<p>ZCXK-B-014 VIGO 08 全电镀中网 08 CHROME GRILLE SIZE:106x36x51CM/5PCS N.W.: 10KG G.W.:11KG</p> 	<p>ZCXK-B-014-2 VIGO 08 中网(金) 08 GOLDEN GRILLE SIZE:106x36x51CM/5PCS N.W.: 10KG G.W.:11KG</p> 	
<p>ZCXK-B-015 2005-2014 内铁翼子板 2005-2014 INNER METAL FENDER</p> 	<p>ZCXK-B-016 2005-2014 双排车顶 2005-2014 DOUBLE CABIN ROOF</p>  	

丰田海拉克斯VIGO/REVO系列 TOYOTA HILUX VIGO/REVO



<p>ZCXXK-B-017 05-14后保险杠 05-14 REAR BUMPER SIZE:163x19.5x25CM/1PCS N.W.: 10KG G.W.:11KG</p> 	<p>ZCXXK-B-017-2 VIGO 后杠 (金) VIGO REAR BUMPER (GOLDEN) SIZE:163x19.5x25CM/1PCS N.W.: 10KG G.W.:11KG</p> 
<p>ZCXXK-B-017-3 VIGO 后杠 (黑) VIGO REAR BUMPER (BLACK) SIZE:163x19.5x25CM/1PCS N.W.: 10KG G.W.:11KG</p> 	<p>ZCXXK-B-017-4 VIGO 2012 (原装后保险杠) 2012 VIGO REAR BUMPER ORIGINAL TYPE</p> 
<p>ZCXXK-B-017-4 A VIGO 2012 后杠包角 VIGO 2012 REAR BUMPER SIDE COVER</p> 	<p>ZCXXK-B-017-4 B VIGO 2012 后杠踏板 VIGO 2012 REAR BUMPER STEP COVER</p> 
<p>ZCXXK-B-018 08-11 前保险杠网格 08-11 BUMPER GRILLE SIZE:110x32.7x37CM/40PCS N.W.: 13KG G.W.:14 KG</p> 	<p>ZCXXK-B-019 05-11保险杠支架 05-11 FRONT BUMPER SUPPORT SIZE:53x48x41CM/300PCS N.W.: 17KG G.W.:18KG</p> 
<p>ZCXXK-B-020 风扇叶 FAN SIZE:82x45x44CM/20PCS N.W.: 16KG G.W.:17KG</p> 	<p>ZCXXK-B-021 VIGO 05-14 一排半车顶 VIGO 05-14 SMART CAB ROOF SIZE: N.W.: G.W.:</p>  

丰田海拉克斯VIGO/REVO系列 TOYOTA HILUX VIGO/REVO



<p>ZCXX-B-022 水壺汽油 WATER TANK GASOLINE SIZE:76.5x32.5x37.5CM/30PCS N.W.: 8KG G.W.:9KG</p> 	<p>ZCXX-B-023 水壺柴油 WATER TANK DIESEL SIZE:71x57x36CM/25PCS N.W.: 7KG G.W.: 8KG</p> 
<p>ZCXX-B-024 2005-2014中东版后叶子板 2005-2014 MID ASIA TYPE REAR FENDER</p>  	<p>ZCXX-B-025 2005-2014泰国版后叶子板 2005-2014 THAILAND TYPE REAR FENDER</p>  
<p>ZCXX-B-026 外侧围 2005-2014 VIGO DOUBLE CABIN PILLAR</p>  	<p>ZCXX-B-027 花纹电镀外拉手 DECORATIVE CHROME OUTHANDLE SIZE:48x36x41CM/250PCS N.W.: G.W.:</p> 
<p>ZCXX-B-027-2 黑色外拉手 BLACK OUTHANDLE SIZE:48x36x41CM/250PCS N.W.: G.W.:</p> 	<p>ZCXX-B-028 挡板扣 TAIL GATE BUCKLE SIZE:38x34x25CM/100PCS N.W.: 17KG G.W.:18KG</p> 
<p>ZCXX-B-029 机盖锁 HOOD LOCK SIZE:42x22x23CM/25PCS N.W.: 7KG G.W.:8 KG</p> 	<p>ZCXX-B-030 VIGO 05-14 一排半车门外侧围 VIGO 05-14 SMART CAB PILLAR SIZE: N.W.: G.W.:</p>  

丰田海拉克斯VIGO/REVO系列 TOYOTA HILUX VIGO/REVO



<p>ZCXX-B-031 汽油空滤 AIR FILTER (GASOLINE) SIZE:56x49x37.5CM/2PCS N.W.: 6KG G.W.:7KG</p> 	<p>ZCXX-B-031-2 柴油空滤 AIR FILTER(DIESEL) SIZE:56x49x37.5CM/2PCS N.W.: 6KG G.W.:7KG</p> 	<p>ZCXX-B-032 08-11半电镀中网黑色 08 HALF CHROME GRILLE BLACK SIZE:106x36x51CM/5PCS N.W.:10KG G.W.:11KG</p> 	
<p>ZCXX-B-032-2 08-11半电镀中网灰色 08 HALF CHROME GRILLE GRAY SIZE:106x36x51CM/5PCS N.W.:10KG G.W.:11KG</p> 	<p>ZCXX-B-032-3 08-11中网黑色 08 -11 GRILLE BLACK SIZE:106x36x51CM/5PCS N.W.:10KG G.W.:11KG</p> 		
<p>ZCXX-B-033 12 尾灯 2012-2014 TAIL LAMP SIZE:75x35x40CM/10PCS N.W.: 7KG G.W.:8KG</p> 	<p>ZCXX-B-033-2 2012 尾灯改2021版本 2012 VIGO TAIL LAMP 2021 TAIL LAMP TYPE</p> 		
<p>ZCXX-B-034 12白色车镜 (东南亚) 12 MIRROR (SOUTHEAST ASIA) SIZE:75.5x34.5x48.5CM/10PCS N.W.: 17KG G.W.:19KG</p> 	<p>ZCXX-B-034-2 12 电镀车镜 (东南亚) 12 CHROME MIRROR (SOUTHEAST ASIA) SIZE:75.5x34.5x48.5CM/10PCS N.W.: 17KG G.W.:19KG</p> 		
<p>ZCXX-B-035 2012 大灯 2012 HEAD LAMP SIZE:70.5x65x50CM/4PCS N.W.: 10KG G.W.:11.5KG</p> 	<p>ZCXX-B-035-2 VIGO 12 熏黑大灯 VIGO 12 HEAD LAMP BLACK SIZE:70.5x65x50CM/4PCS N.W.: 10KG G.W.:11.5KG</p> 		

丰田海拉克斯VIGO/REVO系列 TOYOTA HILUX VIGO/REVO



<p>ZCXK-B-036 VIGO 12雾灯 VIGO 12 FOG LAMP SIZE:68x49x40CM/40PCS N.W.: 7KG G.W.:9KG</p> 	<p>ZCXK-B-036-2 2012雾灯LED 2012 FOG LAMP LED</p> 
<p>ZCXK-B-036-3 2014雾灯 2014 FOG LAMP 2014</p> 	<p>ZCXK-B-037 VIGO 12半电镀中网灰色 VIGO 12HALF CHROME GRILLE GRAY SIZE:114.5x39.5x61CM/5PCS N.W.: 10 KG G.W.:11KG</p> 
<p>ZCXK-B-037-2 VIGO 12 全电镀中网 VIGO 12 CHROME GRILLE SIZE:114.5x39.5x61CM/5PCS N.W.: 10 KG G.W.:11KG</p> 	<p>ZCXK-B-037-3 VIGO 12 中网 (金) VIGO 12 GRILLE (GOLDEN) SIZE:114.5x39.5x61CM/5PCS N.W.: 10 KG G.W.:11KG</p> 
<p>ZCXK-B-037-4 VIGO 12 中网 (黑) VIGO 12 GRILLE (BLACK) SIZE:114.5x39.5x61CM/5PCS N.W.: 10 KG G.W.:11KG</p> 	<p>ZCXK-B-037-5 VIGO 12 中网半电镀 (黑色) VIGO 12 GRILLE CHROME AND BLACK</p> 
<p>ZCXK-B-038 VIGO 12车镜 VIGO 12 MIRROR SIZE:75.5x34.5x48.5CM/10PCS N.W.: 17KG G.W.:19KG</p> 	<p>ZCXK-B-039 05-14水箱框架 05-14 RADIATOR SUPPORT SIZE: N.W.: 5.4KG G.W.:7.4KG</p> 

丰田海拉克斯VIGO/REVO系列 TOYOTA HILUX VIGO/REVO



<p>ZCXK-B-040 VIGO 08 保险杠 VIGO 08 FRONT BUMPER SIZE: N.W.: 3.7KG G.W.:3.8KG</p> 	<p>ZCXK-B-041 05-11 前翼子板内衬 05-11 FRONT INNER LINING OF FENDER SIZE: N.W.: G.W.:</p> 
<p>ZCXK-B-042 05-14后翼子板内衬 05-14 REAR INNER LINING OF FENDER SIZE: N.W.: G.W.:</p> 	<p>ZCXK-B-043 VIGO 脚踏板 VIGO FOOT PLATE SIZE:216x23.5x20CM/1SET N.W.: G.W.:</p> 
<p>ZCXK-B-044 12 改装LED 车镜 12 MODIFIED LED MIRROR SIZE:75.5x34.5x48.5CM/10PCS N.W.: 17KG G.W.:19KG</p> 	<p>ZCXK-B-045 挡泥板 MUDGUARD 4PCS/6PCS SIZE:64x42x37CM/10SET N.W.:8KG G.W.:9KG</p> 
<p>ZCXK-B-046 风扇罩(柴油版) FAN SHROUD(DIESEL) SIZE:80x51x61CM/10PCS N.W.: 7KG G.W.:8KG</p> 	<p>ZCXK-B-046-2 2012 5L风扇罩 2012 VIGO 5L FAN SHROUD</p> 
<p>ZCXK-B-047 风扇罩(汽油版) FAN SHROUD(PETROL) SIZE:80x51x61CM/10PCS N.W.: 7KG G.W.:8KG</p> 	<p>ZCXK-B-048 08-11前护杠 08-11FRONT OVERBUMPER SIZE:134.5x20x43CM/1PCS N.W.: 4KG G.W.:5.5KG</p> 

丰田海拉克斯VIGO/REVO系列 TOYOTA HILUX VIGO/REVO



<p>ZCXXK-B-049 刮水器挡水板(左驾) WIPER PANEL(LEFT HAND) SIZE:80x51x61CM/20SET N.W.: 15KGS G.W.:16.3KGS</p> 	<p>ZCXXK-B-050 刮水器挡水板(右驾) WIPER PANEL(RIGHT HAND) SIZE:80x51x61CM/20SET N.W.: 15KGS G.W.:16.3KGS</p> 
<p>ZCXXK-B-051 VIGO机盖铰链 HOOD HINGE SIZE: N.W.: G.W.:</p> 	<p>ZCXXK-B-052 05-11 引擎盖 05-11 HOOD SIZE: N.W.: G.W.:</p> 
<p>ZCXXK-B-053 05-11 VIGO轮眉 05-11 VIGO WHEEL EYEBROW SIZE:119x67x29CM/2SET N.W.: 13KGS G.W.:15KGS</p> 	<p>ZCXXK-B-054 05-11 翼子板 4WD 05-11 FENDER 4 WD SIZE:91x11x125CM/2CARTON N.W.: G.W.:</p> 
<p>ZCXXK-B-054-2 05-11 翼子板 2WD 05-11 FENDER 2WD SIZE:91x11x125CM/2CARTON N.W.: G.W.:</p> 	<p>ZCXXK-B-055 2005-2014 VIGO 中东版后车厢 2005-2014 VIGO TAIL BODY MID ASIA TYPE</p> 
<p>ZCXXK-B-055-2 2005-2014 VIGO 泰国版后车厢 2005-2014 VIGO TAIL BODY THAILAND TYPE</p> 	<p>ZCXXK-B-056 VIGO车门饰板(灰) INNER DOOR BOARD SIZE:94.5x41x71CM/4PCS N.W.: G.W.:</p> 

丰田海拉克斯VIGO/REVO系列 TOYOTA HILUX VIGO/REVO



<p>ZCXX-B-057 前保险杠内铁杠 4WD FRONT BUMPER INNER IRON BUMPER 4WD SIZE: N.W.: G.W.:</p> 	<p>ZCXX-B-057-2 前保险杠内铁杠 2WD FRONT BUMPER INNER IRON BUMPER 2WD SIZE: N.W.: G.W.:</p> 
<p>ZCXX-B-058 VIGO前门 FRONT DOOR SIZE: N.W.: G.W.:</p> 	<p>ZCXX-B-059 VIGO滤清器 AIR FILTER CORE SIZE: N.W.: G.W.:</p> 
<p>ZCXX-B-060 前车门下踏板 FRONT DOOR UNDER PEDAL SIZE: N.W.: G.W.:</p> 	<p>ZCXX-B-060-2 后车门下踏板 REAR DOOR UNDER PEDAL SIZE: N.W.: G.W.:</p> 
<p>ZCXX-B-061 VIGO车门饰板 INNER DOOR BOARD SIZE:94.5x41x71CM/4PCS N.W.: G.W.:</p> 	<p>ZCXX-B-062 VIGO发动机铁保护板(前) FRONT ENGINE PROTECTION METAL BOARD SIZE: N.W.: G.W.:</p> 
<p>ZCXX-B-062-2 2012 VIGO前发动机铁护板2WD 2012 VIGO FRONT ENGINE COVER 2WD</p> 	<p>ZCXX-B-063 VIGO发动机铁保护板(中) MIDDLE ENGINE PROTECTION METAL BOARD SIZE: N.W.: G.W.:</p> 

丰田海拉克斯VIGO/REVO系列 TOYOTA HILUX VIGO/REVO



<p>ZCXK-B-064 VIGO发动机铁保护板(后) BACK ENGINE PROTECTION METAL BOARD SIZE: N.W.: G.W.:</p> 	<p>ZCXK-B-065 VIGO喷水壶 WIPER TANK SIZE:99.5x49x47.5CM/16PCS N.W.: 7.7KGS G.W.:9.7KGS</p> 
<p>ZCXK-B-065-2 VIGO喷水壶带电机 WIPER TANK WITH MOTOR</p> 	<p>ZCXK-B-066 12前保险杠 12 FRONT BUMPER SIZE: N.W.: G.W.:</p> 
<p>ZCXK-B-067 12前保险杠网格 12 FRONT BUMPER GRILLE SIZE:91.5x31.5x38.5/20PCS N.W.: 7KGS G.W.:9KGS</p> 	<p>ZCXK-B-068 12前保险杠支架 2012-2014 FRONT BUMPER BRACKET SIZE: N.W.: G.W.:</p> 
<p>ZCXK-B-069 VIGO 12-14前翼子板内衬 VIGO 12-14 FRONT INNER LINING OF FENDER</p> 	<p>ZCXK-B-070 VIGO 05前保险杠白色 VIGO 05 FRONT BUMPER WHITE</p> 
<p>ZCXK-B-071 VIGO 08前保险杠白色 VIGO 08 FRONT BUMPER WHITE</p> 	<p>ZCXK-B-072 VIGO 12前保险杠白色 VIGO 12 FRONT BUMPER WHITE</p> 

丰田海拉克斯VIGO/REVO系列 TOYOTA HILUX VIGO/REVO



<p>ZCXX-B-073 05-11 高位刹车灯红色 05-11 HIGH BRAKE LIGHT RED SIZE: N.W.: G.W.:</p> 	<p>ZCXX-B-074 VIGO'2012 前保险杠护罩 VIGO'2012 FRONT BUMPER COVER SIZE: N.W.: G.W.:</p> 
<p>ZCXX-B-075 VIGO 轮胎螺丝防护罩 VIGO TIRE SCREW PROTECTION COVER SIZE: N.W.: G.W.:</p>  	<p>ZCXX-B-076 05-14高位刹车灯(白) 05-14 HIGH BRAKE LIGHT WHITE</p> 
<p>ZCXX-B-077 12 VIGO 引擎盖 12 VIGO ENGINE HOOD SIZE: N.W.: G.W.:</p> 	<p>ZCXX-B-078 12 翼子板 2WD 12 FENDER 2 WD SIZE: N.W.: G.W.:</p> 
<p>ZCXX-B-078-2 12翼子板 4WD 12 FENDER 4WD SIZE: N.W.: G.W.:</p> 	<p>ZCXX-B-079 VIGO 后门 VIGO REAR DOOR SIZE: N.W.: G.W.:</p> 
<p>ZCXX-B-080 VIGO 尾门 (中东) TAIL GATE (MID EAST) SIZE: N.W.: G.W.:</p> 	<p>ZCXX-B-081 VIGO 尾门(东南亚) TAIL GATE (SOUTHEAST ASIA) SIZE: N.W.: G.W.:</p> 

丰田海拉克斯VIGO/REVO系列 TOYOTA HILUX VIGO/REVO



<p>ZCXXK-B-082 电镀装饰条 CHROME DECORATIVE STRIP SIZE: N.W.: G.W.:</p> 	<p>ZCXXK-B-083 HILUX VIGO 2012-2014 LED尾灯 HILUX VIGO 2012-2014 LED TAIL LAMP RED</p> 
<p>ZCXXK-B-084 HILUX VIGO 2012-2014 LED尾灯 HILUX VIGO 2012-2014 LED TAIL LAMP SMOKE</p> 	<p>ZCXXK-B-085 VIGO 涉水喉 VIGO PLASTIC SNORKEL SIZE:163x19.5x25CM/2SET N.W.: 5KG G.W.:6.6KG</p> 
<p>ZCXXK-B-086 VIGO '05-11机盖通风罩 VIGO 05-11 HOOD COVER SIZE: N.W.: G.W.:</p> 	<p>ZCXXK-B-087 VIGO '2012 机盖通风罩 VIGO 12 HOOD COVER SIZE: N.W.: G.W.:</p> 
<p>ZCXXK-B-088 VIGO 2012 高位刹车灯 (烟灰色) VIGO 2012 HIGH BRAKE LIGHT (SMOKE) SIZE: N.W.: G.W.:</p> 	<p>ZCXXK-B-089 VIGO 2005-2014 仪表台 VIGO 2005-2014 DASHBOARD SIZE: N.W.: G.W.:</p> 
<p>ZCXXK-B-090 VIGO 轮胎帽 VIGO TIRE CAP SIZE: N.W.: G.W.:</p> 	<p>ZCXXK-B-091 VIGO 2012 护杠 VIGO 2012 OVERBUMPER SIZE:136.5x25x48CM/1PCS N.W.: 4KGS G.W.:5.5KGS</p> 

丰田海拉克斯VIGO/REVO系列 TOYOTA HILUX VIGO/REVO



<p>ZCXK-B-091-2 12 护杠 (白, 绿, 蓝) 12 OVERBUMPER (WHITE, GREEN, BLUE) SIZE:136.5x25x48CM/1PC N.W.: 4KGS G.W.:5.5KGS</p>  	<p>ZCXK-B-092 VIGO'2012 轮眉 VIGO 2012 EYEBROW SIZE:119x67x29CM/2SET N.W.: 13KGS G.W.:15KGS</p> 
<p>ZCXK-B-093 VIGO'2012 行李架 VIGO'2012 ROOF RACK SIZE:86x16x13.5CM/1SET N.W.: G.W.:</p>  	<p>ZCXK-B-094 2005-2014 车壳 2005-2014 TAIL BODY SINGLE CAB</p>  
<p>ZCXK-B-095-A REVO 15 大灯低配改装高配 REVO 15 HEAD LAMP MODIFIED TYPE SIZE:88x42x74CM/2PCS N.W.: G.W.:</p>   	<p>ZCXK-B-095-B REVO 15 大灯高配原装 REVO 15 HEAD LAMP HIGH CLASS OEM SIZE:88x42x74CM/2PCS N.W.: G.W.:</p>   
<p>ZCXK-B-095-2 REVO 15 大灯低配 REVO 15 HEAD LAMP LOW CLASS SIZE:83x54x64CM/4PCS N.W.: G.W.:</p> 	<p>ZCXK-B-095-3 REVO 15 改装大灯LED REVO 2015 HEAD LAMP LED</p>  
<p>ZCXK-B-096 REVO 15 尾灯普通白色 REVO 15 TAIL LAMP BOTH WHITE SIZE:77x42x66CM/10PCS N.W.: G.W.:</p> 	<p>ZCXK-B-096-2 REVO 15 尾灯左驾 REVO 15 TAIL LAMP LEFT HAND DRIVE SIZE: N.W.: G.W.:</p> 

丰田海拉克斯VIGO/REVO系列 TOYOTA HILUX VIGO/REVO



<p>ZCXX-B-096-3 REVO 15 尾灯右驾 REVO 2015- TAIL LAMP RIGHT HAND DRIVE</p> 	<p>ZCXX-B-096-4 A REVO 15 尾灯 REVO 15 TAIL LAMP SMOKE</p> 
<p>ZCXX-B-096-4 B REVO 15 尾灯 REVO 15 TAIL LAMP SMOKE SIZE: N.W.: G.W.:</p> 	<p>ZCXX-B-096-5 REVO 15 尾灯LED REVO 15 TAIL LAMP LED SIZE: N.W.: G.W.:</p>  
<p>ZCXX-B-096-6 REVO 15 TRD尾灯 REVO 15 TRD TAIL LAMP</p> 	<p>ZCXX-B-097 REVO 15 右驾倒车镜 REVO 15 MIRROR RIGHT HAND SIZE: N.W.: G.W.:</p> 
<p>ZCXX-B-097-2 REVO 15 左驾车镜 REVO 15 MIRROR LEFT HAND SIZE: N.W.: G.W.:</p> 	<p>ZCXX-B-097-3 REVO 15 车镜不带灯电镀 REVO 15 MIRROR WITHOUT LAMP CHROME</p> 
<p>ZCXX-B-097-4 REVO 15 车镜不带灯黑色 HILUX REVO 2015- MIRROR WITHOUT LAMP BLACK</p> 	<p>ZCXX-B-097-5 REVO 15 车镜带灯LED 2015- REVO MIRROR WITH LED OPERATION</p> 

丰田海拉克斯VIGO/REVO系列 TOYOTA HILUX VIGO/REVO



<p>ZCXX-B-098 REVO 15 中网 (电镀) REVO 15 GRILLE (CHROME) SIZE:100x50x51CM/6PCS N.W.: G.W.:</p> 	<p>ZCXX-B-098-2 REVO 15 中网黑色 REVO 15 GRILLE BLACK SIZE:100x50x51CM/6PCS N.W.: G.W.:</p> 
<p>ZCXX-B-098-3 REVO 15 TRD中网 2015 REVO GRILLE TRD TYPE</p> 	<p>ZCXX-B-098-4 REVO 15 中网 2015 REVO GRILLE MODIFIED TYPE</p> 
<p>ZCXX-B-098-5 REVO 15 中网 2015 REVO GRILLE THAILAND TYPE</p> 	<p>ZCXX-B-098-6 REVO 15 中网 2015 REVO GRILLE THAILAND TYPE WITH LED</p> 
<p>ZCXX-B-099 REVO 15 前保险杠4WD REVO 15 FRONT BUMPER 4WD SIZE: N.W.: G.W.:</p> 	<p>ZCXX-B-099-2 REVO 15 前保险杠2WD REVO 15 FRONT BUMPER 2WD SIZE: N.W.: G.W.:</p> 
<p>ZCXX-B-099-3 REVO 2015-2017 TRD 前保险杠 2015-2017 REVO TRD BUMPER</p> 	<p>ZCXX-B-100 REVO 15 保险杠网格 REVO 15 BUMPER GRILLE SIZE:99x50x43CM/20PCS N.W.: G.W.:</p> 

丰田海拉克斯VIGO/REVO系列 TOYOTA HILUX VIGO/REVO



ZCXX-B-101

REVO 15 后杠
REVO 15 REAR BUMPER
SIZE:179x25x28.5CM/1PCS
N.W.: G.W.:



ZCXX-B-101-2

REVO 15 后保险杠黑
REVO 15 REAR BUMPER BLACK
SIZE:179x25x28.5CM/1PCS
N.W.: G.W.:



ZCXX-B-101-3

REVO 15 后保险杠灰色
HILUX REVO 2015- REAR BUMPER GRAY



ZCXX-B-101-4

REVO 15 TRD后保险杠
REVO 15 TRD REAR BUMPER



ZCXX-B-102-A

REVO 15 雾灯
REVO 15 FOG LAMP
SIZE:84.5x50x27.5CM/50PCS
N.W.: G.W.:



ZCXX-B-102-B

REVO 15 雾灯 LED
REVO 15 FOG LAMP LED
SIZE:
N.W.: G.W.:



ZCXX-B-102-2

REVO 15 雾灯罩(高配)
REVO 15 FOG LAMP COVER
SIZE:53x48x41CM/50PCS
N.W.: G.W.:



ZCXX-B-102-3

REVO 15 雾灯罩(低配)
REVO 15 FOG LAMP COVER
SIZE:53x48x41CM/50PCS
N.W.: G.W.:



ZCXX-B-102-4

REVO 15 雾灯罩带LED
REVO 2015 FOG LAMP COVER
WITH LED



ZCXX-B-103

REVO 15 前保险杠支架4WD
REVO 15 FRONT BUMPER SUPPORT 4WD
SIZE:
N.W.: G.W.:



丰田海拉克斯VIGO/REVO系列 TOYOTA HILUX VIGO/REVO



<p>ZCXK-B-103-2 REVO 15前保险杠支架2WD REVO 15 FRONT BUMPER SUPPORT 2WD SIZE: N.W.: G.W.:</p> 	<p>ZCXK-B-104 REVO 15高位刹车灯红色 REVO 15 HIGH BRAKE LIGHT RED SIZE: N.W.: G.W.:</p> 
<p>ZCXK-B-104-2 REVO 15高位刹车灯烟灰 REVO 15 HIGH BRAKE LIGHT SMOKE SIZE: N.W.: G.W.:</p> 	<p>ZCXK-B-104-3 REVO 15高位刹车灯流光(红/烟灰) REVO 15 HIGH BRAKE LIGHT MOVABLE TYPE RED/SMOKE</p> 
<p>ZCXK-B-105 REVO 15尾门把手带孔 高配 REVO 15 TAIL GATE HANDLE WITH HOLE SIZE: N.W.: G.W.:</p> 	<p>ZCXK-B-105-2 REVO 15尾门把手不带孔 低配 REVO 15 TAIL GATE HANDLE WITHOUT HOLE SIZE: N.W.: G.W.:</p> 
<p>ZCXK-B-106 REVO 15风扇罩柴油版 REVO 15 FAN SHROUD DIESEL SIZE:77x67.5x64CM/10PCS N.W.: G.W.:</p> 	<p>ZCXK-B-106-2 REVO 15风扇罩(汽油版) REVO 15 FAN SHROUD PETROL SIZE:77x67.5x64CM/10PCS N.W.: G.W.:</p> 
<p>ZCXK-B-107 REVO 15空滤柴油版 REVO 15 AIR FILTER DIESEL SIZE:70x56.5x33CM/4PCS N.W.: G.W.:</p> 	<p>ZCXK-B-107-2 REVO 15空滤(汽油版) REVO 15 AIR FILTER PETROL SIZE:70x56.5x33CM/4PCS N.W.: G.W.:</p> 

丰田海拉克斯VIGO/REVO系列 TOYOTA HILUX VIGO/REVO



<p>ZCXK-B-108 REVO 15 滤清器 REVO 15 AIR FILTER CORE SIZE:57.5x35x69CM/30PCS N.W.: G.W.:</p> 	<p>ZCXK-B-109 REVO 15 机盖亮条电镀 HOOD STRIP CHROME SIZE: N.W.: G.W.:</p> 
<p>ZCXK-B-109-2 REVO 15 机盖亮条黑色 HOOD STRIP BLACK SIZE: N.W.: G.W.:</p> 	<p>ZCXK-B-110 REVO 15 机盖亮条底座 REVO 15 HOOD STRIP HOUSING SIZE: N.W.: G.W.:</p> 
<p>ZCXK-B-111 REVO 15 挡泥板 REVO 15 MUD GUARD 4WD SIZE:64x42x37CM/10SET 76622-0K140 76621-0K140 76626-0K270 76625-0K270</p> 	<p>ZCXK-B-111-2 REVO 15 挡泥板 REVO 15 MUD GUARD 2WD SIZE:64x42x37CM/10SET 76622-0K140 76621-0K140 76626-0K240 76625-0K240</p> 
<p>ZCXK-B-111-3 REVO 15 挡泥板2门版 REVO 15 MUD GUARD 2 DOORS 76622-0K130 76621-0K130 76626-0K250 76625-0K250</p> 	<p>ZCXK-B-112 REVO 15 水箱盖板 REVO 15 UPPER PLASTIC COVER OF RADIATOR SIZE: N.W.: G.W.:</p> 
<p>ZCXK-B-113 REVO 15 喷水壶 REVO 15 WIPER TANK SIZE:60x46.5x48CM/10SET N.W.: G.W.:</p> 	<p>ZCXK-B-113-2 REVO 15 水壺(带电机) REVO 15 WIPER TANK WITH MOTOR SIZE: N.W.: G.W.:</p> 

丰田海拉克斯VIGO/REVO系列 TOYOTA HILUX VIGO/REVO



<p>ZCXXK-B-114 REVO 15 水壶柴油 REVO 15 WATER TANK DIESEL SIZE:99x45x48CM/20PCS N.W.: G.W.:</p> 	<p>ZCXXK-B-114-2 REVO 15 水壶汽油 REVO 15 WATER TANK PETROL SIZE:76.5x32.5x37.5CM/30PCS N.W.: G.W.:</p> 	<p>ZCXXK-B-115 REVO 15 脚踏板 REVO 15 FOOT STEP SIZE:215x21x21CM/1SET N.W.: G.W.:</p> 	
<p>ZCXXK-B-116 REVO 15 护杠黑色 REVO 15 OVER BUMPER BLACK SIZE:136x25x48CM/2PCS N.W.: G.W.:</p> 		<p>ZCXXK-B-116-2 REVO 15 护杠白以 REVO 15 OVER BUMPER WHITE SIZE:136x25x48CM/2PCS N.W.: G.W.:</p> 	
<p>ZCXXK-B-117 REVO 15 翼子板铁支架 REVO 15 METAL SUPPORT OF FENDER SIZE: N.W.: G.W.:</p> 	<p>ZCXXK-B-118 REVO 15 前保险杠铁骨架 REVO 15 INNER IRON BUMPER OF FRONT BUMPER SIZE: N.W.: G.W.:</p> 		
<p>ZCXXK-B-119 REVO 15 发动机铁护板前 REVO 15 ENGINE PROTECTION METAL BOARD FRONT SIZE: N.W.: G.W.:</p> 	<p>ZCXXK-B-119-2 REVO 15 发动机铁护板前TRD 2015- REVO ENGINE PROTECTION BOARD TRD</p>  		
<p>ZCXXK-B-120 REVO 15 发动机铁护板后 REVO 15 ENGINE PROTECTION METAL BOARD REAR SIZE: N.W.: G.W.:</p> 	<p>ZCXXK-B-121 REVO 15 机盖通风罩 REVO 15 HOOD COVER SIZE: N.W.: G.W.:</p> 		

丰田海拉克斯VIGO/REVO系列 TOYOTA HILUX VIGO/REVO



<p>ZCXK-B-122 REVO 15 风扇叶(柴油) REVO 15 FAN (DIESEL) SIZE:82x45x44CM/20PCS N.W.: G.W.:</p> 	<p>ZCXK-B-123 REVO 15 风扇叶 (汽油) REVO 15 FAN (PETROL) SIZE: N.W.: G.W.:</p> 
<p>ZCXK-B-124 REVO 15 轮胎帽 REVO 15 TIRE CAP SIZE: N.W.: G.W.:</p> 	<p>ZCXK-B-125 REVO 15 轮眉 REVO 15 EYEBROW SIZE: N.W.: G.W.:</p> 
<p>ZCXK-B-125-2 REVO 15 轮眉 2015-REVO FENDER FLARE MODIFIED</p> 	<p>ZCXK-B-126 REVO 15 水箱塑料支架 REVO 15 RADIATOR PLASTIC SUPPORT SIZE: N.W.: G.W.:</p> 
<p>ZCXK-B-127 REVO 15 冷凝器塑料支架 REVO 15 COOLANT PLASTIC SUPPORT SIZE: N.W.: G.W.:</p> 	<p>ZCXK-B-128 REVO 15 机盖 REVO 15 HOOD SIZE: N.W.: G.W.:</p> 
<p>ZCXK-B-129 REVO 15 翼子板 REVO 15 FENDER 4WD SIZE: N.W.: G.W.:</p> 	<p>ZCXK-B-129-2 REVO 15 翼子板带边灯孔 REVO 15 FENDER WITH SIDE LAMP HOLE 2WD SIZE: N.W.: G.W.:</p> 

丰田海拉克斯VIGO/REVO系列 TOYOTA HILUX VIGO/REVO



<p>ZCXX-B-130 REVO 15 车门 REVO 15 DOOR SIZE: N.W.: G.W.:</p> 	<p>ZCXX-B-130-2 REVO 15 后车门 2015- REVO REAR DOOR</p> 
<p>ZCXX-B-131 REVO 15 尾门 (泰国) REVO 15 TAIL GATE (THAILAND) SIZE: N.W.: G.W.:</p> 	<p>ZCXX-B-131-2 REVO 15 尾门 (中东) REVO 15 TAIL GATE (MID ASIA) SIZE: N.W.: G.W.:</p> 
<p>ZCXX-B-132 REVO 15 水箱框架 REVO 15 RADIATOR SUPPORT SIZE: N.W.: G.W.:</p> 	<p>ZCXX-B-133 REVO 15 前杠铁包角 (中东) REVO 15 FRONT BUMPER METAL CORNER SIZE: N.W.: G.W.:</p> 
<p>ZCXX-B-133-2 REVO 15 前杠上塑料杠 (中东) REVO 15 FRONT BUMPER UPPER PLASTIC BUMPER SIZE: N.W.: G.W.:</p> 	<p>ZCXX-B-133-3 A REVO 15 前杠网格 (中东) 2驱 HILUX REVO 2015- MID ASIA FRONT BUMPER GRILLE 2WD 53901-0K010 53901-0K020</p> 
<p>ZCXX-B-133-3 B REVO 15 前杠网格 (中东) 4驱 HILUX REVO FRONT BUMPER GRILLE (MID ASIA) 4WD</p> 	<p>ZCXX-B-133-4 REVO 15 前杠下铁面板 (中东) REVO 15 FRONT BUMPER UNDER METAL BOARD SIZE: N.W.: G.W.:</p> 

丰田海拉克斯VIGO/REVO系列 TOYOTA HILUX VIGO/REVO



<p>ZCXK-B-134 REVO 15 雾灯罩 高配 (中东) REVO 15 FOG LAMP COVER (MID ASIA) SIZE: N.W.: G.W.:</p> 	<p>ZCXK-B-134-2 REVO 15 雾灯罩 低配 (中东) REVO 15 FOG LAMP COVER (MID ASIA) SIZE: N.W.: G.W.:</p> 
<p>ZCXK-B-135 REVO 15前叶子板内衬(泰国版) FRONT INNER LINING OF FENDER THAILAND SIZE: N.W.: G.W.:</p> 	<p>ZCXK-B-135-2 REVO 15前叶子板内衬(中东版) FRONT INNER LINING OF FENDER MID ASIA SIZE: N.W.: G.W.:</p> 
<p>ZCXK-B-135-3 REVO 15前叶子板小内衬(中东版) SMALL FRONT INNER LINING OF FENDER MID ASIA SIZE: N.W.: G.W.:</p> 	<p>ZCXK-B-136 REVO 15后叶子板内衬 REAR INNER LINING OF FENDER SIZE: N.W.: G.W.:</p> 
<p>ZCXK-B-136-2 REVO 15后叶子板小内衬 SMALL REAR INNER LINING OF FENDER SIZE: N.W.: G.W.:</p> 	<p>ZCXK-B-137 REVO 15 行李架 REVO 15 ROOF RACK SIZE: N.W.: G.W.:</p> 
<p>ZCXK-B-138 REVO 15门板 REVO 15 DOOR BOARD SIZE: N.W.: G.W.:</p> 	<p>ZCXK-B-139 REVO 15中东版前杠铁框架 REVO 15 FRONT BUMPER REINFORCEMENT UPPER FRAME MID ASIA SIZE: N.W.: G.W.:</p> 

丰田海拉克斯VIGO/REVO系列 TOYOTA HILUX VIGO/REVO



<p>ZCXX-B-139-2 铁框架紧固件 REINFORCEMENT FRAME SUPPORT</p>  	<p>ZCXX-B-139-3 铁框架紧固件支架A FRAME SUPPORT BRACKET A</p>  
<p>ZCXX-B-139-4 铁框架紧固件支架B FRAME SUPPORT BRACKET B</p>  	<p>ZCXX-B-139-5 铁框架内叶子板支架B REVO INNER LINING OF FENDER METAL SUPPORT</p>  
<p>ZCXX-B-140 REVO 15外门拉手电镀 REVO 15 OUT HANDLE CHROME</p> 	<p>ZCXX-B-140-2 REVO 15外门拉手黑色 REVO 15 OUT HANDLE BLACK</p> 
<p>ZCXX-B-141 REVO 15油壶 REVO 15 POWER OIL TANK</p> 	<p>ZCXX-B-142 REVO 15外门拉手电镀框 REVO 15 DOOR HANDLE FRAME</p>  
<p>ZCXX-B-143 REVO 15前杠网格电镀件 REVO 15 BUMPER GRILLE CHROME STRIP</p>  	<p>ZCXX-B-144 REVO 15雾灯电镀框 REVO 15 FOG LAMP COVER CHROME FRAME</p>  

丰田海拉克斯VIGO/REVO系列 TOYOTA HILUX VIGO/REVO



<p>ZCXX-B-145 REVO 15机盖电镀件 REVO 15 HOOD CHROME STRIP</p>  	<p>ZCXX-B-146 REVO 15大灯电镀件 REVO 15 HEAD LAMP CHROME COVER</p>  
<p>ZCXX-B-147 REVO 15尾门电镀件 REVO 15 TAIL GATE STRIP</p>  	<p>ZCXX-B-148 REVO 15翼子板电镀件 REVO 15 FENDER COVER</p>  
<p>ZCXX-B-149 REVO 15尾灯电镀件 REVO 15 TAIL LAMP COVER</p>  	<p>ZCXX-B-150 REVO 15尾雾灯框电镀件 REVO 15 FOG LAMP COVER CHROME STRIP</p>  
<p>ZCXX-B-151 REVO 15牌照灯 REVO 15 LICENCE LAMP</p> 	<p>ZCXX-B-152 REVO 15边灯 REVO 15 SIDE LAMP</p> 
<p>ZCXX-B-153 REVO 轮胎螺丝防护罩 REVO TIRE SCREW PROTECTION COVER</p>  	<p>KX-B-154 HILUX REVO 18 ROCCO 中网(电镀) HILUX REVO 18 ROCCO GRILLE(CHROME)</p> 

丰田海拉克斯VIGO/REVO系列 TOYOTA HILUX VIGO/REVO



<p>KX-B-154-2 HILUX REVO 18 ROCCO 中网(灰) HILUX REVO 18 ROCCO GRILLE (GREY)</p> 	<p>KX-B-154-3 HILUX REVO 18 ROCCO 中网(黑) HILUX REVO 18 ROCCO GRILLE (BLACK)</p> 
<p>ZCXK-B-154-4 A 18 ROCCO TRD黑中网 18 ROCCO TRD GRILLE BLACK</p>   	<p>ZCXK-B-154-4 B 18 ROCCO TRD电镀中网 18 ROCCO TRD GRILLE CHROME</p>   
<p>ZCXK-B-154-5 18 ROCCO 中网 18 ROCCO MODIFIED GRILLE</p> 	<p>ZCXK-B-154-6 18 ROCCO 中网 18 ROCCO MODIFIED GRILLE</p> 
<p>ZCXK-B-154-7 18 ROCCO 中网 18 ROCCO MODIFIED GRILLE</p> 	<p>KX-B-155 HILUX REVO 18 ROCCO 前保险杠 HILUX REVO 18 ROCCO FRONT BUMPER</p> 
<p>KX-B-156 HILUX REVO 18 ROCCO 前杠网格 HILUX REVO 18 ROCCO FRONT BUMPER GRILLE</p> 	<p>ZCXK-B-157 18 ROCCO 雾灯 18 ROCCO FOG LAMP</p> 



丰田海拉克斯VIGO/REVO系列 TOYOTA HILUX VIGO/REVO

<p>KX-B-158 HILUX REVO 18 ROCCO 雾灯框 HILUX REVO 18 ROCCO FOG LAMP COVER</p> 	<p>ZCXK-B-158-2 18 ROCCO 雾灯框LED 18 ROCCO FOG LAMP COVER LED</p>  
<p>ZCXK-B-158-3 18 ROCCO TRD 雾灯框 18 ROCCO TRD FOG LAMP COVER</p> 	<p>KX-B-159 HILUX REVO 18 ROCCO 前护板 HILUX REVO 18 ROCCO FRONT BUMPER BOARD</p> 
<p>ZCXK-B-159-2 18 ROCCO TRD 保险杠护板 2018 ROCCO BUMPER COVER TRD TYPE</p> 	<p>ZCXK-B-160 18 ROCCO 机盖锁铁支架 HILUX REVO HOOD LOCK BRACKET</p>  
<p>KX-B-161 HILUX REVO 机盖装饰罩 HILUX REVO HOOD COVER</p>  	<p>ZCXK-B-162 2015- REVO 后车厢盖 2015- REVO TAIL BODY ELECTRIC COVER</p>  
<p>ZCXK-B-163 2015-2017 REVO 前杠TRD护板 2015-2017 REVO BUMPER COVER TRD</p>  	<p>ZCXK-B-164 2018 ROCCO 前杠 2018 ROCCO FRONT BUMPER TRD</p> 

丰田海拉克斯VIGO/REVO系列 TOYOTA HILUX VIGO/REVO



<p>ZCXXK-B-165 REVO机盖铰链 REVO HOOD HINGE</p> 	<p>ZCXXK-B-166 REVO尾门流光灯 REVO TAIL GATE MOVABLE LAMP</p>  
<p>ZCXXK-B-167 15 REVO门饰板 15 REVO DOOR COVER</p> 	<p>ZCXXK-B-168 15 REVO翼子板护罩 15 REVO FENDER COVER</p>  
<p>ZCXXK-B-169 15 REVO脚踏板 15 REVO TRD FOOT STEP</p> 	<p>ZCXXK-B-170 A 2021 REVO 左驾高配原装款大灯 2021 REVO HEAD LAMP HIGH LEVEL LEFT HAND DRIVE ORIGINAL TYPE</p>  
<p>ZCXXK-B-170 B 2021 REVO 右驾高配原装款大灯 2021 REVO HEAD LAMP HIGH LEVEL RIGHT HAND DRIVE ORIGINAL TYPE</p>  	<p>ZCXXK-B-170 C 2021 REVO 低升高版大灯左驾 2021 REVO UPGRADE TYPE HEAD LAMP LEFT HAND DRIVE</p>  
<p>ZCXXK-B-170 D 2021 REVO 低升高版大灯右驾 2021 REVO UPGRADE TYPE HEAD LAMP RIGHT HAND DRIVE</p>  	<p>ZCXXK-B-170 E 2021 REVO 左驾高配原装款大灯带日行灯 2021 REVO HEAD LAMP HIGH LEVEL LEFT HAND DRIVE ORIGINAL TYPE</p>  

丰田海拉克斯VIGO/REVO系列 TOYOTA HILUX VIGO/REVO



ZCXX-B-170 F

2021 REVO 右驾高配原装款大灯带日行灯
2021 REVO HEAD LAMP HIGH LEVEL RIGHT HAND DRIVE ORIGINAL TYPE WITH DRL



ZCXX-B-170 G

2021 REVO 低升高版大灯左驾带日行灯
2021 REVO UPGRADE TYPE HEAD LAMP LEFT HAND DRIVE WITH DRL



ZCXX-B-170 H

2021 REVO 低升高版大灯右驾带日行灯
2021 REVO UPGRADE TYPE HEAD LAMP RIGHT HAND DRIVE WITH DRL



ZCXX-B-170-2 A

2021 低配左驾大灯
2021 REVO HEAD LAMP LOW LEVEL LEFT HAND DRIVE



ZCXX-B-170-2 B

2021 低配右驾大灯
2021 REVO HEAD LAMP LOW LEVEL RIGHT HAND DRIVE



ZCXX-B-171

2021 尾灯
2021 REVO TAIL LAMP



ZCXX-B-171-2

2021 尾灯烟灰色
2021 REVO TAIL LAMP SMOKE

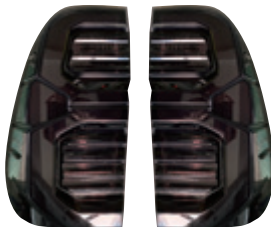

ZCXX-B-172 A

2021 REVO 中网电镀加高光黑
2021 REVO GRILLE CHROME AND GLOSS BLACK



ZCXX-B-172 B

2021 REVO 中网黑色
2021 REVO GRILLE BLACK

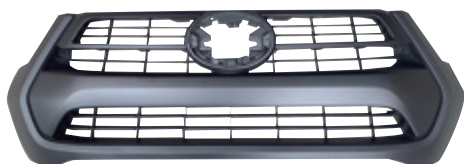

ZCXX-B-172 C

2021 REVO 中网电镀加普通黑色
2021 REVO GRILLE CHROME AND PAINTING BLACK



丰田海拉克斯VIGO/REVO系列 TOYOTA HILUX VIGO/REVO



ZCXK-B-172-2
2021 REVO 中网中东版
2021 REVO GRILLE MID ASIA



ZCXK-B-172-3
2021 ROCCO中网
2021 ROCCO GRILLE



ZCXK-B-172-4
2021 REVO 改装中网
2021 REVO MODIFIED GRILLE



ZCXK-B-172-5
2021 REVO改装中网
2021 REVO MODIFIED GRILLE



ZCXK-B-172-6
2021 REVO 改装中网
2021 REVO MODIFIED GRILLE



ZCXK-B-173
2021 REVO前杠
2021 REVO FRONT BUMPER



ZCXK-B-173-2
2021 REVO 中东版前杠
2021 REVO FRONT BUMPER MID ASIA TYPE



ZCXK-B-173-3
2021 ROCCO 前杠
2021 ROCCO FRONT BUMPER



ZCXK-B-174
2021 REVO 前杠网格
2021 REVO FRONT BUMPER GRILLE



ZCXK-B-175
2021 REVO雾灯带雾灯框 高配
2021 REVO FOG LAMP WITH COVER HIGH LEVEL



丰田海拉克斯VIGO/REVO系列 TOYOTA HILUX VIGO/REVO



<p>ZCXK-B-175-2 2021 REVO 雾灯框低配 2021 REVO FOG LAMP COVER LOW LEVEL</p> 	<p>ZCXK-B-175-3 2021 ROCCO 雾灯带雾灯框 2021 ROCCO FOG LAMP WITH COVER</p> 
<p>ZCXK-B-176 2021 REVO 机盖亮条电镀 2021 REVO HOOD STRIP CHROME</p> 	<p>ZCXK-B-176-2 2021 REVO 机盖亮条黑色 2021 REVO HOOD STRIP BLACK</p> 
<p>ZCXK-B-176-3 2021 REVO 机盖亮条底座 2021 REVO HOOD STRIP HOUSING</p> 	<p>ZCXK-B-177 2021 REVO 水箱盖板 2021 REVO UPPER PLASTIC COVER OF RADIATOR</p> 
<p>ZCXK-B-178 2021 ROCCO 前杠护板 2021 ROCCO FRONT BUMPER BOARD</p> 	<p>ZCXK-B-178-2 2021 ROCCO 前杠护板网格 2021 ROCCO FRONT BUMPER BOARD GRILLE</p> 
<p>ZCXK-B-178-3 2021 ROCCO 前杠护板盖板 2021 ROCCO FRONT BUMPER BOARD COVER</p> 	<p>ZCXK-B-179 2021 ROCCO 轮眉 2021 ROCCO FENDER FLARE</p> 

丰田海拉克斯VIGO/REVO系列 TOYOTA HILUX VIGO/REVO



ZCXXK-B-179-2
2021 REVO轮眉
2021 REVO FENDER FLARE



ZCXXK-B-180
2021 REVO前杠支架
21 REVO FRONT BUMPER BRACKET



ZCXXK-B-181
2021 REVO尾门把手框
2021 REVO TAIL GATE HANDLE COVER



ZCXXK-B-182
2015 REVO双排车顶
2015 REVO DOUBLE CABIN ROOF



ZCXXK-B-183
2015 REVO双排侧围
2015 REVO DOUBLE CABIN PILLAR



ZCXXK-B-184
2015 REVO双排后翼子板
2015 REVO DOUBLE CABIN REAR FENDER



ZCXXK-B-184-2
2015 REVO单排后翼子板
2015 REVO SINGLE CABIN REAR FENDER



ZCXXK-B-185
REVO 5L 风扇罩
REVO 5L FAN SHROUD



ZCXXK-B-186
2021 ROCCO GR中网
2021 ROCCO GR GRILLE



ZCXXK-B-187
2021 ROCCO GR 前杠护板
2021 ROCCO GR FRONT BUMPER BOARD





丰田海拉克斯VIGO/REVO系列 TOYOTA HILUX VIGO/REVO

ZCXK-B-188
 2022 ROCCO GR 雾灯框
 2022 ROCCO GR FOG LAMP COVER



2005 → 2014



丰田海拉克斯VIGO/REVO系列 TOYOTA HILUX VIGO/REVO



2012 VIGO → 2021 ROCCO



丰田海拉克斯HILUX系列 TOYOTA 2020 HILUX



2012 VIGO → 2021 REVO



丰田海拉克斯HILUX系列 TOYOTA 2020 HILUX



2015 REVO → 2021 ROCCO

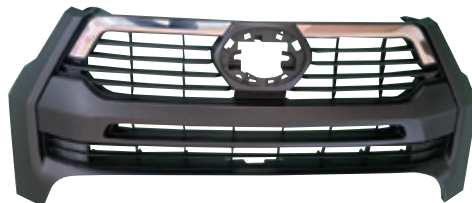

丰田海拉克斯HILUX系列 TOYOTA 2020 HILUX



2015 REVO → 2021 REVO

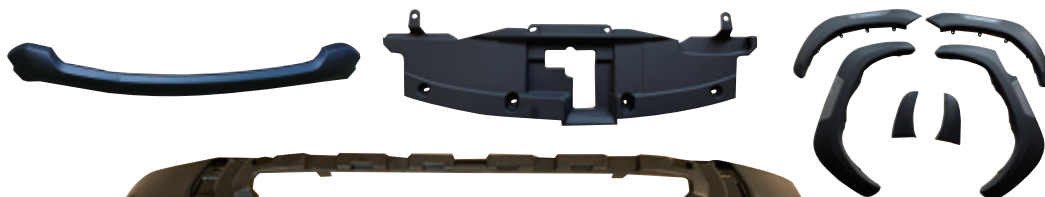

丰田海拉克斯HILUX系列 TOYOTA 2020 HILUX



2015 REVO MID ASIA → 2021 REVO MID ASIA





2015 REVO CHANGE TO 2021 REVO MID ASIA TYPE

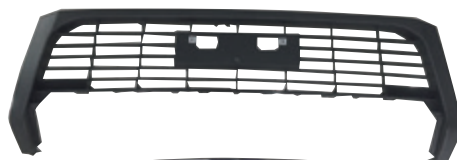

丰田FORTUNER/SW4系列FORTUNER/SW4



<p>ZCXK-FT-12-001 2021前大灯 12 FORTUNER HEAD LAMP</p> 	<p>ZCXK-FT-12-002 A 2021 外尾灯 12 OUTER LAMP</p> 
<p>ZCXK-FT-12-002 B 12内尾灯 12 INNER LAMP</p> 	<p>ZCXK-FT-12-003 12 中网 12 GRILLE</p> 
<p>ZCXK-FT-12-004 12脚踏板 12 FOOT STEP</p> 	<p>ZCXK-FT-12-005 12 轮眉 12 EYEBROW</p> 
<p>ZCXK-FT-12-006 12挡泥板 12 MUD GUARD</p> 	<p>ZCXK-FT-12-007 12 行李架 12 ROOF RACK</p> 
<p>ZCXK-FT-12-008 12前保险杠支架 12 FRONT BUMPER BRACKET</p> 	<p>ZCXK-FT-12-009 12 后杠支架 12 12 REAR BUMPER BRACKET</p> 

丰田FORTUNER/SW4系列FORTUNER/SW4



<p>ZCXX-FT-12-010 12尾门饰条 12 TAIL DOOR STRIP</p> 	<p>ZCXX-FT-12-011 12 前翼子板内衬 12 FRONT INNER LINING</p> 
<p>ZCXX-F-001 16前大灯 16 HEAD LAMP HIGH LEVEL</p> 	<p>ZCXX-F-002 16尾灯 16 TAIL LAMP</p> 
<p>ZCXX-F-002-A 16外尾灯 16 OUTER LAMP</p> 	<p>ZCXX-F-002-B 16内尾灯 16 INNER LAMP</p> 
<p>ZCXX-F-003 16前保险杠 16 FRONT BUMPER</p> 	<p>ZCXX-F-004 16中网 16 GRILLE</p> 
<p>ZCXX-F-004-2 2016 中网 2016 FORTUNER GRILLE WAVE TYPE</p> 	<p>ZCXX-F-004-3 16中网 2016 FORTUNER GRILLE WITH DRL</p> 

丰田FORTUNER/SW4系列FORTUNER/SW4



<p>ZCXXK-F-004-3 2016 中网 2016 FORTUNER GRILLE WITH LED</p> 	<p>ZCXXK-F-004-4 2016 中网 2016 FORTUNER GRILLE TOYO TYPE</p> 
<p>ZCXXK-F-004-5 2016 中网 2016 FORTUNER GRILLE BIG TRD TYPE</p> 	<p>ZCXXK-F-004-6 2016 中网 2016 FORTUNER SMALL TRD TYPE</p> 
<p>ZCXXK-F-004-7 2016 中网 2016 FORTUNER CHROME TYPE</p> 	<p>ZCXXK-F-005 16倒车镜 16 MIRROR</p> 
<p>ZCXXK-F-006 16后杠 16 REAR BUMPER</p> 	<p>ZCXXK-F-007 16尾门饰条 16 TAIL GATE CHROME</p> 
<p>ZCXXK-F-008 16网格 16 FRONT BUMPER GRILLE</p> 	<p>ZCXXK-F-009 16后雾灯 16 REAR FOG LAMP</p> 

丰田FORTUNER/SW4系列FORTUNER/SW4



<p>ZCXX-F-009-2 16后雾灯 16 REAR FOG LAMP</p>  	<p>ZCXX-F-010 16挡泥板 16 MUDGUARD</p> 
<p>ZCXX-F-011 16雾灯框 16 FORTUNER FOG LAMP COVER</p> 	<p>ZCXX-F-011-2 16雾灯框 LED 2016 FORTUNER LED FOG LAMP COVER LED</p>  
<p>ZCXX-F-012 16高位刹车灯 16 HIGH BRAKE LAMP</p> 	<p>ZCXX-F-013 16雾灯 16 FOG LAMP</p> 
<p>ZCXX-F-014 16风扇罩柴油版/汽油版 16 FAN SHROUD DIESEL/PETROL</p>  <p style="display: flex; justify-content: space-around;"> DIESEL PETROL </p>	<p>ZCXX-F-015 16空滤柴油版/汽油版 16 AIR FILTER DIESEL/PETROL</p>  <p style="display: flex; justify-content: space-around;"> DIESEL PETROL </p>
<p>ZCXX-F-016 16水壶柴油版 16 WATER TANK DIESEL</p>  <p>ZCXX-F-017 16喷水壶 16 WIPER TANK</p> 	<p>ZCXX-F-018 16前杠支架 FRONT BUMPER SUPPORT</p> 

丰田FORTUNER/SW4系列FORTUNER/SW4



<p>ZCXX-F-018-2 16后杠支架 2016 FORTUNER REAR BUMPER BRACKET</p> 	<p>ZCXX-F-019 轮胎帽 TIRE CAP</p> 
<p>ZCXX-F-020 尾翼 EMPENNAGE</p> 	<p>ZCXX-F-021 2016 FORTUNER杠护板 2016 FORTUNER OVER BUMPER</p> 
<p>ZCXX-F-022 护杠 2016 FORTUNER BUMPER BOARD</p> 	<p>ZCXX-F-023 2016 FORTUNER尾门饰条 2016 FORTUNER TAIL GATE DECORATION BOARD</p> 
<p>ZCXX-F-024 2016 FORTUNER后杠饰条 2016 FORTUNER REAR BUMPER DECORATION BOARD</p> 	<p>ZCXX-F-025 2016 FORTUNER车门护板 2016 FORTUNER DOOR DECORATION BOARD</p> 
<p>ZCXX-F-026 2016 FORTUNER后立柱灯 2016 FORTUNER TAIL PILLAR LAMP</p> 	<p>ZCXX-F-027 2016 FORTUNER前车门 2016 FORTUNER FRONT DOOR</p> 

丰田FORTUNER/SW4系列FORTUNER/SW4



<p>ZCXK-F-028 2016 FORTUNER后车门 2016 FORTUNER REAR DOOR</p> 	<p>ZCXK-F-029 2016 FORTUNER后背门 2016 FORTUNER TAIL GATE</p> 
<p>ZCXK-F-030 2016 FORTUNER叶子板 2016 FORTUNER FENDER</p> 	<p>ZCXK-F-031 2016 FORTUNER发动机铁护板 2016 FORTUNER FRONT TRD METAL BOARD</p> 
<p>ZCXK-F-032 2016 FORTUNER TRD 雾灯框 2016 FORTUNER TRD FOG LAMP COVER</p>  	<p>ZCXK-F-033 2016 FORTUNER大包围 2016 FORTUNER TRD BODY KIT</p>  
<p>ZCXK-F-034 2016 FORTUNER LEXUS 大包围 2016 FORTUNER LEXUS TYPE BODY KIT</p>  	<p>ZCXK-F-035 尾灯烟灰色 TAIL LAMP SMOKE</p> 
<p>ZCXK-F-035-A 尾灯烟灰色内 16 INNER TAIL LAMP SMOKE</p>  	<p>ZCXK-F-035-B 尾灯烟灰色外 OUTER TAIL LAMP SMOKE</p>  

丰田FORTUNER/SW4系列FORTUNER/SW4



<p>ZCXX-F-036 2016 FORTUNER 轮眉 2016 FORTUNER FENDER FLARE</p> 	<p>ZCXX-F-037 2021 大灯 21 FORTUNER HEAD LAMP</p> 
<p>ZCXX-F-037-2 2021 大灯 2021 LEGENDER HEAD LAMP</p> 	<p>ZCXX-F-038-A 2021 内尾灯 2021 INNER TAIL LAMP</p> 
<p>ZCXX-F-038-B 2021 外尾灯 2021 OUTER TAIL LAMP</p> 	<p>ZCXX-F-039 2021 中网 2021 FORTUNER GRILLE</p> 
<p>ZCXX-F-039-2 2021 中网 2021 LEGENDER GRILLE</p> 	<p>ZCXX-F-040 2021 雾灯框 2021 FORTUNER FOG LAMP COVER</p> 
<p>ZCXX-F-040-2 2021 雾灯框 2021 LEGENDER FOG LAMP COVER</p> 	<p>ZCXX-F-041 2021 前杠 2021 FORTUNER FRONT BUMPER</p> 





丰田FORTUNER/SW4系列FORTUNER/SW4



<p>ZCXK-F-041-2 2021 前杠 2021 FORTUNER LEGENDER FRONT BUMPER</p> 	<p>ZCXK-F-041-3 A 2021 后杠 2021 FORTUNER LEGENDER REAR BUMPER</p> 
<p>ZCXK-F-041-3 B 2021 后杠小 2021 FORTUNER LEGENDER REAR SMALL BUMPER</p> 	<p>ZCXK-F-041-3 C 2021 后杠小盖板 2021 FORTUNER LEGENDER REAR BUMPER SMALL COVER</p> 
<p>ZCXK-F-042 2021 前杠杠网 2021 FORTUNER LEGENDER FRONT BUMPER GRILLE</p> 	<p>ZCXK-F-043 2021 前杠护板 2021 FORTUNER LEGENDER FRONT BUMPER BOARD</p> 
<p>ZCXK-F-043-2 2021 前杠护板 2021 FORTUNER LEGENDER FRONT BUMPER BOARD</p> 	<p>ZCXK-F-044 2021 大灯电镀装饰条 2021 FORTUNER HEAD LAMP CHROME STRIP</p> 
<p>ZCXK-F-044-2 2021 大灯黑色装饰条 2021 FORTUNER LEGENDER HEAD LAMP BLACK STRIP</p> 	<p>ZCXK-F-045 2016前轮眉 2016 FORTUNER FRONT BUMPER FLARE</p> 

丰田FORTUNER/SW4系列FORTUNER/SW4



<p>ZCXX-F-045-2 2021 前轮眉 2021 FORTUNER LEGENDER FRONT BUMPER FLARE</p> 	<p>ZCXX-F-046 2021 前轮眉 2021 FORTUNER FRONT BUMPER FLARE</p> 
<p>ZCXX-F-046-2 2021 后轮眉 2021 FORTUNER LEGENDER REAR BUMPER FLARE</p> 	<p>ZCXX-F-047 2021 日行灯 2021 FORTUNER DRL LAMP</p> 
<p>ZCXX-F-048 2021 雾灯 2021 FOG LAMP</p> 	



丰田FORTUNER/SW4系列FORTUNER/SW4





丰田FORTUNER/SW4系列FORTUNER/SW4

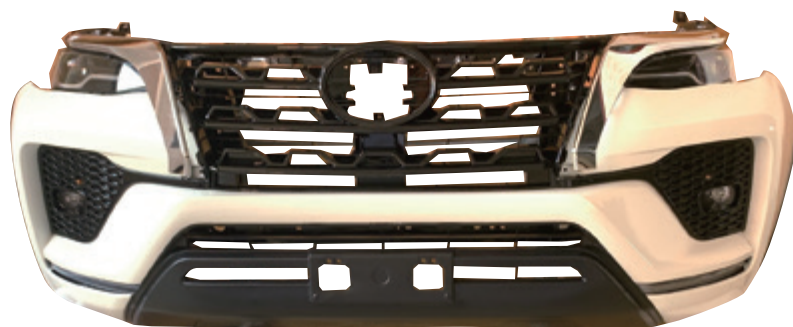

三菱L200系列 MITSUBISHI L200



<p>ZCXK-C-001 L200大灯(黄) L200 HEAD LAMP (YELLOW) SIZE:59.5x48x46.5CM/4PCS N.W.: 6.5KG G.W.:8KG</p> 	<p>ZCXK-C-001-2 L200大灯(白) L200 HEAD LAMP (WHITE) SIZE:59.5x48x46.5CM/4PCS N.W.: 6.5KG G.W.:8KG</p> 
<p>ZCXK-C-002 L200尾灯(红) L200 TAIL LAMP (RED) SIZE:65x29.5x62CM/10PCS N.W.: 6KG G.W.:7KG</p> 	<p>ZCXK-C-002-2 L200尾灯(烟灰色) L200 TAIL LAMP (SMOKE) SIZE:65x29.5x62CM/10PCS N.W.: 6KG G.W.:7KG</p> 
<p>ZCXK-C-003 L200车镜(电镀) L200 MIRROR(CHROME) SIZE:72.5x44x45.5CM/8PCS N.W.: 14.5KG G.W.:15.5KG</p> 	<p>ZCXK-C-004 L200尾门把手总成 L200 TAIL GATE HANDLE SIZE: N.W.: G.W.:</p> 
<p>ZCXK-C-005 L200高位刹车灯 L200 HIGH BRAKE LIGHT SIZE:53x47x41CM/100PCS N.W.: G.W.:</p> 	<p>ZCXK-C-006 L200尾门把手框 L200 TAIL GATE HANDLE BOX SIZE: N.W.: G.W.:</p> 
<p>ZCXK-C-007 L200内门扣手 L200 INNER DOOR HANDLE SIZE: N.W.: G.W.:</p> 	<p>ZCXK-C-008 L200轮胎帽 L200 TIRE CAP SIZE: N.W.: G.W.:</p> 

三菱L200系列 MITSUBISHI L200



<p>ZCXK-C-009 L200 10 前保险杠 L200 10 FRONT BUMPER SIZE: N.W.: G.W.:</p> 	<p>ZCXK-C-010 L200 10 中网 黑色 L200 10 BLACK GRILLE SIZE:106x35x42CM/8PCS N.W.: 11KGS G.W.:12KGS</p> 
<p>ZCXK-C-010-2 L200 10中网 电镀 L200 10 CHROME GRILLE SIZE:106x35x42CM/8PCS N.W.: 11KGS G.W.:12KGS</p> 	<p>ZCXK-C-011 2007-2014机盖 2007-2014 HOOD</p> 
<p>ZCXK-C-012 L200 10雾灯 L200 10 FOG LAMP SIZE:52x46.5x40CM/10SET N.W.: 7KGS G.W.:8KGS</p> 	<p>ZCXK-C-012-2 L200 10雾灯 LED L200 10 FOG LAMP LED</p> 
<p>ZCXK-C-013 L200 后反射灯 L200 REFLECTION LIGHT SIZE: N.W.: G.W.:</p> 	<p>ZCXK-C-014 L200 两门大灯 L200 SINGLE CAB HEAD LAMP SIZE: N.W.: G.W.:</p> 
<p>ZCXK-C-015 L200 05 半电镀中网 L200 05 HALF CHROME GRILLE SIZE:54x35x53CM/20SET N.W.: 10KGS G.W.:11KGS</p> 	<p>ZCXK-C-015-2 L200 05 全电镀中网 L200 05 CHROME GRILLE SIZE:54x35x53CM/20SET N.W.: 10KGS G.W.:11KGS</p> 

三菱L200系列 MITSUBISHI L200

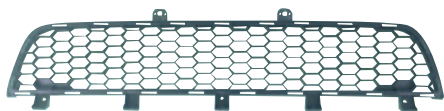

<p>ZCXK-C-015-3 L200 05 黑色中网 L200 05 BLACK GRILLE SIZE:54x35x53CM/20SET N.W.: 10KGS G.W.:11KGS</p> 	<p>ZCXK-C-016 L200保险杠支架 L200 BUMPER SUPPORT SIZE: N.W.: G.W.:</p> 
<p>ZCXK-C-017 L200 风扇罩 L200 FAN SHROUD SIZE: N.W.: G.W.:</p> 	<p>ZCXK-C-018 L200后杠 L200 REAR BUMPER SIZE:133x18.5x15.5CM/1PCS N.W.: 8KGS G.W.:9KGS</p> 
<p>ZCXK-C-019 L200 喷水壶 L200 WIPER TANK SIZE: N.W.: G.W.:</p> 	<p>ZCXK-C-020 L200 付水壶 L200 RADIATOR TANK SIZE: N.W.: G.W.:</p> 
<p>ZCXK-C-021 L200空滤 L200 AIR FILTER SIZE: N.W.: G.W.:</p> 	<p>ZCXK-C-022 L200 挡泥板 L200 MUDGUARD</p>  <p>THAI</p> <p>MID ASIA</p>
<p>ZCXK-C-023 L200 前保险杠网格 L200 FRONT BUMPER GRILLE SIZE:106x36x51CM/30PCS N.W.: 13KGS G.W.:14KGS</p> 	<p>ZCXK-C-024 L200 下中网条 L200 BUMPER GRILLE STRIP SIZE:106x35x43CM/20PCS N.W.: 11KGS G.W.:13.5KGS</p> 

三菱L200系列 MITSUBISHI L200



<p>ZCXXK-C-025 L200 边灯 (黄) L200 SIDE LAMP (YELLOW)</p> 	<p>ZCXXK-C-025-2 L200边灯(白) L200 SIDE LAMP (WHITE)</p> 	<p>ZCXXK-C-026 2005-2014翼子板 2005-2014 FENDER</p> 
<p>ZCXXK-C-027 L200 前护杠 L200 OVERBUMPER SIZE:117x20x42CM/1PCS N.W.: 3.8KGS G.W.:4.8KGS</p> 	<p>ZCXXK-C-028 2005-2014 后翼子板 2005-2014 REAR FENDER</p> 	
<p>ZCXXK-C-029 L200 前翼子板内衬 L200 FRONT INNER LINING OF FENDER SIZE: N.W.: G.W.:</p> 	<p>ZCXXK-C-029-2 L200 中翼子板内衬 L200 MIDDLE INNER LINING OF FENDER SIZE: N.W.: G.W.:</p> 	
<p>ZCXXK-C-030 L200黑色车镜 L200 MIRROR BLACK SIZE: N.W.: G.W.:</p> 	<p>ZCXXK-C-031 L200 前门 L200 FRONT DOOR SIZE: N.W.: G.W.:</p> 	
<p>ZCXXK-C-032 L200 后门 L200 REAR DOOR SIZE: N.W.: G.W.:</p> 	<p>ZCXXK-C-033 L200 15 大灯 L200 15 HEAD LAMP SIZE: N.W.: G.W.:</p> 	

三菱L200系列 MITSUBISHI L200



<p>ZCXK-C-034 L200 15 尾灯 L200 15 TAIL LAMP SIZE: N.W.: G.W.:</p> 	<p>ZCXK-C-035 L200 15 前翼子板小内衬 L200 15 FRONT SMALL INNER LINING OF FENDER</p> 
<p>ZCXK-C-036 L200 15 高位刹车灯 L200 15 HIGH BRAKE LIGHT SIZE: N.W.: G.W.:</p> 	<p>ZCXK-C-037 L200 15 中网 L200 15 GRILLE</p> 
<p>ZCXK-C-038 L200 15 中网 L200 15 GRILLE</p> 	<p>ZCXK-C-039 L200 15 低配大灯浅黄版 L200 15 LOW LEVEL HEAD LAMP LIGHT YELLOW TYPE</p> 
<p>ZCXK-C-039-2 L200 15 低配大灯浓黄版 L200 15 LOW LEVEL HEAD LAMP DARK YELLOW TYPE</p> 	<p>ZCXK-C-040 L200 15 机盖 L200 15 HOOD</p> 
<p>ZCXK-C-041 L200 15 前翼子板大内衬 L200 15 FRONT BIG INNER LINING OF FENDER</p> 	<p>ZCXK-C-042 L200 15 后翼子板 L200 15 REAR FENDER</p> 

三菱L200系列 MITSUBISHI L200



<p>ZCXXK-C-043 L200 15 水壶 L200 15 TANK SIZE: N.W.: G.W.:</p> 	<p>ZCXXK-C-044 L200 15 喷水壶 L200 15 WIPER TANK SIZE: N.W.: G.W.:</p> 	<p>ZCXXK-C-045 19 L200 前杠骨架 19 L200 FRONT BUMPER IRON BUMPER</p>  
<p>ZCXXK-C-046 15 L200 后杠 15 L200 REAR BUMPER</p> 	<p>ZCXXK-C-047 A 2019 L200 高配大灯 左驾 2019 L200 HEAD LAMP HIGH CLASS LEFT HAND DRIVE</p>  	
<p>ZCXXK-C-047 B 2019 L200 高配大灯 右驾 2019 L200 HEAD LAMP HIGH CLASS RIGHT HAND DRIVE</p>  	<p>ZCXXK-C-047 C 2019 L200 高配大灯 左驾 带流光转向 2019 L200 HEAD LAMP HIGH CLASS LEFT HAND DRIVE WITH DRL</p>   	
<p>ZCXXK-C-047 D 2019 L200 高配大灯 右驾 带流光转向 2019 L200 HEAD LAMP HIGH CLASS RIGHT HAND DRIVE WITH DRL</p>   	<p>ZCXXK-C-047-2 2019 L200 低配大灯 2019 L200 HEAD LAMP LOW LEVEL</p> 	
<p>ZCXXK-C-047-3 A 2019 L200 低升高大灯 左驾 2019 L200 HEAD LAMP UPGRADE LEFT HAND DRIVE</p>  	<p>ZCXXK-C-047-3 B 2019 L200 低升高大灯 右驾 2019 L200 HEAD LAMP UPGRADE RIGHT HAND DRIVE</p>  	

三菱L200系列 MITSUBISHI L200



<p>ZCXXK-C-047-3 C 2019 L200 低升高大灯 左驾带流光转向 2019 L200 HEAD LAMP UPGRADE LEFT HAND DRIVE WITH DRL</p>  	<p>ZCXXK-C-047-3 D 2019 L200 低升高大灯 右驾带流光转向 2019 L200 HEAD LAMP UPGRADE RIGHT HAND DRIVE WITH DRL</p>  
<p>ZCXXK-C-048 2019 L200 高配雾灯带转向灯 2019 FOG LAMP WITH TURNING LAMP HIGH CLASS</p> 	<p>ZCXXK-C-048-2 2019 L200 雾灯框带转向灯 2019 FOG LAMP COVER WITH TURNING LIGHT</p> 
<p>ZCXXK-C-048-3 2019 L200 低配雾灯带转向灯 2019 FOG LAMP WITH TURNING LAMP LOW CLASS</p> 	<p>ZCXXK-C-049 A 2019 L200 尾灯高配 2019 L200 TAIL LAMP HIGH CLASS</p>  
<p>ZCXXK-C-049 B 2019 L200 尾灯高配带红雾灯版 2019 L200 TAIL LAMP HIGH CLASS WITH REAR FOG LAMP TYPE</p> 	<p>ZCXXK-C-049-2 A 2019 L200 中东带红雾灯版 尾灯低配 2019 L200 TAIL LAMP LOW CLASS MID ASIA WITH REAR FOG LAMP TYPE</p>  
<p>ZCXXK-C-049-2 B 2019 L200 尾灯低配普通版 2019 L200 TAIL LAMP LOW CLASS NORMAL TYPE</p> 	<p>ZCXXK-C-049-3 A 2019 L200 高配尾灯深灰色 2019 L200 HIGH LEVEL TAIL LAMP DARK SMOKE</p>  

三菱L200系列 MITSUBISHI L200



<p>ZCXXK-C-049-3 B 2019 L200 低配中东版尾灯深灰色 2019 L200 MID ASIA LOW LEVEL TAIL LAMP DARK SMOKE</p> 	<p>ZCXXK-C-049-3 C 2019 L200 低配普通版尾灯深灰色 2019 L200 NORMAL LOW LEVEL TAIL LAMP DARK SMOKE</p> 
<p>ZCXXK-C-049-4 A 2019 L200 高配尾灯 浅灰 2019 L200 HIGH LEVEL TAIL LAMP LIGHT SMOKE</p> 	<p>ZCXXK-C-049-4 B 2019 L200 中东低配尾灯 浅灰 2019 L200 MID ASIA LOW LEVEL TAIL LAMP LIGHT SMOKE</p> 
<p>ZCXXK-C-049-4 C 2019 L200 普通低配尾灯 浅灰 2019 L200 NORMAL LOW LEVEL TAIL LAMP LIGHT SMOKE</p> 	<p>ZCXXK-C-050 2019 L200 中网银色高配 2019 L200 GRILLE HIGH CLASS SILVER</p> 
<p>ZCXXK-C-050-2 2019 L200 中网黑色低配 2019 L200 GRILLE BLACK LOW CLASS</p> 	<p>ZCXXK-C-050-3 2019 L200 中网电镀 2019 L200 GRILLE CHROME</p> 
<p>ZCXXK-C-050-4 2019 L200 改装中网带灯A 2019 L200 GRILLE WITH LAMP A</p> 	<p>ZCXXK-C-050-5 2019 L200 改装中网带灯B 2019 L200 GRILLE WITH LAMP B</p> 

三菱L200系列 MITSUBISHI L200



<p>ZCXXK-C-050-6 2019 L200 改装中网不带灯C 2019 L200 GRILLE WITHOUT LAMP C</p> 	<p>ZCXXK-C-051 2019 L200 挡泥板高配 2019 L200 MUD GUARD</p> 
<p>ZCXXK-C-051-2 2019 L200 中东四驱版挡泥板 2019 L200 MID ASIA 4WD TYPE MUD GUARD</p> 	<p>ZCXXK-C-051-3 2019 L200 中东二驱版挡泥板 2019 L200 MID ASIA 2WD TYPE MUD GUARD</p> 
<p>ZCXXK-C-052 2019 L200 前杠上亮条 2019 L200 FRONT BUMPER UPPER CHROME STRIP</p> 	<p>ZCXXK-C-052-2 2019 L200 前杠下亮条 L200 FRONT BUMPER UNDER CHROME STRIP</p> 
<p>ZCXXK-C-052-3 2019 L200 2WD 前杠小塑料条 2019 L200 2WD FRONT BUMPER SMALL STRIP</p>  	<p>ZCXXK-C-053 2019 L200 车门亮条 2019 L200 DOOR STRIP</p> 
<p>ZCXXK-C-054 2019 L200 前保险杠4WD 2019 L200 FRONT BUMPER 4WD</p> 	<p>ZCXXK-C-054-2 2019 L200 前杠 2WD 2019 FRONT BUMPER 2WD</p> 

三菱L200系列 MITSUBISHI L200



<p>ZCXXK-C-055 2019 L200 前保险杠网格 2019 L200 FRONT BUMPER GRILLE</p> 	<p>ZCXXK-C-056 2019 L200 前保险杠下条 2019 L200 FRONT BUMPER STRIP</p> 	
<p>ZCXXK-C-057 2019 L200 边灯 2019 L200 SIDE LAMP</p> 	<p>ZCXXK-C-058 2019 L200 电镀车镜 2019 L200 CHROME MIRROR</p> 	
<p>ZCXXK-C-058-2 2019 L200 黑色车镜 2019 L200 BLACK MIRROR</p> 	<p>ZCXXK-C-059 2019 L200 后杠 2019 L200 REAR BUMPER</p> 	
<p>ZCXXK-C-060 2019 L200 前小内衬 2019 L200 FRONT SMALL INNER LINING</p> 	<p>ZCXXK-C-060-2 2019 L200 前大内衬 2019 L200 FRONT BIG INNER LINING</p> 	<p>ZCXXK-C-060-3 2019 L200 后翼子板内衬 2019 L200 REAR INNER LINING OF FENDER</p> 
<p>ZCXXK-C-061 2019 L200 前发动机铁保护板 2019 L200 FRONT METAL ENGINE PROTECTION COVER</p> 	<p>ZCXXK-C-062 2019 L200 前保险杠支架 2019 L200 FRONT BUMPER BRACKET</p> 	

三菱L200系列 MITSUBISHI L200



<p>ZCXXK-C-063 2019 L200 机盖 2019 HOOD</p> 	<p>ZCXXK-C-064 2019 L200 翼子板. 2019 FENDER</p> 
<p>ZCXXK-C-065 2019 L200 后翼子板. 19 REAR FENDER</p> 	<p>ZCXXK-C-066 2021 L200 涉水喉 2021 L200 SNORKEL</p> 
<p>ZCXXK-C-067 2019 L200 外门拉手 2019 L200 OUT DOOR HANDLE</p> 	<p>ZCXXK-C-068 2019 L200 尾门把手框 2019 L200 TAIL GATE HANDLE FRAME</p> 
<p>ZCXXK-C-069 2019 L200 机盖铰链 2019 L200 HOOD HINGE</p> 	<p>ZCXXK-C-070 2019 L200 轮眉长款 2019 L200 FENDER FLARE LONG TYPE</p> 
<p>ZCXXK-C-070-2 2019 L200 轮眉短款 2019 L200 FENDER FLARE SHORT TYPE</p> 	<p>ZCXXK-C-071 2019 L200 水箱盖板 2019 L200 UPPER PLASTIC COVER OF RADIATOR</p> 

三菱L200系列 MITSUBISHI L200



ZCXXK-C-072
2019 L200 行李架
2019 L200 ROOF RACK



ZCXXK-C-073
2019 L200 脚踏板
2019 L200 FOOT STEP



ZCXXK-C-074
2019 L200 高配车镜
2021 L200 HIGH LEVEL MIRROR



ZCXXK-C-075
2020 L200 前门
2020 L200 FRONT DOOR



ZCXXK-C-076
2020 L200 后门
2020 L200 REAR DOOR



三菱L200系列 MITSUBISHI L200



2015 CHANGE TO 2020 L200 DRL HEAD LAMP TYPE UPGRADE



2015 L200 CHANGE TO 2020 L200 HIGH LEVEL HEAD LAMP TYPE UPGRADE



福特RANGER系列 FORD RANGER



<p>ZCXXK-D-08-002 10 红色尾灯 RED 10 RANGER TAIL LAMP</p> 	<p>ZCXXK-D-08-002 10 白色尾灯 WHITE 10 RANGER TAIL LAMP</p> 	
<p>ZCXXK-D-001 12 大灯(黑) 12 HEAD LAMP(BLACK)</p> 	<p>ZCXXK-D-001-2 12 前大灯(白) 12 HEAD LAMP(WHITE)</p> 	<p>ZCXXK-D-002 12 尾灯 12 TAIL LAMP SIZE:72x45x57CM/10PCS</p> 
<p>ZCXXK-D-003 雾灯 FOG LAMP SIZE:</p> 	<p>ZCXXK-D-004 12 尾灯 12 TAIL LAMP SMOKE SIZE:</p> 	
<p>ZCXXK-D-005 12 前保险杠 12 FRONT BUMPER</p> 	<p>ZCXXK-D-006 12 尾灯带黑色护罩 12 TAIL LAMP WITH BLACK COVER</p> 	
<p>ZCXXK-D-007 12 电镀中网 12 CHROME GRILLE SIZE:118x62x35CM/4PCS</p> 	<p>ZCXXK-D-007-2 12 黑色中网 12 BLACK GRILLE SIZE:118x62x35CM/4PCS</p> 	

福特RANGER系列 FORD RANGER



<p>ZCXK-D-007-3 12 中网 2012 MODIFIED GRILLE</p> 	<p>ZCXK-D-008 12 尾灯 LED 12 TAIL LAMP LED</p> 
<p>ZCXK-D-009 17 大灯 17 HEAD LAMP</p> 	<p>ZCXK-D-009-2 16 大灯 2016 RANGER NORMAL HEAD LAMP</p> 
<p>ZCXK-D-009-3 16 大灯 2016 RANGER MODIFIED HEAD LAMP</p> 	<p>ZCXK-D-010 17 中网灰色 17 GRILLE GREY</p> 
<p>ZCXK-D-010-2 17 中网电镀 GRILLE CHROME</p> 	<p>ZCXK-D-011 12 中网黑色 GRILLE</p> 
<p>ZCXK-D-011-2 2010 中网带日行灯 2016 RANGER GRILLE WITH DRL</p>  	<p>ZCXK-D-011-3 2016 中网日行灯 2016 RANGER GRILLE DRL</p> 

福特RANGER系列 FORD RANGER



<p>ZCXK-D-012 2016 雾灯框白色 2016 RANGER FOG LAMP WHITE</p> 	<p>ZCXK-D-012-2 2016 雾灯框黄色 2016 RANGER FOG LAMP YELLOW</p> 
<p>ZCXK-D-013 2016 中网框 2016 RANGER RAPTOR TYPE</p> 	<p>ZCXK-D-014 2016 中网LED 2016 RANGER GRILLE 3 LED</p> 
<p>ZCXK-D-014-2 2016 中网LED 2016 RANGER GRILLE 4 LED</p> 	<p>ZCXK-D-015 2016 轮眉 2016 RANGER EYEBROW</p> 
<p>ZCXK-D-015-2 2016 轮眉带灯 2016 RANGER EYEBROW WITH LAMP</p> 	<p>ZCXK-D-016 2016 机盖板 2016 RANGER HOOD COVER</p> 
<p>ZCXK-D-017 2016 前杠护杠 2016 RANGER FRONT OVERBUMPER</p> 	<p>ZCXK-D-018 2016 后杠 2016 RANGER REAR BUMPER</p> 

福特RANGER系列 FORD RANGER



<p>ZCXX-D-019 2016 行李架 2016 RANGER ROOF RACK</p> 	<p>ZCXX-D-020 2016 车门装饰板 2016 RANGER DOOR PROTECTION BOARD</p>  
<p>ZCXX-D-021 2016 脚踏板 2016 RANGER FOOT STEP</p>  	<p>ZCXX-D-022 2016 前包围 2016 RANGER FRONT BODY KIT</p>  
<p>ZCXX-D-023 2016 叶子板饰板 2016 RANGER FENDER COVER</p> 	<p>ZCXX-D-024 2016 机盖 2016 RANGER HOOD</p>  <p>ZCXX-D-025 2016 叶子板 2016 RANGER FENDER</p> 
<p>ZCXX-D-026 2016 前门 2016 RANGER FRONT DOOR</p>  <p>ZCXX-D-026-2 2016 后门 2016 RANGER REAR DOOR</p> 	<p>ZCXX-D-027 2016 后背门 2016 RANGER TAIL GATE</p> 
<p>ZCXX-D-028 2016 水箱框架 2016 RANGER RADIATOR SUPPORT</p> 	<p>ZCXX-D-029 2016 后背门板 2016 RANGER TAIL GATE BOARD</p> 

大众AMAROK 12系列 AMAROK 12



<p>ZCXK-V-001 AMAROK 12 前大灯 AMAROK 12 HEAD LAMP SIZE: N.W.: G.W.:</p> 	<p>ZCXK-V-002 AMAROK 12尾灯 AMAROK 12 TAIL LAMP SIZE:79x40.5x54CM/10PCS N.W.: G.W.:</p> 
<p>ZCXK-V-003 AMAROK 12 普通车镜 AMAROK 12 MIRROR SIZE: N.W.: G.W.:</p> 	<p>ZCXK-V-004 AMAROK 12 中网 AMAROK 12 GRILLE SIZE:112x44.5x54CM/3PCS N.W.: G.W.:</p> 
<p>ZCXK-V-005 AMAROK 12 前保险杠 AMAROK 12 FRONT BUMPER SIZE: N.W.: G.W.:</p> 	<p>ZCXK-V-006 AMAROK 12 雾灯 AMAROK 12 FOG LAMP SIZE: N.W.: G.W.:</p> 
<p>ZCXK-V-007 AMAROK 12 雾灯罩 AMAROK 12 FOG LAMP SIZE: N.W.: G.W.:</p> 	<p>ZCXK-V-008 AMAROK 12 边灯 AMAROK 12 SIDE LAMP SIZE: N.W.: G.W.:</p> 
<p>ZCXK-V-009 2016大灯 2016 HEAD LAMP</p> 	<p>ZCXK-V-010 AMAROK 12 后杠 AMAROK 12 REAR BUMPER SIZE: N.W.: G.W.:</p> 

大众AMAROK 12系列 AMAROK 12



<p>ZCXXK-V-010-2 AMAROK 12 黑色后杠 AMAROK 12 BLACK REAR BUMPER SIZE: N.W.: G.W.:</p> 	<p>ZCXXK-V-011 AMAROK 12 尾灯 AMAROK 12 TAIL LAMP (SMOKE) SIZE: N.W.: G.W.:</p> 
<p>ZCXXK-V-012 AMAROK 网格 AMAROK BUMPER GRILLE SIZE: N.W.: G.W.:</p> 	<p>ZCXXK-V-013 AMAROK 轮眉 AMAROK EYEBROW SIZE: N.W.: G.W.:</p> 
<p>ZCXXK-V-014 AMAROK 护杠 AMAROK OVERBUMPER SIZE:136.5x25x48CM/1PC N.W.: 4KGS G.W.:5.5KGS</p> 	<p>ZCXXK-V-015 AMAROK 风扇罩 AMAROK FAN SHROUD SIZE: N.W.: G.W.:</p> 
<p>ZCXXK-V-016 AMAROK 风扇叶 AMAROK FAN SIZE: N.W.: G.W.:</p> 	<p>ZCXXK-V-017 AMAROK 前保险杠支架 AMAROK FRONT BUMPET SUPPORT SIZE: N.W.: G.W.:</p> 
<p>ZCXXK-V-018 AMAROK 挡泥板 AMAROK MUD GUARD SIZE: N.W.: G.W.:</p> 	<p>ZCXXK-V-019 AMAROK 2016 尾灯LED AMAROK 2016 TAIL LAMP LED</p> 

大众AMAROK 12系列 AMAROK 12



<p>ZCXK-V-020 2016 尾灯烟灰色LED 2016 TAIL LAMP LED SMOKE</p>  	<p>ZCXK-V-021 2016 雾灯 2016 FOG LAMP</p> 
<p>ZCXK-V-022 2016 雾灯框 2016 FOG LAMP COVER</p> 	<p>ZCXK-V-022-2 2016 雾灯框带日行灯 FOG LAMP COVER WITH DRL</p> 
<p>ZCXK-V-023 2016 中网 2016 GRILLE</p> 	<p>ZCXK-V-024 2016 前保险杠网格 2016 FRONT BUMPER GRILLE</p> 

尼桑NAVARA系列 NISSAN NAVARA



<p>ZCXC-N-001 大灯 HEAD LAMP</p> 	<p>ZCXC-N-001-2 15 NAVARA NORMAL 大灯 15 NAVARA NORMAL HEAD LAMP</p> 
<p>ZCXC-N-002 15 NAVARA 尾灯 15 NAVARA TAIL LAMP</p> 	<p>ZCXC-N-002-2 15 NAVARA 改装尾灯红色 15 NAVARA TAIL LAMP LED RED</p> 
<p>ZCXC-N-002-3 15 NAVARA 改装尾灯烟灰色 15 NAVARA TAIL LAMP LED SMOKE</p>  	<p>ZCXC-N-003 15 NAVARA 电镀中网 15 NAVARA GRILLE CHROME</p> 
<p>ZCXC-N-003-2 15 NAVARA 黑色中网 15 NAVARA GRILLE BLACK</p> 	<p>ZCXC-N-003-3 15 NAVARA 中网 15 NAVARA GRILLE LATTICED TYPE</p> 
<p>ZCXC-N-003-4 15 NAVARA 黑色中网 15 NAVARA GRILLE RAPTOR TYP</p> 	<p>ZCXC-N-003-5 15 NAVARA 中网 15 NAVARA GRILLE HUMMER TYPE</p>  

尼桑NAVARA系列 NISSAN NAVARA



<p>ZCXK-N-003-6 15 NAVARA 中网 15 NAVARA GRILLE TRD TYP</p> 	<p>ZCXK-N-004 15 NAVARA 前杠 15 NAVARA FRONT BUMPER</p> 
<p>ZCXK-N-005 15 NAVARA 雾灯带灯框 15 NAVARA FOG LAMP WITH COVER</p> 	<p>ZCXK-N-006 15 NAVARA 带灯框带LED黑色 15 NAVARA FOG LAMP COVER WITH LED BLACK</p>  
<p>ZCXK-N-006-2 15 NAVARA 带灯框带LED电镀 15 NAVARA FOG LAMP WITH LED CHROME</p> 	<p>ZCXK-N-007 15 NAVARA 前护杠 15 NAVARA FRONT OVERBUMPER</p> 
<p>ZCXK-N-008 15 NAVARA 后杠 15 NAVARA REAR BUMPER</p> 	<p>ZCXK-N-009 15 NAVARA 机盖 15 NAVARA HOOD</p> 
<p>ZCXK-N-010 15 NAVARA 两驱叶子板 15 NAVARA FENDER 2WD</p> 	<p>ZCXK-N-011 15 NAVARA 四驱叶子板 15 NAVARA FENDER 2WD</p> 

尼桑NAVARA系列 NISSAN NAVARA



<p>ZCXXK-N-012 15 NAVARA 前门 15 NAVARA FRONT DOOR</p> 	<p>ZCXXK-N-012-2 15 NAVARA 后门 15 NAVARA REAR DOOR</p> 
<p>ZCXXK-N-013 15 NAVARA 后背门带孔 15 NAVAR TAILGATE WITH MOULDING HOLE</p> 	<p>ZCXXK-N-013-2 15 NAVARA 后背门 15 NAVARA TAIL GATE</p> 
<p>ZCXXK-N-014 15 NAVARA 后叶子板 15 NAVARA REAR FENDER</p> 	<p>ZCXXK-N-015 21 NAVARA 高配大灯 21 NAVARA HEAD LAMP HIGH LEVEL</p> 
<p>ZCXXK-N-015-2 21 NAVARA 低配大灯 21 NAVARA HEAD LAMP LOW LEVEL</p> 	<p>ZCXXK-N-016 21 NAVARA 尾灯 21 NAVARA TAIL LAMP</p> 
<p>ZCXXK-N-016-2 21 NAVARA 尾灯烟灰色 21 NAVARA TAIL LAMP SMOKE</p>  	<p>ZCXXK-N-017 21 NAVARA 电镀中网 21 NAVARA GRILLE CHROME</p> 

尼桑NAVARA系列 NISSAN NAVARA



<p>ZCXK-N-017-2 21 NAVARA 黑色中网 21 NAVARA GRILLE BLACK</p> 	<p>ZCXK-N-018 21 NAVARA 前杠 21 NAVARA FRONT BUMPER</p> 
<p>ZCXK-N-018-2 21 NAVARA 前杠护板 21 NAVARA FRONT BUMPER BOARD</p> 	<p>ZCXK-N-018-3 21 NAVARA 前杠小护板 21 NAVARA FRONT BUMPER SMALL BOARD</p> 
<p>ZCXK-N-018-4 21 NAVARA 前杠盖板 21 NAVARA FRONT BUMPER COVER</p> 	<p>ZCXK-N-019 21 NAVARA 雾灯套装. 21 NAVARA FOG LAMP COMPLETE SET</p> 
<p>ZCXK-N-019-2 21 NAVARA 雾灯低配 21 NAVARA FOG LAMP LOW LEVEL</p> 	<p>ZCXK-N-020 21 NAVARA 高配机盖亮条电镀 21 NAVARA HOOD STRIP HIGH LEVEL</p> 
<p>ZCXK-N-020-2 21 NAVARA 低配机盖亮条黑色 21 NAVARA HOOD STRIP LOW LEVEL BLACK</p> 	<p>ZCXK-N-021 21 NAVARA 前杠支架 21 NAVARA FRONT BUMPER BRACKET</p> 

尼桑NAVARA系列 NISSAN NAVARA



ZCXK-N-022
21 NAVARA 水箱盖板
21 NAVARA RADIATOR COVER



ZCXK-N-023
21 NAVARA 尾门把手
21 NAVARA TAIL GATE HANDLE



ZCXK-N-024
21 NAVARA 喷水壶
21 NAVARA WIPER TANK



ZCXK-N-025
21 NAVARA 水壶
21 NAVARA WATER TANK



ZCXK-N-026
21 NAVARA 风扇叶
21 NAVARA FAN



ZCXK-N-027
21 NAVARA 前翼子板内衬
21 NAVARA FRONT INNER LINING OF FENDER



ZCXK-N-028
21 NAVARA 挡泥板
21 NAVARA MUD GUARD



尼桑NAVARA系列 NISSAN NAVARA



UPGRADE



LC76系列



<p>ZCXX-LC-001 大灯 HEAD LAMP</p> 	<p>ZCXX-LC-001-2 大灯LED HEAD LAMP LED</p> 
<p>ZCXX-LC-001-3 2022大灯 2022 LC HEAD LAMP</p> 	<p>ZCXX-LC-002-A 尾灯窄体 TAIL LAMP NARROW</p> 
<p>ZCXX-LC-002-B 尾灯宽体 TAIL LAMP WILD</p> 	<p>ZCXX-LC-003 角灯电镀 CORNER LAMP CHROME</p> 
<p>ZCXX-LC-003-2 角灯黑色 CORNER LAMP BLACK</p> 	<p>ZCXX-LC-004 尾灯 TAIL LAMP</p> 
<p>ZCXX-LC-005 黑色中网 GRILLE BLACK</p> 	<p>ZCXX-LC-005-2 电镀中网 GRILLE CHROMF</p> 









LC76系列



<p>ZCXK-LC-006 电镀中网 GRILLE CHROME</p> 	<p>ZCXK-LC-006-2 中网黑色 GRILLE BLACK</p> 
<p>ZCXK-LC-006-3 中网改装1 GRILLE CHROME</p> 	<p>ZCXK-LC-006-4 中网改装2 GRILLE</p> 
<p>ZCXK-LC-007 前保险杠 FRONT BUMPER</p> 	<p>ZCXK-LC-008 后保险杠 REAR BUMPER</p> 
<p>ZCXK-LC-009 前雾灯 FOG LAMP</p> 	<p>ZCXK-LC-010 前雾灯底座 FOG LAMP HOUSING</p> 
<p>ZCXK-LC-011 前雾灯 FOG LAMP</p> 	<p>ZCXK-LC-012 轮眉 FENDER FLARE</p> 

普拉多PRADO 2014系列 PRADO 2014



<p>ZCXK-P-001 手动大灯 14 HEAD LAMP NORMAL</p> 	<p>ZCXK-P-002 大灯LED 14 HEAD LAMP LED</p> 
<p>ZCXK-P-003 尾灯 14 TAIL LAMP</p> 	<p>ZCXK-P-003-2 尾灯WHITE 14 TAIL LAMP WHITE</p> 
<p>ZCXK-P-003-3 尾灯烟灰色 14 TAIL LAMP SMOKE</p> 	<p>ZCXK-P-004 中网电镀 14 GRILLE CHROME</p> 
<p>ZCXK-P-004-2 中网灰色 14 GRILLE GREY</p> 	<p>ZCXK-P-005 机盖亮条 14 HOOD STRIP</p> 
<p>ZCXK-P-006 前杠 14 FRONT BUMPER</p> 	<p>ZCXK-P-007 雾灯 14 FOG LAMP</p> 

普拉多PRADO 2014系列 PRADO 2014



<p>ZCXK-P-008 后杠 14 REAR BUMPER</p> 	<p>ZCXK-P-009 前内护板 14 INNER COVER OF FRONT</p> 
<p>ZCXK-P-010 牌照板 LICENSE PLATE</p> 	<p>ZCXK-P-011 前杠内骨架 14 FRONT BUMPER INNER METAL SUPPORT</p> 
<p>ZCXK-P-012 前杠支架 14 FRONT BUMPER BRACKET.</p> 	<p>ZCXK-P-013 前杠网格 14 FRONT BUMPER GRILLE</p> 
<p>ZCXK-P-014 前杠铁骨架 14 FRONT INNER IRON BUMPER</p> 	<p>ZCXK-P-015 前叶子板内衬 14 FRONT INNER LINING OF FENDER</p> 
<p>ZCXK-P-016 前护杠 14 FRONT OVERBUMPER</p> 	<p>ZCXK-P-017 后牌照板亮条 14 TAIL GATE STRIP</p> 

普拉多PRADO 2014系列 PRADO 2014



<p>ZCXXK-P-018 牌照框 14 LICENSE COVER</p> 	<p>ZCXXK-P-019 轮毂罩 14 WHEEL COVER</p> 
<p>ZCXXK-P-020 后反光灯 14 REAR REFLECTION LAMP</p> 	<p>ZCXXK-P-021 高位刹车灯 14 HIGH BRAKE LAMP</p> 
<p>ZCXXK-P-022 后反光灯 TRAILER HOOK</p> 	<p>ZCXXK-P-023 水箱下护板 RADIATOR UPPER COVER</p> 

普拉多PRADO 2014系列 PRADO 2014



10-13 款普拉多改 14 款普拉多 / 前后套件 (国产版)



普拉多PRADO 2018系列 PRADO 2018



<p>ZCXK-P-18-001 大灯 HEAD LAMP</p> 	<p>ZCXK-P-18-002 尾灯 TAIL LAMP</p> 
<p>ZCXK-P-18-003 中网灰色 GRILLE GREY</p> 	<p>ZCXK-P-18-003-2 中网白色 GRILLE WHITE</p> 
<p>ZCXK-P-18-004 雾灯 FOG LAMP</p> 	<p>ZCXK-P-18-005 前杠 FRONT BUMPER</p> 
<p>ZCXK-P-18-006 后杠 REAR BUMPER</p> 	<p>ZCXK-P-18-007 前杠网格 FRONT BUMPER GRILLE</p> 
<p>ZCXK-P-18-008 大灯电镀亮条 HEAD LAMP CHROME STRIP</p> 	<p>ZCXK-P-18-009 前杠护杠 FRONT OVERBUMPER</p> 

普拉多PRADO 2018系列 PRADO 2018



<p>ZCXX-P-18-010 水箱护板 RADIATOR COVER</p> 	<p>ZCXX-P-18-011 前杠支架 FRONT BUMPER BRACKET</p> 
<p>ZCXX-P-18-012 牌照板 LICENSE PLATE</p> 	<p>ZCXX-P-18-013 发动机罩内衬 INNER LINING OF HOOD</p> 
<p>ZCXX-P-18-014 前保险杠雨刮器盖 WIPER TANK BUMPER</p> 	<p>ZCXX-P-18-015 后牌照板 REAR LICENSE PLATE</p> 
<p>ZCXX-P-18-016 后背门亮条 TAIL DOOR STRIP</p> 	<p>ZCXX-P-18-017 后灯装饰框 TAIL LAMP COVER</p>  
<p>ZCXX-P-18-018 尾翼 REAR SPOILER</p> 	<p>ZCXX-P-18-019 侧板 SIDE BOARD</p> 

普拉多PRADO 2018系列 PRADO 2018



ZCXX-P-18-020
后雾灯LED
REAR FOG LAMP LED













10-17 款普拉多改 18 款普拉多 / 前后套件 (国产版)



兰德酷路泽LANDCRUISER 2016系列 LANDCRUISER 2016



<p>ZCXK-L-001 大灯 HEAD LAMP</p> 	<p>ZCXK-L-002 尾灯 TAIL LAMP</p> 
<p>ZCXK-L-003 大灯电镀亮条 HEAD LAMP CHROME STRIP</p> 	<p>ZCXK-L-004 中网低配 LOW LEVEL GRILLE</p> 
<p>ZCXK-L-005 雾灯 FOG LAMP</p> 	<p>ZCXK-L-006 雾灯框 FOG LAMP COVER</p> 
<p>ZCXK-L-007 前杠 FRONT BUMPER</p> 	<p>ZCXK-L-008 前杠护杠 FRONT OVER BUMPER</p> 
<p>ZCXK-L-009 前杠小 SMALL FRONT BUMPER</p> 	<p>ZCXK-L-010 后杠小 SMALL REAR BUMPER</p> 

兰德酷路泽LANDCRUISER 2016系列 LANDCRUISER 2016



<p>ZCXK-L-011 后杠 REAR BUMPER</p> 	<p>ZCXK-L-012 脚踏板 FOOT STEP</p> 
<p>ZCXK-L-013 车门装饰条 DOOR STRIP</p> 	<p>ZCXK-L-014 前杠支架 FRONT BUMPER BRACKET</p> 
<p>ZCXK-L-015 后杠支架 REAR BUMPER BRACKET</p> 	<p>ZCXK-L-016 前杠铁支架 FRONT BUMPER METAL SUPPORT</p> 
<p>ZCXK-L-017 前保险杠雨刮器盖 FRONT BUMPER WIPER COVER</p> 	<p>ZCXK-L-018 发动机罩铰链 HOOD HINGE</p> 
<p>ZCXK-L-019 后反光灯 REAR REFLECTION LAMP</p> 	<p>ZCXK-L-020 A 白雾灯带雾灯框 WHITE</p> 

兰德酷路泽LANDCRUISER 2016系列 LANDCRUISER 2016



<p>ZCXK-L-020 B 黄雾灯带雾 灯框YELLOW</p> 	<p>ZCXK-L-020 雾灯框 LED FOG LAMP COVER</p> 
<p>ZCXK-L-021 散热器上盖 RADIATOR UPPER COVER</p> 	<p>ZCXK-L-022 发动机罩内衬 INNER LINING OF HOOD</p> 

兰德酷路泽LANDCRUISER 2016系列 LANDCRUISER 2016

