

Blue Line Gen2
**Pet Friendly TriTech
 Motion Detector**
 ISC-BDL2-WP12, ISC-BDL2-WP6



This product is intended for use in the following countries within the European Union and in other countries outside of the European Union:

ISC-BDL2-WP12G, ISC-BDL2-WP6G (10.525 GHz):
 Austria, Belgium, Denmark, Finland, Greece, Italy, Luxembourg, Netherlands, Norway, Portugal, Spain, Sweden

ISC-BDL2-WP12H (10.588 GHz):
 France, United Kingdom

US Patent No.
 5,670,943
 7,009,106
 5,450,062

Optional Brackets:
 B328, B338, B335

2,2 m - 2,75 m
 (7.5 ft - 9 ft)
 Recommended:
 2,2m (7.5 ft)

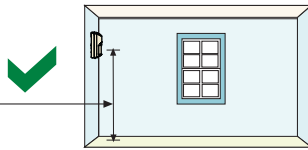

Pet Friendly
 ≤ 45 kg (100 lb)

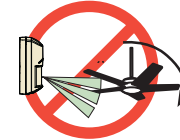
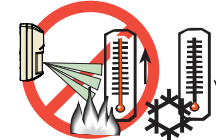
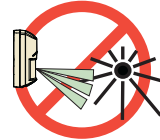
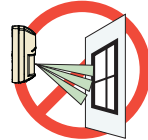

Changes or modifications not expressly approved by Bosch Security Systems, Inc. can void the user's authority to operate the equipment.

UL/C-UL
 Perform Walk Test at least once a year.
 Pet immunity not tested by UL/C-UL.
 Use only a Listed limited-power source.
 The Listed control unit or a Listed burglary power supply must provide 4 hours (40 mAh) of standby power.
 Install the unit in accordance with National Electrical Code NFPA 70 and Part 1 of the Canadian Electrical code CSA C22.1.
 Adjust the microwave range control, if necessary, to achieve maximum range.

SELV
 Connect all wiring to a safety extra-low voltage (SELV) circuit only.
CE EN 50131-2-4 Grade 2
E EN 50130-5 Environmental Class II
 IP30 IK04 (EN 60529, EN 50102)

Ligue todas as cablagens apenas a um circuito de segurança de tensão extra baixa (SELV).
 Conecte el cableado únicamente a un circuito de seguridad para voltajes muy bajos (SELV).
 Alle Drähte sind ohne Ausnahme an Niederspannung anzuschließen.

Sluit alle bedrading uitsluitend aan op een circuit met een extra lage veiligheidsspanning.

Prenez soin de connecter tous les câbles à un circuit à très basse tension de sécurité (TBTS).

Collegare tutti i cavi esclusivamente a un circuito SELV (circuito di sicurezza a bassissima tensione).

-30°C to +55°C
 (-20°F to +130°F)
 UL/C-UL Listed installations, the temperature range is 0°C to +49°C (+32°F to +120°F)

Pour les installations certifiées NFA2P, Température de fonctionnement -10°C à +55°C

0 - 95% Relative Humidity
 (0 - 85% UL/C-UL installations)

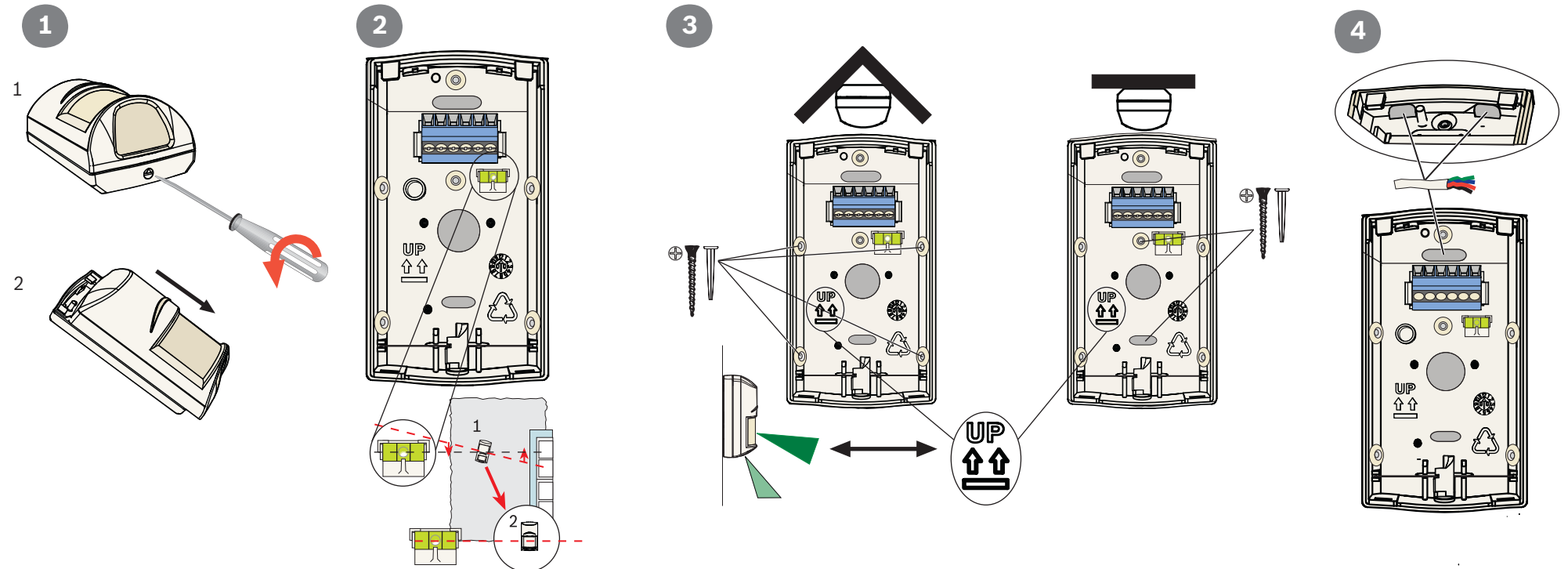

5

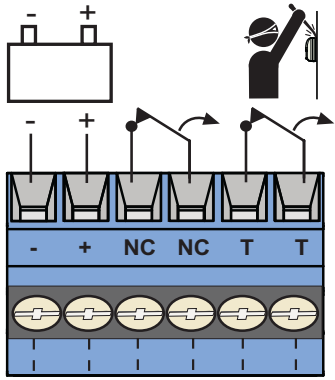

9 - 15 VDC
 10 mA (0.12W) @ 12 VDC

≤ 100 mA, 25 VDC, 2.5 W
 <20 Ω closed

9-15 Vcc
 10 mA @ 12 Vcc en veille/
 en alarme, source limitée en
 puissance, ondulation
 résiduelle 1 V.

6

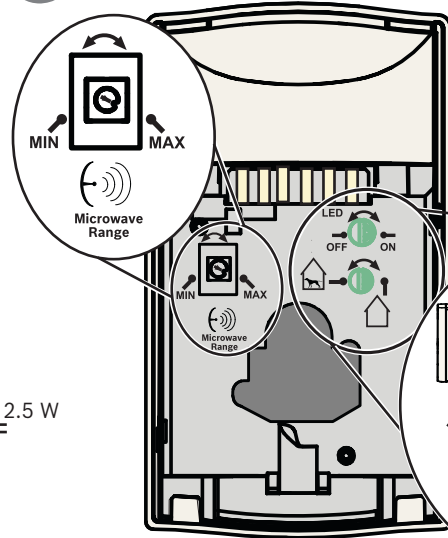

7

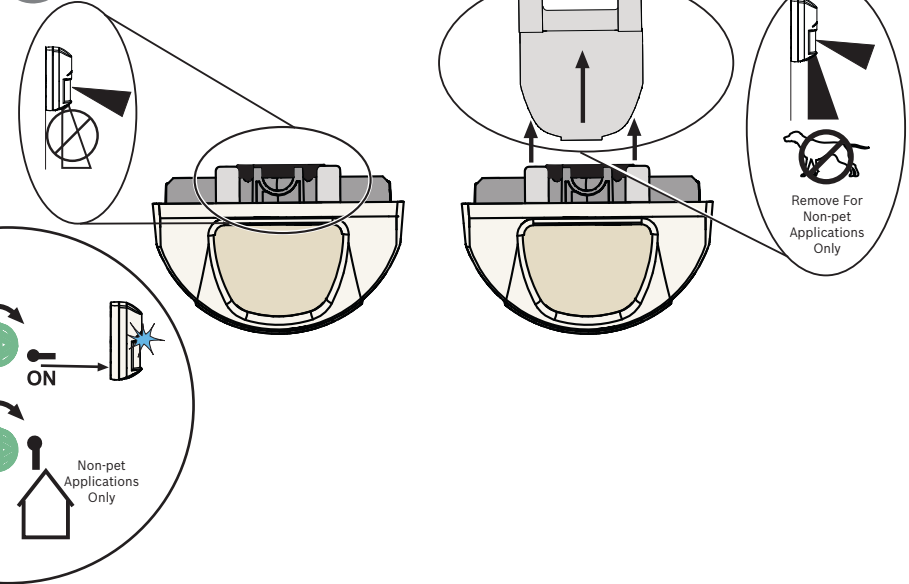

8

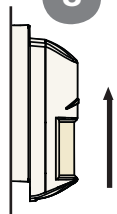

9

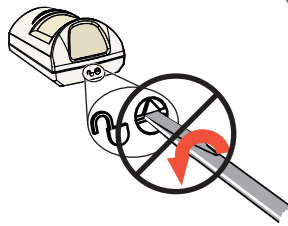

10

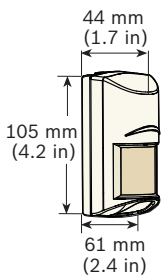
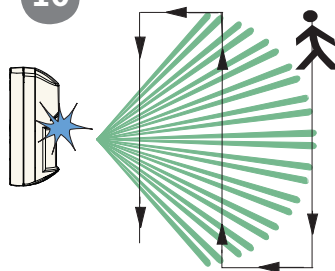

? → www.boschsecurity.com

