

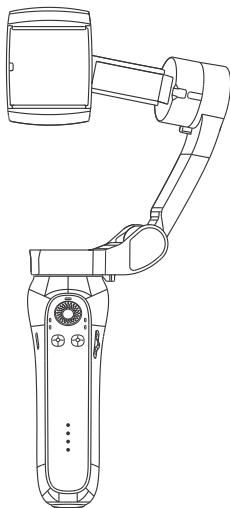

Sports Tracking Gimbal User Manual

Version 1.5 Apr. 2024



Contents

Before Use	2
Introduction	3
Auto Tracking	3
Video Tutorial	3
Phone Stabilizer	3
Component Diagram	4
Getting Started	5
Charging	5
Mounting Smartphones	5
Choosing a Recording Location	6
Using XbotGo	8
Buttons	8
Adjusting the Gimbal	10
Using the XbotGo App	10
FAQ	15
Notices	17
Specifications	18
Remote Controller	19
Apple Watch App	25

01/ Before Use

Scan the following QR code to download XbotGo App from App Store.



iOS



Android

⚠ The iOS version of XbotGo supports iOS 15.0 and later.
The Android version of XbotGo supports Android 10.0 and later.

Quick Start Guide

1. Open XbotGo App.
2. Click "User Manual" or "Guide" .
3. Watch the "Video Tutorial" for more instructions.

TIPS

- 1) Fully charge the gimbal before using.
- 2) Turn off the power when not in use.
- 3) Mount a mobile phone to the phone holder securely.

Support

Please contact: support@xbotgo.com OR +1 (888) 894 – 1886.

Business Hours: 8:00 AM – 18:00 PM EST (M – F).

02/ Introduction

► Auto Tracking

Thank you for choosing XbotGo! To use our gimbal to automatically track, record or stream sports games, please watch the following video tutorial first.

► Video Tutorial



► Phone Stabilizer

In addition, the XbotGo Gimbal is a fully functioning phone gimbal that can stabilize video recordings on smartphones. If you want to use it as a stabilizer for a mobile phone, refer to the 'XbotGo Gimbal User Manual' on the XbotGo official website: www.xbotgo.com.

Contact Us:

Live Chat: www.xbotgo.com

Email: support@xbotgo.com

Phone: +1 (888) 894 – 1886

► Component Diagram

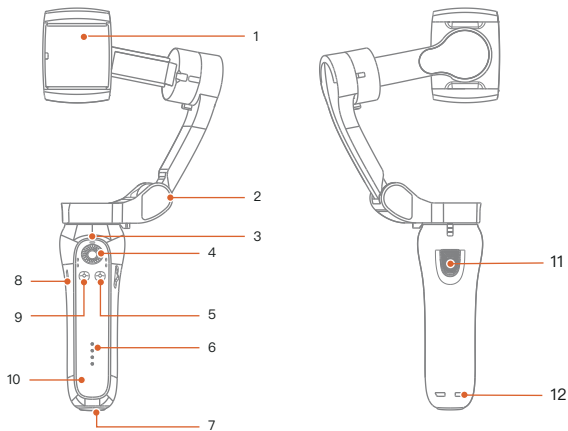

- | | |
|-----------------------------|-------------------------|
| 1. Smartphone Holder | 7. 1/4" Thread Screw |
| 2. Folding Shaft | 8. Type-C Charging Port |
| 3. Bluetooth Indicator | 9. Mode Button |
| 4. Joystick | 10. Handle |
| 5. Power Button | 11. Shutter Button |
| 6. Battery Level Indicators | 12. Thread Hole |

03/ Getting Started

► Charging

- To charge the XbotGo, connect a USB adapter (not included) to the USB-C charging port using the provided charging cable. This device supports fast charging, and it is recommended to use a 5V/2A adapter.
- When charging the XbotGo, the blue power indicator lights should flash. If not, please check if the adapter and the cable are connected properly. All four power lights should turn solid blue once the charging is completed.

Charging time: 80 minutes

Max. runtime: 3 ~ 4 hours

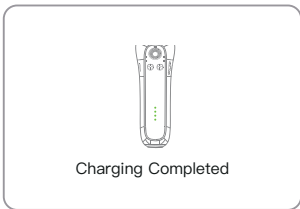
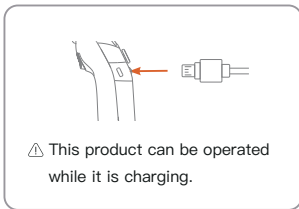

► Mounting Smartphone

1. Place the phone on the holder.
2. It is recommended to remove the phone case before mounting for the following reasons:
 - (1) The phone will have a better grip on the holder.
 - (2) The phone will dissipate heat more effectively. Overheating phones

at high temperatures could result in shutdown.

3. Align the mobile phone with the directional indicator on the phone holder clamp. Ensure it is centered and securely attached to the panel of the holder to prevent slipping. Make sure the phone is properly aligned with the red lines on the recording screen of the app.

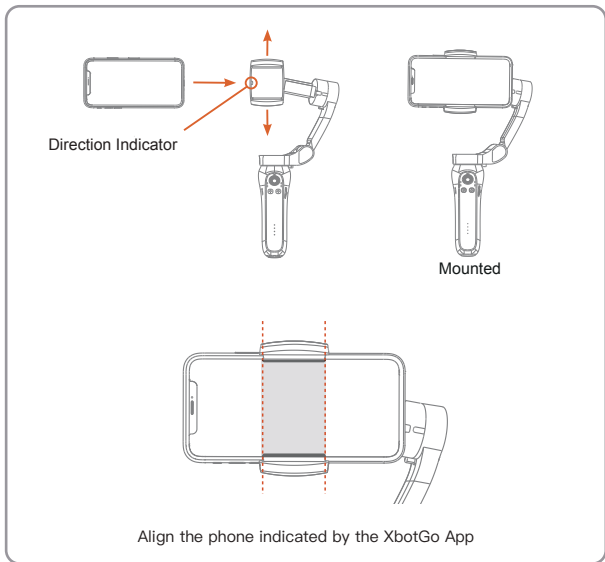

► Choosing a Recording Location (Highly Recommended)

When recording sport games, for the best tracking performance, it is

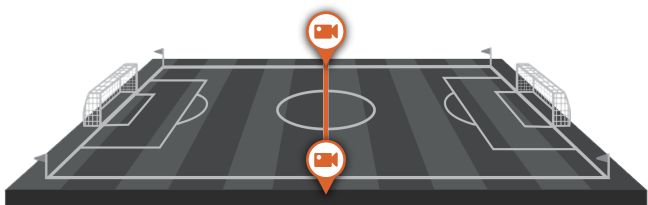

Examples of football fields

highly recommended to setup the device near the center line of the field (as shown below).

- Please try to align the back center mark toward the center line of the target field. This applies to all recording modes except for basketball half-court mode. Doing so will ensure that the camera covers the entire field.

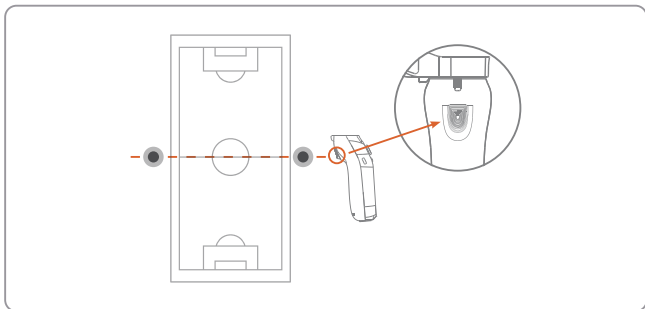

- Use a tripod to maintain stability and prevent gimbal destabilization during filming.

To avoid obstructing the sight, please consider the following suggestions:

- Elevate the tripod as much as possible to prevent audience members from blocking the camera's view.
- Avoid having audience members too close to the camera, as they may obstruct the view. Ensure that the camera's position remains undisturbed by the audience to achieve optimal shooting results.

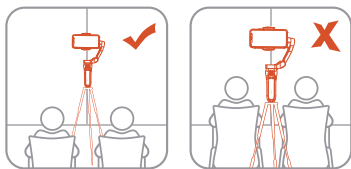

04/ Using XbotGo

► Buttons

1. Power Button

- **Power on:** Press and hold the power button for 1 second until the indicator lights turn on, and the gimbal makes a startup sound.
- **Power off:** Press and hold the power button for 1 second to turn off the gimbal. The gimbal will emit a shutdown sound, and all indicator lights will go off.

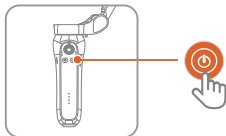

TIPS

The arms should be folded manually after power down, and the phone holder should get back to the storage position.

- **Single quick press:** Press the power button quickly to switch between portrait and landscape modes. If the gimbal becomes jammed, the AF light will flash; reset it by performing a single quick press.

2. Mode Button

Press twice: make the gimbal gets back to the center position.

3. Shutter Button

Reset Bluetooth: Press and hold the power button and the shutter button simultaneously for 3 seconds to reset the Bluetooth connection. This will disconnect the gimbal from the currently paired mobile phone.

4. Joystick

Move vertically to tilt and move horizontally to pan the mobile phone.

5. Battery Indicator Lights

Charging Status	Battery Level
The first light is flashing	10%–25%
The first light is on, and the second light is flashing	25%–50%
The first and second lights are on, and the third light is flashing	50%–75%
The first three lights are on, and the fourth light is flashing	75%–99%
Four lights are all on	100%

6. Bluetooth Indicator Light

Indicator Light Status	Bluetooth Status
Bluetooth indicator pulsing (flashing slowly)	Bluetooth is not connected
Bluetooth indicator flashing	Bluetooth is connecting
Bluetooth light is on	Bluetooth is connected

7. 1/4" Thread Port

The threaded port on the bottom allows XbotGo to attach to tripods.

► Adjusting the Gimbal

1. XbotGo is designed to record in landscape mode. To switch modes, press the power button once to switch the phone from portrait mode to landscape mode.
2. Before shooting, double-click the mode button to set the gimbal back to the center position. Try to align the shutter button with the center line of the field.

► Using XbotGo App

When used with XbotGo App, the XbotGo gimbal will be able to support features such as automatic tracking, manual shooting, and live streaming. To connect the gimbal with the XbotGo App.

Here's the instruction:

1. Enable Bluetooth from the mobile phone settings.
2. Open XbotGo App.
3. Sign up and log in to your account.
4. Click the orange  logo button on the home page.

5. XbotGo devices with the names "Xbot XXX" or "GP7 XXX" should be found. Select to connect to them. If the device cannot be seen, check if it appears in the Bluetooth settings of your mobile phone. It might be paired with other phones and thus cannot be seen by the desired phone.

⚠ Press and hold the power button and shutter button simultaneously for about 3 seconds to reset the Bluetooth. This will disconnect it from the previously paired phone, enabling quick connection to a new phone.

6. When the device is connected for the first time, a pairing reminder will appear, allowing you to choose whether to connect to the device. Afterward, when using the device, the XbotGo App will automatically connect to the device without displaying the pairing reminder again.



7. Connected devices (gimbal/controller) will display corresponding icons and Bluetooth identifiers on the main interface of the XbotGo App.



8. You can also manually add XbotGo Bluetooth devices. Clicking on allows you to manually add a gimbal/controller.



⚠ Only one gimbal and one controller can be connected at the same time.

Recording

1. After establishing a Bluetooth connection, you can select a sports activity within the application and enter recording mode. In this mode, press the red recording button to initiate automatic tracking and recording.
2. Before starting a recording, it is advisable to activate the "Do Not Disturb" mode on your phone to prevent interruptions such as incoming calls during the recording session.

Recording Parameter Settings

Upon entering the shooting interface in the XbotGo App, tap the corresponding icons on the screen to adjust the following parameters:

1. Interface Hide



2. Mute

Enables mute recording and live streaming.



3. Resolution

Choose between recording resolutions of 1080p or 720p. Resolution selection is automatically adjusted based on the phone model and shooting mode. For instance, iPhone 12 and newer models support 1080p, while compatible Android phones also support 1080p. Note that some older model phones may experience frame drops when recording in 1080p resolution with AI processing. Users recording in the default 720p resolution can manually upgrade to 1080p recording, although tracking and recording effects may vary.

4. Zoom Factor

Different zoom factors are pre-set for various shooting modes to optimize shooting effects and tracking performance in different scenes.

5. Additional Settings

Tap the icon to access additional personalized settings:

- **Auto Save Duration**
Sets the duration for automatic segmentation of videos. It is recommended to keep the recording time set to the default 30 minutes to prevent overheating and potential loss of recorded videos due to prolonged recording.
- **Screen Power Saving**
Activating power-saving mode reduces screen brightness to the minimum level after recording starts, extending the phone's battery life.
- **Auto Zoom:** Automatically adjusts zoom during shooting based on

scene and timing.

- **Auto Tracking**
Toggle switch for manual/auto tracking. When auto tracking is not desired, users can disable this function and use the gimbal buttons for manual tracking shots.
- **Shooting Angle**
Sets the maximum angle for left and right gimbal shots to prevent misjudgments. Users can adjust this to expand or reduce the shooting angle range as needed.
- **Tracking Speed**
Default settings are typically sufficient. If tracking speed is slow, users can manually adjust it according to their preferences.

Video Storage

Recorded videos are stored within the XbotGo application. To access these videos, navigate to "Local Files" to view all saved videos.

Upload/Download

Click on "Local Files" to access management. Then, tap the icon in the upper right corner to select local videos for upload or download. Uploaded videos can be viewed in the cloud interface, while downloaded videos are accessible in the app's local files.

Sharing

Click on the "Cloud" tab, select "Manage", choose the video you want to share, and tap the "Share" icon below to share the video with others through various methods.

Live Streaming

1. To initiate live streaming, tap the "Start Live" button located in the top right corner of the shooting interface. Follow the system prompts to select an image as the live cover and enter the live title.



2. Live streaming is facilitated through the XbotGo platform and can be shared externally by distributing the live streaming link. Users can set a live streaming password and determine the audience range as needed.

06/FAQ

1. Common reasons for issues such as tilting, shaking, loss of tracking, erratic movement, or beeping typically include:
 - Insufficient device battery power.
 - Misalignment of the phone clamp position.
 - External forces interfering with the normal operation of the device.
2. Possible causes of complete loss of tracking may include:
 - Interruption in Bluetooth connection.
 - Device connected to the wrong phone (if the gimbal has previously

connected to multiple phones).

3. For tracking with poor performance, specific issues and solutions are as follows:

- Partial areas of the field not captured:

Problems may arise from the placement position and angle of the device. Ensure that the extension line on the back of the device handle is perpendicular to the sideline of the field to ensure the correct center angle of the device.

- Camera not responsive to movements of certain players (especially those at a distance):

This could be due to incorrect selection of game mode or field size, or incorrect selection of player age.

- Camera focusing on one side of the field while the other remains empty for an extended period (more than 30 seconds) :

The camera may be obstructed by spectators along the sideline. Attempt to position the device as close to the sideline of the field as possible to minimize interference.

- Camera not zooming in or zooming not noticeable:

Ensure that automatic zoom is enabled. The zoom algorithm may require improvement.

4. If the gimbal battery depletes too quickly, lasting less than an hour:

- Adjust the position of the phone clamp to ensure the phone is centered and balanced.
- Ensure the gimbal battery is fully charged; when fully charged, all four blue power lights should illuminate.

- Use the original data cable for charging and avoid high-power chargers.
5. If unable to connect to the device's Bluetooth:
- Ensure the gimbal is not connected to other phones. Verify that the gimbal's Bluetooth is displayed in the phone's Bluetooth list.
 - Restart the gimbal and close and reopen the XbotGo App.
 - Reset the gimbal's Bluetooth and attempt reconnection.
6. General troubleshooting:
- Adjust the position of the phone clamp to ensure the phone is centered and balanced.
 - Restart the device and close and reopen the application.
 - Reset Bluetooth and reconnect the device.

07/ Notices

1. Ensure that no external force obstructs the movement of the gimbal while using the XbotGo App.
2. When initiating the XbotGo gimbal, ensure the handle remains stable. Shaking the gimbal during startup may lead to startup failure. It is advisable to install the tripod before commencing use.
3. The XbotGo gimbal is not waterproof. Avoid exposing the product to liquids or submerging it in water.

4. Refrain from disassembling the gimbal. In case of abnormal operation due to disassembly, please contact official after-sales support for professional assistance.
5. Prolonged and continuous operation may elevate the surface temperature of the motors excessively. Please use it with caution.
6. Handle the gimbal with care, as dropping or colliding with it may result in damage, thus impacting its normal operation.
7. Keep the product out of the reach of children and pets.
8. Do not place the product near heat sources and do not store it in high-temperature environments.
9. Store the product in a dry environment.
10. Do not overcharge to avoid damaging the battery.
11. Please use this product within the temperature range of 0°C to 40°C.

08/ Specifications

Gimbal Weight	362g
Payload	280g
Operating Temperature	0°C – 40°C
Voltage	3.4~4.2V (Standard 3.7V)
Compatible Phone Size	Diagonal: ≤ 180mm Width: 55–90mm Thickness: ≤ 9.5mm

Operating Current	150~3000mA (Standard 1500mA)
Dimensions	Unfolded: 260mm×130mm×88mm Folded: 152mm×110mm×46.6mm
Charging Time	80 mins (use 5V/2A adapter)
Run Time	3~4 hours
Input Voltage	5V
Input Current	2A

09/ Remote Controller

► Remote Controller Specifications



Model	XbotGo RC1
Battery Model	CR2032
Signal Coverage Range	10m
Temperature	-5°C ~ 60°C (23°F ~ 140°F)

Quick Start Guide

1. Open the battery compartment cover, then remove the insulating plastic sheet from the bottom of the battery. Close the battery compartment cover.

2. Press and hold the power button for 3 seconds to turn the remote controller on/off.

3. After turning on, press the function selection button to switch functions.

4. Bluetooth pairing is required before the first use.

a. Press and hold the remote controller's power button to power it on. The phone connection indicator on the remote controller will flash red.

b. Open the XbotGo app on your phone and select "XbotR-XXXX" in the app for pairing. After the connection is established, the phone connection indicator on the remote controller will turn solid blue.

5. **Exceeding the signal range:**

When disconnected from the app, the remote controller lights will flash red. If it re-enters the

receptive range within 1 minute, the blue lights on the remote controller will illuminate, and the connection will be automatically restored.



6. Sleep mode and Shutdown:

With no operation for 3 seconds, the remote controller will enter sleep mode. Press any button on the remote controller to exit sleep mode. If the remote controller remains in sleep mode for more than 30 minutes, it will automatically shut down. Press the power button to turn it on again, and it can be reconnected when close to the device.

⚠ The disconnection of the remote controller during use will not affect the app running on the phone. If the app cannot find the remote controller during use, you can reset the remote controller by pressing the power button for 3 seconds and then perform the pairing again.

► XbotGo RC1 Remote Controller

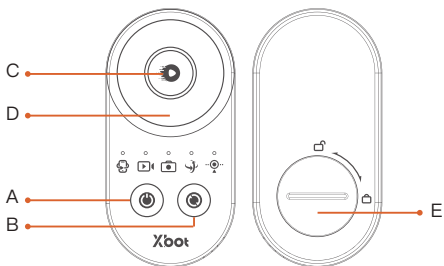

- A. Power Button
- B. Function Selection Button
- C. Confirm Button
- D. Directional Buttons (Circular Disk)
- E. Battery Compartment

► Buttons and Functions

Before using the remote controller, take some time to become familiar with its functions and features.

► Camera Function

Press the Function Selection button to switch to camera mode; then, use the confirm button in camera mode to control the shooting settings

• On the remote controller :

1. One "beep" sound indicates that the app is in "start recording" status.
2. Two consecutive "beep" sounds indicate that the app is in "stop recording" status.

• On the App side :

A blue mask will appear on the screen for 3 seconds and will automatically disappear. At this point, the device is in camera mode, and you can check the status with corresponding operational commands.

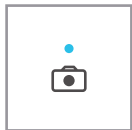
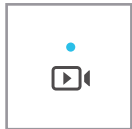

► Photo Function

- Press the Function Selection button to switch to photo mode.
- In photo mode, press the confirm button to take photos.

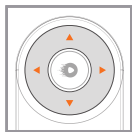

► Steering Function



- Press the Function Selection button to switch to the steering mode. In steering mode, use the up, down, left, and right directional buttons to rotate the gimbal in the corresponding direction.

► Mark Function (Available only during recording)

Mark remarkable moments manually during the shooting process to automatically generate highlight reel videos. You can view these highlight clips in the XbotGo App/Cloud Management.



- Begin recording a video.
- Switch the remote controller to marking mode.
- Press the confirmation button at the desired moment to mark the video.
- After recording, the marked time points will be indicated with a special color marker on the video timeline.



► Video Editing

- After completing the recording, select the marked video from the local files in the XbotGo App and upload it to the XbotGo cloud.
- In the XbotGo cloud management interface, click "Add Editing Task" and select the target video with markers.
 - 1) Choose the duration of the target video.
 - 2) Click "Start Editing".
 - 3) Wait for the cloud to automatically complete the editing process.
You will receive a notification when it's done (XbotGo App does not need to be in the foreground).

Note

If the remote controller's red pulsing light flashes, the buzzer alerts, or if the app displays errors or command execution failures, please follow the prompts on the app for operation.



Battery

The remote controller is equipped with a CR2032 button battery.

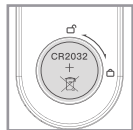

⚠ For optimal product performance:

- Please do not use different types of batteries.
- If you do not intend to use the device for more than two months, please do not leave the battery in the remote controller.

Battery Disposal:

- Do not dispose of batteries as unsorted municipal waste. Please refer to local regulations for proper battery disposal.



WARNING

THIS PRODUCT CONTAINS A BUTTON BATTERY
If swallowed, a lithium button battery can cause severe or fatal injuries within 2 hours.
Keep batteries out of reach of children.
If you think batteries may have been swallowed or placed inside any part of the body, seek immediate medical attention.

► Notes on Remote Controller

- The remote controller must be used within a range of 10 meters from the device.
- When the remote control signal is received, the app will provide pairing prompts.

10/ Apple Watch App

► User Guide

- After entering the shooting mode in the XbotGo App on your mobile device, simply start the XbotGo App on your Apple Watch to preview the camera feed from your phone on the Apple Watch screen.
- Control the gimbal's rotation direction by tapping the directional keys (up, down, left, right).



► Control Interface

Swiping left on the XbotGo App's homepage takes you to the shooting control interface.

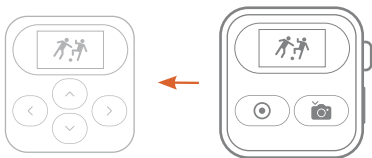

- **Video Recording:**

Tap the video recording button on the left to enter or exit video recording mode.

- **Photo Capture :**

Tap the capture button to take still photos while recording videos. Photos can be viewed in the local files section of the XbotGo App on your mobile device.

- **Tagging Function:**

Manually mark exciting moments during the shooting process to automatically generate highlight reel videos. These highlight segments can be viewed in the XbotGo app, Cloud Management, or Cloud Drive. Press the confirm button at the desired moments to mark them in the video. After shooting, special color-coded markers will appear on the video's timeline at the marked time points.

Please contact: support@xbotgo.com OR +1 (888) 894 – 1886.

Business Hours: 8:00 AM – 18:00 PM EST (M – F).

⚠ This content is subject to change.
Download the latest version from www.xbotgo.com