

Joto Pneumatic Large Format Heat Press (XSTM-40/ XSTM-48)

Model No.: E-HP-JLF-XSTM-40/ E-HP-JLF-XSTM-48

OPERATOR'S MANUAL



JOTOTM
Bringing images to lifeTM

Safety Instructions

For Use By Qualified Personnel Only

When using your Heat Press, basic precautions should always be followed, including the following:

Read all instructions.

Use heat press only for its intended use.

Always keep the heat press dry. Do not get the heat press wet to reduce the risk of electric shock. Do not store heat press in a wet/ damp area.

Never pull cord to disconnect the power. Instead, grasp plug and pull to disconnect from power outlet.

Make sure you protect the power cord by keeping it away from hot surfaces. Avoid placing objects on top of the cord. This could cause damage to the cord and could be a fire hazard risk.

Do not operate heat press with a damaged cord or if the equipment has been damaged. To prevent risks of injury, please do not disassemble or attempt to repair the heat press by yourself if you are not qualified to do so. Instead, call or take it to a qualified service person for examination and repair. Incorrect assembly or repair could increase the risk of fire, electric shock, or injury to persons when the equipment is used.

If heat press being used by or near children, please make sure that it is supervised. Do not leave equipment unattended while connected.

Metal parts on the press can become hot. Avoid touching the hot metal parts to prevent burns. Proceed with caution when using the heat press.

To reduce the likelihood of circuit overload, Joto recommends to use a dedicated circuit if possible.

Make sure that the cord is safely secured so it cannot be pulled or tripped over.

If you need to use an extension cord, make sure you use a 20 amperage rated cord. Cords rated below 20 amperage can overheat. Make sure that the extension cord is safely secured so it cannot be pulled or tripped over.

Note: This heat press should not be set to exceed 400°F (200°C). Setting the press temperature to above 400°F (200°C) may cause a fire hazard.



PLEASE KEEP THE BOX THAT YOUR HEAT PRESS ARRIVED IN, ALONG WITH ALL ORIGINAL PACKAGING.

Congratulations on your purchase of a Joto Pneumatic Large Format Heat Press XSTM-40/ XSTM-48! In order to work professionally with the machine and start production, please make sure you read this manual carefully.

Reproduction of this manual requires written consent from Joto. Errors and amendments of technical details excepted, all rights reserved. Joto is not liable for any direct or indirect damages caused by the use of this product.

Table of Contents

Safety.....	2
Introduction	3
Heat Press Overview	4
Machine Parts Diagram	5
Setting Up Your Heat Press	6
Operating Instructions	7
Maintenance	8
Heat Pressing Guide	9-10
Schematic Diagram.....	11
Expanded View	12-13
Circuit Diagram.....	14
Warranty.....	15
Contact	16

Heat Press Overview



Technical Specs

Model No.:	E-HP-JLF-XSTM-40	E-HP-JLF-XSTM-48
Machine Type:	Automatic, Double Station	Automatic, Double Station
Machine Size:	(2316 x 1458 x 1550mm)	106.96" x 65.31" x 61.02" (2717 x 1659 x 1550mm)
Heat platen Size:	32" x 40" (80 x 100cm)	40" x 48" (100 x 120cm)
Max Print Area:	Up to 32" x 40" (80 x 100cm)	Up to 40" x 48" (100 x 120cm)
Controller	GY-06 Digital Controller	GY-06 Digital Controller
Printable Materials:	Up to 6.96" (177mm) thickness	Up to 6.96" (177mm) thickness
Voltage:	380V/ 3 Phase	380V/ 3 Phase
Power:	7.5KW, 12A	9KW, 14A
Time Range:	0-999 Seconds	0-999 Seconds
Maximum Temp:	491°F (225°C)	491°F (225°C)
Packing Size:	91.18" x 57.40" x 61.02" (2316 x 1458 x 1550mm)	106.96" x 65.31" x 61.02" (2717 x 1659 x 1550mm)
Gross Weight:	2006.21 (910kg), wooden crate	2425.08lbs (1100kg), wooden crate

Note: This heat press should not be set to exceed 400°F (200°C). Setting the press temperature to above 400°F (200°C) may cause a fire hazard.

Machine Parts Diagram

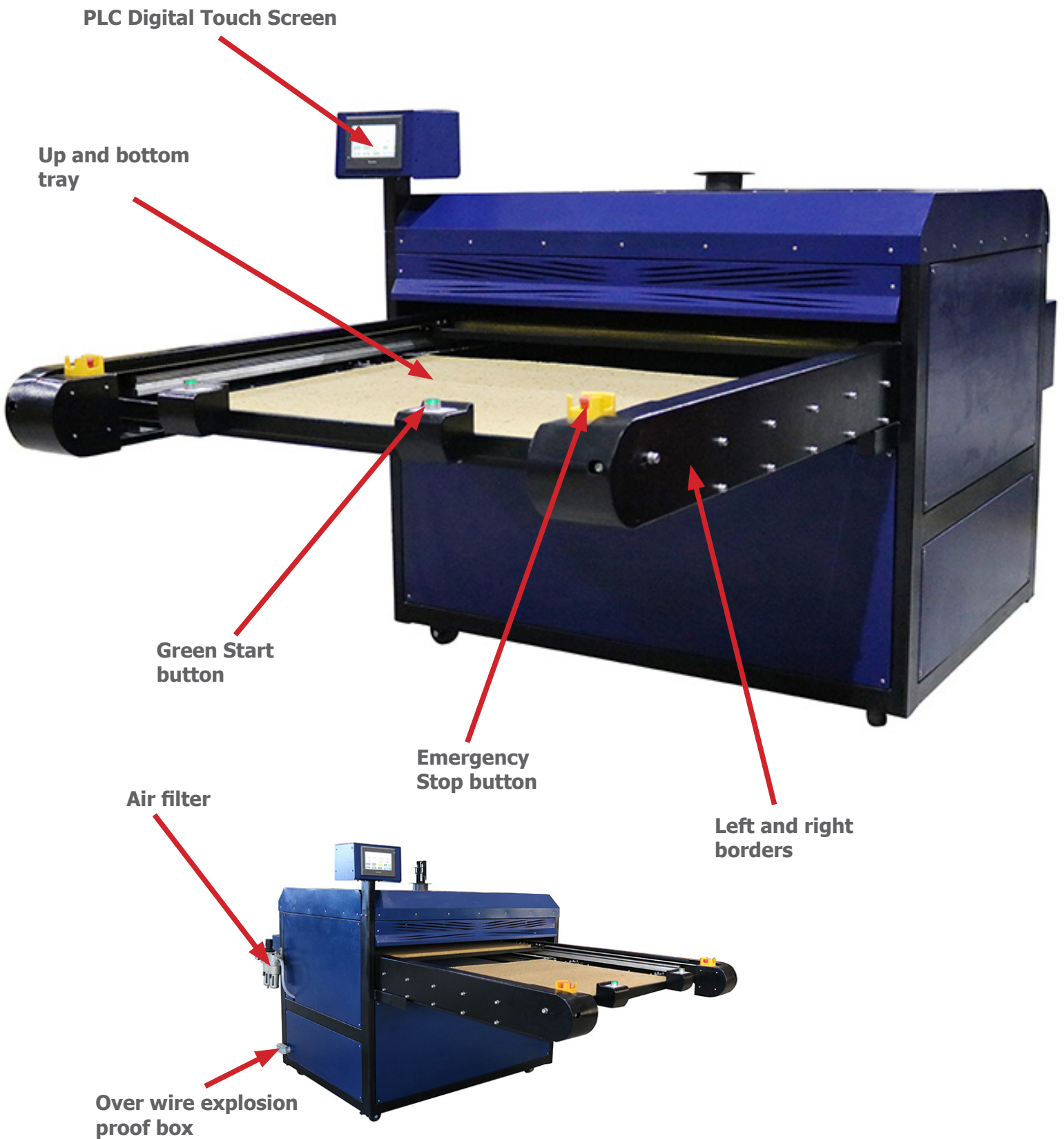

Setting Up Your Heat Press

How to adjust pressure (figure 1.1):

1. Connect the heat press with air compressor or air sources.
2. Lift up the cap of air valve as the picture four shown
3. Revolve the cap anti clockwise, the air pressure goes down; conunter clockwise, the air pressure goes up; when you finish the pressure adjustment, push down the cap.
4. Suggested air pressure is 0.6~0.8 Mpa. It depends on the transfer materials.

How to Read The Display

- 1.) Turn on Heat Press, display screen will switch on
- 2.) Right side PV value = Current Temperature
- 3.) Left side PV value = Current Time
- 4.) Right side SV value = Set Press Temperature
- 5.) Left side SV value = Set Press Time

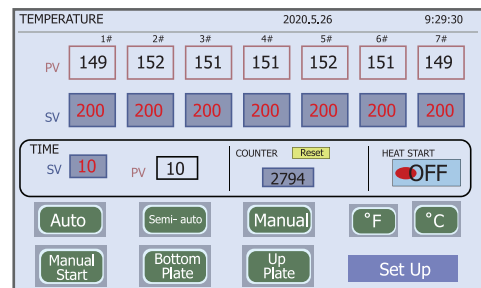

Setting Press Temperature

Press the corresponding number of SV to start. Touch the °F or °C buttons to choose to display in °F or °C.

°F stands for Fahrenheit

°C stands for Celsius

Press ENT to save and exit, CLR to clear the settings, ESC to reset.

Use keypad to set press temperature value. Press ENT to save

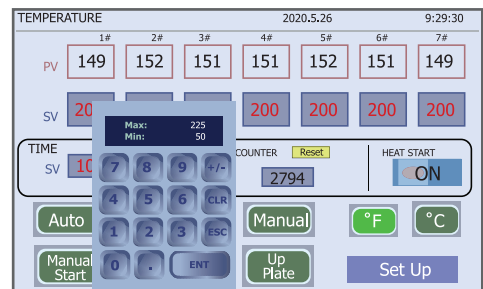

Note: Setting the press temperature to above 400°F (200°C) may cause a fire hazard.

Setting Press Time

Press the SV Time Value and a keypad will show up.

Press the numbers on the keypad change the value.

Press ENT to save the value.

Wait until the current temperature is the same as the set temperature before using. The press will beep once set temperature is reached. Close and open the press to stop the beeping.

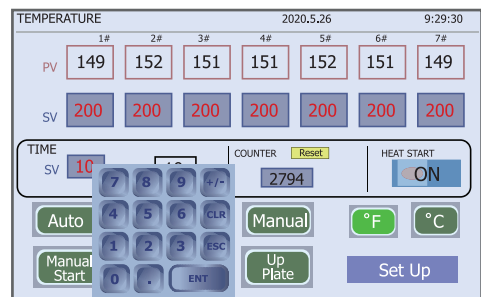

Operating Instructions

Pressing a images to your substrate

- 1.) Ensure that the air supply is connected to the press.
- 2.) Turn on the Main Power Switch.
- 3.) Adjust the air pressure to 0.6-0.8Mpa. Heat platen will open automatically.
- 4.) Draw out the under plate and place the substrate on top of the under plate.
- 5.) Set the appropriate Press Temperature, and Time as per your transfer paper, transfer vinyl or sublimation instructions.
- 6.) Wait until current temperature is the same as the set temperature. Once the press has reached set temperature, place transfer material on the shirt. For Sublimation, place the paper with the image face down. For cuttable transfer vinyl, place the matte side with the transparent carrier backing facing the heat platen. For some sublimation items, the imaged transfer paper is on the bottom with image face up while the substrate is placed on top with printable side face down. If unsure, please refer to the instructions you received with your transfer materials.
- 7.) Push the green start-up switch. The platen will close automatically. The current time value will start counting down. Once the timer reaches the last 2 seconds before reaching 0, it will start to beep to warn you. It is recommended to stand clear of the press and let the auto-open feature work without obstruction. Once time reaches zero, the press will open.

Note: Once the press is closed, it cannot be opened manually until the timer reaches zero. In an emergency, you may press the red emergency stop button to force open the press. When pressing the red emergency stop button, the press will open immediately without warning. Keep hands on the heat press handle at all times during and after pressing the emergency stop button. Not securing the handle with your hands may cause injury.

- 8.) For most sublimation and transfer vinyl, the peel is hot. If unsure, refer to the instructions that came with your transfer materials.

CAUTION: Suitable air pressure is 0.4-0.5Mpa or 75-80Psi. Do not exceed this range as too much air pressure may damage the machine, and not enough air pressure will not allow the heat platen to work properly.

Heat Pressing Guide

Transfer Vinyls

MultiCut One-4-All

Temperature: 265°F
Time: 3-5 seconds
Peel: Warm (Cotton)



MultiCut Premium

Temperature: 310-330°F
Time: 45 seconds
Peel: Warm/Cool



MultiCut New Flock

Temperature: 310-330°F
Time: 15 seconds
Peel: Warm



MultiCut Lustre

Temperature: 310-330°F
Time: 15-20 seconds
Peel: Hot to Cold



MultiCut Nylon

Temperature: 300-305°F
1st Press Time: 3-4 seconds
2nd Press Time: 10-15 seconds



MultiCut Style

Temperature: 310-330°F
Time: 15-20 seconds
Peel: Hot to Cold



For more instructions, please visit our website at www.jotoimagingsupplies.com/support/how-to-library/instructions.html

Transfer Papers

CL TrimFree Dark

(REQUIRE A WHITE TONER PRINTER)

Temperature: 310°F
1st Press Time: 120 seconds
2nd Press Time: 30 seconds



CL TrimFree Light

Temperature: 330°F
Time: 30 seconds
Peel: Warm (5-10 seconds)



Inkjet Light

Temperature: 350-365°F
Time: 20 seconds
Peel: Warm



Inkjet Dark

Temperature: 375°F
Time: 20-25 seconds
Peel: Cool



For more instructions, please visit our website at www.jotoimagingsupplies.com/support/how-to-library/instructions.html

Heat Pressing Guide

Sublimation Items

Sublimatable Ceramic Tiles

Temperature: 400°F
Time: 360-420 seconds
Peel: Hot
Method: Substrate face down
Image face up



iLumipiX Photo Panels

Temperature: 400°F
Time: 65-150 seconds

Time may varied based on size.
Scan the QR code on the left for instructions or visit our website.



Porcelain Ornaments

Temperature: 400°F
Time: 180-240 seconds
Peel: Hot
Method: Substrate face down
Image face up



Sublimatable Towels

Temperature: 360°F
Time: 120 seconds
Peel: Hot
Method: Substrate face up
Image face down



Coasters with Cork Bottom

Temperature: 400°F
Time: 75 seconds
Peel: Hot
Method: Substrate face up
Image face down



Sublimatable Pillows

Temperature: 375°F
Time: 45 seconds
Peel: Immediate
Method: Substrate face up
Image face down



Pot Holder

Temperature: 360°F
Time: 120 seconds
Peel: Immediate
Method: Substrate face up
Image face down



Sublimatable Slates

Temperature: 360°F
Time: 480 seconds
Peel: Immediate
Method: Substrate face up
Image face down



For more instructions, please visit our website at www.jotoimagingsupplies.com/support/how-to-library/instructions.html

Maintenance

General Maintenance

Please switch OFF the machine and unplug the power cord when the machine is not in use.

To protect the heat platen, do not allow any hard surface objects to be in direct contact with the platen. This includes zippers, buttons, metal sublimation items. When pressing these items, place a protective sheet between the platen and the objects.

The heat platen will cool down to the room temperature, if heat press is not used for more than 30 minutes.

The heat-releasing fan will automatically starts when the temperature of heat platen reaches 80 degree C (176 degree F). It helps to reduce the temperature of electrical parts and prolong the service life of them.

Please add the lubrication oil regularly on the joints. To prolong the life of your heat press. The frequency will depend on how often you use your machine.

Always check to ensure there is enough lubricating oil in the Cylinder.

Note: This heat press should not be set to exceed 400°F (200°C). Setting the press temperature to above 400°F (200°C) may cause a fire hazard.



If your mug press stops working, please contact Joto at 1-800-565-5686 so we can help you troubleshoot.

Schematic Diagram

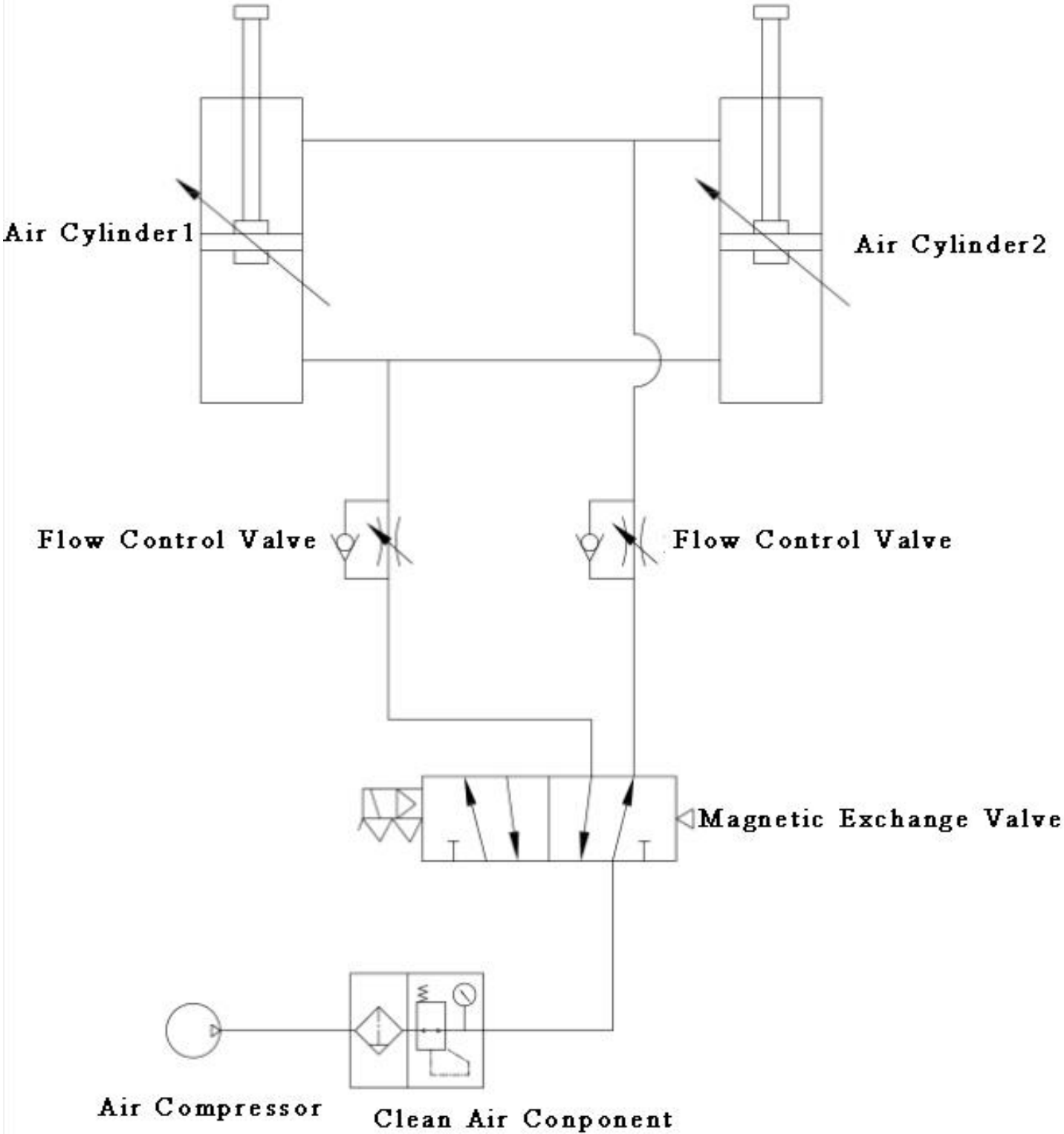

Expanded Diagram

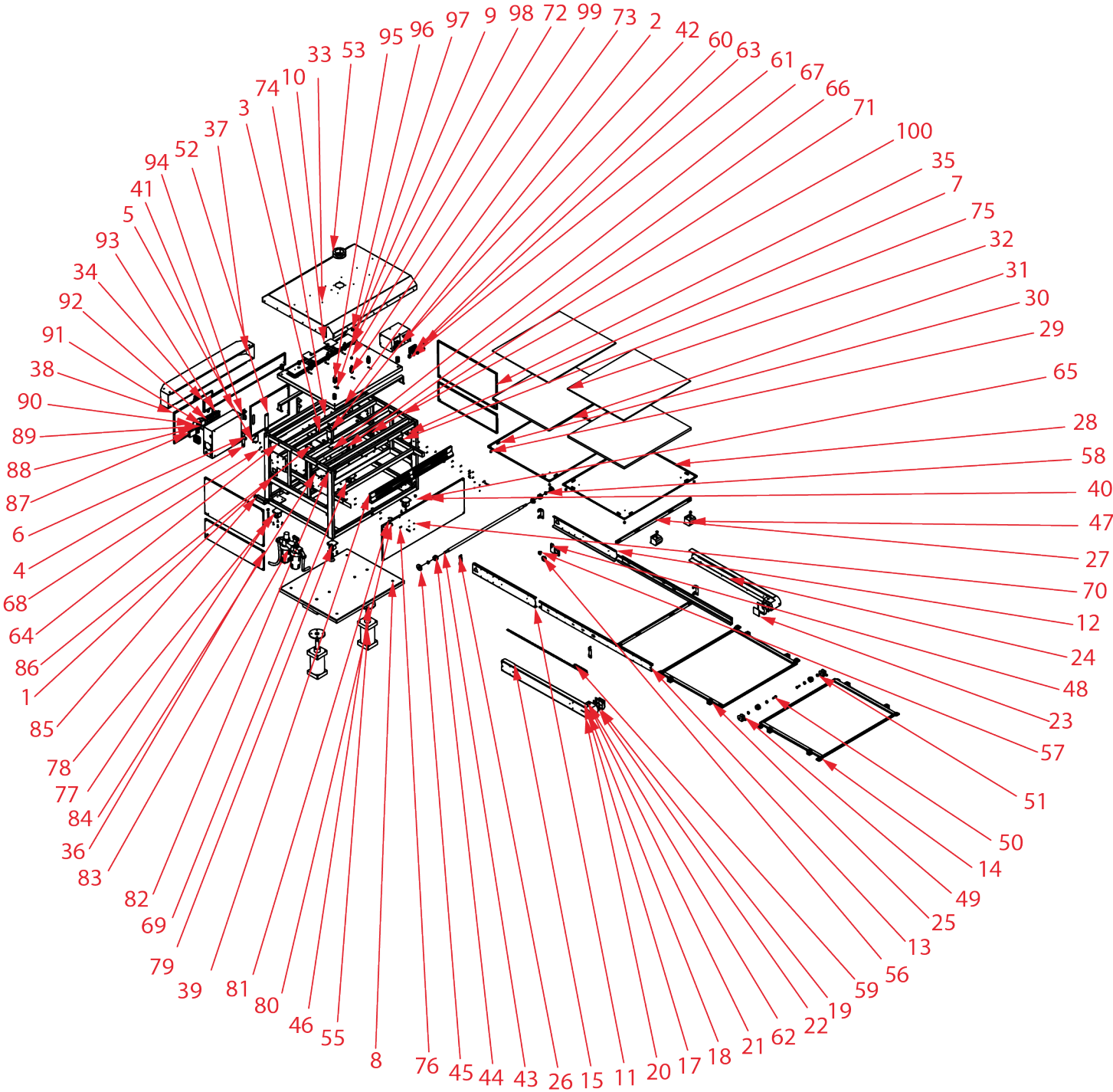

Expanded Diagram

Serial No.	Part Name	Qty
1	Top cover plate	1
2	Side plate	2
3	Silicon pad	2
4	Air cylinder	4
5	Filter	1
6	Drive rod	1
7	Rear rail fixing plate	2
8	Front rail fixing plate	2
9	Solenoid valve	2
10	Front plate	1
11	Iron pipe	12
12	Backplate	1
13	Electric box	2
14	Fixture for cooling fan	1
15	Electric box	1
16	Shield for drive shaft	1
17	Power cord	1
18	Unite box	1
19	Caster	4
20	Slide rail	4

Serial No.	Part Name	Qty
21	Fallboard for the frame	1
22	Start control box	2
23	Moving frame	2
24	Lifting board	1
25	Machine frame	1
26	Lower electric control box	1
27	Cover plate for heat platen	1
28	Fixing bolt	6
29	Upper adapter plate	1
30	Governor	1
31	Synchronous belt	4
32	Synchronizing wheel	4
33	Fixed flange	2
34	Gear	1
35	Emergency stop button	2
36	Start button	2
37	Slide block	8
38	Heat platen	1
39	Shim plate for heat platen	4
40	Tee	3

Circuit Diagram

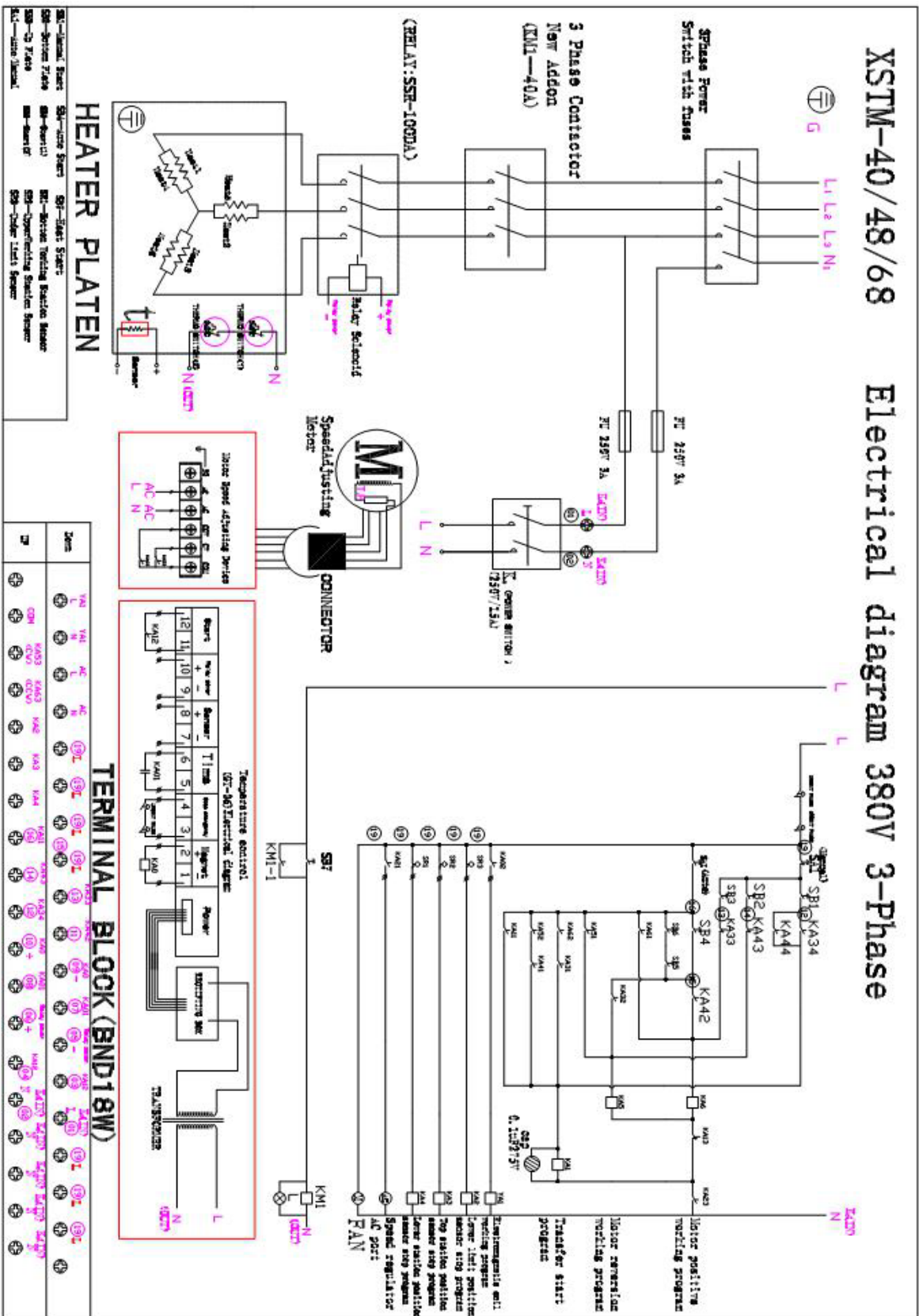

Warranty Statement

JOTO warrants to the original purchaser JOTO's E-HP-JLF-XSTM-40/ E-HP-JLF-XSTM-48 heat presses or component that such heat press or component is free from defects in materials and workmanship, subject to the limitations set forth below.

IN LIEU OF ALL WARRANTIES, EITHER EXPRESS OR IMPLIED, INCLUDING WITHOUT LIMITATION ANY IMPLIED WARRANTY OF MERCHANTABILITY OR FITNESS FOR A PARTICULAR PURPOSE, WHICH JOTO HEREBY DISCLAIMS, THE OBLIGATIONS OF JOTO UNDER THIS WARRANTY ARE EXPRESSLY LIMITED TO THE FOLLOWING:

- a. JOTO will repair or replace at its option, free of charge, any product, component of its products, and any component it sells separately which is installed in JOTO's heat presses, within twenty-four months and sixty months for the heating platen after shipment by same.
 - b. This warranty does not apply to damage incurred in shipment. Damage incurred in shipment should be reported to the designated carrier. It is the carrier's responsibility to ensure arrival in undamaged condition.
 - c. Service labor, when requested in connection with any of the above items covered by this warranty, will be charged for traveling expenses only.
 - d. This warranty applies only if the product or component proves to be defective under conditions of normal use. It does not apply to breakage or to defects resulting from accident, alteration, misuse, or improper installation.
 - e. This warranty does not include installation of the product or component.
 - f. Prior to any return of a product or component, Buyer must receive written authorization to do so from JOTO. After written authorization, Buyer shall return the defective product or component freight prepaid by the original purchaser and JOTO will ship the replacement or repaired component freight prepaid by JOTO.
 - g. This warranty is effective only if the product or component is installed in a location and manner prescribed by JOTO instructions and only if it is maintained in accordance therewith. This warranty shall become ineffective if the product or component is altered by anyone other than JOTO employees. JOTO neither assumes, nor authorizes any person to assume for it, any obligation or liability other than as specified herein.
- JOTO WILL IN NO CASE AND UNDER NO CIRCUMSTANCES BE LIABLE FOR SPECIAL OR CONSEQUENTIAL DAMAGES, LOSS OF PROFIT OR COMMISSION, OR FOR LOSS OR DELAY IN PRODUCTION.

Without limiting the generality of the foregoing, JOTO will not be liable with respect to furnishing or delay in furnishing any product or component, the use, resale or other disposition thereof, failure to furnish the same, or any other cause. JOTO liability arising out of the supply of any product or component, its use, resale or other disposition, or out of any guarantee or warranty, express or implied, or any other cause shall in no case exceed the cost to JOTO of the product or component which JOTO has agreed to supply. All liability of JOTO with respect to any product or component shall terminate upon the expiration of the twenty-four month period described above.

-Any controversy or claim arising out of or relating to transactions or orders or breach thereof, including breach of warranty, shall be settled by arbitration in Blaine, Washington, pursuant to the rules of American Arbitration Association. Any award made against JOTO shall be limited as provided above. Judgment upon award rendered by arbitration may be entered in any court having jurisdiction thereof. However, at JOTO's option, this paragraph shall not apply to collection by JOTO of the price of any product sold or any action related thereto.



**PLEASE KEEP THE BOX THAT YOUR HEAT PRESS ARRIVED IN,
ALONG WITH ALL ORIGINAL PACKAGING.**

JOTOTM

A red swoosh underline that starts under the 'O' and extends to the right, ending under the 'O'.

Bringing images to lifeTM

www.jotoimagingsupplies.com

Tel: 1-800-565-5686

Fax: 1-800-565-5622

Coquitlam, BC | Brampton, ON

Blaine, WA | Las Vegas, NV | Antioch TN