



PS-111 / GIGI-1 INNER TENT

MANUAL - Ver 2.02

EN

■ ITEMS INCLUDED

Please check the contents of the set before fully opening the tent. If you find something missing, please contact the store where you purchased it or us directly.



Tent body
x1

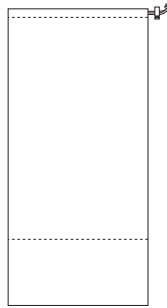

Storage case
x1

※ Not include pegs and hammer

■ ABOUT THIS PRODUCT

Please take some time to understand the characteristics of this product before using it.

Pegs not include

Pegs not include, please prepare the following recommended pegs and the required number of pegs in advance.

【Recommend · Required number】

● TO-518 / GRART STAKE 18 × 5

Do not use any open flames or fire inside tent

Chemically treated fibers are used in the fabric of this product. Chemically treated fibers may liquefy when burned, the liquefied fabric may stick to skin and cause serious burns.

Do not remove the fire prohibition tag

Do not cut or remove the fire-prohibited tag sewn into the product. Products without a fire-prohibited tag cannot be guaranteed or repaired.

■ PRECAUTIONS FOR SETUP AND USE

Be sure to read and understand the following contents before use to prevent harm to the user and others, and damage to property.



DANGER

**INDICATES CONTENT THAT MAY RESULT
IN DEATH OR SERIOUS INJURY.**

- Fire is not allowed in tents, shelters, and tarps. It is extremely dangerous as there is a risk of fire, oxygen deficiency, carbon monoxide poisoning, etc. Do not use firearms and keep fire away from tents, shelters, and tarps.
- If the weather is bad, such as a typhoon or storm, or if you anticipate such weather, stop camping immediately.
- Do not set up in a place that is easily affected by wind or where there is a risk of falling rocks, avalanches, or rising water.



**INDICATES CONTENT THAT MAY CAUSE
INJURIES OR PROPERTY DAMAGE.**

WARNING

- Not for permanent use. If this product is set up permanently, it will deteriorate and be damaged in a short period of time due to the effects of ultraviolet rays and other elements.
- Set up on a flat surface with good drainage. Moisture and dirt can lead to deterioration, and rough terrain can lead to damage to product.
- Remove any items that may damage the product, such as rocks and branches, before setting up.
- When setting up the product, be sure to have two or more people, and pay attention to surroundings.
- Do not set up when the wind is strong. The main body may blow away or product may be damaged by the force of the wind.
- When setting up, be prepared for wind gusts and be sure that the main body and frame don't fly away by keeping your hands on the frame and main body while working.
- If the weather suddenly changes hold on to the product for as long as needed to keep it down.

■ PRECAUTIONS FOR TEARDOWN AND AFTER USE CARE

Be sure to read and understand the following contents before use to prevent harm to the user and others, and damage to property.



WARNING

INDICATES CONTENT THAT MAY CAUSE MINOR INJURIES OR PROPERTY DAMAGE.

- When taking down the product, be sure to have two or more people.
- Please take down the product in the reverse order of the setup. Not following the instructions properly may damage the product.
- After use, clean the fabric and allow it to dry thoroughly before storing. If it is stored with dirt or moisture uncleaned, it may cause colors to transfer or mold odors to form, and may cause the seam tape to come off and diminish its waterproofness.

- Rope, webbing, plastic and metal parts should also be thoroughly dried before storage. If it is stored while moist or uncleaned, it may be damaged by corrosion.
- Salt can accelerate the deterioration of fabrics. If used near the sea, rinse with fresh water and dry well before storing.
- Use a soft towel to gently clean or wipe moisture off fabrics. Rubbing can damage the coating of the fabric.
- Do not use solvents such as paint thinners. There is a risk of delaminating or discoloration of the water-repellent finish.
- Please do not wash. It will lead to deterioration of the fabric and damage to other parts.
- Please keep out of reach of infants and children.

■ SETUP PROCEDURES

Set up according to the numerical order.

【Prepare in Advance】

※Ready Pegs and Hammer

Recommnd pegs · Required number > TO-518 / GRART STAKE 18 × 5

※Close all zippers

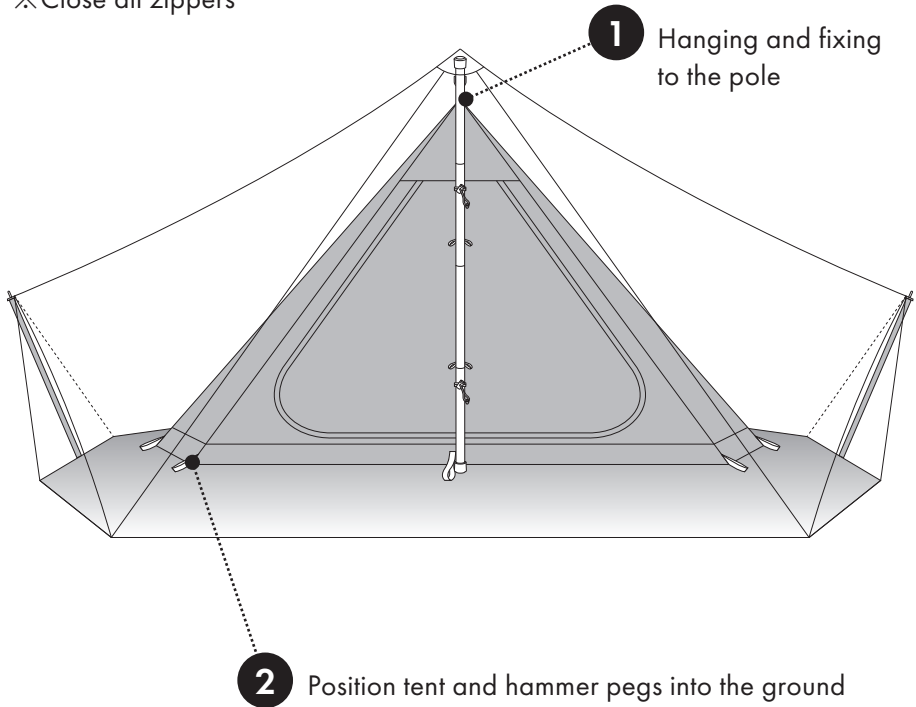

1 HANGING AND FIXING TO THE POLE

A: Set up for GIGI-1 and GIGI-2 are the same (illustration below is for GIGI-1).

B: Attach the hook on the upper part of the inner tent to the center pole of GIGI-1 or the main pole of GIGI-2, adjust the height as needed with the adjuster.

C: Fix the inner tent to the center pole with included cords. (2 places).

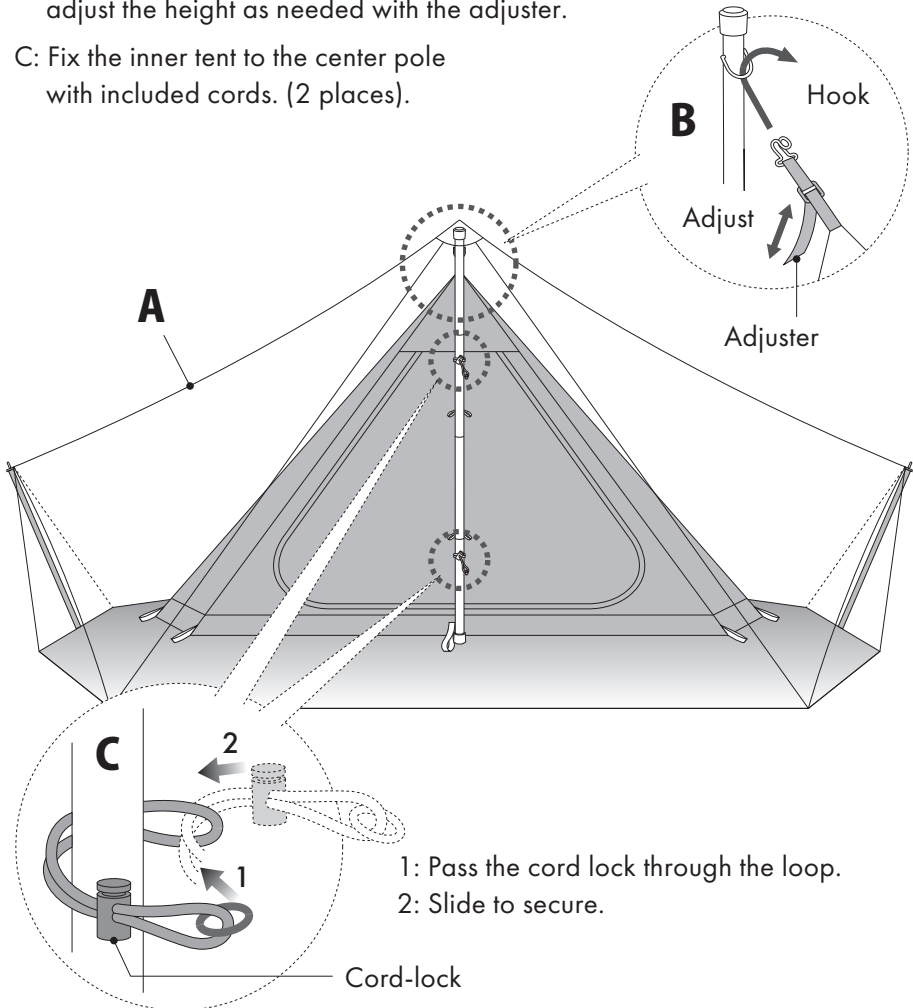

2 -1 POSITION TENT AND HAMMER PEGS INTO THE GROUND

Choose where to position the inner tent

GIGI-1 can be set up in 2 variations.
(Front) and (Diagonal).

GIGI-2 can be set up in 2 variations.
(Side) and (Diagonal)

Basic setting.

【GIGI-1】

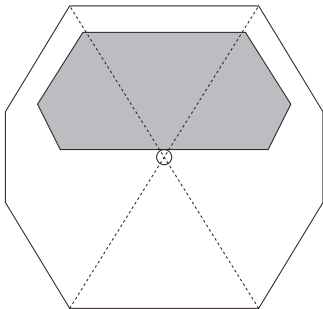

Front

【GIGI-2】

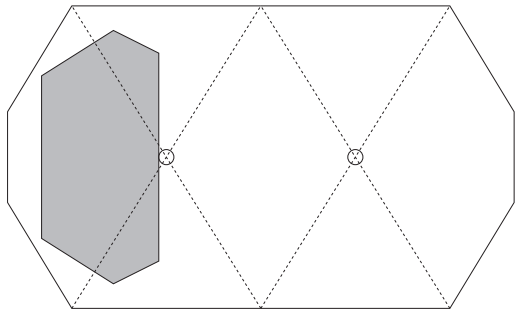

Side

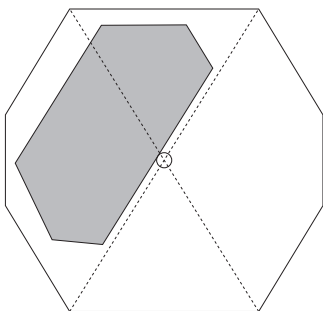

Diagonal

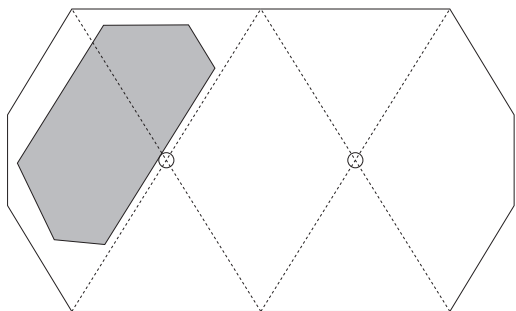

Diagonal

2 -2 POSITION TENT AND HAMMER PEGS INTO THE GROUND

Drive pegs through loops in numerical order (8 locations).

