



LT-003 / ZIG

MANUAL - Ver 1.01

EN

Please be sure to read the manual before using this product. If you have any questions or if there is a problem with the product, please contact the store where you purchased it or ZANE ARTS directly.

■ PARTS

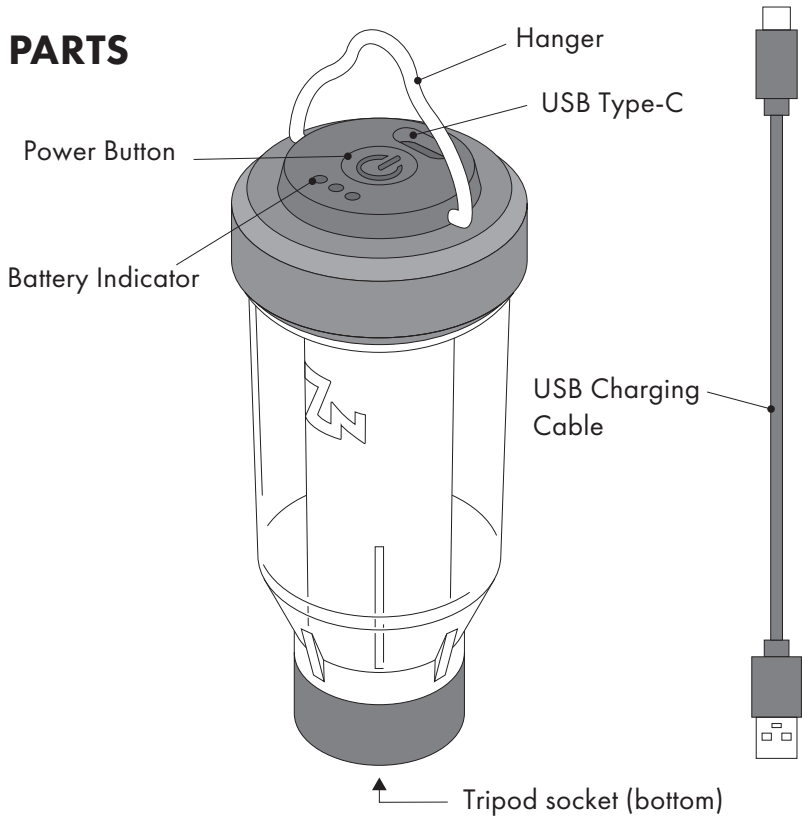

※ The bottom features an integrated standard 1/4-20 UNC camera tripod socket.

※ Overtightening could cause damage.

■ ABOUT THIS PRODUCT

Please familiarize yourself with this product before use.

It is dangerous to charge when the USB port is wet.

Do not plug in the USB charging cable when the USB port is wet. Doing so may cause an electric shock or malfunction.

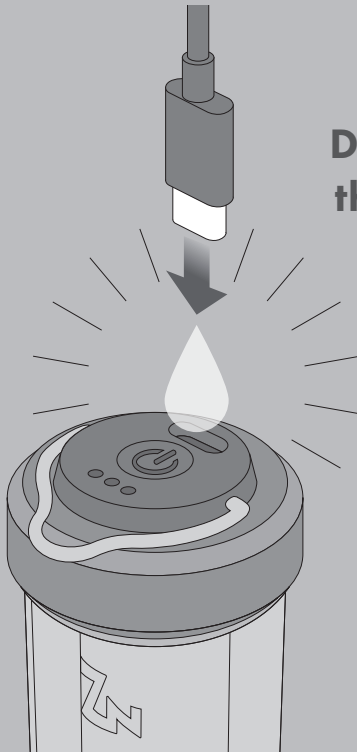

**Do not charge when
the USB port is wet!**

About the USB Charging Cable

- To unplug during or after charging is complete, always unplug the USB cable first from the lantern. If it is unplugged from the outlet, the battery indicator will temporarily display an error.

About the Lithium-ion Battery

- This product uses a lithium-ion battery.
- Please charge before using for the first time.
- The battery's charge will gradually reduce over time even when not in use. If the lantern has been stored or unused for a long period of time, charge before use.
- Do not store when the battery is fully charged or extremely low. Doing so may reduce the performance and life of the battery.
- If not used frequently, please charge the battery every three months.

Lithium-ion Battery Disposal

- Please follow the instructions of your local government regarding proper disposal.

About the LED Lights

- Due to the nature of LEDs, the color and brightness of each product may differ.
- Battery voltage may drop depending on the environment and may affect brightness.
- Can be powered directly from a USB cable, however the lights will dim in order to prevent overheating.

For use in Japan only.

- For use in Japan only. Warranty and repair are not covered outside of Japan.

■ HANDLING PRECAUTIONS

Please follow these guidelines to avoid property damage and to ensure the safety of yourself and others.



**INDICATES SITUATIONS THAT COULD
RESULT IN SERIOUS INJURY OR DEATH.**

WARNING

- Do not use, charge, or store in the following places. Doing so may cause fire, electric shock, injury or malfunction.
- Near water, such as in the rain or a bathroom.
- Humid environments.
- Near open flames or in direct sunlight (places over 40°C)
- Near heaters and places that easily get hot.
- Places where small children can reach.
- Do not expose to any strong impact, pressure, or vibration. May cause risk of damage, fire, swelling, explosion, leakage, or chemical burns.

- Do not disassemble or modify. Doing so may cause electric shock, fire, accident or injury.
- Do not pour liquids on the product or operate it with wet hands. Doing so may cause an electric shock or malfunction.
- Do not use under a cloth such as a blanket or sleeping bag. Doing so may cause fire, electric shock, or injury.
- If the rechargeable battery leaks, immediately stop using it and do not allow the liquid to come in contact with your skin or eyes. Skin damage and blindness may occur. In case of skin or eye contact, wash thoroughly with water and seek medical attention.
- Do not damage the USB charging cable by pulling, bending or stepping on it. Fire or electric shock may result.



**INDICATES SITUATIONS THAT COULD CAUSE
MINOR INJURY OR PROPERTY DAMAGE.**

CAUTION

- Do not use chemicals such as alcohol, gasoline, or benzine on this product. It may cause damage to the main unit or injury.
- Do not look directly at the light source. It may hurt your eyes or cause physical discomfort.
- The bottom features an integrated standard 1/4-20 UNC camera tripod socket. Using different sized screws may cause damage.
- When mounting to a tripod be careful not to overtighten as this may damage the socket.

HOW TO USE

1 TURNING THE LANTERN ON AND OFF

[On] : Long hold the power button for more than 1 second.

[Off] : Long hold the power button for more than 1 second.

Follow the guide below to change modes

 Long hold
(> 1 sec)
to turn on

 Short press
(< 1 sec after previous action)
to choose the amount of LEDs

 Short press
(>1 sec)
to dim

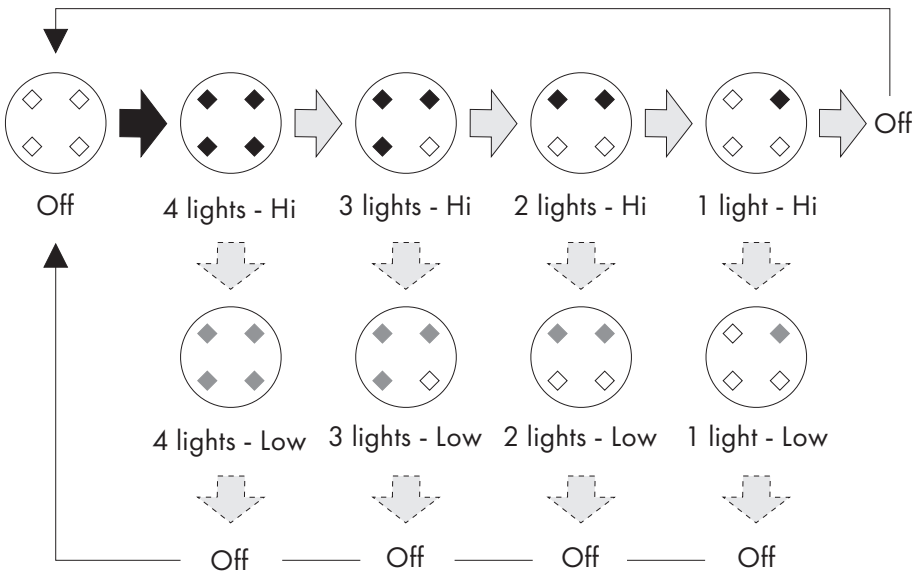

● lighting time / Brightness

	4 lights	3 lights	2 lights	1 light
Hi	200lm/7h	150lm/10h	100lm/14h	50lm/35h
Low	100lm/14h	75lm/20h	50lm/28h	25lm/55h

2 CHECKING THE BATTERY LEVEL

Lights indicate the remaining battery level.

● Battery level displays when on

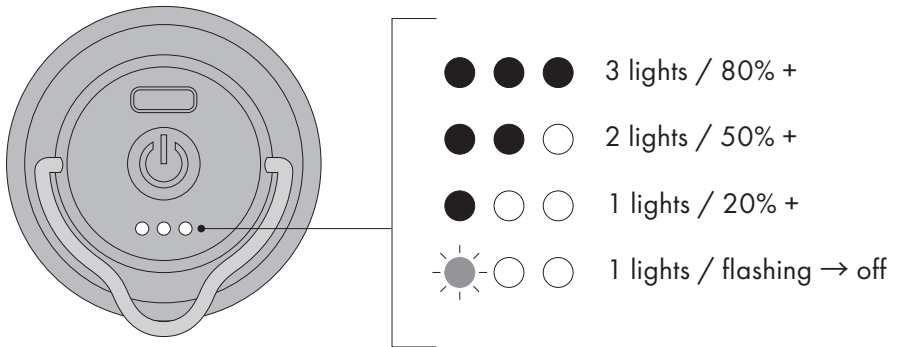

3 HOW TO CHARGE

Plug the USB cable (included) into the USB port on the top of the lantern.
A full charge will take about 3.5 hours.

※ Please use a charging adapter of 5V/1.0A or higher.

※ Charging only occurs when lights are off.

Lantern must be off in order to charge.

● Lights indicate charging status

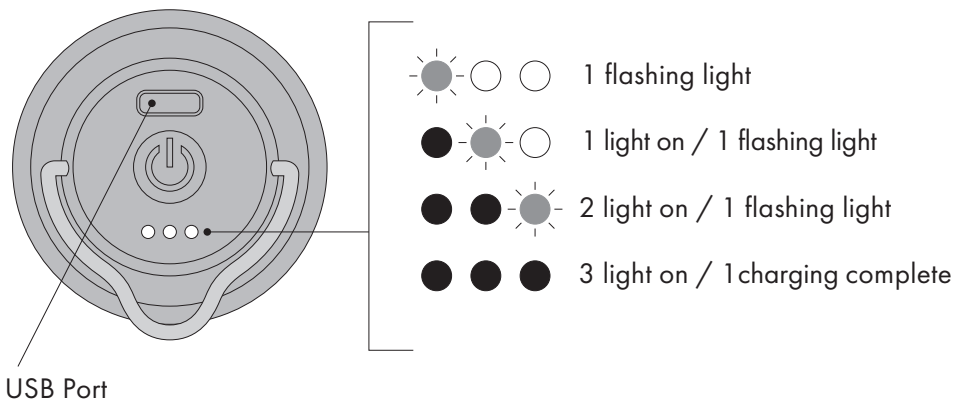

4 ERROR INDICATOR

●When On

An error may occur when the lantern is used outside of the ideal operating temperature. When an error occurs the battery indicator will flash rapidly, the lantern will automatically reset, and turn off.

After the lantern turns off it should turn on again as usual.

If it does not there might be a malfunction, please contact the store where you purchased it or ZANE ARTS directly.

●When charging

The battery will not charge if too hot or too cold.

(Charging temperature range 0°-35°C)

The indicator will flash rapidly and the battery will not charge, even when plugged into a USB port, if the battery temperature is lower or higher than the ideal charging temperature range.

The battery will resume charging when it returns to the ideal charging temperature range and the rapid flashing lights will return to charging status.

5 CARE INSTRUCTIONS

Wipe any noticeable dirt away with a soft cloth.

Using an abrasive material or rubbing too hard may scratch the surface.

■ WARRANTY AND REPAIR

If you find any defects in the product, please contact the store where you purchased it or us directly. We will replace or repair any item found to have a manufacturing defect free of charge. We will repair products with damage caused by wear and aging at a reasonable price. Please note that it may be difficult to obtain some materials due to the discontinuation of products and parts, and repairs may not be possible based on the condition of the product.

※ When sending a product for repair, please remove dirt and moisture from the product before sending it. Moisture and dirt may interfere with repairs. Items that are not clean and dry upon arrival for repair will incur additional charges at their own expense for cleaning. Thank you for your understanding.

ZANE ARTS, Inc.

7190-2 Shimauchi, Matsumoto, Nagano 390-0851

info@zanearts.com