



DT-002 / OKITOMA-2

MANUAL - Ver 2.03

EN

## ■ ITEMS INCLUDED

Please check the contents of the set before fully opening the tent. If you find something missing, please contact the store where you purchased it or us directly.

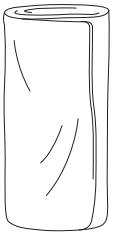

Fly Sheet  
×1



Inner Tent  
×1



Bridge Frame × 2

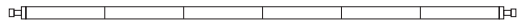

Long Frame × 2

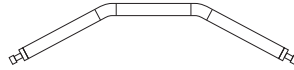

Short Frame × 2

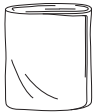

Footprint  
×1

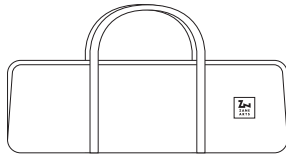

Carrying Case ×1

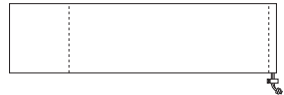

Pole Bag ×1

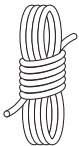

2.5m  
Rope  
×12

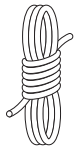

1.5m  
Rope  
×4



Repair  
Pipe  
×1

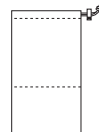

Peg · Rope  
Case  
×1

※Peg · Hammer is not include

## ■ ABOUT THIS PRODUCT

Please take some time to understand the characteristics of this product before using it.

---

Pegs not include

---

Pegs not include, please prepare the following recommended pegs and the required number of pegs in advance.

【Recommend · Required Number】

● TO-518 / GRART STAKE 18 × 20

---

Waterproofing performance is reduced

---

The surface is treated with silicone water repellent, but after use, the water repellent performance will deteriorate and rain will eventually penetrate the fabric. Please note that the water repellency cannot be maintained long term. Waterproof performance of the back side is not affected, so even if water repellency deteriorates, there is no issue using it as it is.

---

Wrinkles caused by folding are noticeable

---

Commonly used chemically treated fibers used in tents, shelters and tarps are prone to creases. In particular, the fabric in this product has noticeable wrinkles due to the color, thickness, and surface processing of fabric. Please note that it does not affect performance in any way.

---

For 3 seasons of use

---

This product is not designed to withstand snowfall or low temperatures. Do not use in low temperatures where the zippers may freeze or in snow.

---

Use of a wood stove is absolutely prohibited.

---

Chemically treated fibers are used in the fabric of this product. Chemically treated fibers may liquefy when burned, the liquefied fabric may stick to skin and cause serious burns. Never bring fire close to tents, shelters or tarps.

---

Do not remove the fire prohibition tag

---

Do not cut or remove the fire-prohibited tag sewn into the product. Products without a fire-prohibited tag cannot be guaranteed or repaired.

## ■ PRECAUTIONS FOR SETUP AND USE

Be sure to read and understand the following contents before use to prevent harm to the user and others, and damage to property.



**DANGER**

---

**INDICATES CONTENT THAT MAY RESULT  
IN DEATH OR SERIOUS INJURY.**

---

- Fire is not allowed in tents, shelters, and tarps. It is extremely dangerous as there is a risk of fire, oxygen deficiency, carbon monoxide poisoning, etc. Do not use firearms and keep fire away from tents, shelters, and tarps.
- If the weather is bad, such as a typhoon or storm, or if you anticipate such weather, stop camping immediately.
- Do not set up in a place that is easily affected by wind or where there is a risk of falling rocks, avalanches, or rising water.



---

**INDICATES CONTENT THAT MAY CAUSE  
INJURIES OR PROPERTY DAMAGE.**

---

**WARNING**

- Not for permanent use. If this product is set up permanently, it will deteriorate and be damaged in a short period of time due to the effects of ultraviolet rays and other elements.
- Set up on a flat surface with good drainage. Moisture and dirt can lead to deterioration, and rough terrain can lead to damage to product.
- Remove any items that may damage the product, such as rocks and branches, before setting up.
- When setting up the product, be sure to have two or more people, and pay attention to surroundings.
- Do not set up when the wind is strong. The main body may blow away or product may be damaged by the force of the wind.
- When setting up, be prepared for wind gusts and be sure that the main body and frame don't fly away by keeping your hands on the frame and main body while working.

- When extending poles or frames, make sure each section is inserted securely. Assembling the product incorrectly can lead to damage.
- When handling poles or frames, be careful not to hit or damage something around you and pay attention to your surroundings.
- After setup, secure the tent, shelter, and tarp to the ground with pegs and ropes to prevent them from being blown away by the wind.
- If the weather suddenly changes hold on to the product for as long as needed to keep it down.



## ■ PRECAUTIONS FOR TEARDOWN AND AFTER USE CARE

Be sure to read and understand the following contents before use to prevent harm to the user and others, and damage to property.



**WARNING**

---

**INDICATES CONTENT THAT MAY CAUSE MINOR INJURIES OR PROPERTY DAMAGE.**

---

- When taking down the product, be sure to have two or more people.
- Please take down the product in the reverse order of the setup. Not following the instructions properly may damage the product.
- When removing poles or frames, be careful not to hit or damage something around you and pay attention to your surroundings.

- When folding a frame or pole with a built-in cord (cord), begin folding from the center, this will reduce the wear on the bungee cord by not applying extra tension to the cord.

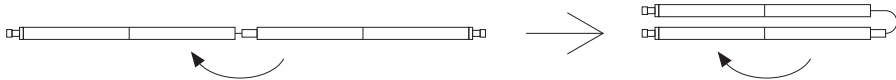

- After use, clean the fabric and allow it to dry thoroughly before storing. If it is stored with dirt or moisture uncleaned, it may cause colors to transfer or mold odors to form, and may cause the seam tape to come off and diminish its waterproofness.
- Frames, poles, and other metal parts should also be thoroughly dried before storage. If stored while moist or uncleaned, they may be damaged by corrosion.
- Salt can accelerate the deterioration of fabrics. If used near the sea, rinse with fresh water and dry well before storing.
- Use a soft towel to gently clean or wipe moisture off fabrics. Rubbing can damage the coating of the fabric.
- Do not use solvents such as paint thinners. There is a risk of delaminating or discoloration of the water-repellent finish.
- Please do not wash. It will lead to deterioration of the fabric and damage to other parts.
- Please keep out of reach of infants and children.

# ■ SETUP PROCEDURES

Set up according to the numerical order.

【Prepare in Advance】

※Ready Pegs and Hammer

Recommned pegs > TO-518 / GRART STAKE 18 × 20

※Close all zippers

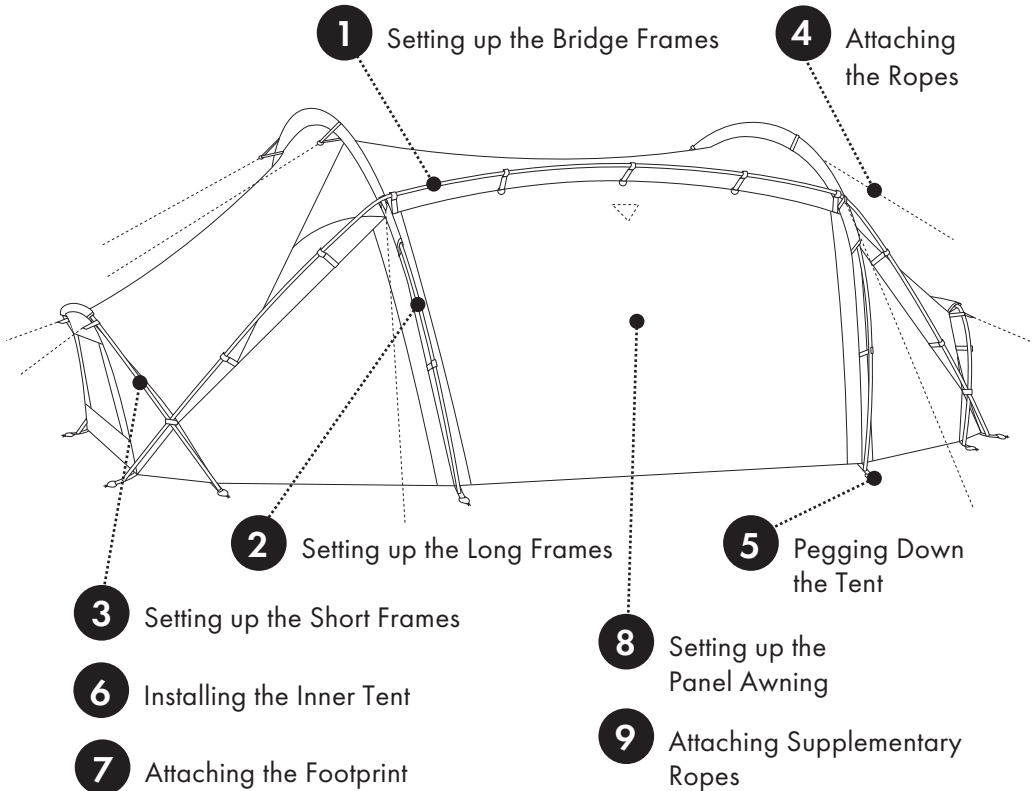

# 1 SETTING UP THE BRIDGE FRAMES

Assemble all frames (6 in total)

A: Take the long frame with gray ends and insert it into the grommets in the webbing that has gray rope attached to it. (both ends)

B: Attach clips (9 locations) to first frame.  
Repeat on other frame.

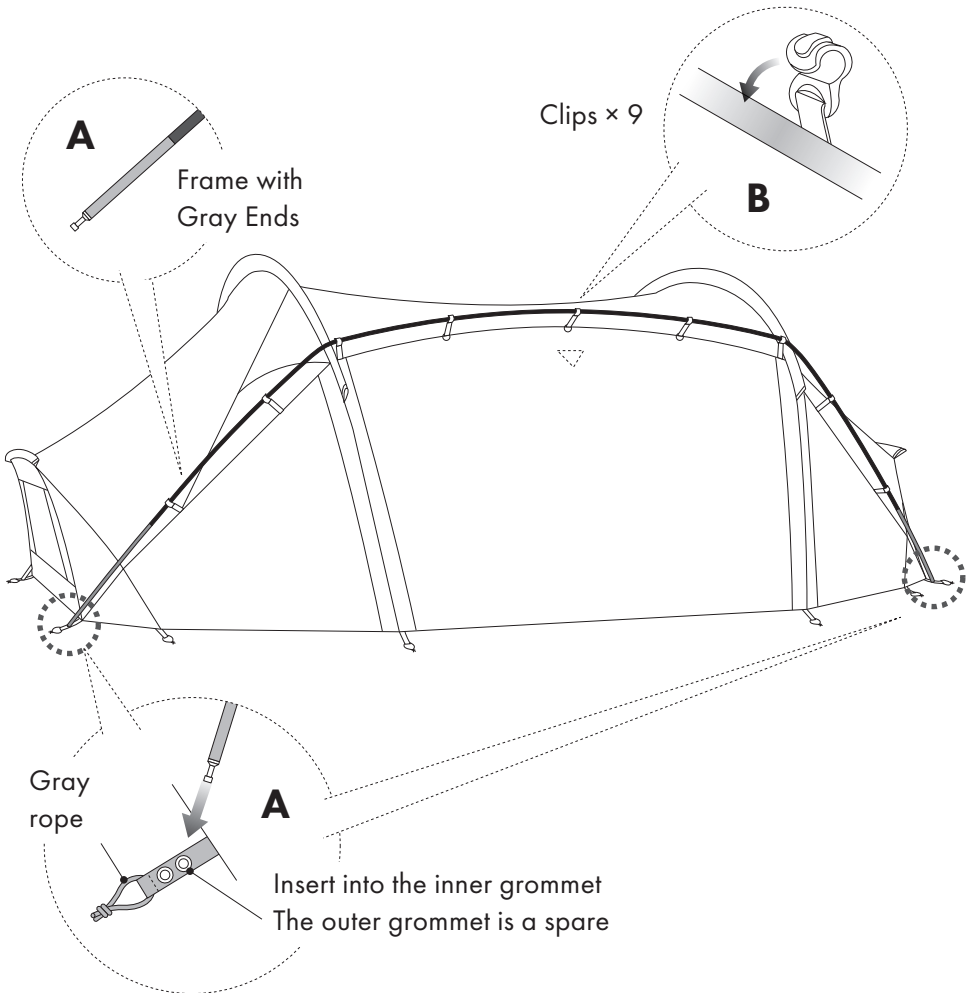

## 2 SETTING LONG FRAME

A: Insert long frames into upper sleeves.

B: Insert both ends into grommets.

C: Attach clips (2 locations) to first frame.  
Repeat on other frame.

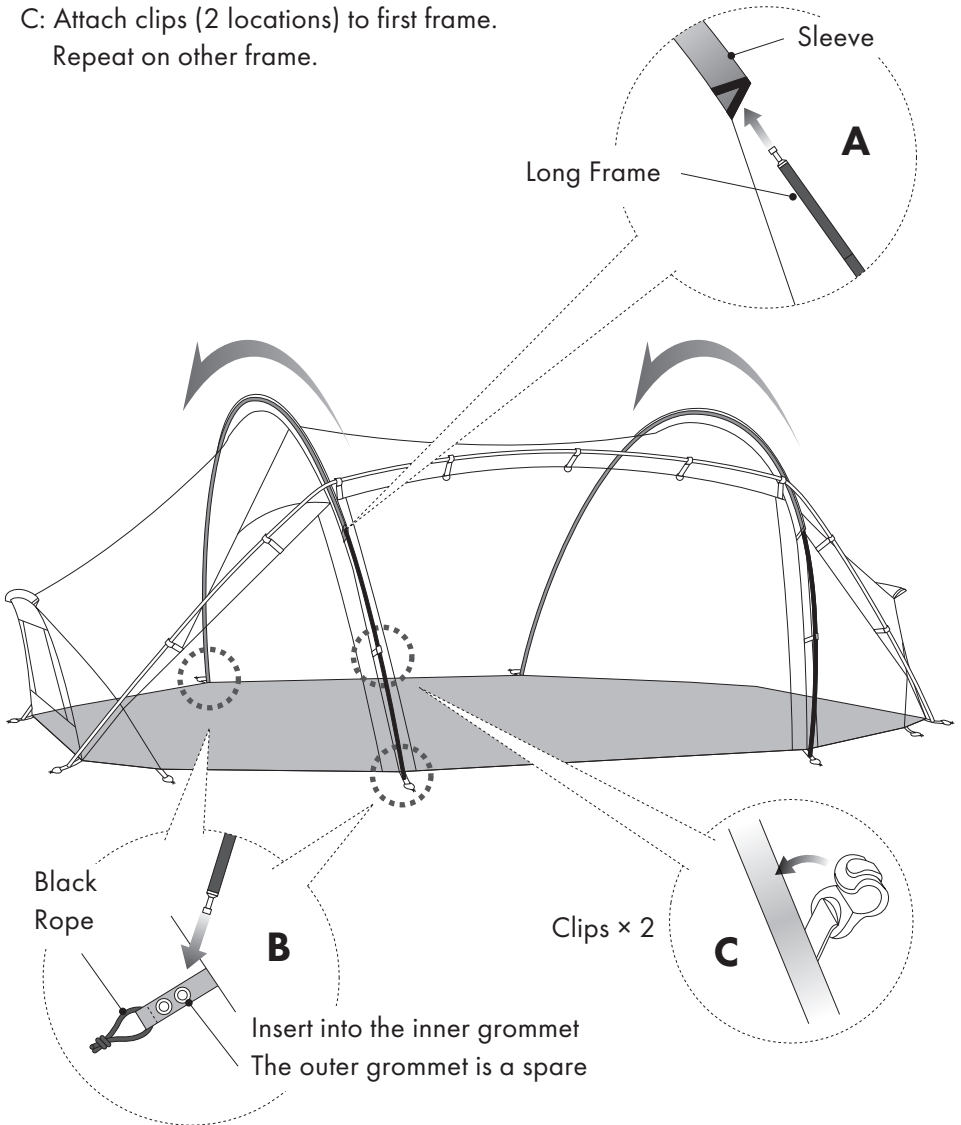

### 3 SETTING UP THE SHORT FRAMES

A: Insert remaining short frames into side sleeves.

B: Insert both ends into grommets.

C: Clip and wind the intersection (2 locations)

Repeat on both sides.

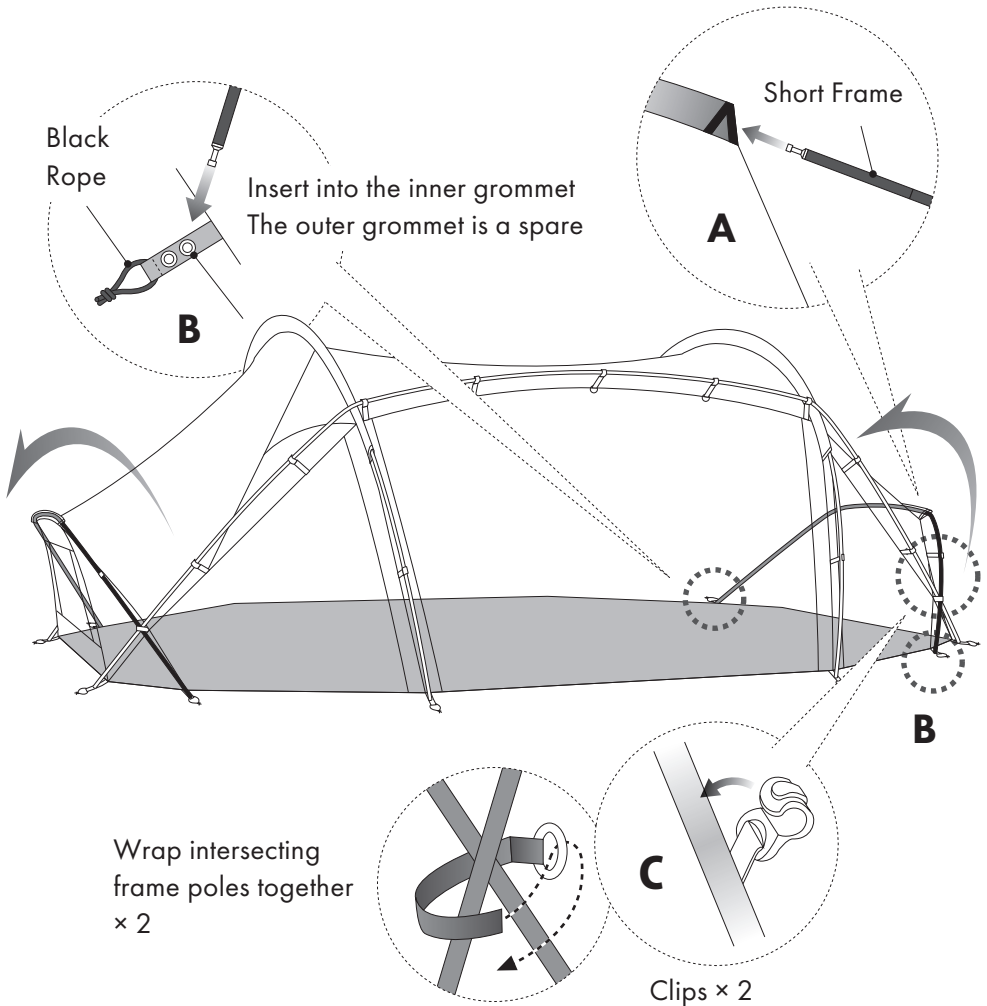

## 4 ATTACHING THE ROPES

A: Wrap webbing loop around frame (8 locations)

B: Attach a 2.5m rope to the end of the webbing or to the ring (8 locations).

C: Attach a 1.5m rope to the end of the webbing (4 locations).

Setting rope

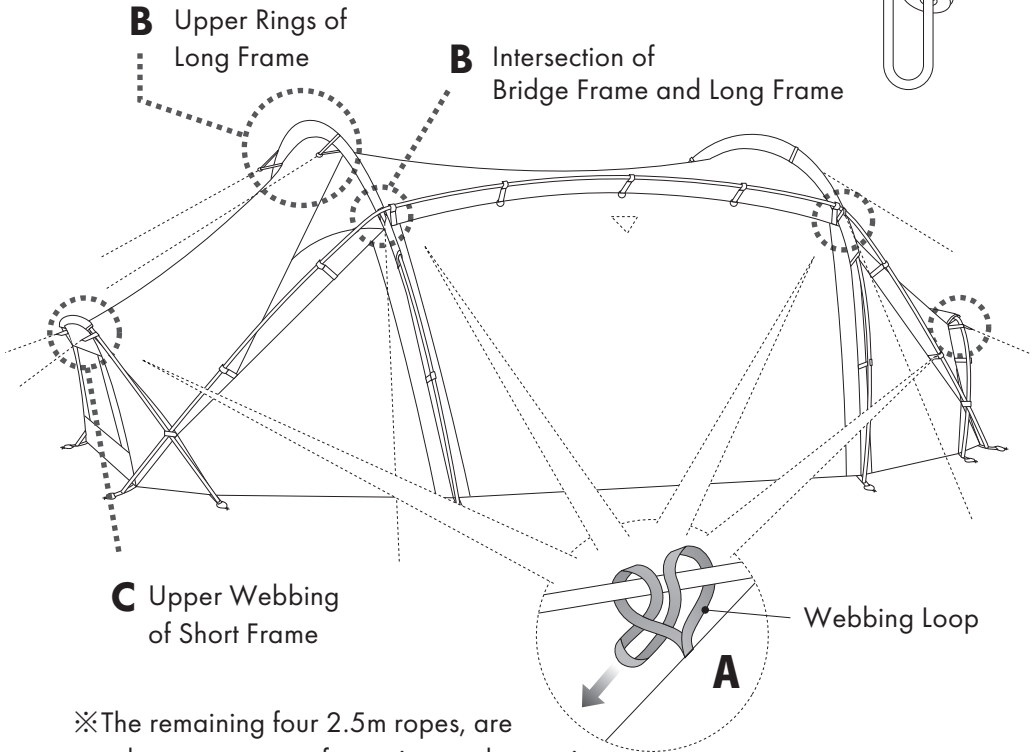
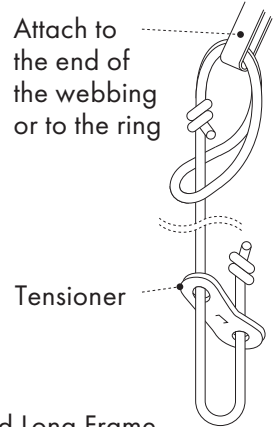

※The remaining four 2.5m ropes, are supplementary ropes for setting up the awning or stabilizing the tent in windy conditions.

## 5 DRIVE PEGS

Drive pegs into the ground in numerical order

A: Peg down sections 1-4, then peg down sections 5-8 while pulling in the direction of the arrows.

B: Peg down sections 9-12 without over-tensioning. Then peg down the tension cords in sections 13-20. Installation complete.

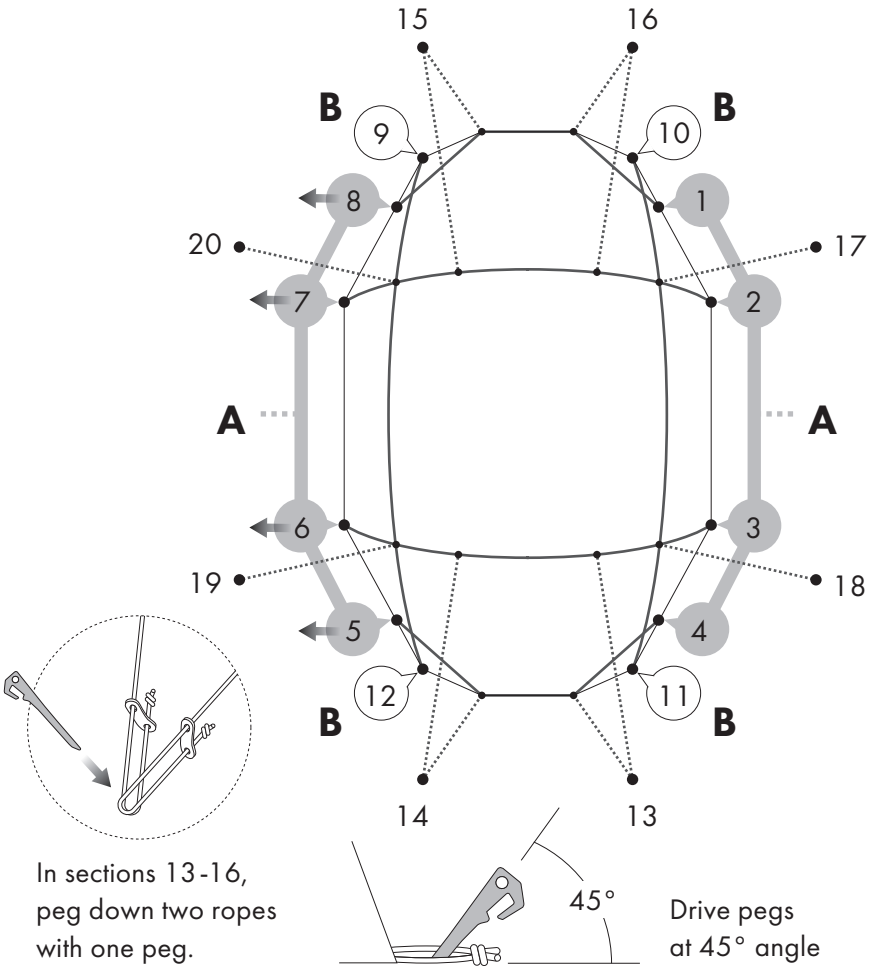



## 6 -1 INSTALLING THE INNER TENT (PREP)

A: Determine the front and back of the inner tent.

The side with the logo is the front.

※The main tent is symmetrical, so it can be installed either way.

B: The two bottom corners on the front can either be pegged down or hooked into place. When pegging down always unfasten the buckle first and then peg down the corner rope.

※When using the hook to attach, be sure the buckle is fastened.

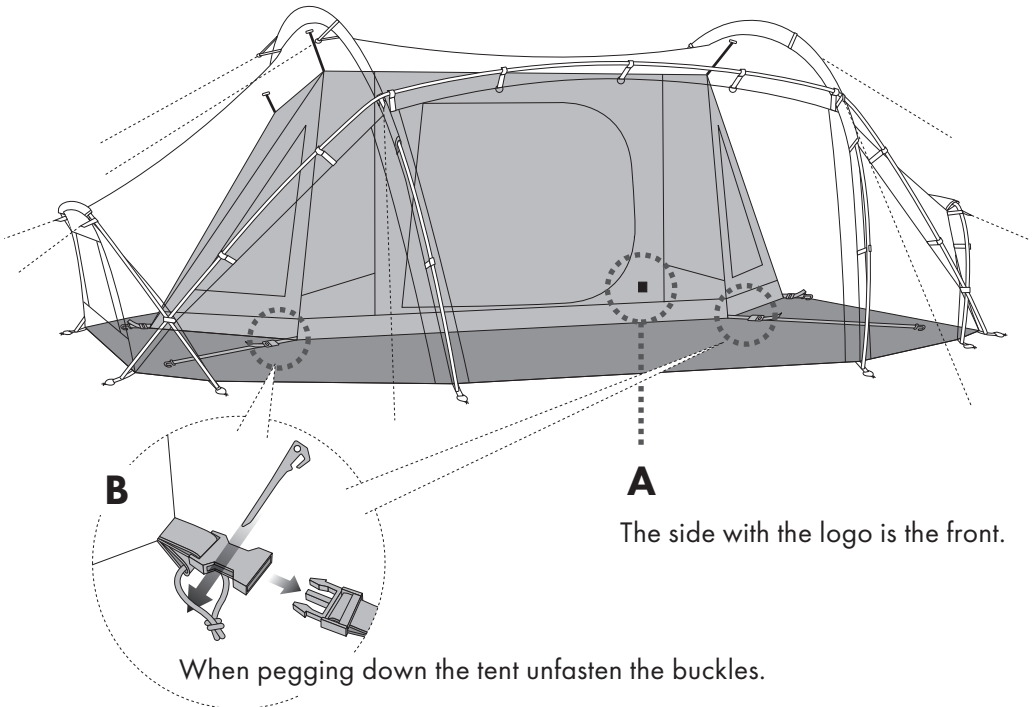



## 7 -1 INSTALLING THE FOOTPRINT (PREP)

A: Determine the top and bottom of the footprint. The shiny side is the top.

B: When using the protective sheet as a base for the inner tent, place it under the inner tent. When using it as a living sheet, lay it in front of the inner tent.

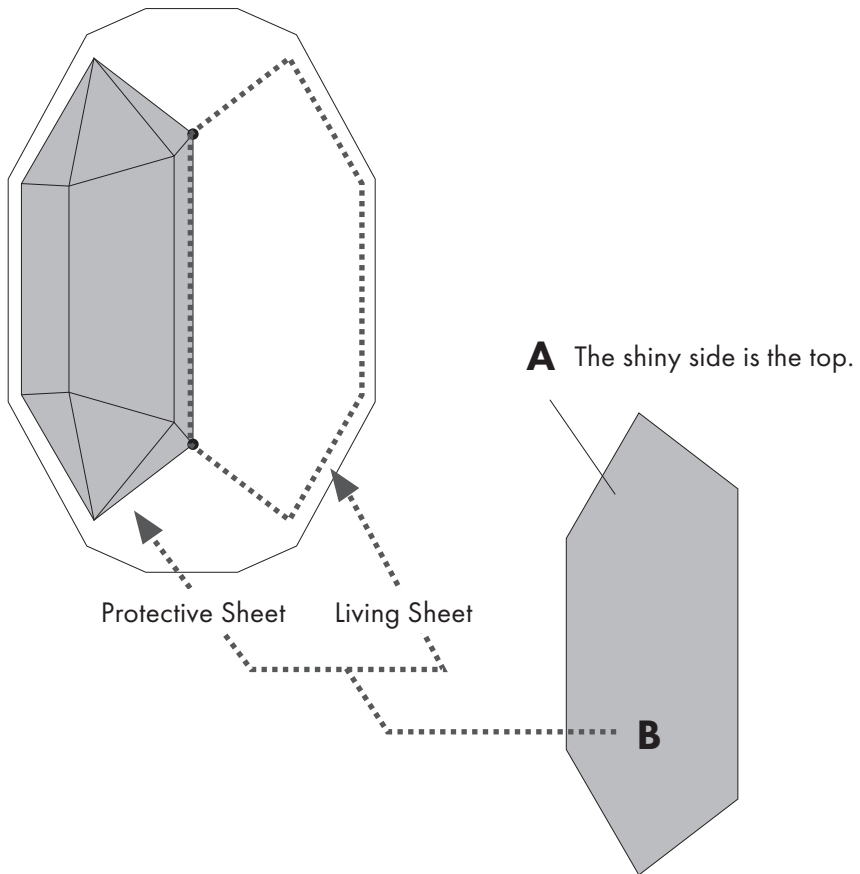

## 7 -2 INSTALLING THE FOOTPRINT

C: Wrap the elastic loops from each corner around the pegs holding down the main tent.

D: When using the protective sheet as a base for the inner tent, unfasten the buckle at the D ring, pass the webbing through the elastic loop and refasten.

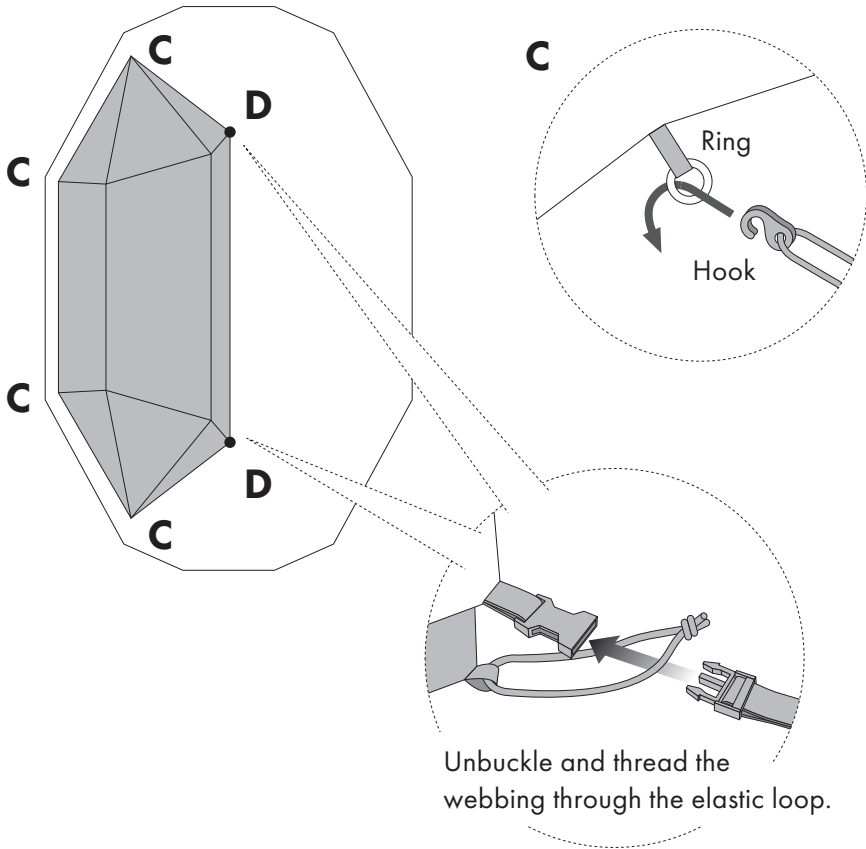

## 8 SETTING UP THE PANEL AWNING

※The two poles and two pegs required to set up the panel awning are sold separately.

A: Insert the tip of the pole into the corner ring of the main panel.

B: Use the 2.5m rope to peg down.

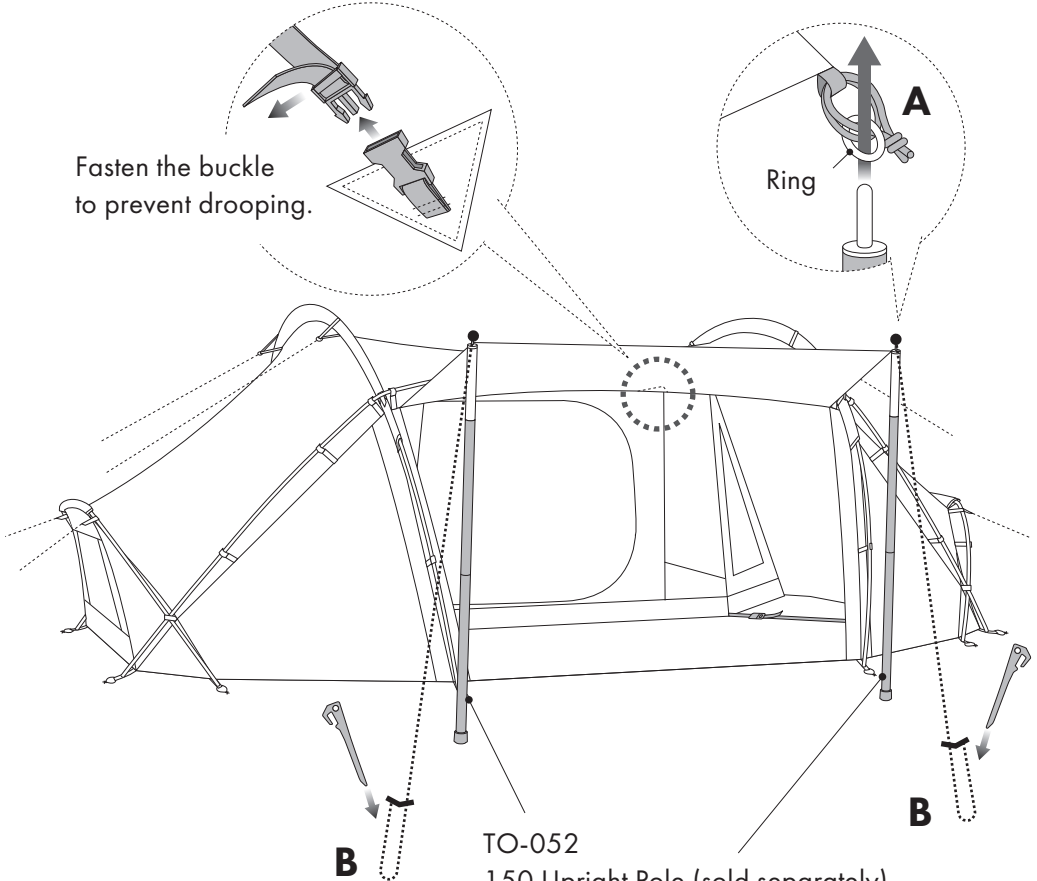

※Any two poles extended to 120cm can also be used.

## 9 ATTACHING SUPPLEMENTARY ROPES

The tent can be stabilized on windy days by attaching the 2.5m ropes to the metal rings (3 rings per side) located on the clips attached to the center of the bridge frame.

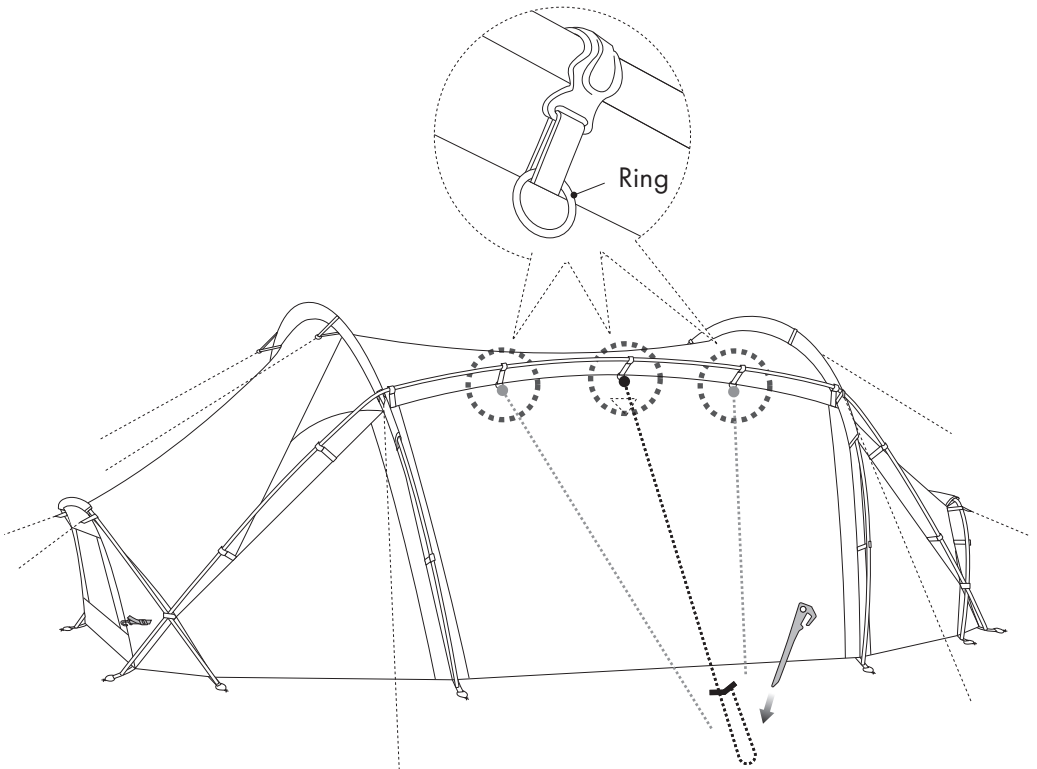

Attach a rope to the center point or to the two adjacent points and peg down.