

DHV4



HEAD VALVE ASSEMBLY

(HVG1 Gasket Included)

Ref	Item No.	Description
1	DX133	Bushing
2	DX132	Metal Gasket
3	DX131	Body
4	D772	Lock Nut
5	DV171	Hex Screw, Washer & Nut
6	DR129	Fulcrum
7	DR127	Valve Stem
8	D727	Lever Pin & Cotter Pin
9	DR122A	Screw Plug
10	DR126	Handle
11	HS-N	Head Spring
12	DR128	Stem Guide
13	DH-T	Disc Holder

Specifications

- 125 lbs. WSP @ 350° F Max.
- 400 lbs. WOG
- NPT Threaded Ends

Features

- Brass Body
- 100% Leak & Pressure Tested
- PTFE Gasket Included

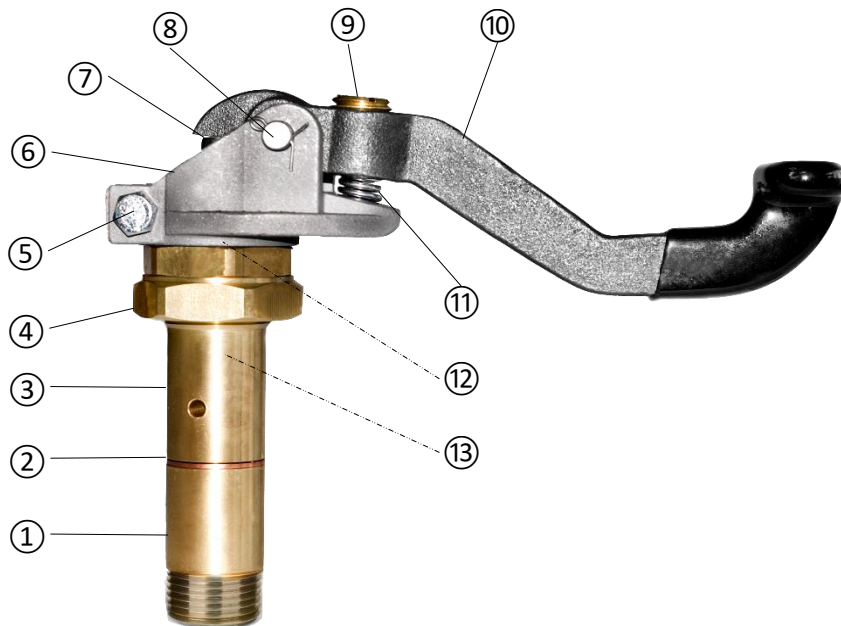

Copyright©2021 Höt-Steam® All rights reserved.

Ver.2305