

2024 **PRODUCT CATALOG**



CONNECT WITH US

4716 New Utrecht Ave Brooklyn, NY 11219

☎ 844-922-7267 ✉ Info@abramsmfg.com



WWW.ABRAMSMFG.COM



Abrams 2024 **PRODUCT CATALOG**

Abrams®

2024

PRODUCT CATALOG



POLICE



WORK / UTILITY TRUCK



MUNICIPALITIES / PUBLIC WORKS



AMBULANCE / FIRE TRUCK

VEHICLE SAFETY & LIGHTING SOLUTIONS

WWW.ABRAMSMFG.COM



ABRAMS CATALOG INDEX

2024 PRODUCT CATALOG

GRILL LIGHTS:

Flex 3 Series	03
Flex 6 Series	03
Flex 12 Series	04
Ultra 6 Series	04
Ultra 12 Series	05
Ultra 18 Series	05
T3 Series	06
Edge 3 Series	06
L3 Series	07
Bold 12 Series	07
Flex 180 Series	08
Quadra 16 Series	09
Quadra 32 Series	09
Quadra 48 Series	10
Quadra 64 Series	10

HIDEAWAYS:

Impact 6 Series	13
Blaster 6 Series	13
Blaster 120 Series	14
Blaster 360 Series	14

BEACONS:

Stareye 4" Series	17
Stareye 7" Series	17

VISOR AND DASH LIGHTS:

Blitz X Series Visor Lightbar	21
Focus 1X Series	21
Focus 2X Series	22
Quadra 1X-S Series Quad Color Dash Light	23
Quadra 2X-S Series Quad Color Dash Light	23
Quadra 1X-D Series Quad Color Dash Light	24
Quadra 2X-D Series Quad Color Dash Light	24

DECK & LIGHT STICKS:

Unity 2X Series Dual Color LED	27
Unity 4X Series Dual Color LED	27
Unity 6X Series Dual Color LED	28
Unity 8X Series Dual Color LED	28
Focus 200 Series	29
Focus 400 Series	29
Focus 600 Series	30
Focus 800 Series	30

ARROW TRAFFIC ADVISOR:

Focus 1600 Series	33
-------------------	----

RUNNING LIGHTS:

Mustang 1X Series	37
Mustang 2X Series	37
Mustang 3X Series	38
Mustang 4X Series	38
Mustang 5X Series	39
Mustang 6X Series	39

LIGHTBARS:

Unity 24X Series	41
Unity 29X Series	41
Unity 34X Series	42
Unity 40X Series	42
Unity 45X Series	43
Unity 50X Series	43
Unity 55X Series	44
Unity 60X Series	44
Unity 65X Series	45
Rugeye 10X Series	45

OFF ROAD LIGHTBARS:

ORS 20W Lightbar	49
ORS 40W Lightbar	49
ORS 60W Lightbar	50
ORS 80W Lightbar	50
ORS 100W Lightbar	51
ORS 120W Lightbar	51
ORS 180W Lightbar	52
ORS 240W Lightbar	52
ORS 300W Lightbar	53
NBS Curve 120W Lightbar	53
NBS Curve 180W Lightbar	54
NBS Curve 240W Lightbar	54
NBS Curve 288W Lightbar	55
NBS Curve 300W Lightbar	55

WORK LIGHTS:

3" HDS Series 18W Flood/ Spot Light	59
4" HDS Series 27W Flood/ Spot Light	59
5" HDS Series 48W Flood/ Spot Light	60
5" HDS Series 60W Flood/ Spot Light	60
6" HDS Series 100W Flood/ Spot Light	61
6" HDS Series 18W Flood/ Spot Light	61



ABRAMS CATALOG INDEX

2024 PRODUCT CATALOG

SNOW PLOW LIGHTS:

X Series Snow Plow Light	65
Y Series Snow Plow Light	66
T Series Snow Plow Light	67
Series Snow Plow Relay Kit	67

FORK LIFT LIGHTS:

5 in 1 Fork Lift Lights	71
Arrow Shape Fork Lift Lights	71
Line Shape Fork Lift Lights	72
Square Shape Fork Lift Lights	72
Forklift Head Light Kit LED	73

TOUCH LIGHTS:

5.11" Round Interior LED Dome Lights	77
5.3" Rectangular Interior LED Dome Light	77
7.8" Rectangular Interior LED Dome Lights	78
11.8" - 12W Interior LED Dome Lights	78
11.8" - 11.6W Interior LED Dome Lights	79
7.3" Rectangular Interior LED Dome Lights	79
PIR Motion Sensor	80

COBALT LIGHTS:

5" Cobalt XS Side Scene Lights	83
9" Cobalt XS Side Scene Lights	83
13" Cobalt XS Side Scene Lights	84
9" Cobalt XR Side Scene Lights	84
12" Cobalt XR Side Scene Lights	85
15" Cobalt XR Side Scene Lights	85

PEDESTAL LIGHTS:

24 LED Round Parking Lights	89
26 LED Square Parking Lights	90

BUS LIGHTS:

7" - 47 LED Round Bus Tail Lights	93
-----------------------------------	----

TRAILER TAIL LIGHTS:

4" - 10 LED Round Tail Lights	97
4" - 24 LED Round Tail Lights	97
6" - 10 LED Round Tail Lights	98
6" - 24 LED Round Tail Lights	98
5x3" - 10 LED Rectangular Tail Lights	99
5x3" - 24 LED Rectangular Tail Lights	99
6" Oval - 35 LED Sequential Turn Lights	100
6" Oval - 9 LED Round Turn Lights	100

STROBE LIGHTS:

4" Round - 24 LED Trailer Strobe Lights	101
6" Oval - 24 LED Trailer Strobe Lights	102

COMBINATION LIGHTS:

4" Round 12 LED's Fiesta Combo Light	105
6" Round 13 LED's Fiesta Combo Light	106
4" Round All in One Fiesta Combo Strobe Light	107
6" Round All in One Fiesta Combo Strobe Light	108

TRAILER CLEARANCE LIGHTS:

3/4" Bullet Clearance Lights	109
2" Side Marker Clearance Lights	109
2.5" Side Marker Clearance Lights	110
4"x2" Bullseye Clearance Lights	110

ID MARKER LIGHTS:

15" ID Marker Light Bars	113
--------------------------	-----

LICENSE PLATE LIGHTS:

Bracket Mount Series	117
Stud Mount Series	117
Surface Mount Series	118
Universal Mount Tag Light Series	118

REFLECTIVE TAPE:

Solas Reflective Tape 2"	121
DOT C2 2" Reflective Tape	122

SIREN SYSTEM:

Escape 100W Siren System	125
Escape 200W Siren System	125
Expedition 100W Siren System	126
Expedition 200W Siren System	126
Logic 1100 Handheld & Light Controller	127
Logic 2200 Handheld & Light Controller	127
Logic 2200 Console & Light Controller	128
Macro Waterproof Motorcycle Siren System	129

SPEAKERS:

Tornado 3 Low Frequency Siren System	132
ECO 100W Siren Speaker	135
Slim 100W Siren Speaker	135
Ultra 100W Siren Speaker	136
Rogue 100W Siren Speaker	136
Bolt 100W Siren Speaker	137
Supreme 100W Siren Speaker	137
Supreme 200W Siren Speaker	138
Macro Series Motorcycle Siren Speaker	138



ABRAMS CATALOG INDEX

2024 PRODUCT CATALOG



BACKUP ALARM:

102DB Series Backup Alarm	141
112DB Series Backup Alarm	141

SWITCH PANELS:

Taurus Series Switch Panel	145
Astro 400 Series Controller	147
Astro 500 Series Controller with Relay	147
Astro 1100 Series Controller	148

ACCESSORIES:

Edge 3 & T3 Mounting Brackets	151
Impact & Blaster Mounting Brackets	151
Impact & Blaster Grommet	152
Dash Housing/Cover for Ultra Series Light	152
L Shape Bracket Flex Mount Brackets	153
C Shape Bracket Flex Mount Brackets	153
Flex-180 C Bracket	154
Flex-180 L Bracket	154
Ultra L-Shape Bracket	155
Bold 12 L-Shape Bracket	155
4" Trailer Light L Bracket	156
5" Trailer Light L Bracket	156
6" Trailer Light L Bracket	157

QUADRA SERIES STACKED L BRACKET:

Single Light Multi-Option Mounting Kit	157
Double Stacked Light Multi-Option Mounting Kit	157
Triple Stacked Light Multi-Option Mounting Kit	158
Quad Stacked Light Multi-Option Mounting Kit	158
Double Stacked L Bracket	159
Triple Stacked L Bracket	159
Quad Stacked L Bracket	160
Single Side-By-Side L Bracket	160
Double Stacked Side-By-Side L Bracket	161
Triple Side-By-Side L Bracket	161
Quad Side-By-Side L Bracket	162
Visor Headliner Quick Mount Bracket	162

WINDOW SHROUD KIT:

Abrams 1X Single Quadra Series	163
Abrams 1X-D Single Double Quadra & Flex Series	163
Abrams 2X Single Quadra Series	164
Abrams 2X-D Single Double Quadra & Flex Series	164

CONNECTGO SYSTEM SERIES:

Extention Cables	167
Pigtail Connectors	168
Splitter Connectors	169

TRAILER LIGHT GROMMET:

Flex 3 FMG Grommet	171
Flex 6 FMG Grommet	171
Flex 12 FMG Grommet	172
2" Rubber Grommet	172
2.5" Rubber Grommet	173
4" Rubber Grommet	173
5"x3" Rubber Grommet	174
6" Rubber Grommet	174

TRAILER LIGHT CONNECTORS:

CLC-2P-RA	175
CLC-2P-RA	175
CLC-2P-SA	175
CLC-2P-SA	175
TLC-2P-RA	175
TLC-2P-RA	175
TLC-2P-SA	175
TLC-2P-SA	175

GSA & GOVERNMENT PURCHASES

Abrams will gladly accept government purchase orders from various different municipal agencies & departments such as Police, Fire, EMS, Public Safety, DOT, State, Federal, Military, and Volunteer Departments. The P.O. must be issued by a bonafide government agency on agency letterhead or agency forms. You may place your order online and select Purchase Order when checking out. Then you would just need to email or fax a copy of your purchase order authorization for processing.

AGENCIES THAT BENEFIT FROM ABRAMS MFG PRODUCTS





GRILL LIGHTS

USE ALMOST ANYWHERE ON THE VEHICLE

Flex 3 Series



SKU	FLEX 3-X
DIMENSIONS	3.25" x 0.96" x 0.65"
VOLTAGE	10-30 VDC
WATTAGE	9W
AMPS	1A
WEIGHT	2.4 OUNCES
LED COUNT	3 LED
WATERPROOF	IP67 RATED
COLOR TYPE	SINGLE COLOR
LIGHT SPREAD / BEAM TYPE	LINEAR SPREAD
AVAILABLE COLORS	

SPECIFICATIONS:

- SAE Class 1
- 21 Flash Patterns
- 7th Generation LED
- Built in Flasher
- Pattern Memory Recall
- Fit Anywhere
- Heat Sink
- Mounting Flange
- Turn, Brake Tail Light
- Sync. Between Multiple Units
- 5 yr Warranty
- Multiple Mounting Options

Flex 12 Series



SKU	FLEX 12-XX
DIMENSIONS	5" X 0.87" X 0.68"
VOLTAGE	10-30 VDC
WATTAGE	36W
AMPS	2A
WEIGHT	4 OUNCES
LED COUNT	12 LED
WATERPROOF	IP67 RATED
COLOR TYPE	SINGLE/SPLIT/DUAL
LIGHT SPREAD / BEAM TYPE	LINEAR SPREAD
AVAILABLE COLORS	

SPECIFICATIONS:

- SAE Class 1
- 63+ Flash Patterns
- 7th Generation LED
- Built in Flasher
- Pattern Memory Recall
- Fit Anywhere
- Heat Sink
- Mounting Flange
- Turn, Brake Tail Light
- 5 yr Warranty
- Sync. Between Multiple Units
- Independent Color Control
- Multiple Mounting Options

Flex 6 Series



SKU	FLEX 6-XX
DIMENSIONS	3.87" X 0.97" X 0.65"
VOLTAGE	10-30 VDC
WATTAGE	18W
AMPS	1.5A
WEIGHT	3 OUNCES
LED COUNT	6 LED
WATERPROOF	IP67 RATED
COLOR TYPE	SINGLE/SPLIT
LIGHT SPREAD / BEAM TYPE	LINEAR SPREAD
AVAILABLE COLORS	

SPECIFICATIONS:

- SAE Class 1
- 30 Flash Patterns
- 7th Generation LED
- Built in Flasher
- Pattern Memory Recall
- Fit Anywhere
- Heat Sink
- Mounting Flange
- Turn, Brake Tail Light
- Sync. Between Multiple Units
- 5 yr Warranty
- Multiple Mounting Options

Ultra 6 Series



SKU	ULTRA 6-XX
DIMENSIONS	4.74" X 0.56" X 1.26"
VOLTAGE	10-30 VDC
WATTAGE	18W
AMPS	2A
WEIGHT	3.36 OUNCES
LED COUNT	6 LED
WATERPROOF	IP67 RATED
COLOR TYPE	SINGLE/SPLIT
LIGHT SPREAD / BEAM TYPE	LINEAR SPREAD
AVAILABLE COLORS	

SPECIFICATIONS:

- SAE Class 1
- 29 Flash Patterns
- 7th Generation LED
- Built in Flasher
- Pattern Memory Recall
- Fit Anywhere
- Heat Sink
- Mounting Flange
- Turn, Brake Tail Light
- Sync. Between Multiple Units
- 5 yr Warranty
- Multiple Mounting Options

Ultra 12 series



SKU	ULTRA 12-XX
DIMENSIONS	4.74" X 0.56" X 1.26"
VOLTAGE	10-30 VDC
WATTAGE	36W
AMPS	3A
WEIGHT	3.36 OUNCES
LED COUNT	12 LED
WATERPROOF	IP67 RATED
COLOR TYPE	SINGLE/SPLIT/DUAL COLOR
LIGHT SPREAD / BEAM TYPE	LINEAR SPREAD
AVAILABLE COLORS	

SPECIFICATIONS:

- SAE Class 1
- 69 Flash Patterns
- 7th Generation LED
- Built in Flasher
- Pattern Memory Recall
- Fit Anywhere
- Heat Sink
- Mounting Flange
- Turn, Brake Tail Light
- Sync. Between Multiple Units
- 5 yr Warranty
- Independent Color Control

Ultra 18 series



SKU	ULTRA 18-XX
DIMENSIONS	4.74" X 0.56" X 1.26"
VOLTAGE	10-30 VDC
WATTAGE	72W
AMPS	6A
WEIGHT	3.52 OUNCES
LED COUNT	18 LED
WATERPROOF	IP67 RATED
COLOR TYPE	SINGLE/DUAL/TRI COLOR
LIGHT SPREAD / BEAM TYPE	LINEAR SPREAD
AVAILABLE COLORS	

SPECIFICATIONS:

- SAE Class 1
- 24+ Flash Patterns
- 7th Generation LED
- Built in Flasher
- Pattern Memory Recall
- Fit Anywhere
- Heat Sink
- Mounting Flange
- Turn, Brake Tail Light
- Sync. Between Multiple Units
- 5 yr Warranty
- Independent Color Control



T3 Series



SKU	TG-300-X
DIMENSIONS	3.1" X 1" X 1.5"
VOLTAGE	10-30 VDC
WATTAGE	9W
AMPS	1A
WEIGHT	3 OUNCES
LED COUNT	3 LED
WATERPROOF	IP67 RATED
COLOR TYPE	SINGLE COLOR
LIGHT SPREAD / BEAM TYPE	TIR SPREAD
AVAILABLE COLORS	

SPECIFICATIONS:

- SAE Class 1
- 15 Flash Patterns
- 5th Generation LED
- Built in Flasher
- Pattern Memory Recall
- Fit Anywhere
- Heat Sink
- Mounting Flange
- Turn, Brake Tail Light
- Sync. Between Multiple Units
- 5 yr Warranty

Edge 3 Series



SKU	EG-300-X
DIMENSIONS	3.1" X 1" X 1.5"
VOLTAGE	10-30 VDC
WATTAGE	9W
AMPS	1A
WEIGHT	3 OUNCES
LED COUNT	3 LED
WATERPROOF	IP67 RATED
COLOR TYPE	SINGLE COLOR
LIGHT SPREAD / BEAM TYPE	LINEAR SPREAD
AVAILABLE COLORS	

SPECIFICATIONS:

- SAE Class 1
- 15 Flash Patterns
- 5th Generation LED
- Built in Flasher
- Pattern Memory Recall
- Fit Anywhere
- Sync. Between Multiple Units
- Mounting Flange
- Turn, Brake Tail Light
- Sync. Between Multiple Units
- 5 yr Warranty



GRILL LIGHTS

GRILL LIGHTS

L3 Series



SKU	LG-300-X
DIMENSIONS	3.1" X 1" X 1.5"
VOLTAGE	10-30 VDC
WATTAGE	9W
AMPS	1A
WEIGHT	3 OUNCES
LED COUNT	3 LED
WATERPROOF	IP67 RATED
COLOR TYPE	SINGLE COLOR
LIGHT SPREAD / BEAM TYPE	TIR SPREAD
AVAILABLE COLORS	

SPECIFICATIONS:

- SAE Class 1
- 15 Flash Patterns
- 5th Generation LED
- Built in Flasher
- Pattern Memory Recall
- Fit Anywhere
- Heat Sink
- Mounting Flange
- Turn, Brake Tail Light
- Sync. Between Multiple Units
- 5 yr Warranty

Bold 12 Series



SKU	BOLD 12-XX
DIMENSIONS	4.72" X 2.75" X 1"
VOLTAGE	10-30 VDC
WATTAGE	36W
AMPS	1.7A
WEIGHT	7.7 OUNCES
LED COUNT	12 LED
WATERPROOF	IP67 RATED
COLOR TYPE	SINGLE COLOR, SPLIT COLOR
LIGHT SPREAD / BEAM TYPE	LINEAR SPREAD
AVAILABLE COLORS	

SPECIFICATIONS:

- SAE Class 1
- 37+ Flash Patterns
- 7th Generation LED
- Built in Flasher
- Pattern Memory Recall
- Fit Anywhere
- Heat Sink
- Mounting Flange
- Turn, Brake Tail Light
- Sync. Between Multiple Units
- 5 yr Warranty

Flex 180 Series



SKU	FLEX 180-XX
DIMENSIONS	4.88" X 4.52" X 1.87"
VOLTAGE	10-30 VDC
WATTAGE	36W
AMPS	1.5A
WEIGHT	5 OUNCES
LED COUNT	3 LED
WATERPROOF	IP67 RATED
COLOR TYPE	SPLIT/DUAL COLOR
LIGHT SPREAD / BEAM TYPE	180°
AVAILABLE COLORS	

SPECIFICATIONS:

- SAE Class 1
- ECE R65
- 69 Flash Patterns
- Pattern Memory Recall
- Heat Sink
- Turn, Brake Tail Light
- 5 yr Warranty
- Independent Color Control
- Sync. Between Multiple Units
- 7th Generation LED
- Puddle Light
- Takedown Function

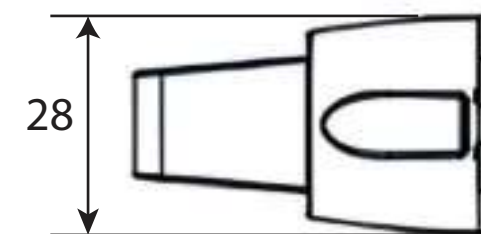
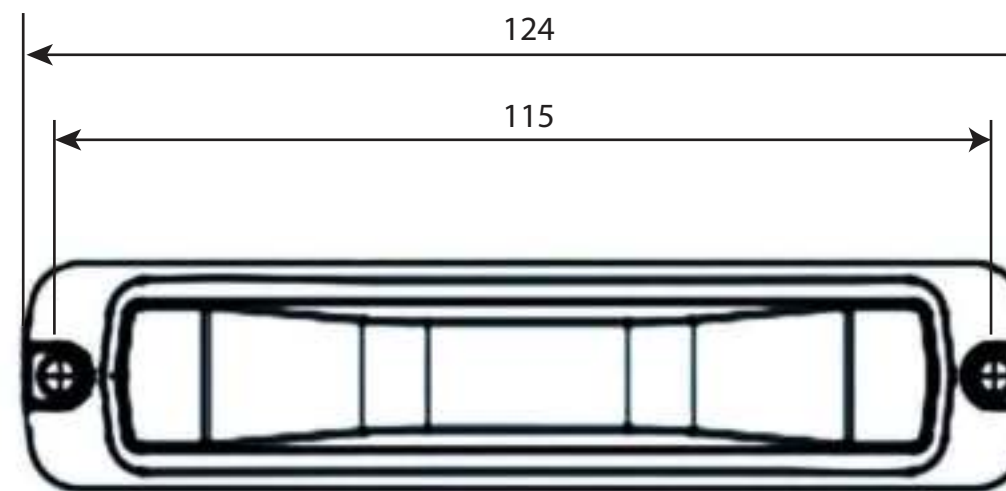

Quadra Series 16 LED Quad Color



SKU	QG-1600-XXXX
DIMENSIONS	5.41" X 0.64" X 0.57"
VOLTAGE	10-30 VDC
WATTAGE	48W
AMPS	0.8A @ 12V / 0.5A @ 24VA
WEIGHT	.30 POUNDS
LED COUNT	16 LED
WATERPROOF	IP67 RATED
COLOR TYPE	SINGLE/DUAL/TRI/QUAD COLOR
LIGHT SPREAD / BEAM TYPE	LINEAR
AVAILABLE COLORS	

SPECIFICATIONS:

SAE Class 1	30+ Flash Patterns	7th Generation LED	Built in Flasher	Pattern Memory Recall
Fit Anywhere	Heat Sink	Mounting Flange	Plug & Play	Quad Colors
5 yr Warranty	7 Modes	Multiple Mounting Options		

Quadra Series 32 LED Quad Color



SKU	QG-3200-XXXX
DIMENSIONS	5.41" X 1.29" X 0.57"
VOLTAGE	10-30 VDC
WATTAGE	96W
AMPS	1.6A @ 12V / 1A @ 24VA
WEIGHT	.75 POUNDS
LED COUNT	32 LED
WATERPROOF	IP67 RATED
COLOR TYPE	SINGLE/DUAL/TRI/QUAD COLOR
LIGHT SPREAD / BEAM TYPE	LINEAR
AVAILABLE COLORS	

SPECIFICATIONS:

SAE Class 1	30+ Flash Patterns	7th Generation LED	Built in Flasher	Pattern Memory Recall
Fit Anywhere	Heat Sink	Mounting Flange	Plug & Play	Quad Colors
5 yr Warranty	7 Modes	Multiple Mounting Options		



Quadra Series 48 LED Quad Color



SKU	QG-4800-XXXX
DIMENSIONS	5.41" X 1.93" X 0.57"
VOLTAGE	10-30 VDC
WATTAGE	144W
AMPS	2.4A @ 12V / 1.5A @ 24V
WEIGHT	1 POUNDS
LED COUNT	48 LED
WATERPROOF	IP67 RATED
COLOR TYPE	SINGLE/DUAL/TRI/QUAD COLOR
LIGHT SPREAD / BEAM TYPE	LINEAR
AVAILABLE COLORS	

SPECIFICATIONS:

SAE Class 1	30+ Flash Patterns	7th Generation LED	Built in Flasher	Pattern Memory Recall
Fit Anywhere	Heat Sink	Mounting Flange	Plug & Play	Quad Colors
5 yr Warranty	7 Modes	Multiple Mounting Options		

Quadra Series 64 LED Quad Color



SKU	QG-6400-XXXX
DIMENSIONS	5.41" X 2.57" X 0.57"
VOLTAGE	10-30 VDC
WATTAGE	192W
AMPS	3.2A @ 12V / 2A @ 24V
WEIGHT	1.25 POUNDS
LED COUNT	64 LED
WATERPROOF	IP67 RATED
COLOR TYPE	SINGLE/DUAL/TRI/QUAD COLOR
LIGHT SPREAD / BEAM TYPE	LINEAR
AVAILABLE COLORS	

SPECIFICATIONS:

SAE Class 1	30+ Flash Patterns	7th Generation LED	Built in Flasher	Pattern Memory Recall
Fit Anywhere	Heat Sink	Mounting Flange	Plug & Play	Quad Colors
5 yr Warranty	7 Modes	Multiple Mounting Options		



GRILL LIGHTS

GRILL LIGHTS



HIDEWAYS

SMALL SIZE - HIGH INTENSITY
PLACE ANYWHERE ON VEHICLE

Impact 6 Series



SKU	IMPACT 6-XX
DIMENSIONS	1.5" X 1" X 1"
VOLTAGE	10-30 VDC
WATTAGE	18W
AMPS	1A
WEIGHT	10 OUNCES
LED COUNT	6 LED
WATERPROOF	IP67 RATED
COLOR TYPE	SINGLE/DUAL COLOR
LIGHT SPREAD / BEAM TYPE	180 DEGREE SPREAD
AVAILABLE COLORS	

SPECIFICATIONS:

- SAE Class 1
- 35 Flash Patterns
- 7th Generation LED
- Built in Flasher
- Pattern Memory Recall
- Fit Anywhere
- Heat Sink
- Mounting Flange
- Turn, Brake Tail Light
- Sync. Between Multiple Units
- 5 yr Warranty
- Independent Color Control

Blaster 120 Series



SKU	BLASTER 120-XX
DIMENSIONS	1.5" X 1" X 1"
VOLTAGE	10-30 VDC
WATTAGE	36W
AMPS	2A
WEIGHT	10 OUNCES
LED COUNT	12 LED
WATERPROOF	IP67 RATED
COLOR TYPE	SINGLE/DUAL COLOR
LIGHT SPREAD / BEAM TYPE	120 DEGREE SPREAD
AVAILABLE COLORS	

SPECIFICATIONS:

- SAE Class 1
- 21 Flash Patterns
- 7th Generation LED
- Built in Flasher
- Pattern Memory Recall
- Fit Anywhere
- Heat Sink
- Mounting Flange
- Turn, Brake Tail Light
- Sync. Between Multiple Units
- 5 yr Warranty
- Independent Color Control

Blaster 6 Series



SKU	BLASTER 6-XX
DIMENSIONS	1.5" X 1" X 1"
VOLTAGE	10-30 VDC
WATTAGE	18W
AMPS	2A
WEIGHT	10 OUNCES
LED COUNT	6 LED
WATERPROOF	IP67 RATED
COLOR TYPE	SINGLE/DUAL COLOR
LIGHT SPREAD / BEAM TYPE	120 DEGREE SPREAD
AVAILABLE COLORS	

SPECIFICATIONS:

- SAE Class 1
- 21 Flash Patterns
- 7th Generation LED
- Built in Flasher
- Pattern Memory Recall
- Fit Anywhere
- Heat Sink
- Mounting Flange
- Turn, Brake Tail Light
- Sync. Between Multiple Units
- 5 yr Warranty
- Independent Color Control

Blaster 360 Series



SKU	BLASTER 360-XX
DIMENSIONS	1.5" X 1" X 1"
VOLTAGE	10-30 VDC
WATTAGE	18W
AMPS	2A
WEIGHT	10 OUNCES
LED COUNT	6 LED
WATERPROOF	IP67 RATED
COLOR TYPE	SINGLE/DUAL COLOR
LIGHT SPREAD / BEAM TYPE	360 DEGREE SPREAD
AVAILABLE COLORS	

SPECIFICATIONS:

- SAE Class 1
- 21 Flash Patterns
- 7th Generation LED
- Built in Flasher
- Pattern Memory Recall
- Fit Anywhere
- Heat Sink
- Mounting Flange
- Turn, Brake Tail Light
- Sync. Between Multiple Units
- 5 yr Warranty
- Independent Color Control



BEACONS

VISIBILITY IN ALL WEATHER CONDITIONS

StarEye 4" Series



SPECIFICATIONS:

SAE Class 1	30 Flash Patterns	7th Generation LED	Pattern Memory Recall	360 Degree Coverage
Built in Flasher	Cigarette Adapter	Mounting Flange	Magnetic Mount	Sync. Between Multiple Units
Turn, Brake Tail Light	5 yr Warranty			

SKU	STAREYE 4-X
DIMENSIONS	4" H X 5 1/8" D
VOLTAGE	10-30 VDC
WATTAGE	36W
AMPS	2A
WEIGHT	1 POUND
LED COUNT	12 LED
WATERPROOF	IP66 RATED
COLOR TYPE	SINGLE COLOR
LIGHT SPREAD / BEAM TYPE	360 DEGREE SPREAD
AVAILABLE COLORS	

StarEye 7" Series



SPECIFICATIONS:

SAE Class 1	30 Flash Patterns	7th Generation LED	Pattern Memory Recall	360 Degree Coverage
Built in Flasher	Cigarette Adapter	Mounting Flange	Magnetic Mount	Sync. Between Multiple Units
Turn, Brake Tail Light	5 yr Warranty			

SKU	STAREYE 7-X
DIMENSIONS	7" H X 6.5" D
VOLTAGE	10-30 VDC
WATTAGE	36W
AMPS	2A
WEIGHT	1.5 POUNDS
LED COUNT	12 LED
WATERPROOF	IP66 RATED
COLOR TYPE	SINGLE COLOR
LIGHT SPREAD / BEAM TYPE	360 DEGREE SPREAD
AVAILABLE COLORS	

StarEye 4"

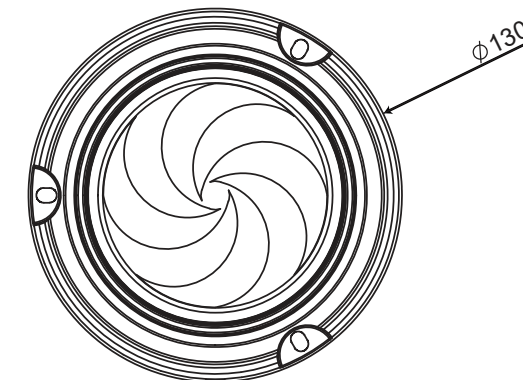
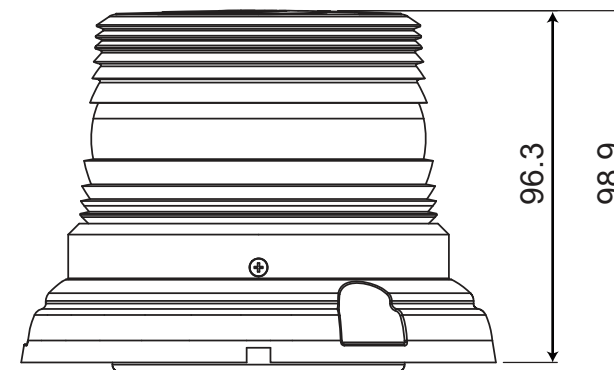

StarEye 7"

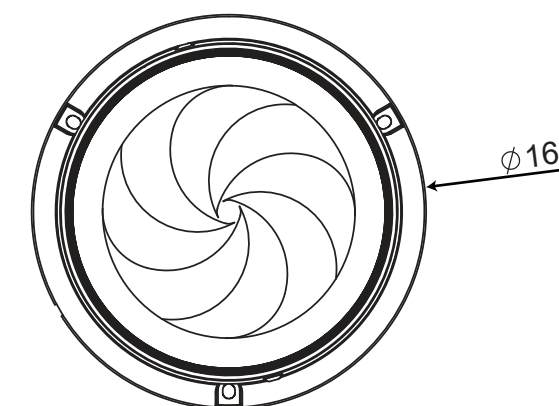
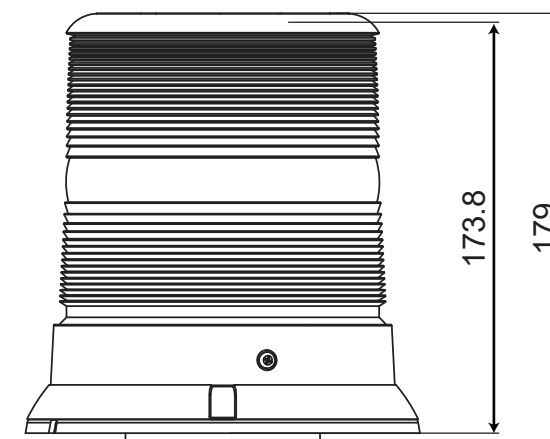



VISION & DASH LIGHTS

PERFECT FOR UNDERCOVER AND UNMARKED CARS

Blitz X Visor Lightbar Series



SKU	BLITZ X-XXX
DIMENSIONS	13.8"L X 0.76"H X 4.72"/3.31"D
VOLTAGE	10-30 VDC
WATTAGE	216W
AMPS	8A
WEIGHT	2 POUNDS
LED COUNT	72 LED
COLOR TYPE	SPLIT/DUAL OR TRI
LIGHT SPREAD / BEAM TYPE	LINEAR SPREAD
AVAILABLE COLORS	

SPECIFICATIONS:

- SAE Class 1
- 210+ Flash Patterns
- 7th Generation LED
- Built in Flasher
- Pattern Memory Recall
- Heat Sink
- Mounting Hardware
- Dim Mode
- Cruise Mode
- Take Down
- Independent Color Control
- Super Slim
- 5 yr Warranty
- 8 Traffic Adviser Patterns

Focus 1X Series



SKU	FOCUS 1X-XX
DIMENSIONS	4.5" X 1.75" X 1.875"
VOLTAGE	10-30 VDC
WATTAGE	18W
AMPS	1A
WEIGHT	1.28 POUNDS
LED COUNT	6 LED
WATERPROOF	IP67 RATED
COLOR TYPE	SINGLE COLOR
LIGHT SPREAD / BEAM TYPE	LINEAR SPREAD
AVAILABLE COLORS	

SPECIFICATIONS:

- SAE Class 1
- 52 Flash Patterns
- 7th Generation LED
- Built in Flasher
- Pattern Memory Recall
- Cigarette Adapter
- Heat Sink
- Mounting Flange
- Turn, Brake Tail Light
- Sync. Between Multiple Units
- 5 yr Warranty

Focus 2X Series



SKU	FOCUS 2X-XX
DIMENSIONS	8.5" X 1.75" X 1.875"
VOLTAGE	10-30 VDC
WATTAGE	36W
AMPS	2A
WEIGHT	1.75 POUNDS
LED COUNT	12 LED
WATERPROOF	IP67 RATED
COLOR TYPE	SINGLE/SPLIT COLOR
LIGHT SPREAD / BEAM TYPE	LINEAR SPREAD
AVAILABLE COLORS	

SPECIFICATIONS:

- SAE Class 1
- 52 Flash Patterns
- 7th Generation LED
- Built in Flasher
- Pattern Memory Recall
- Fit Anywhere
- Heat Sink
- Mounting Flange
- Turn, Brake Tail Light
- Sync. Between Multiple Units
- 5 yr Warranty

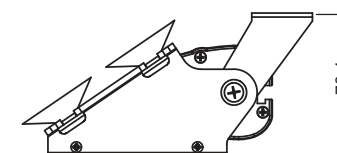
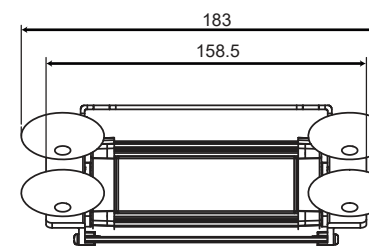
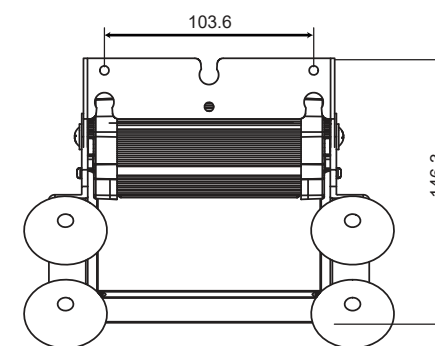

Focus 1X

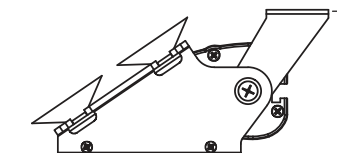
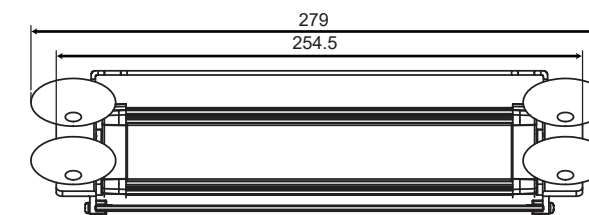
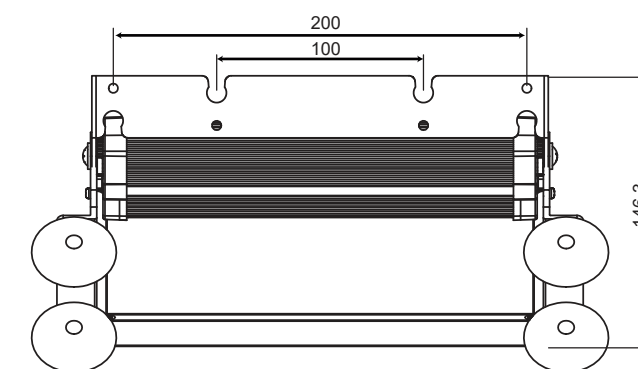

Focus 2X

Quadra Series 1X-S Quad Color LED Dash & Deck Light



SKU	QD-1X-S-Q
DIMENSIONS	7.43" X 3.17" X 1.00"
VOLTAGE	10-30 VDC
WATTAGE	48W
AMPS	0.8A @ 12V / 0.5A @ 24V
WEIGHT	1 POUNDS
LED COUNT	16 LED
WATERPROOF	IP67 RATED
COLOR TYPE	SINGLE/DUAL/TRI/QUAD COLOR
LIGHT SPREAD / BEAM TYPE	LINEAR
AVAILABLE COLORS	

SPECIFICATIONS:

- SAE Class 1
- 30+ Flash Patterns
- 7th Generation LED
- Built in Flasher
- Pattern Memory Recall
- Fit Anywhere
- Heat Sink
- Mounting Flange
- Plug & Play
- Quad Colors
- 5 yr Warranty
- 7 Modes
- Multiple Mounting Options

DASH & DECK LIGHT

Quadra Series 1X-D Quad Color LED Dash & Deck Light



SKU	QD-1X-D-Q
DIMENSIONS	7.80" X 4.17" X 1.39"
VOLTAGE	10-30 VDC
WATTAGE	96W
AMPS	1.6A @ 12V / 1A @ 24V
WEIGHT	1.5 POUNDS
LED COUNT	32 LED
WATERPROOF	IP67 RATED
COLOR TYPE	SINGLE/DUAL/TRI/QUAD COLOR
LIGHT SPREAD / BEAM TYPE	LINEAR
AVAILABLE COLORS	

SPECIFICATIONS:

- SAE Class 1
- 30+ Flash Patterns
- 7th Generation LED
- Built in Flasher
- Pattern Memory Recall
- Fit Anywhere
- Heat Sink
- Mounting Flange
- Plug & Play
- Quad Colors
- 5 yr Warranty
- 7 Modes
- Multiple Mounting Options

DASH & DECK LIGHT

Quadra Series 2X-S Quad Color LED Dash & Deck Light



SKU	QD-2X-S-Q
DIMENSIONS	12.71" X 3.17" X 1.00"
VOLTAGE	10-30 VDC
WATTAGE	96W
AMPS	1.6A @ 12V / 1A @ 24V
WEIGHT	1.5 POUNDS
LED COUNT	32 LED
WATERPROOF	IP67 RATED
COLOR TYPE	SINGLE/DUAL/TRI/QUAD COLOR
LIGHT SPREAD / BEAM TYPE	LINEAR
AVAILABLE COLORS	

SPECIFICATIONS:

- SAE Class 1
- 30+ Flash Patterns
- 7th Generation LED
- Built in Flasher
- Pattern Memory Recall
- Fit Anywhere
- Heat Sink
- Mounting Flange
- Plug & Play
- Quad Colors
- 5 yr Warranty
- 7 Modes
- Multiple Mounting Options

Quadra Series 2X-D Quad Color LED Dash & Deck Light



SKU	QD-2X-D-Q
DIMENSIONS	13.27" X 4.17" X 1.39"
VOLTAGE	10-30 VDC
WATTAGE	192W
AMPS	3.2A @ 12V / 2A @ 24V
WEIGHT	2 POUNDS
LED COUNT	64 LED
WATERPROOF	IP67 RATED
COLOR TYPE	SINGLE/DUAL/TRI/QUAD COLOR
LIGHT SPREAD / BEAM TYPE	LINEAR
AVAILABLE COLORS	

SPECIFICATIONS:

- SAE Class 1
- 30+ Flash Patterns
- 7th Generation LED
- Built in Flasher
- Pattern Memory Recall
- Fit Anywhere
- Heat Sink
- Mounting Flange
- Plug & Play
- Quad Colors
- 5 yr Warranty
- 7 Modes
- Multiple Mounting Options



DECK & LIGHT STICKS

INCREASED VISIBILITY OF ALL EMERGENCY RESPONSE VEHICLES

Unity Series 2X Dual Color LED Deck Light



SKU	UT-2X
DIMENSIONS	8.26"W X 1.67"H X 1.74"D
VOLTAGE	10-30 VDC
WATTAGE	48W
AMPS	1.6A
WEIGHT	1 POUND
LED COUNT	16 LED
WATERPROOF	IP67 RATED
COLOR TYPE	DUAL COLOR
LIGHT SPREAD / BEAM TYPE	LINEAR
AVAILABLE COLORS	

SPECIFICATIONS:

- SAE Class 1
- ECE R65
- 7th Generation LED
- Built in Flasher
- Pattern Memory Recall
- Fit Anywhere
- Heat Sink
- Mounting Flange
- Turn, Brake Tail Light
- Sync. Between Multiple Units
- 5 yr Warranty
- 40+ Flash Patterns

Unity Series 4X Dual Color LED Deck Light



SKU	UT-4X
DIMENSIONS	16.57"W X 1.67"H X 1.74"D
VOLTAGE	10-30VDC
WATTAGE	96W
AMPS	3.2A
WEIGHT	3.26 POUND
LED COUNT	32 LED
WATERPROOF	IP67 RATED
COLOR TYPE	DUAL COLOR
LIGHT SPREAD / BEAM TYPE	LINEAR
AVAILABLE COLORS	

SPECIFICATIONS:

- SAE Class 1
- ECE R65
- 7th Generation LED
- Built in Flasher
- Pattern Memory Recall
- Fit Anywhere
- Heat Sink
- Mounting Flange
- Turn, Brake Tail Light
- Sync. Between Multiple Units
- 5 yr Warranty
- 8 Traffic Advisor Pattern
- 40+ Flash Patterns



Unity Series 6X Dual Color LED Light Stick



SKU	UT-6X
DIMENSIONS	24.90"W X 1.67"H X 1.74"D
VOLTAGE	10-30VDC
WATTAGE	144W
AMPS	4.8A
WEIGHT	4.2 POUND
LED COUNT	48 LED
WATERPROOF	IP67 RATED
COLOR TYPE	DUAL COLOR
LIGHT SPREAD / BEAM TYPE	LINEAR
AVAILABLE COLORS	

SPECIFICATIONS:

- SAE Class 1
- ECE R65
- 7th Generation LED
- Built in Flasher
- Pattern Memory Recall
- Fit Anywhere
- Heat Sink
- Mounting Flange
- Turn, Brake Tail Light
- Sync. Between Multiple Units
- 5 yr Warranty
- 8 Traffic Advisor Pattern
- 80+ Flash Patterns

Unity Series 8X Dual Color LED Light Stick



SKU	UT-8X
DIMENSIONS	33.23"W X 1.67"H X 1.74"D
VOLTAGE	10-30VDC
WATTAGE	192W
AMPS	6.4A
WEIGHT	5.2 POUND
LED COUNT	64 LED
WATERPROOF	IP67 RATED
COLOR TYPE	DUAL COLOR
LIGHT SPREAD / BEAM TYPE	LINEAR
AVAILABLE COLORS	

SPECIFICATIONS:

- SAE Class 1
- ECE R65
- 7th Generation LED
- Built in Flasher
- Pattern Memory Recall
- Fit Anywhere
- Heat Sink
- Mounting Flange
- Turn, Brake Tail Light
- Sync. Between Multiple Units
- 5 yr Warranty
- 8 Traffic Advisor Pattern
- 80+ Flash Patterns



DASH & DECK LIGHT

DASH & DECK LIGHT

Focus 200 Series



SKU	FOCUS 200-XX
DIMENSIONS	8.7" X 2.71" X 1.64"
VOLTAGE	10-30 VDC
WATTAGE	48W
AMPS	1.6A
WEIGHT	1.67 POUNDS
LED COUNT	16 LED
WATERPROOF	IP66 RATED
COLOR TYPE	SINGLE/SPLIT COLOR
LIGHT SPREAD / BEAM TYPE	LINEAR SPREAD
AVAILABLE COLORS	

SPECIFICATIONS:

SAE Class 1	25 Flash Patterns	7th Generation LED	Built in Flasher	Pattern Memory Recall
Turn, Brake Tail Light	Heat Sink	Mounting Flange	5 yr Warranty	Sync. Between Multiple Units

Focus 400 Series



SKU	FOCUS 400-XX
DIMENSIONS	17.72" X 2.71" X 1.64"
VOLTAGE	10-30 VDC
WATTAGE	96W
AMPS	3.2A
WEIGHT	2.8 POUNDS
LED COUNT	32 LED
WATERPROOF	IP66 RATED
COLOR TYPE	SINGLE/SPLIT COLOR
LIGHT SPREAD / BEAM TYPE	LINEAR SPREAD
AVAILABLE COLORS	

SPECIFICATIONS:

SAE Class 1	31 Flash Patterns	7th Generation LED	Built in Flasher	Pattern Memory Recall
Turn, Brake Tail Light	Heat Sink	Mounting Flange	5 yr Warranty	Sync. Between Multiple Units

Focus 600 Series



SKU	FOCUS 600-XX
DIMENSIONS	26.65" X 2.71" X 1.64"
VOLTAGE	10-30 VDC
WATTAGE	144W
AMPS	4.8 A
WEIGHT	3 POUNDS
LED COUNT	48 LED
WATERPROOF	IP66 RATED
COLOR TYPE	SINGLE/SPLIT COLOR
LIGHT SPREAD / BEAM TYPE	LINEAR SPREAD
AVAILABLE COLORS	

SPECIFICATIONS:

SAE Class 1	31 Flash Patterns	7th Generation LED	Built in Flasher	Pattern Memory Recall
Dim Mode	Heat Sink	Mounting Flange	5 yr Warranty	8 Traffic Adviser Patterns

Focus 800 Series



SKU	FOCUS 800-XX
DIMENSIONS	35.67" X 2.71" X 1.64"
VOLTAGE	10-30 VDC
WATTAGE	192W
AMPS	6.4A
WEIGHT	5 POUNDS
LED COUNT	64 LED
WATERPROOF	IP66 RATED
COLOR TYPE	SINGLE/SPLIT COLOR
LIGHT SPREAD / BEAM TYPE	LINEAR SPREAD
AVAILABLE COLORS	

SPECIFICATIONS:

SAE Class 1	31 Flash Patterns	7th Generation LED	Built in Flasher	Pattern Memory Recall
Dim Mode	Heat Sink	Mounting Flange	5 yr Warranty	8 Traffic Adviser Patterns



ARROW TRAFFIC ADVISORS

GIVE THE FOCUSED DIRECTION

Focus 1600 Series



SKU	FOCUS 1600-XX
DIMENSIONS	24.42" X 20.70" X 3.22" (L-A) 24.42" X 20.70" X 3.22" (R-A)
VOLTAGE	10-30 VDC
WATTAGE	384W
AMPS	8A
WEIGHT	8 POUNDS
LED COUNT	128 LED
WATERPROOF	IP66 RATED
COLOR TYPE	SINGLE/SPLIT COLOR
LIGHT SPREAD / BEAM TYPE	LINEAR SPREAD
AVAILABLE COLORS	

SPECIFICATIONS:

- SAE Class 1
- 25 Flash Patterns
- 7th Generation LED
- Built in Flasher
- Pattern Memory Recall
- Dim Mode
- Heat Sink
- Mounting Flange
- 5 yr Warranty
- 8 Traffic Adviser Patterns

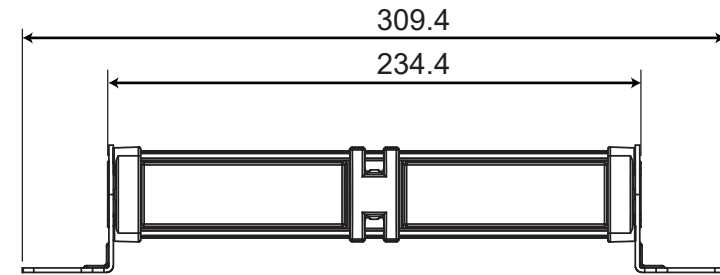

Focus 200

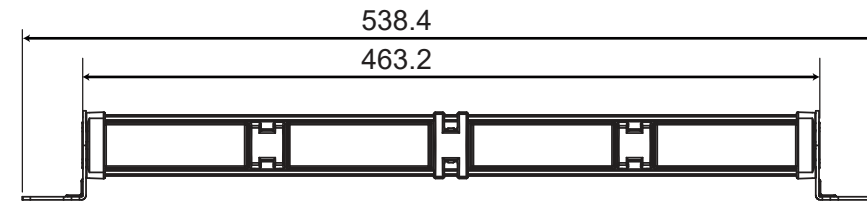
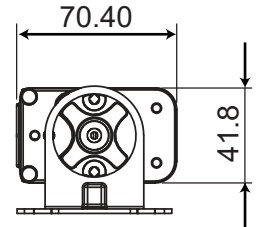

Focus 400

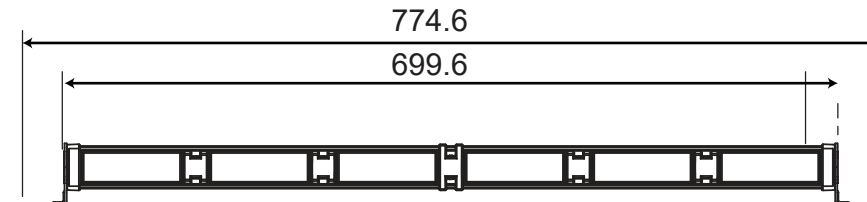
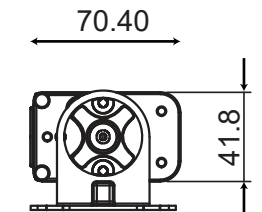

Focus 600

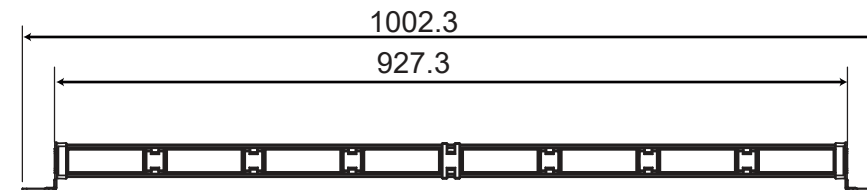
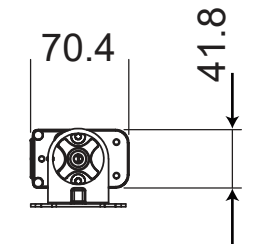

Focus 800

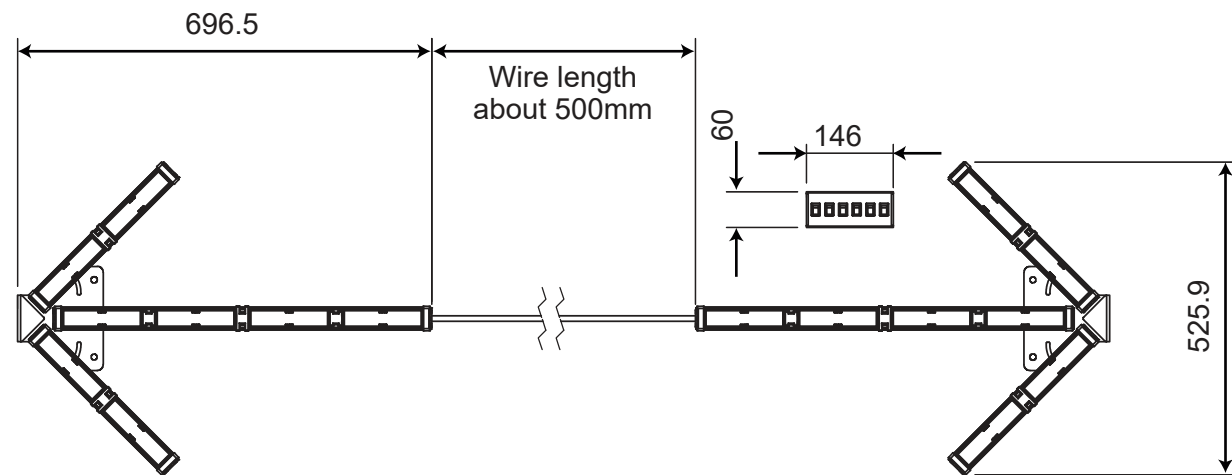
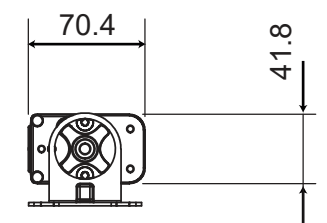



RUNNING LIGHTS

SUPER SLICK, INNOVATIVE
AND MANY OPTIONS TO CHOOSE FROM



Mustang 1X Series



SKU	MUSTANG 1X-XX
DIMENSIONS	15.2" X 0.90" X 0.31"
VOLTAGE	10-30 VDC
WATTAGE	36W
AMPS	0.8A
WEIGHT	0.40 POUNDS
LED COUNT	12 LED
WATERPROOF	IP67 RATED
COLOR TYPE	SINGLE, DUAL, AND TRI COLOR
LIGHT SPREAD / BEAM TYPE	LINEAR SPREAD
AVAILABLE COLORS	

SPECIFICATIONS:

SAE Class 1

60 Flash Patterns

Easy to Install

Built in Flasher

Sync. Between Multiple Units

7th Generation LED

Pattern Memory Recall

Independent Color Control

Heat Sink

Turn, Brake Tail Light

5 yr Warranty

Mustang 2X Series



SKU	MUSTANG 2X-XX
DIMENSIONS	26.6" X 0.90" X 0.31"
VOLTAGE	10-30 VDC
WATTAGE	72W
AMPS	1.6A
WEIGHT	0.80 POUNDS
LED COUNT	24 LED
WATERPROOF	IP67 RATED
COLOR TYPE	SINGLE, DUAL, AND TRI COLOR
LIGHT SPREAD / BEAM TYPE	LINEAR SPREAD
AVAILABLE COLORS	

SPECIFICATIONS:

SAE Class 1

60 Flash Patterns

Easy to Install

Built in Flasher

Sync. Between Multiple Units

7th Generation LED

Pattern Memory Recall

Independent Color Control

Heat Sink

Turn, Brake Tail Light

5 yr Warranty



Mustang 3X Series



SKU	MUSTANG 3X-XX
DIMENSIONS	38" X 0.90" X 0.31"
VOLTAGE	10-30 VDC
WATTAGE	108W
AMPS	2.4A
WEIGHT	1.2 POUNDS
LED COUNT	36 LED
WATERPROOF	IP67 RATED
COLOR TYPE	SINGLE, DUAL, AND TRI COLOR
LIGHT SPREAD / BEAM TYPE	LINEAR SPREAD
AVAILABLE COLORS	

SPECIFICATIONS:

SAE Class 1

60 Flash Patterns

Easy to Install

Built in Flasher

Sync. Between Multiple Units

7th Generation LED

Pattern Memory Recall

Independent Color Control

Heat Sink

Turn, Brake Tail Light

5 yr Warranty

Mustang 4X Series



SKU	MUSTANG 4X-XX
DIMENSIONS	49" X 0.90" X 0.31"
VOLTAGE	10-30 VDC
WATTAGE	144W
AMPS	3.2A
WEIGHT	1.8 POUNDS
LED COUNT	48 LED
WATERPROOF	IP67 RATED
COLOR TYPE	SINGLE, DUAL, AND TRI COLOR
LIGHT SPREAD / BEAM TYPE	LINEAR SPREAD
AVAILABLE COLORS	

SPECIFICATIONS:

SAE Class 1

60 Flash Patterns

Easy to Install

Built in Flasher

Sync. Between Multiple Units

7th Generation LED

Pattern Memory Recall

Independent Color Control

Heat Sink

Turn, Brake Tail Light

5 yr Warranty



Mustang 5X Series



SKU	MUSTANG 5X-XX
DIMENSIONS	60" X 0.90" X 0.31"
VOLTAGE	10-30 VDC
WATTAGE	180W
AMPS	4A
WEIGHT	2.5 POUNDS
LED COUNT	60 LED
WATERPROOF	IP67 RATED
COLOR TYPE	SINGLE, DUAL, AND TRI COLOR
LIGHT SPREAD / BEAM TYPE	LINEAR SPREAD
AVAILABLE COLORS	

SPECIFICATIONS:

- SAE Class 1
- 60 Flash Patterns
- Easy to Install
- Built in Flasher
- Sync. Between Multiple Units
- 7th Generation LED
- Pattern Memory Recall
- Independent Color Control
- Heat Sink
- Turn, Brake Tail Light
- 5 yr Warranty

Mustang 6X Series



SKU	MUSTANG 6X-XX
DIMENSIONS	72" X 0.90" X 0.31"
VOLTAGE	10-30 VDC
WATTAGE	216W
AMPS	4.8A
WEIGHT	3.4 POUNDS
LED COUNT	72 LED
WATERPROOF	IP67 RATED
COLOR TYPE	SINGLE, DUAL, AND TRI COLOR
LIGHT SPREAD / BEAM TYPE	LINEAR SPREAD
AVAILABLE COLORS	

SPECIFICATIONS:

- SAE Class 1
- 60 Flash Patterns
- Easy to Install
- Built in Flasher
- Sync. Between Multiple Units
- 7th Generation LED
- Pattern Memory Recall
- Independent Color Control
- Heat Sink
- Turn, Brake Tail Light
- 5 yr Warranty

Mustang 6X



Mustang 5X

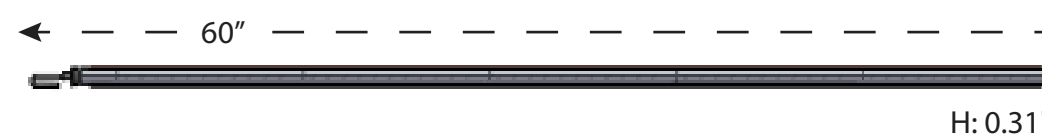

Mustang 4X

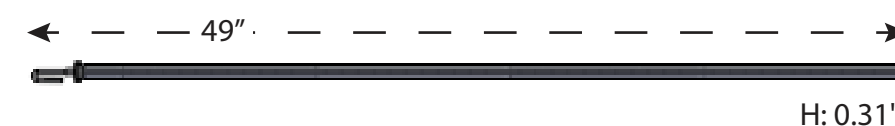

Mustang 3X



Mustang 2X

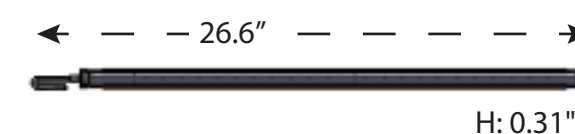

Mustang 1X



Unity 24X Series



SKU	UNITY 24-XX
DIMENSIONS	23.91" X 3.46" X 8.55"
VOLTAGE	10-30 VDC
WATTAGE	99.84W
AMPS	3.9A
PATTERNS	30+
LED COUNT	144 + 48 LED
WATERPROOF	IP67 RATED
COLOR TYPE	SINGLE/SPLIT/DUAL COLOR
LIGHT SPREAD / BEAM TYPE	360 DEGREE LINEAR
AVAILABLE COLORS	

SPECIFICATIONS:

SAE Class 1	360 Degree Coverage	Linear Technology	Modules Rearrangement	Easy to Install
Heat Sink	7th Generation LED	Built in Flasher	Dim Mode	Take Down & Alley Light
8 Traffic Adviser Patterns	Independent Color Control	Pattern Memory Recall	TRUE Dual Color	5 yr Warranty

Unity 29X Series



SKU	UNITY 29-XX
DIMENSIONS	29" X 12" X 8"
VOLTAGE	10-30 VDC
WATTAGE	117.76W
AMPS	4.6A
PATTERNS	30+
LED COUNT	216 + 48 LED
WATERPROOF	IP67 RATED
COLOR TYPE	SINGLE/SPLIT/DUAL COLOR
LIGHT SPREAD / BEAM TYPE	360 DEGREE LINEAR
AVAILABLE COLORS	

SPECIFICATIONS:

SAE Class 1	360 Degree Coverage	Linear Technology	Modules Rearrangement	Easy to Install
Heat Sink	7th Generation LED	Built in Flasher	Dim Mode	Take Down & Alley Light
8 Traffic Adviser Patterns	Independent Color Control	Pattern Memory Recall	TRUE Dual Color	5 yr Warranty



Unity 34X Series



SKU	UNITY 34-XX
DIMENSIONS	34.33" X 3.46" X 7.95"
VOLTAGE	10-30 VDC
WATTAGE	135.68W
AMPS	5.3A
PATTERNS	40+
LED COUNT	216 + 48 LED
WATERPROOF	IP67 RATED
COLOR TYPE	SINGLE/SPLIT/DUAL COLOR
LIGHT SPREAD / BEAM TYPE	360 DEGREE LINEAR
AVAILABLE COLORS	

SPECIFICATIONS:

SAE Class 1	360 Degree Coverage	Linear Technology	Modules Rearrangement	Easy to Install
Heat Sink	7th Generation LED	Built in Flasher	Dim Mode	Take Down & Alley Light
8 Traffic Adviser Patterns	Independent Color Control	Pattern Memory Recall	TRUE Dual Color	5 yr Warranty

Unity 40X Series



SKU	UNITY40-XX
DIMENSIONS	40" X 12" X 8"
VOLTAGE	10-30 VDC
WATTAGE	156.16W
AMPS	6A
PATTERNS	70+
LED COUNT	216 + 48 LED
WATERPROOF	IP67 RATED
COLOR TYPE	SINGLE/SPLIT/DUAL COLOR
LIGHT SPREAD / BEAM TYPE	360 DEGREE LINEAR
AVAILABLE COLORS	

SPECIFICATIONS:

SAE Class 1	360 Degree Coverage	Linear Technology	Modules Rearrangement	Easy to Install
Heat Sink	7th Generation LED	Built in Flasher	Dim Mode	Take Down & Alley Light
8 Traffic Adviser Patterns	Independent Color Control	Pattern Memory Recall	TRUE Dual Color	5 yr Warranty



Unity 45X Series



SKU	UNITY 45-XX
DIMENSIONS	44.74" X 3.46" X 7.95"
VOLTAGE	10-30 VDC
WATTAGE	176.64W
AMPS	6.9A
PATTERNS	70+
LED COUNT	288 + 48 LED
WATERPROOF	IP67 RATED
COLOR TYPE	SINGLE/SPLIT/DUAL COLOR
LIGHT SPREAD / BEAM TYPE	360 DEGREE LINEAR
AVAILABLE COLORS	

SPECIFICATIONS:

SAE Class 1	360 Degree Coverage	Linear Technology	Modules Rearrangement	Easy to Install
Heat Sink	7th Generation LED	Built in Flasher	Dim Mode	Take Down & Alley Light
8 Traffic Adviser Patterns	Independent Color Control	Pattern Memory Recall	TRUE Dual Color	5 yr Warranty

Unity 50X Series



SKU	UNITY50-XX
DIMENSIONS	49.95" X 3.46" X 7.95"
VOLTAGE	10-30 VDC
WATTAGE	189.44W
AMPS	7.4A
PATTERNS	70+
LED COUNT	324 + 48 LED
WATERPROOF	IP67 RATED
COLOR TYPE	SPLIT COLOR
LIGHT SPREAD / BEAM TYPE	LINEAR SPREAD
AVAILABLE COLORS	

SPECIFICATIONS:

SAE Class 1	360 Degree Coverage	Linear Technology	Modules Rearrangement	Easy to Install
Heat Sink	7th Generation LED	Built in Flasher	Dim Mode	Take Down & Alley Light
8 Traffic Adviser Patterns	Independent Color Control	Pattern Memory Recall	TRUE Dual Color	5 yr Warranty

Unity 55X Series



SKU	UNITY 55-XX
DIMENSIONS	55.16" X 3.46" X 7.95"
VOLTAGE	10-30 VDC
WATTAGE	199.68W
AMPS	7.8A
PATTERNS	70+
LED COUNT	360 + 48 LED
WATERPROOF	IP67 RATED
COLOR TYPE	SINGLE/SPLIT/DUAL COLOR
LIGHT SPREAD / BEAM TYPE	360 DEGREE LINEAR
AVAILABLE COLORS	

SPECIFICATIONS:

SAE Class 1	360 Degree Coverage	Linear Technology	Modules Rearrangement	Easy to Install
Heat Sink	7th Generation LED	Built in Flasher	Dim Mode	Take Down & Alley Light
8 Traffic Adviser Patterns	Independent Color Control	Pattern Memory Recall	TRUE Dual Color	5 yr Warranty

Unity 60X Series



SKU	UNITY 60-XX
DIMENSIONS	60.39" X 3.46" X 7.95"
VOLTAGE	10-30 VDC
WATTAGE	225.28W
AMPS	8.8A
PATTERNS	70+
LED COUNT	396 + 48 LED
WATERPROOF	IP67 RATED
COLOR TYPE	SINGLE/SPLIT/DUAL COLOR
LIGHT SPREAD / BEAM TYPE	360 DEGREE LINEAR
AVAILABLE COLORS	

SPECIFICATIONS:

SAE Class 1	360 Degree Coverage	Linear Technology	Modules Rearrangement	Easy to Install
Heat Sink	7th Generation LED	Built in Flasher	Dim Mode	Take Down & Alley Light
8 Traffic Adviser Patterns	Independent Color Control	Pattern Memory Recall	TRUE Dual Color	5 yr Warranty

Unity 65X Series



SKU	UNITY 65-XX
DIMENSIONS	65.59" X 3.46" X 7.95"
VOLTAGE	10-30 VDC
WATTAGE	238.08W
AMPS	9.3A
PATTERNS	70+
LED COUNT	432 + 48 LED
WATERPROOF	IP67 RATED
COLOR TYPE	SINGLE/SPLIT/DUAL COLOR
LIGHT SPREAD / BEAM TYPE	360 DEGREE LINEAR
AVAILABLE COLORS	

SPECIFICATIONS:

SAE Class 1	360 Degree Coverage	Linear Technology	Modules Rearrangement	Easy to Install
Heat Sink	7th Generation LED	Built in Flasher	Dim Mode	Take Down & Alley Light
8 Traffic Adviser Patterns	Independent Color Control	Pattern Memory Recall	TRUE Dual Color	5 yr Warranty

RugEye 10X Series



SKU	RUGEYE 10X-XX
DIMENSIONS	11.40 L" X 7.62 D" X 1.89 H"
VOLTAGE	10-30 VDC
WATTAGE	108W
AMPS	6A
MOUNT	MAGNETIC/PERMANENT
LED COUNT	36 LED
WATERPROOF	IP66 RATED
COLOR TYPE	SINGLE/SPLIT COLOR
LIGHT SPREAD / BEAM TYPE	TIR SPREAD / LINEAR
AVAILABLE COLORS	

SPECIFICATIONS:

SAE Class 1	60 Flash Patterns	360 Degree Coverage	TIR Technology	Replaceable Cover
Easy to Install	Heat Sink	7th Generation LED	Built in Flasher	Pattern Memory Recall
Turn, Brake Tail Light	5 yr Warranty			

Unity 24X



Unity 29X

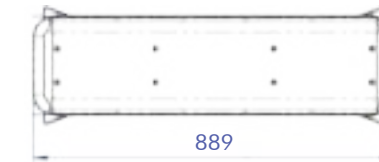

Unity 34X



Unity 40X

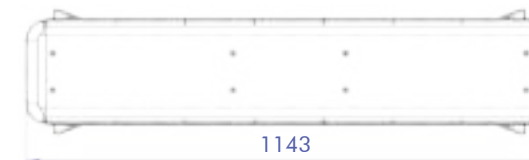

Unity 45X

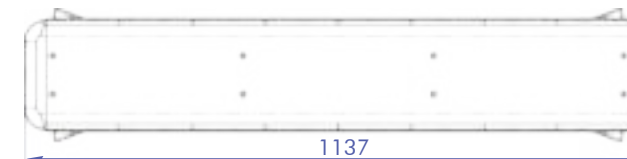

Unity 50X



Unity 55X



Unity 60X



Unity 65X

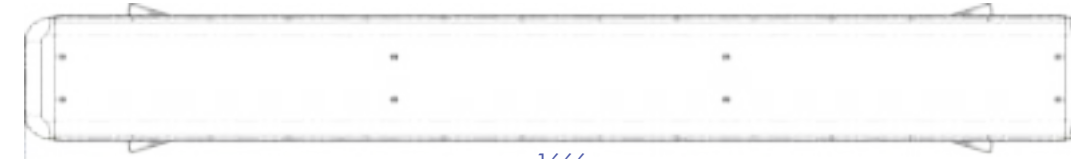



OFF ROAD LIGHTBARS

LIGHT UP YOUR PATH

ORS 20W Lightbar



SKU	ORS-20W
DIMENSIONS	4.72" X 2.36" X 3.54"
VOLTAGE	10-30 VDC
WATTAGE	20W
AMPS	1.6A@13.5V, 0.71A@28V
WEIGHT	2.09 POUNDS
LED COUNT	2 LED
WATERPROOF	IP67 RATED
LUMENS	1,600 LM
LIGHT SPREAD / BEAM TYPE	SPOT SPREAD
SOURCE MATERIAL	6063 ALUMINUM PROFILE

SPECIFICATIONS:

- BRIGHT** Ultra Bright
- EFFICIENT** Energy Efficient
- OUTDOOR** Ideal for Outdoor Use
- EASY** Easy to Mount
- UNIVERSAL** Universal Design
- DT CONNECTOR** DT Connector Included
- RELAY** Relay Kit
- WARRANTY** 5 yr Warranty
- 4D OPTICS** 4D Optics

OFF-ROAD LIGHTBAR

ORS 60W Lightbar



SKU	ORS-60W
DIMENSIONS	11.2" X 2.36" X 3.54"
VOLTAGE	10-30 VDC
WATTAGE	60W
AMPS	4.44A@13.5V, 2.14A@28V
WEIGHT	4.18 POUNDS
LED COUNT	6 LED
WATERPROOF	IP67 RATED
LUMENS	4,800 LM
LIGHT SPREAD / BEAM TYPE	FLOOD/SPOT COMBO
SOURCE MATERIAL	6063 ALUMINUM PROFILE

SPECIFICATIONS:

- BRIGHT** Ultra Bright
- EFFICIENT** Energy Efficient
- OUTDOOR** Ideal for Outdoor Use
- EASY** Easy to Mount
- UNIVERSAL** Universal Design
- DT CONNECTOR** DT Connector Included
- RELAY** Relay Kit
- WARRANTY** 5 yr Warranty
- 4D OPTICS** 4D Optics

OFF-ROAD LIGHTBAR

ORS 40W Lightbar



SKU	ORS-40W
DIMENSIONS	7.87" X 2.36" X 3.54"
VOLTAGE	10-30 VDC
WATTAGE	40W
AMPS	2.96A@13.5V, 1.43A@28V
WEIGHT	3.08 POUNDS
LED COUNT	4 LED
WATERPROOF	IP67 RATED
LUMENS	3,200 LM
LIGHT SPREAD / BEAM TYPE	SPOT SPREAD
SOURCE MATERIAL	6063 ALUMINUM PROFILE

SPECIFICATIONS:

- BRIGHT** Ultra Bright
- EFFICIENT** Energy Efficient
- OUTDOOR** Ideal for Outdoor Use
- EASY** Easy to Mount
- UNIVERSAL** Universal Design
- DT CONNECTOR** DT Connector Included
- RELAY** Relay Kit
- WARRANTY** 5 yr Warranty
- 4D OPTICS** 4D Optics

ORS 80W Lightbar



SKU	ORS-80W
DIMENSIONS	14" X 3.54" X 2.36"
VOLTAGE	10-30 VDC
WATTAGE	80W
AMPS	5.92A@13.5V, 2.86A@28V
WEIGHT	5 POUNDS
LED COUNT	8 LED
WATERPROOF	IP67 RATED
LUMENS	6,400 LM
LIGHT SPREAD / BEAM TYPE	FLOOD/SPOT COMBO
SOURCE MATERIAL	6063 ALUMINUM PROFILE

SPECIFICATIONS:

- BRIGHT** Ultra Bright
- EFFICIENT** Energy Efficient
- OUTDOOR** Ideal for Outdoor Use
- EASY** Easy to Mount
- UNIVERSAL** Universal Design
- DT CONNECTOR** DT Connector Included
- RELAY** Relay Kit
- WARRANTY** 5 yr Warranty
- 4D OPTICS** 4D Optics

ORS 100W Lightbar



SKU	ORS-100W
DIMENSIONS	17" X 3.54" X 2.36"
VOLTAGE	10-30 VDC
WATTAGE	100W
AMPS	7.40A@13.5V, 3.57A@28V
WEIGHT	6 POUNDS
LED COUNT	10 LED
WATERPROOF	IP67 RATED
LUMENS	8,000 LM
LIGHT SPREAD / BEAM TYPE	FLOOD/SPOT COMBO
SOURCE MATERIAL	6063 ALUMINUM PROFILE

SPECIFICATIONS:

Ultra Bright	Energy Efficient	Ideal for Outdoor Use	Easy to Mount	Universal Design
DT Connector Included	Relay Kit	5 yr Warranty	4D Optics	

ORS 120W Lightbar



SKU	ORS-120W
DIMENSIONS	20.27" X 2.36" X 3.54"
VOLTAGE	10-30 VDC
WATTAGE	120W
AMPS	8.89A@13.5V, 4.29A@28V
WEIGHT	7.42 POUNDS
LED COUNT	12 LED
WATERPROOF	IP67 RATED
LUMENS	9,600 LM
LIGHT SPREAD / BEAM TYPE	FLOOD/SPOT COMBO
SOURCE MATERIAL	6063 ALUMINUM PROFILE

SPECIFICATIONS:

Ultra Bright	Energy Efficient	Ideal for Outdoor Use	Easy to Mount	Universal Design
DT Connector Included	Relay Kit	5 yr Warranty	4D Optics	

ORS 180W Lightbar



SKU	ORS-180W
DIMENSIONS	29.92" X 3.54" X 2.36"
VOLTAGE	10-30 VDC
WATTAGE	180W
AMPS	13.33A@13.5V, 6.43A@28V
WEIGHT	9.92 POUNDS
LED COUNT	18 LED
WATERPROOF	IP67 RATED
LUMENS	14,400 LM
LIGHT SPREAD / BEAM TYPE	FLOOD/SPOT COMBO
SOURCE MATERIAL	6063 ALUMINUM PROFILE

SPECIFICATIONS:

Ultra Bright	Energy Efficient	Ideal for Outdoor Use	Easy to Mount	Universal Design
DT Connector Included	Relay Kit	5 yr Warranty	4D Optics	

ORS 240W Lightbar



SKU	ORS-240W
DIMENSIONS	39.17" X 2.36" X 3.54"
VOLTAGE	10-30 VDC
WATTAGE	240W
AMPS	17.78A@ 13.5V, 8.57A@28V
WEIGHT	12.40 POUNDS
LED COUNT	24 LED
WATERPROOF	IP67 RATED
LUMENS	19,200 LM
LIGHT SPREAD / BEAM TYPE	FLOOD/SPOT COMBO
SOURCE MATERIAL	6063 ALUMINUM PROFILE

SPECIFICATIONS:

Ultra Bright	Energy Efficient	Ideal for Outdoor Use	Easy to Mount	Universal Design
DT Connector Included	Relay Kit	5 yr Warranty	4D Optics	

ORS 300W Lightbar



SKU	ORS-300W
DIMENSIONS	50" X 3.54" X 2.36"
VOLTAGE	10-30 VDC
WATTAGE	300W
AMPS	22.22A@ 13.5V, 10.71A@28V
WEIGHT	5.32 POUNDS
LED COUNT	30 LED
WATERPROOF	IP67 RATED
LUMENS	24,000 LM
LIGHT SPREAD / BEAM TYPE	FLOOD/SPOT COMBO
SOURCE MATERIAL	6063 ALUMINUM PROFILE

SPECIFICATIONS:

- Ultra Bright
- Energy Efficient
- Ideal for Outdoor Use
- Easy to Mount
- Universal Design
- DT Connector Included
- Relay Kit
- 5 yr Warranty
- 4D Optics

OFF-ROAD LIGHTBAR

NBS Curve 120W Lightbar



SKU	NBS-120W
DIMENSIONS	22" X 2.5" X 3.5"
VOLTAGE	10-30 VDC
WATTAGE	120W
AMPS	9A@12V, 4.5A@24V
WEIGHT	7 POUNDS
LED COUNT	40 LED
WATERPROOF	IP67 RATED
LUMENS	9,600 LM
LIGHT SPREAD / BEAM TYPE	FLOOD/SPOT COMBO
SOURCE MATERIAL	6063 ALUMINUM PROFILE

SPECIFICATIONS:

- Ultra Bright
- Energy Efficient
- Ideal for Outdoor Use
- Easy to Mount
- Universal Design
- DT Connector Included
- Relay Kit
- 5 yr Warranty
- 5D Optics



NBS Curve 180W Lightbar



SKU	NBS-180W
DIMENSIONS	32" X 2.5" X 3.5"
VOLTAGE	10-30 VDC
WATTAGE	180W
AMPS	11A@12V, 5.5A@24V
WEIGHT	10 POUNDS
LED COUNT	60 LED
WATERPROOF	IP67 RATED
LUMENS	12,800 LM
LIGHT SPREAD / BEAM TYPE	FLOOD/SPOT COMBO
SOURCE MATERIAL	6063 ALUMINUM PROFILE

SPECIFICATIONS:

- Ultra Bright
- Energy Efficient
- Ideal for Outdoor Use
- Easy to Mount
- Universal Design
- DT Connector Included
- Relay Kit
- 5 yr Warranty
- 5D Optics

OFF-ROAD LIGHTBAR

NBS Curve 240W Lightbar



SKU	NBS-240W
DIMENSIONS	42" X 2.5" X 3.5"
VOLTAGE	10-30 VDC
WATTAGE	240W
AMPS	13A@12V, 6.5A@24V
WEIGHT	2.25 POUNDS
LED COUNT	80 X 3W BRIDGELUX LEDS
WATERPROOF	IP67 RATED
LUMENS	19,200 LM
LIGHT SPREAD / BEAM TYPE	FLOOD/SPOT COMBO
SOURCE MATERIAL	6063 ALUMINUM PROFILE

SPECIFICATIONS:

- Ultra Bright
- Energy Efficient
- Ideal for Outdoor Use
- Easy to Mount
- Universal Design
- DT Connector Included
- Relay Kit
- 5 yr Warranty
- 5D Optics



NBS Curve 288W Lightbar



SKU	NBS-288W
DIMENSIONS	50" X 2.5" X 3.5"
VOLTAGE	10-30 VDC
WATTAGE	288W
AMPS	15.6A@12V, 7.8A@24V
WEIGHT	2.53 POUNDS
LED COUNT	96 X 3W BRIDGELUX LEDS
WATERPROOF	IP67 RATED
LUMENS	23,040 LM
LIGHT SPREAD / BEAM TYPE	FLOOD/SPOT COMBO
SOURCE MATERIAL	6063 ALUMINUM PROFILE

SPECIFICATIONS:

- Ultra Bright
- Energy Efficient
- Ideal for Outdoor Use
- Easy to Mount
- Universal Design
- DT Connector Included
- Relay Kit
- 5 yr Warranty
- 4D Optics

NBS Curve 300W Lightbar



SKU	NBS-300W
DIMENSIONS	52" X 2.5" X 3.5"
VOLTAGE	10-30 VDC
WATTAGE	300W
AMPS	17.6A@12V, 8.8A@24V
WEIGHT	16 POUNDS
LED COUNT	100 LED
WATERPROOF	IP67 RATED
LUMENS	24,000 LM
LIGHT SPREAD / BEAM TYPE	FLOOD/SPOT COMBO
SOURCE MATERIAL	6063 ALUMINUM PROFILE

SPECIFICATIONS:

- Ultra Bright
- Energy Efficient
- Ideal for Outdoor Use
- Easy to Mount
- Universal Design
- DT Connector Included
- Relay Kit
- 5 yr Warranty
- 5D Optics

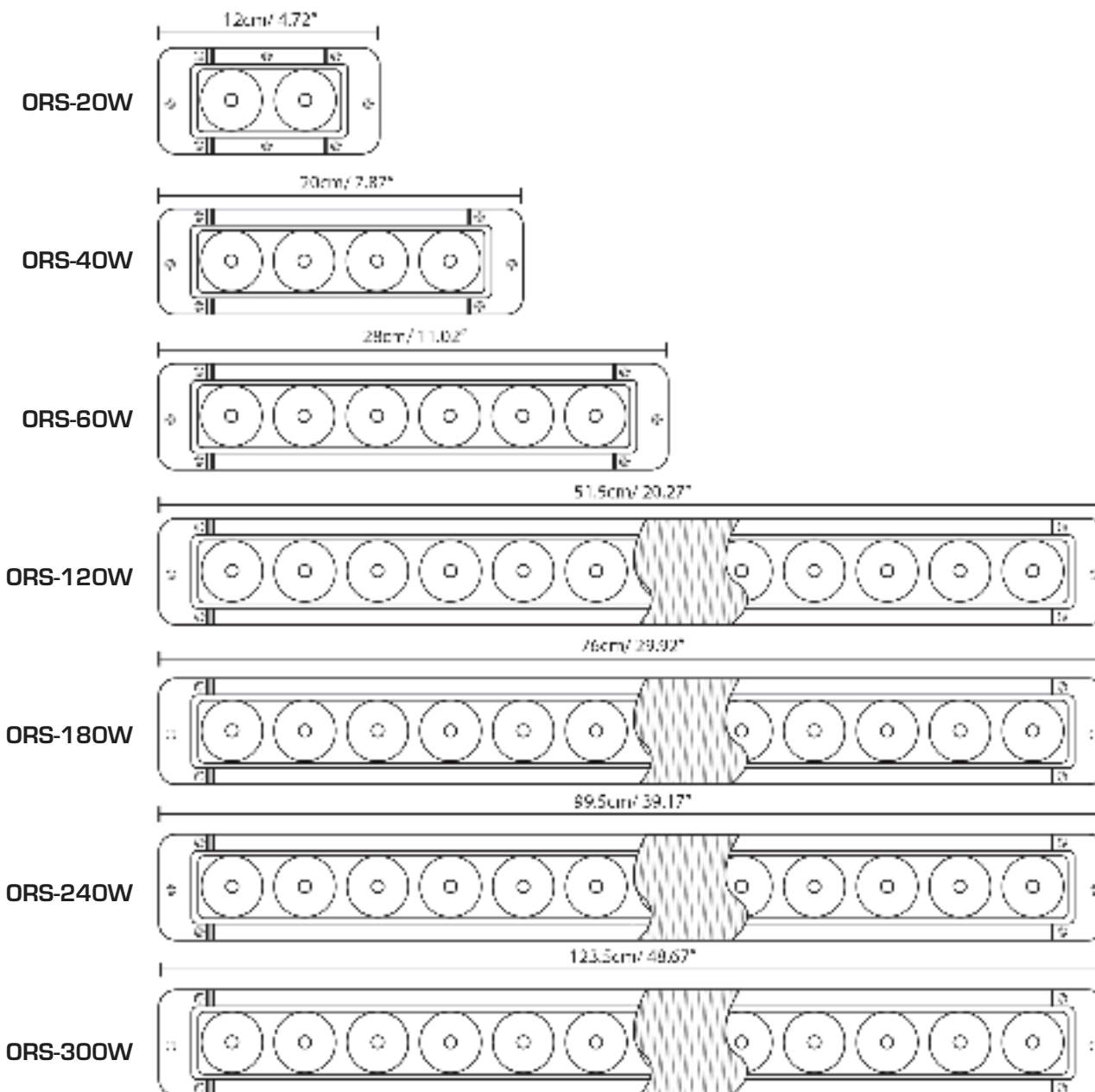
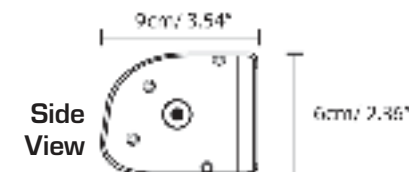



WORK LIGHTS

EXTEND YOUR DAY LIGHT

3" HDS Series 18W Flood/Spot LED



HDS-18F

HDS-18S

SPECIFICATIONS:

- Ultra Bright
- Energy Efficient
- Powered by 12 Volt
- Fog Light
- Ideal for Outdoor Use
- DT Connector Included
- 2 yr Warranty
- Easy to Mount
- Universal Design

SKU	HDS-18F, HDS-18S
DIMENSIONS	3" X 3.54" X 1.65"
VOLTAGE	10-30 VDC
WATTAGE	18 WATTS
AMPS	1.3A@13.5V, 0.64A@28V
WEIGHT	0.65 POUNDS
LED COUNT	6 LED
WATERPROOF	IP68 RATED
LUMENS	1440 LM
LIGHT SPREAD / BEAM TYPE	FLOOD/SPOT
BEAM ANGLE	60 DEGREE, 30 DEGREE

WORK LIGHTS

5" HDS Series 48W Flood/Spot LED



HDS-48F

HDS-48S

SPECIFICATIONS:

- Ultra Bright
- Energy Efficient
- Powered by 12 Volt
- Fog Light
- Ideal for Outdoor Use
- DT Connector Included
- 2 yr Warranty
- Easy to Mount
- Universal Design

SKU	HDS-48F, HDS-48S
DIMENSIONS	4.92" X 4.64" X 4.05"
VOLTAGE	10-30 VDC
WATTAGE	48 WATTS
AMPS	3.56A@13.5V, 1.71A@28V
WEIGHT	3.49 POUNDS
LED COUNT	16 LED
WATERPROOF	IP68 RATED
LUMENS	3840 LM
LIGHT SPREAD / BEAM TYPE	FLOOD/SPOT
BEAM ANGLE	60 DEGREE, 30 DEGREE

WORK LIGHTS

4" HDS Series 27W Flood/Spot LED



HDS-27F

HDS-27S

SPECIFICATIONS:

- Ultra Bright
- Energy Efficient
- Powered by 12 Volt
- Fog Light
- Ideal for Outdoor Use
- DT Connector Included
- 2 yr Warranty
- Easy to Mount
- Universal Design

SKU	HDS-27F, HDS-27S
DIMENSIONS	4.25" X 4.6" X 2.8"
VOLTAGE	10-30 VDC
WATTAGE	27 WATTS
AMPS	2.00A@13.5V, 0.96A@28V
WEIGHT	2.18 POUNDS
LED COUNT	9 LED
WATERPROOF	IP68 RATED
LUMENS	2160 LM
LIGHT SPREAD / BEAM TYPE	FLOOD/SPOT
BEAM ANGLE	60 DEGREE, 30 DEGREE

5" HDS Series 60W Flood/Spot LED



HDS-60F

HDS-60S

SPECIFICATIONS:

- Ultra Bright
- Energy Efficient
- Powered by 12 Volt
- Fog Light
- Ideal for Outdoor Use
- DT Connector Included
- 2 yr Warranty
- Easy to Mount
- Universal Design

SKU	HDS-60F, HDS-60S
DIMENSIONS	4.92" X 4.64" X 4.05"
VOLTAGE	10-30 VDC
WATTAGE	60 WATTS
AMPS	4.44A@13.5V, 2.14A@28V
WEIGHT	3.49 POUNDS
LED COUNT	12 LED
WATERPROOF	IP68 RATED
LUMENS	4800 LM
LIGHT SPREAD / BEAM TYPE	FLOOD/SPOT
BEAM ANGLE	60 DEGREE, 30 DEGREE

6" HDS Series 100W Flood/Spot LED



HDS-100F

HDS-100S

SKU	HDS-100F, HDS-100S
DIMENSIONS	6" X 5.55" X 4.5"
VOLTAGE	10-30 VDC
WATTAGE	100 WATTS
AMPS	7.40A@13.5V, 3.57A@28V
WEIGHT	5.67 POUNDS
LED COUNT	20 LED
WATERPROOF	IP68 RATED
LUMENS	8000 LM
LIGHT SPREAD / BEAM TYPE	FLOOD/SPOT
BEAM ANGLE	60 DEGREE, 30 DEGREE

SPECIFICATIONS:

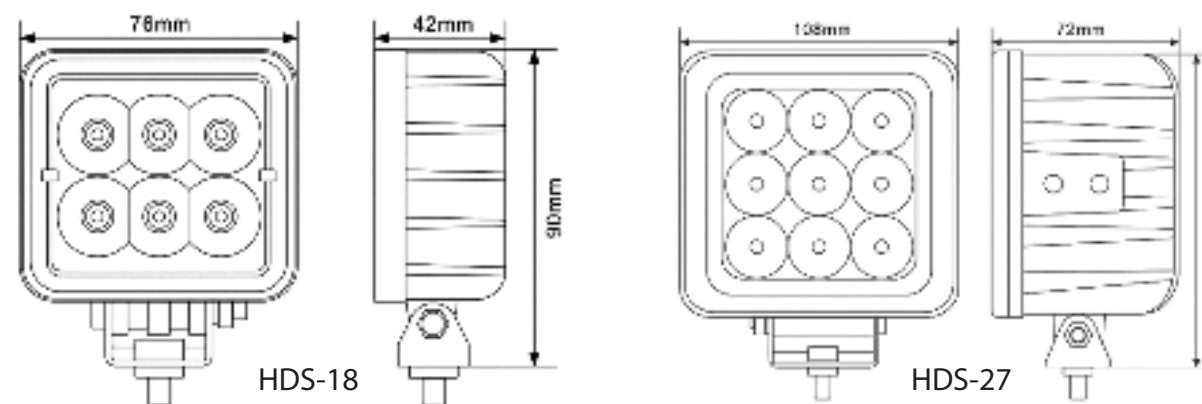
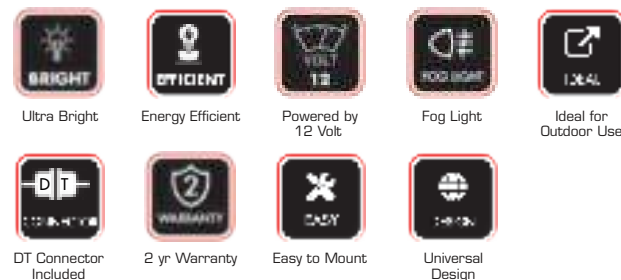

HDS-18

HDS-27

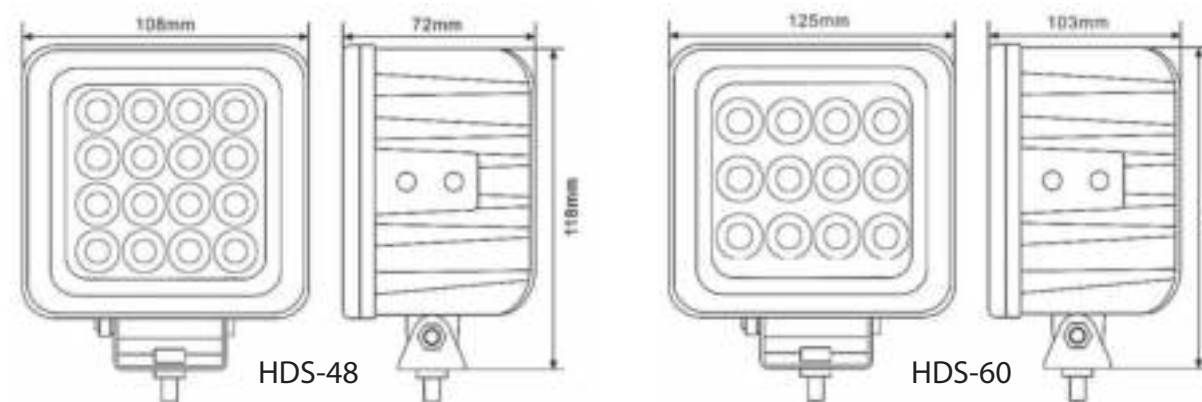

HDS-48

HDS-60

6" HDS Series 18W Flood/Spot LED



HDS-R18S

HDS-R18F

SKU	HDS-R18F, HDS-R18S
DIMENSIONS	5.90" X 2.06" X 2.20"
VOLTAGE	10-30 VDC
WATTAGE	18 WATTS
AMPS	1.3A@13.5V, 0.64A@28V
WEIGHT	1.5 POUNDS
LED COUNT	6 LED
WATERPROOF	IP68 RATED
LUMENS	1440 LM
LIGHT SPREAD / BEAM TYPE	FLOOD/SPOT
BEAM ANGLE	60 DEGREE, , 30 DEGREE

SPECIFICATIONS:

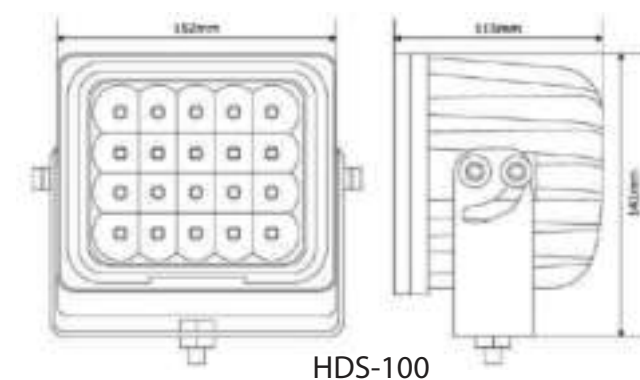
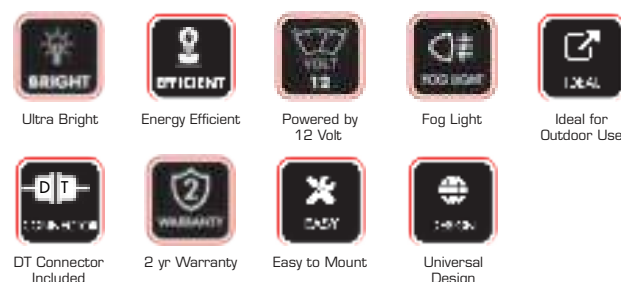

HDS-100

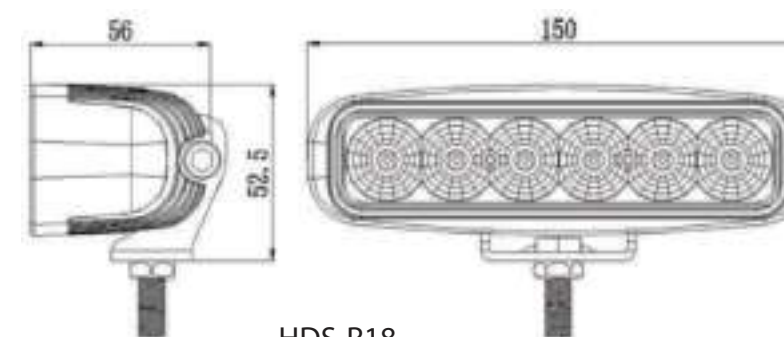

HDS-R18



SNOW PLOW LIGHTS

WORK AS HEADLIGHT REPLACEMENTS



X Series Snow Plow Lights



SKU	SNL-SX-HL
DIMENSIONS	13.3" X 4.2" X 3.3"
VOLTAGE	10-30 VDC
WATTAGE	40 WATT
WEIGHT	10 POUNDS
WATERPROOF	IP68 RATED
LUMENS	4000 LM
LIGHT SPREAD / BEAM TYPE	HIGH & LOW BEAMS
AVAILABLE COLORS	SINGLE COLOR

SPECIFICATIONS:

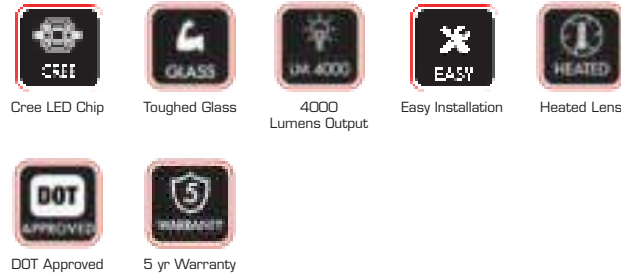

BEAM	AMP DRAW (12V/24V)	LED COUNT
LOW BEAM	1.4A/0.7A	4PCS*5W
HIGH BEAM	3.5/1.7A	4PCS*10W
INDICATOR	1.4A/0.7A	6PCS*5W
PARK LIGHT	0.1A/0.05A	3PCS*3W

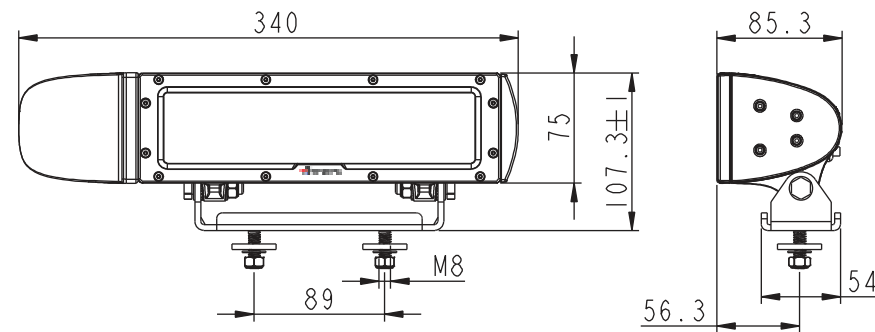

Relay Kit



Y Series Snow Plow Lights



SKU	SNL-SY-HL
DIMENSIONS	8.46" X 5.90" X 3.34"
VOLTAGE	10-30 VDC
WATTAGE	40 WATT
WEIGHT	10 POUNDS
WATERPROOF	IP68 RATED
LUMENS	4000 LM
LIGHT SPREAD / BEAM TYPE	HIGH & LOW BEAMS
AVAILABLE COLORS	SINGLE COLOR

SPECIFICATIONS:

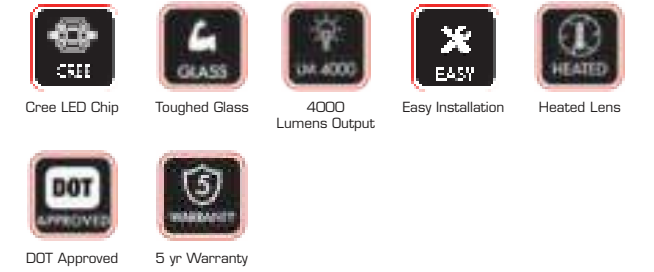

BEAM	AMP DRAW (12V/24V)	LED COUNT
LOW BEAM	1.4A/0.7A	4PCS*5W
HIGH BEAM	3.5/1.7A	4PCS*10W
INDICATOR	1.4A/0.7A	6PCS*5W
POSITION LIGHT	0.1A/0.05A	3PCS*3W

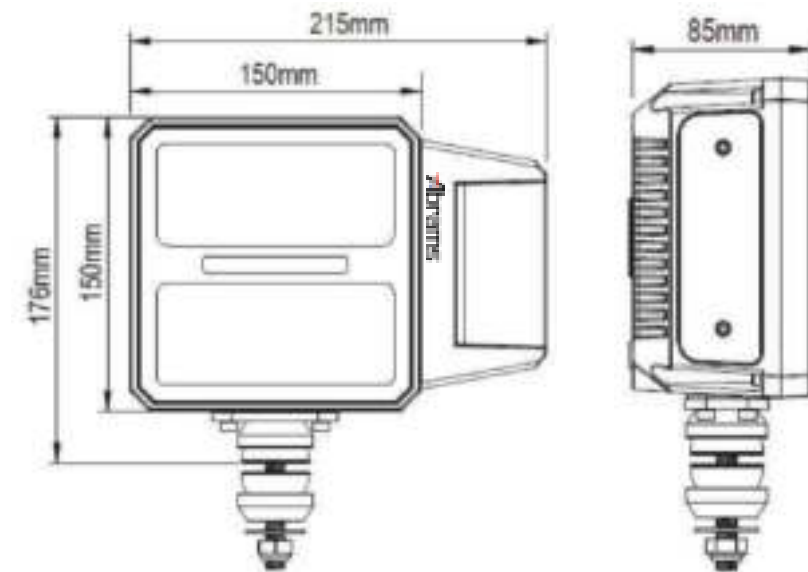

T Series Snow Plow Lights



SKU	SNL-ST-HL
DIMENSIONS	8.46" X 5.90" X 3.34"
VOLTAGE	10-30 VDC
WATTAGE	40 WATT
WEIGHT	10 POUNDS
WATERPROOF	IP68 RATED
LUMENS	4000 LM
LIGHT SPREAD / BEAM TYPE	HIGH & LOW BEAMS
AVAILABLE COLORS	SINGLE COLOR

SPECIFICATIONS:

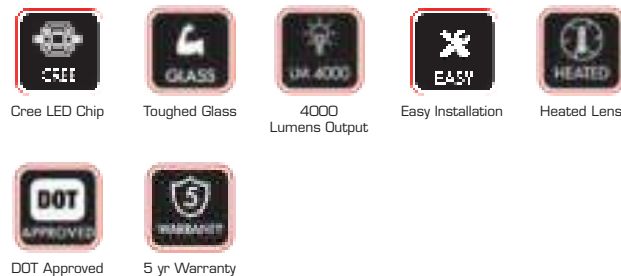

BEAM	AMP DRAW(12V/24V)	LED COUNT
LOW BEAM	6.6A@12V, 3.2A@24V	1x90W
HIGH BEAM	3.2A@12V, 1.6A@24V	1x30W
DRL	1.6A@12V, 0.8A@24V	24x1W
FRONT TURN LIGHT	1.7A@12V, 2.1A@24V	7x1W
REAR TURN LIGHT	1.7A@12V, 2.1A@24V	6x1W

Snow Light Series LED Snow Plow Head Light Relay Module



SKU	SNL-RM
WIRE LENGTH	3 FT/8 FT
RELAYS	5
FUSES	1
CONNECTORS	4

SPECIFICATIONS:

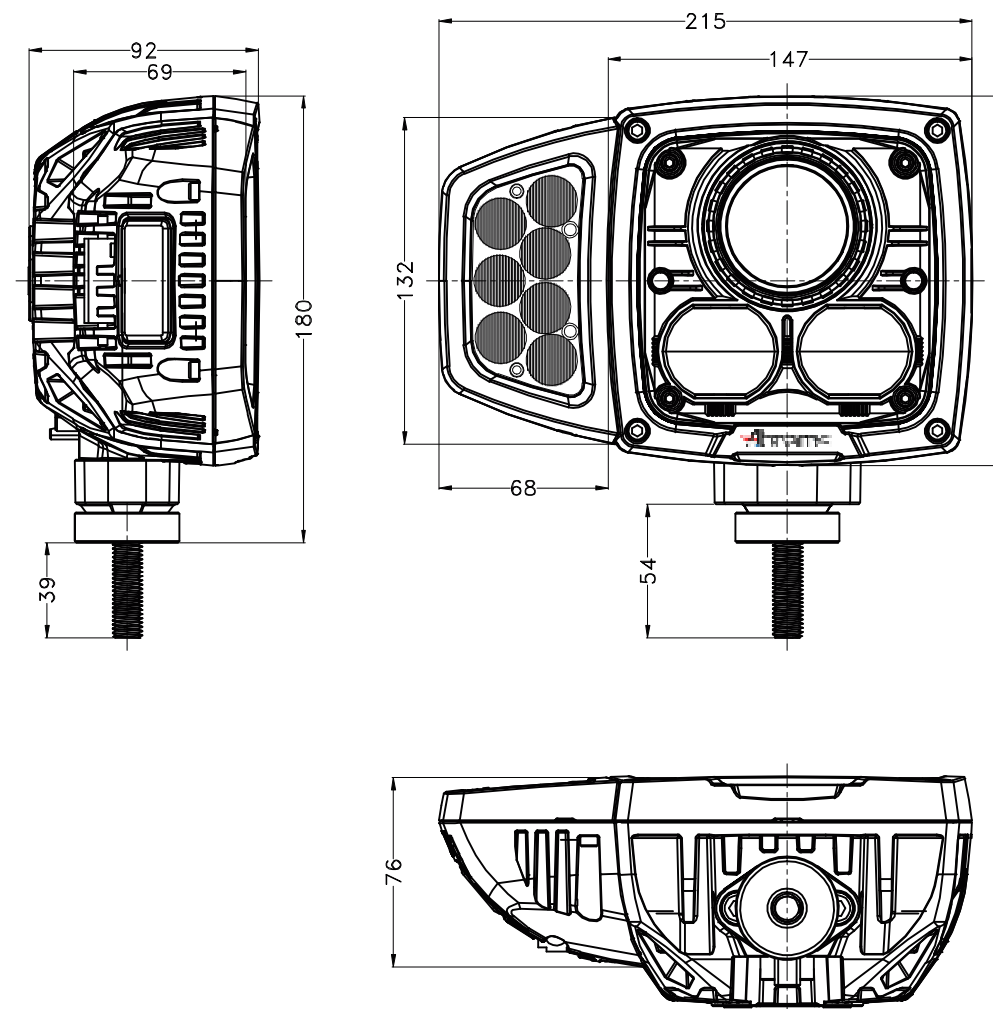

SNOW PLOW RELAY MODULE NOTICE

Vehicles such as Chevrolet, GM, Dodge & Jeep may require a relay kit to avoid flickering after install.

We recommend using the Abrams LED Snow Plow Headlight Plug & Play Anti Flicker Module to fix flickering issues. Please search part number SNL-RM on abramsmfg.com or on Amazon.com or any other marketplace to find & buy this module.

- Stops flickering on snow plow lights installed on many vehicles
- Solves flickering issues for most vehicles including: Chevrolet, GM, Dodge & Jeep.
- Solves turn signal issue on snow plow lights connected to above vehicles,
- Great for low voltage vehicles - Cancels headlight flickering.
- Work with Abrams Snow Plow Lights & may work with other Aftermarket LED Snow Plow Headlights.
- It's Very Easy to Install, No Modification is Needed Volts In: 9 to 36V
- Lifetime Customer Support! No more headlight flickering



FORK LIFT SAFETY LIGHTS

MAKE YOUR BUSY WAREHOUSE SAFER



5 In 1 Fork lift LED



SKU	FLL-ST
DIMENSIONS	7.5" W X 2" H X 0.96" D
VOLTAGE	10-30 VDC
WATTAGE	36 W
AMPS	0.25 A
WEIGHT	1 POUND
LED COUNT	28 LED
WATERPROOF	IP67 RATED
LUMENS	450
PROGRAMMABLE MODE	STOP/TAIL/TURN/REVERSE
AVAILABLE COLORS	■ ■ ■

SPECIFICATIONS:

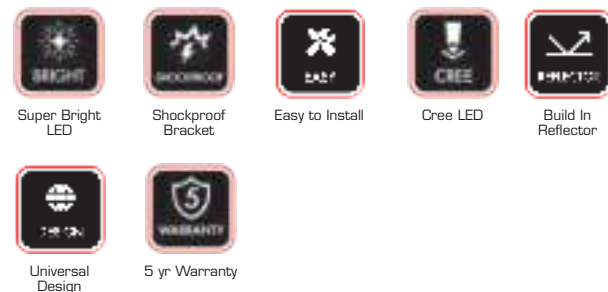

Arrow Shape Forklift Safety Lights



SKU	FSL-BA
DIMENSIONS	4.2" X 3.7" X 3.4"
VOLTAGE	10-94 VDC
WATTAGE	9W
AMPS	0.75 A
WEIGHT	0.90 POUND
LED COUNT	3 LED
WATERPROOF	IP68 RATED
LUMENS	450
BEAM PATTERN	ARROW SHAPED
AVAILABLE COLORS	BLUE, GREEN, RED

SPECIFICATIONS:

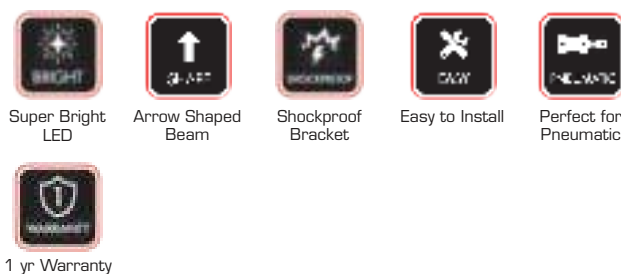

Line Shape Forklift Safety Lights



SKU	FSL-BL
DIMENSIONS	2.98" X 3.22" X 2.88"
VOLTAGE	10-94 VDC
WATTAGE	9W
AMPS	0.75 A
WEIGHT	0.93 POUND
LED COUNT	3 LED
WATERPROOF	IP68 RATED
LUMENS	450
BEAM PATTERN	LINE SHAPED
AVAILABLE COLORS	BLUE, RED

SPECIFICATIONS:

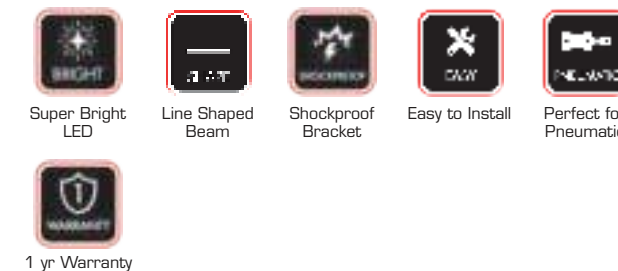

Square Shape Forklift Safety Lights



SKU	FSL-BS
DIMENSIONS	2.99" X 3.85" X 2.90"
VOLTAGE	10-94 VDC
WATTAGE	9W
AMPS	1A
WEIGHT	0.93 POUND
LED COUNT	4 LED
WATERPROOF	IP68 RATED
LUMENS	450
BEAM PATTERN	SQUARE SHAPED
AVAILABLE COLORS	BLUE, RED

SPECIFICATIONS:

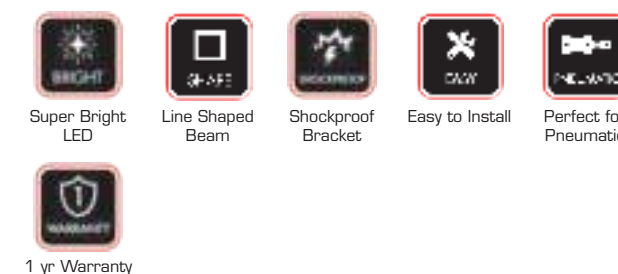

Abrams LED Forklift Head Light Kit

FORK LIFT LIGHTS



SKU	FHL-92-K
DIMENSIONS	4.74" X 0.56" X 1.26"
VOLTAGE	9-80 VDC
WATTAGE	36 W
AMPS	0.25 A
WEIGHT	2 POUND
LED COUNT	28 LED
WATERPROOF	IP67 RATED
LUMENS	6400 LUMENS
PROGRAMMABLE MODE	STOP/TAIL/TURN/REVERSE
AVAILABLE COLORS	■ ■ ■

SPECIFICATIONS:

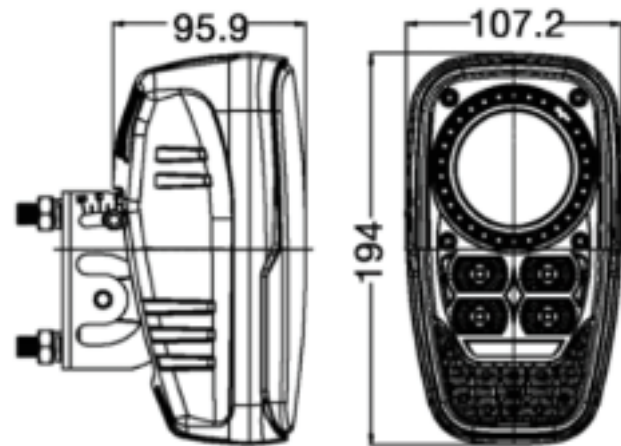
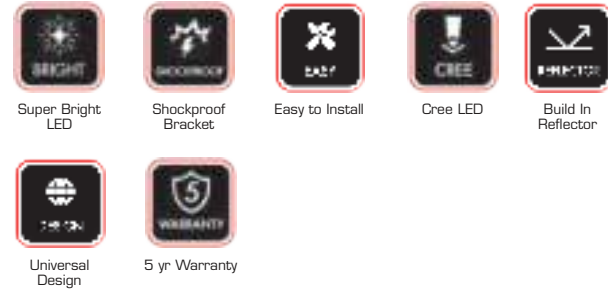

FORK LIFT LIGHTS

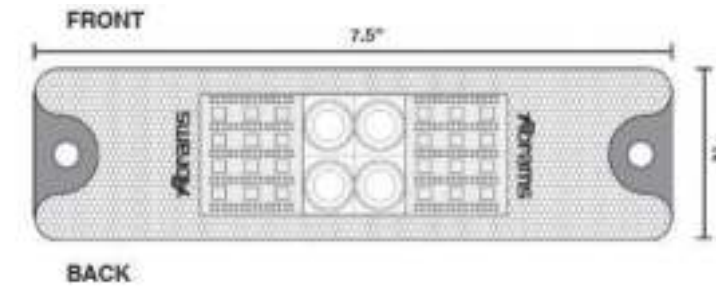

FLL-ST

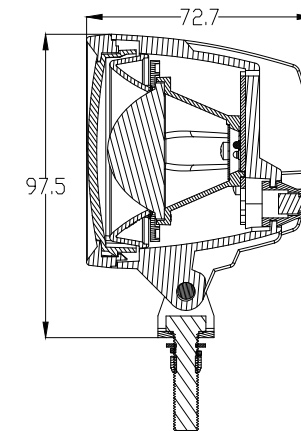
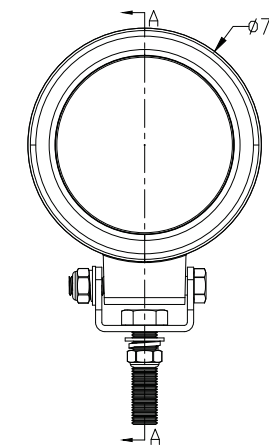

FSL-BA

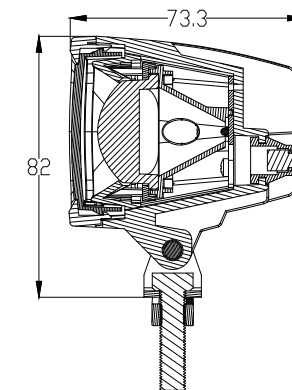
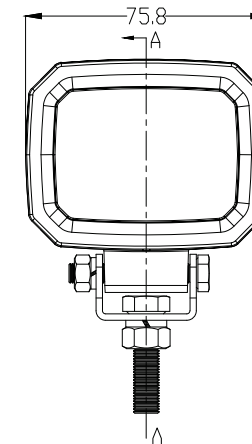

FSL-BL

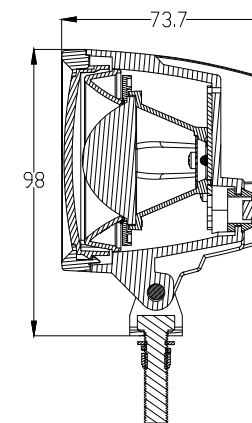
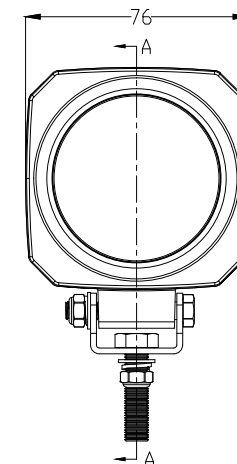

FSL-BS



INTERIOR DOME LIGHTS

COMPLEMENT ANY INDOOR AREA

5.11" Round Interior LED Dome Light Series



SKU	TLC-9300
DIMENSIONS	5.11" X 5.11" X 0.72"
VOLTAGE	10-30 VDC
WATTAGE	25.5W
AMPS	1.89A@13.5V, 0.91A@28V
WEIGHT	0.82 POUND
LED COUNT	51 LED
WATERPROOF	IP67 RATED
LUMENS	1785
AVAILABLE COLORS	SINGLE

SPECIFICATIONS:

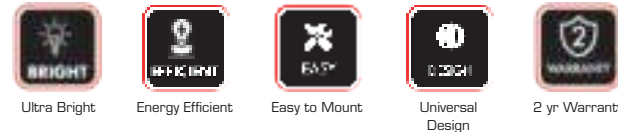

DOME LIGHTS

7.8" Rectangular Interior LED Dome Light Series



SKU	TLA-9600
DIMENSIONS	7.87" X 2.36" X 1.33"
VOLTAGE	10-30 VDC
WATTAGE	12WT
AMPS	0.89A@13.5V, 0.43A@28V
WEIGHT	0.93 POUND
LED COUNT	60 LED
WATERPROOF	IP67 RATED
LUMENS	840
AVAILABLE COLORS	SINGLE

SPECIFICATIONS:

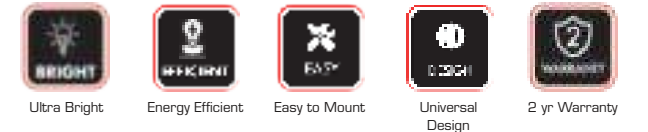

DOME LIGHTS

5.3" Rectangular Interior LED Dome Light Series



SKU	TLR-9400
DIMENSIONS	5.37" X 2.58" X 0.74"
VOLTAGE	10-30 VDC
WATTAGE	13.5WT
AMPS	1.00A@13.5V, 0.84A@28V
WEIGHT	0.54 POUND
LED COUNT	27 LED
WATERPROOF	IP67 RATED
LUMENS	945
AVAILABLE COLORS	SINGLE

SPECIFICATIONS:

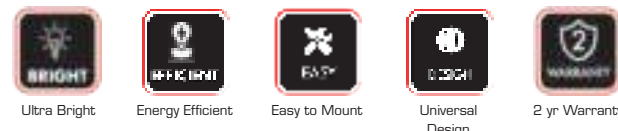

11.8" - 12W Interior LED Dome Light Series



SKU	TLA-9650
DIMENSIONS	11.81" X 2.36" X 1.33"
VOLTAGE	10-30 VDC
WATTAGE	6.4W
AMPS	1.89A@13.5V, 0.43A@28V
WEIGHT	0.53 POUND
LED COUNT	32 LED
WATERPROOF	IP67 RATED
LUMENS	448
AVAILABLE COLORS	SINGLE

SPECIFICATIONS:

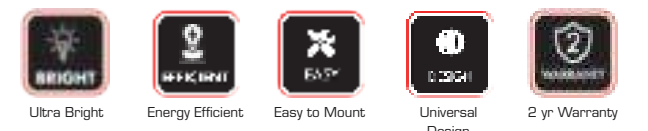

11.8" - 11.6W Interior LED Dome Light Series



SKU	TLB-9700
DIMENSIONS	12.4" X 2.64" X 0.98"
VOLTAGE	10-30 VDC
WATTAGE	11.6W
AMPS	0.86A@13.5V, 0.41A@28V
WEIGHT	0.8 A
LED COUNT	58 LED
WATERPROOF	IP67 RATED
LUMENS	812
AVAILABLE COLORS	SINGLE

SPECIFICATIONS:

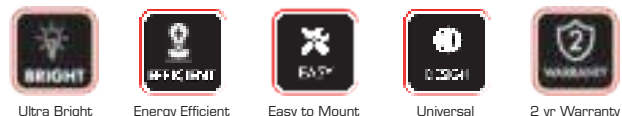

PIR Motion Sensor



SKU	TLS-PIR-5A
DIMENSIONS	3.5" X 1.5" X 1"
VOLTAGE	10-30 VDC
AMPS	1.89A@13.5V, 0.91A@28V
WEIGHT	8 OUNCES
WATERPROOF	IP65 RATED
AVAILABLE COLORS	SINGLE

SPECIFICATIONS:

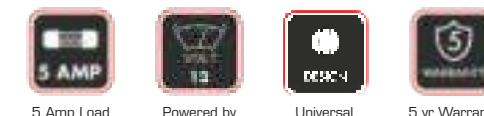

7.3" Rectangular Interior LED Dome Light Series



SKU	TLR-9500
DIMENSIONS	7.33" X 2.58" X 0.74"
VOLTAGE	10-30 VDC
WATTAGE	21W
AMPS	1.56A@13.5V, 0.75A@28V
WEIGHT	0.72 POUND
LED COUNT	42 LED
WATERPROOF	IP67 RATED
LUMENS	1470
AVAILABLE COLORS	SINGLE

SPECIFICATIONS:

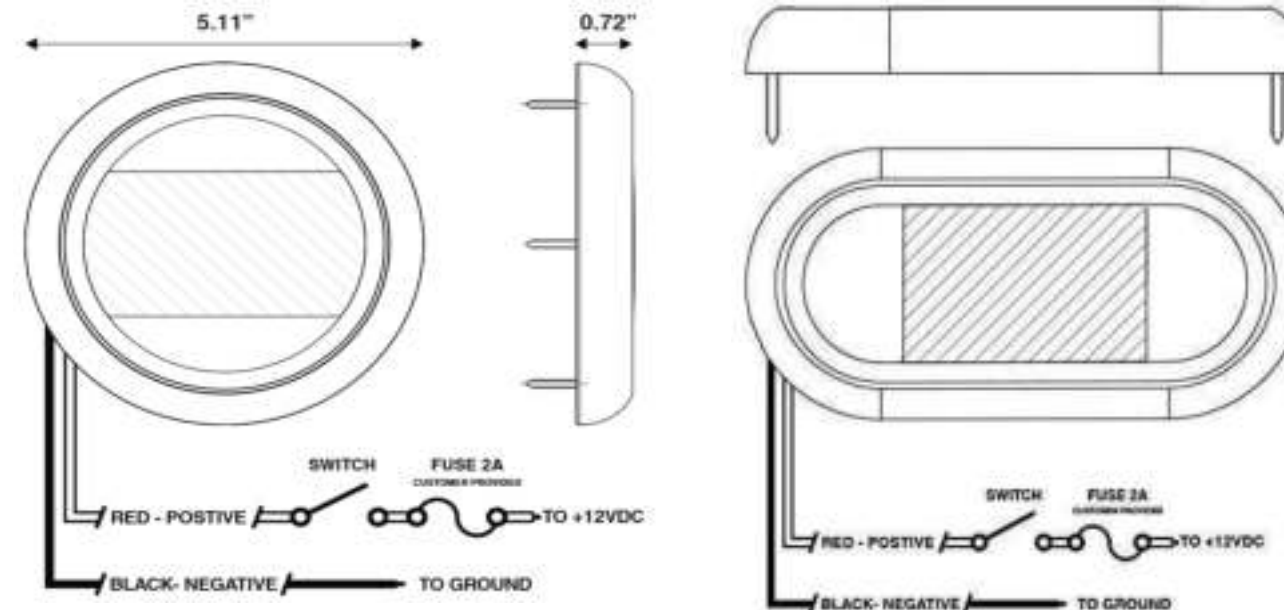
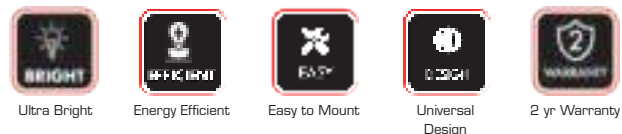



**SIDE
SCENE LIGHT**
NOVEL APPEARANCE DESIGN

5" Cobalt XS Side Scene Light



SKU	CSSL-15-XS
DIMENSIONS	5.07"W X 2.59"H X 2.67"D
VOLTAGE	9-32 VDC
WATTAGE	15W
AMPS	1.03A / 0.52A
WEIGHT	0.66 POUND
LED COUNT	15 X 1W OSRAM LEDES
WATERPROOF	IP68 RATED
LUMENS	1500LM / 1200LM
BEAM PATTERN	FLOOD BEAM
AVAILABLE COLORS	BLACK, WHITE

SPECIFICATIONS:

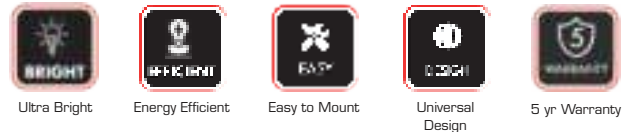

9" Cobalt XS Side Scene Light



SKU	CSSL-36-XS
DIMENSIONS	9.01"W X 2.59"H X 2.67"D
VOLTAGE	9-32 VDC
WATTAGE	36W
AMPS	2.00A / 1.00A
WEIGHT	1.16 POUND
LED COUNT	36 X 1W OSRAM LEDES
WATERPROOF	IP68 RATED
LUMENS	3600LM / 2880LM
BEAM PATTERN	FLOOD BEAM
AVAILABLE COLORS	BLACK, WHITE

SPECIFICATIONS:

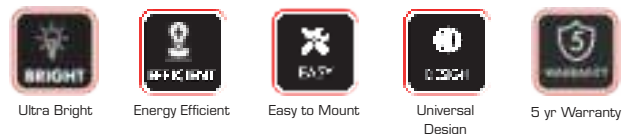

13" Cobalt XS Side Scene Light



SKU	CSSL-60-XS
DIMENSIONS	12.95"W X 2.59"H X 2.67"D
VOLTAGE	9-32 VDC
WATTAGE	60W
AMPS	3A / 1.5A
WEIGHT	1.16 POUND
LED COUNT	60 X 1W OSRAM LEDES
WATERPROOF	IP68 RATED
LUMENS	6000LM / 4800LM
BEAM PATTERN	FLOOD BEAM
AVAILABLE COLORS	BLACK, WHITE

SPECIFICATIONS:

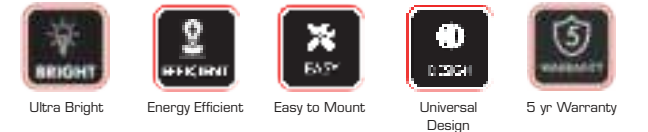

9" Cobalt XR Side Scene Light



SKU	CSSL-20-XR
DIMENSIONS	9.09"W X 1.88"H X 2.16"D
VOLTAGE	9-32 VDC
WATTAGE	20W
AMPS	1.21A / 0.61A
WEIGHT	0.83 POUND
LED COUNT	20 X 1W OSRAM LEDES
WATERPROOF	IP68 RATED
LUMENS	2,000LM / 1,600LM
BEAM PATTERN	FLOOD BEAM
AVAILABLE COLORS	BLACK, WHITE

SPECIFICATIONS:

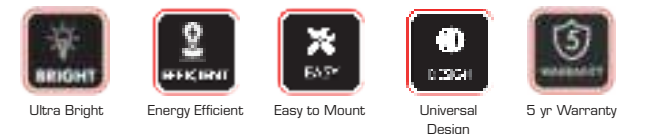

12" Cobalt XR Side Scene Light



SKU	CSSL-32-XR
DIMENSIONS	12.28"W X 1.88"H X 2.16"D
VOLTAGE	9-32 VDC
WATTAGE	32W
AMPS	1.78A / 0.88A
WEIGHT	1.16 POUND
LED COUNT	32 X 1W OSRAM LEDES
WATERPROOF	IP68 RATED
LUMENS	3,200LM / 2,560LM
BEAM PATTERN	FLOOD BEAM
AVAILABLE COLORS	BLACK, WHITE

SPECIFICATIONS:

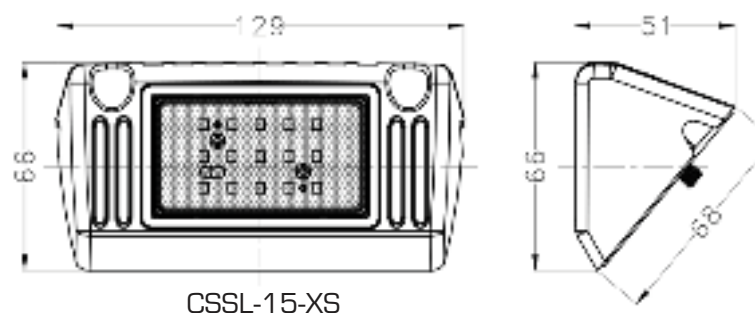
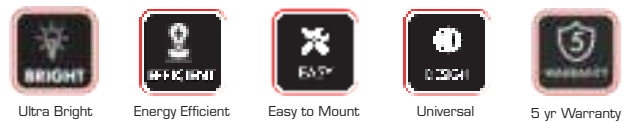

CSSL-15-XS

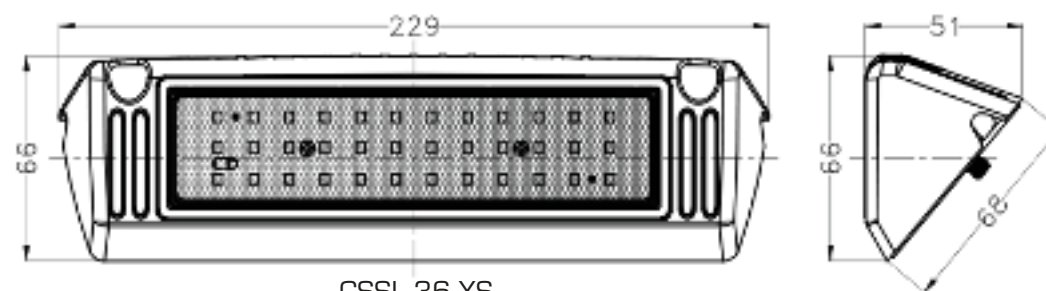

CSSL-36-XS

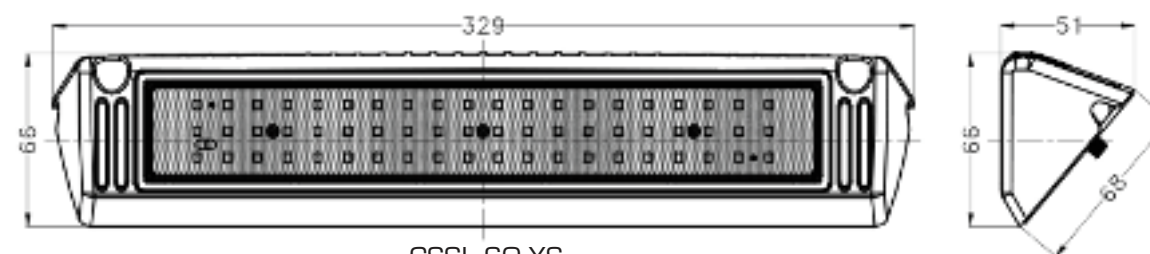

CSSL-60-XS

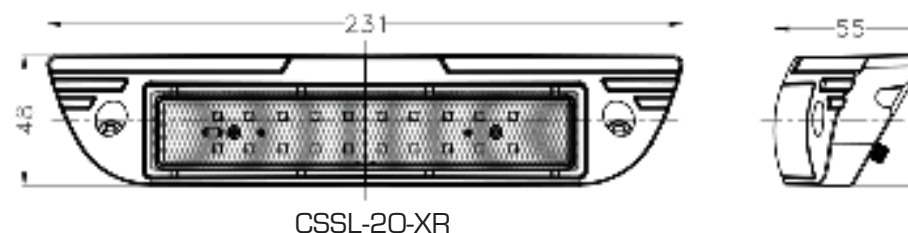

CSSL-20-XR

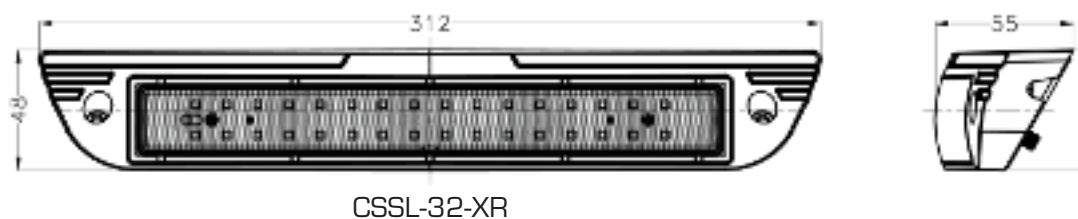

CSSL-32-XR

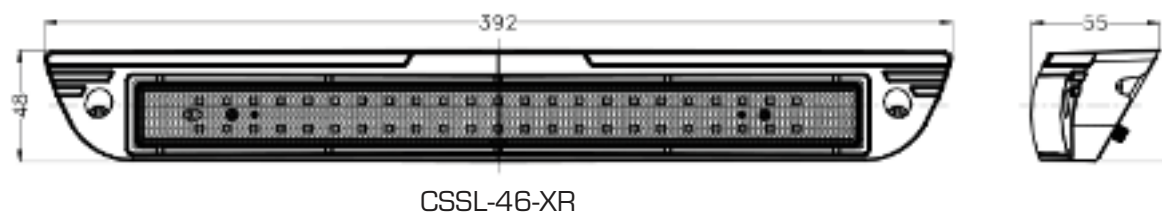

CSSL-46-XR

15" Cobalt XR Side Scene Light



SKU	CSSL-46-XR
DIMENSIONS	15.43"W X 1.88"H X 2.16"D
VOLTAGE	9-32 VDC
WATTAGE	46W
AMPS	2.50A / 1.25A
WEIGHT	1.43 POUND
LED COUNT	46 X 1W OSRAM LEDES
WATERPROOF	IP68 RATED
LUMENS	4,600LM / 3,680LM
BEAM PATTERN	FLOOD BEAM
AVAILABLE COLORS	BLACK, WHITE

SPECIFICATIONS:

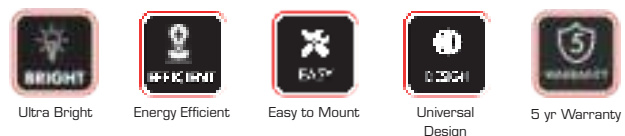



PEDESTAL PARKING LIGHTS

DOUBLE SIDED HEAVY DUTY LED LIGHTS

24 LED - Round Parking Light



SKU	PTPL-RDF-24-RA
DIMENSIONS	4.75" W X 2.37" D
VOLTAGE	8-16 VDC
AMPS	0.65 A
WEIGHT	1 POUND
LED COUNT	24
WATERPROOF	IP68 RATED
COLOR TYPE	DUAL COLOR
AVAILABLE COLORS	■ ■

SPECIFICATIONS:

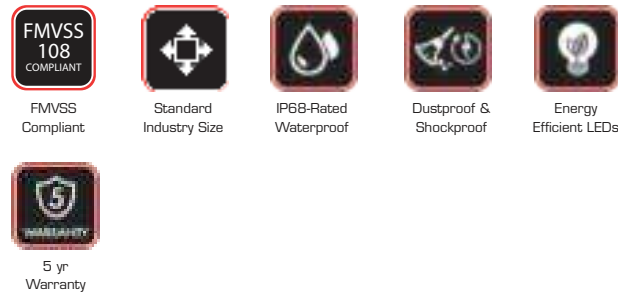

PEDESTAL LIGHTS

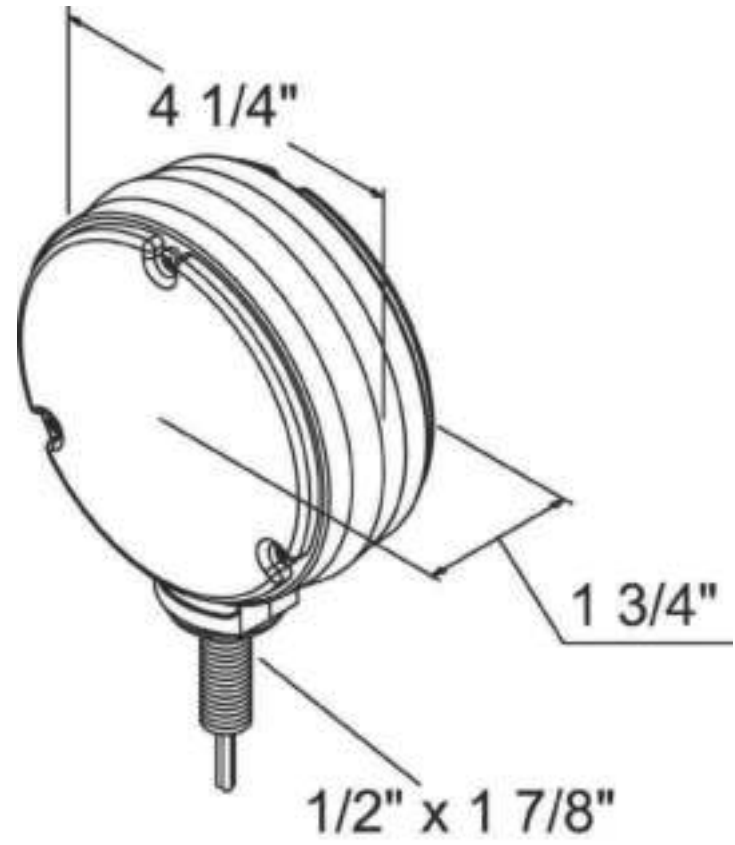

26 LED - Square Parking Light



SKU	PTPL-SDF-26-RA
DIMENSIONS	4.25"W X 4.25"H X 1.75"D
VOLTAGE	8-16 VDC
AMPS	0.65 A
WEIGHT	1 POUND
LED COUNT	26
WATERPROOF	IP68 RATED
COLOR TYPE	DUAL COLOR
AVAILABLE COLORS	■ ■

SPECIFICATIONS:

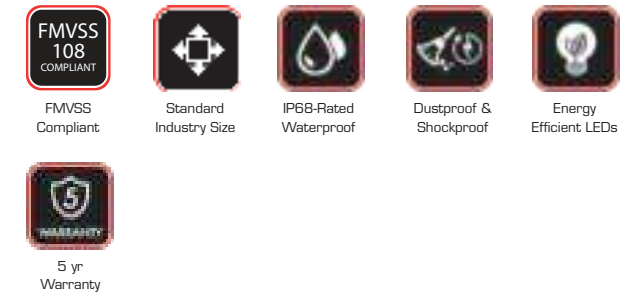

PEDESTAL LIGHTS

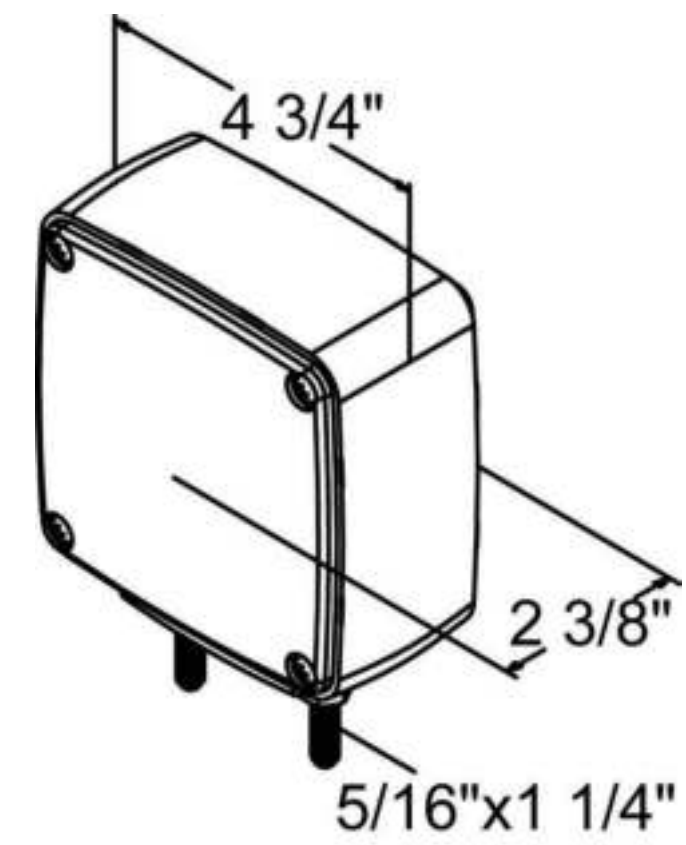

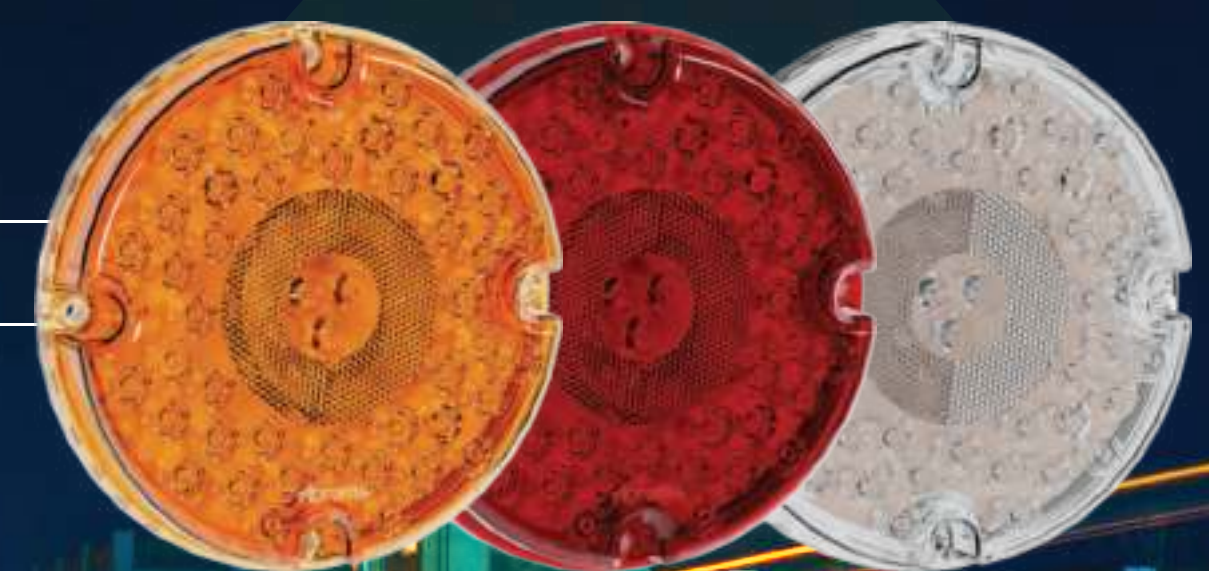

BUS --- **TAIL LIGHTS**

KEEPING OUR CHILDREN SAFE
ON THE ROADS

7" - 47 LED Round Bus Tail Light



SKU	BTL-R47-A
DIMENSIONS	7" X 6.25" X 1.07"
VOLTAGE	8-16 VDC
AMPS	0.50 A
WEIGHT	1 POUNDS
LED COUNT	47 LED
WATERPROOF	IP68 RATED
COLOR TYPE	DUAL COLOR
AVAILABLE COLORS	

SPECIFICATIONS:

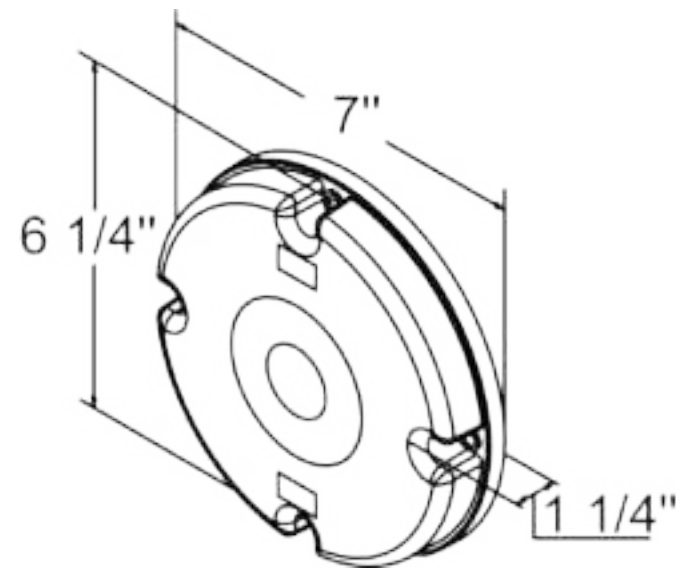
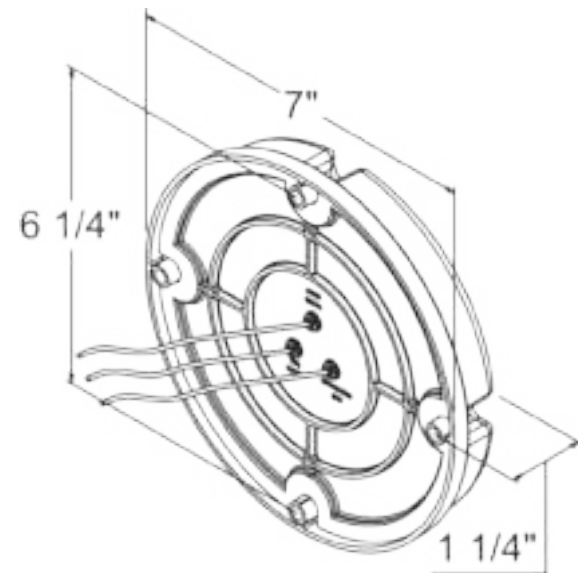
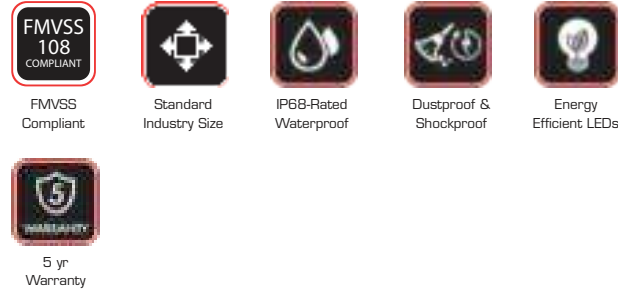

COMING SOON





TRAILER TAIL LIGHTS

SAFETY ISN'T EXPENSIVE, IT'S PRICELESS

4" - 10 LED Round Tail Light



SKU	TTL-R10-X
DIMENSIONS	5.5" X 4.125" X 1"
VOLTAGE	8-16 VDC
AMPS	0.25 A
WEIGHT	1 POUNDS
LED COUNT	10 LED
WATERPROOF	IP67 RATED
DOT	FMVSS-108 COMPLIANT
COLOR TYPE	SINGLE COLOR
AVAILABLE COLORS	  

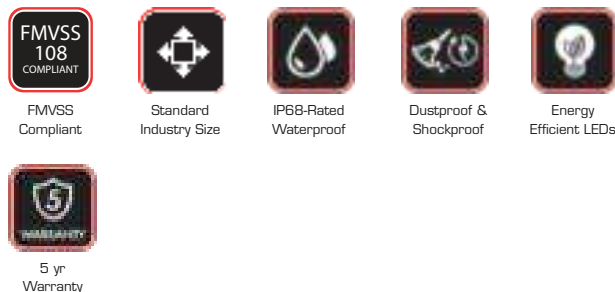

SPECIFICATIONS:



TRAILER TAIL LIGHTS

6" - 10 LED Oval Tail Light



SKU	TTL-O10-X
DIMENSIONS	7.625"W X 3.375"H X 1"D
VOLTAGE	8-16 VDC
AMPS	0.25 A
WEIGHT	1 POUNDS
LED COUNT	10 LED
WATERPROOF	IP67 RATED
DOT	FMVSS-108 COMPLIANT
BEAM PATTERN	SINGLE COLOR
AVAILABLE COLORS	  

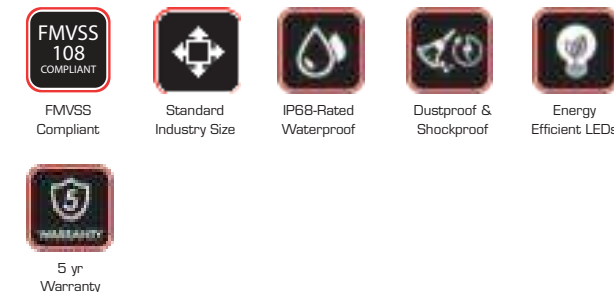

SPECIFICATIONS:



TRAILER TAIL LIGHTS

4" - 24 LED Round Tail Light



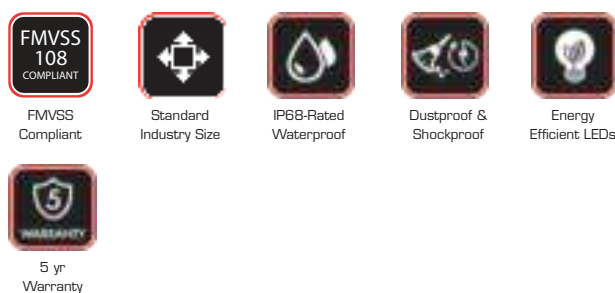

SKU	TTL-R24-X
DIMENSIONS	5.5" X 4.125" X 1"
VOLTAGE	8-16 VDC
AMPS	0.25 A
WEIGHT	1 POUNDS
LED COUNT	24 LED
WATERPROOF	IP67 RATED
DOT	FMVSS-108 COMPLIANT
BEAM PATTERN	SINGLE COLOR
AVAILABLE COLORS	  

SPECIFICATIONS:



6" - 24 LED Oval Tail Light



SKU	TTL-O24-X
DIMENSIONS	7.625"W X 3.375"H X 1"D
VOLTAGE	8-16 VDC
AMPS	0.25 A
WEIGHT	1 POUNDS
LED COUNT	24 LED
WATERPROOF	IP67 RATED
DOT	FMVSS-108 COMPLIANT
BEAM PATTERN	SINGLE COLOR
AVAILABLE COLORS	  

SPECIFICATIONS:

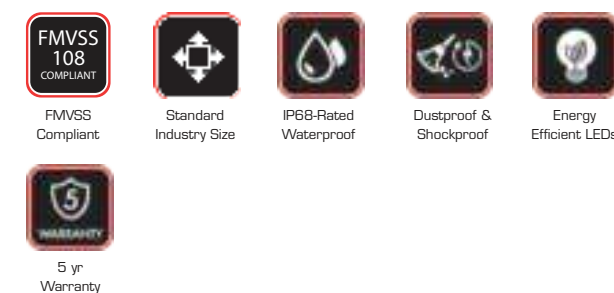

5"x3" - 10 LED Rectangular Tail Light



SKU	TTL-S10-X
DIMENSIONS	5.375"H X 3.5"W X 1.5"D
VOLTAGE	8-16 VDC
AMPS	0.25 A
WEIGHT	1 POUNDS
LED COUNT	10 LED
WATERPROOF	IP67 RATED
DOT	FMVSS-108 COMPLIANT
COLOR TYPE	SINGLE COLOR
AVAILABLE COLORS	■ ■ ■

SPECIFICATIONS:

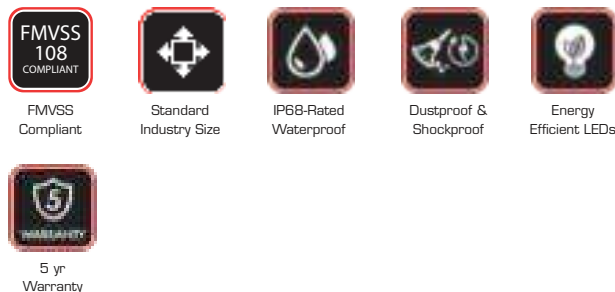

TRAILER TAIL LIGHTS

6" Oval - 35 LED Sequential Turn Light



SKU	STTL-035-X
DIMENSIONS	6.5"W X 2.25"H X 1.87"D
VOLTAGE	9-36 VDC
AMPS	0.95 A
WEIGHT	1 POUNDS
LED COUNT	35 LED
WATERPROOF	IP67 RATED
DOT	FMVSS-108 COMPLIANT
BEAM PATTERN	SINGLE COLOR
AVAILABLE COLORS	■ ■

SPECIFICATIONS:

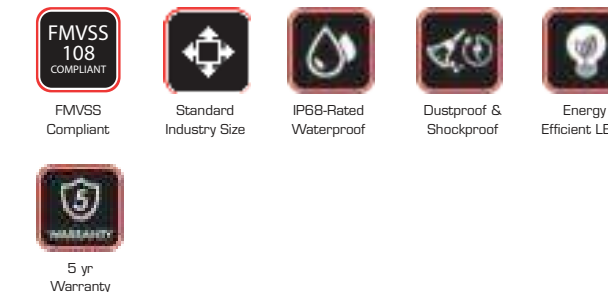

TRAILER TAIL LIGHTS

5"x3" - 24 LED Rectangular Tail Light



SKU	TTL-S24-X
DIMENSIONS	5.31"H X 3.437"W X 1.125"D
VOLTAGE	8-16 VDC
AMPS	0.25 A
WEIGHT	1 POUNDS
LED COUNT	24 LED
WATERPROOF	IP67 RATED
DOT	FMVSS-108 COMPLIANT
BEAM PATTERN	SINGLE COLOR
AVAILABLE COLORS	■ ■ ■

SPECIFICATIONS:

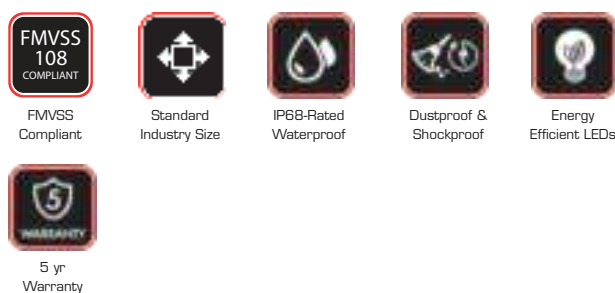

6" Oval - 9 LED Turn Light



SKU	TTL-S24-X
DIMENSIONS	6.5"W X 2.31"H X 2.68"D
VOLTAGE	8-16 VDC
AMPS	0.25 A
WEIGHT	1 POUNDS
LED COUNT	9 LED
WATERPROOF	IP67 RATED
DOT	FMVSS-108 COMPLIANT
BEAM PATTERN	SINGLE COLOR
AVAILABLE COLORS	■

SPECIFICATIONS:

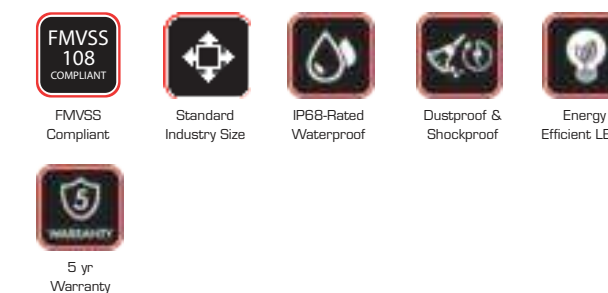

4" Round - 24 LED Trailer Strobe Light



SKU	TSL-R24-X
DIMENSIONS	5.5"W X 4.125"H X 1"D
VOLTAGE	9-36 VDC
AMPS	0.7 A
WEIGHT	1 POUNDS
LED COUNT	24 LED
WATERPROOF	IP67 RATED
DOT	FMVSS-108 COMPLIANT
COLOR TYPE	SINGLE COLOR
AVAILABLE COLORS	

SPECIFICATIONS:

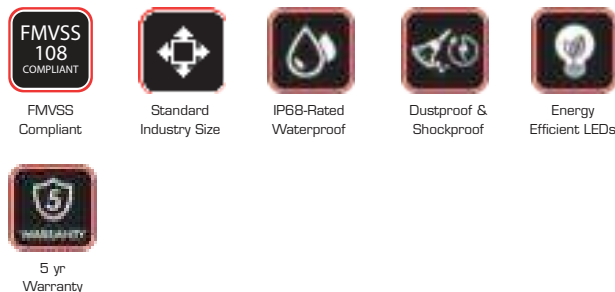

6" Oval - 24 LED Trailer Strobe Light



SKU	TSL-O24-X
DIMENSIONS	7.625"W X 3.3"H X 1"D
VOLTAGE	9-36 VDC
AMPS	0.7 A
WEIGHT	1 POUNDS
LED COUNT	24 LED
WATERPROOF	IP67 RATED
DOT	FMVSS-108 COMPLIANT
BEAM PATTERN	SINGLE COLOR
AVAILABLE COLORS	

SPECIFICATIONS:

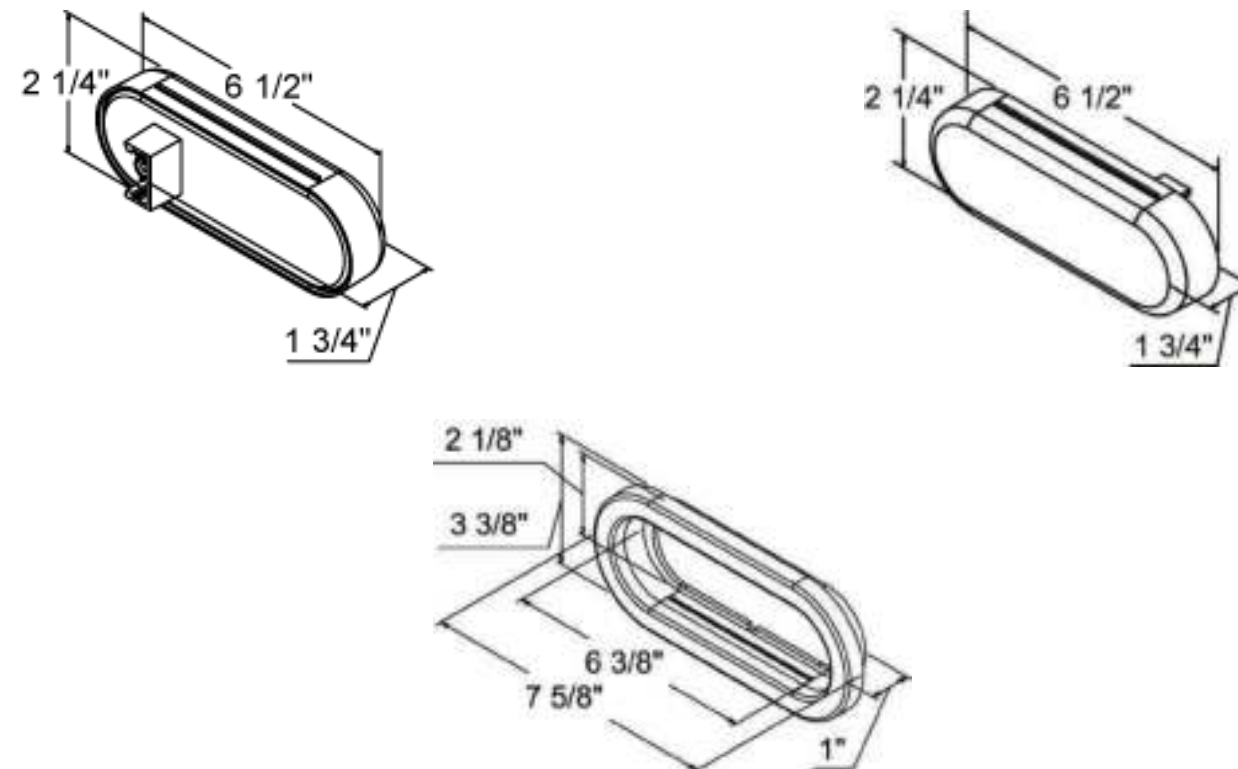
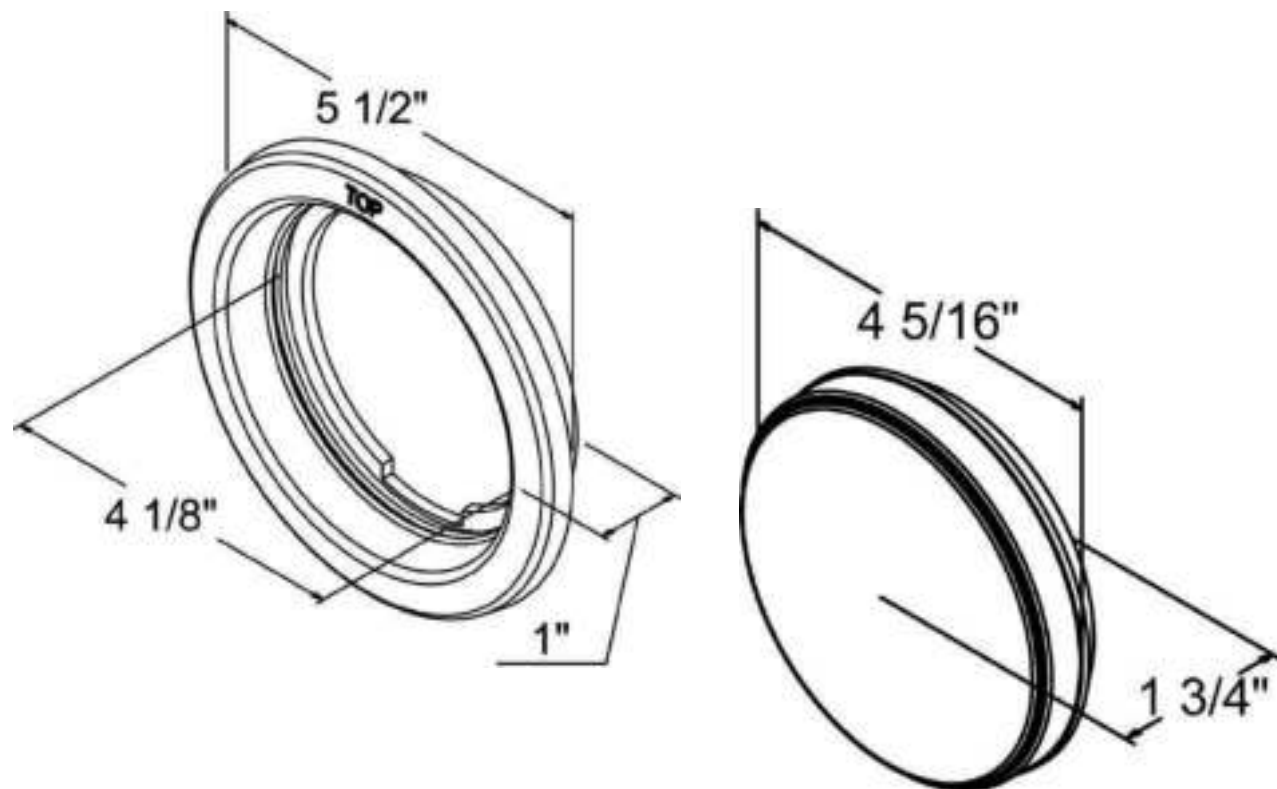
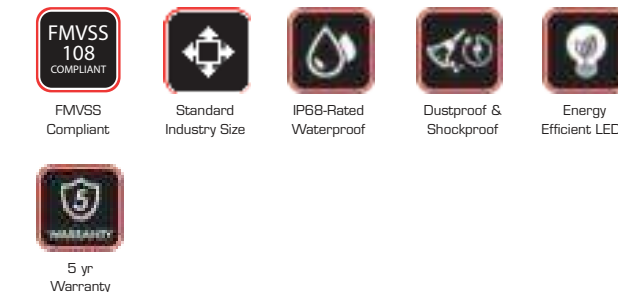

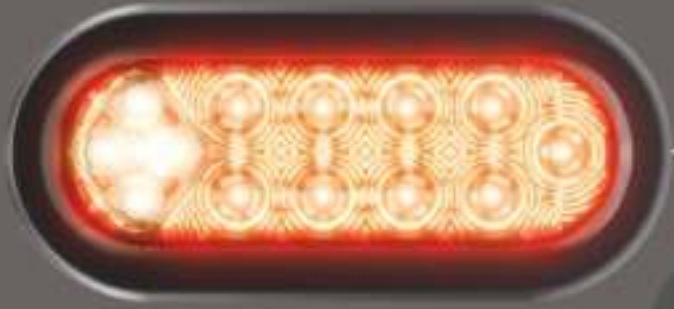

COMBINATION TRAILER LIGHTS

SUPER BRIGHT ALL IN ONE
BRAKE, TAIL, TURN & REVERSE

4" Round 12 LED's Fiesta Combo Trailer Light



SKU	FIESTA-R12
DIMENSIONS	4.375" L X 1.375"D
VOLTAGE	8-16 VDC
AMPS	0.25 A
WEIGHT	13.6 OUNCES
LED COUNT	12
WATERPROOF	IP68 RATED
DOT	FMVSS-108 COMPLIANT
COLOR TYPE	DUAL COLOR
AVAILABLE COLORS	

SPECIFICATIONS:

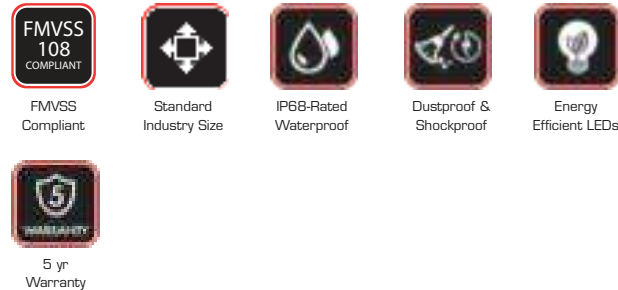

COMBINATION LIGHTS

6" Oval 13 LED's Fiesta Combo Trailer Light



SKU	FIESTA-O13
DIMENSIONS	6.5"L X 2.31"H X 1.43"D
VOLTAGE	8-16 VDC
AMPS	0.25 A
WEIGHT	12.8 OUNCES
LED COUNT	13
WATERPROOF	IP68 RATED
DOT	FMVSS-108 COMPLIANT
BEAM PATTERN	DUAL COLOR
AVAILABLE COLORS	

SPECIFICATIONS:

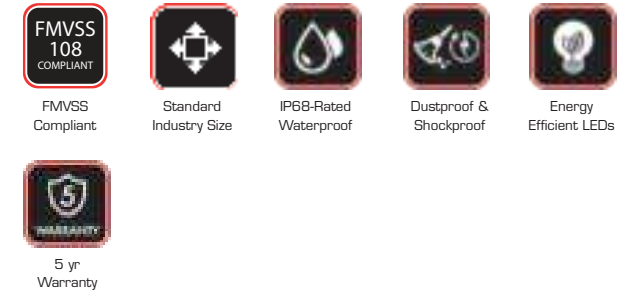

COMBINATION LIGHTS

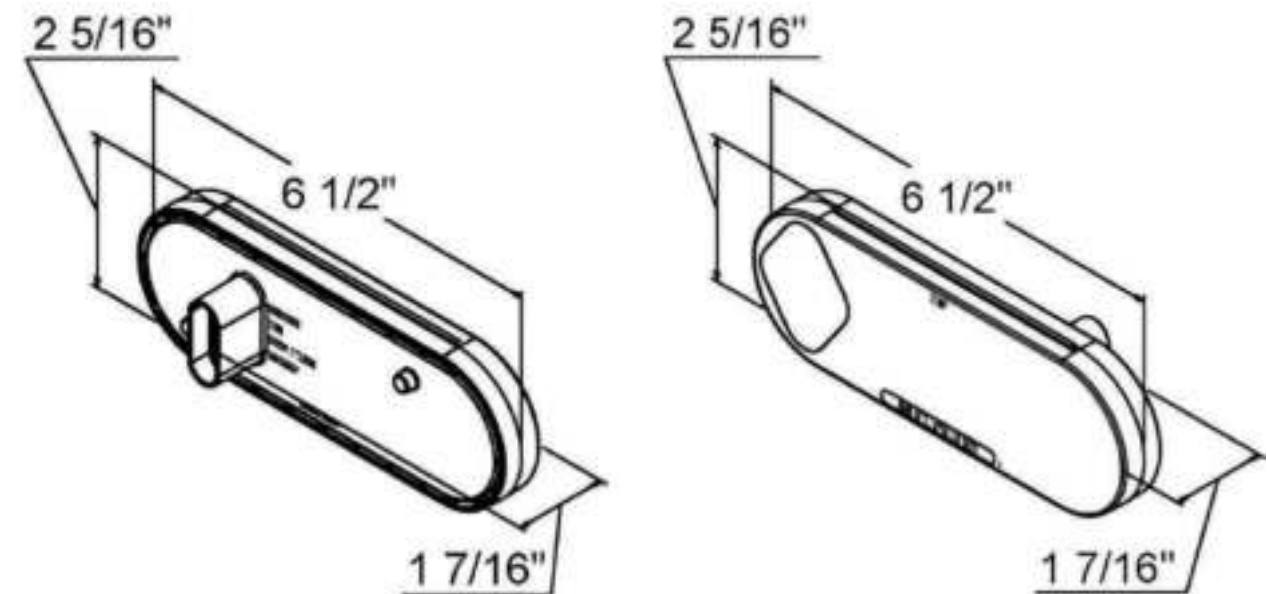
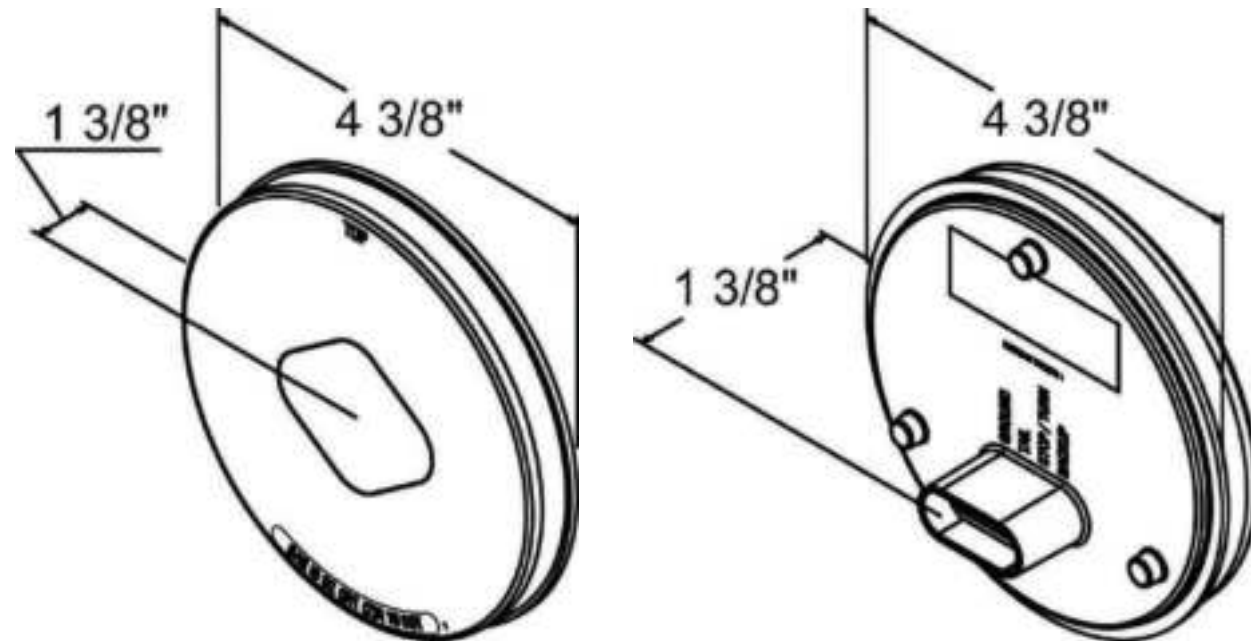

4" Round All in One Fiesta Combo Trailer Strobe Light



SKU	TSLC-R-GL-AW-L/R
DIMENSIONS	4.33"D X 1.00"H
VOLTAGE	12VDC
AMPS	1.68A
WEIGHT	13.6 OUNCES
LED COUNT	13
WATERPROOF	IP67 RATED
DOT	DOT/FMVSS 108/SAE CLASS 1*
COLOR TYPE	DUAL COLOR
AVAILABLE COLORS	

SPECIFICATIONS:

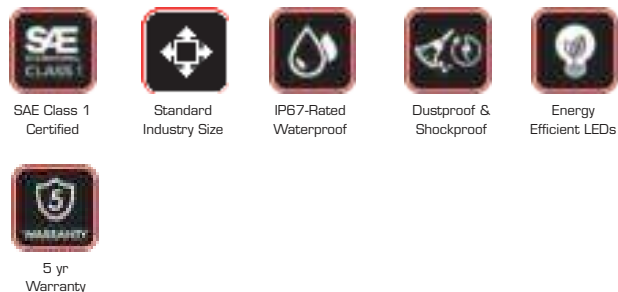

COMBINATION LIGHTS

6" Oval All in One Fiesta Combo Trailer Strobe Light



SKU	TSLC-O-GL-AW-L/R
DITMENSIONS	5.23"L X 1.18"W X 1.07"H
VOLTAGE	12VDC
AMPS	1.74A
WEIGHT	12.8 OUNCES
LED COUNT	13
WATERPROOF	IP67 RATED
DOT	DOT/FMVSS 108/SAE CLASS 1*
COLOR TYPE	DUAL COLOR
AVAILABLE COLORS	

SPECIFICATIONS:

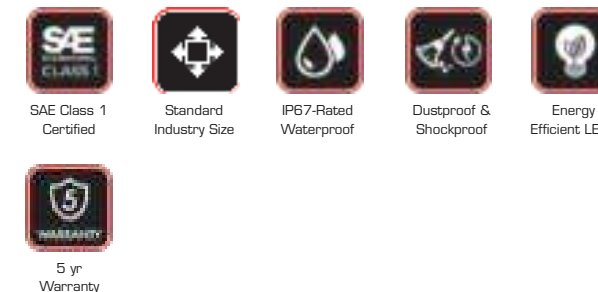

COMBINATION LIGHTS

REVERSE LIGHT BRAKE LIGHT



TAIL LIGHT STROBE FUNCTION

REVERSE LIGHT BRAKE LIGHT



TAIL LIGHT STROBE FUNCTION



TRAILER CLEARANCE LIGHT

ENHANCE YOUR VEHICLE'S VISIBILITY



3/4" Bullet Clearance Lights



SKU	BCL-R1
DIMENSIONS	0.75"W X 1"H X 0.62"D
VOLTAGE	8-16 VDC
AMPS	0.06 A
WEIGHT	3.2 OUNCES
LED COUNT	1 LED
WATERPROOF	IP68 RATED
DOT	FMVSS-108 COMPLIANT
COLOR TYPE	SINGLE COLOR
AVAILABLE COLORS	AMBER, AMBER/CLEAR LENS, RED, RED/CLEAR LENS

SPECIFICATIONS:

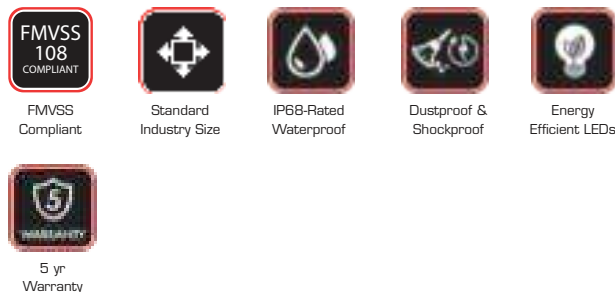

TRAILER CLEARANCE LIGHTS

2.5" Side Marker Clearance Light



SKU	TML-R213
DIMENSIONS	2.5"W X 3.31"H X 1.125"D
VOLTAGE	8-16 VDC
AMPS	0.08 A
WEIGHT	8.8 OUNCES
LED COUNT	13 LED
WATERPROOF	IP67 RATED
DOT	FMVSS-108 COMPLIANT
BEAM PATTERN	SINGLE COLOR
AVAILABLE COLORS	Yellow, Red

SPECIFICATIONS:

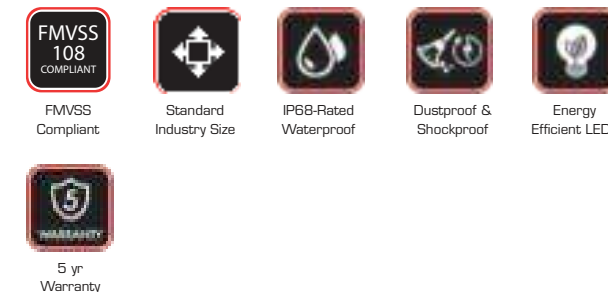

TRAILER CLEARANCE LIGHTS

2" Side Marker Clearance Light



SKU	TML-R210
DIMENSIONS	2"W X 2.875"H X 0.812"D
VOLTAGE	8-16 VDC
AMPS	0.06 A
WEIGHT	3.2 OUNCE
LED COUNT	10 LED
WATERPROOF	IP67 RATED
DOT	FMVSS-108 COMPLIANT
BEAM PATTERN	SINGLE COLOR
AVAILABLE COLORS	Yellow, Red

SPECIFICATIONS:

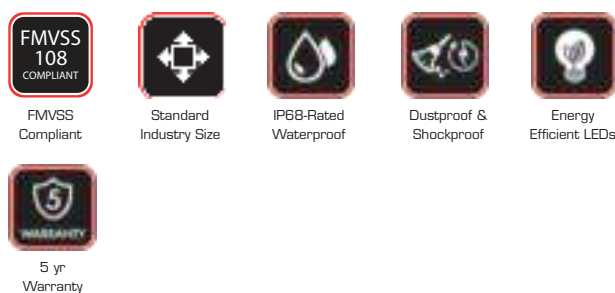

4"x2" Bullseye Clearance Light



SKU	TML-S416
DIMENSIONS	4"W X 2"H X 1.125"D
VOLTAGE	8-16 VDC
AMPS	0.08 A
WEIGHT	5.6 OUNCES
LED COUNT	16 LED
WATERPROOF	IP67 RATED
DOT	FMVSS-108 COMPLIANT
BEAM PATTERN	SINGLE COLOR
AVAILABLE COLORS	Yellow, Red

SPECIFICATIONS:

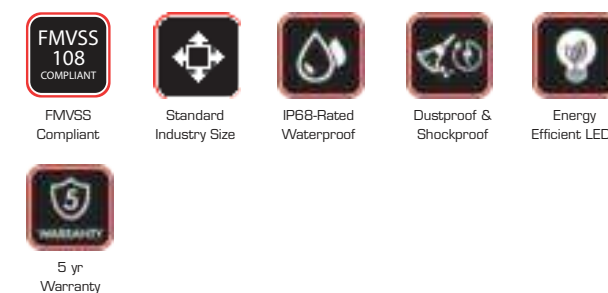



FULL
BUILDING
LEADERSHIP
OPPORTUNITIES
OFFICE
RETAIL

212 841 5965
212 713 6795



TRAILER ID BAR

SAFETY OF YOUR WIDER TRAILER



15" ID Marker Light Bar



SKU	TCL-B9
DIMENSIONS	14.07"W X 1.05"H X 1"D
VOLTAGE	8-16 VDC
AMPS	0.5 A
WEIGHT	10 OUNCES
LED COUNT	9 LED
WATERPROOF	IP67 RATED
DOT	FMVSS-108 COMPLIANT
COLOR TYPE	SINGLE COLOR
AVAILABLE COLORS	

SPECIFICATIONS:

- FMVSS 108 Compliant
- Standard Industry Size
- IP68-Rated Waterproof
- Dustproof & Shockproof
- Energy Efficient LEDs
- 5 yr Warranty

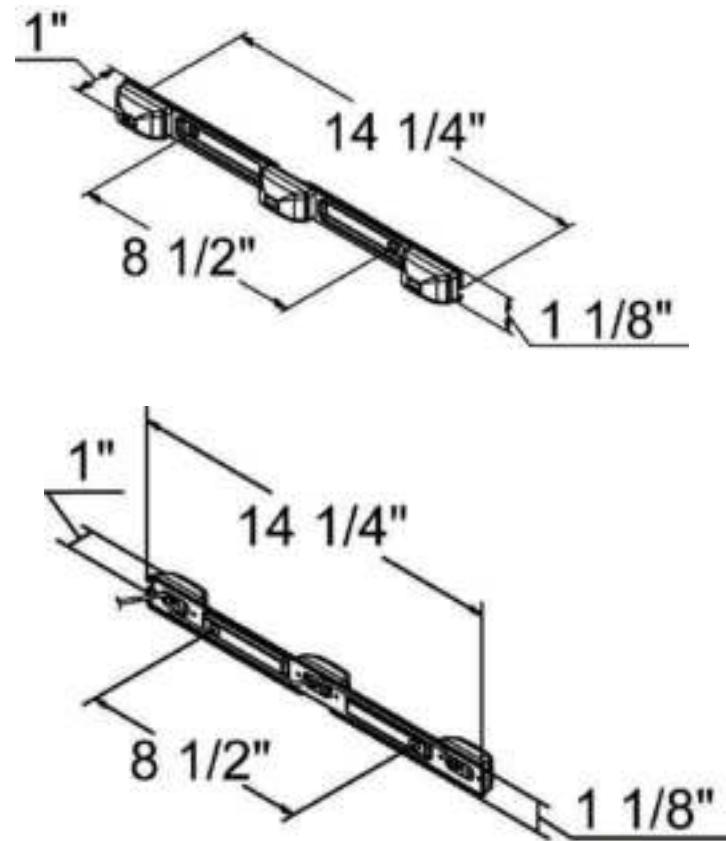

COMING SOON



LICENSE PLATE LIGHTS

COMPLIES WITH LOCAL LAWS AND REGULATIONS



Bracket Mount Series License Plate Lights

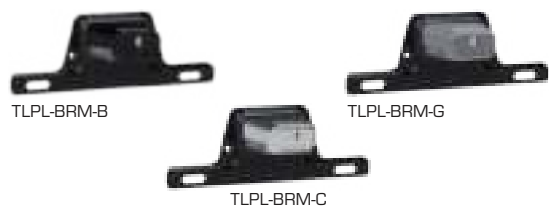

SKU	TLPL-BRM
DIMENSIONS	8.5"W X 2.87"H X 2.37"D
VOLTAGE	8-16 VDC
WATTAGE	2W
AMPS	0.06 A
WEIGHT	7 OUNCES
LED COUNT	2 LED
WATERPROOF	IP67 RATED
MATERIAL	ROBUST POLYCARBONATE & RUST-RESISTANT STEEL
COLOR TYPE	SINGLE COLOR
HOUSING COLORS	BLACK, CHROME, GREY

SPECIFICATIONS:

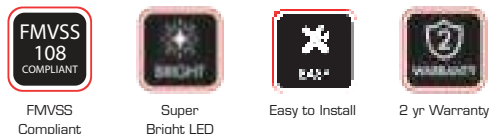

Stud Mount Series License Plate Lights



SKU	TLPL-STM
DIMENSIONS	2.12"W X 2.81"H X 1.62"D
VOLTAGE	8-16 VDC
WATTAGE	2W
AMPS	0.06 A
WEIGHT	3 OUNCES
LED COUNT	2 LED
WATERPROOF	IP67 RATED
MATERIAL	ROBUST POLYCARBONATE & RUST-RESISTANT STEEL
COLOR TYPE	SINGLE COLOR
HOUSING COLORS	BLACK, CHROME, GREY

SPECIFICATIONS:

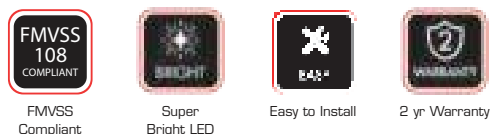

Surface Mount Series License Plate Lights



SKU	TLPL-SUM
DIMENSIONS	4"W X 2.25"H X 1.75"D
VOLTAGE	8-16 VDC
WATTAGE	2W
AMPS	0.06 A
WEIGHT	3 OUNCES
LED COUNT	2 LED
WATERPROOF	IP67 RATED
MATERIAL	ROBUST POLYCARBONATE & RUST-RESISTANT STEEL
COLOR TYPE	SINGLE COLOR
HOUSING COLORS	BLACK, CHROME, GREY

SPECIFICATIONS:

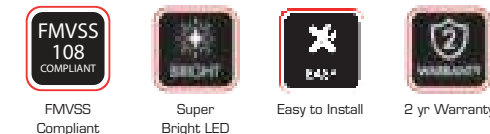

Universal Mount Tag Light License Plate Lights



SKU	ULPL-SUM
DIMENSIONS	2.62"W X 1.18"H X 1"D
VOLTAGE	8-16 VDC
WATTAGE	2W
AMPS	0.06 A
WEIGHT	3 OUNCES
LED COUNT	2 LED
WATERPROOF	IP67 RATED
MATERIAL	ROBUST POLYCARBONATE & RUST-RESISTANT STEEL
COLOR TYPE	SINGLE COLOR
HOUSING COLORS	BLACK, CHROME, GREY

SPECIFICATIONS:

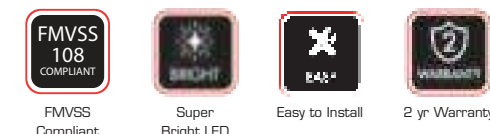



REFLECTIVE TAPE

EASILY DISCOVERABLE BY OTHERS

Solas Tape Series



SOLAS 2 X 30



SOLAS 2 X 75















SOLAS 2 X 50



SOLAS 2 X 150

SPECIFICATIONS:

 Solas Grade	 Honeycomb Design	 High Stretchable	 Easy to Apply & Removable	 Long Lifespan
 NHTSA Certified	 FMVSS Certified	 Dot Certified	 Weatherproof	 5 yr Warranty
 High Reflectivity	 Strong Adhesive			

SKU	SOLAS
SIZE	30, 50, 75, 150 FOOT
WIDTH	2"
WEIGHT	0.5 POUND
TAPE TYPE	SOLAS
RATED LIFESPAN	10 YEARS
COLOR	SINGLE
AVAILABLE COLORS	WHITE

DOT C2 Tape Series



DOT-C2 2X 30



DOT-C2 2 X 150



DOT-C2 2 X 50















DOT-C2 2 X 75



DOT-C2 2 X 150

SPECIFICATIONS:

 DOT Certified	 Honeycomb Design	 High Stretchable	 Easy to Apply & Removable	 Long Lifespan
 NHTSA Certified	 FMVSS Certified	 Strong Adhesive	 Weatherproof	 5 yr Warranty
 High Reflectivity				

SKU	DOT-C2
SIZE	30, 50, 75, 150 FOOT
WIDTH	2"
WEIGHT	0.5 POUND
TAPE TYPE	SOLAS
RATED LIFESPAN	10 YEARS
COLOR	SINGLE
AVAILABLE COLORS	



SIREN SYSTEMS

MOST POWERFUL SIREN SYSTEMS
IN THE MARKET

Escape 100W Siren System



SKU	EC-100
DIMENSIONS	5.7" W X 2.53" H X 6.4" D
VOLTAGE	10-16 VDC
WATTAGE	100 WATT
AMPS	10 A
WEIGHT	3.3 POUND
STAND BY CURRENT	LESS THAN 220 MA
WATERPROOF	IP64 RATED
SIREN TONES	HORN, MANUAL, WAIL, YEIP, HI-LO, PHSR

SPECIFICATIONS:

- SAE Class J1849 Standards
- Universal Design
- 6 Siren Tones
- Volume Control
- Horn Ring
- PA System
- 2 x 10A Light Control
- 1 yr Warranty

Escape 200W Siren System



SKU	EC-200
DIMENSIONS	5.7" W X 2.53" H X 6.4" D
VOLTAGE	10-16 VDC
WATTAGE	200 WATT
AMPS	17 A
WEIGHT	3.3 POUND
STAND BY CURRENT	LESS THAN 220 MA
WATERPROOF	IP64 RATED
SIREN TONES	HORN, MANUAL, WAIL, YEIP, HI-LO, PHSR

SPECIFICATIONS:

- SAE Class J1849 Standards
- Universal Design
- 6 Siren Tones
- Volume Control
- Horn Ring
- PA System
- 2 x 10A Light Control
- 1 yr Warranty

Expedition 100W Siren System



SKU	EH-100
DIMENSIONS	1.0" x 1.6" x 3.7" (CONTROLLER) 1.8" x 3.9" x 6.3 (AMPLIFIER)
VOLTAGE	10-16 VDC
WATTAGE	100 WATT
AMPS	8.5 AMPS
WEIGHT	2.2 POUNDS
STAND BY CURRENT	LESS THAN 35 MA
WATERPROOF	IP65 RATED
SIREN TONES	HORN, MANUAL, WAIL, YEIP, HI-LO, PHSR, PRIM, HHI

SPECIFICATIONS:

- SAE Class J1849 Standards
- 8 Siren Tones
- Volume Control
- 100 Watt High Power
- PA System
- Easy Installation
- 2 x 10A Light Output
- Universal Fit
- 1 yr Warranty

Expedition 200W Siren System



SKU	EH-200
DIMENSIONS	1.0" x 1.6" x 3.7" (CONTROLLER) 1.8" x 3.9" x 6.3 (AMPLIFIER)
VOLTAGE	10-16 VDC
WATTAGE	200 WATT
AMPS	17 AMPS
WEIGHT	3.44 POUNDS
STAND BY CURRENT	LESS THAN 160 MA
WATERPROOF	IP65 RATED
SIREN TONES	HORN, MANUAL, WAIL, YEIP, HI-LO, HYPER-LO, HYPER-YELP, & WHOOP

SPECIFICATIONS:

- SAE Class J1849 Standards
- 8 Siren Tones
- Volume Control
- Horn Ring
- 200 Watt High Power
- PA System
- 2 x 10A Light Output
- Universal Fit
- Easy Installation
- 1 yr Warranty

Logic 1100 Programmable Handheld & Light Controller



SKU	LGS-1100-H
DIMENSIONS	7.48"W X 8.54"L X 1.79"H (AMPLIFIER) 2.61"W X 5.27"L X 1.05"D (CONTROLLER)
VOLTAGE	12-24 VDC
WATTAGE	100W
AMPS	8.5A/4A
OPERATING TEMP.	86F TO 149F
SIREN TONES	WAIL YELP PHASER, HI-LO, HORN
LOW AMP DRAW	CLASS D AMPLIFIER PRODUCES AN INCREDIBLY CLEAN, CRISP TONE & LOUD OUTPUT

SPECIFICATIONS:

- SAE Class J1849 Standards
- Backlit Keypad
- 22 Siren Tones
- Volume Control
- Horn Ring Transfer
- RRB & PA System
- 45 Icons Stickers
- Button Interlink
- Momentary Switch
- 5 yr Warranty

Logic 2200 Programmable Console & Light Controller



SKU	LGS-2200-C
DIMENSIONS	7.49"W X 8.54"L X 1.8"H (AMPLIFIER) 6.93"W X 3.66"L X 1.21"D (CONTROLLER)
VOLTAGE	12-24 VDC
WATTAGE	200 WATT
AMPS	20A /10 A
OPERATING TEMP.	86F TO 149F
SIREN TONES	WAIL YELP PHASER, HI-LO, HORN
LOW AMP DRAW	CLASS D AMPLIFIER PRODUCES AN INCREDIBLY CLEAN, CRISP TONE & LOUD OUTPUT

SPECIFICATIONS:

- SAE Class J1849 Standards
- Backlit Keypad
- 22 Siren Tones
- Volume Control
- Horn Ring Transfer
- RRB & PA System
- 45 Icons Stickers
- Fully Programmable
- Momentary Switch
- Button Interlink
- 5 yr Warranty

Logic 2200 Programmable Handheld & Light Controller



SKU	LGS-2200-H
DIMENSIONS	7.48"W X 8.54"L X 1.79"H (AMPLIFIER) 2.61"W X 5.27"L X 1.05"D (CONTROLLER)
VOLTAGE	12-24 VDC
WATTAGE	100W
AMPS	20A@12VDC/10A@24VDC
OPERATING TEMP.	86F TO 149F
SIREN TONES	WAIL YELP PHASER, HI-LO, HORN
LOW AMP DRAW	CLASS D AMPLIFIER PRODUCES AN INCREDIBLY CLEAN, CRISP TONE & LOUD OUTPUT

SPECIFICATIONS:

- SAE Class J1849 Standards
- Backlit Keypad
- 22 Siren Tones
- Volume Control
- Horn Ring Transfer
- RRB & PA System
- 45 Icons Stickers
- Fully Programmable
- Momentary Switch
- Button Interlink
- 5 yr Warranty

SIREN / AMPLIFIER

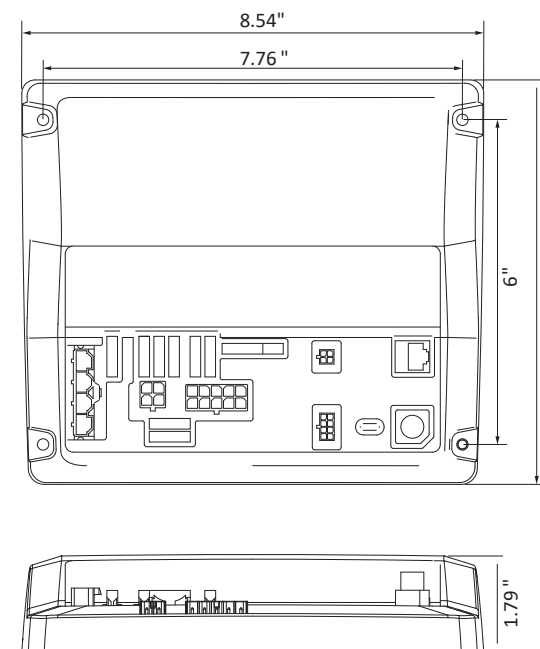

CONTROL HEAD

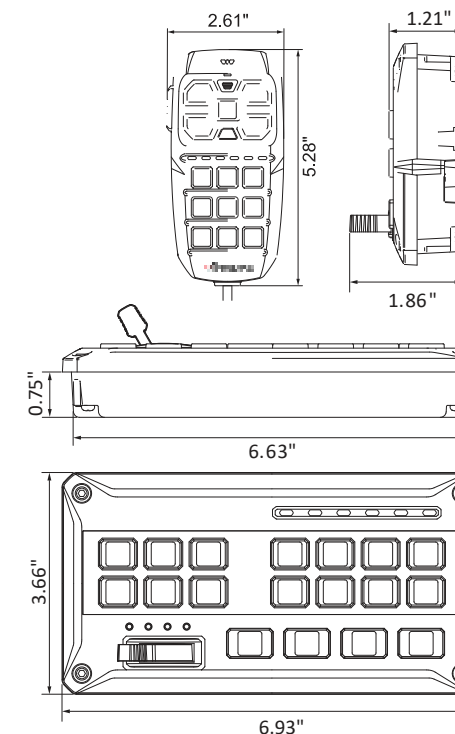

MACRO WATERPROOF MOTORCYCLE SIREN SYSTEM

SIREN SYSTEM

SKU	AS-400, MSS-100
DIMENSIONS	3.93" W x 3.75" H x 1.27" D 0.93" L X 1.49 W" X 2.97" H
VOLTAGE	10-30 VDC
WATTAGE	100 WATT
AMPS	2.5 AMPS
WEIGHT	3 POUND
OPERATING TEMPERATURE	-40° C - 70° C
AMPLIFIER WATERPROOF	IP65 RATED
CONTROLLER WATERPROOF	IP66 RATED



SPECIFICATIONS:

- SAE Class J1849 Standards
- 5 Siren Tones
- PA System
- 100 Watt High Power
- Waterproof Wire Harness
- 124 DB
- NEO Driver
- Shock Resistant and Waterproof
- 5 yr Warranty

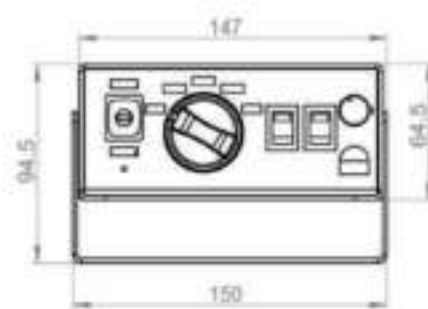
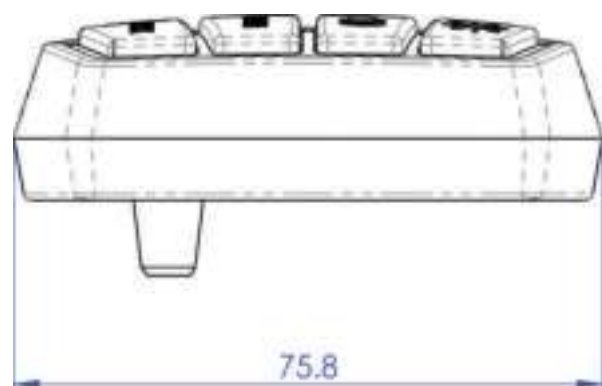
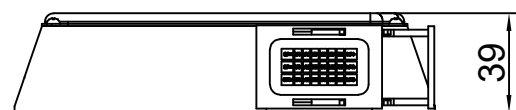
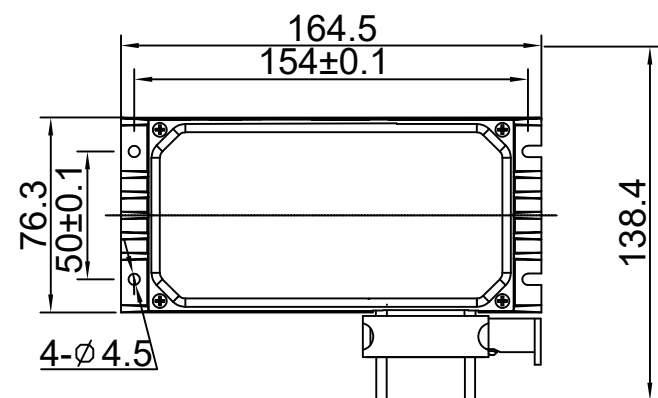

EC-100 & EC-200

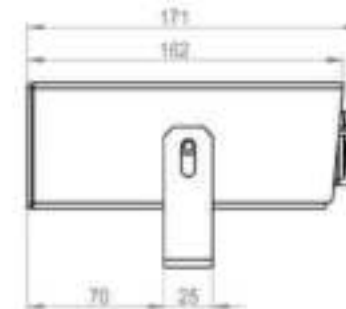

HANDHELD CONTROLER

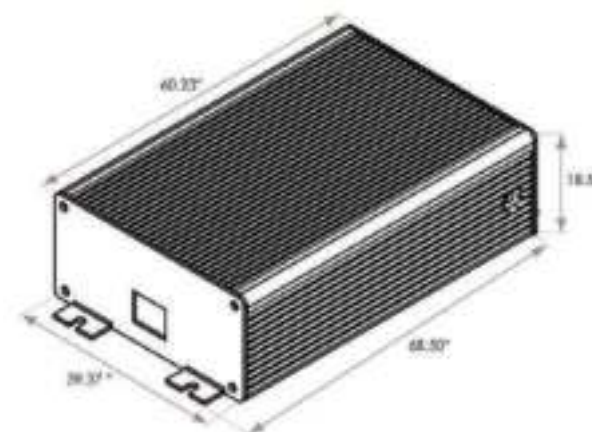

EH-100

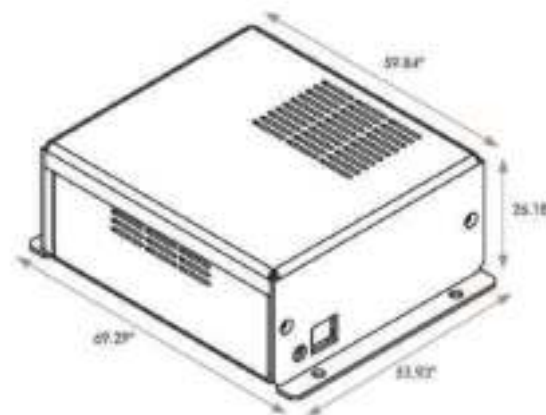

EH-200

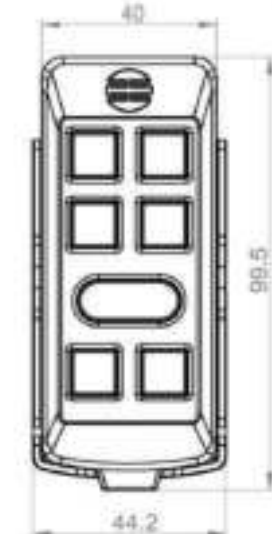
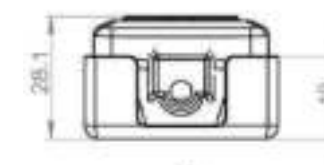

CONTROLER

SIREN SYSTEM

LOW-FREQUENCY ALARM SYSTEM

Getting attention and clearing traffic more effectively than a standard siren tone



Tornado 3 Low Frequency Siren System



SKU	TORNADO-3
DIMENSIONS	5.78"W X 4.88"H X 1.67"D
VOLTAGE	12-24 VDC
WATTAGE	100W
AMPS	8 A
WEIGHT	9 POUNDS
BRACKET TYPE	UNIVERSAL REVERSIBLE MOUNT
WATERPROOF	IP66 RATED
MATERIAL	ABS HOUSING
COLOR TYPE	BLACK

SPECIFICATIONS:

- SAE Class A
- NEO Driver
- Cost Efficient
- 100 Watt High Power
- Easy Installation
- 11 OHM
- 115 Decibel
- Universal Fit
- 2 yr Warranty

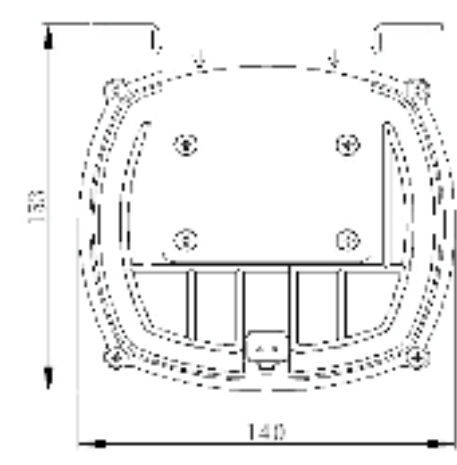
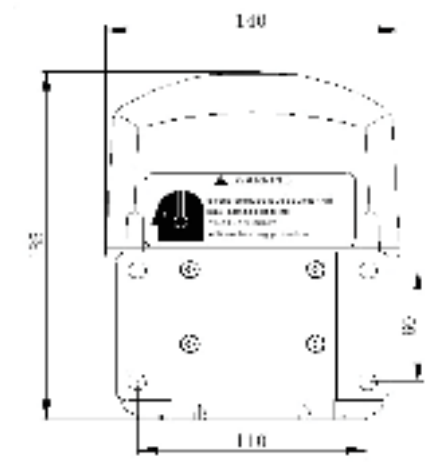



SIREN SPEAKERS

DESIGNED TO WITHSTAND
THE TOUGHEST CONDITIONS

ECO Series 100W Siren Speaker



SKU	ECS-100
DIMENSIONS	8.1"W X 5.2"H X 6.6"D
VOLTAGE	12 VCD
WATTAGE	100W
WEIGHT	4 POUNDS
WATERPROOF	IP67 RATED
PACKAGING CONTAINS	SPEAKER, OWNER'S MANUAL

SPECIFICATIONS:











 SAE Class A	 NEO Driver	 Cost Efficient	 100 Watt High Power	 Universal Fit
 Easy Installation	 OHM 11	 123 Decibel	 Shock Resistant and Waterproof	 2 yr Warranty

Ultra Series 100W Siren Speaker



SKU	ULS-100
DIMENSIONS	5.9"W X 4.9"H X 2.1"D
VOLTAGE	12 VCD
WATTAGE	100W
WEIGHT	5.3 POUNDS
WATERPROOF	IP67 RATED
PACKAGING CONTAINS	SPEAKER, OWNER'S MANUAL

SPECIFICATIONS:

 SAE Class A	 NEO Driver	 Cost Efficient	 100 Watt High Power	 Universal Fit
 Easy Installation	 OHM 11	 123 Decibel	 Shock Resistant and Waterproof	 2 yr Warranty

Slim Series 100W Siren Speaker



SKU	SLS-100
DIMENSIONS	5.9"W X 5.5"H X 2"D
VOLTAGE	12 VCD
WATTAGE	100W
WEIGHT	5.15 POUNDS
WATERPROOF	IP67 RATED
PACKAGING CONTAINS	SPEAKER, OWNER'S MANUAL

SPECIFICATIONS:





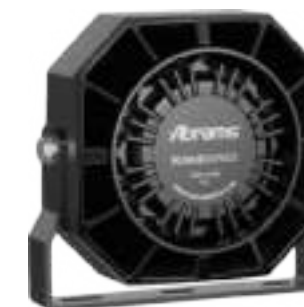





 SAE Class A	 NEO Driver	 Cost Efficient	 100 Watt High Power	 Universal Fit
 Easy Installation	 OHM 11	 123 Decibel	 Shock Resistant and Waterproof	 2 yr Warranty

Rogue Series 100W Siren Speaker



SKU	RGS-100
DIMENSIONS	7.5"W X 7.2"H X 2.7"D
VOLTAGE	12 VCD
WATTAGE	100W
WEIGHT	7 POUNDS
WATERPROOF	IP67 RATED
PACKAGING CONTAINS	SPEAKER, OWNER'S MANUAL

SPECIFICATIONS:

 SAE Class A	 NEO Driver	 Cost Efficient	 100 Watt High Power	 Universal Fit
 Easy Installation	 OHM 11	 124 Decibel	 Shock Resistant and Waterproof	 2 yr Warranty

Bolt Series 100W Siren Speaker



SKU	BLT-100
DIMENSIONS	W 6.33" X H 6.33" X D 2.93"
WATTAGE	100 WATT
WEIGHT	5.51 POUNDS
WATERPROOF	IP67 RATED
PACKAGING CONTAINS	SPEAKER, OWNER'S MANUAL

SPECIFICATIONS:

SAE Class A	NEO Driver	Cost Efficient	200 Watt High Power	Easy Installation
OHM 11	124 Decibel	Universal Fit	Shock Resistant and Waterproof	2 yr Warranty

Supreme Series 200W Speaker



SKU	SPS-200
DIMENSIONS	5.5"W X 5.82"H X 7"D
VOLTAGE	12 VOLTS
WATTAGE	200 WATT
WEIGHT	7.2 POUNDS
WATERPROOF	IP67 RATED
PACKAGING CONTAINS	SPEAKER, OWNER'S MANUAL

SPECIFICATIONS:

SAE Class A	NEO Driver	Cost Efficient	200 Watt High Power	Easy Installation
OHM 11	127 Decibel	Universal Fit	Shock Resistant and Waterproof	2 yr Warranty

Supreme Series 100W Speaker



SKU	SPS-100
DIMENSIONS	5.5"W X 5.82"H X 7"D
VOLTAGE	12 VCD
WATTAGE	200W
WEIGHT	7.2 POUNDS
WATERPROOF	IP67 RATED
PACKAGING CONTAINS	SPEAKER, OWNER'S MANUAL

SPECIFICATIONS:

SAE Class A	NEO Driver	Cost Efficient	200 Watt High Power	Easy Installation
OHM 11	127 Decibel	Universal Fit	Shock Resistant and Waterproof	2 yr Warranty

Macro Series Motorcycle Siren Speaker



SKU	MCS-50W-X2
DIMENSIONS	4.46"R x 3.62"D
VOLTAGE	10-24 VDC
WATTAGE	100 WATT
WEIGHT	2.8 POUND
WATERPROOF	IP66 RATED
PACKAGING CONTAINS	2 X 50W SPEAKERS, OWNER'S MANUAL

SPECIFICATIONS:

SAE Class J1849 Standards	100 Watt High Power	Waterproof Wire Harness	119 DB	Universal Fit
NEO Driver	Shock Resistant and Waterproof	Cost Efficient	OHM 11	Easy Installation
2 yr Warranty				



BACKUP ALARMS

BACK UP SAFETY WITH A
POWERFUL BACKUP ALARM

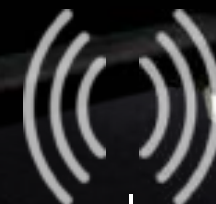

102 DB Series Backup Alarm



SKU	BAU-102
DIMENSIONS	4"W X 2.75"H X 2"D
VOLTAGE	10-80 VDC
MODEL VERSIONS	BEEP BEEP 102DB, SELF ADJUSTABLE 102DB WHITE NOISE 102DB
AMPS	250 MILIAMPS
WEIGHT	1 POUNDS
DB	102 DB
WATERPROOF	IP67 RATED
PACKAGING CONTAINS	BACKUP ALARM, OWNER'S MANUAL

SPECIFICATIONS:

Commercial Grade	No Grounding Wire Needed	Reverse Mount Speaker	102 Decibel	Easy Installation
Universal Fit	Sealed Epoxy	Shock Resistant and Waterproof	5 yr Warranty	

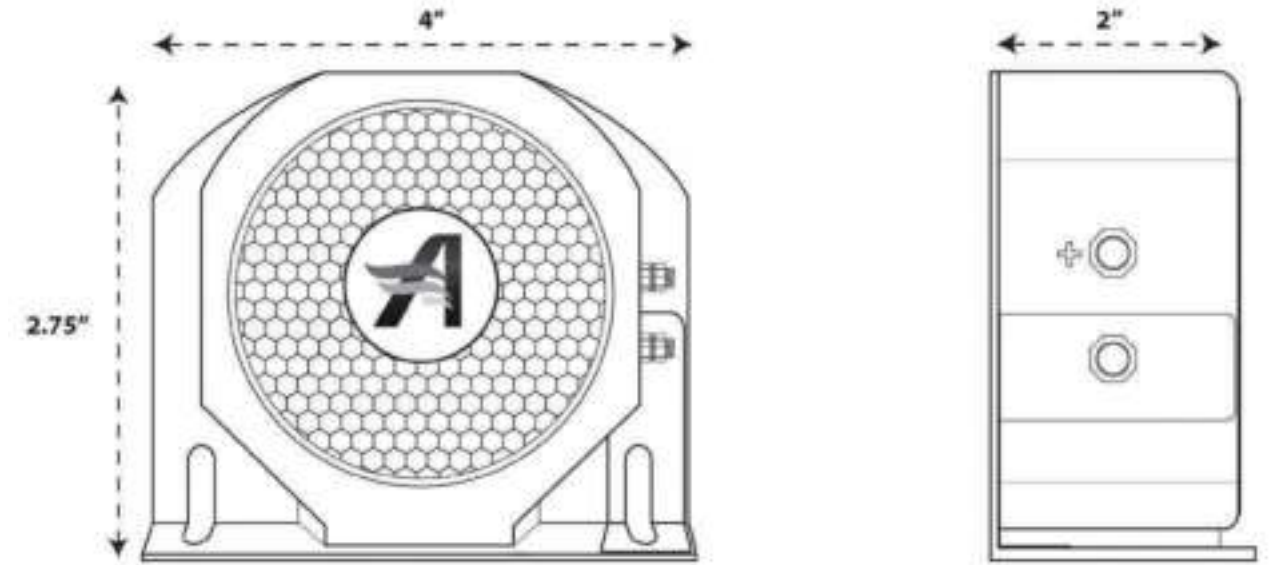

112 DB Series Backup Alarm



SKU	BAU-112
DIMENSIONS	5"W X 3"H X 4"D
VOLTAGE	10-80 VDC
MODEL VERSIONS	BEEP BEEP 112DB, SELF ADJUSTABLE 112DB WHITE NOISE 112DB
AMPS	250 MILIAMPS
WEIGHT	1.5 POUNDS
DB	107/112 DB
WATERPROOF	IP67 RATED
PACKAGING CONTAINS	BACKUP ALARM, OWNER'S MANUAL

SPECIFICATIONS:

Commercial Grade	No Grounding Wire Needed	Reverse Mount Speaker	112 Decibel	2 Level Alarm
Easy Installation	Universal Fit	Sealed Epoxy	Shock Resistant and Waterproof	5 yr Warranty

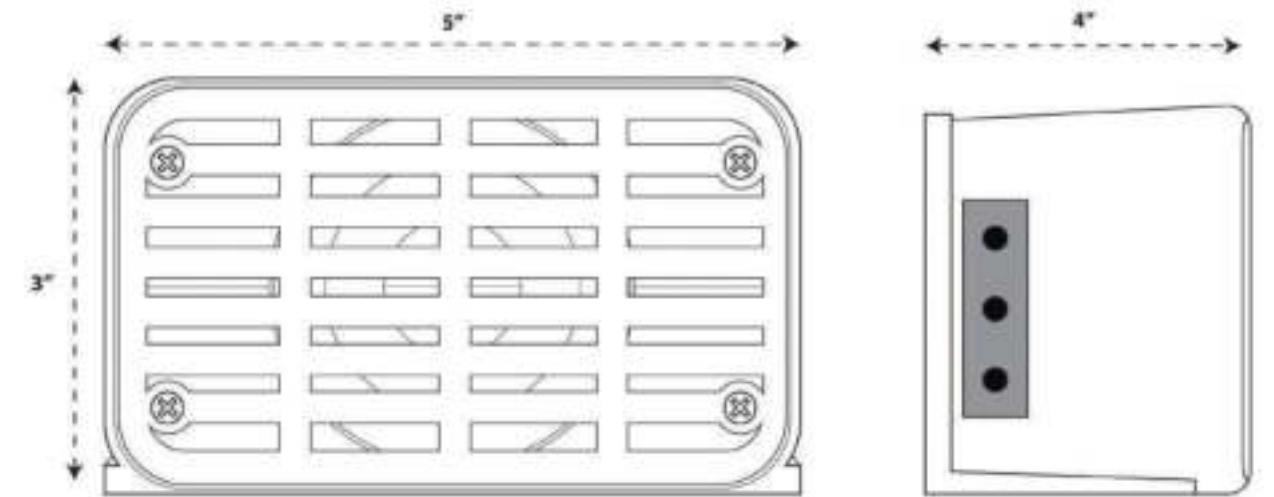

*SA - SELF ADJUSTMENT
*WN - WIDE NOISE



SWITCH PANEL & CONTROLLERS

EASILY CONTROL DIFFERENT ACCESSORIES

Taurus Series Switch Panels



SPECIFICATIONS:



SKU	ATSP-100	ATSP-200	ATSP-300
DIMENSIONS	2" X 2.2" X 1.57"	2.95" X 2.2" X 1.57"	3.87" X 2.2" X 1.57"
VOLTAGE	9-30 VDC	9-30 VDC	9-30 VDC
AMPS	15 A	15 A	15 A
WEIGHT	2 OUNCES	2.4 OUNCES	5.6 OUNCES
WATERPROOF	IP65 RATED	IP65 RATED	IP65 RATED

SKU	ATSP-400	ATSP-500
DIMENSIONS	4.82" X 2.2" X 1.57"	5.74" X 2.2" X 1.57"
VOLTAGE	9-30 VDC	9-30 VDC
AMPS	30 A	30 A
WEIGHT	6.4 OUNCES	10 OUNCES
WATERPROOF	IP65 RATED	IP65 RATED

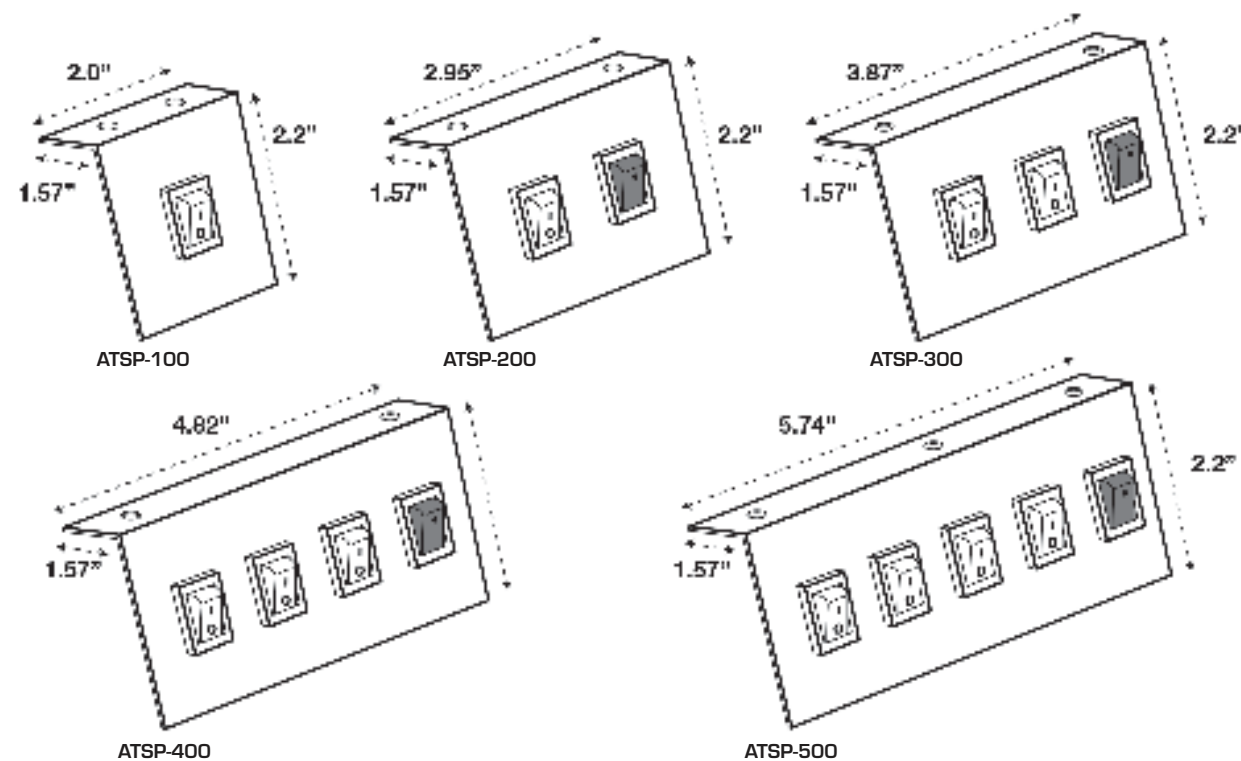
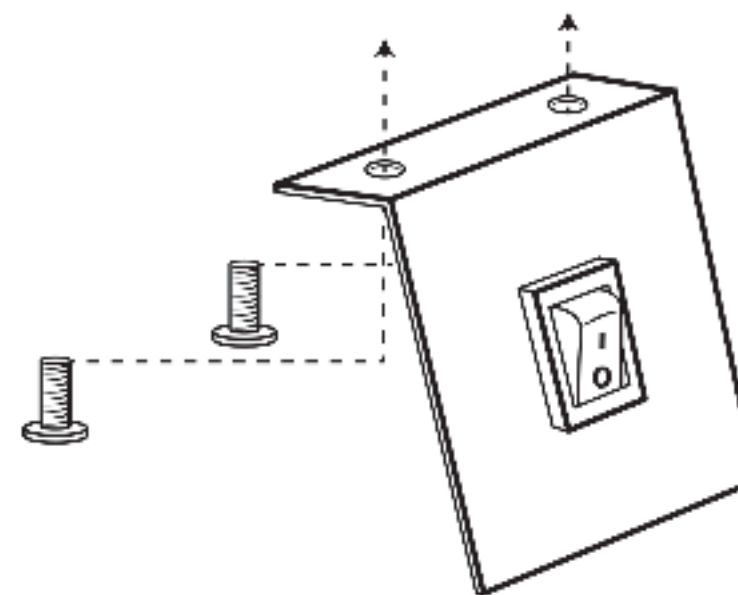

Astro 400 Series Controller



SKU	AS-400
DIMENSIONS	0.93" L X 1.49 W" X 2.97" H
VOLTAGE	10-30 VDC
WATTAGE	1 W
AMPS	0.8 A
WEIGHT	5.6 OUNCES
PROGRAMMABLE MODE	ON-OFF / MOMENTARY
WATERPROOF	IP65 RATED
BACKLIT KEYPAD	YES
CABLE LENGTH	5 FT.

SPECIFICATIONS:



Astro 1100 Series Controller



SKU	AS-1100
DIMENSIONS	3.93" X 2.36" X 0.72" (CONTROLLER) 5.82" X 3.62" X 0.98" (FUSE BOX)
VOLTAGE	10-30 VDC
WATTAGE	18 W
AMPS	41 A
WEIGHT	6.4 OUNCES
WORKING TEMPERATURE	-300C~+700C
WATERPROOF	IP65 RATED

SPECIFICATIONS:

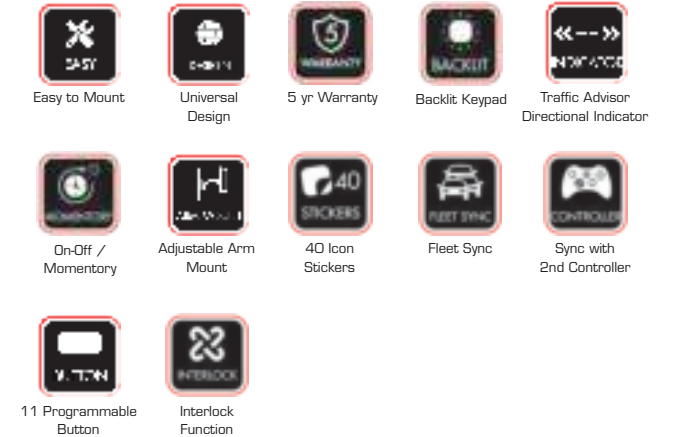

Astro 500 Series Controller with Relays



SKU	AS-500
DIMENSIONS	2.44"W X 2.44"D X 0.98"H
VOLTAGE	10-30 VDC
WATTAGE	1 W
AMPS	4X5A
WEIGHT	5.6 OUNCES
PROGRAMMABLE MODE	ON-OFF / MOMENTARY
WATERPROOF	IP65 RATED
BACKLIT KEYPAD	YES
CABLE LENGTH	1 FT.

SPECIFICATIONS:



Astro 400 Series Controller Drawing

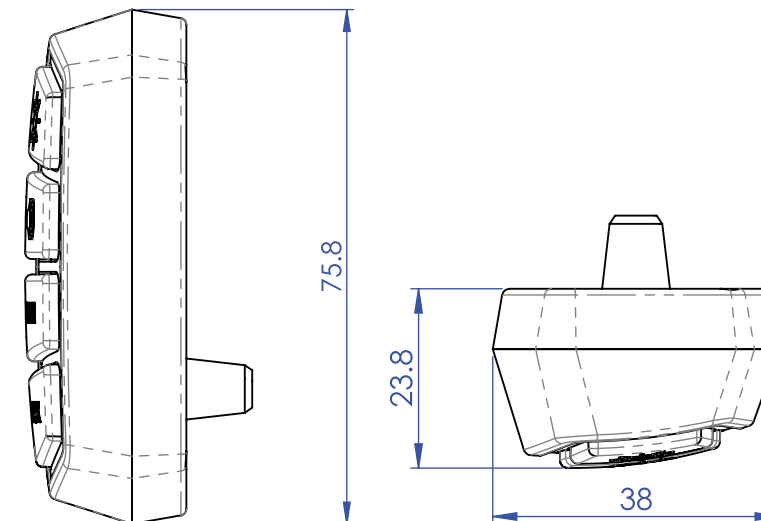



ACCESSORIES

BRACKETS AND GROMETS

Edge & T3 Series Mounting Brackets



SPECIFICATIONS:

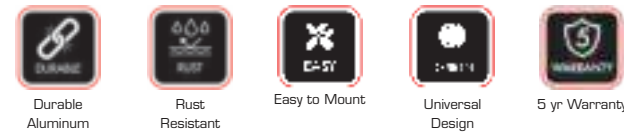

SKU	EDGE/ECLIPSE-L/BRACKET
DIMENSIONS	3.9 X 0.7 X 0.3 INCHES
WEIGHT	2 OUNCES
GROMMET/BRACKET SHAPE	L SHAPE
WATERPROOFING	IP67
MATERIAL	ALUMINIUM

ACCESSORIES

Impact & Blaster Grommet Quick Mount



SPECIFICATIONS:

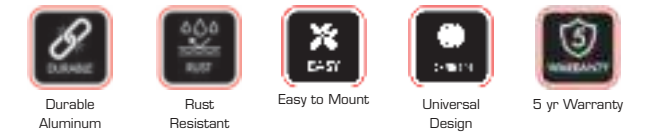

SKU	IMPACT/BLASTER-GROMMET
DIMENSIONS	4 X 3 X 0.2 INCHES
WEIGHT	1 OUNCES
GROMMET/BRACKET SHAPE	ROUND
WATERPROOFING	IP67
MATERIAL	RUBBER

ACCESSORIES

Impact & Blaster Mounting Brackets



SPECIFICATIONS:



SKU	IMPACT/BLASTER-L/BRACKET
DIMENSIONS	3.3 X 3.2 X 1.3 INCHES
WEIGHT	2 OUNCES
GROMMET/BRACKET SHAPE	L SHAPE
WATERPROOFING	IP67
MATERIAL	ALUMINIUM

Dash Housing/Cover for Ultra Series Light



SPECIFICATIONS:

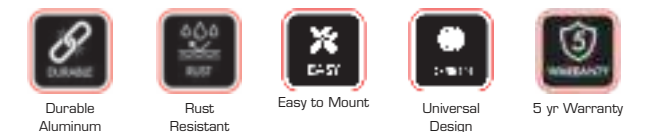

SKU	ULTRA-DHC
DIMENSIONS	4.74" X 0.56" X 1.26"
WEIGHT	0.798 OUNCES
GROMMET/BRACKET SHAPE	C SHAPE
WATERPROOFING	IP67
MATERIAL	ALUMINIUM

L Shape Bracket Flex Mounting Brackets



SPECIFICATIONS:

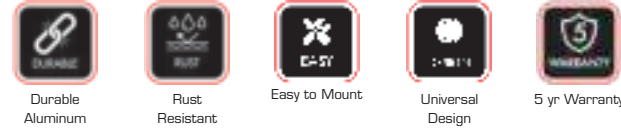

SKU	FLEX-L/BRACKET
DIMENSIONS	3.1 X 1.7 X 0.3 INCHES
WEIGHT	0.798 OUNCES
GROMET/BRACKET SHAPE	L SHAPE
MATERIAL	ALUMINIUM

Flex 180 C Bracket



SPECIFICATIONS:

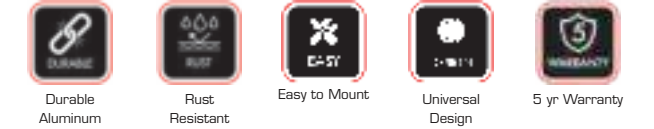

SKU	FLEX 180-C
DIMENSIONS	W1.96 X H1.01 INCHES
WEIGHT	0.3 POUND
WATERPROOF	IP67
GROMET/BRACKET SHAPE	C BRACKET
MATERIAL	ALUMINIUM

C Shape Bracket Flex Mounting Brackets



SPECIFICATIONS:



SKU	FLEX-C/BRACKET
DIMENSIONS	2.6 X 2.5 X 0.6 INCHES
WEIGHT	0.798 OUNCES
GROMET/BRACKET SHAPE	C SHAPE
MATERIAL	ALUMINIUM

Flex 180 L Bracket



SPECIFICATIONS:

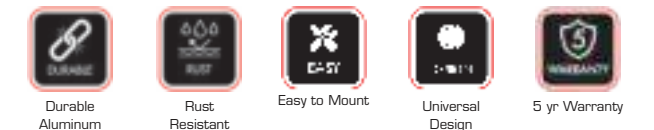

SKU	FLEX 180-L
DIMENSIONS	W1.96 X H1.42 INCHES
WEIGHT	0.3 POUND
WATERPROOF	IP67
GROMET/BRACKET SHAPE	L BRACKET
MATERIAL	ALUMINIUM

Ultra L-Shape Bracket



SPECIFICATIONS:



Durable Aluminum



Rust Resistant



Easy to Mount



Universal Design



5 yr Warranty

SKU	ULTRA-L/BRACKET
DIMENSIONS	W 4.72 X H 1.37 INCHES
WEIGHT	0.3 POUND
WATERPROOF	IP67
GROMET/BRACKET SHAPE	L BRACKET
MATERIAL	ALUMINIUM

Bold 12 L-Shape Bracket



SPECIFICATIONS:



Durable Aluminum



Rust Resistant



Easy to Mount



Universal Design



5 yr Warranty

SKU	BOLD-L/BRACKET
DIMENSIONS	W 5.24 X H 1.8 - INCHES
WEIGHT	0.3 POUND
WATERPROOF	IP67
GROMET/BRACKET SHAPE	L BRACKET
MATERIAL	ALUMINIUM

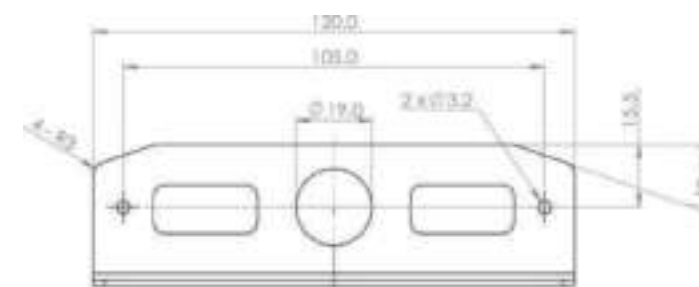

ULTRA-L-BRACKET

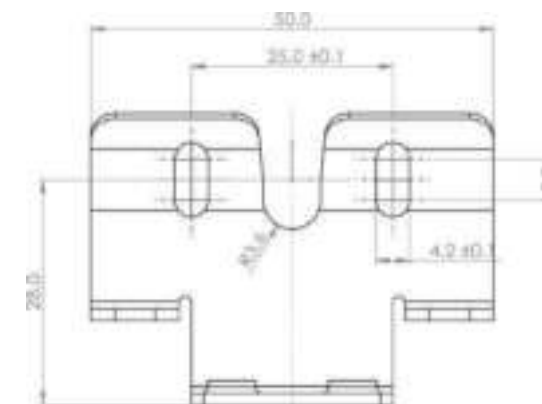

FLEX-180-L

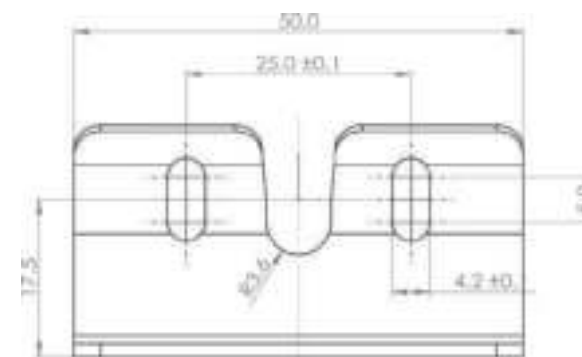

FLEX-180-C

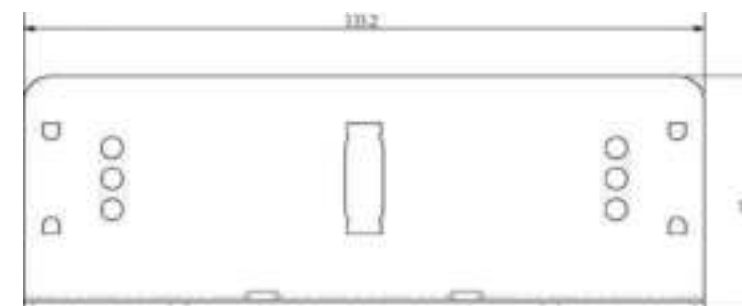

BOLD 12 L-BRACKET

4" Trailer Light L Bracket



SPECIFICATIONS:



SKU	TLLB-4R
DIMENSIONS	6" X 5.875" X 1.375"
WEIGHT	3 OUNCES
WATERPROOF	IP67
GROMET/BRACKET SHAPE	ROUND
MATERIAL	COATED STEEL

TRAILER LIGHT BRACKET

6" Trailer Light L Bracket



SPECIFICATIONS:



SKU	TLLB-6O
DIMENSIONS	8.375" X 4" X 1.875"
WEIGHT	3 OUNCES
WATERPROOF	IP67
GROMET/BRACKET SHAPE	OVAL
MATERIAL	COATED STEEL

TRAILER LIGHT BRACKET

5" Trailer Light L Bracket



SPECIFICATIONS:

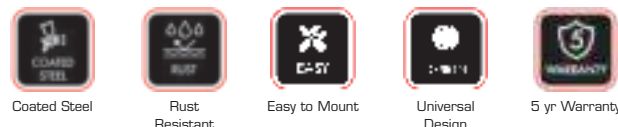

SKU	TLLB-5S
DIMENSIONS	6.875" X 5.81" X 1.31"
WEIGHT	3 OUNCES
WATERPROOF	IP67
GROMET/BRACKET SHAPE	RECTANGULAR
MATERIAL	COATED STEEL

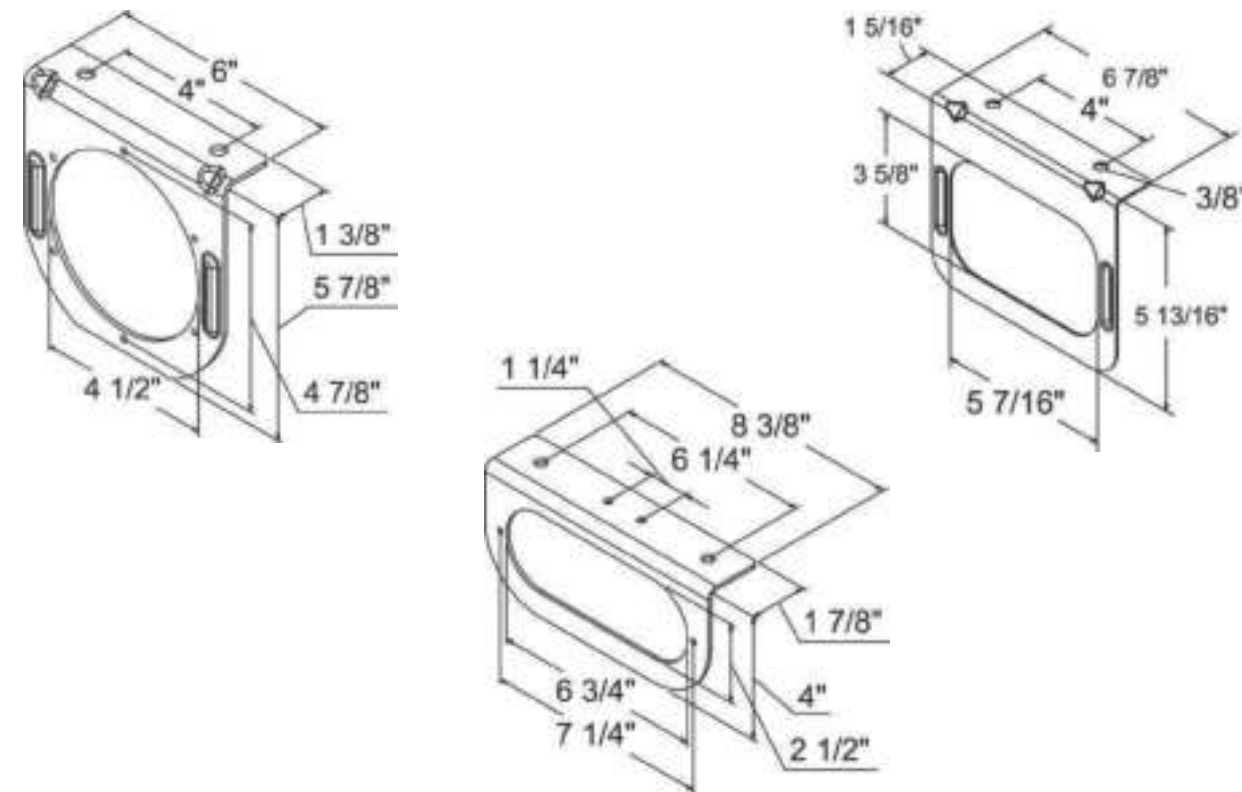

Abrams Quadra Series Single Light Multi-Option Mounting Kit - 3M Tape Mount Included



SKU	QS-S-MMK
DIMENSIONS WITH LIGHT	5.41" X 0.64" X 0.73"
DIMENSIONS WITHOUT LIGHT	5.41" X 0.64" X 0.16"
WEIGHT	2 OUNCES
GROMET/BACKET SHAPE	SURFACE MOUNT
MATERIAL	ABS PLASTIC / FOAM

SPECIFICATIONS:

- SAE Class 1
- 21 Flash Patterns
- 7th Generation LED
- Built in Flasher
- Pattern Memory Recall
- Fit Anywhere
- Heat Sink
- Mounting Flange
- Turn, Brake Tail Light
- Sync. Between Multiple Units
- 5 yr Warranty

Abrams Quadra Series Double Stacked Light Multi-Option Mounting Kit - 3M Tape Mount Included



SKU	QS-D-MMK
DIMENSIONS WITH LIGHT	5.41" X 1.29" X 0.73"
DIMENSIONS WITHOUT LIGHT	5.41" X 1.29" X 0.16"
WEIGHT	4 OUNCES
GROMET/BACKET SHAPE	SURFACE MOUNT
MATERIAL	ABS PLASTIC / FOAM

SPECIFICATIONS:

- SAE Class 1
- 30 Flash Patterns
- 7th Generation LED
- Built in Flasher
- Pattern Memory Recall
- Fit Anywhere
- Heat Sink
- Mounting Flange
- Turn, Brake Tail Light
- Sync. Between Multiple Units
- 5 yr Warranty

Abrams Quadra Series Triple Stacked Light Multi-Option Mounting Kit - 3M Tape Mount Included



SKU	QS-T-MMK
DIMENSIONS WITH LIGHT	5.41" X 1.93" X 0.73"
DIMENSIONS WITHOUT LIGHT	5.41" X 1.93" X 0.16"
WEIGHT	6 OUNCES
GROMET/BACKET SHAPE	SURFACE MOUNT
MATERIAL	ABS PLASTIC / FOAM

SPECIFICATIONS:

- SAE Class 1
- 30 Flash Patterns
- 7th Generation LED
- Built in Flasher
- Pattern Memory Recall
- Fit Anywhere
- Heat Sink
- Mounting Flange
- Turn, Brake Tail Light
- Sync. Between Multiple Units
- 5 yr Warranty

Abrams Quadra Series Quad Stacked Light Multi-Option Mounting Kit - 3M Tape Mount Included



SKU	QS-Q-MMK
DIMENSIONS WITH LIGHT	5.41" X 2.57" X 0.73"
DIMENSIONS WITHOUT LIGHT	5.41" X 2.57" X 0.16"
WEIGHT	8 OUNCES
GROMET/BACKET SHAPE	SURFACE MOUNT
MATERIAL	ABS PLASTIC / FOAM

SPECIFICATIONS:

- SAE Class 1
- 30 Flash Patterns
- 7th Generation LED
- Built in Flasher
- Pattern Memory Recall
- Fit Anywhere
- Heat Sink
- Mounting Flange
- Turn, Brake Tail Light
- Sync. Between Multiple Units
- 5 yr Warranty

Abrams Quadra Series Double Stacked L Bracket



SPECIFICATIONS:



SKU	QS-DS-L
DIMENSIONS WITH LIGHT	5.41" X 1.34" X 1.56"
DIMENSIONS WITH LIGHT	5.41" X 1.34" X 1.00"
WEIGHT	4 OUNCES
WATERPROOF	IP67
GROMET/BRACKET SHAPE	L SHAPED
MATERIAL	ALUMINUM

STACKED L BRACKET

Abrams Quadra Series Quad Stacked L Bracket



SPECIFICATIONS:

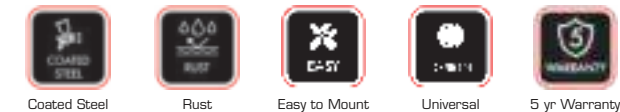

SKU	QS-QS-L
DIMENSIONS WITH LIGHT	5.41" X 2.62" X 1.56"
DIMENSIONS WITH LIGHT	5.41" X 2.62" X 1.00"
WEIGHT	8 OUNCES
WATERPROOF	IP67
GROMET/BRACKET SHAPE	L SHAPED
MATERIAL	ALUMINUM

STACKED L BRACKET

Abrams Quadra Series Triple Stacked L Bracket



SPECIFICATIONS:



SKU	QS-TS-L
DIMENSIONS WITH LIGHT	5.41" X 1.98" X 1.56"
DIMENSIONS WITH LIGHT	5.41" X 1.98" X 1.00"
WEIGHT	6 OUNCES
WATERPROOF	IP67
GROMET/BRACKET SHAPE	L SHAPED
MATERIAL	ALUMINUM

Abrams Quadra Series Single Side-by-Side L Bracket



SPECIFICATIONS:



SKU	QS-S-SS-L
DIMENSIONS WITH LIGHT	10.89" X 0.70" X 1.56"
DIMENSIONS WITH LIGHT	10.89" X 0.70" X 1.00"
WEIGHT	4 OUNCES
WATERPROOF	IP67
GROMET/BRACKET SHAPE	L SHAPED
MATERIAL	ALUMINUM

Abrams Quadra Series Double Stacked Side-by-Side L Bracket



SPECIFICATIONS:



SKU	QS-DS-SS-L
DIMENSIONS WITH LIGHT	10.89" X 1.34" X 1.56"
DIMENSIONS WITHOUT LIGHT	10.89" X 1.34" X 1.00"
WEIGHT	8 OUNCES
WATERPROOF	IP67
GROMET/BRACKET SHAPE	L SHAPED
MATERIAL	ALUMINUM

STACKED L BRACKET

Abrams Quadra Series Quad Side-by-Side L Bracket



SPECIFICATIONS:

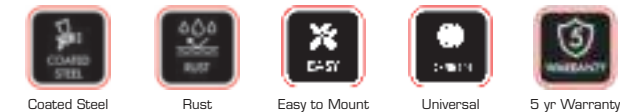

SKU	QS-Q-SS-L
DIMENSIONS WITH LIGHT	10.89" X 2.62" X 1.56"
DIMENSIONS WITHOUT LIGHT	10.89" X 2.62" X 1.00"
WEIGHT	8 OUNCES
WATERPROOF	IP67
GROMET/BRACKET SHAPE	L SHAPED
MATERIAL	ALUMINUM

STACKED L BRACKET

Abrams Quadra Series Triple Side-by-Side L Bracket



SPECIFICATIONS:



SKU	QS-T-SS-L
DIMENSIONS WITH LIGHT	10.89" X 1.98" X 1.56"
DIMENSIONS WITHOUT LIGHT	10.89" X 1.98" X 1.00"
WEIGHT	6 OUNCES
WATERPROOF	IP67
GROMET/BRACKET SHAPE	L SHAPED
MATERIAL	ALUMINUM

Abrams Quadra, Flex & Focus Series Visor Headliner Quick Mount Bracket



SPECIFICATIONS:

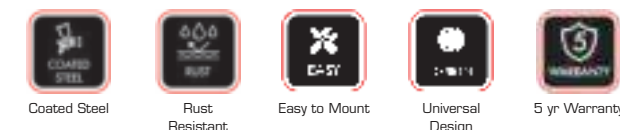

SKU	QFS-VQM
DIMENSIONS	12" X 4.9" X 2.00"
WEIGHT	14 OUNCES
WATERPROOF	IP67
GROMET/BRACKET SHAPE	L SHAPED
MATERIAL	ALUMINUM

Abrams 1X Single Quadra Series Window Shroud Kit



SPECIFICATIONS:



SKU	QS-DS-L
DIMENSIONS WITH LIGHT	5.41" X 1.34" X 1.56"
DIMENSIONS WITHOUT LIGHT	5.41" X 1.34" X 1.00"
WEIGHT	6 OUNCES
WATERPROOF	IP65
GROMET/BRACKET SHAPE	WINDOW SHROUD
MATERIAL	ABS PLASTIC

WINDOW SHROUD KIT

Abrams 2X Single Quadra Series Window Shroud Kit



SPECIFICATIONS:



SKU	QS-QS-L
DIMENSIONS WITH LIGHT	5.41" X 2.62" X 1.56"
DIMENSIONS WITHOUT LIGHT	5.41" X 2.62" X 1.00"
WEIGHT	10 OUNCES
WATERPROOF	IP65
GROMET/BRACKET SHAPE	WINDOW SHROUD
MATERIAL	ABS PLASTIC

WINDOW SHROUD KIT

Abrams 1X-D Single Double Quadra & Flex Series Window Shroud Kit



SPECIFICATIONS:

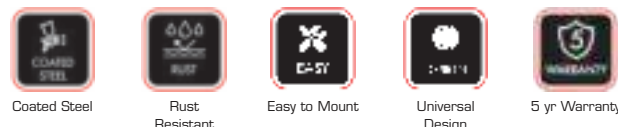

SKU	QS-TS-L
DIMENSIONS WITH LIGHT	5.41" X 1.98" X 1.56"
DIMENSIONS WITHOUT LIGHT	5.41" X 1.98" X 1.00"
WEIGHT	10 OUNCES
WATERPROOF	IP65
GROMET/BRACKET SHAPE	WINDOW SHROUD
MATERIAL	ABS PLASTIC

Abrams 2X-D Single Double Quadra & Flex Series Window Shroud Kit



SPECIFICATIONS:

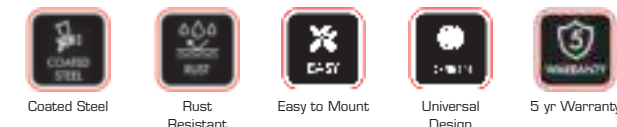

SKU	QS-S-SS-L
DIMENSIONS WITH LIGHT	10.89" X 0.70" X 1.56"
DIMENSIONS WITHOUT LIGHT	10.89" X 0.70" X 1.00"
WEIGHT	14 OUNCES
WATERPROOF	IP65
GROMET/BRACKET SHAPE	WINDOW SHROUD
MATERIAL	ABS PLASTIC





**TRAILER LIGHT
GROMMETS
BRACKETS & CONNECTORS**

Abrams ConnectCo Series System - Extention Cables

CONNECTCO SYSTEM SERIES



SPECIFICATIONS:

 Easy to Install	 Universal Design	 IP66 Weatherproof	 Plug & Play	 5 yr Warranty
---	---	---	---	---



CONNECTOR TYPE	EXTENSION CABLE
WIRE LENGTH	3 FT , 6 FT, 12 FT
WIRE COLORS	YELLOW, GREEN & BLUE
PINS	3P-M - 4P-F

Abrams ConnectCo Series System - Pigtail Connectors

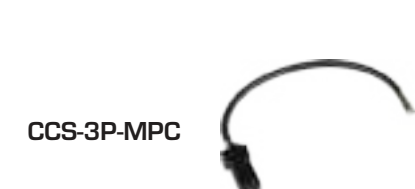
CONNECTCO SYSTEM SERIES



SPECIFICATIONS:

 Easy to Install	 Universal Design	 IP66 Weatherproof	 Plug & Play	 5 yr Warranty
---	--	---	---	---

CONNECTOR TYPE	PIGTAIL CONNECTOR
WIRE LENGTH	6"
WIRE COLORS	BLACK, RED & WHITE
PINS	3P-M - 4P-F

Abrams ConnectCo Series System - Splitter Connectors

CONNECTCO SYSTEM SERIES

CCS-3F-3MM-S



CCS-4F-4MM-S



CCS-3F-3MMM-S



CCS-4F-4MMM-S







CCS-3F-3MMMM-S



CCS-4F-4MMMM-S



SPECIFICATIONS:

- 
Easy to Install
- 
Universal Design
- 
IP66 Weatherproof
- 
Plug & Play
- 
5 yr Warranty

CONNECTOR TYPE	SPLITTER
WIRE LENGTH	2" - 4" TOTAL
WIRE COLORS	GREEN, YELLOW & BLUE
PINS	3P-F - 3P-M - 3P-M

Abrams ConnectCo Series System - Splitter Connectors

CONNECTCO SYSTEM SERIES

CCS-6F-6MMM-S



CCS-8F-8MMM-S







CCS-6F-6MMMM-S



CCS-8F-8MMMM-S



SPECIFICATIONS:

- 
Easy to Install
- 
Universal Design
- 
IP66 Weatherproof
- 
Plug & Play
- 
5 yr Warranty

CONNECTOR TYPE	SPLITTER
WIRE LENGTH	2" - 4" TOTAL
WIRE COLORS	GREEN, YELLOW & BLUE
PINS	3P-F - 3P-M - 3P-M

Flex 3 FMG Grommet



SPECIFICATIONS:



SKU	FLEX-3-FMG
DIMENSIONS	3.97"W X 1.49"H X 0.70"D
WEIGHT	0.3 POUND
WATERPROOF	IP67 RATED
GROMMET/BRACKET SHAPE	OVAL
MATERIAL	RUBBER

TRAILER LIGHT GROMMETS

Flex 12 FMG Grommet



SPECIFICATIONS:



SKU	FLEX-12-FMG
DIMENSIONS	5.94"W X 1.49"H X 0.70"D
WEIGHT	0.5 POUND
WATERPROOF	IP67 RATED
GROMMET/BRACKET SHAPE	OVAL
MATERIAL	RUBBER

TRAILER LIGHT GROMMETS

Flex 6 FMG Grommet



SPECIFICATIONS:



SKU	FLEX-6-FMG
DIMENSIONS	4.68"W X 1.49"H X 0.70"D
WEIGHT	0.4 POUND
WATERPROOF	IP67 RATED
GROMMET/BRACKET SHAPE	OVAL
MATERIAL	RUBBER

2" Rubber Grommet



SPECIFICATIONS:

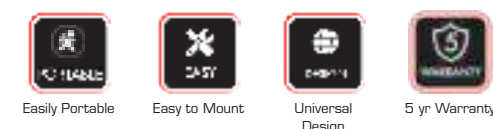

SKU	TLG-20R
DIMENSIONS	2.87" X 2" X 0.81"
WEIGHT	2 OUNCES
WATERPROOF	IP67
GROMMET/BRACKET SHAPE	ROUND
MATERIAL	RUBBER

2.5" Rubber Grommet



SPECIFICATIONS:



SKU	TLG-25R
DIMENSIONS	3.31" X 2.5" X 1.05"
WEIGHT	3 OUNCES
WATERPROOF	IP67
GROMET/BRACKET SHAPE	ROUND
MATERIAL	RUBBER

TRAILER LIGHT GROMMETS

5"x3" Rubber Grommet



SPECIFICATIONS:



SKU	TLG-50S
DIMENSIONS	4.71" X 6.37" X 1.68"
WEIGHT	8 OUNCES
WATERPROOF	IP67 RATED
GROMET/BRACKET SHAPE	RECTANGULAR
MATERIAL	RUBBER

TRAILER LIGHT GROMMETS

4" Rubber Grommet



SPECIFICATIONS:



SKU	TLG-40R
DIMENSIONS	5.5" X 4.12" X 1"
WEIGHT	5 OUNCES
WATERPROOF	IP67
GROMET/BRACKET SHAPE	ROUND
MATERIAL	RUBBER

6" Rubber Grommet



SPECIFICATIONS:



SKU	TLG-600
DIMENSIONS	3.12" X 7.62" X 1"
WEIGHT	6 OUNCES
WATERPROOF	IP67 RATED
GROMET/BRACKET SHAPE	OVAL
MATERIAL	RUBBER

Trailer Light Connectors

TRAILER LIGHT CONNECTORS

TRAILER LIGHT CONNECTORS



CLC-2P-RA



CLC-2P-SA



TLC-2P-RA

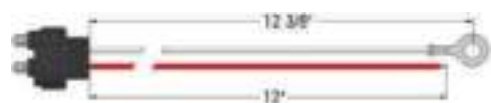

TLC-2P-SA

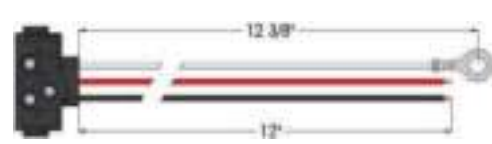

CLC-2P-RA

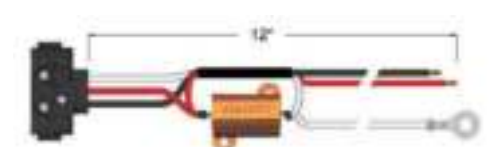

CLC-2P-SA

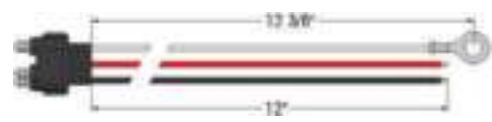



TLC-2P-RA



TLC-2P-SA

SPECIFICATIONS:

- 
Easy to Install
- 
Universal Design
- 
IP66 Weatherproof
- 
Plug & Play
- 
5 yr Warranty

ITEM WEIGHT	4 OUNCES
BULB TYPE	LED
AMPERAGE	10 A
VOLTAGE	9-30 VDC
WATERPROOF	IP66 RATED
AVAILABLE PACK	1, 2 & 10

COMPATIBLE MODELS:

CLC-2P-RA / CLC-2P-SA	TML-R200, TML-R250 CLEARANCE LIGHTS
TLC-2P-RA / TLC-2P-SA	TTL-R10-W / TTL-R24-W / TTL-O10-W / TTL-O24-W / TTL-S10-W / TTL-S24-W
TLC-3P-RA / TLC-3P-RA-WR / TLC-3P-SA	TTL-R10-A & R / TTL-R24-A & R / TTL-O10-A & R / TTL-O24-A & R / TTL-S10-A & R / TTL-S24-A & R
TRLC-4P-SA	FIESTA-R12 / FIESTA-O13 / AS WELL AS SIMILAR STT LIGHTS FROM OTHER MANUFACTURERS