



JMPTM
JMPWOOD.COM
KING OF STAIR PARTS



Contents

Introduction

About JMP	4
How to Order	6

Stair Parts

Stairpart Identifier	8
Wood & Finishes	10

Newel Posts

Box Newels	12
Turned Posts	20
Finials & Caps	34

Balusters

1 1/4" & 1 3/4" Wide	36
Primed	40

Metal Balusters

1/2" Round	42
1/2" Round Shoes	43
1/2" Square	44
1/2" Square Shoes	55
9/16" Round	56
5/8" Round	57
5/8" Round Shoes	59
5/8" Square	60
5/8" Square Shoes	61
1 3/16" Iron Newels	62

Lineals

Handrails	64
Bending Rails	66
Handrail Fittings	68
S4S Lumber	72
Shoe Rails & Fillets	74
Landing Treads & Mouldings	76

Treads & Risers

Treads & Risers	78
False Treads & Risers	80

Tools & Accessories

Handrail Brackets	82
Rosettes & Tread Brackets	83
Hardware	84

Additional Information

Frequently Asked Questions	86
Terms & Conditions	88



WE TAKE PRIDE IN OUR QUALITY

At JMP Wood, we believe your stair is furniture you walk on. With our quality, experienced craftsmanship paired with our expert service, we guarantee you will be impressed.

About Us



Giuseppe and Michael Cangelosi

Giuseppe "Zep" Cangelosi
Rosalia Cangelosi

JMP is a family-owned business founded by Giuseppe Cangelosi, initially providing handmade unique display fixtures to all kinds of boutiques and department stores. Beginning as "JMP Display Fixtures" Giuseppe (Joe) Cangelosi along with brothers Mario & Peter set up shop in Brooklyn, New York circa 1974 to show the world their talent at creating unique wood display fixtures. Since the family trade was passed down to Joe's son, Michael, JMP Display Fixtures expanded to JMP Wood Stairs & Rails and JMP Woodturning. Combining timeless knowledge of wood management along with new age designs and technology, JMP is an unstoppable leader in the millwork/stair part industry.

When priceless craftsmanship meets new age technology, the competition just doesn't compare. Through specialization in the manufacturing of newel posts, balusters, columns, table legs, tangent rails and much more, JMP has branded themselves as a staple in the woodworking industry. JMP's evolution into a fully blossoming corporation consisting of a full staff of the finest artisans, tools and machines is proof that the manufacturing industry is still going strong, and you can't put a price on American made goods. We take pride in our work and assure you that JMP is the best choice for quality and craftsmanship and we take every order one step at time!

How to Order?

All items can be purchased through our online portal at www.jmpwood.com.

If you have trouble placing an order online, or require assistance, please email our customer support team at orders@jmpwood.com or give us a call at **908.777.1JMP (567)**



Bulk Pricing

For bulk orders and pricing, please **contact us**. Pricing may vary depending on shipping and product availability.

Payment Methods

We accept all forms of payment including all major credit cards (Visa, MasterCard, Discover and American Express), checks, cash and money order.

Locations

JMP West:
1600 East Edgar Road
Linden, NJ 07036
908.777.1567



JMP East:
760 East 96th Street
Brooklyn, NY 11236
718.303.7777

SCAN ME.

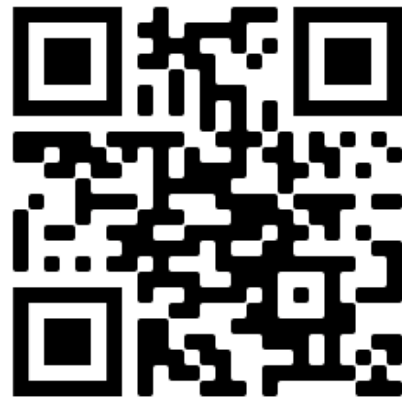

To be directed to our website



Stairpart Identifier



Left Open Box Stair

1. **Starting Step** The first step of a stair system. It tends to be ornate and is typically wider than any of the other steps.
2. **Riser** The vertical plane of a stair that faces each step between stringers and tread.
3. **Tread** This is the portion of the step on which you place your feet.
4. **Baluster** A vertical piece, plain or decorative, that is used between railing and tread or floor.
5. **Newel** Also called a central pole, it is the major supporting pillar of a balustrade system, typically located at the bottom and top of a stairway, or at a turn in a handrail.
6. **Volute** A fancy spiral formation found at the bottom end of the handrails.
7. **Turnout** An ornamental item that usually flares left or right and attaches to the beginning of the rail.
8. **2 Rise Gooseneck** A rail fitting that permits a change in direction, used where rake rail rises vertically to a balcony or landing.
9. **Stringer** The structural component that supports the treads and risers. There are two stringers on a staircase typically, one on either side of the stairs. (Boxed or Open)
10. **Facia** The decorative board that fastens along the wall on the open side of the staircase.
11. **Handrail** The hand support in a stair system.
12. **Rail Fittings** Fittings are assembled parts that match particular hand rail patterns. They allow for directional and vertical changes with the hand rail in over-the-post balustrades.



Double Open Rise Stair

13. **Freestanding Stair** A stairway that is not supported by walls.
14. **Landing** A large horizontal platform between the flights of stairs. Landings allow for directional changes in stairs.
15. **Box Newel Post** Also called a central pole, it is the major supporting pillar of a balustrade system, typically located at the bottom and top of a stairway, or at a turn in a handrail.
16. **Rake Rail** Hand rail used on the ascending section of a balustrade. It follows the pitch of the stair.
17. **Half Newel** A newel post that is typically cut vertically and mounted against the wall, used mainly for aesthetic purposes.
18. **Level Rail** Handrail used on the landing portion of a balustrade.
19. **Landing Tread** A part used at the top of a staircase or beginning of a balcony that allows for transition into the landing.
20. **Total Rise** Refers to the total height your stair needs to be. Synonymous with "Finish to Finish" rise as it refers to the measurement from the top of the finished first floor to the top of the finished second floor.
21. **Total Run** The measurement of how far your stair extends from the wall. Key measurement if your stair is going between walls.

Wood Types

POPLAR | *Populus*



Fine textured, soft and lightweight. Easily worked and takes paint exceptionally well. Frequently finished to look like other woods. **Recommended for painting.**



RED OAK | *Quercus Rubra*



Straight grain with coarse texture. Large open pores produce distinctive grain. Generally works and finishes well.



WHITE OAK | *Quercus Alba*



Finer texture than Red Oak. Heartwood is decay resistant and suitable for exterior use. Good turning and steam bending qualities. **Great for staining.**



MAPLE | *Acer*



Fine, even texture and natural luster. Known for its durability and strength. It has excellent turning properties. Paints and finishes well.



SAPELE | *Entandrophragma cylindricum*



Texture rather fine; grain interlocked; sometimes wavy. Lustrous. Turns fairly well. Excellent substitute for genuine Mahogany. **Great for outdoor applications.**



CHERRY | *Prunus Avium*



Finely textured, strong, and easy to work. Highly rated in all working properties including wood bending and turning. Becomes darker and richer with age.

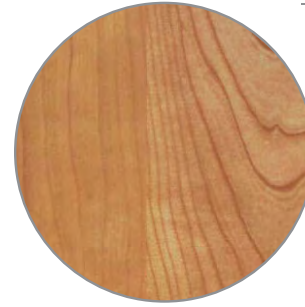

ANY SPECIES

If you see an item that is not in the species you are looking for, please give us a call at 718.303.7777 to receive a quote!

JMP is fully capable to manufacture any part in any species.

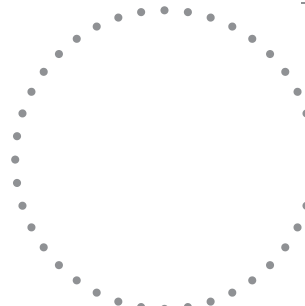

Metal Patinas

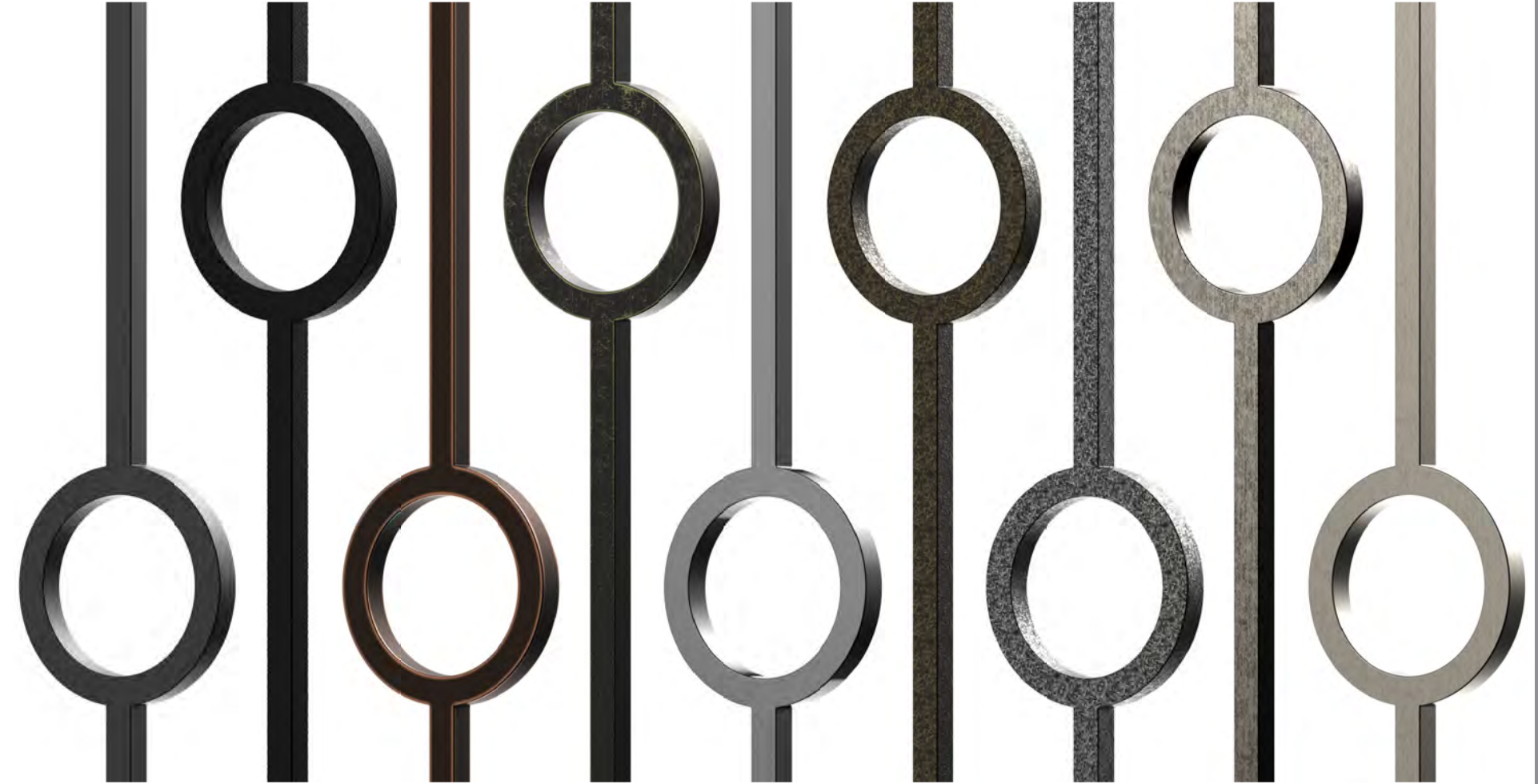

SB
Satin Black

WB
Wrinkle Black

ORC
Oil Rubbed Copper

ORB
Oil Rubbed Bronze

AG
Ash Grey

CV
Copper Vein

SV
Silver Vein

AN
Antique Nickel

NIC
Nickel

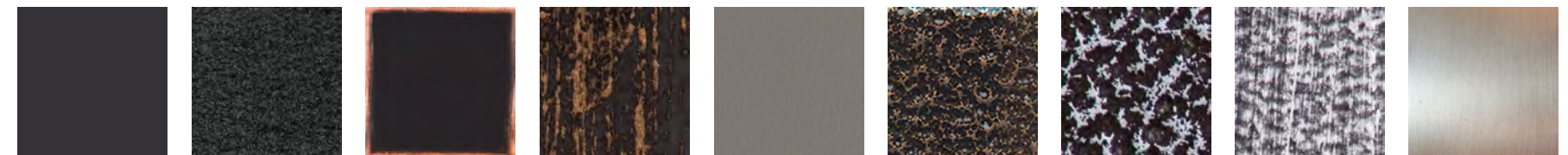

Box Newels | Construction and Styles

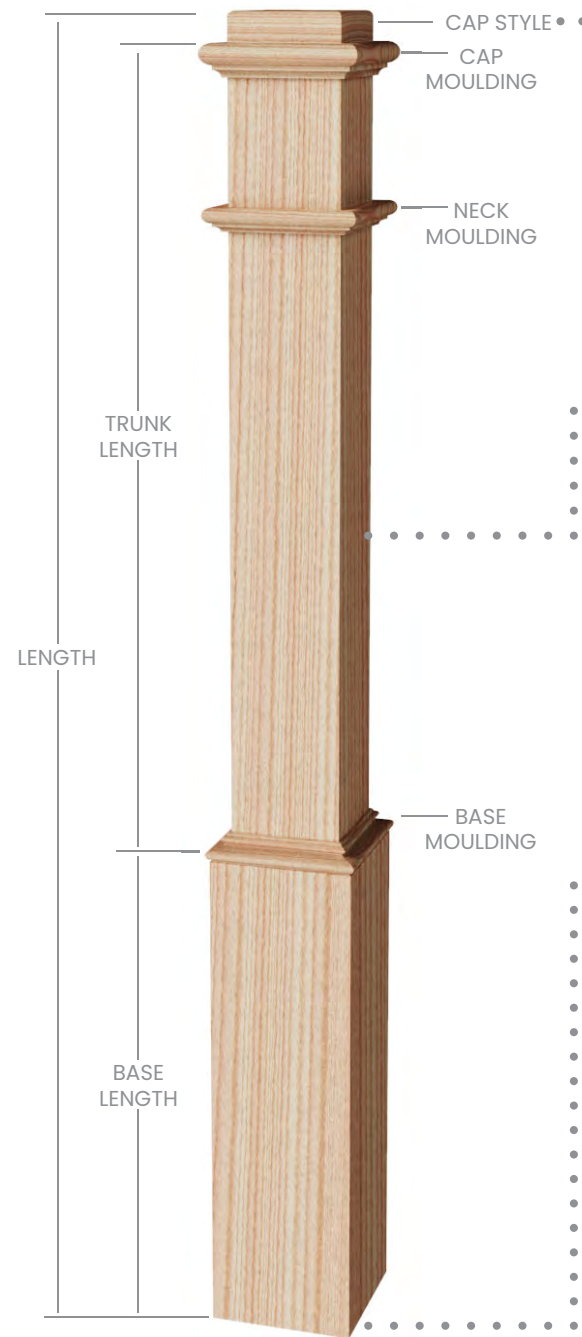

Cap Options

For preconstructed cap styles and options, see **page 35**

Flat



Peak



Ornate Flat



Panel Options

Plain



Flat Panel



Raised Panel



Fluted



Mounting Block



5003 | 2 15/16" Mounting Block & Hardware

For post mounting options, see **page 81**

Box Newels | Appalachian Series

3 1/2" - 4 1/2"

6" - 8"

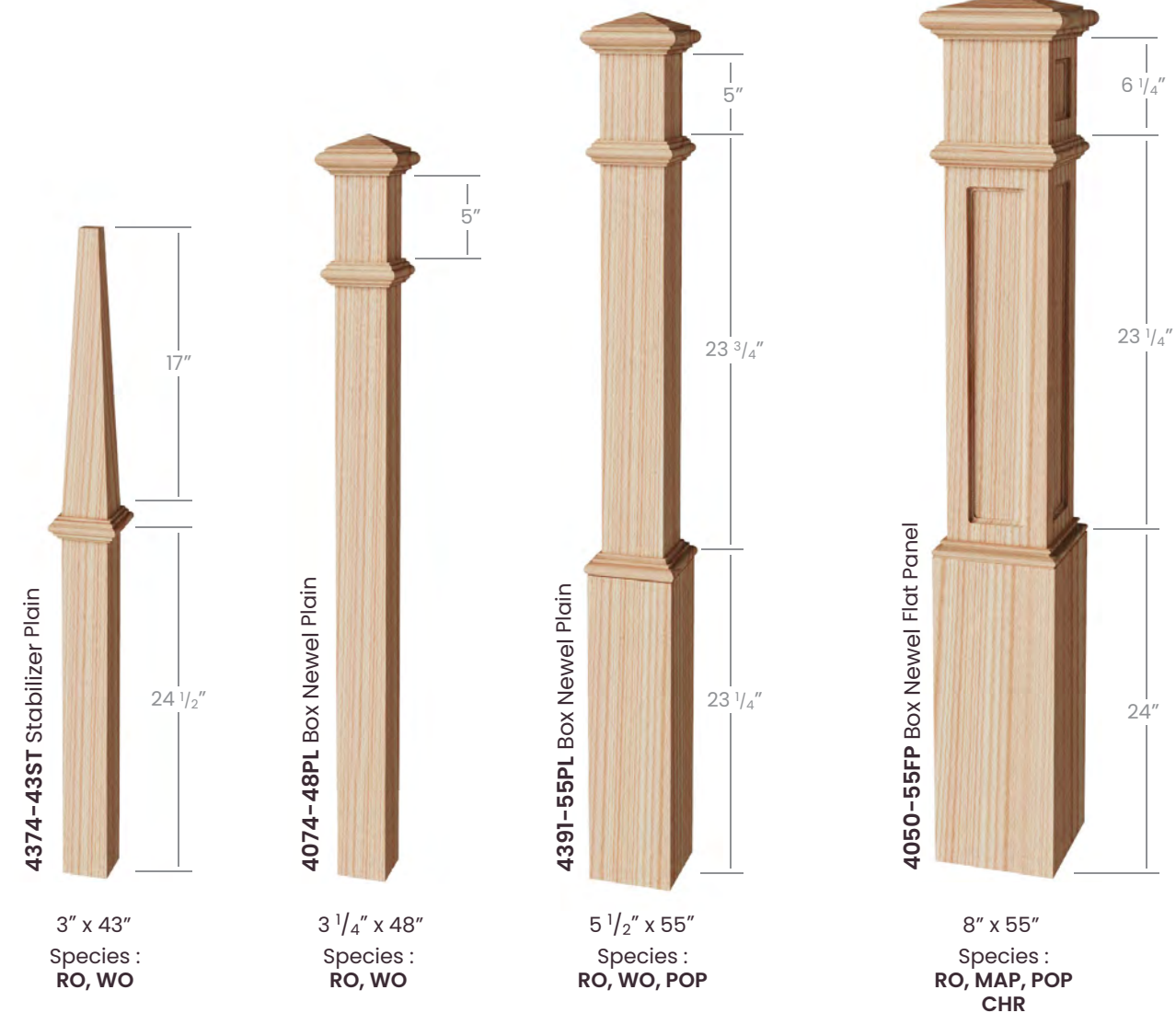

Box Newels | Lincoln Series

3 1/2" - 4 1/2"

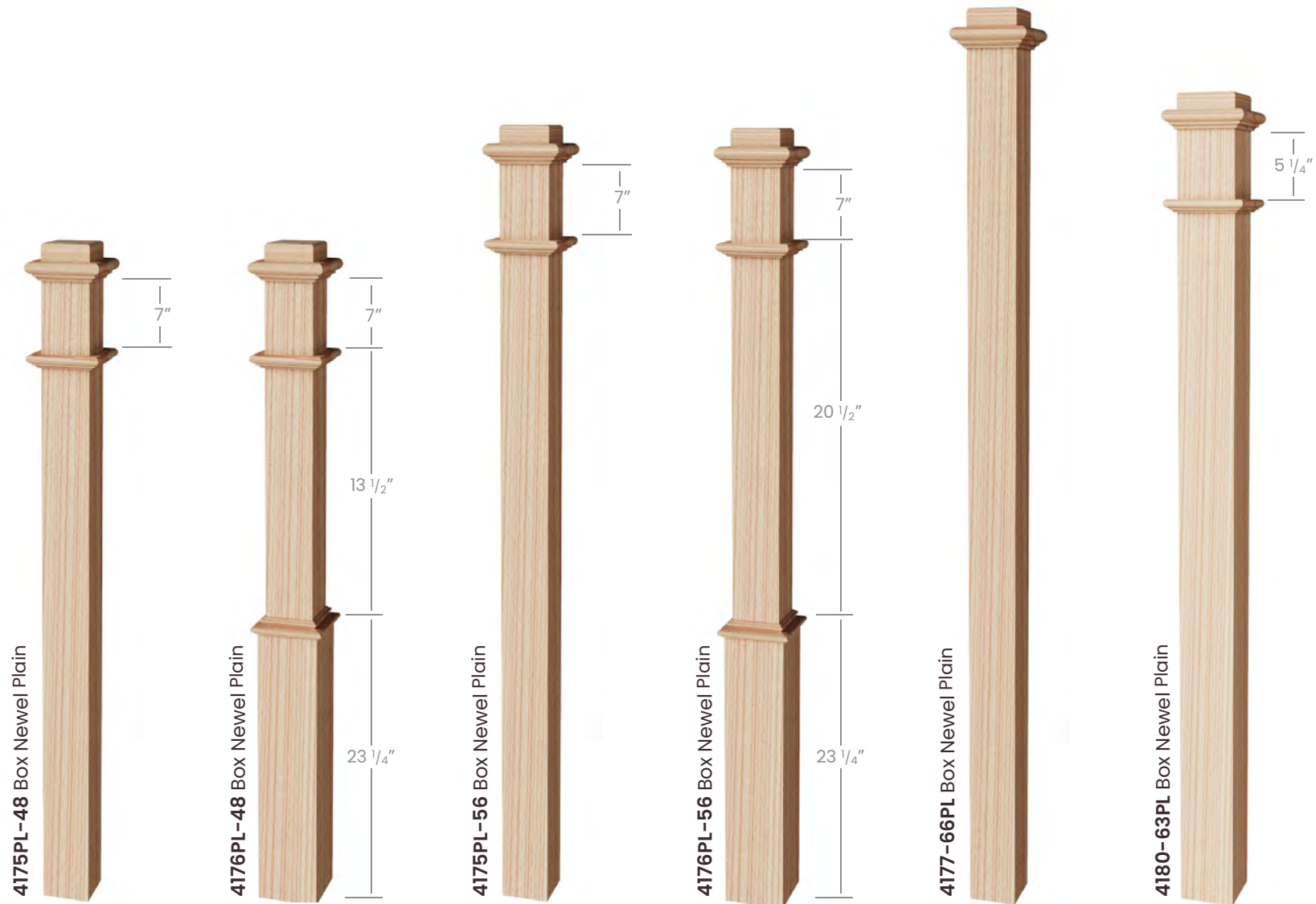

4175PL-48 Box Newel Plain

3 1/2" x 48"
Species :
RO, WO, POP

4176PL-48 Box Newel Plain

5" x 48"
Species :
RO, WO, POP

4175PL-56 Box Newel Plain

3 1/2" x 56"
Species :
RO, WO, POP

4176PL-56 Box Newel Plain

5" x 56"
Species :
RO, WO, POP

4177-66PL Box Newel Plain

3 1/2" x 66"
Species :
RO, WO, POP

4180-63PL Box Newel Plain

4 1/2" x 63"
Species :
RO, WO, POP

6" - 8"

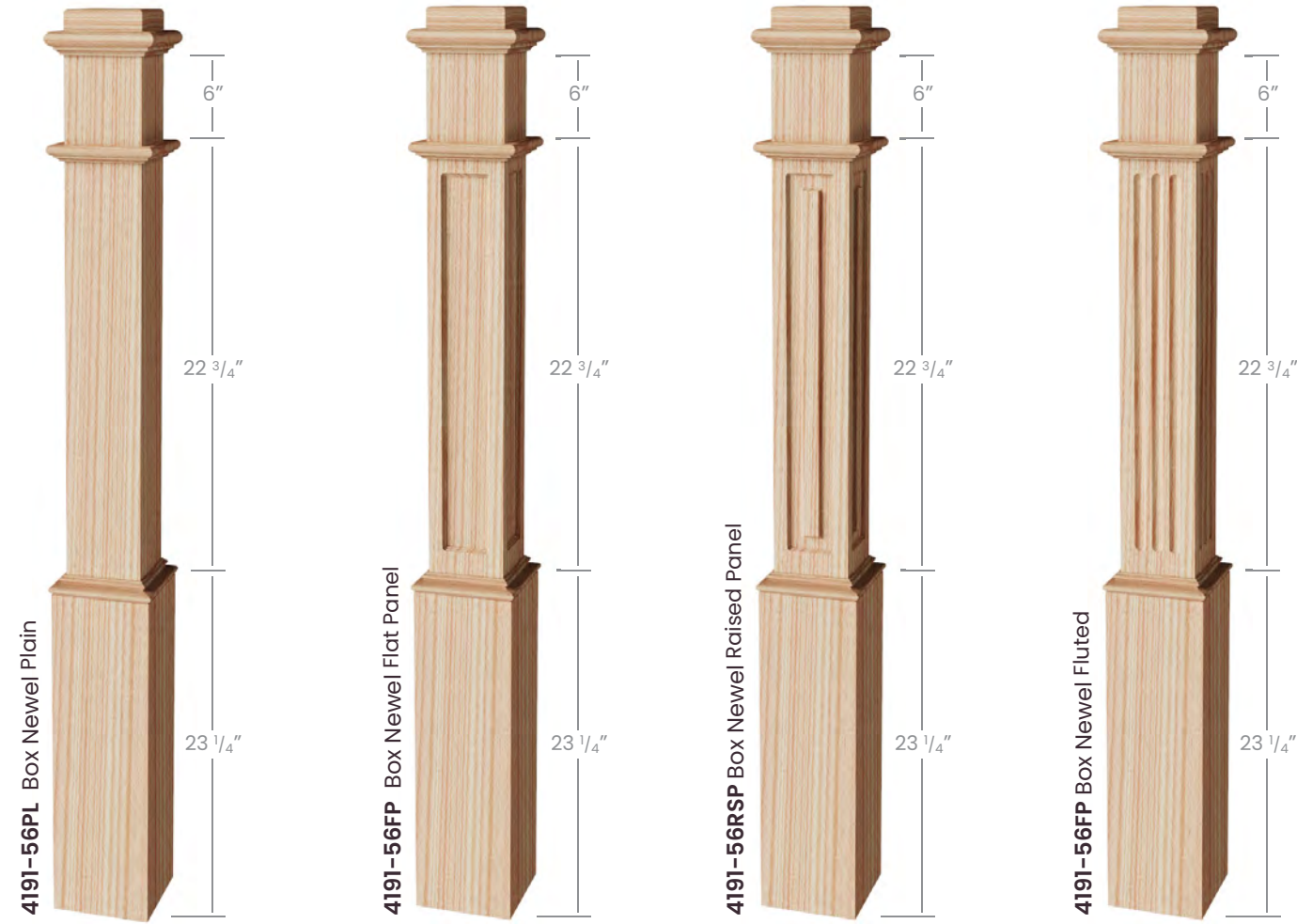

4191-56PL Box Newel Plain

6 1/4" x 56"
Species :
RO, WO, MAP,
POP, CHR

4191-56FP Box Newel Flat Panel

6 1/4" x 56"
Species :
RO, WO, MAP,
POP, CHR

4191-56RSP Box Newel Raised Panel

6 1/4" x 56"
Species :
RO, MAP, POP,
CHR

4191-56FP Box Newel Fluted

6 1/4" x 56"
Species :
RO, MAP, POP,
CHR

Box Newels | Liberty Series

3 1/2" - 4 1/2"

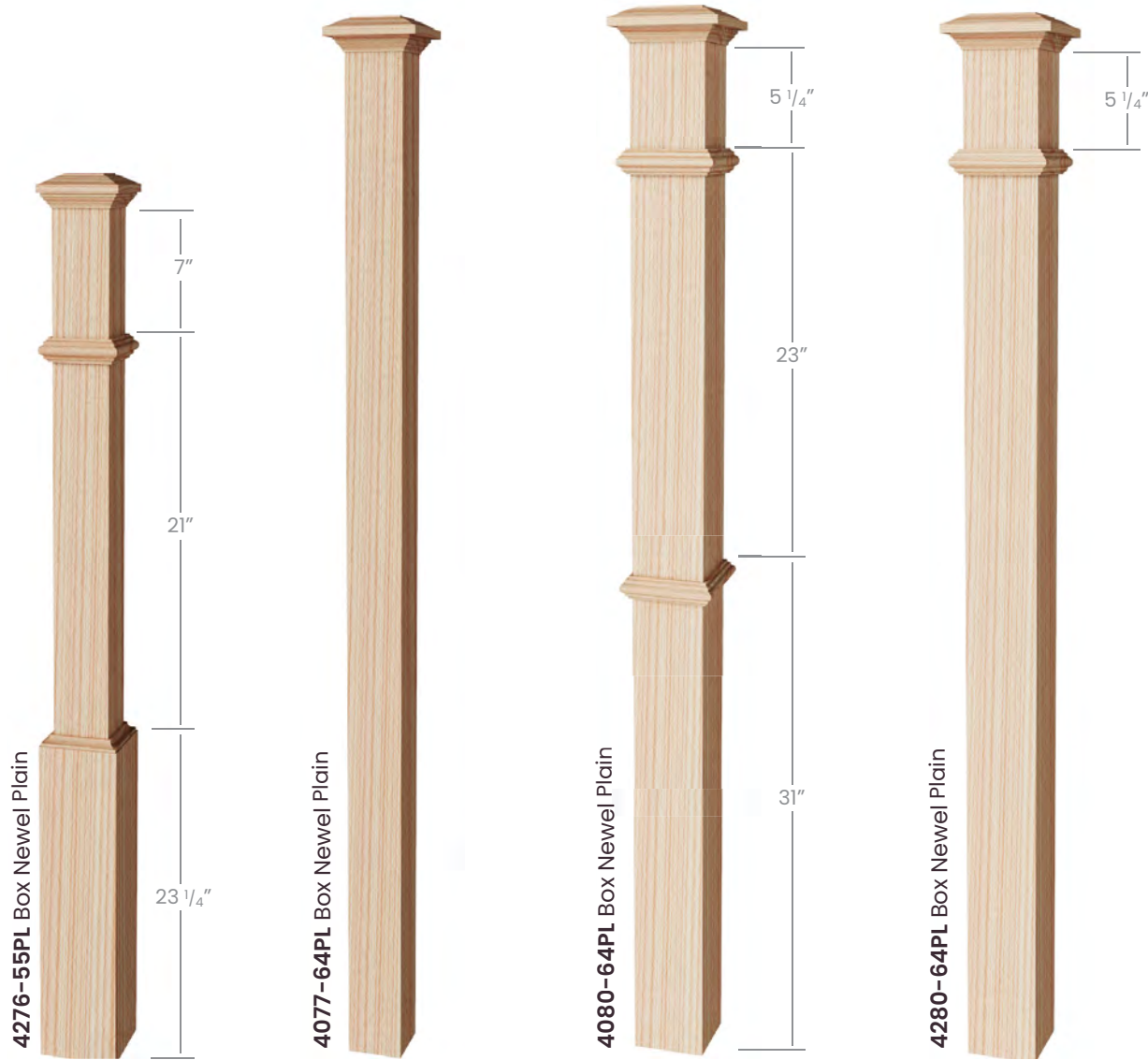

4276-55PL Box Newel Plain
5" x 55"
Species : RO, WO, POP

4077-64PL Box Newel Plain
3 1/2" x 64"
Species : RO, POP

4080-64PL Box Newel Plain
4 1/2" x 64"
Species : RO, WO, POP

4280-64PL Box Newel Plain
4 1/2" x 64"
Species : RO, WO, POP

| Flat Panel



| Raised Panel



6" - 8"

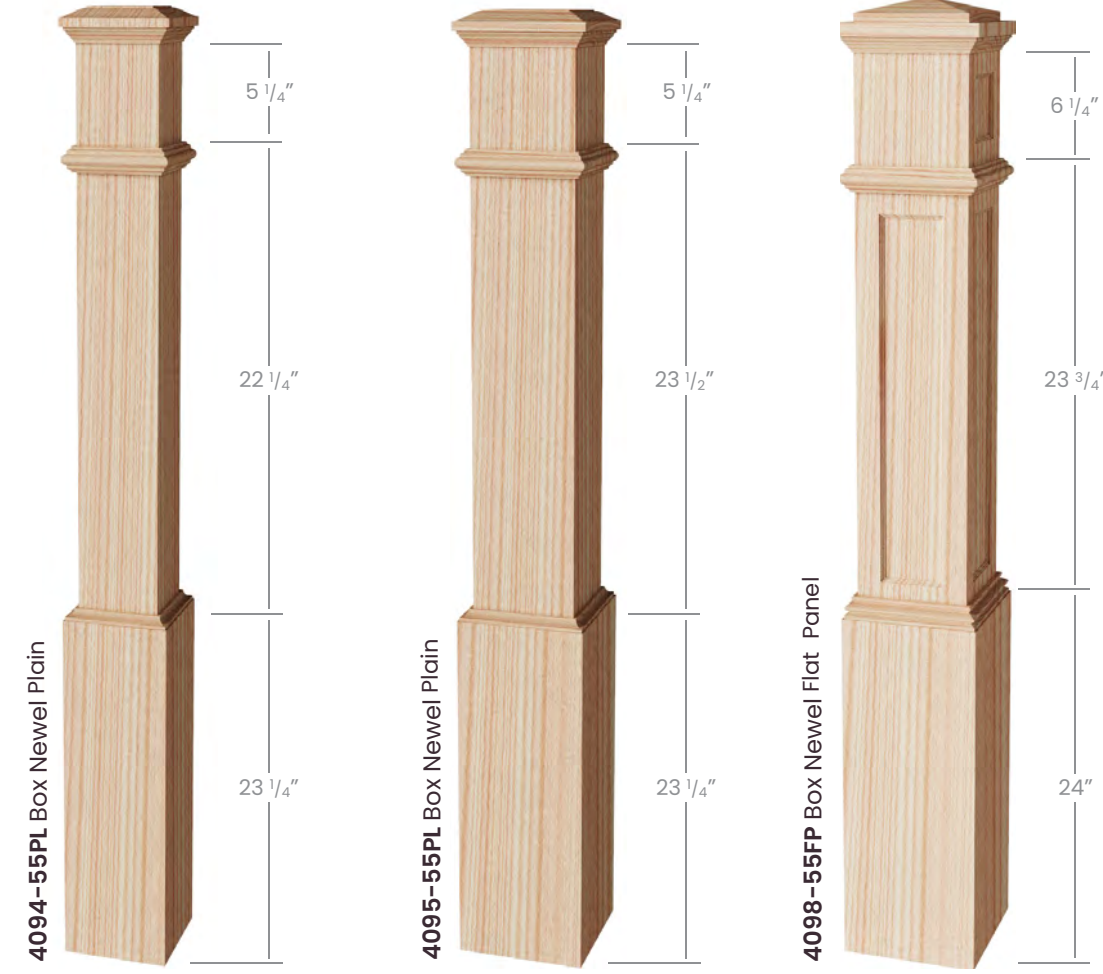

4094-55PL Box Newel Plain
6 1/4" x 55"
Species : RO, POP

4095-55PL Box Newel Plain
7 1/2" x 55"
Species : RO, WO, POP

4098-55FP Box Newel Flat Panel

8" x 55"
Species : RO, WO, POP

| Flat Panel



| Raised Panel



Box Newels | Rialto Series

3 1/2" - 4 1/2"

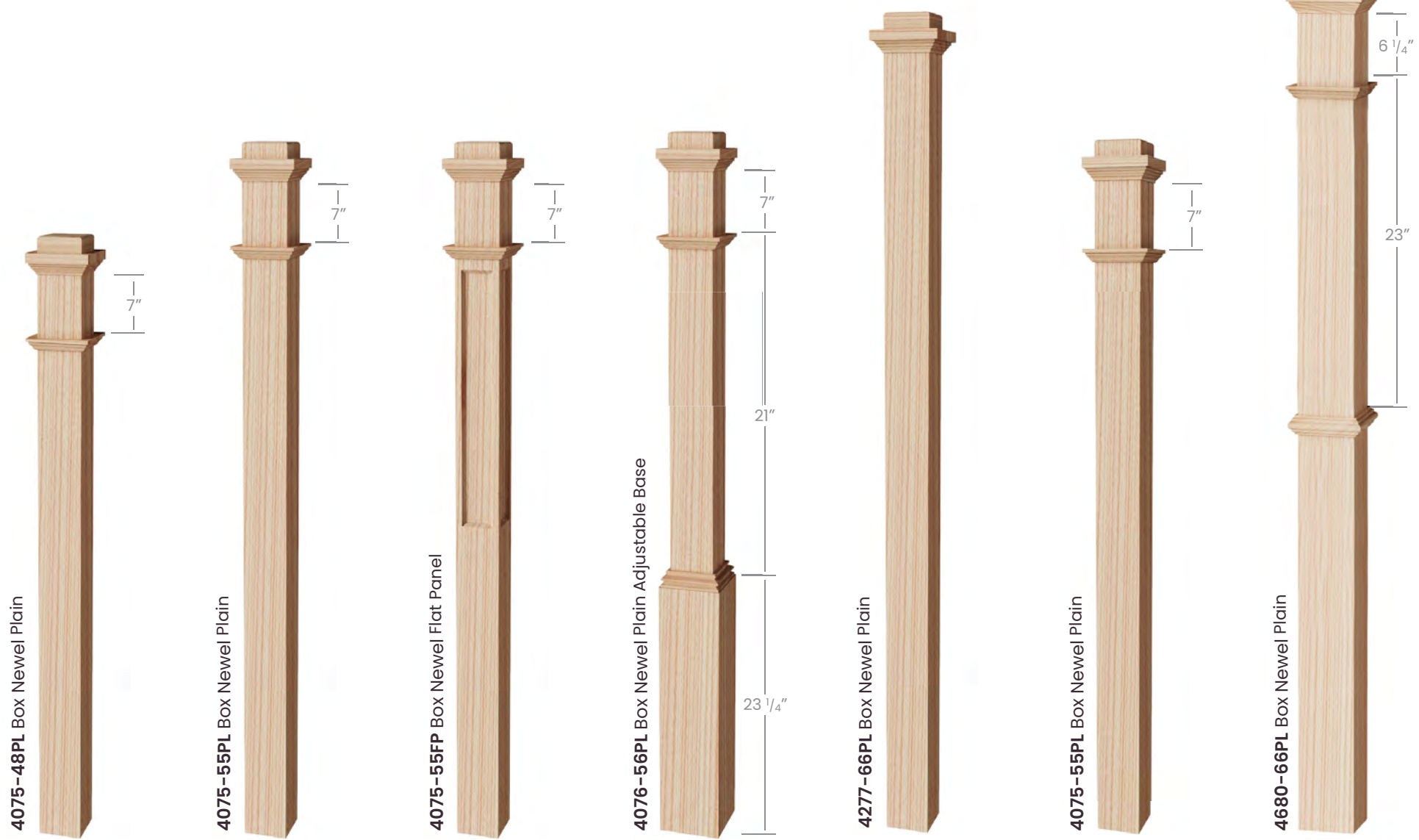

4075-48PL Box Newel Plain
3 1/2" x 48"
Species : RO, POP

4075-55PL Box Newel Plain
3 1/2" x 55"
Species : RO, POP

4075-55FP Box Newel Flat Panel
3 1/2" x 55"
Species : RO, WO, POP

4076-56PL Box Newel Plain Adjustable Base
5" x 56"
Species : RO, WO, POP

4277-66PL Box Newel Plain
3 1/2" x 66"
Species : RO, WO, POP

4075-55PL Box Newel Plain
3 1/2" x 55"
Species : RO, WO, POP

4680-66PL Box Newel Plain
4 1/2" x 66"
Species : RO, WO, POP

6" - 8"

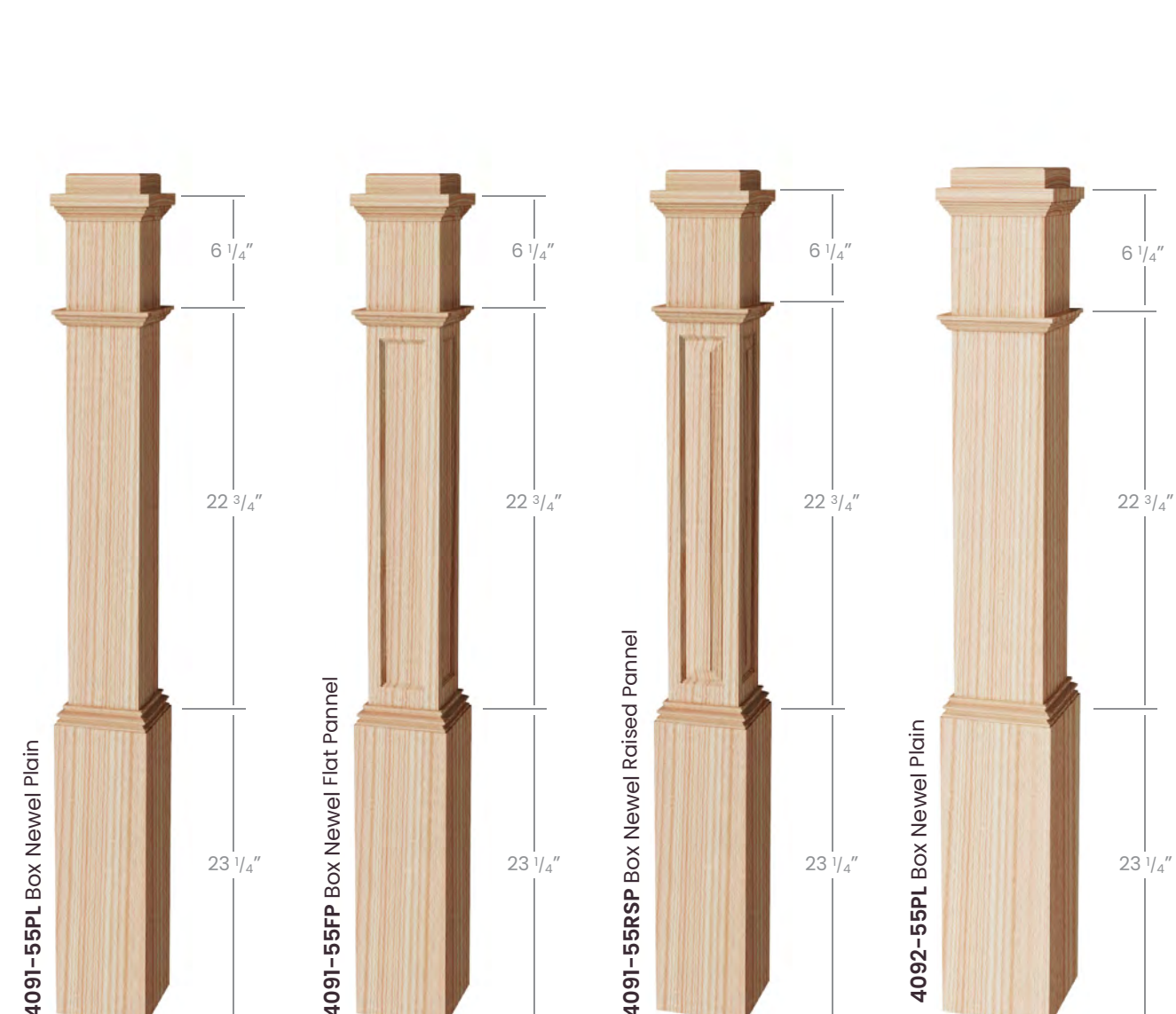

4091-55PL Box Newel Plain
6 1/4" x 55"
Species : RO, POP, PR

4091-55FP Box Newel Flat Panel
6 1/4" x 55"
Species : RO, POP

4091-55RSP Box Newel Raised Panel
6 1/4" x 55"
Species : RO, POP

4092-55PL Box Newel Plain
7 1/2" x 55"
Species : RO, MAP, POP

Turned Newels | Stockbridge Series

Stabilizer



3 1/2" Pin Top



3 1/2" Acorn Top



3013PL Stabilizer Plain
3 1/2" x 44"
Species :
RO, MAP, POP
CHR



3013F Stabilizer Fluted
3 1/2" x 44"
Species :
RO, MAP, POP
CHR



3013T Stabilizer Twist
3 1/2" x 44"
Species :
RO, MAP, POP
CHR



3010-44PT Pin Top Plain
3 1/2" x 44"
Species :
RO, WO, MAP,
POP CHR

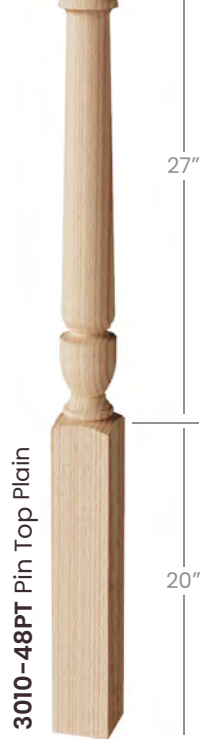

3010-48PT Pin Top Plain
3 1/2" x 48"
Species :
RO, WO, MAP,
POP CHR



3015PT Pin Top Plain
3 1/2" x 56"
Species :
RO, WO, MAP,
POP CHR



3010-44F Pin Top Fluted
3 1/2" x 44"
Species :
RO, MAP, POP
CHR



3010-56F Pin Top Fluted
3 1/2" x 56"
Species :
RO, MAP, POP
CHR



3010T Pin Top Twist
3 1/2" x 44"
Species :
RO, MAP, POP
CHR



3015T Pin Top Twist
3 1/2" x 56"
Species :
RO, MAP, POP
CHR



3042PL Acorn Top Newel Plain
3 1/2" x 56"
Species :
RO, MAP, POP
CHR



3045PL Acorn Top Newel Plain
3 1/2" x 56"
Species :
RO, MAP, POP
CHR



3042F Acorn Top Newel Fluted
3 1/2" x 56"
Species :
RO, MAP, POP
CHR



3045F Acorn Top Newel Fluted
3 1/2" x 56"
Species :
RO, MAP, POP
CHR



3042T Acorn Top Newel Twist
3 1/2" x 56"
Species :
RO, MAP, POP
CHR



3045T Acorn Top Newel Twist
3 1/2" x 56"
Species :
RO, MAP, POP
CHR

Turned Newels | Bordeaux Series

Stabilizer



3" Pin Top



3" Ball Top



3 1/2" Pin Top



3 1/2" Ball Top



<p>953SBL Stabilizer Plain</p> <p>3" x 44" Species : RO, MAP, POP CHR</p>	<p>954PT Pin Top Plain</p> <p>3" x 48" Species : RO, MAP, POP CHR</p>	<p>955-48BT Ball Top Plain</p> <p>3" x 48" Species : RO, MAP, POP CHR</p>	<p>955-54BT Ball Top Plain</p> <p>3" x 54" Species : RO, MAP, POP CHR</p>	<p>955-59BT Ball Top Plain</p> <p>3" x 59" Species : RO, MAP, POP CHR</p>	<p>958BT Ball Top Plain</p> <p>3" x 48" Species : RO, MAP, POP CHR</p>	<p>958BT Ball Top Plain</p> <p>3" x 59" Species : RO, MAP, POP CHR</p>	<p>956-SBT Ball Top Plain</p> <p>3" x 48" Species : RO, MAP, POP CHR</p>	<p>954-48PT Pin Top Plain</p> <p>3 1/2" x 48" Species : RO, MAP, POP CHR</p>	<p>955-48BT Ball Top Plain</p> <p>3 1/2" x 48" Species : RO, MAP, POP CHR</p>	<p>955-56BT Ball Top Plain</p> <p>3 1/2" x 56" Species : RO, MAP, POP CHR</p>	<p>958-56BT Ball Top Plain</p> <p>3 1/2" x 56" Species : RO, MAP, POP CHR</p>	<p>956-48BT Ball Top Plain</p> <p>3 1/2" x 48" Species : RO, MAP, POP CHR</p>	<p>956-56BT Ball Top Plain</p> <p>3 1/2" x 56" Species : RO, MAP, POP CHR</p>
--	--	--	--	--	---	---	---	---	--	--	--	--	--

Turned Newels | Colonial Series

Stabilizer



3" Pin Top



3" Ball Top



4013-SSBL Stabilizer Plain

3" x 43"
Species :
RO, MAP, POP
CHR



4013SBL Stabilizer Plain

3" x 43"
Species :
RO, MAP, POP
CHR

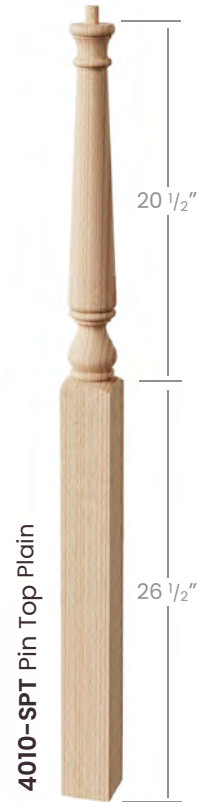

4010-SPT Pin Top Plain

3" x 48"
Species :
RO, MAP, POP
CHR



4010PT Pin Top Plain

3" x 48"
Species :
RO, MAP, POP
CHR



4015-SPT Pin Top Plain

3" x 59"
Species :
RO, MAP, POP
CHR



4015PT Pin Top Plain

3" x 59"
Species :
RO, MAP, POP
CHR



4010-SBT Ball Top Plain

3" x 48"
Species :
RO, MAP, POP
CHR



4010-BT Ball Top Plain

3" x 48"
Species :
RO, MAP, POP
CHR



4012-54SBT Ball Top Plain

3" x 54"
Species :
RO, MAP, POP
CHR



4012-54BT Ball Top Plain

3" x 54"
Species :
RO, MAP, POP
CHR



4012-59SBT Ball Top Plain

3" x 59"
Species :
RO, MAP, POP
CHR



4012-59BT Ball Top Plain

3" x 59"
Species :
RO, MAP, POP
CHR

Turned Newels | Colonial Series

3" Ball Top

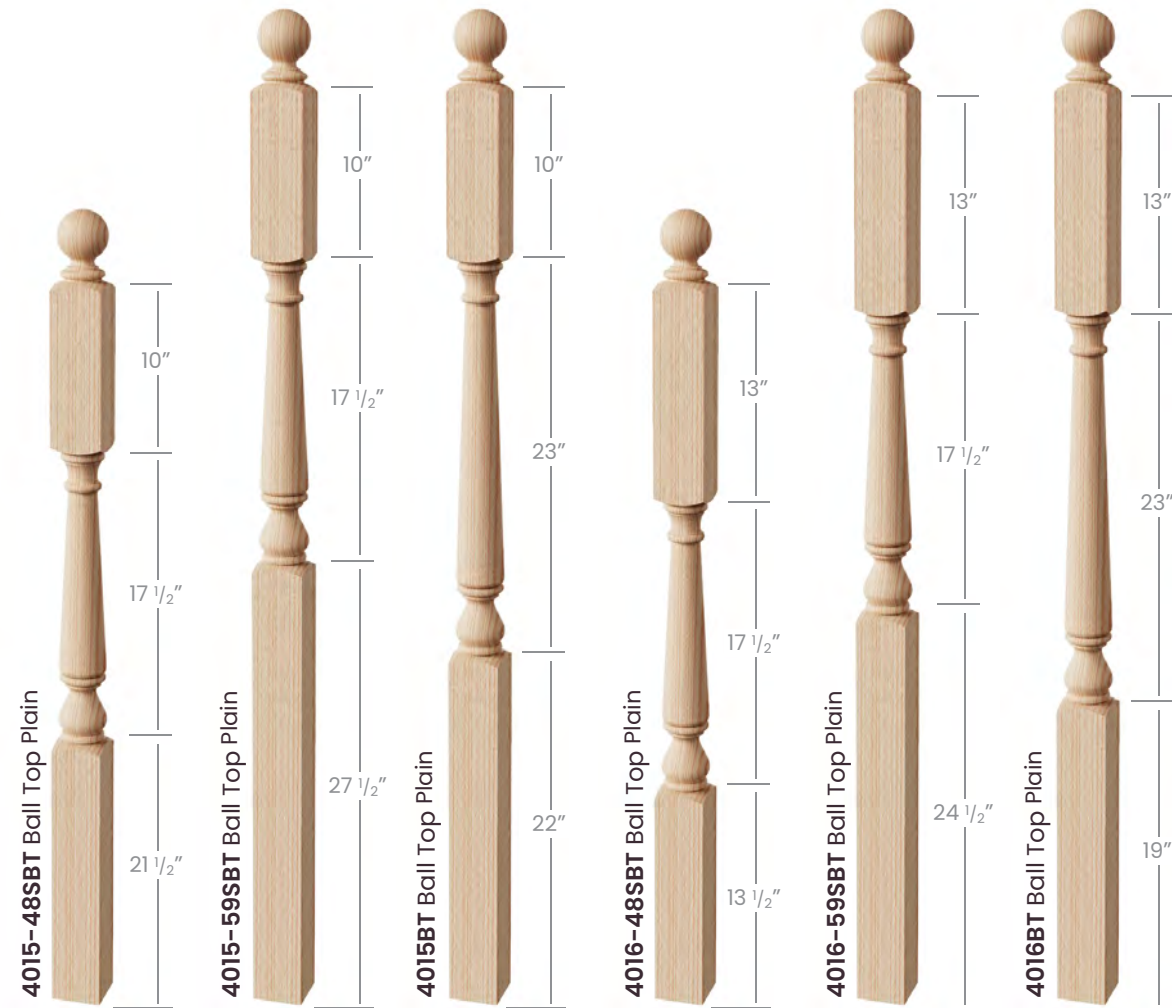

3" x 48" Species: RO, MAP, POP, CHR
 3" x 59" Species: RO, MAP, POP, CHR
 3" x 59" Species: RO, MAP, POP, CHR
 3" x 48" Species: RO, MAP, POP, CHR
 3" x 59" Species: RO, MAP, POP, CHR
 3" x 59" Species: RO, MAP, POP, CHR

3" Mushroom Top



3" x 48" Species: RO, POP
 3" x 54" Species: RO, POP

3 1/2" Pin Top



3 1/2" x 48" Wood Types: RO, POP, MAP

3 1/2" Ball Top

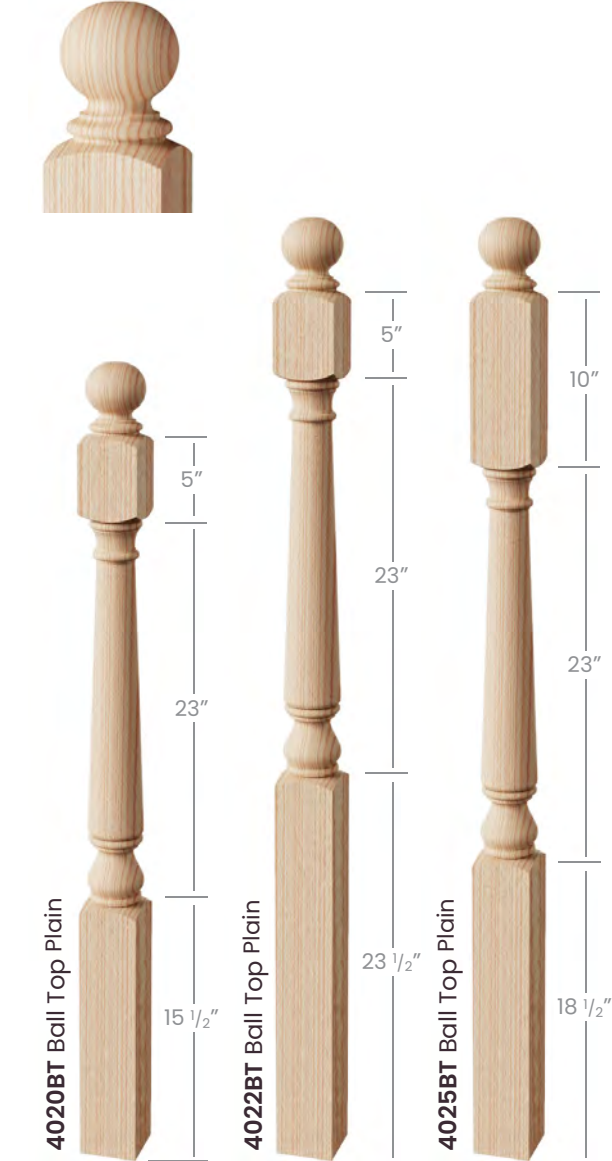

3 1/2" x 48" Species: RO, MAP, POP
 3 1/2" x 56" Species: RO, MAP, POP
 3 1/2" x 56" Species: RO, MAP, POP

Turned Newels | Colonial Variant Series

3" Ball Top

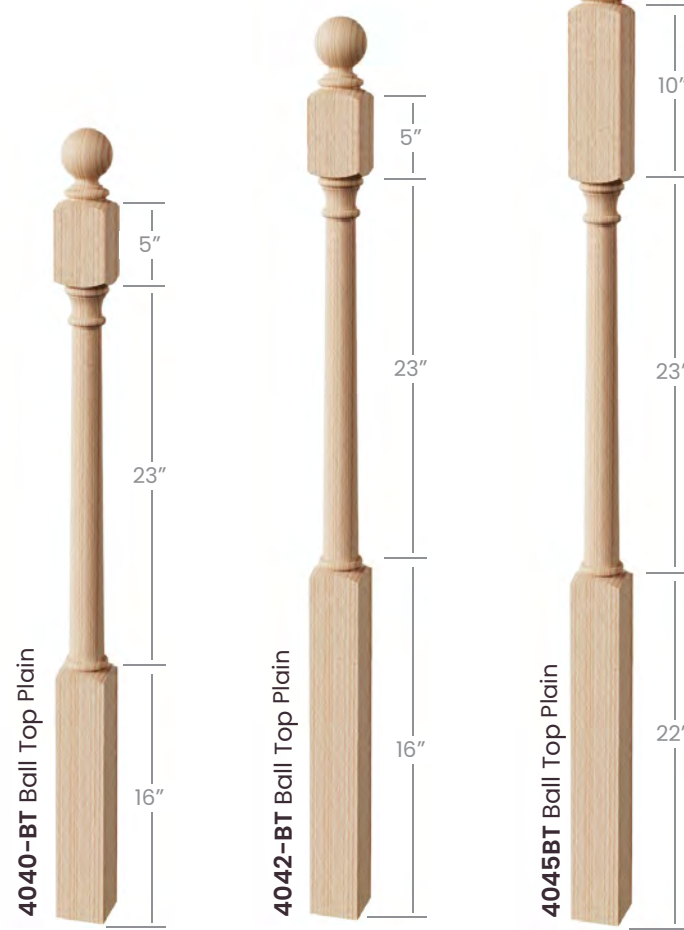

4040-BT Ball Top Plain

3" x 48"
Species :
RO, MAP, POP

4042-BT Ball Top Plain

3" x 54"
Species :
RO, MAP, POP

4045BT Ball Top Plain

3" x 59"
Species :
RO, MAP, POP

3" Mushroom Top

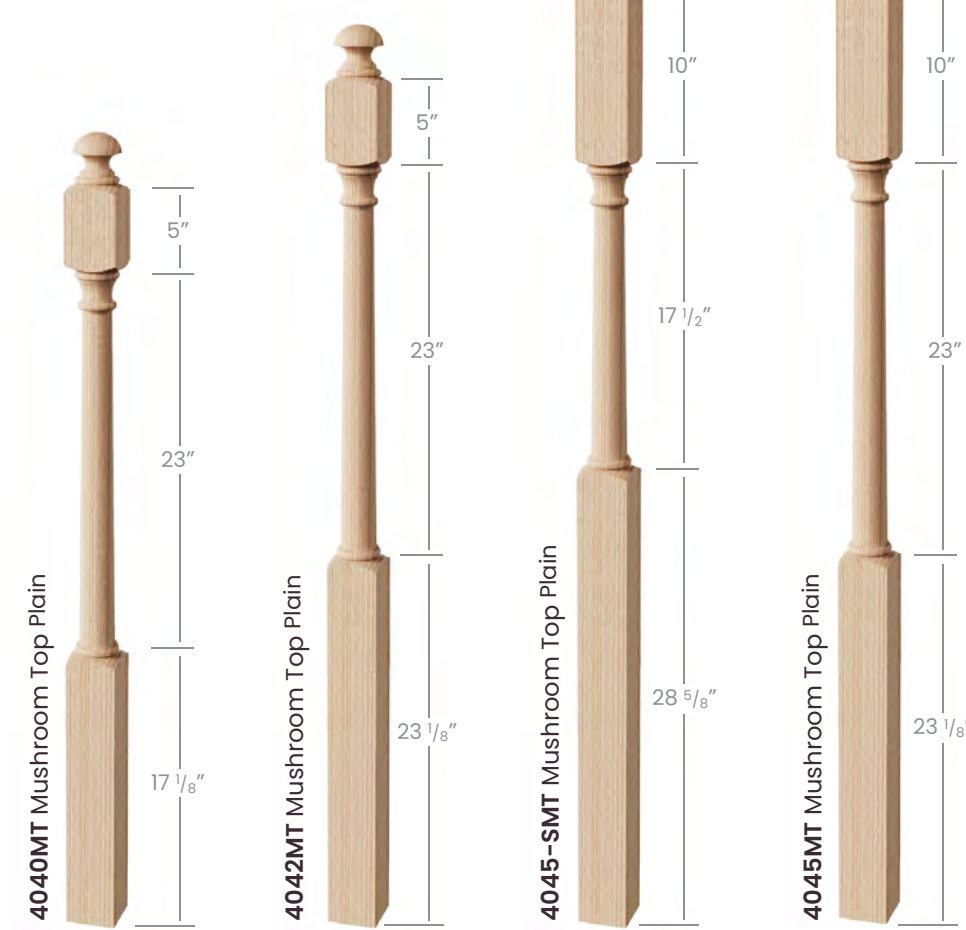

4040MT Mushroom Top Plain

3" x 48"
Species :
RO, MAP, POP

4042MT Mushroom Top Plain

3" x 54"
Species :
RO, MAP, POP

4045-SMT Mushroom Top Plain

3" x 59"
Species :
RO, MAP, POP

4045MT Mushroom Top Plain

3" x 59"
Species :
RO, MAP, POP

Turned Newels | Candlestick Series

3" Pin Top



7300-48PT Pin Top Plain 48"

3" x 48"
Species :
RO, MAP, POP

7300-54PT Pin Top Plain 54"

3" x 54"
Species :
RO, MAP, POP

7300-60PT Pin Top Plain 60"

3" x 60"
Species :
RO, MAP, POP

3 1/2" Pin Top



7500-48PT Pin Top Plain 48"

3 1/2" x 48"
Species :
RO, MAP, POP

7500-54PT Pin Top Plain 54"

3 1/2" x 54"
Species :
RO, MAP, POP

7500-60PT Pin Top Plain 60"

3 1/2" x 60"
Species :
RO, MAP, POP

Turned Newels | Hampton Series

Stabilizer



3" Pin Top



3" Ball Top



3 1/2" Pin Top



3 1/2" Ball Top



3" x 43"
Species :
RO, MAP, POP,
CHR

3" x 48" / 54" / 60"
Species :
RO, MAP, POP,
CHR

3" x 48"
Species :
RO, MAP, POP,
CHR

3" x 54"
Species :
RO, MAP, POP,
CHR

3" x 59"
Species :
RO, MAP, POP,
CHR

3" x 59"
Species :
RO, MAP, POP,
CHR

3" x 59"
Species :
RO, MAP, POP,
CHR

3 1/2" x 48" / 54" / 60"
Species :
RO, MAP, POP,
CHR

3 1/2" x 48"
Species :
RO, MAP, POP,
CHR

3 1/2" x 56"
Species :
RO, MAP, POP,
CHR

3 1/2" x 56"
Species :
RO, MAP, POP,
CHR



Turned Newels | Basic Series

Stabilizer



3" Blank / S4S



4003-48NPB Newel Post Blank 48"



4003-54NPB Newel Post Blank 54"



4003-60NPB Newel Post Blank 60"

313SBL Stabilizer Plain



3" x 44"
Species :
PR, RO, MAP,
POP

3" x 48"
Species :
RO, MAP, POP

3" x 54"
Species :
RO, MAP, POP

3" x 60"
Species :
RO, MAP, POP

3" Ball Top



3004BT Ball Top Plain

3" x 44"
Species :
RO, POP



3005BT Ball Top Plain

3" x 55"
Species :
RO, POP

3 1/2" Blank / S4S



4005-48NPB Newel Post Blank 48"



4005-54NPB Newel Post Blank 54"



4005-60NPB Newel Post Blank 60"

3 1/2" x 48"
Species :
RO, MAP, POP

3 1/2" x 54"
Species :
RO, MAP, POP

3 1/2" x 60"
Species :
RO, MAP, POP

3 1/2" Acorn Top



4500AT Acorn Top Plain

3 1/2" x 51 1/2"
Species :
RO, MAP

3 1/2" Ball Top



4005BT Ball Top Plain

3 1/2" x 51 1/2"
Species :
RO, MAP

Finials and Caps

FN-0100



Species :
RO, WO, POP, MAP, CHR

FN-0103



Species :
RO, WO, POP, MAP, CHR

FN-0104



Species :
RO, WO, POP, MAP, CHR

FN-0108



Species :
RO, WO, POP, MAP, CHR



BN CAP A



Species :
RO, WO, POP, MAP, CHR

BN CAP C



Species :
RO, WO, POP, MAP, CHR

BN CAP E



Species :
RO, WO, POP, MAP, CHR

BN CAP B



Species :
RO, WO, POP, MAP, CHR

BN CAP D



Species :
RO, WO, POP, MAP, CHR



Model Number Key

Pair your desired cap letter with the sizes listed below for your item number

- ___300- Fits on 3" Post
- ___350- Fits on 3.5" Post
- ___475- Fits on 4.75" Post

Ex:
Cap B + 350 = B350

Wood Balusters

Stockbridge Series

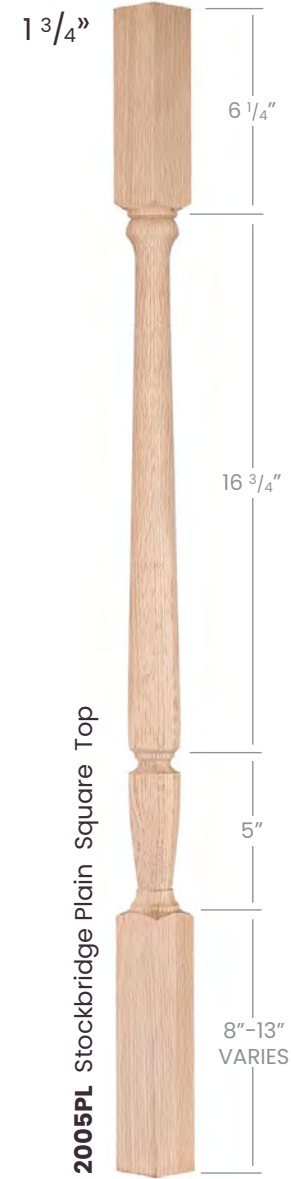

2005PL Stockbridge Plain Square Top
W: 1 3/4"
L: 36" / 41"
 Species :
 RO, POP, MAP



2005F Stockbridge Fluted Square Top
W: 1 3/4"
L: 36" / 41"
 Species :
 RO, POP, MAP



2005T Stockbridge Twisted Square Top
W: 1 3/4"
L: 36" / 41"
 Species :
 RO, POP, MAP



2015PL Stockbridge Plain Pin Top
W: 1 3/4"
L: 36" / 41"
 Species :
 RO, MAP, PR



2015F Stockbridge Fluted Pin Top
W: 1 3/4"
L: 36" / 41"
 Species :
 RO, POP, MAP



2015T Stockbridge Twisted Pin Top
W: 1 3/4"
L: 36" / 41"
 Species :
 RO, MAP, PR

Bordeaux Series



908 Bordeaux Pin Top
W: 1 1/4"
L: 31" / 36" / 41"
 Species :
 RO, POP, MAP, PR



910 Bordeaux Square Top
W: 1 1/4"
L: 36" / 41"
 Species :
 RO, POP, MAP



912 Bordeaux Pin Top
W: 1 1/4"
L: 36" / 41"
 Species :
 RO, PR



909 Bordeaux Pin Top
W: 1 3/4"
L: 31" / 36" / 41"
 Species :
 RO, POP, PR



911 Bordeaux Square Top
W: 1 3/4"
L: 36" / 41"
 Species :
 RO, POP, MAP

Wood Balusters

Colonial Series

Candlestick Series

Blank Series / S4S

Hampton Series



5015 Colonial Pin Top

W: 1 1/4"
L: 34" / 36" / 39" / 41"
Species :
RO, PR



5141 Colonial Round Tapered Square Top

W: 1 1/4"
L: 34" / 36" / 39" / 41"
Species :
RO, POP, PR



5040 Colonial Round Tapered Pin Top

W: 1 1/4"
L: 34" / 36" / 39" / 42"
Species :
RO, POP



5340 Colonial Round Tapered Pin Top

W: 1 3/4"
L: 34" / 36" / 39" / 42"
Species :
RO, POP



100 Blank Baluster

W: 1 1/4"
L: 36" / 41" / 42"
Species :
RO, POP, MAP, CHR,
PR



100CE Blank Baluster Chamfered Edge

W: 1 1/4"
L: 36" / 41"
Species :
PR



100EE Blank Baluster Eased Edge

W: 1 1/4"
L: 31" / 36" / 41"
Species :
POP



5200 Hampton Pin Top

W: 1 1/4"
L: 31" / 34" / 36" / 41"
Species :
RO, MAP, PR



5205 Hampton Square Top

W: 1 1/4"
L: 36" / 41"
Species :
RO, POP, MAP



5005 Hampton Square Top

W: 1 3/4"
L: 36" / 41"
Species :
RO, POP, MAP, PR



5300 Hampton Pin Top

W: 1 3/4"
L: 36" / 39" / 41"
Species :
RO, MAP, PR

Primed Wood Balusters

Stockbridge Series

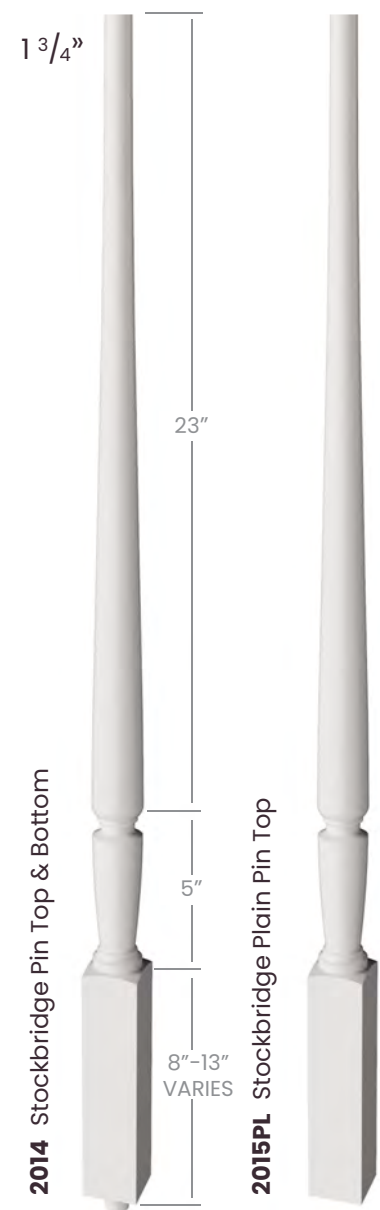

W: 1 3/4"
L: 31" / 36" / 39" / 41"

W: 1 3/4"
L: 36" / 41"

Bordeaux Series

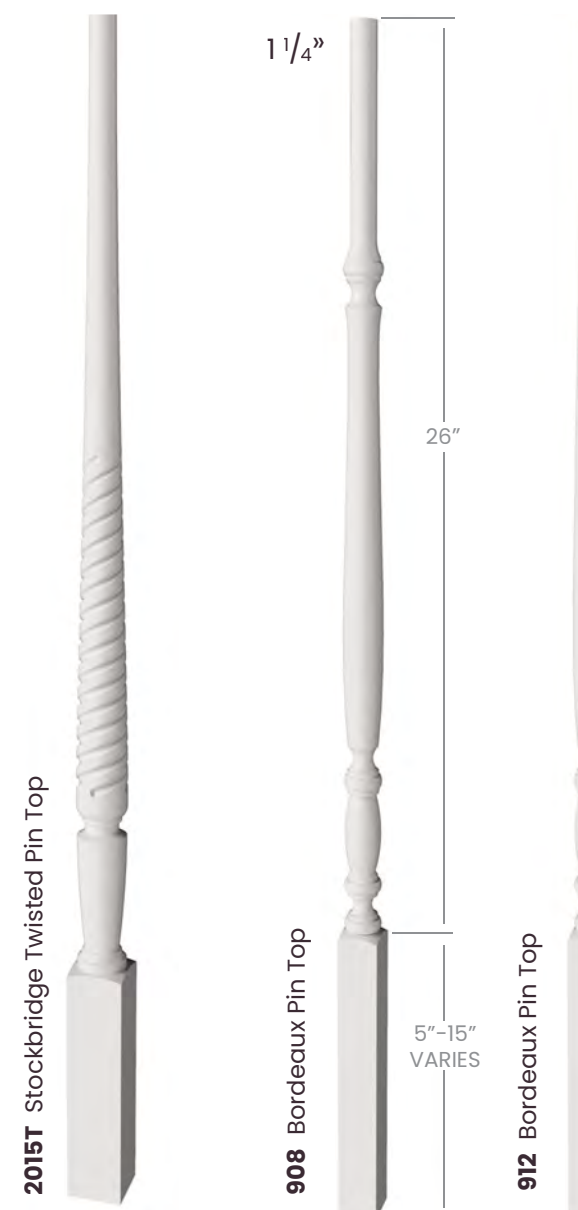

W: 1 1/4"
L: 36" / 41"

W: 1 1/4"
L: 31" / 36" / 41"

W: 1 1/4"
L: 36" / 41"

Colonial Series

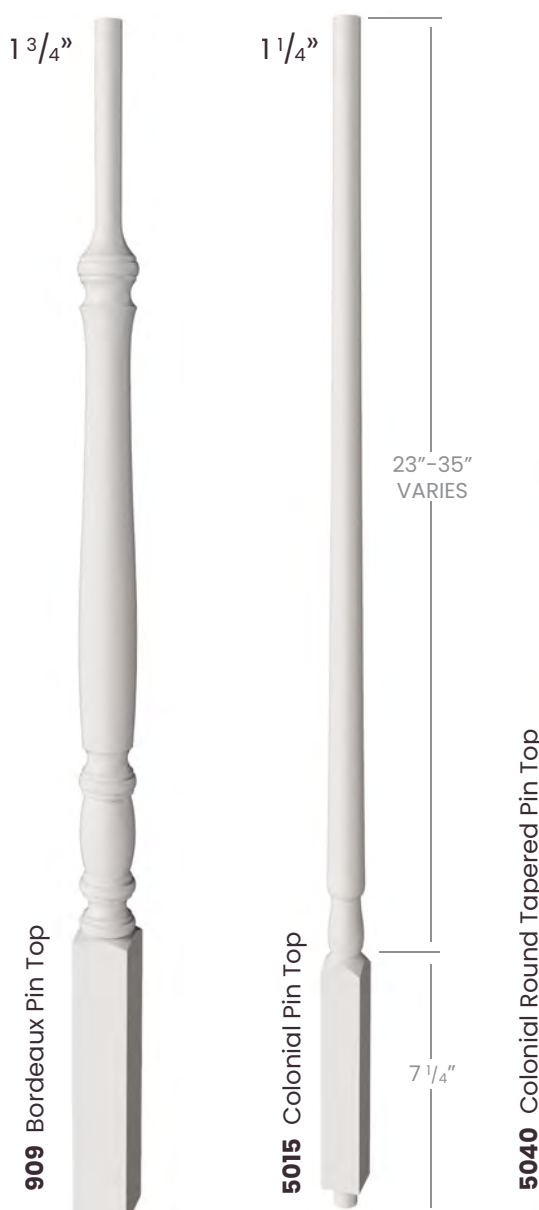

W: 1 3/4"
L: 31" / 36" / 41"

W: 1 1/4"
L: 34" / 36" / 39" / 41"

W: 1 1/4"
L: 36" / 39" / 42"

Hampton Series

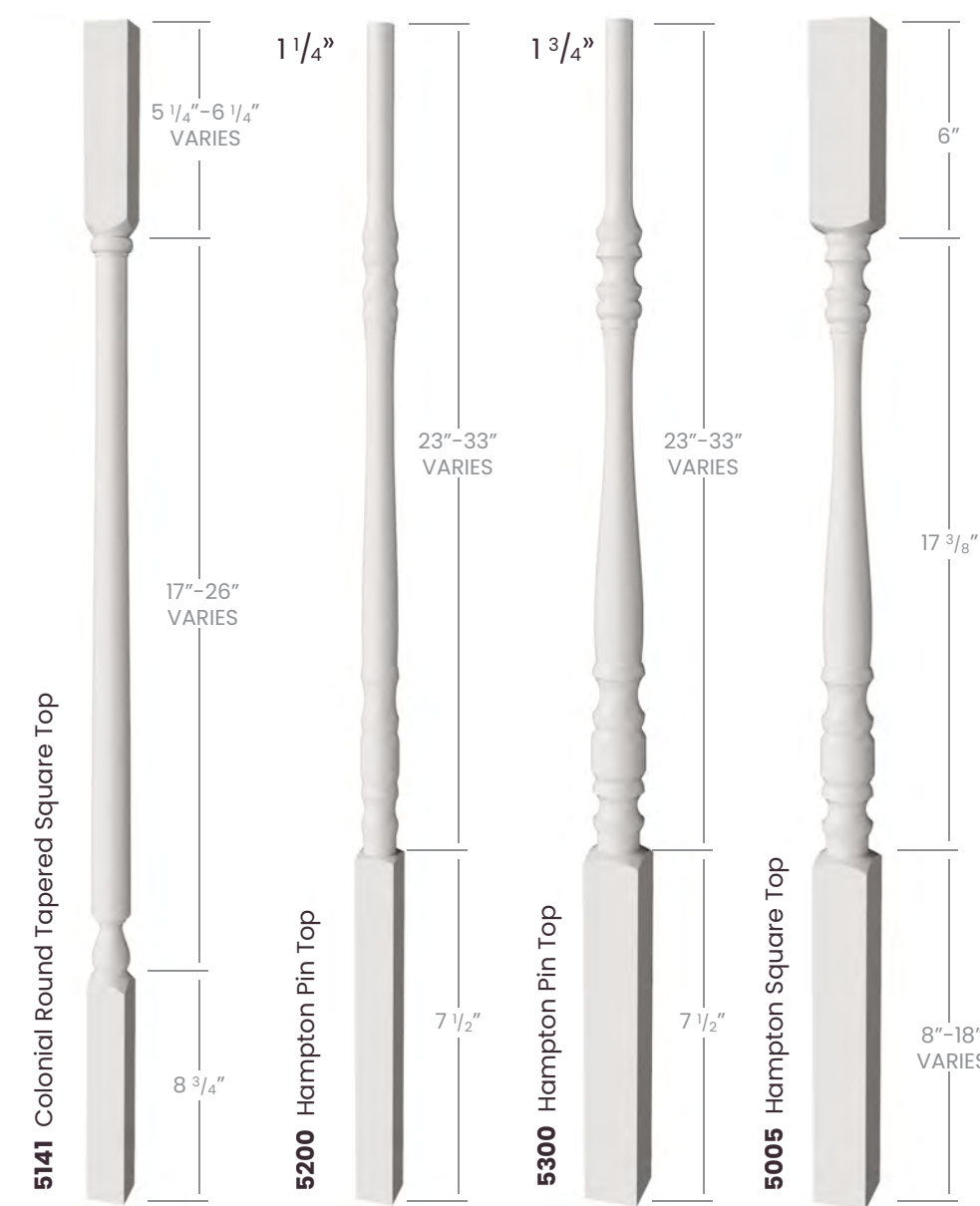

W: 1 1/4"
L: 34" / 36" / 39" / 41"

W: 1 1/4"
L: 31" / 34" / 36" / 41"

W: 1 3/4"
L: 36" / 39" / 41"

W: 1 3/4"
L: 36" / 41"

Blank Series

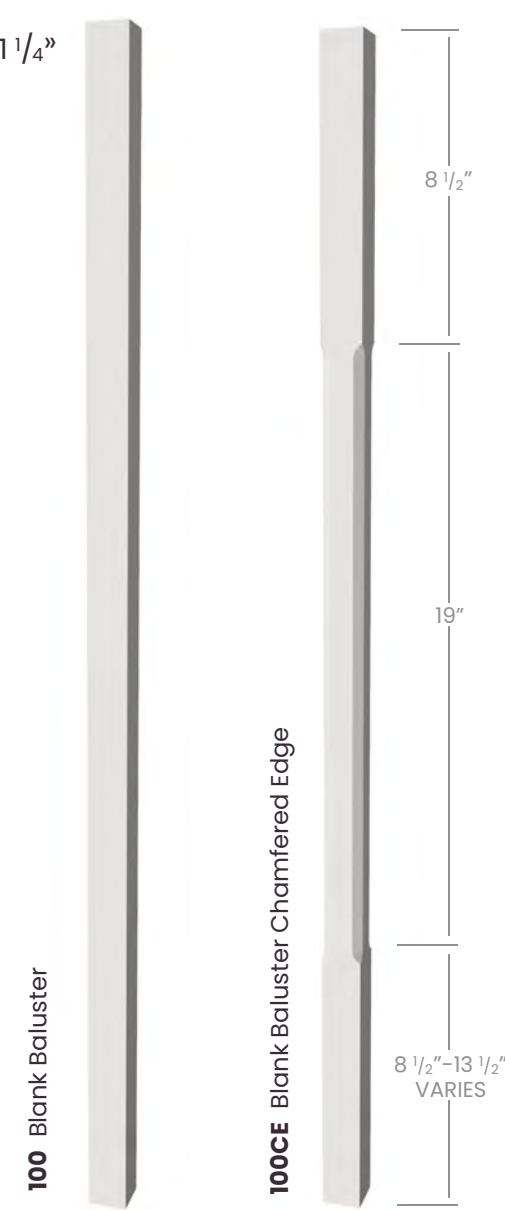

W: 1 1/4"
L: 14" / 36" / 41" / 42"

W: 1 1/4"
L: 36" / 41"

Iron Balusters | 1/2" Round



TR01 Plain | Hollow
1/2" x 44"
Patinas :
SB, ORB

S20 Distressed | Solid
1/2" x 44"
Patinas :
SB, CV, NIC

S21 Single Urn Distressed | Solid
1/2" x 44"
Patinas :
SB, CV, NIC

S22 Double Urn Distressed | Solid
1/2" x 44"
Patinas :
SB, CV, NIC

TR22 Single Ball | Hollow
1/2" x 44"
Patinas :
SB, ORB

TR23 Double Ball | Hollow
1/2" x 44"
Patinas :
SB, ORB

Shoes | 1/2" Round

Flat Shoe

SD500R | Solid



1 1/2" x 1 1/2" x 1"
Patinas :
SB, CV, NIC

SHR900 | Hollow



1 5/8" x 1 5/8" x 1 5/8"
Patinas :
SB, ORB

Rake Shoe

SD504R | Solid



1 1/2" x 1 1/2" x 2"
Patinas :
SB, CV, NIC

SHR904 | Hollow



1 5/8" x 1 5/8" x 2 1/4"
Patinas :
SB, ORB

Iron Balusters | 1/2" Square

Gothic / Hammered

Use shoes **SH901** or **SH905** for this series.

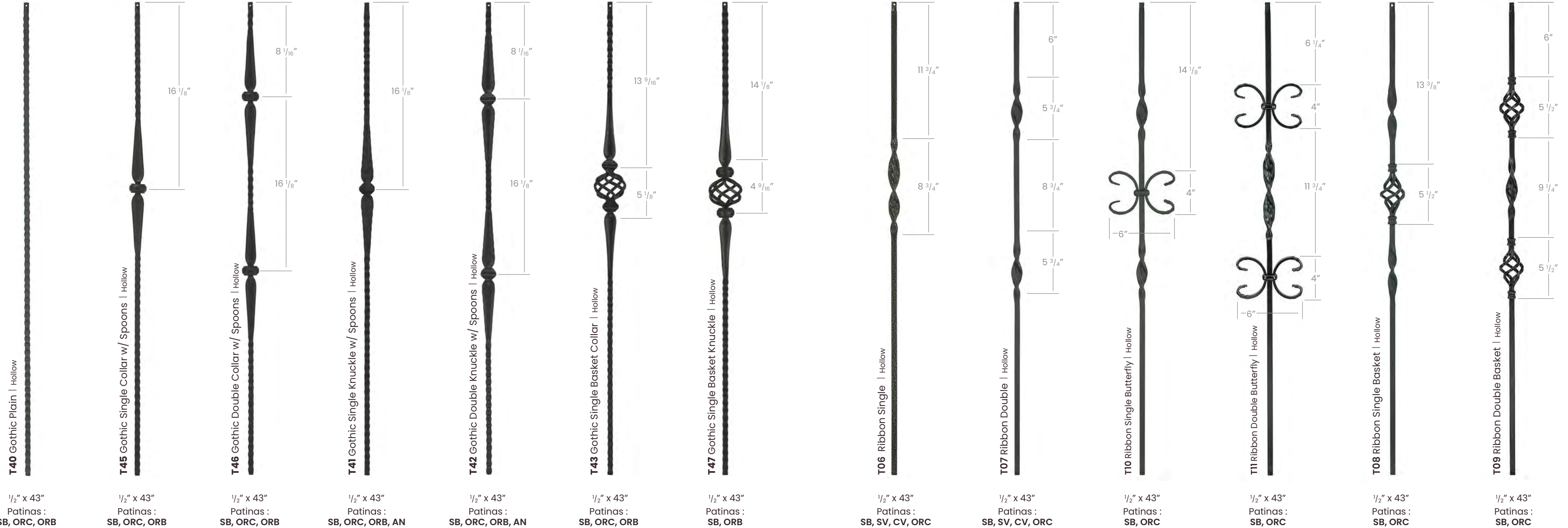

T40 Gothic Plain | Hollow
1/2" x 43"
Patinas :
SB, ORC, ORB

T45 Gothic Single Collar w/ Spoons | Hollow
1/2" x 43"
Patinas :
SB, ORC, ORB

T46 Gothic Double Collar w/ Spoons | Hollow
1/2" x 43"
Patinas :
SB, ORC, ORB

T41 Gothic Single Knuckle w/ Spoons | Hollow
1/2" x 43"
Patinas :
SB, ORC, ORB, AN

T42 Gothic Double Knuckle w/ Spoons | Hollow
1/2" x 43"
Patinas :
SB, ORC, ORB, AN

T43 Gothic Single Basket Collar | Hollow
1/2" x 43"
Patinas :
SB, ORC, ORB

T47 Gothic Single Basket Knuckle | Hollow
1/2" x 43"
Patinas :
SB, ORB

T06 Ribbon Single | Hollow
1/2" x 43"
Patinas :
SB, SV, CV, ORC

T07 Ribbon Double | Hollow
1/2" x 43"
Patinas :
SB, SV, CV, ORC

T10 Ribbon Single Butterfly | Hollow
1/2" x 43"
Patinas :
SB, ORC

T11 Ribbon Double Butterfly | Hollow
1/2" x 43"
Patinas :
SB, ORC

T08 Ribbon Single Basket | Hollow
1/2" x 43"
Patinas :
SB, ORC

T09 Ribbon Double Basket | Hollow
1/2" x 43"
Patinas :
SB, ORC

Iron Balusters | 1/2" Square

Contemporary

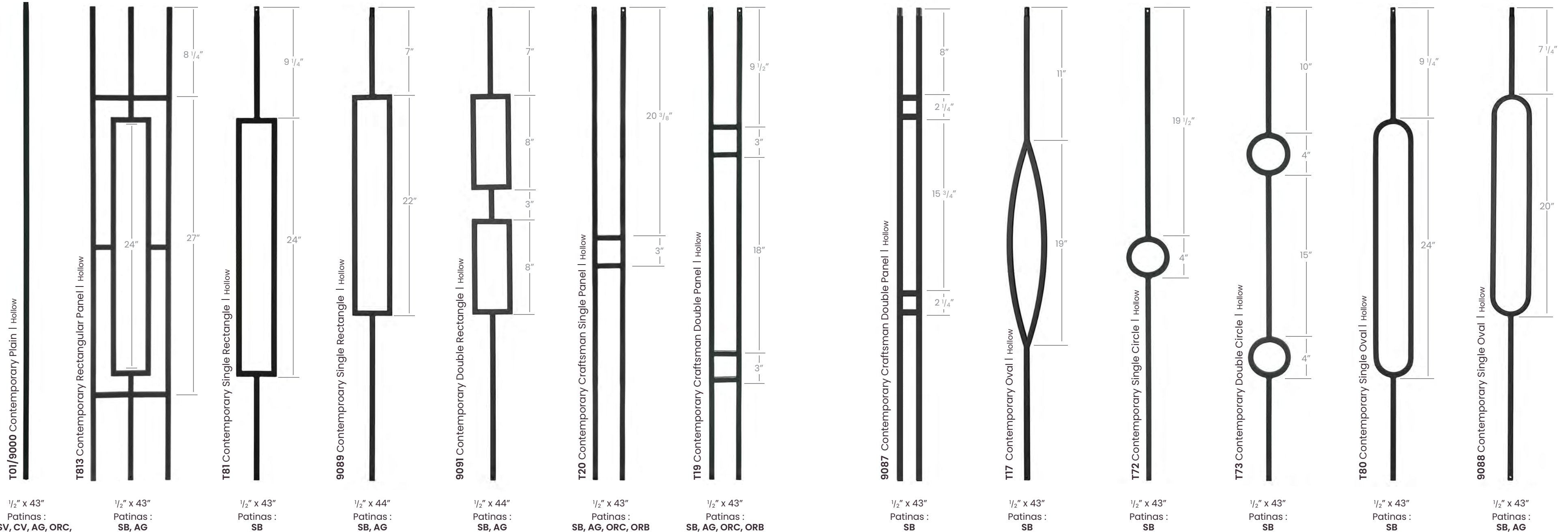

Iron Balusters | 1/2" Square

Contemporary

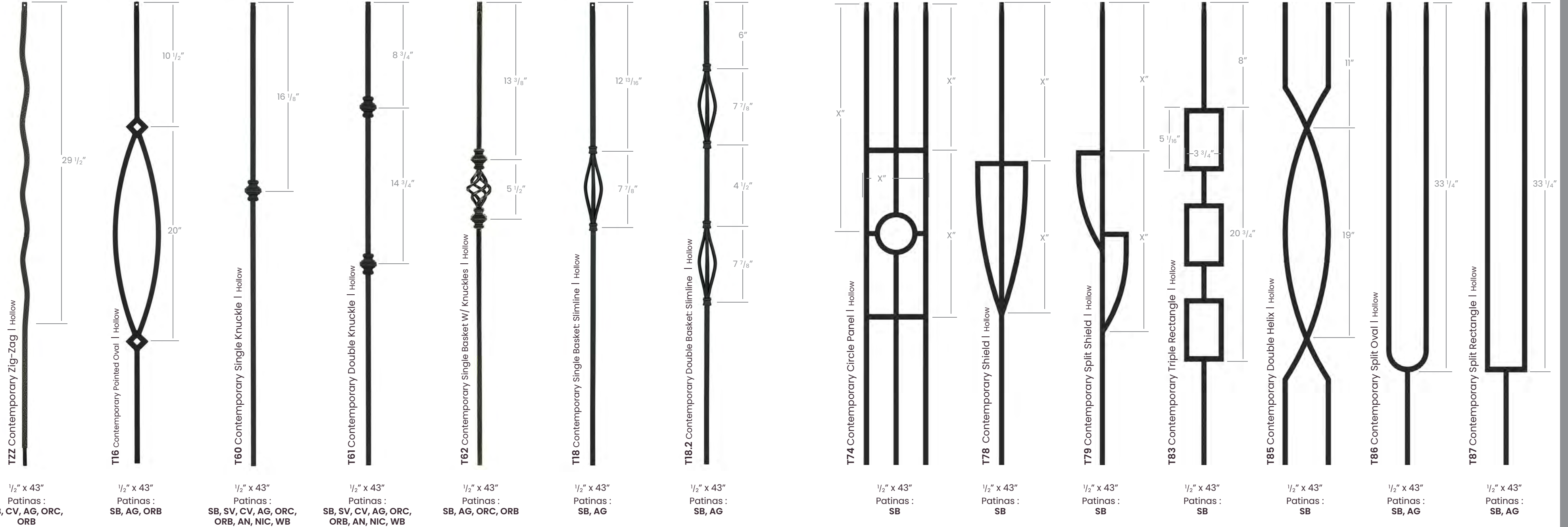

Iron Balusters | 1/2" Square

Scroll



T155 Feather Scroll | Hollow
1/2" x 43"
Patinas :
SB, ORC



T35 Hour Glass Scroll | Hollow
1/2" x 43"
Patinas :
SB



T58 Double Heart Scroll | Hollow
1/2" x 43"
Patinas :
SB



9090 Spiral Scroll | Hollow
1/2" x 44"
Patinas :
SB



9008 16" Scroll | Hollow
1/2" x 44"
Patinas :
SB



9081 24" S Scroll Narrow | Hollow
1/2" x 44"
Patinas :
SB



9009 24" S Scroll | Hollow
1/2" x 44"
Patinas :
SB



T56 Traditional S Scroll | Hollow
1/2" x 43"
Patinas :
SB, SV, CV, AG, ORC,
ORB, AN

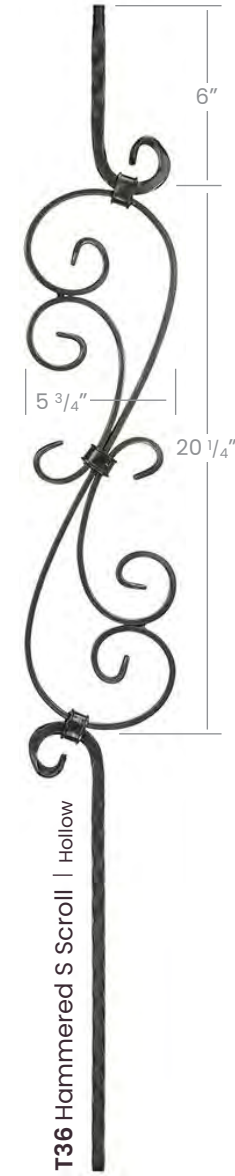

T36 Hammered S Scroll | Hollow
1/2" x 43"
Patinas :
SB, ORC, ORB

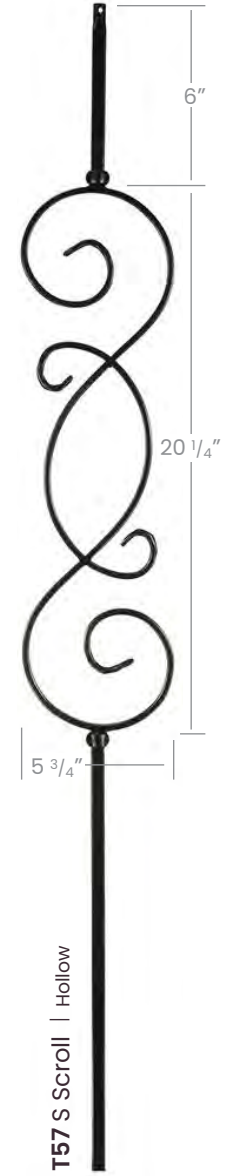

T57 S Scroll | Hollow
1/2" x 43"
Patinas :
SB, AG, ORC

Iron Balusters | 1/2" Square

Tuscan / Hammered

Use shoes **SH901** or **SH905** for this series.



T33 Tuscan Plain | Hollow

1/2" x 43"
Patinas :
SB, ORC, ORB



T31 Tuscan Single Ball | Hollow

1/2" x 43"
Patinas :
SB, ORC, ORB



T32 Tuscan Double Ball | Hollow

1/2" x 43"
Patinas :
SB, ORC, ORB



T93 Tuscan Single Diamond | Hollow

1/2" x 43"
Patinas :
SB, ORB



T94 Tuscan Double Diamond | Hollow

1/2" x 43"
Patinas :
SB, ORB



T95 Tuscan Single Oval | Hollow

1/2" x 43"
Patinas :
SB, ORB



T96 Tuscan Double Oval | Hollow

1/2" x 43"
Patinas :
SB, ORB

Taos



T30 Taos Plain | Hollow

1/2" x 43"
Patinas :
SB, ORC, ORB



T21 Taos Flower W/ Arrows | Hollow

1/2" x 43"
Patinas :
SB, ORB



T22 Taos Split Arrows | Hollow

1/2" x 43"
Patinas :
SB, ORB



T23 Taos Split Arrows W/ Basket | Hollow

1/2" x 43"
Patinas :
SB, ORB

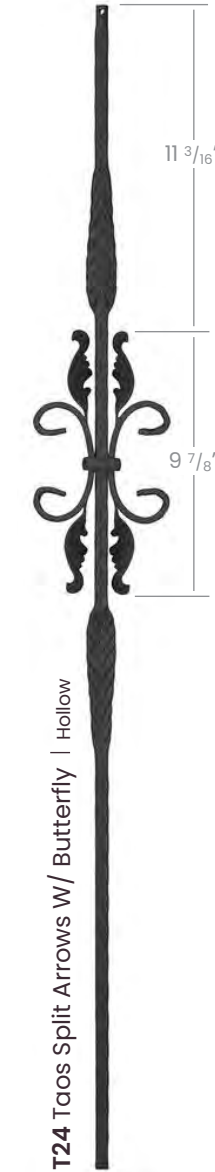

T24 Taos Split Arrows W/ Butterfly | Hollow

1/2" x 43"
Patinas :
SB, ORB

Iron Balusters | 1/2" Square

Twist

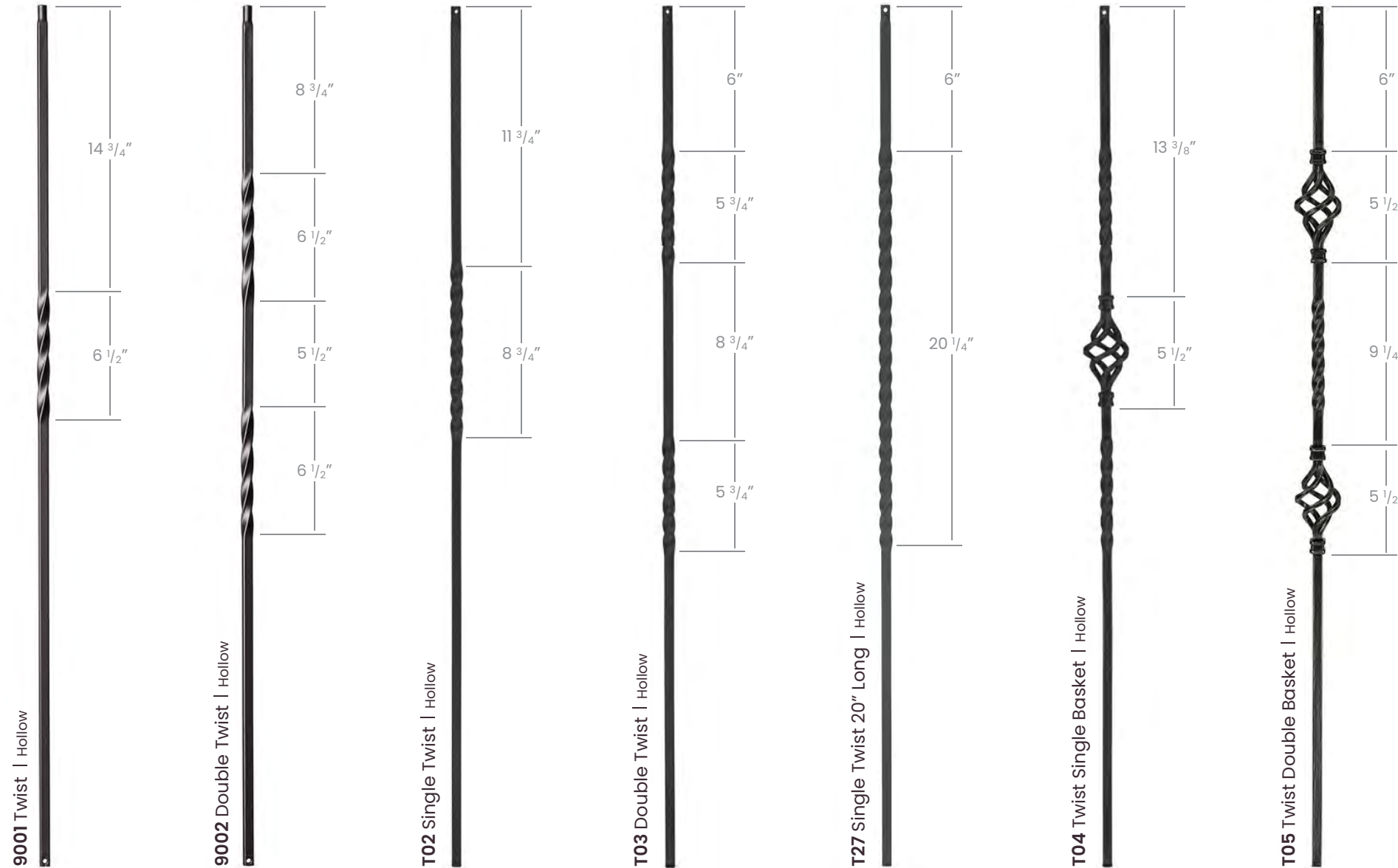

1/2" x 44"
Patinas :
SB, ORC

1/2" x 44"
Patinas :
SB, ORC

1/2" x 43"
Patinas :
SB, SV, CV, AG, ORC,
ORB, AN

1/2" x 43"
Patinas :
SB, SV, CV, AG, ORC,
ORB, AN

1/2" x 43"
Patinas :
SB, ORC

1/2" x 43"
Patinas :
SB, SV, CV, AG, ORC,
ORB, AN

1/2" x 43"
Patinas :
SB, SV, CV, AG, ORC,
ORB, AN

Belly



1/2" x 43"
Patinas :
SB

1/2" x 43"
Patinas :
SB

Compatible Shoes

Flat Shoe

SH900 | Hollow



1 5/16" x 1 5/16" x 1"
Patinas :
SB, SV, CV, AG, ORC,
ORB, AN, WB

SH800 | Hollow

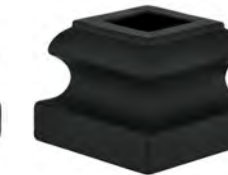

1 5/16" x 1 5/16" x 1"
Patinas :
SB

SH906 | Solid



2" x 2" x 1 7/16"
Patinas :
SB

SH906 | Solid



2 5/8" x 1 1/2" x 1"
Patinas :
SB

Rake Shoe

SH804 | Hollow



1 5/16" x 1 5/16" x 1 7/8"
Patinas :
SB, CV, NIC

SH904 | Hollow



1 5/16" x 1 5/16" x 1 7/8"
Patinas :
SB, SV, CV, AG, ORC,
ORB, AN, WB

Knuckle

KN500 | Hollow



1 9/16" x 1 9/16" x 1 7/8"
Patinas :
SB, SV, CV, AG, ORC,
ORB, AN, WB

Hammered Baluster Shoes

SH901 | Hollow



1 5/16" x 1 5/16" x 1"
Patinas :
SB, ORC, ORB, AN

SH905 | Hollow



1 5/16" x 1 5/16" x 1 7/8"
Patinas :
SB, ORC, ORB

Use these shoes if you are using either the **Gothic** or **Tuscan** series.

Iron Balusters $\frac{9}{16}$ " Round



9068 Plain Hollow

$\frac{9}{16}$ " x 44"
Patinas :
SB, ORB



9069 Knuckle Spoon Hollow

$\frac{9}{16}$ " x 44"
Patinas :
SB, ORB



9070 Double Knuckle Spoon Hollow

$\frac{9}{16}$ " x 44"
Patinas :
SB, ORB

Iron Balusters $\frac{5}{8}$ " Round



2GR01 Plain Hollow

$\frac{5}{8}$ " x 43"
Patinas :
SB, AG



2GR60 Single Knuckle Hollow

$\frac{5}{8}$ " x 43"
Patinas :
SB



2GR61 Double Knuckle Hollow

$\frac{5}{8}$ " x 43"
Patinas :
SB



2GR22 Single Ball Hollow

$\frac{5}{8}$ " x 43"
Patinas :
SB, ORB



2GR23 Double Ball Hollow

$\frac{5}{8}$ " x 43"
Patinas :
SB, ORB



2GR18 Single Basket Slimline Hollow

$\frac{5}{8}$ " x 43"
Patinas :
SB

Iron Balusters | 5/8" Round

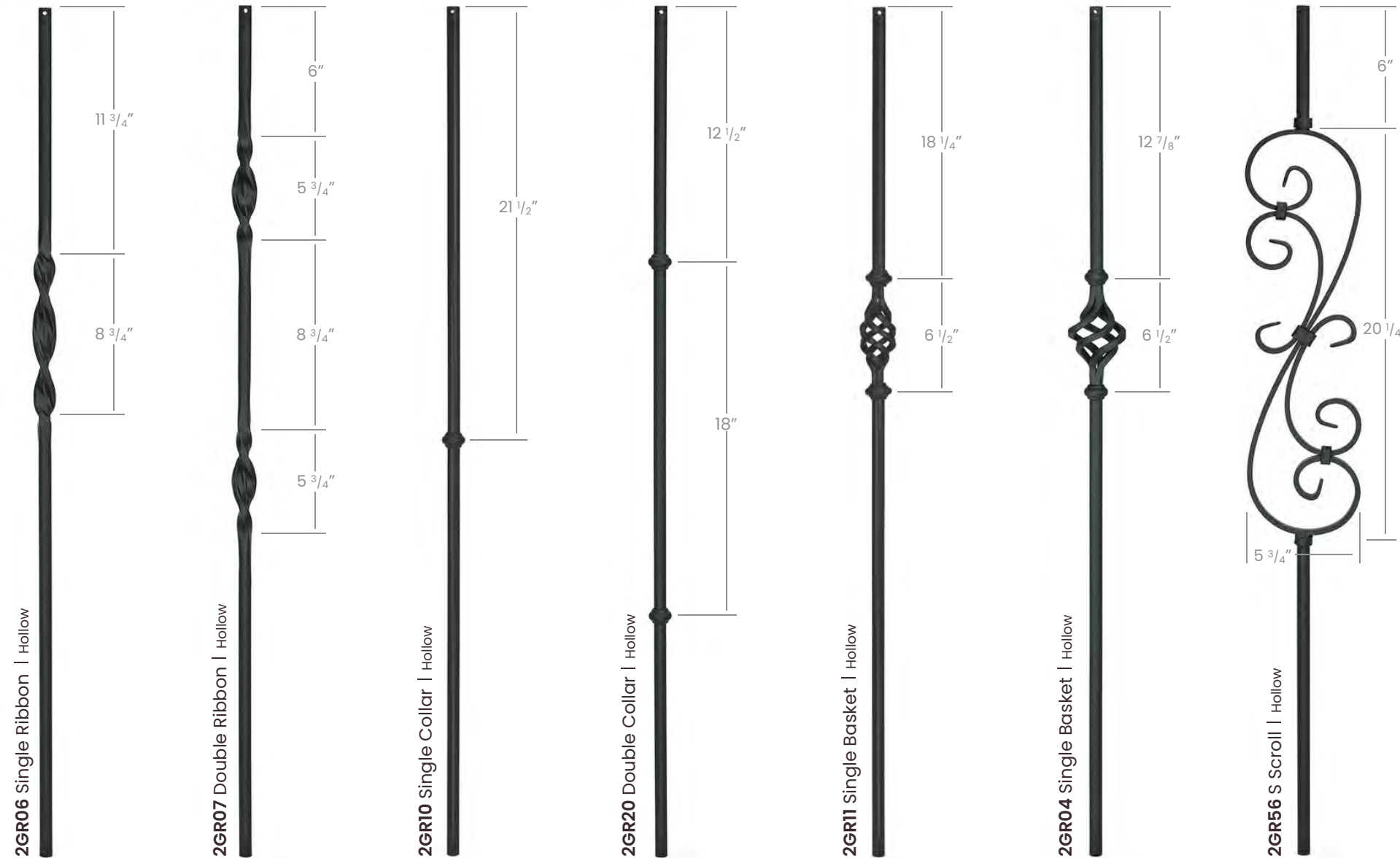

2GR06 Single Ribbon | Hollow
 5/8" x 43"
 Patinas : SB

2GR07 Double Ribbon | Hollow
 5/8" x 43"
 Patinas : SB

2GR10 Single Collar | Hollow
 5/8" x 43"
 Patinas : SB, AG

2GR20 Double Collar | Hollow
 5/8" x 43"
 Patinas : SB, AG

2GR11 Single Basket | Hollow
 5/8" x 43"
 Patinas : SB, AG

2GR04 Single Basket | Hollow
 5/8" x 43"
 Patinas : SB, ORB

2GR56 S Scroll | Hollow
 5/8" x 43"
 Patinas : SB

Compatible Shoes

| Flat Shoe

2GR900 | Hollow



1 3/8" x 1 3/8" x 1 3/8"
 Patinas : SB, AG

| Rake Shoe

2GR904 | Hollow



1 3/8" x 1 3/8" x 2 3/8"
 Patinas : SB, AG

| Knuckle

2GRKNCK | Hollow



1 3/4" x 1 3/4" x 2 3/4"
 Patinas : SB

C1 | Hollow



1 1/8" x 1 1/8" x 3/4"
 Patinas : SB, AN, ANTIQUE BRASS, ANTIQUE COPPER

C2 | Hollow



1 1/8" x 1 1/8" x 2 5/8"
 Patinas : SB, AN, ANTIQUE BRASS, ANTIQUE COPPER

Iron Balusters | 5/8" Square

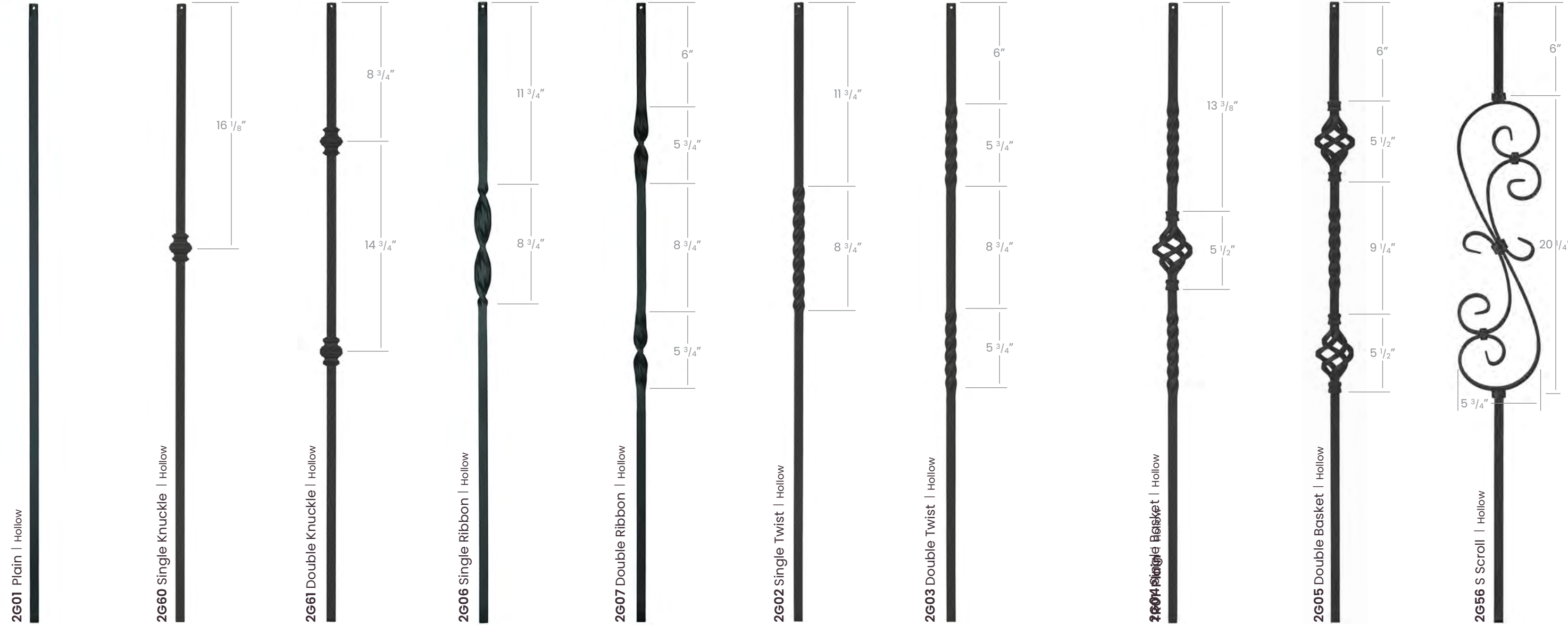

2G01 Plain | Hollow
 5/8" x 43"
 Patinas : SB, ORB

2G60 Single Knuckle | Hollow
 5/8" x 43"
 Patinas : SB, SV, CV

2G61 Double Knuckle | Hollow
 5/8" x 43"
 Patinas : SB, SV, CV

2G06 Single Ribbon | Hollow
 5/8" x 43"
 Patinas : SB

2G07 Double Ribbon | Hollow
 5/8" x 43"
 Patinas : SB

2G02 Single Twist | Hollow
 5/8" x 43"
 Patinas : SB, SV, CV, ORB

2G03 Double Twist | Hollow
 5/8" x 43"
 Patinas : SB, SV, CV, ORB

2G04 Single Basket | Hollow
 5/8" x 43"
 Patinas : SB, SV, CV, ORB

2G05 Double Basket | Hollow
 5/8" x 43"
 Patinas : SB, SV, CV, ORB

2G56 S Scroll | Hollow
 5/8" x 43"
 Patinas : SB, SV, CV, ORB



Compatible Shoes

Flat Shoe

2G900 | Hollow



1 7/16" x 1 7/16" x 1 1/16"
 Patinas : SB, SV, CV, ORB

Knuckle

2GKNCK | Hollow



1 5/8" x 1 5/8" x 1 7/8"
 Patinas : SB, ORB

Rake Shoe

2G904 | Hollow



1 7/16" x 1 7/16" x 2"
 Patinas : SB, SV, CV, ORB



Iron Newels | 1-3/16"



TN01 Plain | Hollow

1-3/16" x 47"
Patinas :
SB



TN33 Hammered | Hollow

1-3/16" x 47"
Patinas :
SB



TN04 Single Basket Twist | Hollow

1-3/16" x 47"
Patinas :
SB



TN31 Single Ball Hammered | Hollow

1-3/16" x 47"
Patinas :
SB

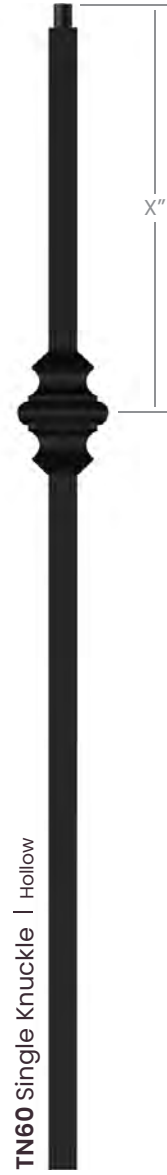

TN60 Single Knuckle | Hollow

1-3/16" x 47"
Patinas :
SB

Iron Newel Fastening Kit

| Flat Shoe

TN900 | Solid



Shoe Dimension:
3 1/8" x 3 1/8" x 2 1/8"

Patinas :
SB

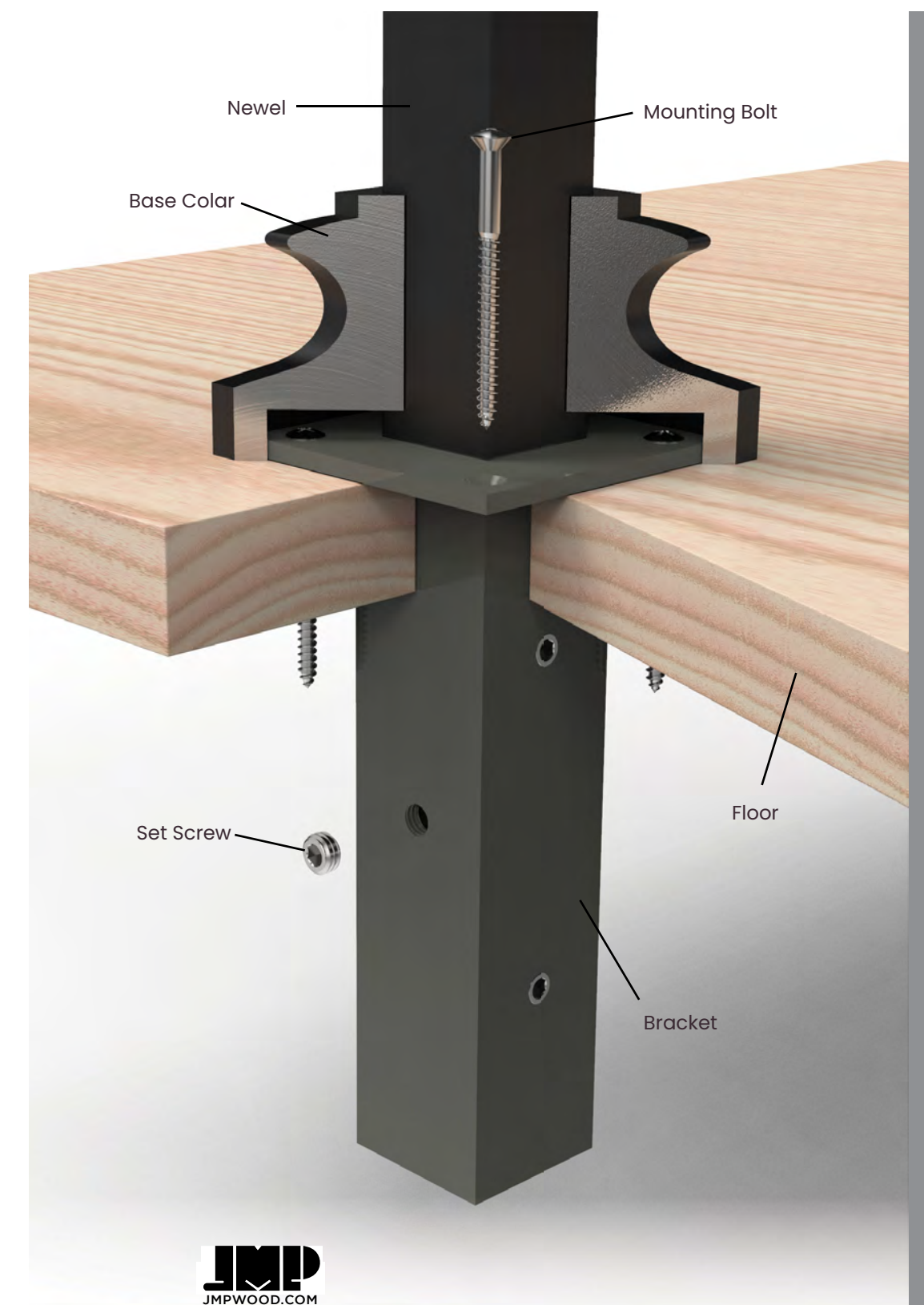

Newel

Mounting Bolt

Base Collar

Set Screw

Floor

Bracket



Lineals | Handrail Profiles

6010 Profile

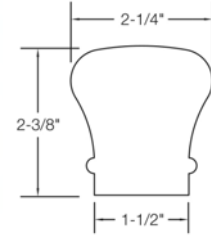
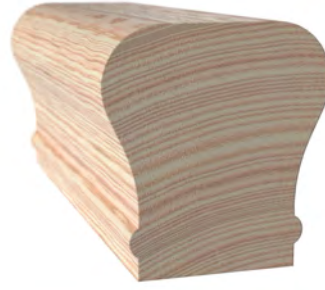

Available Lengths :
8', 12', 14', 16'
 Species :
RO, WO
 With Plow :
1 1/4"

6210 Profile

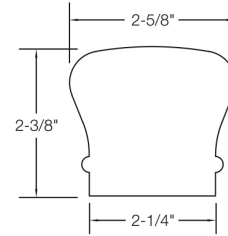
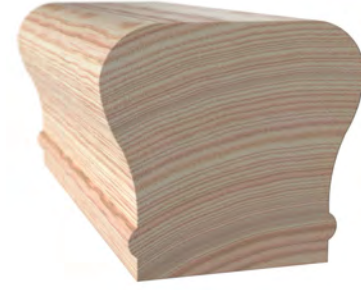

Available Lengths:
8', 12', 14', 16'
 Species :
RO, WO
 With Plow :
1 3/4"

6510 Profile

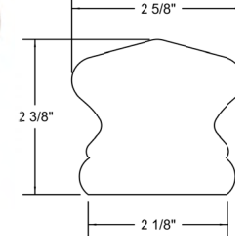

Available Lengths :
8', 12', 14', 16'
 Species :
RO, WO
 With Plow :
1 1/4"

6710 Profile

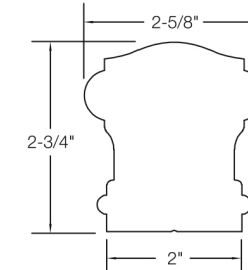

Available Lengths :
8', 12', 14', 16'
 Species :
RO, WO
 With Plow :
1 3/4"

8200 Profile

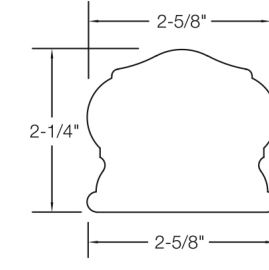

Available Lengths:
8', 12', 14', 16'
 Species :
RO, WO
 With Plow :
N/A

6040 Profile

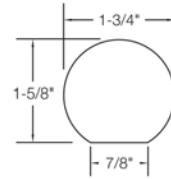

Available Lengths :
8', 12', 14', 16'
 Species :
RO, WO
 With Plow :
N/A

6000-6002 Profile

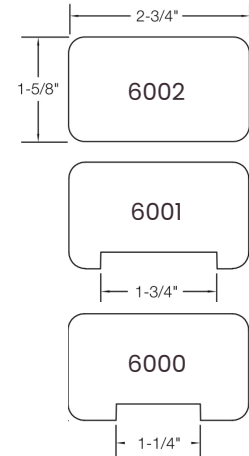

Available Lengths:
8', 12', 14', 16'
 Species :
RO, WO

6084 Profile

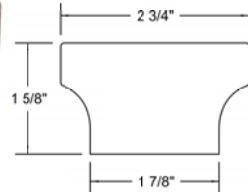

Available Lengths :
8', 12', 14', 16'
 Species :
RO, WO
 With Plow :
N/A

8500 Profile

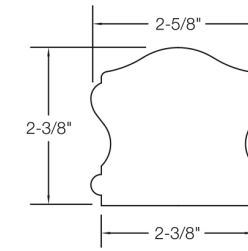

Available Lengths :
8', 12', 14', 16'
 Species :
RO, WO
 With Plow :
1 3/4"

9200 Profile

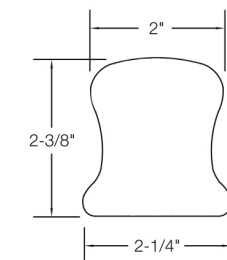

Available Lengths:
8', 12', 14', 16'
 Species :
RO, WO
 With Plow :
1 3/4"

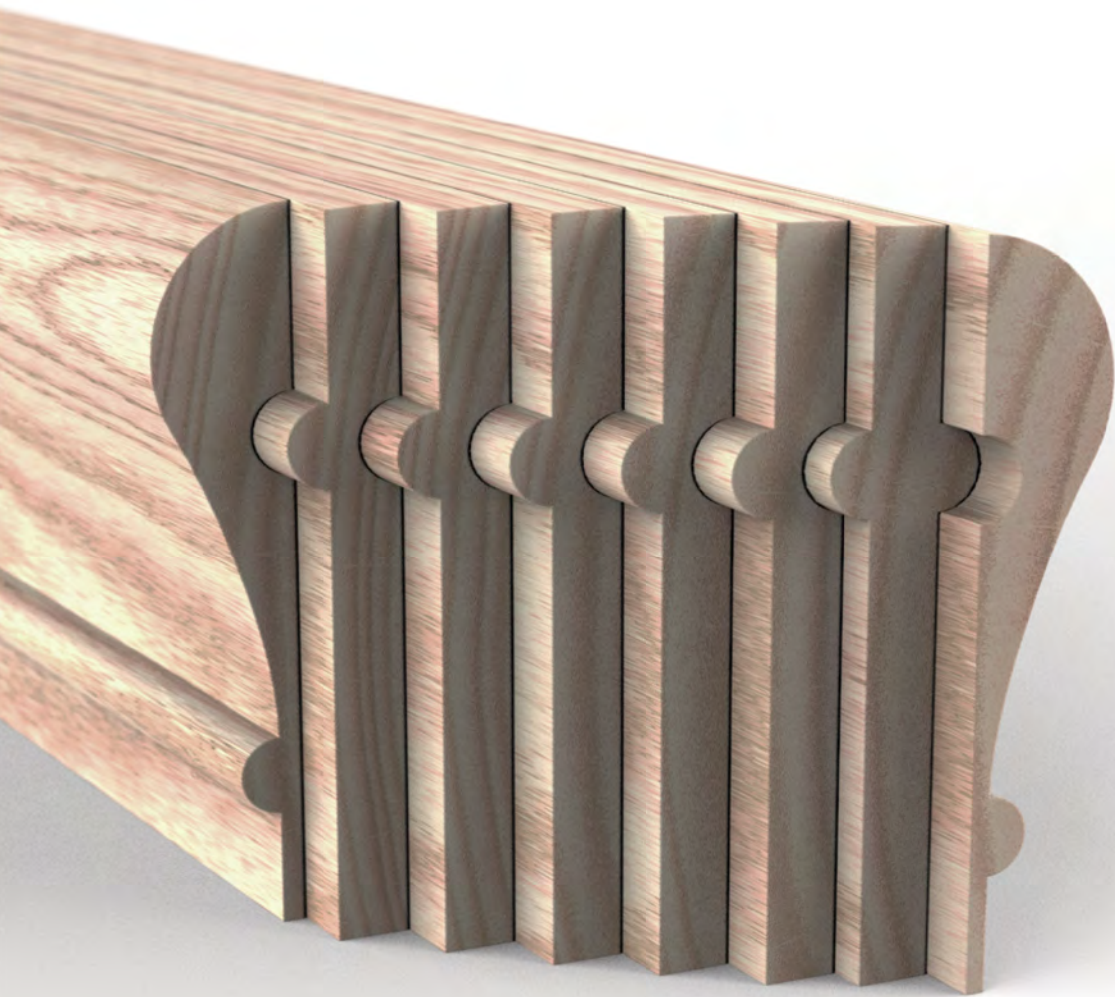

6010B Profile

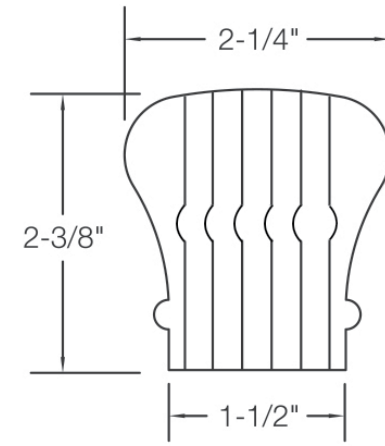

Available Lengths:
8', 16'
Species :
RO, WO, MAP, POP

8000B Profile

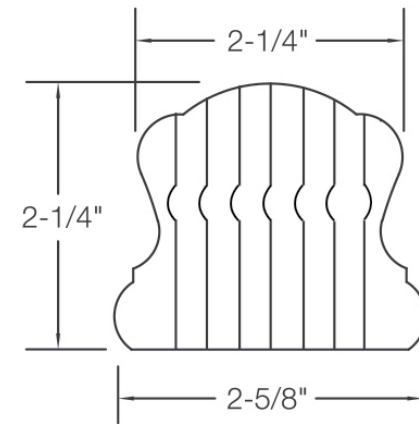

Available Lengths:
8', 16'
Species :
RO, WO

6210B Profile

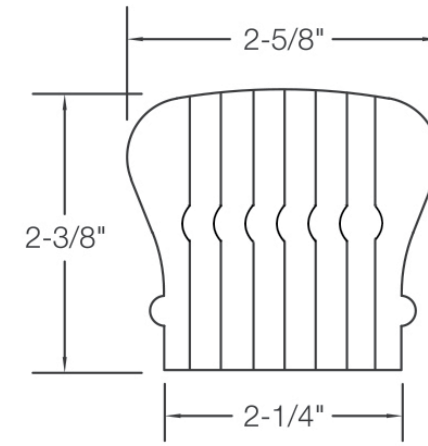

Available Lengths:
8', 16'
Species :
RO, WO

8200B Profile

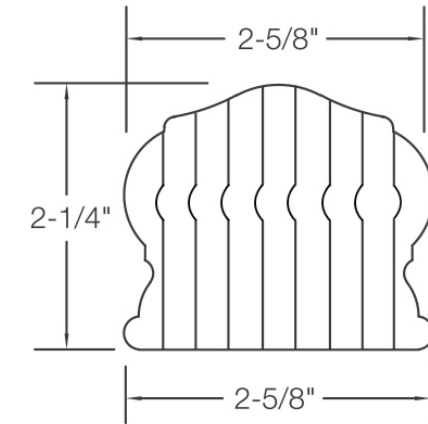

Available Lengths:
8', 16'
Species :
RO, WO, MAP, POP,

6710B Profile

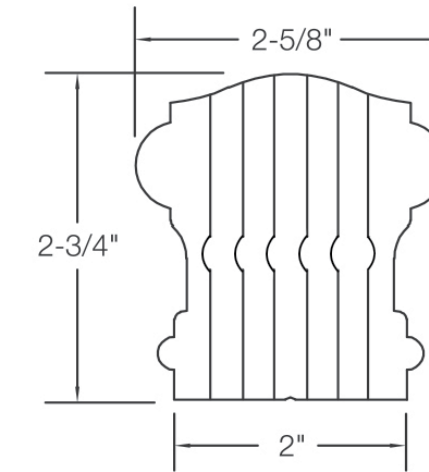

Available Lengths:
8', 16'
Species :
RO, WO

8500B Profile

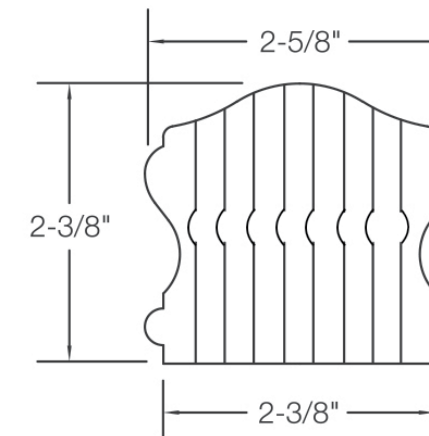

Available Lengths:
8', 16'
Species :
RO, WO

Bending Channels

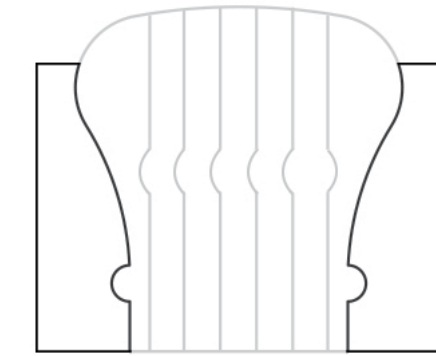

Bending Channels can be provided for any profile upon your request.

9200B Profile

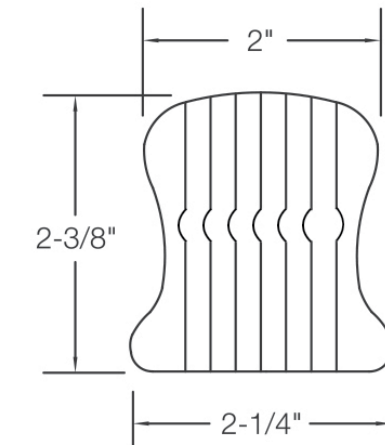

Available Lengths:
8', 16'
Species :
RO, WO, MAP, POP

Handrails | Fittings



POPLAR

“POP”



RED OAK

“RO”



MAPEL

“MAP”



CHERRY

“CHR”



WHITE OAK

“WO”

Fitting 09 Return End



Profiles :

- 7009
- 7209
- 7709
- 8009
- 8209
- 8509
- 9209

Species :
RO, WO, MAP, POP, CHR

Fitting 10 Starting Easing Cap



Profiles :

- 7010
- 7210
- 7710
- 8010
- 8210
- 8510
- 9210

Species :
RO, WO, MAP, POP, CHR

Fitting 11 Level Quarter Turn



Profiles :

- 7011
- 7211
- 7711
- 8011
- 8211
- 8511
- 9211

Species :
RO, WO, MAP, POP, CHR

Fitting 11-135 Level Turn 135°



Profiles :

- 7011-135
- 9211-135

Species :
RO, MAP, POP, CHR

Fitting 12 Up Easing



Profiles :

- 7012
- 7212
- 7712
- 8012
- 8212
- 8512
- 9212

Species :
RO, WO, MAP, POP, CHR

Fitting 13 Over Easing



Profiles :

- 7013
- 7213
- 7713
- 8013
- 8213
- 8513
- 9213

Species :
RO, WO, MAP, POP, CHR

Fitting 14 Up Easing 90°



Profiles :

- 7014
- 7214
- 7714
- 8014
- 8214
- 8514
- 9214

Species :
RO, WO, MAP, POP, CHR

Fitting 15 S Turn Left Hand



Profiles :

- 7015LH
- 9215LH

Species :
RO, MAP, POP, CHR

Fitting 15 S Turn Right Hand



Profiles :

- 7015RH
- 9215RH

Species :
RO, MAP, POP, CHR

Fitting 19 Opening Cap



Profiles :

- 7019
- 7219
- 8019
- 8219
- 8519
- 9219

Species :
RO, WO, MAP, POP, CHR

Fitting 20 Tandem Cap



Profiles :

- 7020
- 7220
- 7720
- 8020
- 8220
- 8520
- 9220

Species :
RO, WO, MAP, POP, CHR

Fitting 21 Level Quarter Turn Cap



Profiles :

- 7021
- 7221
- 7721
- 8021
- 8221
- 8521
- 9221

Species :
RO, WO, MAP, POP, CHR

Fitting 21-135 Level Turn 135° Cap



Profiles :

- 7021-135
- 8221-135
- 8521-135
- 9221-135

Species :
RO, MAP, POP, CHR

Fitting 30 Volute Left Hand



Profiles :

- 7030
- 7230
- 7730
- 8030
- 8230
- 8530
- 9230

Species :
RO, WO, MAP, POP, CHR

Profiles :

- 7035
- 7235
- 7735
- 8035
- 8235
- 8535
- 9235

Species :
RO, WO, MAP, POP, CHR

Fitting 38 Vertical Volute



Profiles :

- 7038
- 9238

Species :
RO, MAP

Fitting 40 Large Turnout LH



Profiles :

- 7040
- 7240
- 7740
- 8240
- 8540
- 9240

Species :
RO, WO, MAP, POP, CHR

Fitting 41 Small Turnout LH



Profiles :

- 7041
- 7241
- 7741
- 8541
- 9241

Species :
RO, MAP, POP, CHR

Fitting 45 Large Turnout RH



Profiles :

- 7045
- 7245
- 7745
- 8245
- 8545
- 9245

Species :
RO, WO, MAP, POP, CHR

Fitting 46 Small Turnout RH



Profiles :

- 7046
- 7246
- 7746
- 8546
- 9246

Species :
RO, MAP, POP, CHR

Handrails | Fittings

Gooseneck

Fitting 50 Quarter Turn GN LH

Profiles :
 - 7050



Species :
RO, POP

Fitting 55 Quarter Turn GN RH

Profiles :
 - 7055



Species :
RO, POP

Fitting 60 Quarter Turn Cap GN LH

Profiles :
 - 7060



Species :
RO

Fitting 65 Quarter Turn Cap GN RH

Profiles :
 - 7065



Species :
RO



Fitting 70 Quarter Turn GN LH

Profiles :
 - 7070



Species :
RO



Fitting 88 Cap Over Easing 90°

Profiles :
 - 7088
 - 9288



Species :
RO, MAP, CHY

Fitting 88-2 Straight Riser Tandem

Profiles :
 - 7088-2
 - 9288-2



Species :
RO, MAP, POP, CHY

Fitting 90 Landing Return LH

Profiles :
 - 7090



Species :
RO

Fitting 90-2 Landing Return LH

Profiles :
 - 7090-2



Species :
RO



Fitting 95 Landing Return LH

Profiles :
 - 7095



Species :
RO

Fitting 71 Quarter Turn GN LH

Profiles :
 - 7071
 - 9271



Species :
RO, POP, MAP, CHR



Fitting 75 Quarter Turn GN RH

Profiles :
 - 7075



Species :
RO



Fitting 76 Quarter Turn GN RH

Profiles :
 - 7076
 - 9276



Species :
RO, MAP, CHR



Fitting 81 Quarter Turn Cap GN LH

Profiles :
 - 7081
 - 9281



Species :
RO, POP, MAP, CHR

Fitting 86 Quarter Turn Cap GN RH

Profiles :
 - 7086
 - 9286



Species :
RO, POP, MAP, CHR

Fitting 95-2 Landing Return RH

Profiles :
 - 7095-2



Species :
RO

Fitting 97 Straight Riser Cap

Profiles :
 - 7097



Species :
RO



Fitting 98 Straight Riser

Profiles :
 - 7098



Species :
RO

Fitting 99 Straight Riser

Profiles :
 - 7099
 - 7299
 - 9299



Species :
RO, MAP, POP, CHY



S4S Yellow Pine

Available Lengths :
12', 14', 16'

Available Widths :
11 1/4"

Available Thickness :
1 3/4", 1"

S4S Poplar

Available Lengths :
12', 14', 16'

Available Widths :
9 1/4", 11 1/4"

Available Thickness :
1 1/16"

S4S Red Oak

Available Lengths :
12', 14', 16'

Available Widths :
9 1/4", 11 1/4"

Available Thickness :
1 1/16"

S4S White Oak

Available Lengths :
12', 14', 16'

Available Widths :
9 1/4", 11 1/4"

Available Thickness :
1 1/16"



S4S Yellow Pine Stepping

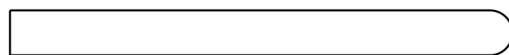

Dimension:
11 1/4" x 1"

If the lengths and widths you require are not represented, please call for a quote.

718.303.7777

S4S Primed

Available Lengths :
12', 14', 16'

Available Widths :
9 1/4", 11 1/4"

Available Thickness :
1 1/16", 3/4"

S4S LVL

Available Lengths :
16', 18'

Available Widths :
9 1/4", 11 1/4"

Available Thickness :
1 3/4"

Custom Cut Stringers

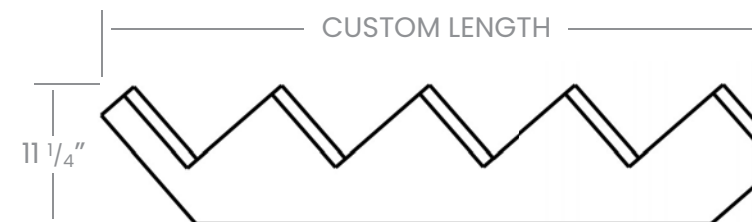
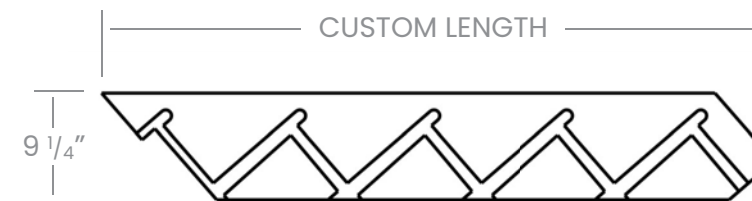

Available Species :
RO, POP, WO



Lineals | Shoe Rails

6005 Profile

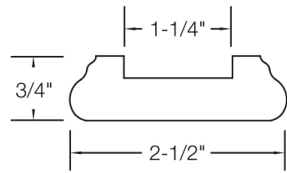

Available Lengths:
8', 12', 16'
Species :
RO, MAP, POP
With Plow :
1 1/4"

Compatible Fillets:
5048, 5100

6007 Profile

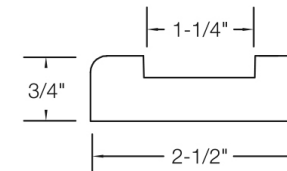

Available Lengths:
8', 12', 16'
Species :
RO, MAP, POP
With Plow :
1 1/4"

Compatible Fillets:
5048, 5100

6006 Profile

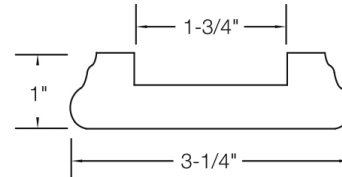

Available Lengths:
8', 12', 16'
Species :
RO, MAP, POP
With Plow :
1 3/4"

Compatible Fillets:
5008

6008 Profile

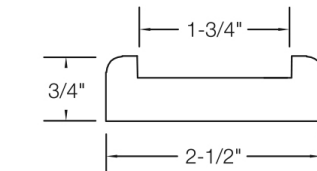

Available Lengths:
8', 12', 16'
Species :
RO, MAP, POP
With Plow :
1 3/4"

Compatible Fillets:
5048

Fillets

5008 Profile

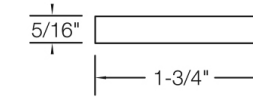

Available Lengths:
Random
Species :
RO, MAP, POP

5048 Profile

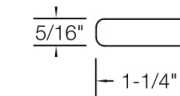

Available Lengths:
Random
Species :
RO, WO, MAP, POP

5100 Profile

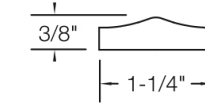

Available Lengths:
Random
Species :
RO, MAP, POP



8093 Profile

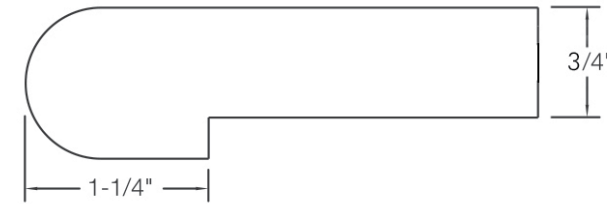

1 1/32" x 3 1/2"
 Available Lengths:
8', 12', 14', 16'
 Species :
RO, WO, MAP, POP

8095 Profile

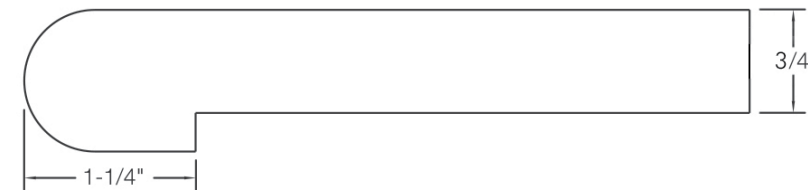

1 1/32" x 5 1/2"
 Available Lengths:
8', 12', 14', 16'
 Species :
RO, WO, MAP, POP, CHR

Bending Nosing

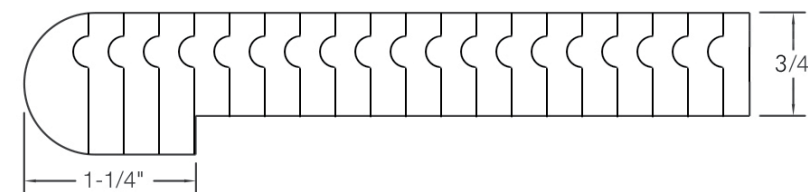

1 1/32" x 5 1/2"
 Available Lengths:
8', 12', 14', 16'
 Species :
RO, WO

7055 Cove Moulding

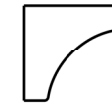

3/4" x 3/4"
 Species :
RO, MAP, POP

7028 Cove Moulding



1/2" x 3/4"
 Species :
RO, MAP, POP

7008



13/16" x 5/8"
 Species :
RO, MAP, POP

All mouldings come at a set length of **24"**
 For more lengths, please call for pricing.

718.303.7777

7009

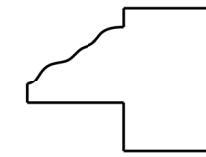

1 1/2" x 1 1/8"
 Species :
RO, MAP, POP

7010



5/8" x 1 1/8"
 Species :
RO, MAP, POP

7012

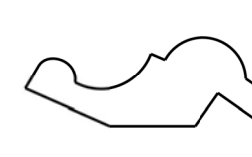

1 15/16" x 1 1/16"
 Species :
RO, MAP, POP

7029



1 3/4" x 1 5/16"
 Species :
RO, MAP, POP

7029-GR

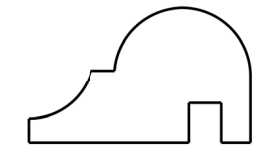

1 3/4" x 1 1/16"
 Species :
RO, MAP, POP

7075

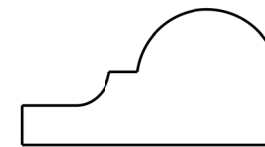

2" x 1 1/16"
 Species :
RO, MAP, POP

7075-G

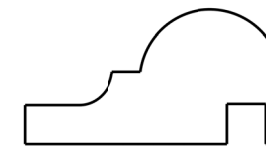

2" x 1 1/16"
 Species :
RO, MAP, POP

7079



1 1/4" x 3/4"
 Species :
RO, MAP, POP

7080



1 1/4" x 3/4"
 Species :
RO, MAP, POP

7173

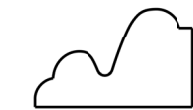

1 1/4" x 3/4"
 Species :
RO, MAP, POP

Treads and Risers | Treads

8070 Straight Tread



Available Lengths:
36", 42", 48", 54", 60", 72"
 Species :
RO, WO, POP, MAP

8070MTRLH Return Tread Left Handed

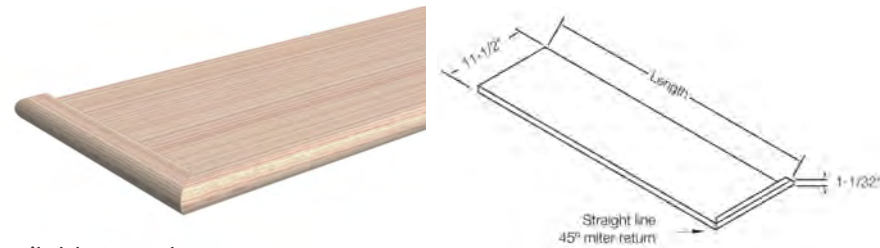

Available Lengths:
42", 48", 54", 60", 72"
 Species :
RO, WO, POP, MAP

8110 Starting Step W/ 1 End



Available Lengths:
48", 60", 72"
 Species :
RO, WO, MAP

Please specify whether it is **left** or **right**.

8070REV Reversible Mitered Return Tread

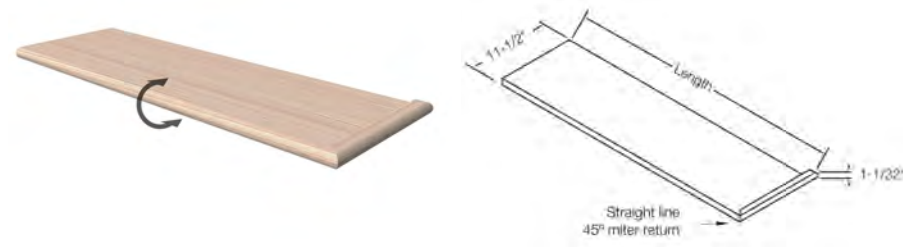

Available Lengths:
42"
 Species :
RO

8070MTRRH Return Tread Right Handed

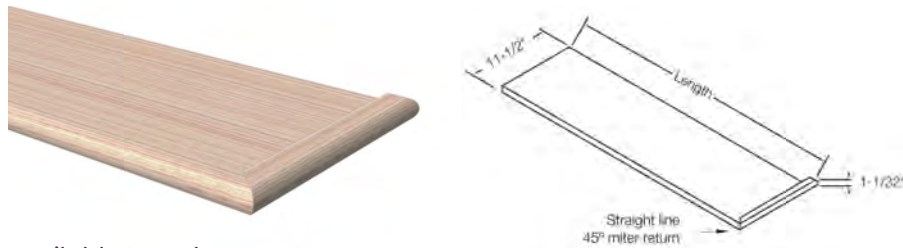

Available Lengths:
42", 48", 54", 60", 72"
 Species :
RO, WO, POP, MAP

8112 Starting Step W/ 2 Ends



Available Lengths:
48", 54", 60", 72"
 Species :
RO, MAP



Qwik Treads

QT48-72 Qwik Tread Straight Ends



Available Lengths:
42", 72"
 Species :
RO

QT48MR-72MR Qwik Tread Return Ends



Available Lengths:
42", 72"
 Species :
RO

QT48LAND-72LAND Qwik Tread Landing Kit

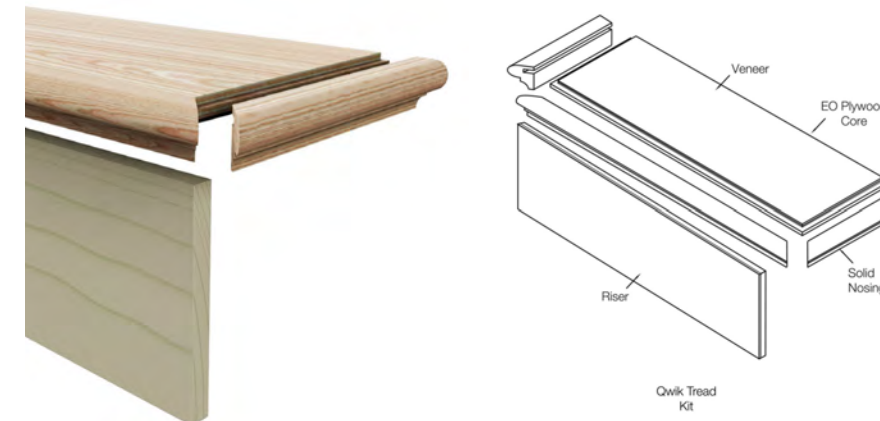

Available Lengths:
48" x 48", 72" x 72"
 Species :
RO



Treads and Risers | False Treads and Risers

8271 False Universal Mitered Tread Cap



Species :
RO, MAP, CHR

8171LH False Mitered Tread Cap Left Handed



Species :
RO, MAP, POP

8110-2 False Starting Step Moulding

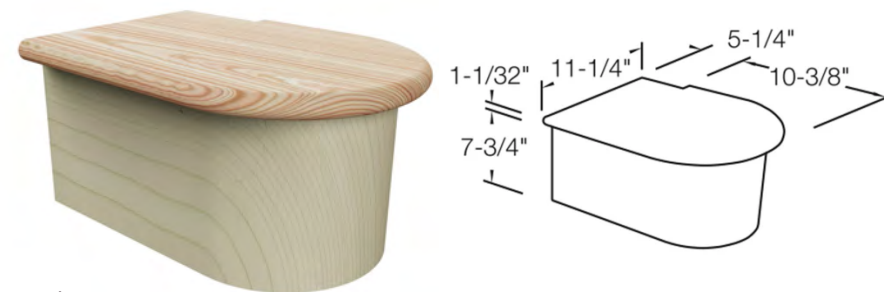

Species :
RO, WO

8172 False Wall Tread

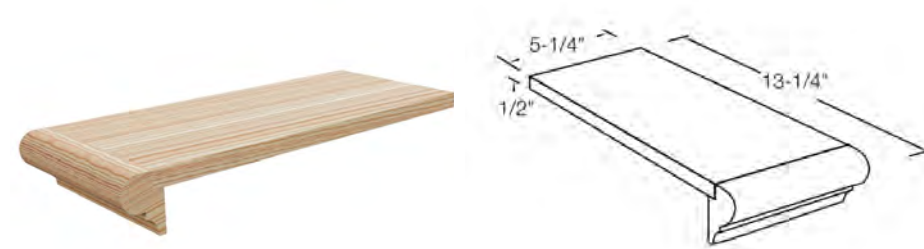

Species :
RO, MAP, CHR

8171RH False Mitered Tread Cap Right Handed



Species :
RO, MAP, POP

Risers

8078 Straight Riser

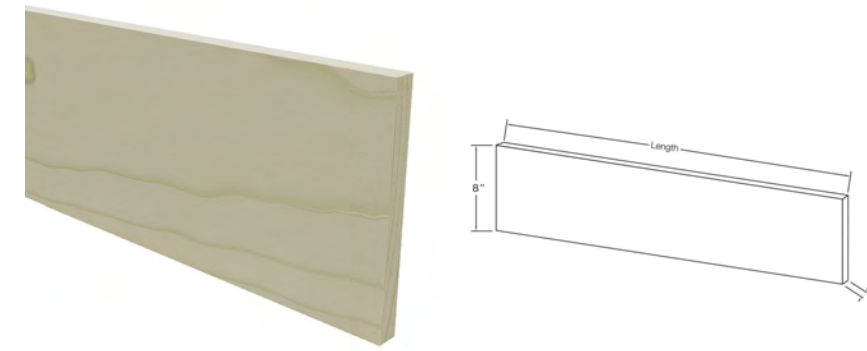

$\frac{3}{4}$ " x $7\frac{1}{2}$ " x ~
Available in length:
36", 42", 48", 54", 60", 72"
Species :
RO, WO, POP, MAP

QWIK TREAD RISER Primed 1-S

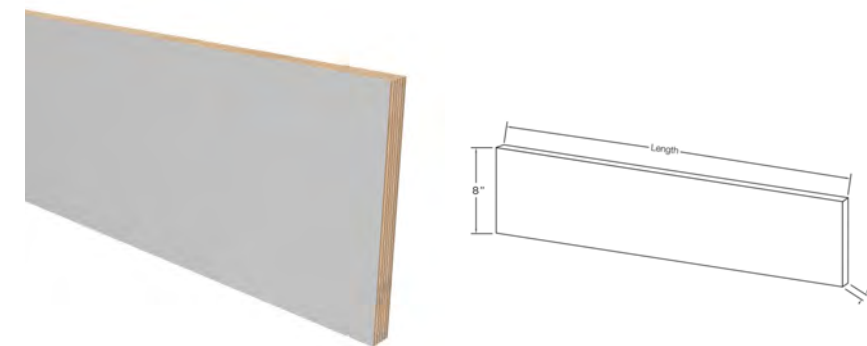

Available Lengths:
48", 72"
Finish:
PR

8176 False Riser Cap

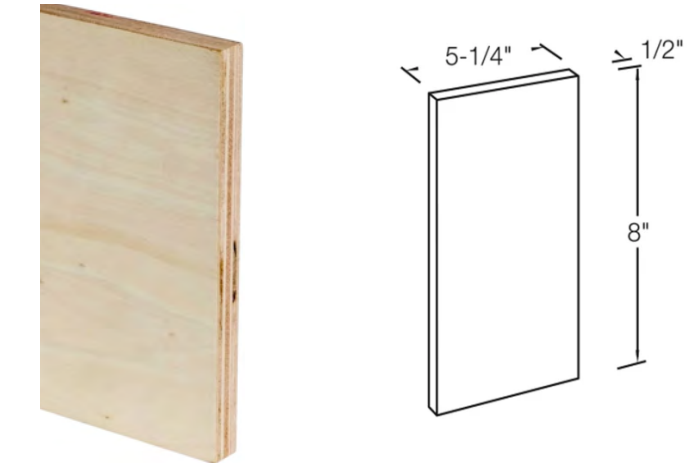

Species :
RO, POP, MAP, CHR

Accessories | Hand Rail Brackets and Rosettes

Finishes

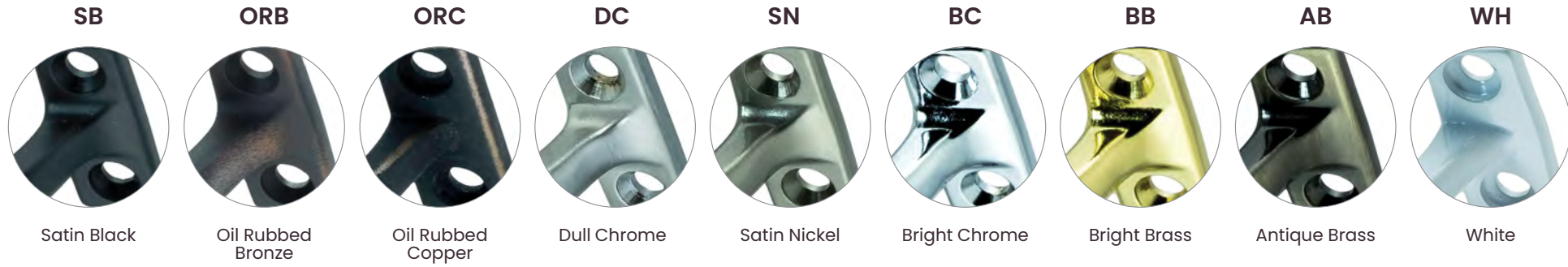

3003 Handrail Bracket Zinc Alloy 2 3/4"

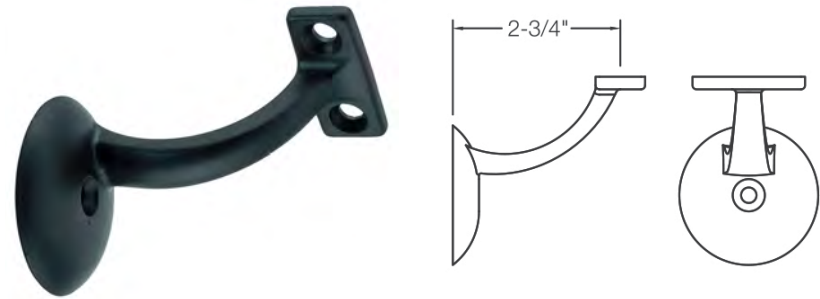

Finishes :
SB, ORB, ORC, DC, SN, BC, BB, AB, WH

3003LA Handrail Bracket Zinc Alloy 3 1/8"

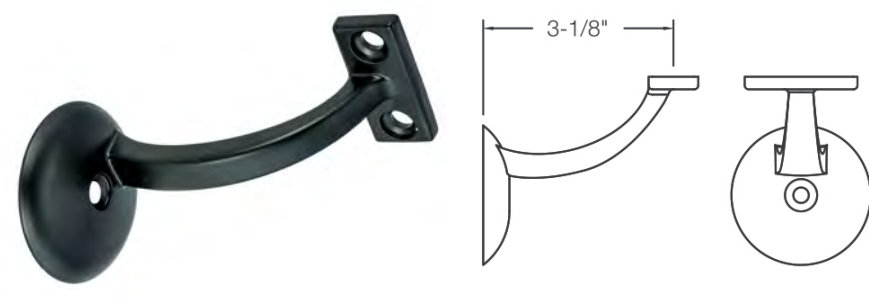

Finishes :
SB, ORB, DC, SN

3002HD Handrail Bracket Zinc Alloy 2 3/8"

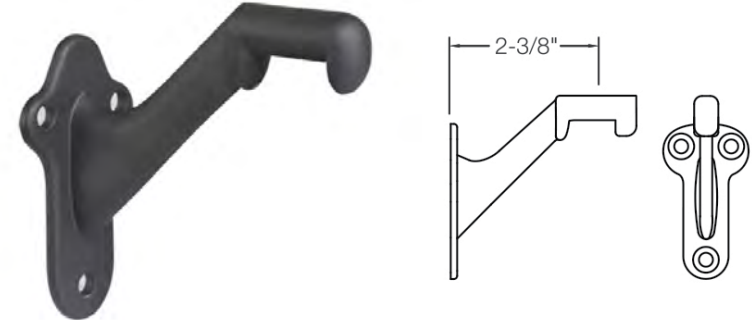

Finishes :
SB, ORB, DC, SN, BC, BB, AB, WH

3004 Handrail Bracket Solid Brass 2 3/4"

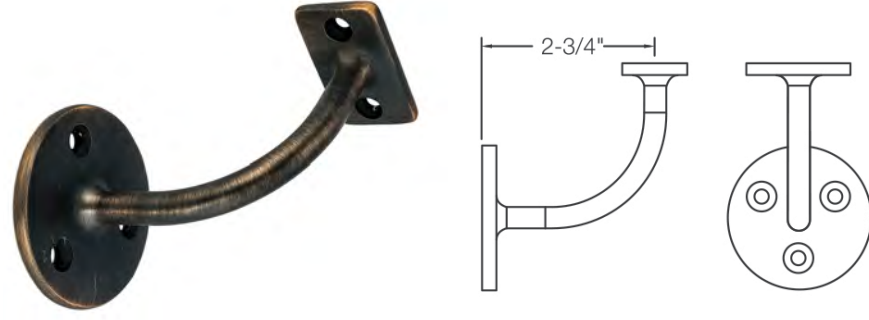

Finishes :
ORB, ORC, DC, BC, BB,

Rosettes

202 Round Rosette

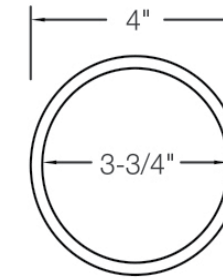

Species:
RO, MAP, POP

210 Oval Rosette

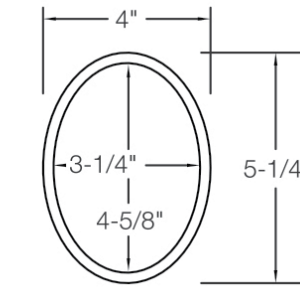

Species:
RO, WO, MAP, POP, CHR

220 Rectangular Rosette

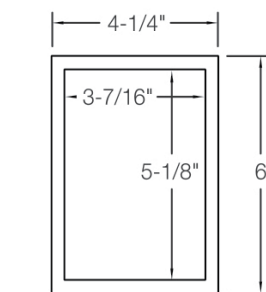

Species:
RO, MAP, POP

Tread Bracket

7029 Scroll Bracket

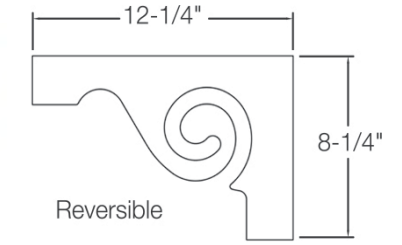

Species:
RO, POP

7039 Scroll Bracket

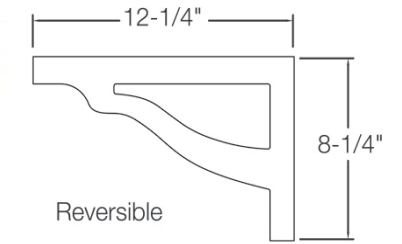

Species:
RO, POP

7049 Scroll Bracket

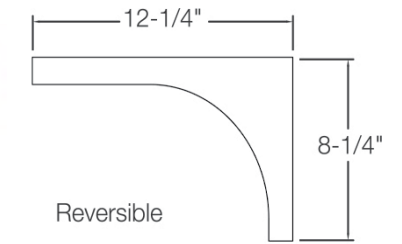

Species:
RO, POP

Tools and Hardware

Tools

DSD14 1/4" Dowel Screw Driver



DSD516 5/16" Dowel Screw Driver



HBD516 5/16" Hanger Bolt Driver



2900 Rail Bolt Wrench



Hardware

Dowel Screw



Product Specs:

DS1425 - 1/4" x 2 1/2"
DS51625 - 5/16" x 2 1/2"
DS1270 - 1/2" x 7"

Hanger Screw



Product Specs:

HB516250 - 5/16" x 2 1/2"
HB516350 - 5/16" x 3 1/2"
HB516450 - 5/16" x 4 1/2"
HB51650 - 5/16" x 5"
HB51660 - 5/16" x 6"

Rail Bolt



Product Specs:

RB5135 - 5/16" x 3 1/2"
RB51650 - 5/16" x 5"

2811 Curved Plastic Washer



Product Specs:
 5/16" Hole

Rail Bolt 5/16" Flange Nut



RBKIT Rail Bolt Kit



Product Specs:
 Bolt, Washer, Nut, Plug

1/2" Flat Tapered Face Grain



Available Species:
 RO, WO, POP

1" Flat Tapered Face Grain



Available Species:
 RO, WO, MAP, POP, CHR

5/8" Flat Tapered Face Grain



Available Species:
 RO, MAP, POP, CHR

EZ-Pin Dowels for Balusters (Poplar)



D: 1/4", 3/4"
 L: 1 3/4"

Available Quantities:
 10, 25, 50, 100

Adhesives & Finishing

Titebond™ Original Wood Glue



Available Volumes:
 16 oz. , 1 gal.

PC Super Epoxy Gun



PC Super Epoxy Refills



Available Volumes:
 50 ml.

Famowood™ Water Based Wood Filler



Available Volumes:
 24 oz.

Mounting Kits

3009-3011 Post Mounting Kits



Colonial Profile PMK:



Available Sizes & Species:

3009 - 3" in RO, MAP, POP, CHR
3010 - 3 1/2" in RO, MAP, POP, CHR
3011 - 5" in RO, MAP, POP

Newel Plate Fastener



Key Lock Newel Fastener



Big Bolt Newel Fastener



Product Specs:
 RO, MAP Plugs

Frequently Asked Questions

What wood do you recommend?

We recommend poplar/maple if you are painting and red/white oak if you are staining. Sapele for a darker, natural finish.

I am building my stair outdoors...

For outdoor we recommend sapele and cedar. Please state on your order that the parts you are purchasing are for outdoor purposes.

Do you install?

No, we do not install. We manufacture and supply both standard and custom stair parts for contractors and homeowners.

Can you recommend someone that can install?

Unfortunately we can not recommend any installer due to fair competition.

Can it be shipped?

All of our products can be shipped via boxes or freight to all 48 states (Alaska and Hawaii, extra fees may apply). Shipping time and cost may vary depending on location, as well as size and weight of the product.

Still have questions?



Contact us:

E info@jmpwood.com

T 908.777.1567

T 718.303.7777

What is considered an oversized package?

Any order that exceeds 50 pounds or if the package dimension is over 95.5 inches.

The product arrived damage or incorrect.

Please refer to our terms and conditions for more details about our return policy.

Do you do site measurements?

Yes we do offer the service of measuring. The cost of the site measurements will depend on the project and location. To receive a quote, please email us information regarding your site address, job description along with pictures and drawings of site conditions.

What is the status of my order?

Due to the large amount of orders we can have at one time, it will be difficult for us to provide a status update for your order. To inquiry for an update, please email us at orders@jmpwood.com or call 718.303.7777

I am looking to get a quote on a custom order.

Please email as much information as possible about your order to custom@jmpwood.com. Please include your name and contact information and a detailed description of your project in order for us to get back to you.

Terms and Conditions

Pricing

- All items are priced per single piece or per linear feet unless otherwise specified.
- Bulk pricing available / wholesale
- All special sales, discounted rates or VIP pricing can not be combined and can only be applied a single time per an order. Any discounted rates are not applicable to any custom orders.
- For pallet pricing, please contact us for availability and shipping rates.
- There is no minimum order quantity, but there is a set minimum cost of shipping and handling may be applicable.
- All pricing and product availability are subject to change without notice. Please visit our website for up-to-date pricing or contact us at info@jmpwood.com

Delivery

- JMPWOOD holds no responsibility if a client (buyer) is absent or fails to receive delivery via a third party at a scheduled time window and may be subject to additional delivery fees for rescheduling.
- Any rescheduling for delivery must be notified at least 48 hours in advance to be honored.
- For local delivery, please contact us at info@jmpwood.com for availability and pricing.

Shipping & Lead Time

- If an item is in stock, the lead time is usually 1-3 business days. Any order placed after 12pm noon will be processed during the next business day.
- JMPWOOD ships to all 48 states (Hawaii and Alaska, extra fees may apply) and U.S. territories via LTL UPS Ground or USPS. Please contact us for details for international shipping.
- All items are shipped with a tracking number that will be emailed once the package has shipped.
- All freight and handling charges are subject to change without notice, as it is a third party service and JMPWOOD is not responsible.
- If you would like to expedite your order, please contact us at info@jmpwood.com
- Items over 8 feet will ship via LTL and may require extra charges
- Insurance can be purchased and is recommended especially on custom made to order items

Payment

- All purchase orders are paid in full unless specified otherwise.
- All purchase orders are subject to all taxes and shipping fees unless specified otherwise. Please provide us with any tax exemption prior to placing an order.
- In order to open an account with JMPWOOD, you first submit a credit application/credit approval and it may take up to 30-120 days for processing. JMPWOOD holds all rights to reject your application for line of credit without cause.
- A recurring service charge of 2% may be applied to outstanding balances past 30 days.
- Any payment process via credit card (VISA, MASTERCARD, AMERICAN EXPRESS, ETC) can be subjected to a processing fee up to 5% on invoice.
- There is an \$50 additional fee on any returned/bounded checks.

Returns

- Items must be in its original carton and deem in a resalable condition by JMPWOOD in order to be accepted for return.
- Any item that is cut, damaged, stained, painted or modified in anyway will not be accepted for returns.
- Any made-to-order parts are not eligible for returns. Any custom or made-to-order item can not be canceled once production has started.
- A 15%-25% restocking fee may apply on any returned products.

Incorrect Product or Damage Upon Arrival

- Any claim of damage on arrival must be noted on the bill of lading along with a signed damage report from the driver, in order for us to process your claim. All claims must be submitted within 24 hours of receiving the product. Please provide photographic evidence of damages to assist your claim.
- Any incorrect items or shortage of items, must be reported within 24 hours upon receiving the product shipment.
- JMPWOOD holds the claims to all damaged items or incorrect items and may ask for those specific items to be returned in arrived condition.

Nature of Wood Products

- There will be some unavoidable color and grain variation in items due to the unique nature of wood. Wood naturally expands and contracts due to changes in temperature and humidity. Because of this, it is perfectly normal for all wood products to possibly experience slight separation at wood joints or slight warping over time with changes in temperature/seasons. This does not affect the structural integrity of the stairs and rails. We take every precaution to minimize this, but a humidity control system may also be used in the home to further reduce the possibility of natural wood expansion and contraction. To further reduce the possibility of natural wood warping, splitting, contraction or expansion, we recommend finishing/sealing all sides of the stairs, including parts that are not visible. This forms a protective seal, making the wood less prone to expansion and contraction.

Copyright © 2020 JMPWOOD

All rights reserved. No part of this publication may be reproduced, distributed, or transmitted in any form or by any means, including photocopying, recording, or other electronic or mechanical methods, without the prior written permission by JMPWOOD without exception. In any legal action concerning copyright infringement, the prevailing party shall be entitled to recover reasonable attorney's fees and costs.



info@jmpwood.com

Copyright © 2020 JMPWOOD

All rights reserved. No part of this publication may be reproduced, distributed, or transmitted in any form or by any means, including photocopying, recording, or other electronic or mechanical methods, without the prior written permission by JMPWOOD without exception. In any legal action concerning copyright infringement, the prevailing party shall be entitled to recover reasonable attorney's fees and costs.