

# PATIO HEATER END PROFILES

## AIR INTAKE END

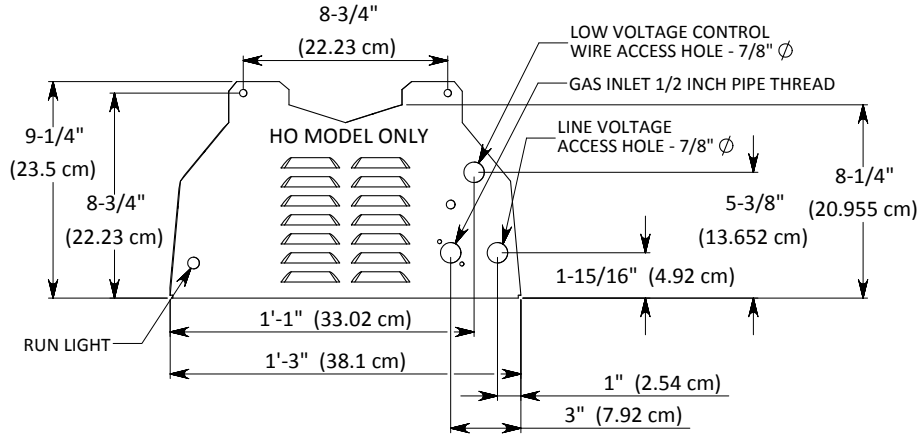

## EXHAUST END

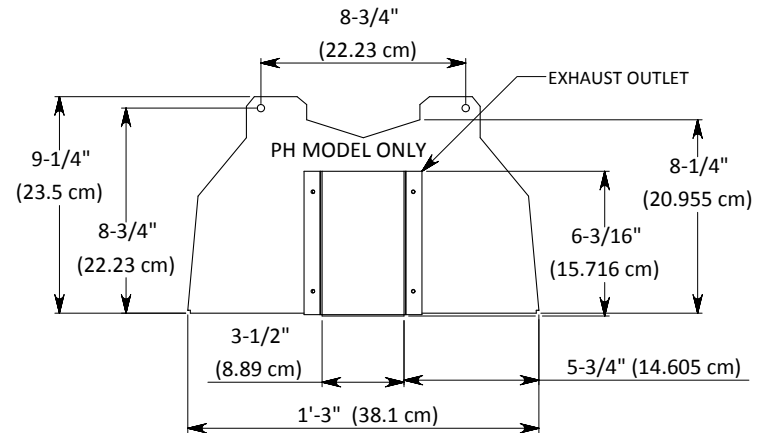
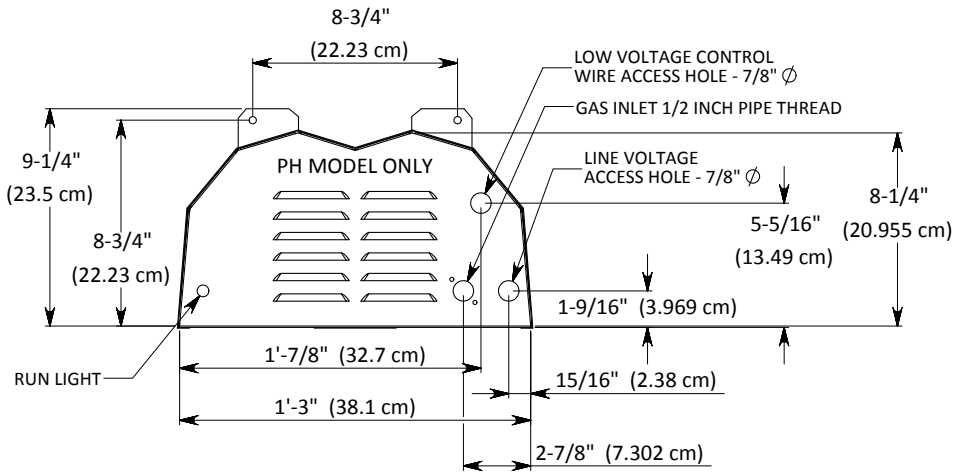
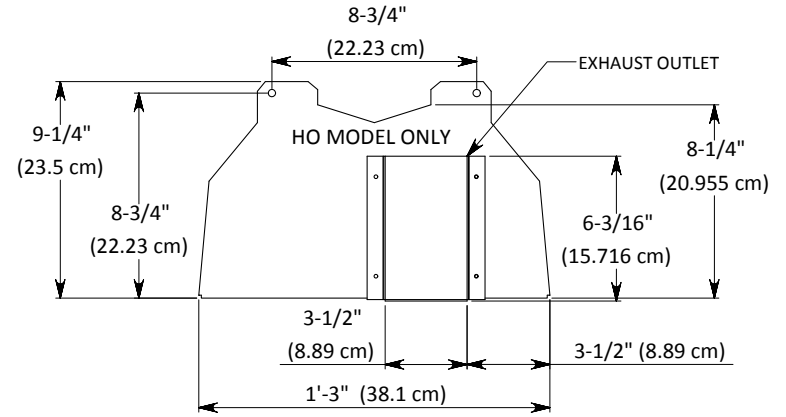

# PLAN VIEWS

AIR INTAKE END

EXHAUST END

**PH-40HO-5'**  
WEIGHT: 70 LBS

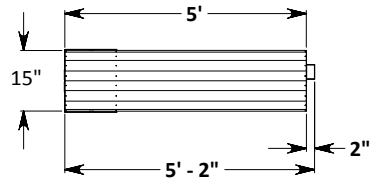

**PH-75HO-10'**  
WEIGHT: 120 LBS

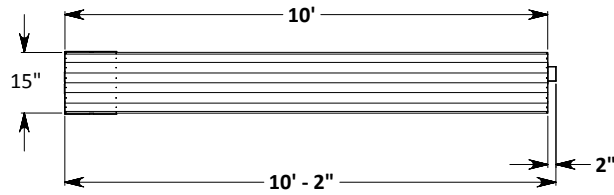

**PH-40-10'**  
WEIGHT: 70 LBS

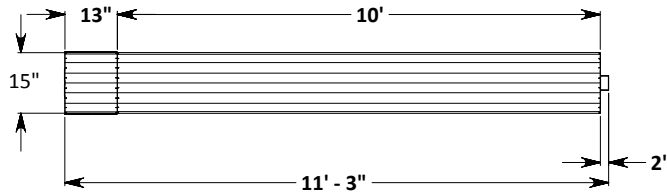

**PH-50-15'**  
WEIGHT: 95 LBS

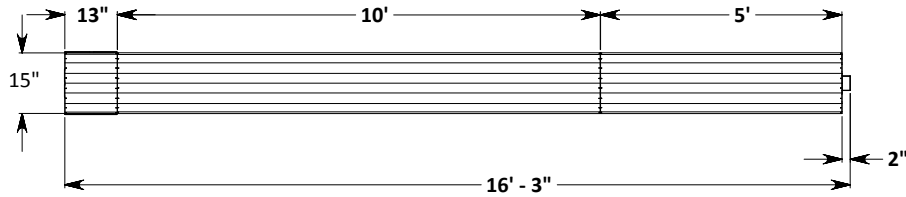

**PH-75-20'**  
WEIGHT: 110 LBS

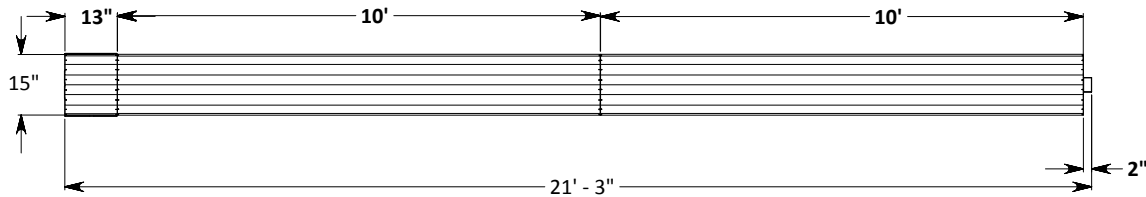

# SIDE VIEWS

AIR INTAKE  
END

EXHAUST END

**PH-40HO-5'**  
WEIGHT: 70 LBS

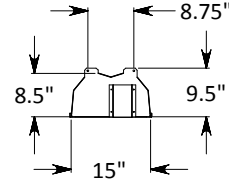
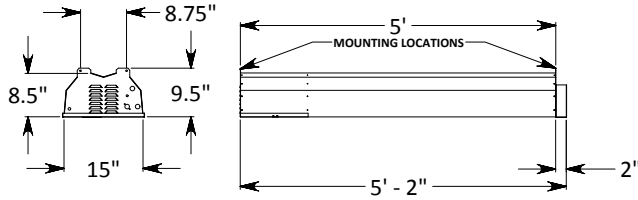

**PH-75HO-10'**  
WEIGHT: 120 LBS

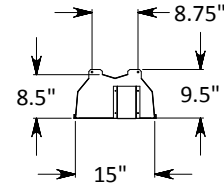
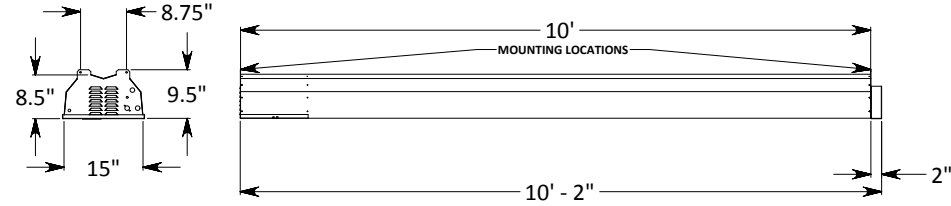

**PH-40-10'**  
WEIGHT: 70 LBS

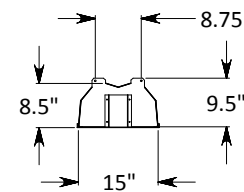
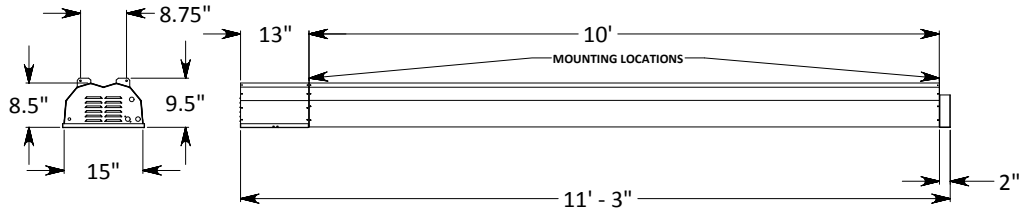

**PH-50-15'**  
WEIGHT: 95 LBS

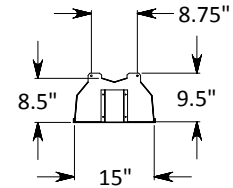
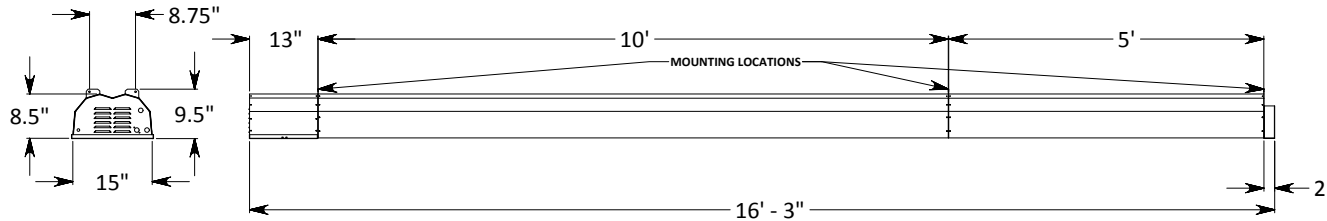

**PH-75-20'**  
WEIGHT: 110 LBS

