

# Firebox Collection

## 96" Firebox DS

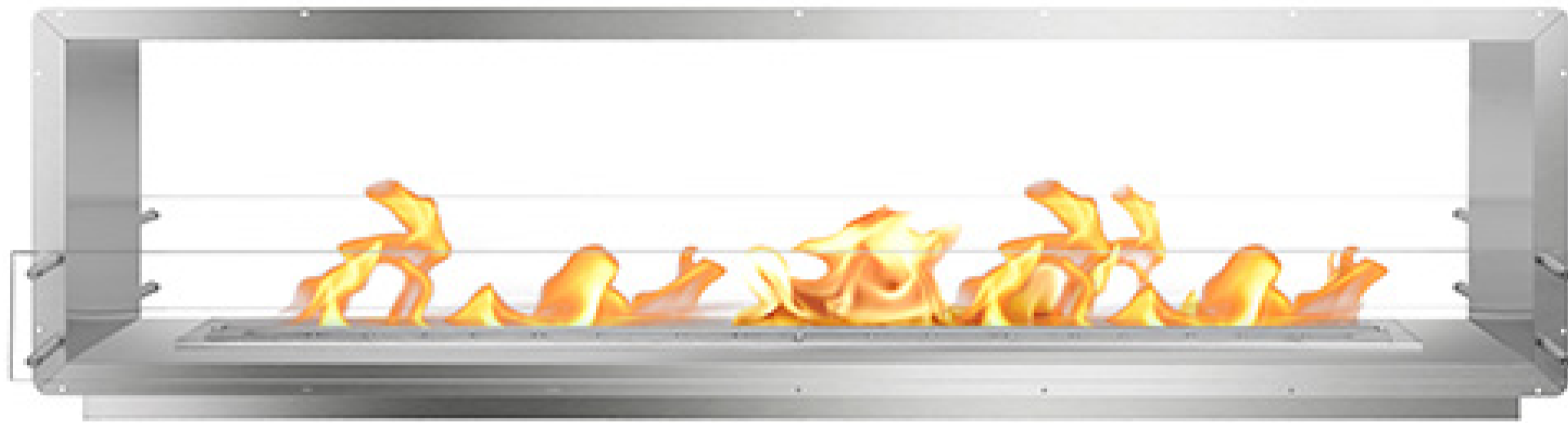

**Black**



### Included Accessories



**Lighting Rod**



**Lighter**



**Funnel**

# Firebox Collection

## 96" Firebox DS

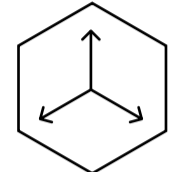
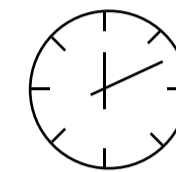
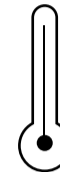
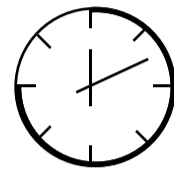
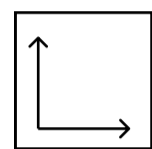
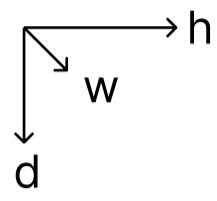

Dimensions H x W x D mm/in	Fuel Capacity	Heats on Average (indoors)	Fuel Consumption	Thermal Output Net (MAX)	Approx. Burn Time	Minimum Room Size (per burner)
686 × 2438 × 381 27.0 × 96.0 × 15.0	18L	Over 169m <sup>2</sup> [1,819 ft <sup>2</sup> ]	1.09L per hour	47,400 BTU/h 13.9 Kw	16 hours	400 sq. ft.

### Awards

2010 Winner Outdoor Hearth Products  
Vesta Awards

### Application

Indoor & Outdoor

### Burner Colour

● Stainless Steel ● Black

### Materials

Brushed Stainless Steel Internal Frame  
8mm Tempered Glass

### Burner Size

72" Burner

### Fuel Type

Bio Ethanol Fuel

### Other

- Double Walled Design
- Fully Insulated
- 304 Stainless Steel Firebox Construction

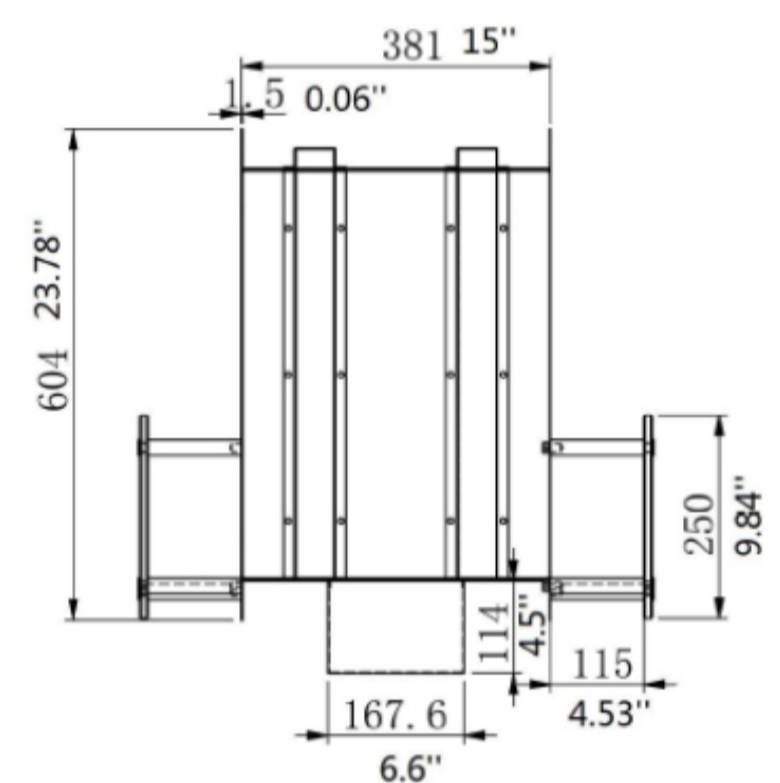

Global Compliance  
All burners are UL Listed in accordance with ANSI/UL1370 in the USA and comply with the ACCC Safety Mandate for Australia.



Lifetime Warranty

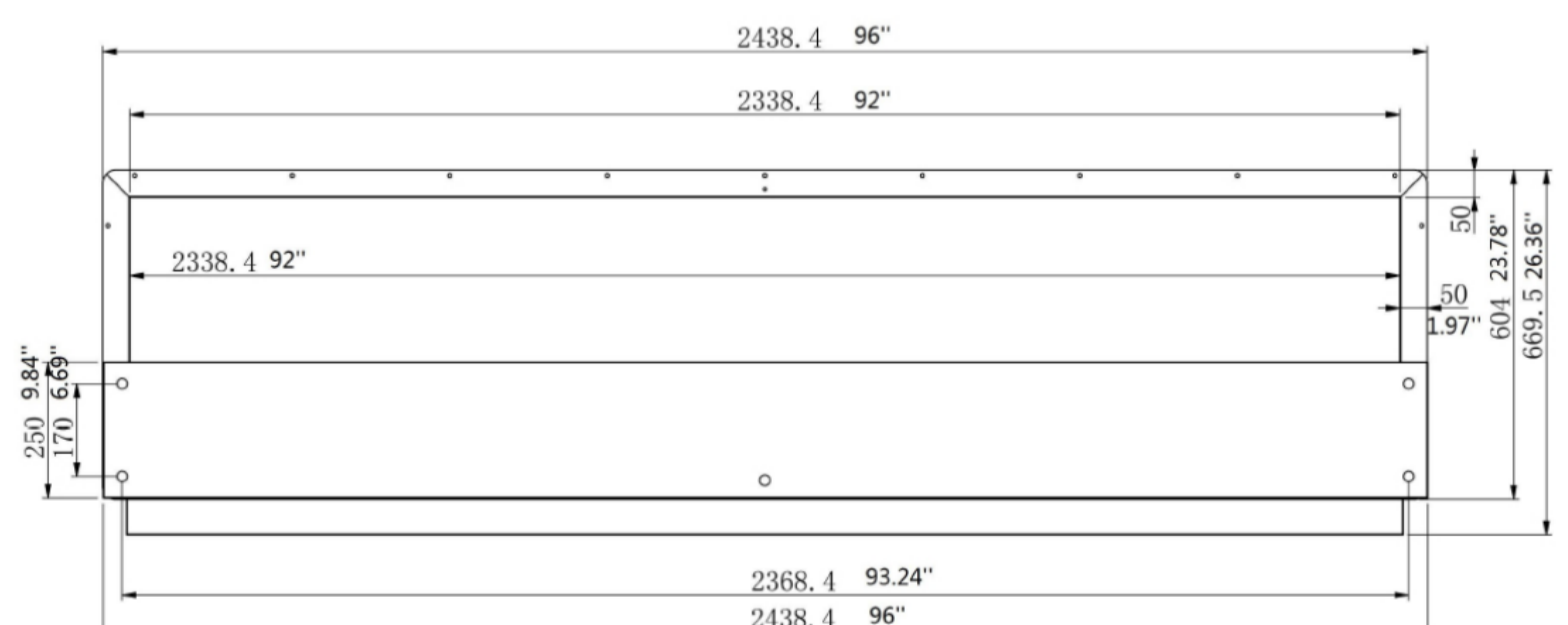

FOR MORE INFORMATION PLEASE REFERENCE THE CLEARANCE & INSTALLATION MANUAL

\*Dimensions may vary by 2% (plus or minus) due to material attributes. Template not provided. The Bio Flame recommends using the actual fireplace or burner model when making final cut out

