

CHESMONT SERIES ELECTRIC FIREPLACE MANTEL

Model # :

80033 – Chesmont White

80034 – Chesmont Black

OWNER'S MANUAL



AC 110-120V 60Hz 1500W

WARNING

Read and understand this entire owner's manual, including **all safety information**, before plugging in or **using** this product. Failure to do so could result in **fire, electric shock, or serious personal injury**.

CAUTION

Keep this owner's manual for future reference. If you sell or give this product away, **make sure this manual accompanies this product**.



**PREMIUM
ELECTRIC FIREPLACES
& TV LIFTS**

Exceeding Expectations



Table of Contents

Contents

General Information	5
<i>CSA Approval Listing Information</i>	5
<i>Fireplace Specifications</i>	5
<i>Dimensional Drawings</i>	6
Unpacking Your Fireplace	7
<i>Parts and Hardware</i>	7
Tools Required.....	7
What's in the Box	7
<i>Unpacking and Setup</i>	7
Testing the Fireplace Prior to Installation.....	8
3-prong Outlet Installation.....	8
Installation	9
<i>Choosing Installation Location</i>	9
Choosing Wall Location	9
<i>Removing The Wall Mount Bracket From Fireplace</i>	10
<i>Removing The Glass Panel and Install Media</i>	11
<i>Wall Mounted Installation</i>	13
Operating Fireplace	15
<i>Methods of Operation</i>	15
Control Panel and Remote Control Functions	16
<i>Remote Control Operation</i>	17
<i>Temperature Limiting Control</i>	17
Care and Maintenance	18
<i>Cleaning</i>	18
<i>Maintenance</i>	18
Warranty	Error! Bookmark not defined.

IMPORTANT SAFETY INFORMATION WARNING!

- **THIS FIREPLACE IS HOT WHEN IN OPERATION AND CAN CAUSE SEVERE BURNS**
- Do not operate fireplace before reading and understanding operating instructions. Failure to operate fireplace according to operating instructions could cause fire or injury.
- Risk of burns. This fireplace is HOT when in operation and heating element is ON. Power to the fireplace should be turned off and the fireplace allowed to cool before servicing. To disconnect power to the fireplace, turn controls to off, then remove plug from outlet.
- Do not install damaged, incomplete, or substitute components.
- Young children should be carefully supervised when they are in same room with fireplace. Toddlers, young children and others may be susceptible to accidental contact burns. A physical barrier is recommended if there are at risk individuals in the house. To restrict access to the fireplace, install an adjustable safety gate to keep toddlers, young children and other at risk individuals away from the fireplace and hot surfaces.
- Clothing and other flammable material should not be placed on or near the fireplace.
- Due to high temperatures, the fireplace should be located out of traffic and away from furniture and draperies.
- Ensure that you have incorporated adequate safety measures to protect infants/toddlers from touching hot surfaces.
- It is imperative that that the control compartments, circulating blower, and its passageway is the fireplace is kept clean.
- Under no circumstances should this fireplace be modified.
- Do not use the fireplace if any part has been under water.
- Do not operate the fireplace with the glass panel removed, cracked or broken.
- Keep the packaging material out of the reach of children. As with all plastic bags, these are not toys and should be kept away from children and infants.
- Servicing should only be done while the fireplace is disconnected from the power outlet.
- Unplug fireplace if not being used for an extended period of time.
- Do not operate this fireplace with a damaged cord or plug after the fireplace malfunctions, has been dropped, or damaged in any manner.
- Do not use outdoors.
- Never locate fireplace where it may fall into a bathtub or other water container.
- Do not run the cord under carpeting. Do not cover cord with throw rugs, runners, or the like. Arrange cord away from traffic area and where it will not be tripped over.
- Connect to properly grounded outlets only.
- Do not insert foreign objects into any ventilation or exhaust opening as this may cause and electric shock, fire, or damage to the fireplace.
- To prevent a possible fire, do not block the air intakes or exhaust in any manner. Do not use on soft surfaces, like a carpet, where openings may be blocked.
- Ensure clearances to combustibles are maintained when building a mantel or shelves above the fireplace. Elevated temperatures on the wall or in the air above the fireplace can cause melting, discoloration or damage to the decorations, a TV or other electronic components.

General Information

CSA Approval Listing Information

This fireplace has been tested in accordance with the CSA Standards for fixed and location-dedicated electric room appliances in the United States and Canada. If you need assistance during installation, please contact our technical support department at 800-215-1990 option 2.

Note: This fireplace must be electrically wired and grounded in accordance with local codes or, in the absence of local codes, with National Electric Code ANSI/NFPA 70-latest edition in the United States or the Canadian Electric Code, CSA C22.1 in Canada.

Fireplace Specifications

Model Number	80033	80034
Description	Chesmont White	Chesmont Black
Voltage	120v AC	120v AC
Watts	Max 1500W	Max 1500W
Amps	15 AMP Grounded Circuit	15 AMP Grounded Circuit
Fireplace Width	50"	50"
Fireplace Height	20 3/8"	20 3/8"
Fireplace Depth	7 1/8"	7 1/8"
Net Weight	60 lbs.	60 lbs.
Shipping Weight	78 lbs.	78 lbs.

Dimensional Drawings

80033/80034 – Dimensions

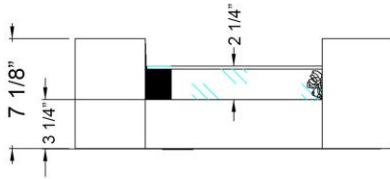

Side View

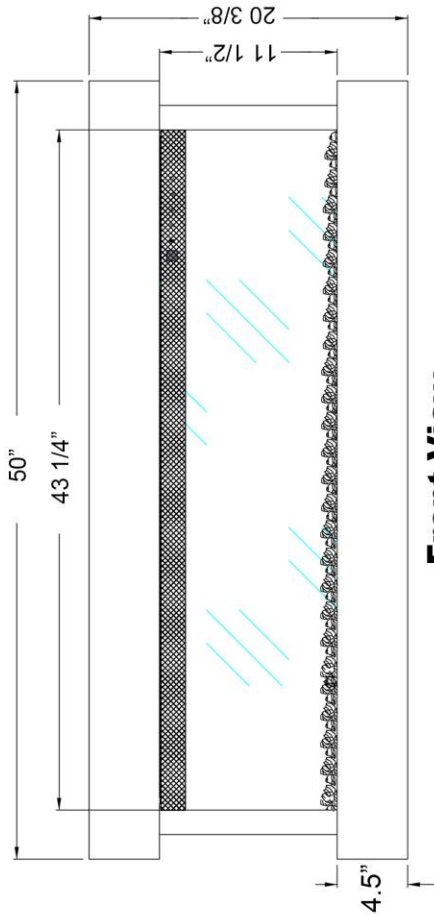
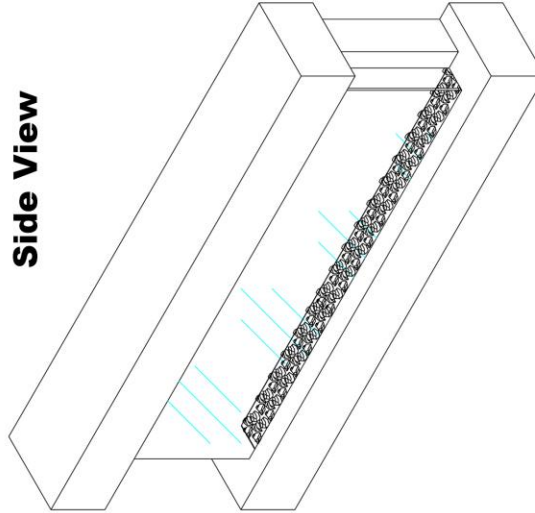

Front View

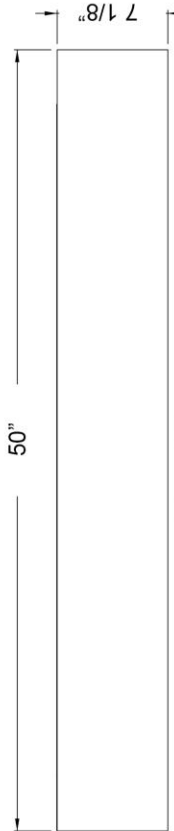

Top View

80033 - Chesmont Wall Mounted Electric Fireplace - Black 80034 - Chesmont Wall Mounted Electric Fireplace - White

Features

- 2 heat settings (high and low)
- Programmable thermostat - 68F to 88F
- Designed for wall mounting
- Remote control for heat and flame setting (batteries not included)
- 3 flame color settings - orange, blue, blue/orange
- Dual mode, operates with or without heat for only flame effect
- Built in timer mode up to 8 hours
- Faux Fire Log and Glass Crystal Media Options

Specifications

- Frame color: 80033 - White
80034 - Black
- Watts: 1,500
- BTU's: 5,000
- Room Coverage: 400 ft.
- Voltage: 110v-120v
- Amperes: 12

Chesmont 50" Wall Mounted Fireplace
PN: 80033/80034



PREMIUM
ELECTRIC FIREPLACES
& TV LIFTS

Exceeding Expectations

Updated: 01/23/2020







Unpacking Your Fireplace

Parts and Hardware

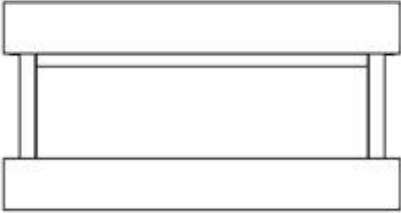
Tools Required

- Phillips-head screwdriver
- Stud finder
- Level
- Tape measure
- Electric drill
- 1/4" wood drill bit

What's in the Box

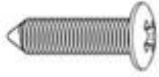
 <p>A – Fireplace (1)</p>	 <p>B – Wood Screws</p>	 <p>C – Drywall anchors</p>
	 <p>RC – Remote Control (1)</p>	 <p>D- Crystals (1)</p>
 <p>Drift log Piece (1)</p>	 <p>ST4*12 (2)</p>	

Unpacking and Setup

Unpacking Instructions:

- Remove all parts and hardware from the carton and place them on a clean, soft, dry surface. Check the parts list to make sure no parts are missing. If parts are missing, please contact technical support at 800-215-1990 opt 2. for replacement parts.

NOTE: Dispose of plastic bag, as it may cause choking hazard with young children. Do not let children play with plastic bag.

Wiring

Touchstone Wall Mounted Electric Fireplaces come with a 3-prong plug which plugs into any standard 110v outlet.

Testing the Fireplace Prior to Installation

- Before installing the fireplace, test the fireplace to make sure that it operates properly.
- Plug fireplace into approved outlet and power on fireplace. Once fireplace is tested, continue with installation.
- If you have any problems, please contact technical support at 800-215-1990 opt 2.

3-prong Outlet Installation

- Only use this fireplace on a 120V AC, 15-Amp grounded circuit. Never overload the circuit. If this fireplace trips the circuit breaker, unplug all other appliances on the same circuit before the next use. Avoid plugging other appliances into the same circuit as this fireplace.
- Always check the fireplace plug and connections before each use.
- Never plug this fireplace into an outlet that is cracked or has any loose wires or connections. Plugging this fireplace into a faulty outlet could result in the outlet overheating or catching fire.
- Make sure this plug fits securely into the outlet. Faulty wall outlet connections or loose plugs can cause the outlet to overheat. If the outlet or faceplate is hot, discontinue use immediately and have a qualified electrician inspect and/or replace the faulty outlet.
- The power cord supplied with the heater has three prongs: two flat blades (live and neutral) and one round pin (ground). If a 3-slot receptacle is not available, an adapter **MUST** be used. The adapter **MUST** be properly grounded to the outlet box (see figure below).

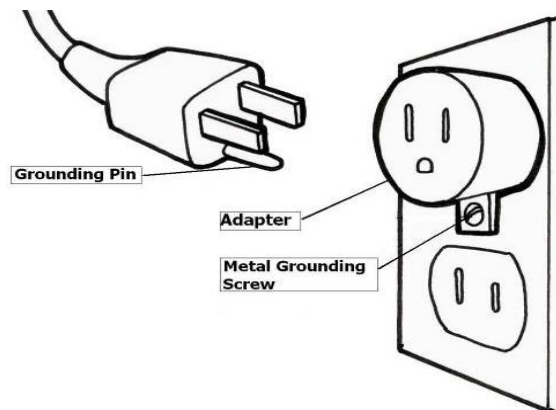

NOTE: Adapter NOT INCLUDED.

Installation

WARNINGS

- Due to high temperatures, keep the fireplace out of high traffic locations.
- Keep combustible materials, such as furniture, pillows, bedding, papers, clothes, and curtains at least 36” away from the front of the fireplace.
- Never install the fireplace where it may fall into a bathtub or other body of water.
- Wear safety gloves and safety glasses for protection during installation. Broken glass may cause injury or harm.
- Prevent contact with loose insulation. Do not install the fireplace against a vapor barrier or exposed insulation.
- Do not expose the fireplace to the elements (rain, etc).

Choosing Installation Location

Choosing Wall Location

- Measure wall location to ensure that fireplace will fit on desired wall location.
- Minimum clearances (measurements taken from front of glass panel):

Bottom of Fireplace to Floor:	0”	Top of Fireplace:	0”
Sides of Fireplace:	0”	Top of Fireplace:	0”
Back of Fireplace:	0”	Top of Fireplace:	0”

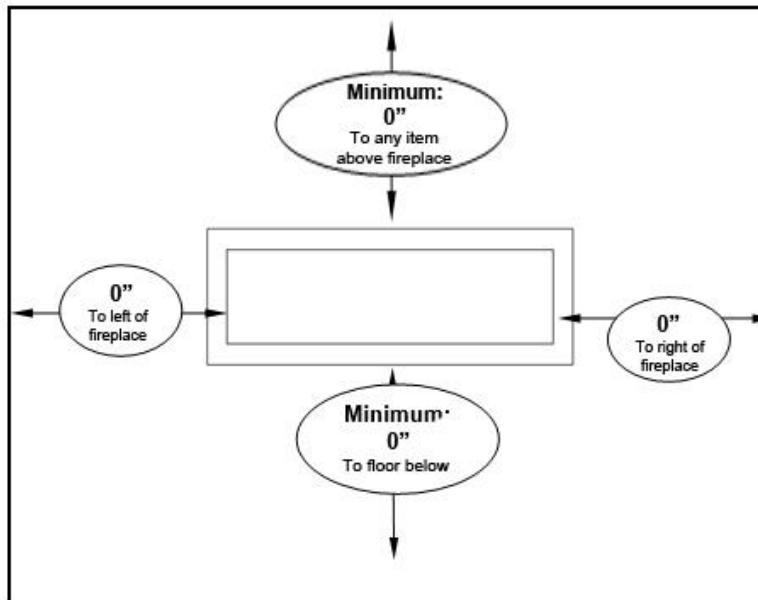

- Select a location that is not prone to moisture and is located at least 36” away from combustible materials such as curtains, drapes, furniture, bedding, or other combustible materials.
- See Safety Information on pages 3 for warnings about safe placement, safe installation, and proper use of this product.

Removing The Wall Mount Bracket From Fireplace

Tools:

- Phillips-head screw driver

Instructions:

1. Remove the fireplace from the packaging and place it on a flat, non-abrasive surface.
2. Remove the wall mount bracket from the back of the fireplace. To remove the bracket, use a Philips-head screwdriver to remove the 4 screws numbered 1-4 in the illustration shown below:

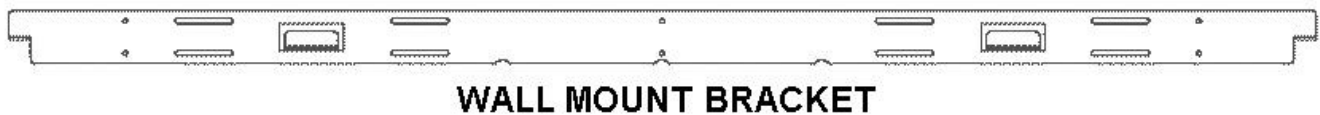
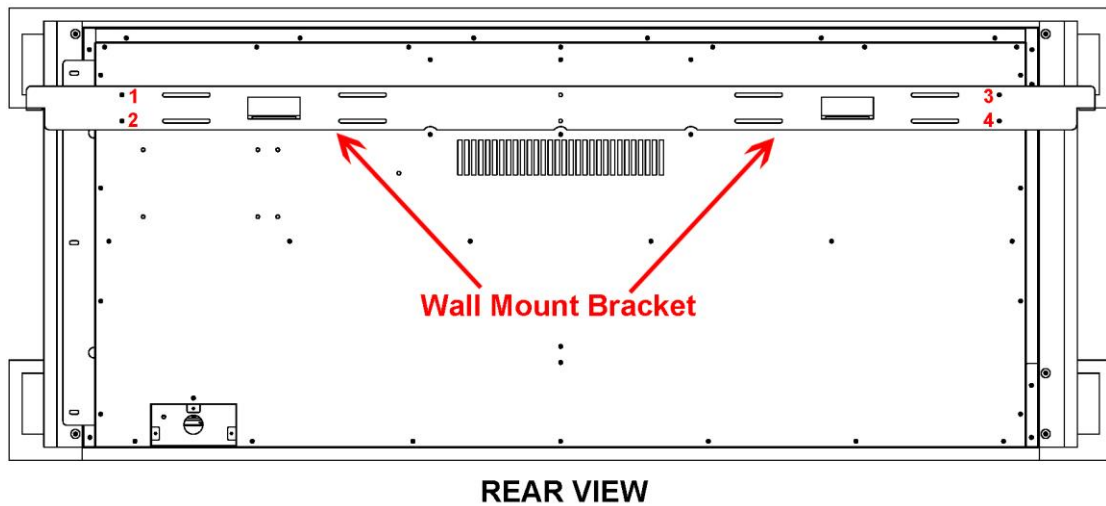

3. Place the mounting bracket and screws off to the side for mounting to the wall. Wall mounting instructions are located on p.13 of this manual.

Removing The Glass Panel and Install Media

Prior to installation on the wall, it is best to remove the glass panel. Please remove glass panel as per instructions below:

Tools Needed:

- Phillips Screwdriver

Instructions:

1. Locate the 4 screws securing the front glass panel to the fireplace. The screws are located on the underside of the top portion of the mantel.

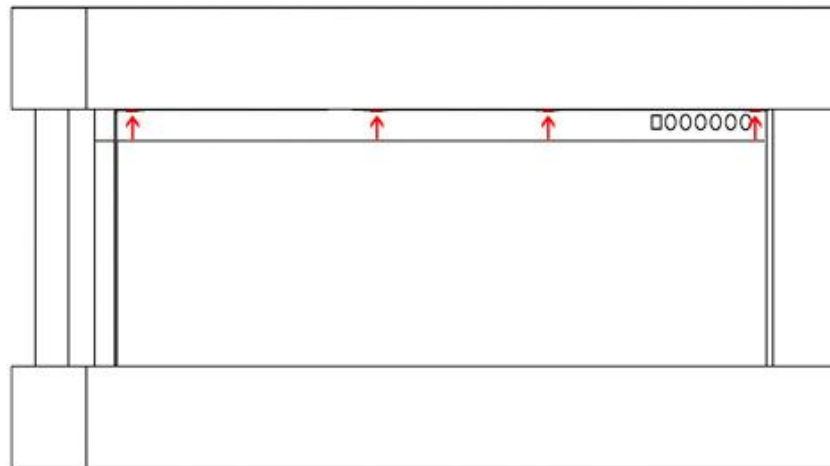

Front View of Fireplace

2. Loosen and remove the 4 screws holding the glass panel to the fireplace and remove the glass panel. Save the 4 screws in a safe spot for reinstallation later.

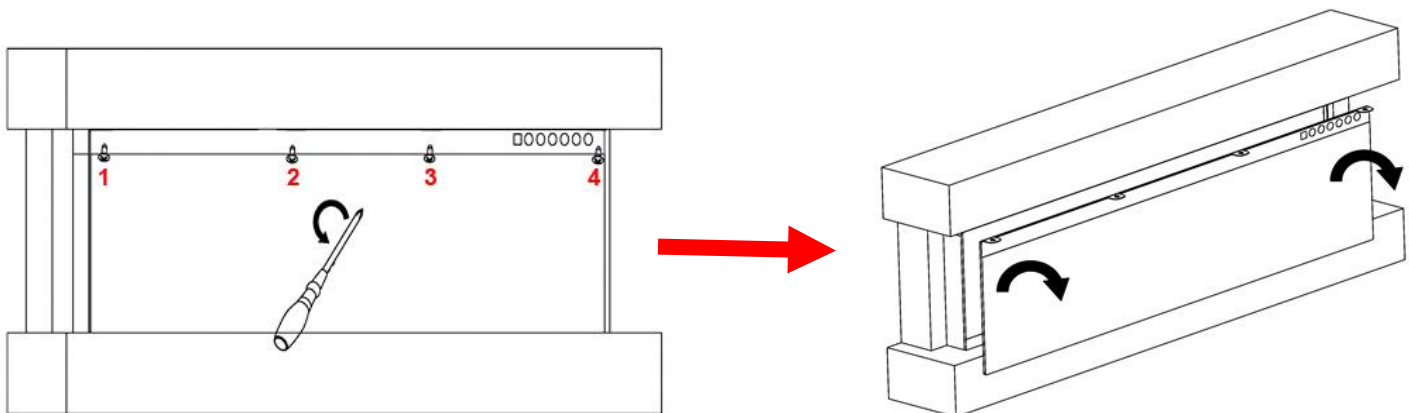

NOTE: Hold the glass panel in place when removing the last screw so that the glass panel does not fall.

Removing The Glass Panel and Install Media – cont.

3. Install the crystal glass and/or driftwood media.

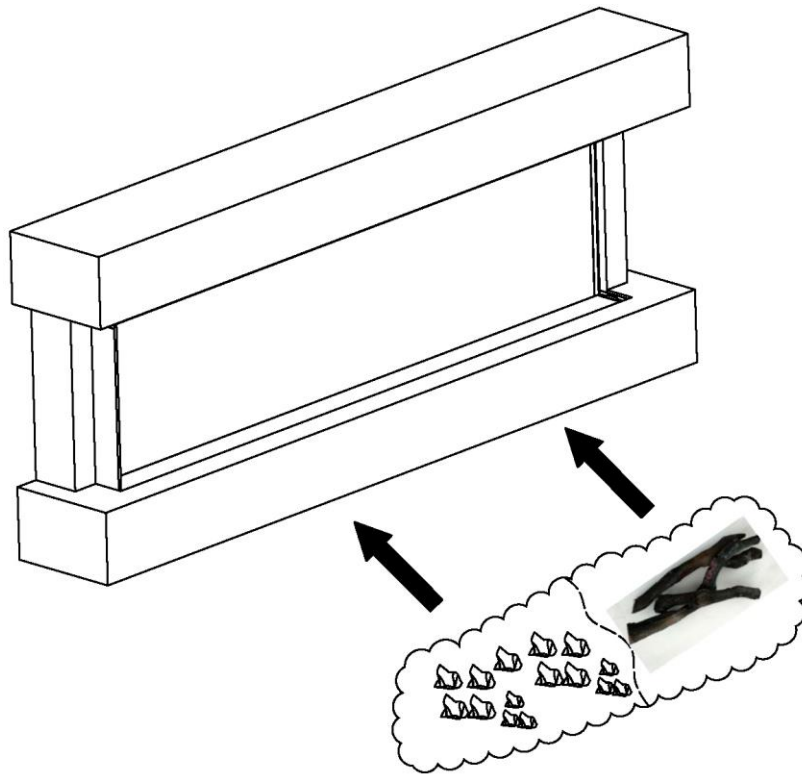

4. Once the crystal glass and/or driftwood media is installed, reinstall the glass panel using the 4 screws removed in step 2.

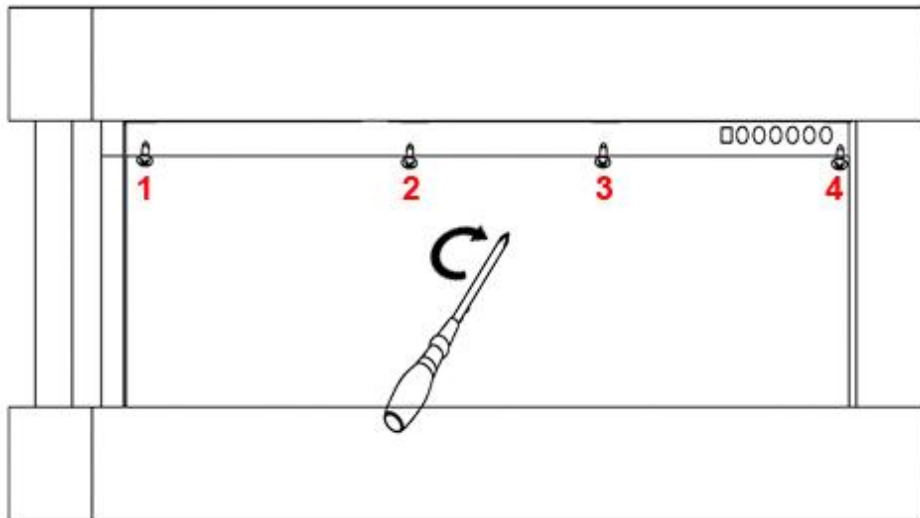

5. Once the glass panel is installed, the fireplace is ready to be mounted.

Wall Mounted Installation

- Due to many different finish materials used on walls, it is highly recommended that you consult your local builder before you install this fireplace on the wall.
- Select a location that is not prone to moisture and is located at least 36” away from combustible materials such as curtains, drapes, furniture, bedding, or other combustible materials.

Instructions

1. Select a location that is not prone to moisture and is located at least 36” away from combustible materials, such as curtains, drapes, furniture, bedding, paper, etc.
2. With glass panel removed (see p.11 for instructions on removing glass panel), have two people hold the fireplace against the wall to determine the final location.
3. Place the unit face down on a soft, non-abrasive surface. Locate the mounting bracket that was removed on p.10.
4. Locate the wall studs using an electronic stud-finder. When hanging the wall bracket, it is recommended to fasten the mounting bracket to 3 studs. If fastening to 3 studs, no dry anchors would need to be used. If fastening to only 2 studs, then dry wall anchors would need to be used to fasten the mounting bracket to the wall. Make mark on the wall at least 24” above the ground.

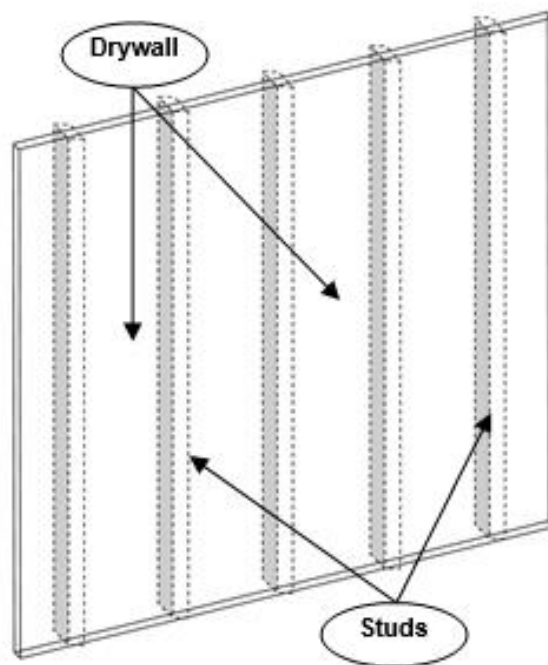

Note: The minimum height from the bottom of the fireplace, once hung on the wall, to the surface below must be at least 6”. To meet this criteria, the wall mount bracket should be hung no lower than 24” from the ground to the top of the mounting bracket when hung on the wall.

Wall Mounted Installation – cont.

5. Align the mounting bracket with the mark on the wall and mark the location of the mounting holes on the wall, making sure to line up with at least 2 studs. It is recommended to fasten the mounting bracket to 3 studs, if possible.

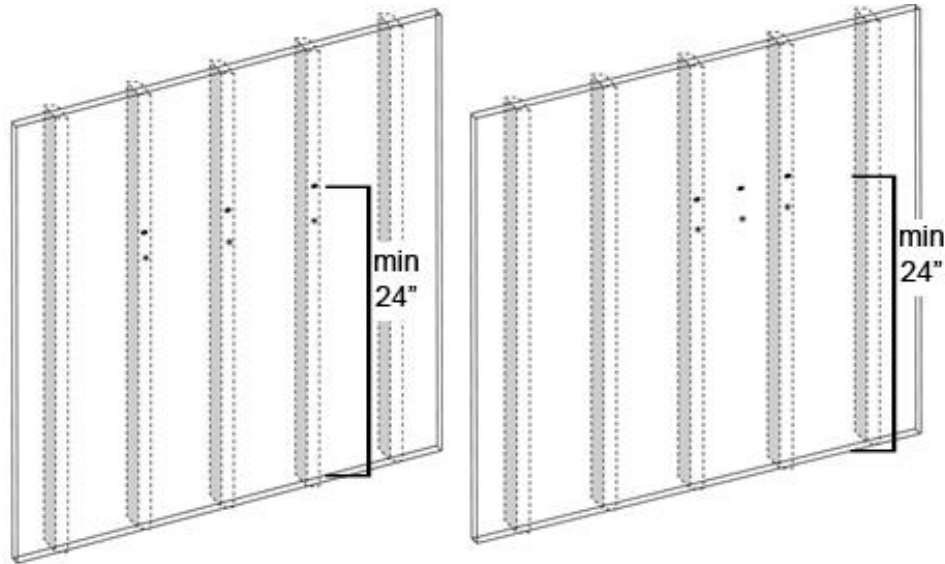

6. Attach the mounting bracket to the wall using the screws provided. If fastening to 3 studs, no dry anchors would need to be used. If fastening to only 2 studs, then at least 2 dry wall anchors would need to be used to fasten the mounting bracket to the wall.

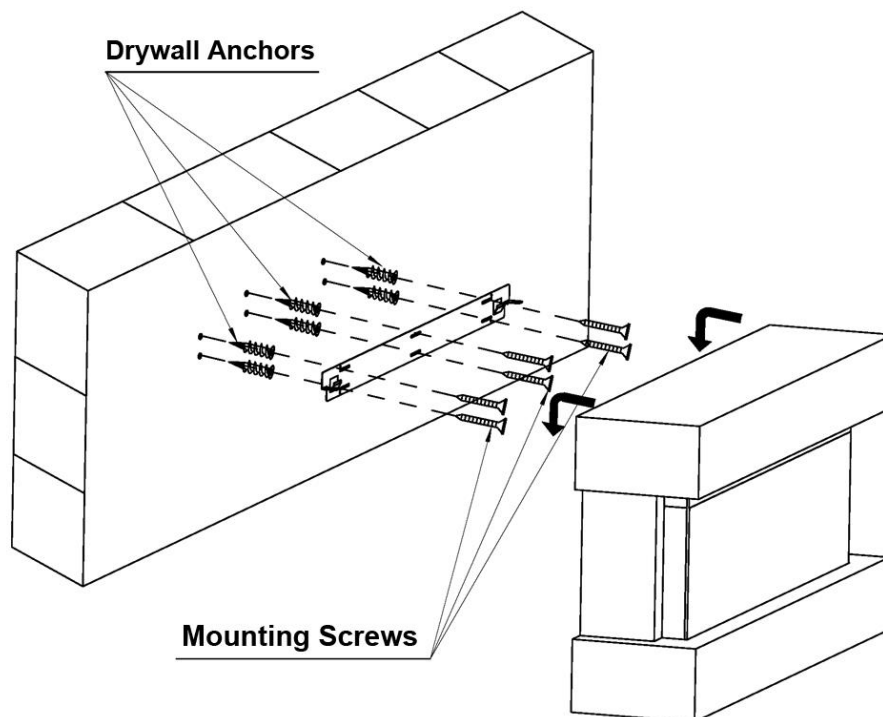

Wall Mounted Installation – cont.

7. Once the bracket is secured to the wall, the fireplace may now be hung on the bracket.
8. Once the fireplace is mounted on the bracket, install the locking screws to secure the bracket to the fireplace mantel.

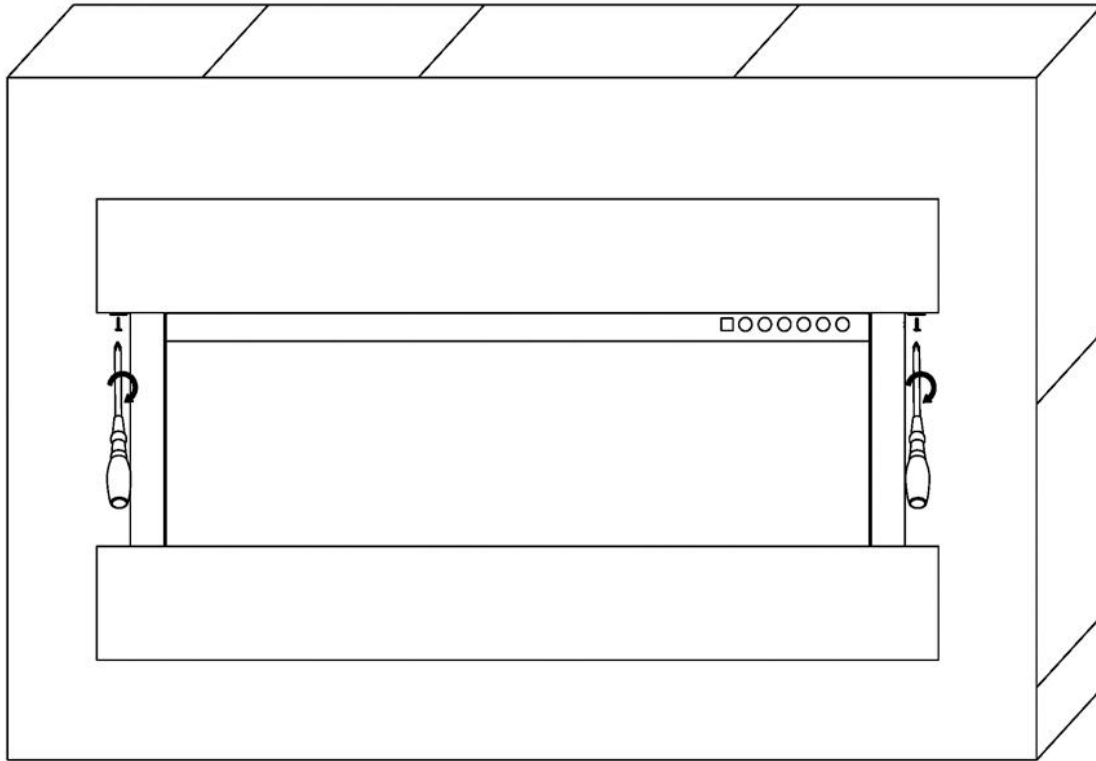

Operating Fireplace

Once the fireplace has been plugged into a grounded outlet, the fireplace is now ready for operation. Ensure that the house circuit breakers for the power supply are turned on.





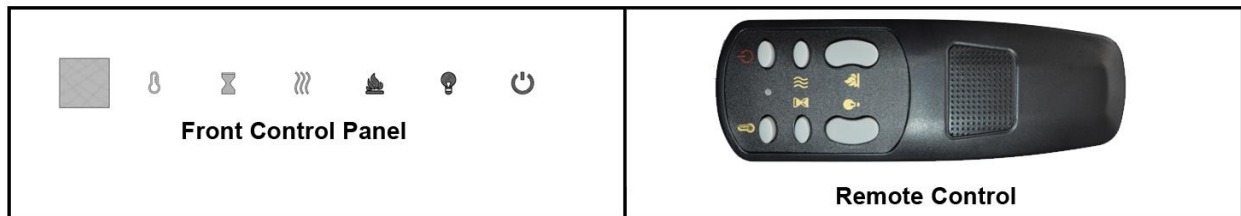

Methods of Operation

This electric fireplace can be operated by the CONTROL PANEL, located in the upper right corner of the front glass panel, or by the REMOTE CONTROL. The operation and functions of both methods are the same



Methods of Operation – cont.

Control Panel and Remote Control Functions

BUTTON	FUNCTION	ACTION & INDICATION																																						
 POWER	<p>ON: Enables control panel functions and remote control. Turns on the flame effect.</p> <p>OFF: Disables control panel functions and remove control. Turns off the flame effect.</p>	<p>1. Press once. Indicator light turns on. Power turns on. All functions enabled.</p> <p>2. Press again. Flame effect turns off. Unit goes to standby. All functions turn off.</p>																																						
 TIMER	<p>TIMER button: Control time settings to turn off fireplace at selected time.</p> <p>Settings range from 0.5 hours to 7.5 hours.</p>	<p>1. Press once. Indicator light turns on. Timer is set to 0.5 hours.</p> <p>2. Press again until desired setting is reached. Indicator lights show setting.</p>																																						
 FLAME	<p>FLAME button: Makes flame effect dimmer and brighter.</p> <p>NOTE: Flame effect stays on until power button is turned off. Flame effect must be on for heater to turn on.</p>	<p>1. Press once: Each press of the flame button changes the flame brightness.</p> <p>2. Press again until desired setting is reached. Flame effect continues to get brighter each time button is pressed.</p>																																						
 COLOR	<p>COLOR button: Changes color of the flame</p> <p>NOTE: Color effect stays on until power button is turned off. Flame effect must be on for heater to turn on.</p>	<p>1. Press once: Flame effect changes color.</p> <p>2. Press again until desired setting is reached. 3 total colors (orange, blue, and blue/orange).</p>																																						
 HEATER	<p>HEATER button: Turns heater on and off.</p> <p>NOTE: The heater only works when the flame effect is on.</p> <p>NOTE: To prevent overheating, the heater fan will blow cool air for 8-10 seconds before the heater turns on, and after the heater turns off.</p>	<p>1. Press once. Indicator lights up. Fan blows cool air for 10 seconds and 750W heater turns on and blows warm air.</p> <p>2. Press again: Indicator lights up. 1500W heater turns on and blows hot air.</p> <p>3. Press again. Heater turns off.</p>																																						
 TEMPERATURE	<p>1. Press once: Touch panel indicator becomes active.</p> <p>2. Press again until desired setting is reached. Digital display shows setting below</p> <table border="1" data-bbox="292 1444 1453 1564"> <tr> <td>Display value</td> <td></td> <td>0</td> <td>1</td> <td>2</td> <td>3</td> <td>4</td> <td>5</td> <td>6</td> <td>7</td> <td>8</td> <td>9</td> <td>10</td> </tr> <tr> <td rowspan="2">Temperature</td> <td>°C</td> <td>20</td> <td>21</td> <td>22</td> <td>23</td> <td>24</td> <td>25</td> <td>26</td> <td>27</td> <td>28</td> <td>29</td> <td>30</td> </tr> <tr> <td>°F</td> <td>68</td> <td>70</td> <td>72</td> <td>74</td> <td>76</td> <td>78</td> <td>80</td> <td>82</td> <td>84</td> <td>86</td> <td>88</td> </tr> </table> <p>NOTE: Press the button for 5 seconds to switch between °C and °F</p>	Display value		0	1	2	3	4	5	6	7	8	9	10	Temperature	°C	20	21	22	23	24	25	26	27	28	29	30	°F	68	70	72	74	76	78	80	82	84	86	88	
Display value		0	1	2	3	4	5	6	7	8	9	10																												
Temperature	°C	20	21	22	23	24	25	26	27	28	29	30																												
	°F	68	70	72	74	76	78	80	82	84	86	88																												

Remote Control Operation

- This remote control uses two AAA batteries (**Not included**).
- Instructions for battery installation are located in the remote control battery compartment.
- To improve operation of the remote control, aim the remote control at the front of the fireplace. **DO NOT PRESS the buttons too quickly.** Give the unit time to respond to each command.
- **NOTICE: NEVER** dispose of batteries in fire. Failure to observe this precaution **may result in an explosion.** Dispose of batteries at your local hazardous material processing center.

Temperature Limiting Control

This heater is equipped with a Temperature Limiting Control. Should the heater reach an unsafe temperature, the heater will automatically **TURN OFF**. To reset, please do the following:

1. Unplug the power cord from the outlet.
2. Turn ON/OFF switch on the CONTROL PANEL to OFF. Wait 5 minutes for fireplace to cool down.
3. Inspect the fireplace to make sure no vents are blocked or clogged with dust or lint. If they are, use a vacuum to clean the vent areas.
4. With the POWER switch in the OFF position, plug the power cord back into the outlet.
5. If the problem continues, have your outlet and wiring inspected by a professional. If the outlet is OK, please contact our customer support department at 800-215-1990.

Care and Maintenance

Cleaning

- **ALWAYS** turn the heater **OFF** and unplug the power cord from the outlet before cleaning, performing maintenance, or moving the fireplace. Failure to do so could result in electric shock, fire, or personal injury.
- **NEVER** immerse in water or spray with water. Doing so could result in electric shock, fire, or personal injury.

Metal:

- Buff using a soft cloth, slightly dampened with citrus oil-based product.
- **DO NOT** use brass polish or household cleaners, as these products will damage the metal trim.

Glass:

- Use a good quality glass cleaner sprayed onto a cloth or towel. Dry thoroughly with a paper towel or lint-free cloth.
- **NEVER** use abrasive cleansers, liquid sprays, or any cleaner that could scratch the surface.

Vents:

- Use a vacuum or duster to remove dust and dirt from the heater and vent areas.

Plastic:

- Wipe gently with a slightly damp cloth and a mild solution of dish soap and warm water.
- **NEVER** use abrasive cleansers, liquid sprays, or any cleaner that could scratch the surface.

Maintenance

- **RISK OF ELECTRIC SHOCK! DO NOT OPEN any panels. No user-serviceable parts inside!**
- **ALWAYS** turn the heater **OFF** and unplug the power cord from the outlet before cleaning, performing maintenance, or moving the fireplace. Failure to do so could result in electric shock, fire, or personal injury.

Electrical and Moving Parts:

- The fan motors are lubricated at the factory and will not require lubrication.
- Electrical components are integrated in the fireplace and are not serviceable by the customer.

Storage:

- Store fireplace in a clean, dry place when not in use.

Warranty

Touchstone Home Products Limited Warranty

Touchstone Home Products®, Inc offers a one (1) year limited warranty on all our electric fireplaces. The one (1) year warranty starts on the date of purchase and expires 1 calendar year from the original date of purchase.

Electrical components, such as fan motor, heater motor, control board, remote control, LED lights and control panel are covered under warranty for one year from date of purchase. Touchstone Home Products® will provide replacement parts free of charge during the first year of the warranty.

Touchstone Home Products® will not be responsible for installation, labor, or any other expenses related to the reinstallation of a warranted part, and such expenses are not covered under warranty.

Conditions and Limitations

Touchstone Home Products®, Inc warrants our electric fireplaces to be free of defects in material and workmanship to the original purchaser only. Registering your warranty is not necessary. Just provide your proof of purchase along with the model fireplace to make a warranty claim.

Warranty coverage begins on the date of purchase.

The factory warranty is non-transferrable.

Touchstone Home Products®, Inc does not cover damages caused by abuse, accident, alterations, lack of maintenance, misuse, or neglect. Parts installed from other manufacturers will void the warranty.

Touchstone will repair or replace any fireplace or fireplace part that is deemed defective or becomes defective during normal use within one (1) year after the date of purchase.

Replacement parts and replacement fireplace units are covered under a 90-day warranty or the remainder of the original one (1) year manufacturer's warranty from original date of purchase, whichever is greater.

Touchstone Home Products®, Inc does not warrant its products against damage caused by third parties.

The warranty does not cover paint scratches, cosmetic blemishes, dents, corrosion, or other normal wear and tear associated with the fireplace. Damage to fireplace or other components due to water, weather damage, long periods of dampness, condensation, damaging chemicals or cleaners are not covered under warranty.

Touchstone Home Products®, Inc limited warranty does not cover accidental breakage of fireplace glass panel.

Extended warranty coverage for the fireplace is available by contacting Touchstone Home Products® directly at 1-800-215-1990.



CALL US FIRST!
DO NOT RETURN TO STORE.



For immediate help with assembly, product information,
or if your product arrives damaged, call our toll-free number at

800-215-1990

or email:

customerservice@thpus.com

Our staff is ready to provide assistance.

Affix Serial Number Label Here