

# 2020 ELECTRIC CATALOG



TRADITIONAL SERIES



TRU-VIEW SERIES



INSERT SERIES



LYNWOOD SERIES



**DISTRIBUTOR COPY  
SHOWROOM USE ONLY**

*Amantii*





# DESIGNER MEDIA KITS



Add incredible value with designer media kits including deluxe log sets, glass and stone media and decorative embers.



6-Piece Log



Black fire glass



90-piece pebble



Rocks



Embers 1



Embers 2



Embers 3



Embers 4

## DESIGN-MEDIA-6PCE

Newcomb  
Palisade  
Emerson

MSRP \$249



Rustic 14-Piece Log



Black fire glass



90-piece pebble



Rocks



Embers 1



Embers 2



Embers 3



Embers 4

## DESIGN-MEDIA-RUSTIC-14PCE

Bennett  
Stanford  
Austin  
Tahoe  
TRV-XL Deep Series  
TRV-XT-XL Series

Panorama Deep XT Series  
Symmetry XT Series

MSRP \$449



Drift 15-Piece Log



Embers 1



Embers 2



Fire Glass



90-piece pebble



Rocks



Embers 3 & 4

## DESIGN-MEDIA-DRIFT-15PCE

Tahoe  
TRV-XL Deep Series  
TRV-XT-XL Series  
Panorama Deep XT Series  
Symmetry XT Series

MSRP \$449



Birch 15-Piece Log



Black fire glass



90-piece pebble



Rocks



Embers 1



Embers 2



Embers 3



Embers 4

## DESIGN-MEDIA-BIRCH-15PCE

Not approved for Sierra Gas Units.  
Can be used with Amantii:  
TRV-XL Deep Series  
TRV-XT-XL Series  
Panorama Deep XT Series  
Symmetry XT Series

MSRP \$449

Amantii

SIERRA FLAME



5lb Container

# STOCK AND DISPLAY OUR NEW REAL FIRE GLASS MEDIA

14 COLORS TO CHOOSE FROM

## FIRE GLASS OPTIONS

Our decorative fire glass media is a beautiful addition to your gas fireplace. Turn your fireplace into a expressive work of art by simply adding our decorative fire glass media. Our fire glass adds a distinctly modern feel to your gas fireplace - mix colors and textures for a unique appearance.

Our decorative fire glass is tempered and will not melt or degrade, some discoloration is normal on glass that is placed directly on the flame. Always wear protective gloves when handling fire glass media.

One 5lb container of media will cover 1 square foot.



AMSF-GLASS -01  
\$55



AMSF-GLASS -02  
\$55



AMSF-GLASS -03  
\$55

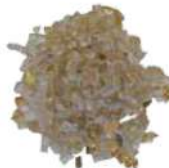

AMSF-GLASS -04  
\$55



AMSF-GLASS -05  
\$55



AMSF-GLASS -06  
\$99



AMSF-GLASS -07  
\$55



AMSF-GLASS -08  
\$55



AMSF-GLASS -09  
\$55



AMSF-GLASS -10  
\$55



AMSF-GLASS -11  
\$55



AMSF-GLASS -12  
\$55



AMSF-GLASS -13  
\$55



AMSF-GLASS -14  
\$55



Ember  
Clear, Suntea, Harvest Moon  
\$69



**NEW!**

### DESIGN-MEDIA-BIRCH-10PCE

Cube 2025  
2939-TRU-VIEW-XL  
Symmetry Series  
Symmetry B Series  
WMFM Series  
TRV Slim Series  
Traditional Series

MSRP \$169



**NEW!**

### DESIGN-MEDIA-OAK-10PCE

Cube 2025  
2939-TRU-VIEW-XL  
Symmetry Series  
Symmetry B Series  
WMFM Series  
TRV Slim Series  
Traditional Series

*4 out of the 10 logs are too wide to fit in: TRV Slim Series, WMFM Series, SYM Series and SYM B Series*

MSRP \$169



# TRADITIONAL SERIES





TRD-48 shown with  
optional Oak Log Kit



**TRADITIONAL SERIES**  
FIREPLACE & INSERT ELECTRIC FIREPLACES

*Amantii*

# TRADITIONAL BEAUTY REVAMPED

## MODERN TECHNOLOGY WITH CLASSIC INSERT FEATURES

The Traditional Series takes inspiration by it's timeless yet elegant style and exceptional quality. The heater and vents are concealed in the inner top of the unit and allows for a true clean appearance. Enjoy the brilliant flames of your fireplace even while the heat is off for ambiance during every season. This timeless fireplace will allow you to breathe new life into any space while adding warmth and ambiance.

### KEY FEATURES

-  Zero emissions, compared to gas and wood, but with traditional looks
-  Approved for Indoor and Outdoor Use
-  State of the art Fire and Ice® flame set with a click of the remote change the flame from traditional colors such as orange to more contemporary blue, purple, rose and violet colors
-  Can produce up to 1200W 4096 BTU heat, Heats approx. 400 sq ft
-  2 stage heater  
Flame operates with our without heat
-  Hard wire ready  
Thermostat hard wire ready
-  Remote control for flame and heater
-  2 Flame sets. Ambient canopy lighting in 13 colors illuminates media like never before
-  Heater is located in inner top of the unit, thus allowing the heat to cascade down over the top of the glass
-  Hidden venting allows for a true clean face appearance

## TECHNICAL SPECIFICATIONS

Volts	120V 60Hz
Amps	10
Watts	1200 W
Heater On	1200 watts high, 600 watts low
Heater Off	22 watts
Rotor Motor	1 at 5 watts
BTU	4096

### SERIES MODELS:

TRD-26	TRD-38
TRD-30	TRD-44
TRD-33	TRD-48

TRD-26



\*Height, Width, Depth: 16 3/4" x 25 1/4" x 11 3/8"  
Glass Viewing Opening & Size: 13 1/4" x 27 1/2"  
\*\*Shipping Size: 21 4/8" x 33 7/8" x 14 5/8"  
Shipping Weight: 57.5 lbs. Glass Included

TRD-30



\*Height, Width, Depth: 19 1/8" x 29 3/8" x 11 3/8"  
Glass Viewing Opening & Size: 15 1/2" x 27 1/2"  
\*\*Shipping Size: 21 4/8" x 33 7/8" x 14 5/8"  
Shipping Weight: 68.6 lbs. Glass Included



### TRD-38

\*Height, Width, Depth: 27 1/4" x 37 1/8" x 12 3/8"  
 Glass Viewing Opening & Size: 23 5/8" x 35 1/4"  
 \*\*Shipping Size: 29 5/8" x 41 6/8" x 15 4/8"  
 Shipping Weight: 101.4 lbs. Glass Included



### TRD-44

\*Height, Width, Depth: 31 5/8" x 43 1/4" x 13 3/4"  
 Glass Viewing Opening & Size: 28 1/8" x 41 3/8"  
 \*\*Shipping Size: 34" x 47 6/8" x 16 7/8"  
 Shipping Weight: 133.8 lbs. Glass Included

### TRD-33



\*Height, Width, Depth: 22 1/4" x 31 3/4" x 11 3/8"  
 Glass Viewing Opening & Size: 18 3/4" x 29 7/8"  
 \*\*Shipping Size: 24 5/8" x 36 2/8" x 14 5/8"  
 Shipping Weight: 78 lbs. Glass Included

### INCLUDED ACCESSORIES

10 piece Birch log set, charcoal grey real fireglass media and two bags of vermiculite, in black and white, plus a remote. The 44 & 48 models come with two 10 piece Birch log sets.

*A steel trim and glass inlay are included for the 26, 30, 33 & 38 models only.*



\*Remote control may not be exactly as shown

DESIGN-MEDIA-BIRCH-10PCE

TRD-48 shown with optional Fireglass

## TRD-48

\*Height, Width, Depth: 41 1/8" x 47 1/4" x 13 3/4"

Glass Viewing Opening & Size: 38 5/8" x 45 3/8"

\*\*Shipping Size: 44" x 51 6/8" x 16 7/8"

Shipping Weight: 170.4 lbs. Glass Included



TRD-26

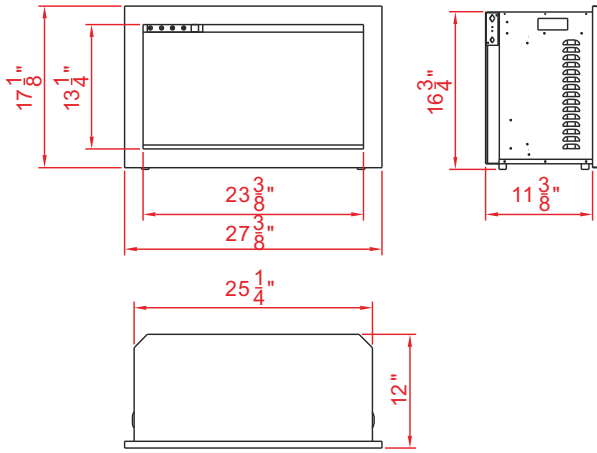

TRD-30

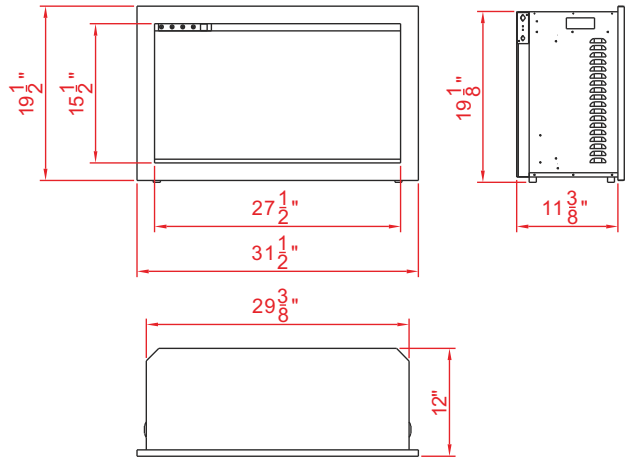

TRD-33

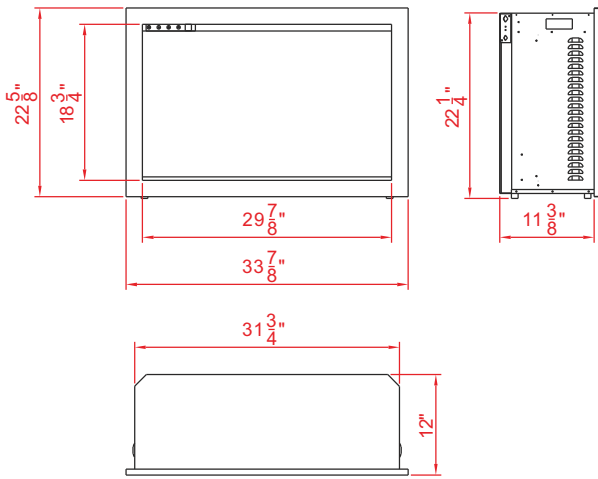

TRD-38

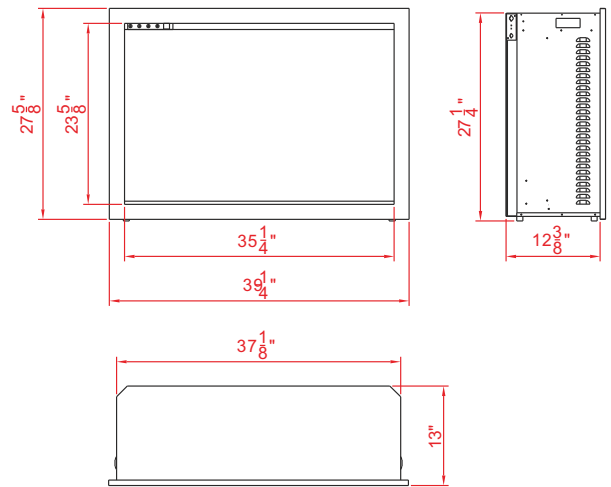

TRD-44

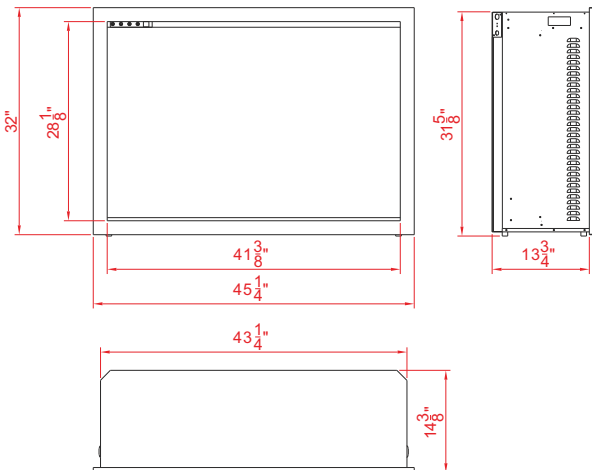

TRD-48

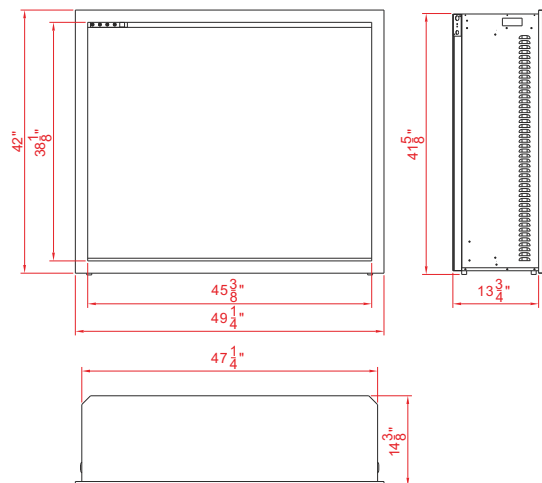



TRD-44 shown with optional Oak Logs



TRD-30 shown with optional Fireglass and optional 4-sided trim

TRD-33 shown with Birch Logs



TRD-48 shown with optional Fireglass



TRD-38 shown with optional Oak Logs



# TRADITIONAL SERIES | FIREPLACE & INSERT ELECTRIC FIREPLACES

## FIRE GLASS

Our decorative fire glass media is a beautiful addition to your fireplace. Turn your fireplace into a expressive work of art by simply adding our decorative fire glass media. Our fire glass adds a distinctly modern feel to your gas fireplace - mix colors and textures for a unique appearance.

Our decorative fire glass is tempered and will not melt or degrade, some discoloration is normal on glass that is placed directly on the flame. Always wear protective gloves when handling fire glass media.

One 5lb container of media will cover 1 square foot.

AMSF-GLASS-01



AMSF-GLASS-02



AMSF-GLASS-03



AMSF-GLASS-04



AMSF-GLASS-05



AMSF-GLASS-06



AMSF-GLASS-07



AMSF-GLASS-08



AMSF-GLASS-09



AMSF-GLASS-10



## Decorative Media Options

AMSF-GLASS-11



AMSF-GLASS-12



AMSF-GLASS-13



AMSF-GLASS-14



FI-105-DIAMOND



FI-106-DIAMOND



FI-107-DIAMOND



FI-109 DIAMOND



LOG SET



LRG LOG SET



CLEAR





## DESIGNER MEDIA KITS

Add incredible value with designer media kits including deluxe log sets, glass and stone media and decorative embers.

### DESIGN-MEDIA-BIRCH-10PCE



### DESIGN-MEDIA-OAK-10PCE



### DESIGN-MEDIA-14PCE



### DESIGN-MEDIA-BIRCH-15PCE



### DESIGN-MEDIA-15PCE



### DESIGN-MEDIA-6PCE



Images are not to scale, please visit your local dealer to view the actual accessories.

Variations in the color and shade are inherent in all printing processes, the actual colors may vary slightly from those shown.

**Note: Log sets and Designer Media Kits will fit in all sizes of the following models - Panorama DEEP, TRU VIEW XL and CUBE ONLY.**

(Depending on the size of the fireplace model, some logs may not be needed.)

# TRIMS

3-sided and 4-sided trims are made of 22 gauge metal, and available for the 26, 30, 33, 38 models.

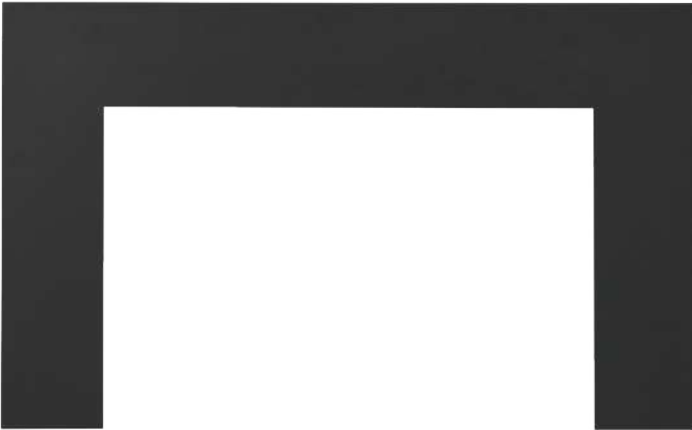

3-sided trim

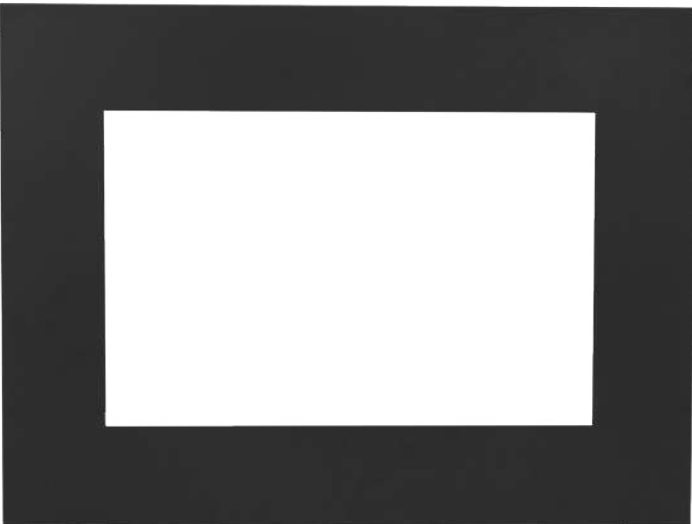

4-sided trim



TRD-33 Insert shown with Birch Logs and optional 4-sided trim

TRD-38 shown with optional Fireglass and optional 4-sided trim



TRD-26 shown with optional Oak Logs and optional 4-sided trim





TRD-33 Insert shown with  
Birch Logs and optional 4-sided trim

AM-TRD-BROCH-CAT Jan 2020

Distributed By:

Product updates, specifications and dimensions are subject to change. Please refer to the product manual to verify measurements and clearance requirements. All local building codes must be followed.

*Amantii*

Visit our online showrooms at:

[www.amantii.com](http://www.amantii.com)



# FREESTAND SERIES





Lynwood E70 electric fireplace  
shown with the Birch log media

**FREESTAND**  
ELECTRIC FIREPLACES

*Amantii*

**SIERRA**  **FLAME**

# THE CUBE

## ALLURING & MODERN

The stylish Cube 3 sided electric fireplace is truly innovative! The stunning flame presentation and unique media options can now be viewed from almost any angle through 3 sides of glass viewing area.

The Cube features two flame sets, ambient canopy lighting in 13 colors to illuminate the decorative media like never before and our exclusive FIRE & ICE® flame presentation that allows users to choose from blue, rose, violet, yellow or orange colored

flames with just a click of the remote control

Customize the appearance of the Cube further by utilizing the included 10 piece log set, charcoal grey real fireglass media and two bags of vermiculite, in black and white. Further media options available for additional purchase.

*With three distinct styles to choose from the Cube is perfect for any space, inside or out including bathrooms and kitchens.*

## IDEAL APPLICATIONS

- Residential spaces
- Patios
- Outdoor spaces
- Commercial spaces
- Restaurants
- New construction or renovations

## KEY FEATURES

FIRE & ICE® Flame Presentation. Three light strips allow for yellow, orange, blue, violet & rose colored flames

Illuminate decorative media like never before with ambient canopy lighting in 13 colors

Perfect for zone heating approx. 400-500 sq ft. 4800 BTU

Thermostat hard-wire ready  
Electrical hard-wire ready

Heater & Fan  
Flame operates with or without heat

6-1/4" deep comes with 10 piece log set, charcoal grey real fireglass media and two bags of vermiculite, in black and white.

The Cube is approved for Indoor and Outdoor use, but Speaker Base and Leg Base are NOT approved for use outdoors.

## TECHNICAL SPECS

Volts	120
Amps	13
Watts	1500 max
Heater On	1500 watts high, 750 watts low
Heater Off	22 watts
Rotor Motor	1 at 5 watts
BTU	4800

## CUBE 2025WM WITH SPEAKER BASE



## CUBE 2025WM WITH LEG BASE



CUBE 2025WM Speaker Base Dimensions  
\*Height, Width, Depth: 17 3/4 x 19 5/8 x 11 3/4



Leg Base Dimensions  
\*Height, Width, Depth: 7x 20 1/2 x 12 5/8



*Leg Base is not approved for use outdoors.*





Speaker Base



Leg Base

### INCLUDED ACCESSORIES

Each unit comes with a 10 piece log set, charcoal grey real fireglass media and two bags of vermiculite, in black and white, and a remote.



*\*Remote control may not be exactly as shown*

### MEASUREMENTS

#### CUBE WITH SPEAKER BASE

43" x 19 5/8" x 11 3/4"

#### CUBE WITH LEG BASE

33 5/8" x 19 5/8" x 11 3/4"

#### LEG BASE

7" x 20 1/2" x 12 5/8"



# THE FREESTAND

## STYLISH & VERSATILE

A distinctly European styled free standing electric fireplace from Sierra Flame by Amantii. Featuring a beveled glass viewing area that gives an almost 'see-thru' effect on three sides.

With no installation boundaries, no need for mounting brackets or building into a wall, this free stand model goes in any room you like. Virtually no assembly required - just simply plug in and enjoy!

## KEY FEATURES

-  Heater & Fan
-  Stunning flame - from contemporary to life-like traditional

 Perfect for zone heating. Approx. 500 sq. ft. 4800 BTUs

 Temperature maintenance control - keep your space warm & cozy

## INCLUDED ACCESSORIES

The Freestand come with an 11 piece log set and sable glass media, plus a remote.



\*Remote control may not be exactly as shown

## IDEAL APPLICATIONS

- Perfect for the cabin
- Basements
- Living rooms
- Den or office
- Bedrooms

## TECHNICAL SPECS

Volts	120
Amps	12.5
Watts	1500 max
Heater On	1500 watts high, 750 watts low
Heater Off	22 watts
Rotor Motor	1 at 5 watts
BTU	4800



### FS-26-922

\*Height, Width, Depth: 28 x 25 5/8 x 17 1/2  
 Glass Viewing Area: 9 x 22  
 \*\*Shipping Size: 31 8/9 x 22 2/3 x 28 1/2  
 Shipping Weight: 81.50 lbs.



**COMING  
SOON!**

**THE LYNWOOD W76  
WOOD BURNING  
FIREPLACE**



Lynwood W76 Wood Fireplace

# LYNWOOD ELECTRIC: E50 & E70

- Real Cast Iron Construction.  
Available in two sizes: 50" and 70"
- Rated for indoor applications only
- State of the art Fire and Ice flame set- with a simple click of the remote change the flame from traditional colors such as orange to contemporary colors such as rose, purple and violet and icy blue color. A spectrum of colors.
- Two Flame sets and canopy lighting in 13 color themes, creates the illusion of a real fire
- Flame effect can be used with or without heat
- On demand heat with two heat settings.  
Thermostat and Hardwire Ready
- Produces up to 4800 BTU of heat, enough to heat up 500 sq. ft
- Lower heat vent, allows the heat to flow directly to floor level
- Includes a multi-function remote
- Fan Noise: 43dB



**E50**



**E70**

<b>E50 NA</b>	Freestanding Electric Fireplace Cast Iron Construction
<b>E70 NA</b>	Freestanding Electric Fireplace Cast Iron Construction

## Tech Specs

	<b>E50</b>	<b>E70</b>
Volts	120	120
Amps	12.5	12.5
Watts	1500	1500
Heater	HIGH 1500 Watts	1500 Watts
	LOW 75 Watts	75 Watts
No Heater	19 Watts	19 Watts
Lamps	TYPE LED	LED
	TOTAL WATTS 19 Watts	19 Watts
Rotor Motor	1 at 5 watts	1 at 5 watts
Height, Width, Depth	28 1/4" x 23 1/8" x 17 1/2"	28 1/4" x 27 7/8" x 17 1/2"
Glass Size	13 1/8" x 16 3/8"	13 1/8" X 21 1/4"
Approx. Heating Area	400 sq ft	400 sq ft

## Media Included

Provided media include: 10 piece realistic birch like logs, 2 colors of fireglass, two bags of vermiculite in black and white colors. *\*Additional media is available for purchase for this series*



DESIGN-MEDIA-BIRCH-10PCE



Lynwood E70 electric fireplace shown with the Oak log media



Lynwood E50 electric fireplace shown with the Oak log media

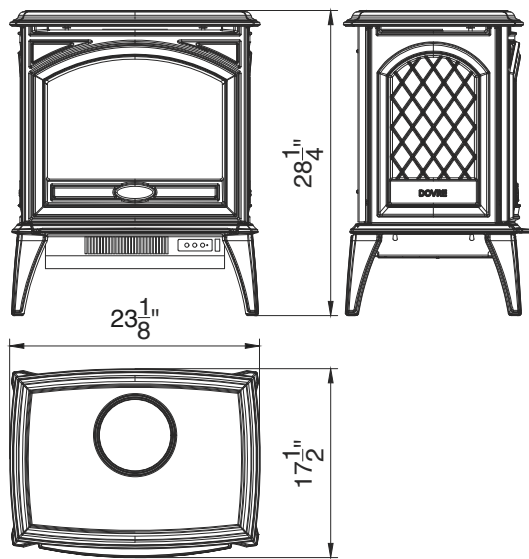

**E50**

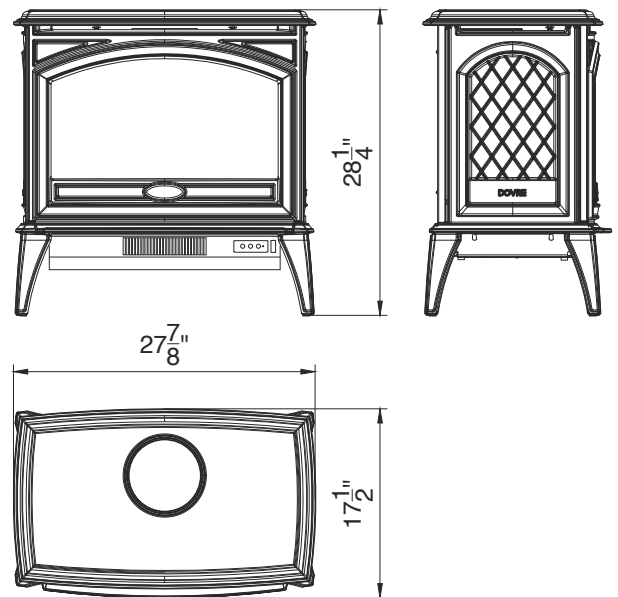

**E70**



Lynwood E50 electric fireplace  
shown with the Birch log media

AMSF-FREESTAND-US

Jan 2020

Distributed By:

We reserve the right to update products, specifications and dimensions are subject to change. Please refer to the product manual to verify measurements and clearance requirements. All local building codes must be followed.

*Amantii*

**SIERRA FLAME**

Visit our online showrooms at:

[www.amantii.com](http://www.amantii.com)

[www.sierraflame.com](http://www.sierraflame.com)



# INSERT SERIES







TRD-38 shown with Birch Logs  
and 3-sided trim

**INSERTS**  
ELECTRIC FIREPLACES

*Amantii*

**SIERRA**  **FLAME**

# ELECTRICS BY AMANTII

Designed as a perfect alternative for wood or gas inserts, our electric insert fireplaces breathe new life into new or aging masonry or metal fireplaces.

Both stylish and practical, the Amantii electric inserts are quick and easy to install making them an ideal application for the renovation and home improvement market.

## KEY FEATURES

- Zero emissions, compared to gas and wood, but with traditional looks
- Rated for Indoor and Outdoor applications
- State of the art Fire and Ice® flame set with a click of the remote change the flame from traditional colors such as orange to more contemporary blue, purple, rose and violet colors
- Can produce up to 1200W 4096 BTU heat, Heats approx. 400 sq ft
- 2 stage heater  
Flame operates with our without heat

The Insert series offers a vibrant multi-colored state-of-the-art flame that is easily changed from blue to purple to violet to orange or yellow with just a click of the remote.

- Hard wire ready  
Thermostat hard wire ready
- Remote control for flame and heater
- 2 Flame sets. Ambient canopy lighting in 13 colors illuminates media like never before
- Heater is located in inner top of the unit, thus allowing the heat to cascade down over the top of the glass
- Hidden venting allows for a true clean face appearance

## IDEAL APPLICATIONS

- Apartments
- New construction or renovations
- Outdoor spaces

## TECHNICAL SPECS

Volts	120V 60Hz
Amps	10
Watts	1200 W
Heater On	1200 watts high, 600 watts low
Heater Off	22 watts
Rotor Motor	1 at 5 watts
BTU	4096

## SERIES MODELS:

- TRD-26
- TRD-30
- TRD-33
- TRD-38

TRD-26



\*Height, Width, Depth: 16 3/4" x 25 1/4" x 11 3/8"  
Glass Viewing Opening & Size: 15 1/2" x 27 1/2"  
\*\*Shipping Size: 21 4/8" x 33 7/8" x 14 5/8"  
Shipping Weight: 57.5 lbs. Glass Included

TRD-30



\*Height, Width, Depth: 19 1/8" x 29 3/8" x 11 3/8"  
Glass Viewing Opening & Size: 15 1/2" x 27 1/2"  
Glass Size: 15 1/2" x 27 1/2"  
\*\*Shipping Size: 21 4/8" x 33 7/8" x 14 5/8"  
Shipping Weight: 68.6 lbs. Glass Included

## TRD-38

\*Height, Width, Depth: 27 1/4" x 37 1/8" x 12 3/8"

Glass Viewing Opening & Size: 23 5/8" x 35 1/4"

\*\*Shipping Size: 29 5/8" x 41 6/8" x 15 4/8"

Shipping Weight: 101.4 lbs. Glass Included



## TRD-33



## INCLUDED ACCESSORIES

10 piece Birch log set, charcoal grey real fireglass media and two bags of vermiculite, in black and white, plus a remote. A steel trim and glass inlay are included for the 26, 30, 33 & 38 models only.



DESIGN-MEDIA-BIRCH-10PCE



\*Remote control may not be exactly as shown

\*Height, Width, Depth: 22 1/4" x 31 3/4" x 11 3/8"

Glass Viewing Opening & Size: 18 3/4" x 29 7/8"

Glass Size: 18 3/4" X 29 7/8"

\*\*Shipping Size: 24 5/8" x 36 2/8" x 14 5/8"





Shipping Weight: 78 lbs. Glass Included

# ELECTRICS BY SIERRA FLAME

Breathe new life into existing masonry or metal fireplaces with an elegant Sierra Flame Electric Insert in two sizes. Designed as a good alternative for wood or gas inserts, these electric inserts are quick and easy to install which makes it an ideal application if you are renovating an existing fireplace. Ideal for Home Improvement Projects.

The Insert Series offers a vibrant multi-colored state-of-the-art flame that is easily changed from blue to purple to violet to orange or yellow with just a click of the remote.

### KEY FEATURES

-  Heater & Fan  
Flame operates with or without heat
-  Perfect for zone heating.  
Approx. 500 sq. ft. 4800 BTUs
-  Hard-wire ready  
Thermostat hard-wire ready
-  Vibrant multi-colored state-of-the-art flame presentation. Three light strips allow for yellow, orange, blue, violet & rose colored flames
-  Remote for flame & heater
-  Log set and EMBER decorative media included

### INCLUDED ACCESSORIES



*\*Remote control may not be exactly as shown*

### IDEAL APPLICATIONS

- Retrofits
- Into existing metal or masonry fireplaces
- New construction
- Renovation projects

### TECHNICAL SPECS

Volts	120
Amps	13
Watts	1500 max
Heater On	1500 watts high, 750 watts low
Heater Off	22 watts
Rotor Motor	1 at 5 watts
BTU	4800

### SERIES MODELS:

Steel front INS 30, INS 34



### INS-FM-30

\*Height, Width, Depth: 25 x 38 x 10

Glass Viewing Area: 15 3/8 x 23 1/2

Surround Size: 24 7/8 x 38

\*\*Shipping Size: 41 x 13 x 27 1/3

Shipping Weight: 76.06 lbs. Glass Included

## INS-FM-34

\*Height, Width, Depth: 30 x 42 x 10 1/8

Glass Viewing Area: 17 3/8 x 27 5/8

Surround Size: 30 x 42

Shipping Size: 44 7/8 x 13 x 32 2/3

Shipping Weight: 92.37 lbs. Glass Included



## Fire Glass

Our decorative fire glass media is a beautiful addition to your fireplace. Turn your fireplace into a expressive work of art by simply adding our decorative fire glass media. Our fire glass adds a distinctly modern feel to your gas fireplace - mix colors and textures for a unique appearance.

Our decorative fire glass is tempered and will not melt or degrade, some discoloration is normal on glass that is placed directly on the flame. Always wear protective gloves when handling fire glass media.

One 5lb container of media will cover 1 square foot.

AMSF-GLASS-01



AMSF-GLASS-02



AMSF-GLASS-03



AMSF-GLASS-04



AMSF-GLASS-05



AMSF-GLASS-06



AMSF-GLASS-07



AMSF-GLASS-08



AMSF-GLASS-09



AMSF-GLASS-10



## Decorative Media Options

AMSF-GLASS-11



AMSF-GLASS-12



AMSF-GLASS-13



AMSF-GLASS-14



FI-105-DIAMOND



FI-106-DIAMOND



FI-107-DIAMOND



FI-109 DIAMOND



LOG SET



LRG LOG SET



CLEAR



## Trims

3-sided and 4-sided trims are made of 22 gauge metal, and available for the 26, 30, 33, 38 models.



3-sided trim



4-sided trim

## Designer Media Kits

Add incredible value with designer media kits including deluxe log sets, glass and stone media and decorative embers.

### DESIGN-MEDIA-BIRCH-10PCE



### DESIGN-MEDIA-OAK-10PCE



### DESIGN-MEDIA-14PCE



### DESIGN-MEDIA-BIRCH-15PCE



### DESIGN-MEDIA-15PCE



### DESIGN-MEDIA-6PCE



Images are not to scale, please visit your local dealer to view the actual accessories.

Variations in the color and shade are inherent in all printing processes, the actual colors may vary slightly from those shown.

**Note:** Log sets and Designer Media Kits will fit in all sizes of the following models - Panorama DEEP, TRU VIEW XL and CUBE ONLY.

(Depending on the size of the fireplace model, some logs may not be needed.)

TRD-26

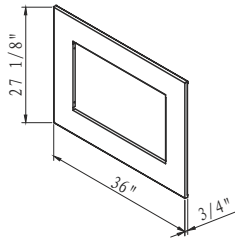

TRD-30

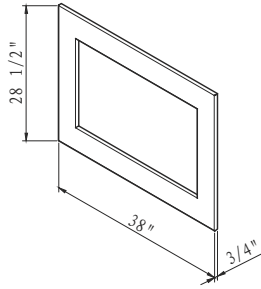

TRD-33

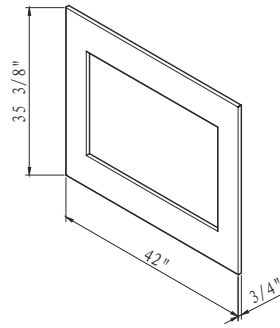

TRD-38

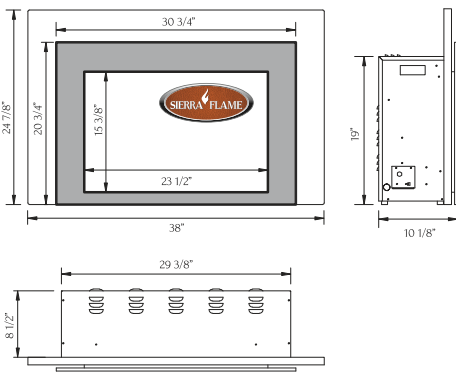
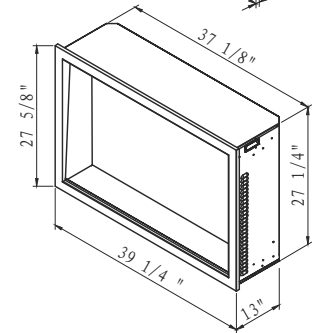
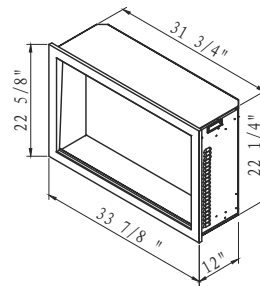
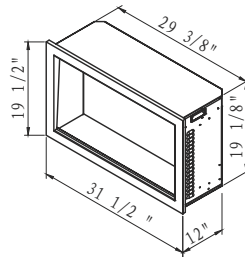
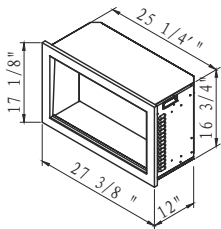
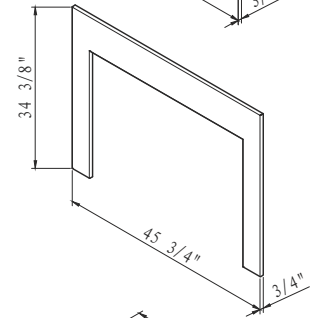
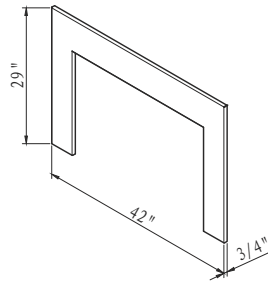
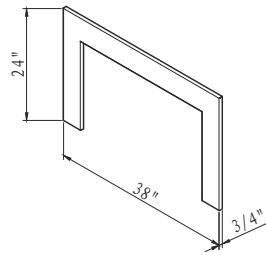
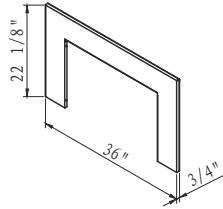
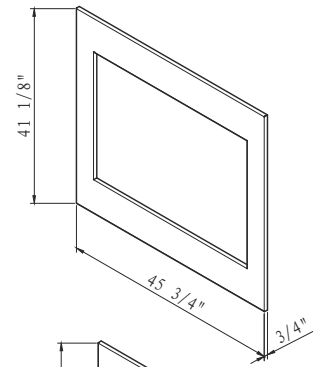

INS-FM-30

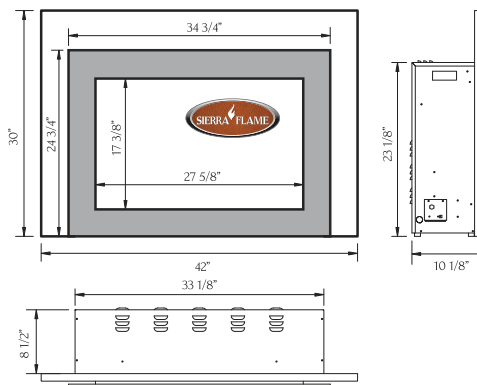

INS-FM-34

AM-SF-Inserts JAN 2020

Distributed By:



Visit our online showrooms at:

www.amantii.com

We reserve the right to update products, specifications and dimensions are subject to change. Please refer to the product manual to verify measurements and clearance requirements. All local building codes must be followed.





# TRU-VIEW SERIES





**NEW Product!  
NEW Height!  
22-inch opening**

60-TRV-XT-XL shown with Birch Logs

**TRU-VIEW SERIES**  
ELECTRIC FIREPLACES

*Amantii*

# SLIM

**NEW Product!  
NEW 4" Depth!**

## THE PERFECT FIT

Our Tru-View series family just got better with the addition of the Slim! With a depth of less than 4", the Tru-View-Slim series of electric fireplaces is designed to be installed into a 2" x 4" wall. Available in five sizes, you'll find a unit that is perfect for any space in your home, business or commercial space. The Slim is perfectly suited to installations where wall depth is at a premium.

Boasting our FIRE & ICE® Flame presentation with three color LED light strips allowing for multi-color flame options. With just a click of the included remote control, choose from blue, rose, violet, yellow or orange colored flames. The Slim model comes standard with a 10 piece log set and Charcoal grey fire glass, vermiculite, black fire glass plus a remote.

## IDEAL APPLICATIONS

- Apartments
- New construction or renovations
- Outdoor spaces

## KEY FEATURES

 FIRE & ICE® Flame Presentation. Three light strips allow for yellow, orange, blue, violet & rose colored flames

 Illuminate decorative media like never before with ambient canopy lighting in 13 colors

 Heater & Fan  
Flame operates with or without heat

 Comes with a 10 piece log set and charcoal grey fire glass, vermiculite, black fire glass plus a remote.

 Thermostat hard-wire ready  
Electrical hard-wire ready

 Very thin – only 4" in depth

 Perfect for zone heating approx. 400-500 sq ft. 4800 BTU

 Approved for Indoor and Outdoor Use

## TECHNICAL SPECS

Volts	120
Amps	13
Watts	1500 max
Heater On	1500 watts high, 750 watts low
Heater Off	22 watts
Rotor Motor	1 at 5 watts
BTU	4800

### 30-TRV-SLIM



\*Height, Width, Depth: 26 5/8 x 33 1/4 x 10 5/8  
Glass Viewing Area: 15 5/8 x 29 5/8  
Surround Size: No surround  
\*\*Shipping Size: 29 1/8 x 37 1/2 x 12 5/8  
Shipping Weight: 85 lbs. Glass Included

### 40-TRV-SLIM



\*Height, Width, Depth: 26 5/8 x 43 1/4 x 10 5/8  
Glass Viewing Area: 15 5/8 x 39 5/8  
Surround Size: No surround  
\*\*Shipping Size: 29 1/8 x 47 1/2 x 12 5/8  
Shipping Weight: 104 lbs. Glass Included



Shown with optional media.

### 60-TRV-SLIM

\*Height, Width, Depth: 26 5/8 x 63 1/4 x 10 5/8  
 Glass Viewing Area: 15 5/8 x 59 5/8  
 Surround Size: No surround  
 \*\*Shipping Size: 29 1/8 x 67 1/2 x 12 5/8  
 Shipping Weight: 140 lbs. Glass Included



Shown with optional media.

### 72-TRV-SLIM

\*Height, Width, Depth: 26 5/8 x 75 1/4 x 10 5/8  
 Glass Viewing Area: 15 5/8 x 71 5/8  
 Surround Size: No surround  
 \*\*Shipping Size: 29 1/8 x 79 1/2 x 12 5/8  
 Shipping Weight: 167 lbs. Glass Included

### 50-TRV-SLIM



\*Height, Width, Depth: 26 5/8 x 53 1/4 x 10 5/8  
 Glass Viewing Area: 15 5/8 X 49 5/8  
 Surround Size: No surround  
 \*\*Shipping Size: 29 1/8 x 57 1/2 x 12 5/8  
 Shipping Weight: 121 lbs. Glass Included

### INCLUDED ACCESSORIES

The TRU VIEW SLIM series comes with a 10 piece log set and Charcoal grey fire glass, vermiculite, black fire glass plus a remote.



\*Remote control may not be exactly as shown

# XL EXTRA TALL



## REACHING NEW HEIGHTS

For a sophisticated and contemporary way to introduce flame into your living space our Tru-View XT-XL are a perfect fit. The XT-XL series comes with a beautiful selection of logs, embers and glass media kit to create a beautiful illusion of flame. It's your choice of media kits.

Built with Amantii's FIRE & ICE® Flame presentation made of three color LED light strips allowing for multi-color flame options. With just a click of the included remote control, choose from blue, rose, violet, yellow or orange colored flames. Additional media options available for purchase.

## IDEAL APPLICATIONS

- Residential spaces
- Patios
- Outdoor spaces
- Commercial spaces
- Restaurants
- New construction or renovations

## KEY FEATURES

 FIRE & ICE® Flame Presentation. Three light strips allow for yellow, orange, blue, violet & rose colored flames

 Illuminate decorative media like never before with ambient canopy lighting in 13 colors

 Heater & Fan  
Flame operates with or without heat

 Your choice of Designer Media kit - deluxe log set, black stones, rocks, pebbles, vermiculite chips and embers

 Thermostat hard-wire ready  
Electrical hard-wire ready

 Glass viewing area is 22" in height

 Perfect for zone heating approx. 400-500 sq ft. 4800 BTU

 Approved for Indoor and Outdoor Use

## TECHNICAL SPECS

Volts	120
Amps	13
Watts	1500 max
Heater On	1500 watts high, 750 watts low
Heater Off	22 watts
Rotor Motor	1 at 5 watts
BTU	4800

40-TRV-XT-XL



50-TRV-XT-XL



\*Height, Width, Depth: 33 x 43 1/4 x 13 3/4  
Glass Viewing Area: 22 x 39 5/8  
Surround Size: No surround  
\*\*Shipping Size: 35 1/4 x 47 1/2 x 15 5/8  
Shipping Weight: 126 lbs. Glass Included

\*Height, Width, Depth: 33 x 53 1/4 x 13 3/4  
Glass Viewing Area: 22 x 49 5/8  
Surround Size: No surround  
\*\*Shipping Size: 35 1/4 x 57 1/2 x 15 5/8  
Shipping Weight: 148 lbs. Glass Included



### 72-TRV-XT-XL

\*Height, Width, Depth: 33 x 75 1/4 x 13 3/4  
 Glass Viewing Area: 22 x 71 5/8  
 Surround Size: No surround  
 \*\*Shipping Size: 35 1/4 x 79 1/2 x 15 5/8  
 Shipping Weight: 201 lbs. Glass Included



### 88-TRV-XT-XL

\*Height, Width, Depth: 33 x 91 1/4 x 13 3/4  
 Glass Viewing Area: 22 x 87 5/8  
 Surround Size: No surround  
 \*\*Shipping Size: 35 1/4 x 95 1/2 x 15 5/8  
 Shipping Weight: 231 lbs. Glass Included

### 60-TRV-XT-XL



\*Height, Width, Depth: 33 x 63 1/4 x 13 3/4  
 Glass Viewing Area: 22 x 59 5/8  
 Surround Size: No surround  
 \*\*Shipping Size: 35 1/4 x 67 1/2 x 15 5/8  
 Shipping Weight: 170 lbs. Glass Included

### INCLUDED ACCESSORIES

The Tru View XL Extra Tall series includes your choice of Design Media Kit - 15 piece log set, black fireglass, pebbles, stones, vermiculite chips and embers, ICE media kit and a remote.



\*Remote control may not be exactly as shown

#### YOUR CHOICE:

#### DESIGN-MEDIA-DRIFT-15PCE

Now includes an additional 4 mini logs (Not Shown)



#### DESIGN-MEDIA-RUSTIC-14PCE



#### DESIGN-MEDIA-BIRCH-15PCE

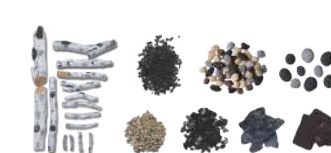

#### ICE MEDIA



FI-109-Diamond

# XL DEEP

## STUNNING FROM ANY ANGLE

Makes a bold statement of elegance that is sure to capture the imagination of any guest who happen upon its presence. Versatile and stunning, this fireplace has four installation options: 3 sided open, left side open, right side open or both sides "closed".

Designed for finishing materials to built flush to the lip for a clean face finish. Built-In only. No trim or surround included.

Perfect for any space, inside or out, including bathrooms.

Boasting a depth of 14-1/4", the TRU-VIEW-XL DEEP features two flame sets, ambient canopy lighting in 13 colors to illuminate the decorative media like never before and our exclusive FIRE & ICE® flame presentation. Additional media available for purchase.

## IDEAL APPLICATIONS

- Residential spaces
- Patios
- Outdoor spaces
- Commercial spaces
- Restaurants
- New construction or renovations

## KEY FEATURES

 FIRE & ICE® Flame Presentation. Three light strips allow for yellow, orange, blue, violet & rose colored flames

 Heater & Fan  
Flame operates with or without heat

 Thermostat hard-wire ready  
Electrical hard-wire ready

 Perfect for zone heating approx. 400-500 sq ft. 4800 BTU

 Illuminate decorative media like never before with ambient canopy lighting in 13 colors

 Your choice of Designer Media kit - deluxe log set, black stones, rocks, pebbles, vermiculite chips and embers

 Approved for Indoor and Outdoor Use

## TECHNICAL SPECS

Volts	120
Amps	13
Watts	1500 max
Heater On	1500 watts high, 750 watts low
Heater Off	22 watts
Rotor Motor	1 at 5 watts
BTU	4800

40-TRV-XL DEEP



\*Height, Width, Depth: 26 5/8 x 43 1/4 x 14 1/4  
Glass Viewing Area: 15 5/8 x 34 1/4  
Surround Size: No surround  
\*\*Shipping Size: 32 1/3 x 51 2/9 x 16  
Shipping Weight: 121 lbs. Glass Included

60-TRV-XL DEEP



\*Height, Width, Depth: 26 5/8 x 63 1/4 x 14 1/4  
Glass Viewing Area: 15 5/8 x 59 5/8  
Surround Size: No surround  
\*\*Shipping Size: 32 1/3 x 70 5/8 x 16  
Shipping Weight: 161 lbs. Glass Included



## 50-TRV-XL DEEP

\*Height, Width, Depth: 26 5/8 x 53 1/4 x 14 1/4  
 Glass Viewing Area: 15 5/8 x 45 1/4  
 Surround Size: No surround  
 \*\*Shipping Size: 32 1/3 x 60 5/8 x 16  
 Shipping Weight: 141 lbs. Glass Included



## 72-TRV-XL DEEP



\*Height, Width, Depth: 26 5/8 x 75 1/4 x 14 1/4  
 Glass Viewing Area: 125 5/8 x 68 3/4  
 Surround Size: No surround  
 \*\*Shipping Size: 32 1/3 x 86 7/9 x 16  
 Shipping Weight: 192 lbs. Glass Included

### INCLUDED ACCESSORIES

The Tru View XL Deep series includes your choice of Design Media Kit - 15 piece log set, black fireglass, pebbles, stones, vermiculite chips and embers, ICE media kit and a remote.



\*Remote control may not be exactly as shown

YOUR CHOICE:

#### DESIGN-MEDIA-DRIFT-15PCE

Now includes an additional 4 mini logs (Not Shown)



#### DESIGN-MEDIA-RUSTIC-14PCE



#### DESIGN-MEDIA-BIRCH-15PCE

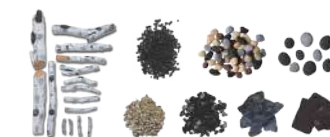

#### ICE MEDIA



FI-109-Diamond

# THE CUBE

## STYLISH & VERSATILE

The stylish Cube 3 sided electric fireplace is truly innovative! The stunning flame presentation and unique media options can now be viewed from almost any angle through 3 sides of glass viewing area.

The Cube features two flame sets, ambient canopy lighting in 13 colors to illuminate the decorative media like never before and our exclusive FIRE & ICE® flame presentation that allows users to choose from blue, rose, violet, yellow or orange colored

flames with just a click of the remote control

Customize the appearance of the Cube further by utilizing the included 10 piece log set, charcoal grey real fireglass media and two bags of vermiculite, in black and white. Further media options available for additional purchase.

*With three distinct styles to choose from the Cube is perfect for any space, inside or out including bathrooms and kitchens.*

## IDEAL APPLICATIONS

- Residential spaces
- Patios
- Outdoor spaces
- Commercial spaces
- Restaurants
- New construction or renovations

## KEY FEATURES

 FIRE & ICE® Flame Presentation. Three light strips allow for yellow, orange, blue, violet & rose colored flames

 Illuminate decorative media like never before with ambient canopy lighting in 13 colors

 Perfect for zone heating approx. 400-500 sq ft. 4800 BTU

 Thermostat hard-wire ready  
Electrical hard-wire ready

 Heater & Fan  
Flame operates with or without heat

 6-1/4" deep comes with 10 piece log set, charcoal grey real fireglass media and two bags of vermiculite, in black and white.

 Approved for Indoor and Outdoor Use

## TECHNICAL SPECS

Volts	120
Amps	13
Watts	1500 max
Heater On	1500 watts high, 750 watts low
Heater Off	22 watts
Rotor Motor	1 at 5 watts
BTU	4800

## CUBE 2025WM WITH SPEAKER BASE



## CUBE 2025WM WITH LEG BASE



CUBE 2025WM Speaker Base Dimensions  
\*Height, Width, Depth: 17 3/4 x 19 5/8 x 11 3/4



Leg Base Dimensions  
\*Height, Width, Depth: 7 x 20 1/2 x 12 5/8



*Leg Base is not approved for use outdoors.*

### CUBE 2025WM

\*Height, Width, Depth: 25 1/4 x 19 5/8 x 11 3/4

Glass Viewing Area: 15 3/8 x 16 1/2 x 3 7/8

\*\*Shipping Size: 23 x 15 x 28

Shipping Weight: 60 lbs. Glass Included



### CUBE 2025WM



### INCLUDED ACCESSORIES

Each unit comes with a 10 piece log set, charcoal grey real fireglass media and two bags of vermiculite, in black and white, and a remote.



*\*Remote control may not be exactly as shown*

### MEASUREMENTS

Nº 1. Cube with Speaker Base  
43" x 19 5/8" x 11 3/4"

Nº 3. Cube Wall Mount  
25 1/4" x 19 5/8" x 11 3/4"

Nº 2. Cube with Leg Base  
33 5/8" x 19 5/8" x 11 3/4"

Nº 4. Leg Base  
8 3/8" x 20 1/2" x 12 5/8"

CUBE 2025WM is approved for use outdoors in a covered area. Speaker Base and Leg Base are not approved for use outdoors.

# 2939 XL

## ALLURING & MODERN

The contemporary 2939 XL – 3 sided fireplace is stunningly modern! Resembling the Cube fireplace with its flame presentation and unique media options. With it comes the allure of a realistic like flame and large 3 sided viewing area, visible from any angle

The 2939 XL feature two flame sets, ambient canopy lighting in 13 colors to illuminate the decorative media like never before and our exclusive FIRE & ICE® flame presentation that allows users to choose

from blue, rose, violet, yellow or orange colored flames with just a click of the remote control. *It's perfect for any space, inside or out including bathrooms.*

Customize the appearance of the 2939 XL further by utilizing the included 10 piece log set, charcoal grey real fireglass media and two bags of vermiculite, in black and white. Further media options available for additional purchase.

## IDEAL APPLICATIONS

- Residential spaces
- Patios
- Outdoor spaces
- Commercial spaces
- Restaurants
- New construction or renovations

## KEY FEATURES

 FIRE & ICE® Flame Presentation. Three light strips allow for yellow, orange, blue, violet & rose colored flames

 Illuminate decorative media like never before with ambient canopy lighting in 13 colors

 Perfect for zone heating approx. 400-500 sq ft. 4800 BTU

 Thermostat hard-wire ready  
Electrical hard-wire ready

 Heater & Fan  
Flame operates with or without heat

 11-3/4" deep comes with a 10 piece log set and media

 Approved for Indoor and Outdoor Use

## TECHNICAL SPECS

Volts	120
Amps	13
Watts	1500 max
Heater On	1500 watts high, 750 watts low
Heater Off	22 watts
Rotor Motor	1 at 5 watts
BTU	4800

2939 XL



2939 XL



### 2939 XL

\*Height, Width, Depth: 39-1/4" x 29-1/2" x 11-3/4"  
Glass Viewing Area: 29" x 26"  
\*\*Shipping Size: 41" x 32-1/2" x 12-1/4"  
Shipping Weight: 104 lbs. Glass Included



### 2939 XL

### INCLUDED ACCESSORIES

Each unit comes with a 10 piece log set, charcoal grey real fireglass media and two bags of vermiculite, in black and white, and a remote.



*\*Remote control may not be exactly as shown*

Approved for outdoor applications, including kitchens.  
Note: For outdoor use it must be installed in a covered area. Please refer to the manual for additional information.

## XL DEEP

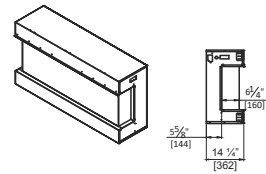
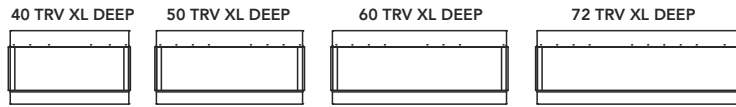

## SLIM

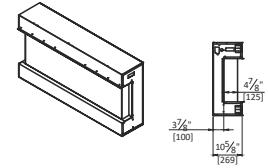
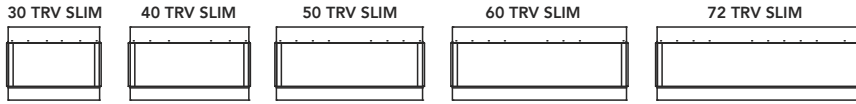

## XL EXTRA TALL

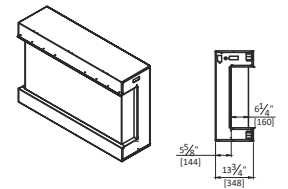
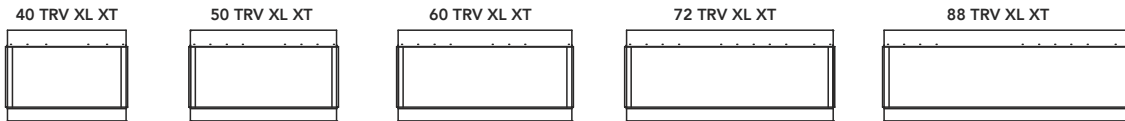

## EXCLUSIVE FLAME SET



Ambient canopy lighting: Shown On and Off, illuminate media like never before with a spectrum of lighting in 13 different colors.

## UNIQUE PRESENTATION



Fire & Ice Flame®: Vibrant multi-colored state-of-the-art FIRE & ICE® flame that is easily changed from purple to orange or yellow to blue to purple, rose or violet to blue with just a click of the remote.

## FOUR INSTALLATION CONFIGURATIONS

- All 3 sides of glass visible
- Left side visible
- Right visible
- Front only for an extra deep (14 1/4") fireplace



3 sides open



Left side open



Right side open



Both sides closed

Tru-View-US JAN 20

Distributed By:

We reserve the right to update products, specifications and dimensions are subject to change. Please refer to the product manual to verify measurements and clearance requirements. All local building codes must be followed.

*Amantii*

Visit our online showrooms at:

[www.amantii.com](http://www.amantii.com)



# PANORAMA SERIES







BI-40-xtra Slim Electric Fireplace  
shown with Mantle Surround in Gray Bark

# PANORAMA SERIES

ELECTRIC FIREPLACES  
INDOOR • OUTDOOR

*Amantii*

# EXTRA SLIM

## INCREDIBLY THIN AT JUST 4"

Our Panorama series family just got better with the addition of the Extra Slim! With an opening height of 11-7/8" and available in four sizes, you'll find a unit that is perfect for any space in your home, business or commercial space. At just 4" in depth, the XS is perfectly suited to installations where wall depth is at a premium.

Boasting our FIRE & ICE® Flame presentation with three color LED light strips allowing for multi-color flame options. With just a click of the included remote control, choose from blue, rose, violet, yellow or orange colored flames. The Extra Slim model comes standard with clear decorative media with additional media options available for purchase.



## IDEAL APPLICATIONS

- Residential spaces
- Patios
- Outdoor spaces
- Commercial spaces
- Restaurants
- New construction or renovations

## KEY FEATURES

-  Heater & Fan
-  Hard-wire ready.  
Thermostat hard-wire ready
-  Rated for indoor & outdoor use including bathrooms

 Very thin – only 4" in depth

-  Perfect for zone heating. Approx. 500 sq. ft. 4800 BTUs
-  FIRE & ICE® Flame presentation.  
Three light strips allow for yellow, orange, blue, violet & rose colored flames

## TECHNICAL SPECS

Volts	120
Amps	12.5
Watts	1500 max
Heater On	1500 watts high, 750 watts low
Heater Off	22 watts
Rotor Motor	1 at 5 watts
BTU	4800

## INCLUDED ACCESSORIES

The Panorama Extra Slim series come with clear decorative media, plus a remote.  
*\*Remote control may not be exactly as shown*



### BI-30-XTRASLIM



\*Height, Width, Depth: 19 7/8 x 29 1/8 x 4  
Glass Viewing Area: 11 7/8 x 25 1/4  
Surround Size: 15 7/8 x 29 1/8  
\*\*Shipping Size: 23 x 35 3/5 x 7 2/7  
Shipping Weight: 51 lbs. Glass Included

### BI-40-XTRASLIM



\*Height, Width, Depth: 19 7/8 x 39 1/8 x 4  
Glass Viewing Area: 11 7/8 x 35 1/4  
Surround Size: 15 7/8 x 39 1/8  
\*\*Shipping Size: 23 x 45 3/5 x 7 2/7  
Shipping Weight: 56 lbs. Glass Included



### BI-50-XTRASLIM

\*Height, Width, Depth: 19 7/8 x 49 1/8 x 4  
 Glass Viewing Area: 11 7/8 x 45 1/4  
 Surround Size: 15 7/8 x 49 1/8  
 \*\*Shipping Size: 23 x 55 3/5 x 7 2/7  
 Shipping Weight: 67 lbs. Glass Included



### BI-60-XTRASLIM

\*Height, Width, Depth: 19 7/8 x 59 1/8 x 4  
 Glass Viewing Area: 11 7/8 x 55 1/4  
 Surround Size: 15 7/8 x 59 1/8  
 \*\*Shipping Size: 23 x 65 3/5 x 7 2/7  
 Shipping Weight: 77 lbs. Glass Included

## BI-40-XTRASLIM MANTEL-SURROUND



### Beautifully Inspired

Amantii's newest line of birch wood mantel-surrounds bring the beauty of genuine birch wood into any space. With four nature inspired colors to choose from, you will find a mantel-surround that is perfect for any space in your home, business or commercial setting. Amantii has designed a mantel-surround for your Bi-40-XTRASLIM fireplace that will compliment every style.

All our mantel-surrounds have been crafted from birch wood with a paint wash application reflective of the variety of colors found in a birch tree forest.

As with all genuine products, variations to the natural wood grain will mean there could be slight variations that may differ from the catalog images or samples.

Variations will occur in color, character, tone and grain from product to product. Slight variations between samples and finished goods should be anticipated. In addition, a touch up pen has been included in the packaging should there be any imperfections caused by the shipping of this product.

The BI-40-XTRASLIM mantel-surrounds have been approved for use in kitchens and bathrooms. The mantel-surrounds cannot be used in outdoor settings.

White Birch • Grey Bark • Natural Birch • Knotty Black

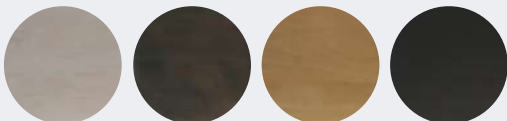

# SLIM

## REACHING NEW HEIGHTS

The Panorama Slim Series of built-in electric fireplaces have been designed to give you the maximum in flexibility in selecting a unit that perfectly suits your needs. The stylish electric fireplace will be a focal point in any room, indoor or outdoor.

At just 6 3/4" in depth, the Slim is a practical choice for new construction projects and renovations alike. As well as giving you the ability to install your fireplace with your choice of finishing material built

right to the glass for a "clean face" design or using the provided black metal surround. Your choice – your design!

Featuring the vibrant Fire & Ice® flame set, with just a click of your remote you can easily change the flame color from blue to purple to violet to orange or yellow. Additional media options available for purchase.

## IDEAL APPLICATIONS

- Residential spaces
- Patios
- Outdoor spaces
- Commercial spaces
- Restaurants
- New construction or renovations

## KEY FEATURES

 Heater & Fan  
Flame operates with or without heat

 Hard-wire ready.  
Thermostat hard-wire ready

 Illuminate decorative media like never before with ambient canopy lighting in 13 colors

 Slim 6 3/4" comes with large glass chunks, clear & blue diamond fire glass media, black steel surround that can be installed if preferred

 Perfect for zone heating. Approx. 500 sq. ft. 4800 BTUs

 FIRE & ICE® Flame presentation.  
Three light strips allow for yellow, orange, blue, violet & rose colored flames

## TECHNICAL SPECS

Volts	120
Amps	12.5
Watts	1500 max
Heater On	1500 watts high, 750 watts low
Heater Off	22 watts
Rotor Motor	1 at 5 watts
BTU	4800

BI-40-SLIM-OD



\*Height, Width, Depth: 23 5/8 x 38 5/8 x 6 3/4  
Glass Viewing Area: 12 x 34 1/4  
Surround Size: 15 3/4 x 38 5/8  
\*\*Shipping Size: 44 7/8 x 9 x 25 1/3  
Shipping Weight: 72 lbs. Glass Included

BI-50-SLIM-OD



\*Height, Width, Depth: 23 5/8 x 49 5/8 x 6 3/4  
Glass Viewing Area: 11 5/8 x 45 1/4  
Surround Size: 15 5/8 x 48 5/8  
\*\*Shipping Size: 25 1/3 x 55 x 9  
Shipping Weight: 92 lbs. Glass Included



### BI-72-SLIM-OD

\*Height, Width, Depth: 23 5/8 x 72 1/8 x 6 3/4  
 Glass Viewing: 11 7/8 x 68 3/4  
 Surround Size: 15 5/8 x 72 1/8  
 \*\*Shipping Size: 25 1/3 x 82 1/3 x 9  
 Shipping Weight: 137 lbs. Glass Included



### BI-60-SLIM-OD

\*Height, Width, Depth: 23 5/8 x 58 5/8 x 6 3/4  
 Glass Viewing: 11 7/8 x 55 1/4  
 Surround Size: 15 5/8 x 59 5/8  
 Shipping Size: 25 1/3 x 64 5/7 x 9  
 Shipping Weight: 107 lbs. Glass Included

### BI-88-SLIM-OD



\*Height, Width, Depth: 23 5/8 x 88 5/8 x 6 3/4  
 Glass Viewing: 11 5/8 x 84 3/4  
 Surround Size: 15 5/8 x 88 1/8  
 \*\*Shipping Size: 25 1/3 x 98 2/5 x 9  
 Shipping Weight: 160 lbs. Glass Included

### INCLUDED ACCESSORIES

The Panorama Slim series come with clear decorative media and our ICE media kit including large glass chunks, clear and blue diamond media and optional black steel surround, plus a remote.



\*Remote control may not be exactly as shown

# DEEP

## REACHING NEW HEIGHTS

The Panorama Deep Series of built-in electric fireplaces have been designed to give you the maximum in flexibility in selecting a unit that perfectly suits your needs. The stylish electric fireplace will be a focal point in any room, indoor or outdoor.

The Deep Series gives you a 12" depth and multiple length options, as well as giving you the

ability to install your fireplace with your choice of finishing material built right to the glass for a "clean face" design or using the provided black metal surround. Your choice – your design!

Featuring the vibrant Fire & Ice® flame set, with just a click of your remote you can easily change the flame color from blue to purple to violet to orange or yellow.

## IDEAL APPLICATIONS

- Residential spaces
- Patios
- Outdoor spaces
- Commercial spaces
- Restaurants
- New construction or renovations

## KEY FEATURES

 Heater & Fan  
Flame operates with or without heat

 Hard-wire ready.  
Thermostat hard-wire ready

 Illuminate decorative media like never before with ambient canopy lighting in 13 colors

 Deep 12" comes with large glass chunks, clear & blue diamond fire glass media, an 11 piece log set, and black steel surround that can be installed if preferred

 Perfect for zone heating. Approx. 500 sq. ft. 4800 BTUs

 FIRE & ICE® Flame presentation.  
Three light strips allow for yellow, orange, blue, violet & rose colored flames

## TECHNICAL SPECS

Volts	120
Amps	12.5
Watts	1500 max
Heater On	1500 watts high, 750 watts low
Rotor Motor	2 at 5 watts
BTU	4800

BI-40-DEEP-OD



\*Height, Width, Depth: 23 5/8 x 38 5/8 x 12  
Glass Viewing Area: 12 x 34 1/4  
Surround Size: 15 3/4 x 38-5/8  
\*\*Shipping Size: 44 7/8 x 14 1/6 x 25 1/3  
Shipping Weight: 93 lbs. Glass Included

BI-50-DEEP-OD



\*Height, Width, Depth: 23 5/8 x 48 1/2 x 12  
Glass Viewing Area: 12 x 45 1/4  
Surround Size: 15 3/4 x 49 1/4  
\*\*Shipping Size: 55 x 14 1/6 x 25 1/3  
Shipping Weight: 111 lbs. Glass Included

### BI-72-DEEP-OD

\*Height, Width, Depth: 23 5/8 x 72 1/8 x 12  
Glass Viewing - 11 7/8 x 68 3/4  
Surround Size - 15 5/8 x 72 1/8  
\*\*Shipping Size - 25 1/3 x 82 1/3 x 14 1/6  
Shipping Weight: 157 lbs. Glass Included



### BI-88-DEEP-OD

\*Height, Width, Depth: 23 5/8 x 88 1/8 x 12  
Glass Viewing Area: 12 x 84 3/4  
Surround Size: 15 3/4 x 88 1/8  
\*\*Shipping Size: 98 2/5 x 14 1/6 x 25 1/3  
Shipping Weight: 197 lbs. Glass Included

### BI-60-DEEP-OD



\*Height, Width, Depth: 23 5/8 x 58 5/8 x 12  
Glass Viewing Area: 12 x 55 1/4  
Surround Size: 15 3/4 x 59 1/8  
Shipping Size: 64 5/7 x 14 1/6 x 25 1/3  
Shipping Weight: 128 lbs. Glass Included

### INCLUDED ACCESSORIES

The Panorama DEEP series come with an 11 piece log set and our ICE media kit including large glass chunks, clear and blue diamond media and optional black steel surround, plus a remote.



\*Remote control may not be exactly as shown



# EXTRA TALL

## REACHING NEW HEIGHTS

Featuring an Extra Tall viewing area that is 18" in height! That is 6" taller than our other Panorama models. It has a deep media tray and comes standard with your choice of an incredible log set, ICE media, pebbles, stones, black glass and vermiculite embers allowing consumers to completely customize the look of their fireplace.

Built with Amantii's FIRE & ICE® Flame presentation made of three color LED light strips allowing for multi-color flame options. With just a click of the included remote control, choose from blue, rose, violet, yellow or orange colored flames. Additional media options available for purchase.

## IDEAL APPLICATIONS

- Residential spaces
- Patios
- Outdoor spaces
- Commercial spaces
- Restaurants
- New construction or renovations

## KEY FEATURES



Heater & Fan



Glass viewing area is 18" in height



Hard-wire ready.  
Thermostat hard-wire ready



Perfect for zone heating. Approx. 500 sq. ft. 4800 BTUs



Rated for indoor & outdoor use  
including bathrooms



FIRE & ICE® Flame presentation.  
Three light strips allow for yellow, orange, blue, violet & rose colored flames

## TECHNICAL SPECS

Volts	120
Amps	12.5
Watts	1500 max
Heater On	1500 watts high, 750 watts low
Heater Off	22 watts
Rotor Motor	2 at 5 watts
BTU	4800

### BI-40-DEEP-XT



\*Height, Width, Depth: 29 1/2 x 38 5/8 x 12 5/8  
Glass Viewing Area: 17 3/4 x 34 1/4  
Surround Size: 21 3/4 x 39 1/8  
\*\*Shipping Size: 47 3/5 x 14 1/2 x 31 1/9  
Shipping Weight: 117 lbs. Glass Included

### BI-50-DEEP-XT



\*Height, Width, Depth: 29 1/2 x 48 5/8 x 12 5/8  
Glass Viewing Area: 17 3/4 x 45 1/4  
Surround Size: 21 3/4 x 49 1/8  
\*\*Shipping Size: 57 3/5 x 14 1/2 x 31 1/9  
Shipping Weight: 146 lbs. Glass Included





### BI-72-DEEP-XT

\*Height, Width, Depth: 29 1/2 x 72 1/8 x 12 5/8  
 Glass Viewing Area: 17 3/4 x 68 3/4  
 Surround Size: 21 3/4 x 72 5/8  
 \*\*Shipping Size: 67 3/5 x 14 1/2 x 31 1/9  
 Shipping Weight: 202 lbs. Glass Included



### BI-88-DEEP-XT

\*Height, Width, Depth: 29 1/2 x 88 5/8 x 12 5/8  
 Glass Viewing Area: 17 3/4 x 84 3/4  
 Surround Size: 21 3/4 x 88 5/8  
 \*\*Shipping Size: 97 1/8 x 14 1/2 x 31 1/9  
 Shipping Weight: 242.50 lbs. Glass Included

### BI-60-DEEP-XT



\*Height, Width, Depth: 29 1/2 x 58 5/8 x 12 5/8  
 Glass Viewing Area: 17 3/4 x 55 1/4  
 Surround Size: 21 3/4 x 59 1/8  
 \*\*Shipping Size: 67 3/5 x 14 1/2 x 31 1/9  
 Shipping Weight: 164 lbs. Glass Included

### INCLUDED ACCESSORIES

The Panorama Extra Tall series comes with your choice of one Design Media Kit, the ICE media set, plus a remote.

\*Remote control may not be exactly as shown



AND CHOICE OF ONE MEDIA KIT:

#### DESIGN-MEDIA-DRIFT-15PCE

Includes an additional 4 mini logs (Not Shown)



#### ICE MEDIA



#### DESIGN-MEDIA-RUSTIC-14PCE



#### DESIGN-MEDIA-BIRCH-15PCE



# PANORAMA SERIES | ELECTRIC FIREPLACES

## FIRE GLASS

Our decorative fire glass media is a beautiful addition to your fireplace. Turn your fireplace into a expressive work of art by simply adding our decorative fire glass media. Our fire glass adds a distinctly modern feel to your gas fireplace - mix colors and textures for a unique appearance.

Our decorative fire glass is tempered and will not melt or degrade, some discoloration is normal on glass that is placed directly on the flame. Always wear protective gloves when handling fire glass media.

One 5lb container of media will cover 1 square foot.

AMSF-GLASS-01



AMSF-GLASS-02



AMSF-GLASS-03



AMSF-GLASS-04



AMSF-GLASS-05



AMSF-GLASS-06



AMSF-GLASS-07



AMSF-GLASS-08



AMSF-GLASS-09



AMSF-GLASS-10



## Decorative Media Options

AMSF-GLASS-11



AMSF-GLASS-12



AMSF-GLASS-13



AMSF-GLASS-14



FI-105-DIAMOND



FI-106-DIAMOND



FI-107-DIAMOND



FI-109 DIAMOND



LOG SET



LRG LOG SET



CLEAR



## DESIGNER MEDIA KITS

Add incredible value with designer media kits including deluxe log sets, glass and stone media and decorative embers.

### DESIGN-MEDIA-BIRCH-10PCE



### DESIGN-MEDIA-OAK-10PCE



### DESIGN-MEDIA-14PCE



### DESIGN-MEDIA-BIRCH-15PCE



### DESIGN-MEDIA-15PCE



### DESIGN-MEDIA-6PCE



Images are not to scale, please visit your local dealer to view the actual accessories.

Variations in the color and shade are inherent in all printing processes, the actual colors may vary slightly from those shown.

**Note:** Log sets and Designer Media Kits will fit in all sizes of the following models - Panorama DEEP, TRU VIEW XL and CUBE ONLY.

(Depending on the size of the fireplace model, some logs may not be needed.)



AM-PANORAMA-US

FEB 2020

Distributed By:

Product updates, specifications and dimensions are subject to change. Please refer to the product manual to verify measurements and clearance requirements. All local building codes must be followed.

*Amantii*

Visit our online showrooms at:

[www.amantii.com](http://www.amantii.com)

877-850-9458



# SYMMETRY SERIES





SYM-50 Bespoke shown with Birch Style Logs

# SYMMETRY SERIES

ELECTRIC FIREPLACES

*Amantii*

# SYMMETRY BESPOKE

## DESIGN INTEGRITY, QUALITY CRAFTSMANSHIP & ATTENTION TO DETAIL

We have expanded on our amazing Symmetry Series with the addition of the Bespoke line. Symmetry Bespoke represents a new generation of Amantii Electric Fireplaces.

Symmetry Bespoke offers versatility to integrate effortlessly in commercial and residential settings ranging from homes, offices, remodeling or new construction. The superior construction ensures a long lasting unit and design integrity at it's core.

Symmetry Bespoke is our most complete fireplace including WIFI integrated options and patented technology.

## KEY FEATURES



### Install option

Can be fully recessed  
Can be semi-flush mounted\* within a 2x4 wall. \*SYM-XS surround required



### Flame Styles

Two flame style patterns - standard and more traditional - you choose!



### Flame presentation

Choose from combinations of yellow, red and orange colored flames



### Heater & Fan

Flame operates with or without heat, perfect for zone heating



### Ambient Canopy Lighting

Choose from 11 colors of light to illuminate decorative media from above



### Digital Touch Pad

For convenient control of features with temperature display

- Patented Screen Remote Control
- Clear Reduced Trim Kit
- Masonry Finish to Trim Option
- 1500W 5118 BTU, heat up 400 sq ft room
- 50000 Hours Lifetime LED Light Source
- Smart Room Temperature Control 59°F–82°F or 15°C–28°C
- Improved flame effect
- Adjustable Flame Brightness
- Adjustable Flame Speed
- Adjustable Ember Bed Colors with possibility to auto mix thousands of colors
- Timer: Regular Timer (1–8 hours) and 7-Day Pre-Set Timer
- Flame and Ember Bed Glow can be on separately
- The most reliable components in industry
- Whisper quiet heater/fan – "the most quiet fireplace in industry"
- Improved 11 Color Downlight
- 5 year warranty

## IDEAL APPLICATIONS

- Residential spaces
- Commercial spaces
- Restaurants
- New construction or renovations
- Outdoor use; refer to installation manual

## TECHNICAL SPECS

Volts	120
Amps	12.5 A
Watts	1500 max
Heater On	1500 watts high, 750 watts low
Heater Off	22 watts
Rotor Motor	1 at 5 watts
BTU	5118

Hidden venting and no grills. The heater is located at the top of the unit allowing heat to cascade down in front of the glass.

## OPTIONAL SURROUNDS

For SYMMETRY Bespoke fireplaces in 50", 60" or SYMMETRY-B fireplaces in 50", 60" & 74" models only. See pages 12 & 13 for more details.

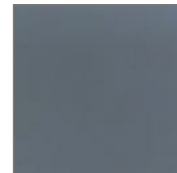

Dark Grey

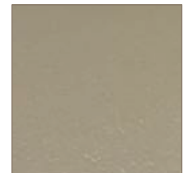

Bronze





**SYM-34-BESPOKE**  
 Height, Width, Depth: 15-5/8 x 32-3/8 x 5-1/2  
 Glass Viewing Opening: 13-1/8 x 30-5/8  
 Surround Size: 16-7/8 x 34-1/2  
 Shipping Weight: 57 lbs Glass Included  
 Media Shown: Clear Ember Glass



**SYM-42-BESPOKE**  
 Height, Width, Depth: 15-5/8 x 42-1/4 x 5-1/2  
 Glass Viewing Opening: 13-1/8 x 40-5/8  
 Surround Size: 16-7/8 x 44-1/4  
 Shipping Weight: 70.50 lbs Glass Included  
 Media Shown: Included Glass Rocks

**INCLUDED ACCESSORIES**

See page 12 for more; and page 13 for flame colors and other details.



**AND CHOICE OF ONE MEDIA KIT:**

**DESIGN-MEDIA-BIRCH-10PCE**



**ICE MEDIA**



FI-109-Diamond

**EMBER**  
 Clear, Suntea, Harvest Moon





**SYM-50-BESPOKE**

Height, Width, Depth: 15-5/8 x 50-1/4 x 5-1/2  
Glass Viewing Opening: 13-1/8 x 48-1/2  
Surround Size: 16-7/8 x 52-1/4  
Shipping Weight: 81.60 lbs Glass Included  
Media Shown: Included Birch Log Set



**SYM-60-BESPOKE**

Height, Width, Depth: 15-5/8 x 60-1/4 x 5-1/2  
Glass Viewing Opening: 13-1/8 x 58-3/8  
Surround Size: 16-7/8 x 62-1/4  
Shipping Weight: 68.30 lbs Glass Included  
Media Shown: Glass Rocks

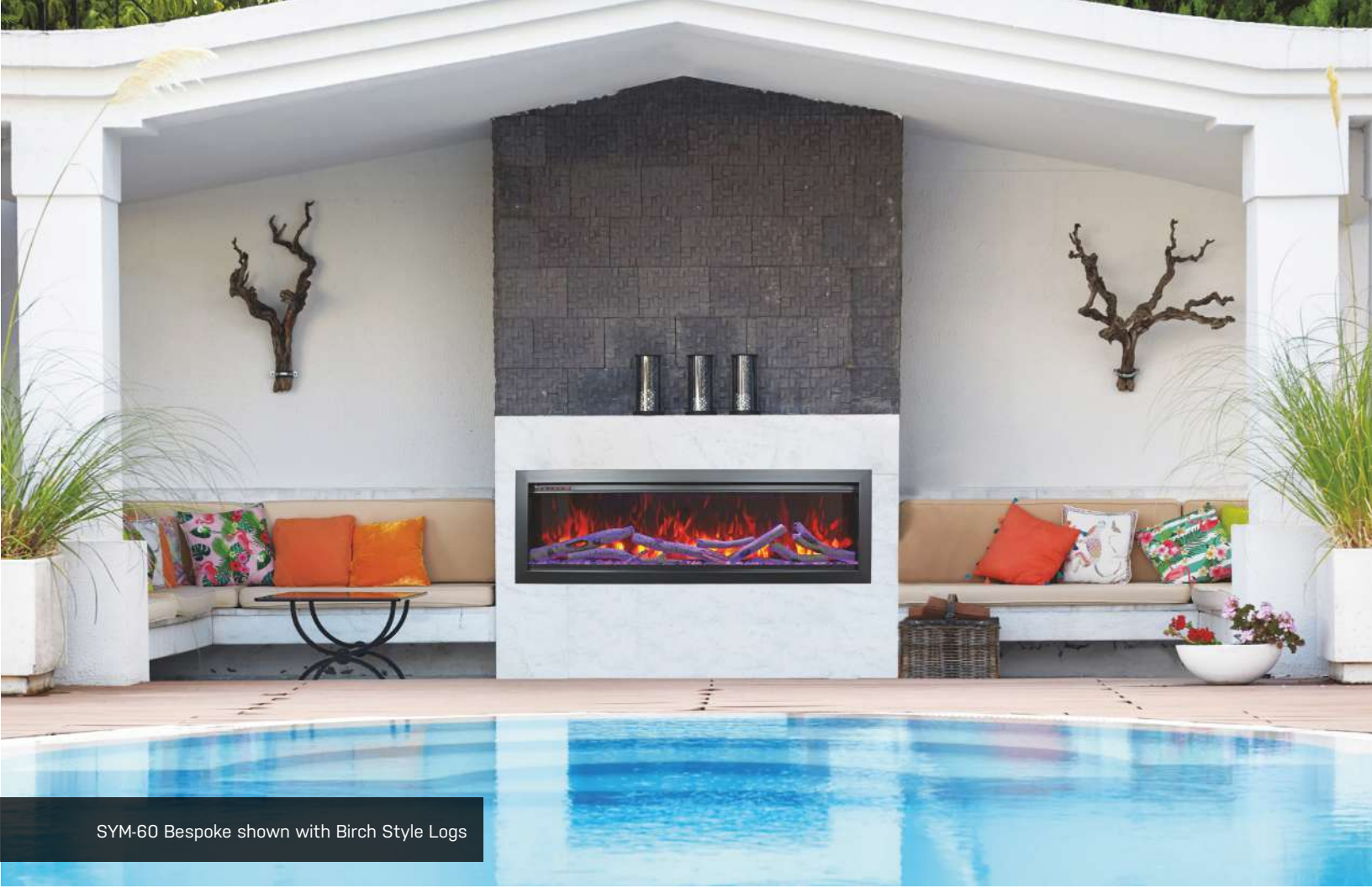

SYM-60 Bespoke shown with Birch Style Logs



SYM-42 Bespoke shown with Birch Style Logs



SYM-34 Bespoke shown with Glass Rocks

# SYMMETRY XT

The SYMMETRY XT by Amantii is taller than the SYMMETRY model and boasts our largest glass viewing area yet. Unencumbered by unsightly venting, the SYMMETRY XT features a stunning true clean face display. New to the SYMMETRY XT are two flame patterns - choose from Amantii's traditional diffused flame appearance or a new realistic flame style. The SYM-74 XT, SYM-88 XT and SYM-100 XT have dual heaters built-in, for double the heat output. The FIRE & ICE® flame presentation doesn't disappoint with yellow, orange, blue, violet & rose colored flames. Please see pages 14 and 15 for more details. Standardized unit sizing means hassle free installation at any stage, inside or outside. The SYM-74 XT, 88-XT and 100-XT all have the option of being hooked up to 240 Volt; which increases heat: 240V, 10A, 2400W, 8191 BTU.

## KEY FEATURES

**Viewing**  
Glass viewing area is 18" tall with no unsightly venting visible

**Heater & Fan**  
Flame operates with or without heat, perfect for zone heating

**Flame Styles**  
Two flame style patterns - standard and more traditional - you choose!

**Ambient Canopy Lighting**  
Choose from 13 colors of light to illuminate decorative media from above

**FIRE & ICE® Flame presentation**  
Choose from combinations of yellow, orange, blue, violet & rose colored flames

**Touch Pad**  
For convenient control of features with temperature display.

## IDEAL APPLICATIONS

- Residential spaces
- Commercial spaces
- Restaurants
- New construction or renovations
- Outdoor use; refer to installation manual

## TECHNICAL SPECS

Volts	120
Amps	13
Watts	1200 max
Heater On	1200 watts high, 600 watts low
Heater Off	22 watts
Rotor Motor	1 at 5 watts
BTU	4500

Hidden venting and no grills. The heater is located at the top of the unit allowing heat to cascade down in front of the glass.

## INCLUDED ACCESSORIES

See pages 14 and 15 for more; and page 13 for flame colors and other details.



AND CHOICE OF ONE MEDIA KIT:

### DESIGN-MEDIA-DRIFT-15PCE

NEW! Now includes an additional 4 mini logs (Not Shown)



### ICE MEDIA



### DESIGN-MEDIA-RUSTIC-14PCE



### DESIGN-MEDIA-BIRCH-15PCE



### SYM-50 XT

Height, Width, Depth: 20-1/8 x 50-1/4 x 11-3/4  
Glass Viewing Opening: 17-5/8 x 48-3/8  
Surround Size: 21-3/8 x 52-1/4  
Shipping Weight: 110.14 lbs Glass Included  
Media Shown: Rustic Log Kit  
6



### SYM-60 XT

Height, Width, Depth: 20-1/8 x 60-1/4 x 11-3/4  
Glass Viewing Opening: 17-5/8 x 58-3/8  
Surround Size: 21-3/8 x 62-1/4  
Shipping Weight: 129.32 lbs Glass Included  
Media Shown: Birch Log Kit



**SYM-74 XT**

Height, Width, Depth: 20-1/8 x 74-1/4 x 11-3/4  
 Glass Viewing Opening: 17-5/8 x 72-3/8  
 Surround Size: 21-3/8 x 76-1/4  
 Shipping Weight: 159.09 lbs Glass Included  
 Media Shown: Drift Wood Kit



**SYM-34 XT**

Height, Width, Depth: 20-1/8 x 32-3/8 x 11-3/4  
 Glass Viewing Opening: 17-5/8 x 32-1/2  
 Surround Size: 21-3/8 x 36-1/4  
 Shipping Weight: 76.84 lbs Glass Included  
 Media Shown: ICE Media



**SYM-42 XT**

Height, Width, Depth: 20-1/8 x 42-1/4 x 11-3/4  
 Glass Viewing Opening: 17-5/8 x 40-3/8  
 Surround Size: 21-3/8 x 44-1/4  
 Shipping Weight: 94.82 lbs Glass Included  
 Media Shown: Drift Wood Kit



**SYM-88 XT**

Height, Width, Depth: 20-1/8 x 88-1/4 x 11-3/4  
 Glass Viewing Opening: 17-5/8 x 86-3/8  
 Surround Size: 21-3/8 x 90-1/4  
 Shipping Weight: 185.22 lbs Glass Included  
 Media Shown: Rustic Log Kit



**SYM-100 XT**

Height, Width, Depth: 20-1/8 x 100-1/4 x 11-3/4  
 Glass Viewing Opening: 17-5/8 x 98-3/8  
 Surround Size: 21-3/8 x 102-1/4  
 Shipping Weight: 207.27 lbs Glass Included  
 Media Shown: ICE Media



SYM-60 XT shown with Birch Style Logs



SYM-74 XT shown with Glass Rocks



SYM-88 XT shown with Glass Rocks



SYM-50 XT shown with Birch Style Logs

# SYMMETRY B

The SYMMETRY B by Amantii is our basic model offering clean, contemporary aesthetics with no visible unsightly heat vents. Featuring our exclusive multi-colored state-of-the-art FIRE & ICE® flame presentation. The slim design allows for versatile applications including semi-flush mount within 2 x 4 walls. Standardized sizing allows for hassle free installation at any stage. Enjoy the warmth and beauty of the SYMMETRY B in your favorite living spaces, inside or outside. Please see page 13 for more details.

## KEY FEATURES

 **Heater & Fan**  
Flame operates with or without heat

 **Perfect for zone heating.**  
Approx. 500 sq. ft. 4500 BTUs

 **Install option**  
Can be fully recessed.  
Can be semi-flush mounted\* within a 2x4 wall. \*SYM-XS surround required

 **FIRE & ICE® Flame presentation**  
Choose from combinations of yellow, orange, blue, violet & rose colored flames

 **Remote**  
For flame & heater

 **Media**  
Clear Glass media is included

## IDEAL APPLICATIONS

- Residential spaces
- Commercial spaces
- Restaurants
- New construction or renovations
- Outdoor use; refer to installation manual

## TECHNICAL SPECS

Volts	120
Amps	13
Watts	1200 max
Heater On	1200 watts high, 600 watts low
Heater Off	22 watts
Rotor Motor	1 at 5 watts
BTU	4500

Hidden venting and no grills. The heater is located at the top of the unit allowing heat to cascade down in front of the glass.

## INCLUDED ACCESSORIES



## OPTIONAL SURROUNDS

For SYMMETRY Bespoke fireplaces in 50", 60" or SYMMETRY-B fireplaces in 50", 60" & 74" models only. See pages 12 & 13 for more details.

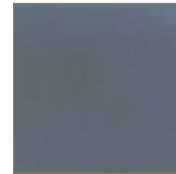

Dark Grey

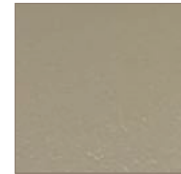

Bronze



### SYM-50-B

Height, Width, Depth: 15-5/8 x 50-1/4 x 5-1/2

Glass Viewing Opening: 13-1/8 x 48-1/2

Surround Size: 16-7/8 x 52-1/4

Shipping Weight: 77 lbs Glass Included

Media Shown: Clear Glass

10



### SYM-74-B

Height, Width, Depth: 15-5/8 x 74-1/4 x 5-1/2

Glass Viewing Opening: 13-1/8 x 72-3/8

Surround Size: 16-7/8 x 76-1/4

Shipping Weight: 108 lbs Glass Included

Media Shown: Clear Glass





**SYM-60-B**  
 Height, Width, Depth: 15-5/8 x 60-1/4 x 5-1/2  
 Glass Viewing Opening: 13-1/8 x 58-3/8  
 Surround Size: 16-7/8 x 62-1/4  
 Shipping Weight: 68.30 lbs Glass Included  
 Media Shown: Clear Glass



**SYM-34-B**  
 Height, Width, Depth: 15-5/8 x 32-3/8 x 5-1/2  
 Glass Viewing Opening: 13-1/8 x 30-5/8  
 Surround Size: 16-7/8 x 34-1/2  
 Shipping Weight: 55 lbs Glass Included  
 Media Shown: Clear Glass



**SYM-42-B**  
 Height, Width, Depth: 15-5/8 x 42-1/4 x 5-1/2  
 Glass Viewing Opening: 13-1/8 x 40-5/8  
 Surround Size: 16-7/8 x 44-1/4  
 Shipping Weight: 68.30 lbs Glass Included  
 Media Shown: Clear Glass



**SYM-88-B**  
 Height, Width, Depth: 15-5/8 x 88-1/4 x 5-1/2  
 Glass Viewing Opening: 13-1/8 x 86-3/8  
 Surround Size: 16-7/8 x 90-1/4  
 Shipping Weight: 130 lbs Glass Included  
 Media Shown: Clear Glass



**SYM-100-B**  
 Height, Width, Depth: 15-5/8 x 100-1/4 x 5-1/2  
 Glass Viewing Opening: 13-1/8 x 98-3/8  
 Surround Size: 16-7/8 x 102-1/4  
 Shipping Weight: 147.70 lbs Glass Included  
 Media Shown: Clear Glass

# SYMMETRY BESPOKE FEATURES

## TWO FLAME STYLE PATTERNS

The SYMMETRY fireplace arrives from the factory with a NEW realistic style flame pattern. Enjoy our FIRE & ICE® flame presentation in a new style that mimics real fire like never before. If you prefer Amantii's traditional diffused flame appearance, simply remove the included stencil.



Log *with* real flame stencil  
Yellow flame with a little Orange



Log *without* real flame stencil  
Yellow flame with a little Orange



Ember Media *with* real flame stencil  
Blue flame



Ember Media *without* real flame stencil  
Blue flame



Ember Media *with* real flame stencil  
Rose flame



Ember Media *without* real flame stencil  
Rose flame



Ember Media *with* real flame stencil  
Purple flame



Ember Media *without* real flame stencil  
Purple flame

## AMBIENT CANOPY LIGHTING

Add more dimension and excitement to your SYMMETRY electric fireplace by illuminating Amantii's decorative media kits (or your own) from above. The ambient canopy lighting is located in the upper part of the fireplace and with the click of a button, choose from 13 colors of light.



Lighting On



Lighting Off

## TOUCH PAD

Convenient touch pad with temperature indicator display.

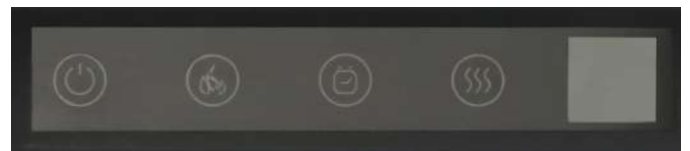

# SYMMETRY BESPOKE & SY

## OPTIONAL SURROUNDS

Add a designer touch to your space with a beautifully finished Dark Grey or Bronze colored surround. These decorative surrounds will compliment either SYMMETRY Bespoke or SYMMETRY-B fireplace in 50", 60" & 74" models only. The surrounds will arrive in a separate package.

# STANDARD FEATURES ON ALL MODELS

## FIRE & ICE® FLAME PRESENTATION COLORS



Yellow flame



Yellow Orange flame



Red flame



Orange Yellow flame



Blue flame



Purple flame



Rose flame

## CLEAN FACE NO UNSIGHTLY VENTING

Unlike models made by other manufacturers, SYMMETRY models are unencumbered by unsightly venting. Venting and grills take away from the aesthetics of a fireplace and the SYMMETRY series have some of the biggest glass viewing areas in the industry. You'll see more of what is important - a beautiful, warm and comforting flame display.



## HASSLE FREE INSTALLATION

The SYMMETRY has been made with standardized unit sizing. This means that the opening for the fireplace can be made at any stage of a build, the appliance can be easily installed and finished with the included surround at the end of a project. The surround beautifully completes the fireplace without the need for finicky or costly finishing.

## SYMMETRY-B OPTIONS

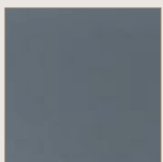

Dark Grey

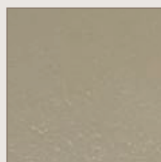

Bronze

## FOR SEMI-FLUSH MOUNT INSTALLATION

For rooms where space may be at a premium, SYMMETRY Bespoke & SYMMETRY-B models can also be partially recessed within a 2 x 4 wall. The unit will sit 2" outside of the wall with 4" of the unit mounted inside.

- This install option requires the Semi-Flush Mount Surround (SYM-XS) to finish the look of the fireplace.
- The Semi-Flush Mount Surround has a black finish and has a depth of 2 1/4"
- The Semi-Flush Mount Surround must be purchased separately. Ships in a separate box.
- This application is only applicable to the SYMMETRY Bespoke & SYMMETRY-B models. XT models must be fully recessed.

# SYMMETRY XT FEATURES

## TWO FLAME STYLE PATTERNS

The SYMMETRY fireplace arrives from the factory with a NEW realistic style flame pattern. Enjoy our FIRE & ICE® flame presentation in a new style that mimics real fire like never before. If you prefer Amantii's traditional diffused flame appearance, simply remove the included stencil.



Birch Logs *with* real flame stencil  
Yellow flame with a little Orange  
Ambient Canopy Lighting: On



Birch Logs *without* real flame stencil  
Yellow flame with a little Orange  
Ambient Canopy Lighting: On



Rustic Logs *with* real flame stencil  
All Yellow  
Ambient Canopy Lighting: On



Rustic Logs *without* real flame stencil  
All Yellow  
Ambient Canopy Lighting: On



Drift Logs *with* real flame stencil  
All Yellow All Orange flame  
Ambient Canopy Lighting: On



Drift Logs *without* real flame stencil  
All Yellow All Orange flame  
Ambient Canopy Lighting: On



Glass Rocks *with* Flame Mold  
Blue flame  
Ambient Canopy Lighting: Off

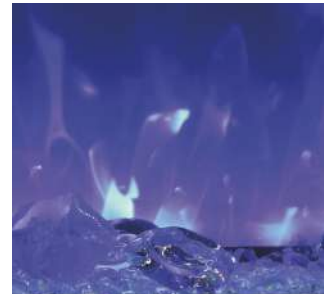

Glass Rocks *without* real flame stencil  
Blue flame  
Ambient Canopy Lighting: Off



Glass Rocks *with* real flame stencil  
Rose flame  
Ambient Canopy Lighting: On



Glass Rocks *without* real flame stencil  
Rose flame  
Ambient Canopy Lighting: Off



Ember Rocks *with* Flame Mold  
Yellow flame  
Ambient Canopy Lighting: On



Ember Rocks *without* real flame stencil  
Yellow flame  
Ambient Canopy Lighting: On

## TOUCH PAD

Convenient touch pad with temperature indicator display.

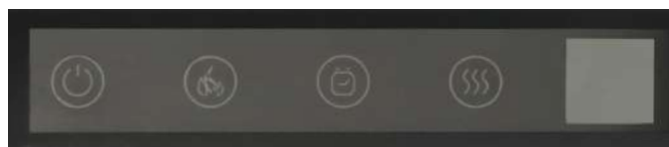

## AMBIENT CANOPY LIGHTING

Add more dimension and excitement to your SYMMETRY electric fireplace by illuminating Amantii's decorative media kits (or your own) from above. The ambient canopy lighting is located in the upper part of the fireplace and with the click of a button, choose from 13 colors of light.



Lighting On



Lighting Off

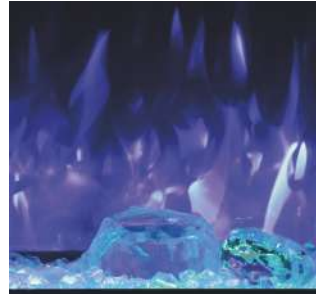

Lighting On



Lighting Off

## TALL VIEWING AREA

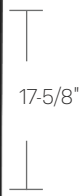

17-5/8"

SYM-50XT

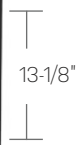

13-1/8"

SYM-50



13-1/8"

SYM-50B

## EXTRA DEEP TRAY

At 12" in depth the extra deep tray accommodates more decorative media than any other unit on the market.

## DUAL HEATERS ON SELECT XT MODELS

The SYM-74 XT, SYM-88 XT and SYM-100 XT have dual heaters built-in, for double the heat output.



AM-SYM-US FEB 2020

Distributed By:

We reserve the right to update products, specifications and dimensions are subject to change. Please refer to the product manual to verify measurements and clearance requirements. All local building codes must be followed.

*Amantii*

Visit our online showrooms at:  
[www.symmetryfireplace.com](http://www.symmetryfireplace.com)  
[www.amantii.com](http://www.amantii.com)



# WMFM & WMFML SERIES







WM-FM-72-8123-BG  
with optional Birch Logs

# WM-FM & WM-FML

LINEAR ELECTRIC FIREPLACES  
INDOOR

*Amantii*

# WM-FM GLASS

## WALL MOUNT FLUSH MOUNT GLASS SURROUND

The Wall Mount/Flush Mount series features an exclusive Fire and Ice flame presentation. Simply wall mount or built in flush with the included brackets.

Heat is emitted from a single slot in the face of the surround. 13 colors of surround back-lighting illuminate spaces creating even more ambiance. All



Built-In Flush Mount / Wall Mount fireplaces come standard with a driftwood style log set and optional decorative media of EMBER or FIRE & ICE® media are available for purchase.

A standard surround included in the box for the WM FM series is black - White glass surrounds are available for additional purchase.

## IDEAL APPLICATIONS

- Residential spaces
- Commercial spaces
- Restaurants
- New construction or renovations
- Places where construction is not an option (wall mount)

## KEY FEATURES

-  Heater & Fan  
Flame operates with or without heat
-  Hard-wire ready.  
Thermostat hard-wire ready
-  Illuminate decorative media like never before with 13 colors of surround back-lit moodlighting

-  New driftwood style log set included
-  Perfect for zone heating. Approx. 500 sq. ft. 4800 BTUs
-  FIRE & ICE® Flame presentation.  
Three light strips allow for yellow, orange, blue, violet & rose colored flames
-  White glass surrounds available for purchase.

## TECHNICAL SPECS

Volts	120
Amps	13
Watts	1500 max
Heater On	1500 watts high, 750 watts low
Heater Off	22 watts
Rotor Motor	1 at 5 watts
BTU	4800

## INCLUDED ACCESSORIES

Amantii WM-FM Glass Front Series comes with installed log set, plus a remote.



\*Remote control may not be exactly as shown

## WM-FM GLASS SERIES

7 sizes to choose from. White glass surrounds available for purchase. See page 7 for more details.

### SERIES MODELS:

- |   |                   |
|---|-------------------|
| WM-FM-26-3623-BG  | WM-FM-34-4423-BG  |
| WM-FM-48-5823-BG  | WM-FM-60-7023-BG  |
| WM-FM-72-8123-BG  | WM-FM-88-10023-BG |
| WM-FM-50-BG (does not have the surround back-light feature) |                   |



### WM-FM-48-5823-BG

Height, Width, Depth: 23 x 57 1/2 x 6 3/4  
Glass Viewing Area: 45 1/2 x 10  
\*\*Shipping Size: 59 5/8 x 8 1/4 x 24 1/2  
Shipping Weight: 81 lbs Glass Included



### WM-FM-50-BG

Height, Width, Depth: 23 x 51 x 6 3/4  
Glass Viewing Area: 45 1/2 x 10  
\*\*Shipping Size: 61 x 10 1/4 x 26 1/4  
Shipping Weight: 84 lbs Glass Included  
\*NOTE: WM-FM-50-BG does not have the surround back-light feature.



**WM-FM-60-7023-BG**

\*Height, Width, Depth: 23 x 69 1/4 x 6 3/4  
 Glass Viewing Area: 57 1/4 x 10  
 \*\*Shipping Size: 71 1/2 x 8 1/4 x 24 1/2  
 Shipping Weight: 97 lbs. Glass Included



**WM-FM-26-2623-BG**

\*Height, Width, Depth: 23 x 35 1/2 x 6 3/4  
 Glass Viewing Area: 23 1/2 x 10  
 \*\*Shipping Size: 38 3/4 x 9 1/8 x 25 1/4  
 Shipping Weight: 53 lbs Glass Included



**WM-FM-34-4423-BG**

\*Height, Width, Depth: 23 x 43 1/2 x 6 3/4  
 Glass Viewing Area: 31 1/2 x 10  
 \*\*Shipping Size: 47 1/4 x 9 1/8 x 25 1/4  
 Shipping Weight: 53 lbs Glass Included



Shown with optional 10 piece Birch

**WM-FM-72-8123-BG**

\*Height, Width, Depth: 23 x 81 x 6 3/4  
 Glass Viewing Area: 69 x 10  
 \*\*Shipping Size: 83 1/4 x 8 1/4 x 24 1/2  
 Shipping Weight: 113 lbs Glass Included



**WM-FM-88-10023-BG**

\*Height, Width, Depth: 23 x 100 x 6 3/4  
 Glass Viewing Area: 86 x 10  
 \*\*Shipping Size: 102 5/8 x 8 1/4 x 24 1/2  
 Shipping Weight: 139 lbs Glass Included



# WM-FML STEEL



## WALL MOUNT FLUSH MOUNT STEEL SURROUND

Sierra Flame by Amantii's Steel Linear Series featuring a deep charcoal colored steel surround. The steel surround has aesthetic proportions and features a touch pad with a numerical temperature display. Heat is emitted through the face below the glass viewing area allowing for a flush mount installation. If recessing is not an option, this model is also wall mountable and perfect in apartments of in places where renovation or construction is not an option.

Available in 6 sizes, you'll find a unit that is perfect for any space in your home, business or commercial space. Boasting our FIRE & ICE® presentation with three color LED strips allowing for a multi-color flame options. With just a click of the included remote control choose from blue, rose, violet, yellow or orange colored flames. The WM-FML-STL series comes standard with clear decorative media. Further media options available for additional purchase.

## KEY FEATURES

-  Heater & Fan
-  Hard-wire ready.  
Thermostat hard-wire ready
-  Illuminate decorative media like never before with 13 colors of surround back-lit moodlighting

-  Perfect for zone heating. Approx. 500 sq. ft. 4800 BTUs
-  FIRE & ICE® Flame presentation.  
Three light strips allow for yellow, orange, blue, violet & rose colored flames

## IDEAL APPLICATIONS

- Residential spaces
- Commercial spaces
- Restaurants
- New construction or renovations
- Places where construction is not an option (wall mount)

## TECHNICAL SPECS

Volts	120
Amps	13
Watts	1500 max
Heater On	1500 watts high, 750 watts low
Heater Off	22 watts
Rotor Motor	1 at 5 watts
BTU	4800

## WM-FM GLASS SERIES

6 sizes to choose from. Further media options available for additional purchase.

### SERIES MODELS:

- WM-FML-26-3223-STL
- WM-FML-34-4023-STL
- WM-FML-48-5523-STL
- WM-FML-60-6623-STL
- WM-FML-72-7823-STL
- WM-FML-88-9623-STL



WM-FML-48-5523-STL

\*Height, Width, Depth: 22 1/2 x 55 x 7 1/8  
Glass Viewing Opening: 45 1/2 x 10  
\*\*Shipping Size: 27 2/5 x 58 2/3 x 10 1/2  
Shipping Weight: 79 lbs. Glass Included



WM-FML-60-6623-STL

\*Height, Width, Depth: 22 1/2 x 66 x 7 1/8  
Glass Viewing Opening: 57 1/4 x 10  
\*\*Shipping Size: 27 2/5 x 70 4/9 x 10 1/2  
Shipping Weight: 91.50 lbs. Glass Included



**WM-FML-72-7823-STL**  
 \*Height, Width, Depth: 22 1/2 x 78 x 7 1/8  
 Glass Viewing Area: 69 x 10  
 \*\*Shipping Size: 27 2/5 x 82 1/6 x 10 1/2  
 Shipping Weight: 114 lbs. Glass Included



**WM-FML-26-2623-BG**  
 \*Height, Width, Depth: 22 1/2 x 32 x 7 1/8  
 Glass Viewing Area: 23 1/2 x 10  
 \*\*Shipping Size: 27 2/5 x 36 2/3 x 10 1/2  
 Shipping Weight: 52 lbs. Glass Included



**WM-FML-34-4023-STL**  
 \*Height, Width, Depth: 22 1/2 x 40 x 7 1/8  
 Glass Viewing Area: 31 1/2 x 10  
 \*\*Shipping Size: 27 2/5 x 44 2/3 x 10 1/2  
 Shipping Weight: 61 lbs. Glass Included



**WM-FML-88-9623-STL**  
 \*Height, Width, Depth: 22 1/2 x 96 x 7 1/8  
 Glass Viewing Opening: 86 x 10  
 \*\*Shipping Size: 27 2/5 x 99 1/5 x 10 1/2  
 Shipping Weight: 137 lbs. Glass Included

### INCLUDED ACCESSORIES

Sierra Flame WM-FML Steel Series comes with clear decorative media, plus a remote.



*\*Remote control may not be exactly as shown*

# WM-FM/WM-FML SERIES | ELECTRIC FIREPLACES

## FIRE GLASS

Our decorative fire glass media is a beautiful addition to your fireplace. Turn your fireplace into a expressive work of art by simply adding our decorative fire glass media. Our fire glass adds a distinctly modern feel to your gas fireplace - mix colors and textures for a unique appearance.

Our decorative fire glass is tempered and will not melt or degrade, some discoloration is normal on glass that is placed directly on the flame. Always wear protective gloves when handling fire glass media.

One 5lb container of media will cover 1 square foot.



## Decorative Media Options



## WHITE GLASS SURROUNDS

Brighten up any space with a cool contemporary white glass surround. White glass surrounds are optional for additional purchase and are available for the shown models only.

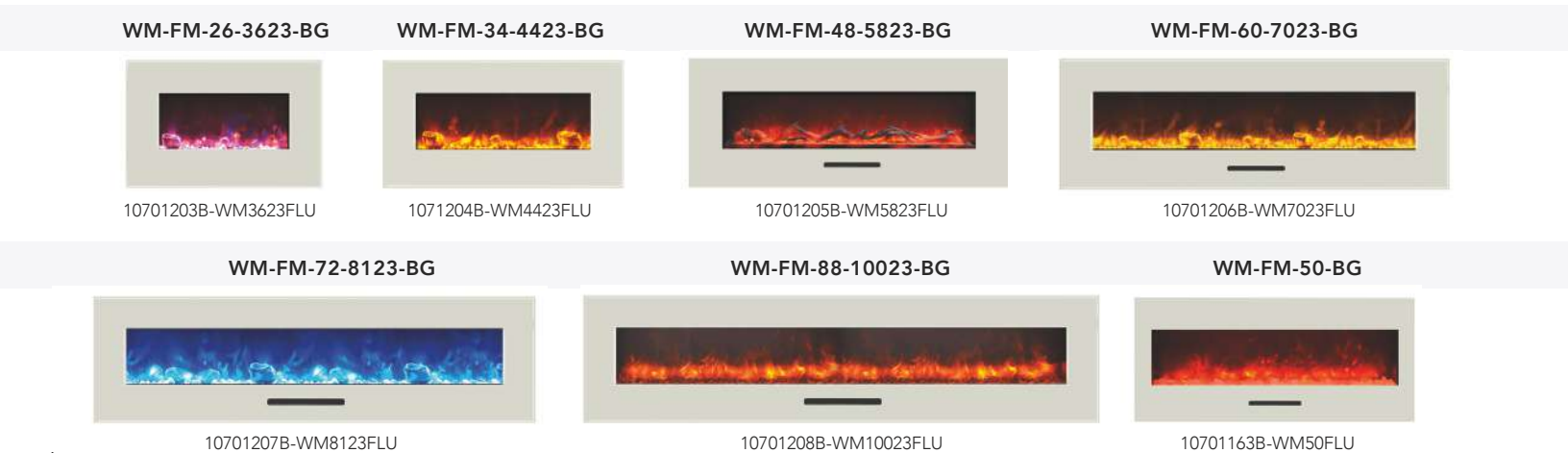

## DESIGNER MEDIA KITS

Add incredible value with designer media kits including deluxe log sets, glass and stone media and decorative embers.

### DESIGN-MEDIA-BIRCH-10PCE



### DESIGN-MEDIA-OAK-10PCE



### DESIGN-MEDIA-14PCE



### DESIGN-MEDIA-BIRCH-15PCE



### DESIGN-MEDIA-15PCE



### DESIGN-MEDIA-6PCE



Images are not to scale, please visit your local dealer to view the actual accessories.

Variations in the color and shade are inherent in all printing processes, the actual colors may vary slightly from those shown.

**Note:** Log sets and Designer Media Kits will fit in all sizes of the following models - Panorama DEEP, TRU VIEW XL and CUBE ONLY.

(Depending on the size of the fireplace model, some logs may not be needed.)



AM-PANORAMA-US

FEB 2020

Distributed By:

Product updates, specifications and dimensions are subject to change. Please refer to the product manual to verify measurements and clearance requirements. All local building codes must be followed.

*Amantii*

Visit our online showrooms at:

[www.amantii.com](http://www.amantii.com)  
877-850-9458





# DISTRIBUTOR COPY – SHOWROOM USE ONLY



TRD-48 shown with Birch

*\*While we place great care into preparing product images, descriptions and prices, sometimes technical and typographical errors or omissions may occur. Canned Heat group of companies cannot be held responsible for such errors and we apologize for any inconvenience this may cause.*

AMSF-CATALOG-US

FEB 2020

Distributed By:



*Amantii*

Visit our online showrooms at:

[www.amantii.com](http://www.amantii.com)

877-850-9458

Product updates, specifications and dimensions are subject to change. Please refer to the product manual to verify measurements and clearance requirements. All local building codes must be followed.