

V1.0

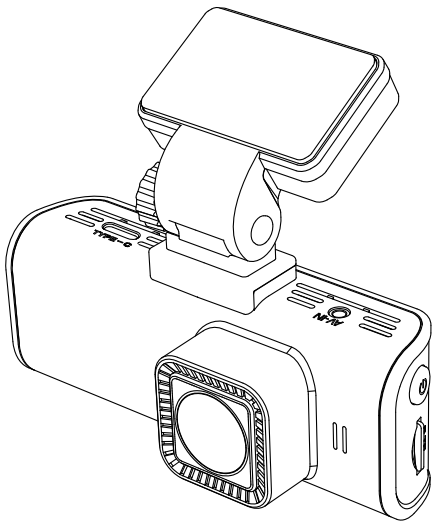

REDTIGER
CAM GOOD



F7N User Manual

redtigercam.com

The information in this manual is subject to change without notice.

Content

Notice	2
Product Specifications	3
Package Contents	4
Appearance	5
Buttons and Functions	6
User Interface Overview	8
Function Overview	11
App and Wi-Fi Function	14
How to Play Using a Computer	16
Installation	18
Troubleshooting	22
Customer Service Center	24

Notice

- Please read this manual carefully before operation and keep it for future reference. It will be helpful should you encounter any operational problems.
- Improper installation will void the manufacturer's warranty. The installation instructions do not apply to all types of vehicles and are written as guidelines to assist in installing the system.
- Consult with an experienced technician if you are not comfortable installing the device on your own.
- Please make sure to read and understand local laws and regulations regarding cameras and their use in a vehicle. Laws may vary by state.
- Do not obscure the view of the road ahead or obstruct the deployment of any airbags in the event of an accident.
- When not in use, please disconnect the car adapter from both the 12/24V DC outlet in your vehicle and the device itself.
- Only clean the device with a soft dry cloth, for tough dirt, apply some neutral detergent diluted in 5 to 6 parts water on a soft cloth.
- Note that alcohol, thinner, benzene, etc. could cause damage to the paint or coatings on the device.
- Avoid making contact with the lens as this may cause damage.
- The video recordings made by this device are intended for personal use only.
- While driving, do not adjust the controls of your device, as it may draw your attention from your surroundings.

Product Specifications

Item Name	F7N Dash Cam	Video Format	MP4
Screen Size	3.18" IPS Screen	Photo Format	JPG
Recording Resolution	Front 2160P @30fps / Front 1440P @60fps Front 1080P @120fps / Front 2160P+Rear1080P Front 1440P+Rear1080P		
Input	DC 5V-2.5A	Lens	Front cam F1.55 Rear camera F2.0
Operating Temperature	-4°F~158°F		
Memory Card	32GB-256GB	Warranty Period	1 Year

Note:

If you have any problems during use, we will provide free device replacement within 1 year of purchase, in addition to lifetime technical support.

Extended Warranty Service:

You may also receive an additional 6 months of extended warranty service by registering your device on our website.

URL: <https://www.redtigercam.com/pages/warranty-form>

Package Contents

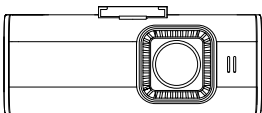

• F7N 4K Dash Cam

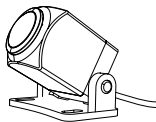

• 1080P Rear Camera

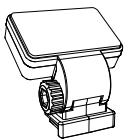

• GPS Mount

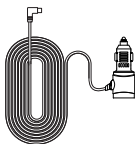

• Power Supply Cable with Car Charger



• Rear Cam Cable



• 64GB Memory Card



• Electrostatic Sticker *2

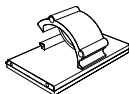

• Cable Clips*5



• User Manual

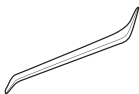

• Tool



• 3M Adhesive

Appearance

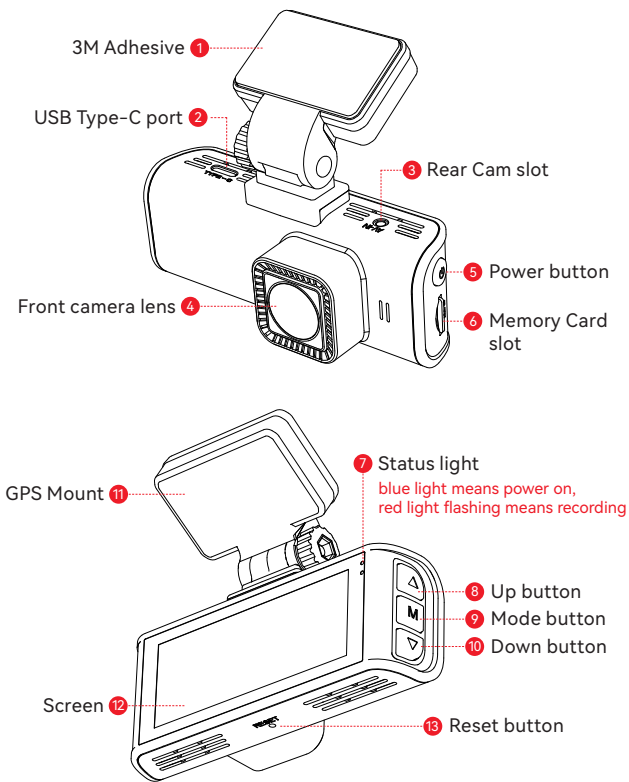

Buttons and Functions



Power Button

Recording Mode:

- Short press-to Switch screen
- Long press-to Turn off the Camera

Setup Mode:

- Short press-to Return to the previous screen

Playback Mode:

- Short press-to Return to the previous screen



Menu Button

Recording Mode:

- Short press to Enter main menu

Setup Mode:

- Short press-to Enter/Confirm specific settings

Playback Mode:

- Short press-to Select and play the specific file
- Long press-to Delete/Lock/Unlock the specific file



Up Button

Recording Mode:

- Short press-to Lock the recording file
- Long press-to Turn on or off Wi-Fi

Setup Mode:

- Short press-to Select the previous function

Playback Mode:

- Short press-to Select the previous file
- Short press-to Fast rewind (while video is playing)



Down Button

Recording Mode:

- Short press-to Take a snapshot
- Long press-to Stop recording

Setup Mode:

- Short press-to Select the next function



Playback Mode:





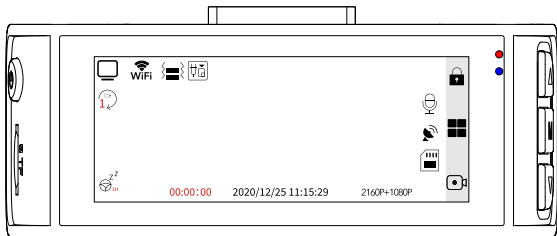





- Short press-to Select the next file
- Short press-to Fast forward (while video is playing)

User Interface Overview

• Recording Mode



Icon	Description
	Generates in 1 min/3 mins/5 mins per file
	Display when fatigue driving function is on
00:00:00	Displays the recording status and recording time
2020/12/25 11:15:29	Display the date and time of the machine
2160P+1080P	Display recording resolution
	Show Memory Card status

Icon	Description
	Display GPS status
	Display voice recording status
	Indicates that the rear camera is connected
	G-Sensor sensitivity display
	Wi-Fi status
	Emergency Video Lock
	Photograph function
	Enter the menu
	Power on
	Red led blinking: Recording Video/No Red led:Not Recording Video

• Playback Mode

- 1 Press the M button to enter Playback mode.
- 2 Press the Up or Down button to select the folder you want to play, then press the M button to enter.

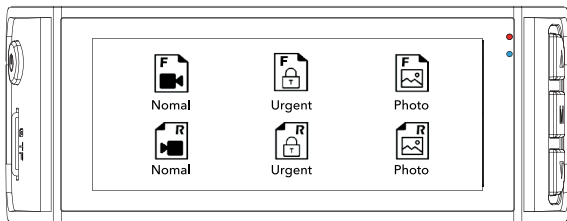



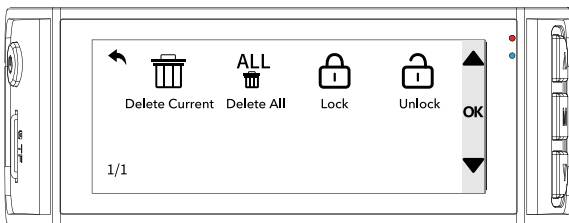



















- 3 Press the M button to watch the recorded video.
- 4 Long press the M button for 3 seconds to edit your recorded videos.









Function Overview

Short press the M button to enter the settings menu, where you can adjust various functions and parameters of the camera.

icon	Function	Option/Description
	Audio	Sound Recording ON/OFF
	Resolution	2160P+1080P, 1440P+1080P
	Date Stamp	Stamp ON/OFF
	Loop recording	1/3/5mins
	G-sensor	Off/Low/Medium/High
	Fatigue Driving	A Reminder Will be Made During 1h/2h/3h/4h/OFF
	Speed Stamp	Stamp ON/OFF
	GPS Stamp	ON/OFF
	Speed Units	KMH/MPH
	GPS Info	Display GPS signal strength

icon	Function	Option/Description
	Rear Cam Flip	Vertical Flip Your Rear View
	Mirror Flip	Horizontal Flip Your Front View
	App	A QR Code for Redtiger app
	Wi-Fi	ON/OFF
	Language	Choose Your Preferred Language
	Time Format	12h/24h
	Date / Time	Update With GPS
	Time Zone	Choose Your Time Zone
	DST	Daylight Saving Time ON/OFF
	Frequency	60Hz/50Hz
	Click Tone	ON/OFF
	Screen Saver	OFF/10s/30s/2mins, Screen goes off after the set time

icon	Function	Option/Description
	Parking Mode	Please connect the ACC hardwire kit
	Format Reminder	Reminder to Clear Data
	Format	Format Memory Card. All data will be deleted
	Card Speed	Card Speed Detection
	Default Setting	Reset All Settings
	Version	Software Version
	Help Center	Scan the QR code to contact us

Note:

- In order to ensure a smooth user experience, it is suggested that you format your memory card once a month.
- When you change the Click Tone setting to OFF, the startup and shutdown sounds will also be turned off.

App and Wi-Fi Function

• How to connect Wi-Fi?

1. Download the app

You can download the app from:

- Official Website: <https://www.redtigercam.com/pages/app>
- QR Code located on your dash cam (may be located on the right side)
- Search “Redtiger” in the Apple App Store or Google Play Store



2. Turn on the Wi-Fi on the dash cam, the Wi-Fi and SSID and password will appear on the display.
3. Open Redtiger App> jump to the Wi-Fi connection interface according to the steps> find the Wi-Fi of the dash cam> enter the password to connect.
(The default password is 12345678)
4. After successfully connecting to Wi-Fi, return to the App to use it.

• View/Download/Delete/Share Video

1. Click the icon on the main interface to view video and image files.
2. Long press the video file to select it, then choose whether you would like to download or delete it.
3. Return to the App home page and select the Album> Open and watch/share it.

• App Home

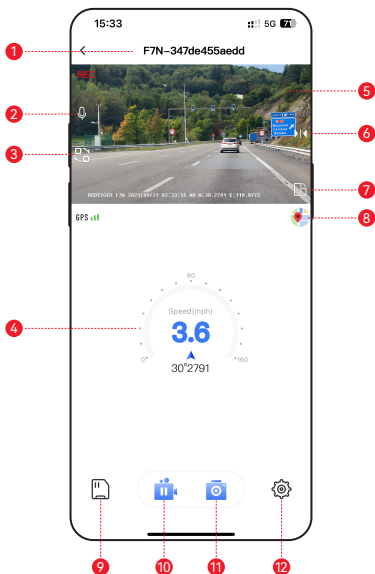

- | | |
|--|------------------------------|
| 1 Native Wi-Fi Name | 2 Turn on/off recorded sound |
| 3 Switch recording screen | 4 GPS information |
| 5 Video play window | 6 Mirror Flip |
| 7 Rotate the video screen left and right | 8 Map |
| 9 Dash cam file | 10 Pause/start recording |
| 11 Take pictures | 12 Dash cam settings |

• Over-The-Air Updates

Note: Please update the Redtiger App to the latest version to use this function.

1. To perform an over-the-air update, disconnect your phone from the dash cam's Wi-Fi network. Connect your phone to LAN (not the dash cam's Wi-Fi) for 5 seconds, then disconnect. Reconnect to the dash cam's Wi-Fi network.
2. Once Wi-Fi connection is successful, open the Redtiger App to start using it. If new software is detected, the App page will indicate the availability of an update.
3. To perform the update, click on "Upgrade Now". The Redtiger app will prompt you to download the update package.
4. Connect the dash cam to send the update package. Do not power off the dash cam during the upgrade process. Once the upgrade is completed, the app will display the upgrade success message, and the dash cam will automatically restart.

How to Play Using a Computer

We recommend using REDTIGER Player as the correct video player to watch/play videos. It can also view Google Maps.

You can Download it for free on Mac or Windows from the following link: <https://www.redtigercam.com/pages/gps-player>

You can choose different playback modes in Settings > Video Playback Mode. You can set playback speed, language, map, and various other functions.

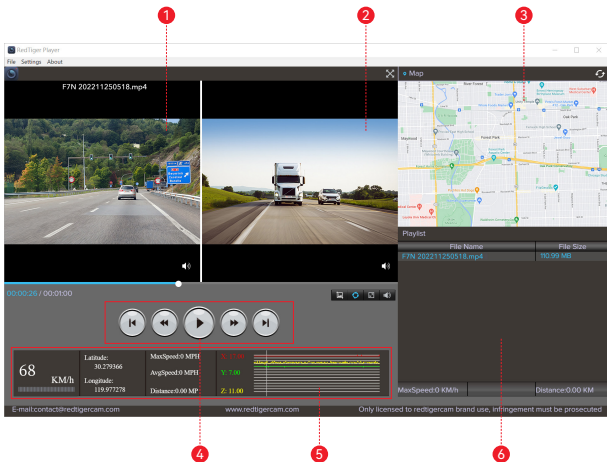

- ① Video play window (Front)
- ② Video play window (Rear)
- ③ Map and track display
- ④ Play control panel
- ⑤ Speed and driving state indication
- ⑥ Play list

Note:

If the video files of front and rear road tracks are recorded synchronously and loaded into the playing list at the same time, they can be played separately in split left and right screens.

When you find the desired video file, hold down the left mouse button and drag the desired files to the video play window to play it.

Installation

⚠ WARNING

Please make sure to connect all cameras and wires before powering on the camera screen, otherwise the camera will not work properly. Please follow the instructions below for the first-time installation of the Redtiger dash cam.



Scan the QR code on the right to view the installation tutorial video.



• Insert Memory Card

Insert the memory card into the dash cam, ensuring that it is oriented correctly so that the gold contacts are facing towards the screen of the dash cam. Push the memory card until it clicks into the slot.

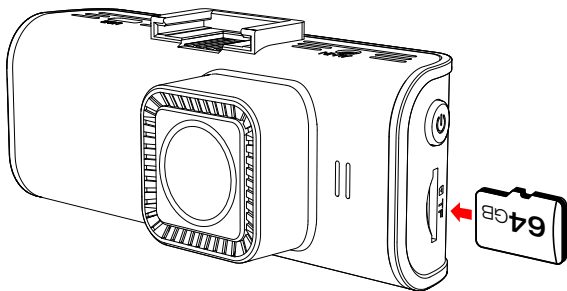

• Front Camera Installation

Peel off the electrostatic sticker on the cellophane and transfer it to where you want to stick it. Attach the front camera to the electrostatic sticker and firmly press to secure it.

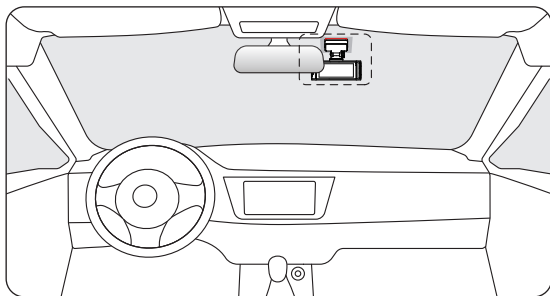
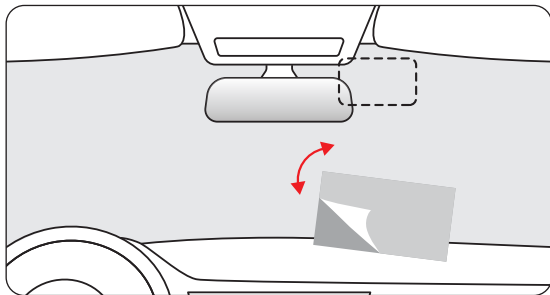

• Mount The Rear Camera

- 1 Open the trunk of the vehicle, remove the screws, remove the plastic panel.
- 2 Pry open the license plate light and pass the rear camera cable through the hole where the license plate light is located.

Note:

This rear camera is specially designed to tolerate a variety of environmental conditions, and is better suited installed on the outside of the vehicle. The lens parameters are set with the assumption that the camera will be used outside, therefore it is recommended that you install the camera on top of the license plate frame. If this is not possible, we have a license plate frame bracket to solve this issue.

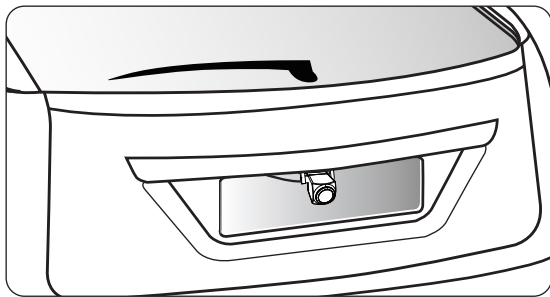

• Wire Layout In The Vehicle

- 1 The car charger is connected to the cigar socket.
- 2 Connect the other end of the car charger to the dash cam.

- 3 Use the crowbar to run the power cable along the front windshield and the roof, and hide the cable down the A-pillar, so as not to block the driver's sight and cause danger.

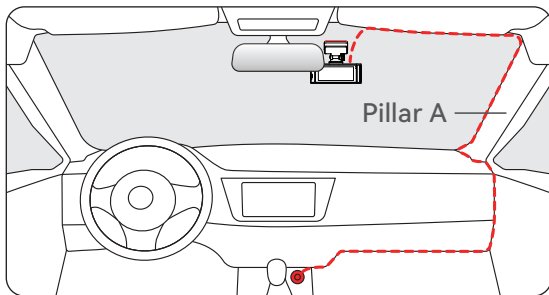

- 4 Connect the rear camera cable to the port on the dash cam.
- 5 Hide the rear camera cable along the gaps between the front windshield and the ceiling, between the car body and the ceiling on the side of the passenger seat, and between the rear seats and the ceiling.

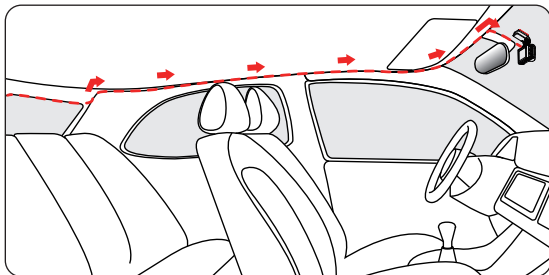

Troubleshooting

• Why is there no GPS signal?

1. Disconnect and clean the cable and port of any dust that may have accumulated around the dash cam. Check for any interference in your car, like metal film on the windshield, a radio antenna, or radar detector.
2. Move your car to an open area. Observe if the GPS icon on the screen turns green and displays GPS information.
3. Once the GPS locks on to a signal, a satellite icon will appear at the bottom left of the screen. Green indicates positioning, while white indicates no positioning.

• How to turn off the on/off music of dash cam?

Please go to Settings > Click Tone > Off.

When the click tone is turned off, the power on and off music will also be turned off.

• Why does my dash cam prompt “Card Error” or “Please Format Memory Card” occasionally?

Please follow the steps below to check:

1. Please go to Settings > Format Reminder to check whether the regular format reminder is enabled.
2. Format the Memory Card.
3. Restore factory settings and restart the dash cam.
4. Update the firmware.

• Device restarts repeatedly/no boot?

1. Ensure you're using the included charger/cables.
2. Remove the memory card, camera cable, and car charger and reinstall them. Check if an issue was caused by the accessories.
3. Reset the device using the button at the bottom of the

camera.

4. If the issue persists, connect the dash cam to a computer using a USB cable. If the device powers on, the issue may be caused by the car charger cable. If it does not power on while connected, there may be an issue with the dash cam itself.
5. Please go to the official website to update the firmware.
6. If it is not resolved, please contact our dedicated customer service for a replacement.

• **Why "Mass storage" appears on the screen?**

"Mass storage" happens when you use a USB cable with data transfer mode causing the dash cam to enter transfer mode. In this mode, data can only be transferred; no other functions work. For best results, use the original car charger or a USB cable without data transfer mode.

• **Why can't I connect to Wi-Fi?**

1. Check the working distance of Wi-Fi, about 15ft.
2. Check the SSID and password of the Wi-Fi, or whether there are other devices connected to the Wi-Fi.
3. Turn off mobile data, security software, and VPN on your phone.
4. If the issue persists, please contact customer support for assistance.

• **Why is the time setting incorrect?**

The dash cam features built-in GPS. It automatically adjusts time based on your location and time zone, eliminating the need for manual time changes. And you can adjust the time through Settings > Time Zone/DST.

Customer Service Center

If you have any problems with the function or installation of your dash cam, please feel free to reach out to us.



Help Center



WhatsApp



For more information:

After Sales: help@redtigercam.com

Business Cooperation: contact@redtigercam.com

Customer Phone Service: +1 888 966 8028 (US)



REDTIGER

CAM GOOD

Check us out here.
Product and service are the foundation of Redtiger.

Instagram: @redtiger_dashcam
Facebook: Redtiger Dash Cam



www.redtigercam.com