

# BUILD↑TUFF

Smarter Building Systems



## ↑TUFFBLOCK

Installation Guide  
to help builders  
Build on.



DISCOVER SMARTER



100% Recycled  
and Recyclable

Each TuffBlock  
weighs only 1.5lbs



Each TuffBlock can  
support 1,700lbs

[buildtuff.com.au](http://buildtuff.com.au)



# TUFFBLOCK

## REPLACES HEAVY CONCRETE BLOCKS USED IN THE FLOATING FOUNDATION DECK BLOCK SYSTEM

Since the inception of Deck Blocks in 1988 in the USA, instant foundation blocks have been the preferred method for creating a strong and stable foundation for many professional & DIY projects worldwide. The concept has literally revolutionised the way we look at deck & raised platform construction, with millions of projects completed each year using the system.

TuffBlock's are made of high strength closed loop recycled polyolefin material with an ultra high UV rating. Designed with a ventilated underside to prevent moisture buildup and deter termites. TuffBlock's are the only block product that are able to be secured to the post/bearer for extra stability.

An individual TuffBlock can support over 770 kgs (1,700 lbs) and weighs only 680 grams (1½ lbs). Designed to accept 35-47mm (2" x 4", 2" x 6", 2" x 8") Joists and 90 x 90mm - 100 x 100mm (4" x 4") Posts, TuffBlocks truly are the lightest, most versatile and easy to use deck foundation system on the market.

Unique to the TuffBlock is the ability for low level decking, it is now possible to build a deck as low as 165mm (6½ inches) without the need for digging. No more ugly concrete blocks in your yard. The slimline profile and satin black finish means a TuffBlock easily blends into the landscape and surrounds.

TuffBlocks are more than just a deck foundation, they are a versatile utility block that can be used for an endless number of applications.



## BUILT TO ACCEPT JOISTS, BEARERS AND POSTS FOR BOTH LOW PROFILE AND RAISED DECKS



90mm

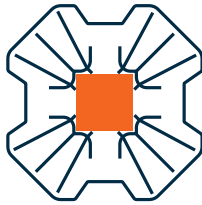

100mm

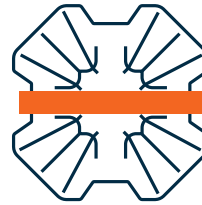

35 – 41mm

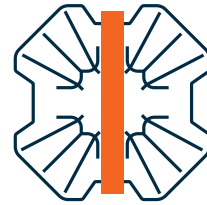

41 – 47mm



Low Profile



Raised

TuffBlocks are not designed for use in structures elevated more than 1 metre (39 inches) from the ground and should be installed on stable ground (see [www.buildtuff.com.au](http://www.buildtuff.com.au) for more details). As always, it is recommended to check your local building guidelines before starting any construction - we always suggest you get the thumbs up before starting your project.

## MAXIMUM 1.5 METRES SPACING BETWEEN TUFFBLOCKS

### Set-up for 2400mm, 3000mm and 3600mm Support Boards



### Set-up for Support Boards End to End



### Set-up for raised and uneven platforms

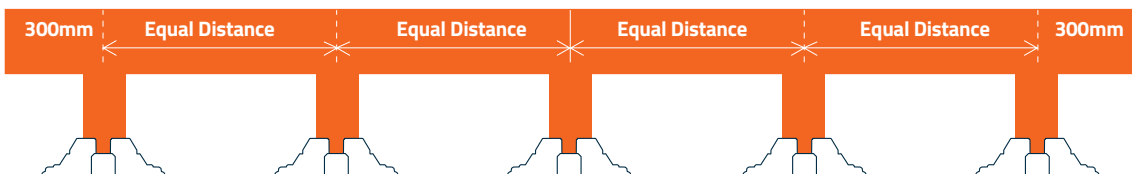

The general rule of thumb is to space joists at 450mm (18 inches) centers (maximum). This spacing depends on your decking or platform material so check with your timber supplier for project specific recommendations. Joists can sit directly on TuffBlocks (e.g. TuffBlock - joists - decking/platform) or on top of a substructure (e.g. TuffBlock - bearers - joists - decking/platform).

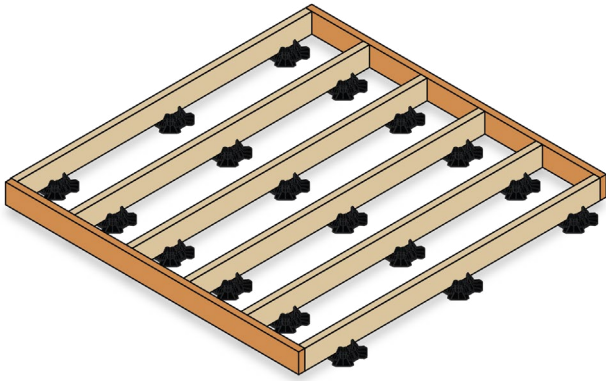

## ULTRA-LOW PROFILE DECKS

Floating foundation systems have always been flawed when it comes to low profile decking. Due to TuffBlock's extremely low design, decks as low as 165mm (6½ inches) are now a possibility.

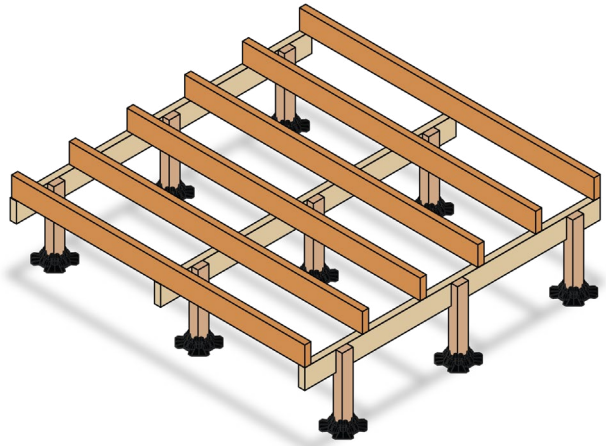

## RAISED DECKS

Tuffblock's allow for use with 90 x 90mm - 100 x 100mm (4" x 4") Posts, allowing your deck to be elevated to any height desired.\*

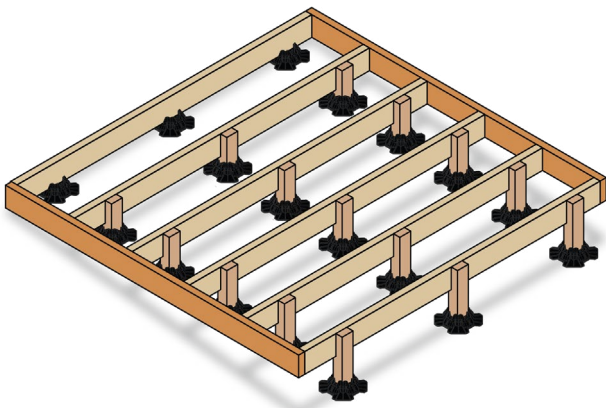

## VARIABLE HEIGHT DECKS

Got a sloping or uneven surface? Due to TuffBlock's incredible adaptability variable height decks are a breeze to install.

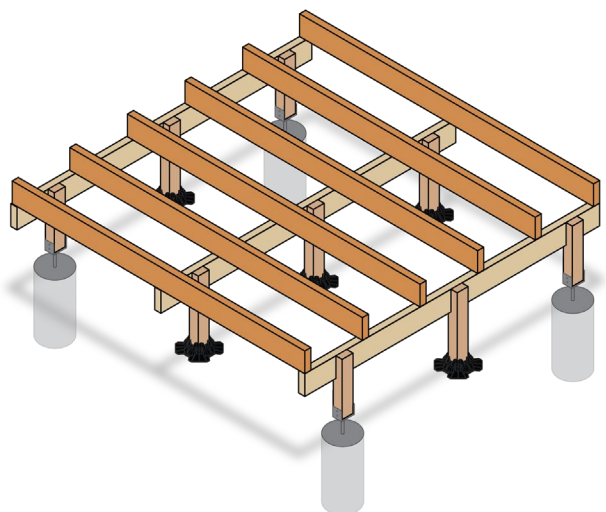

## HYBRID FOOTING DECKS

Should you wish to lock down your project, it is possible to use TuffBlock's in combination with the traditional concrete and steel support method (TuffBlocks become an intermediate support). This is an excellent option for those looking to build in high wind load areas.

\* TuffBlocks are not designed for use in structures elevated more than 1 metre (39 inches) from the ground and should be installed on stable ground (see [www.buildtuff.com.au](http://www.buildtuff.com.au) for more details). As always, it is recommended to check your local building guidelines before starting any construction - we always suggest you get the thumbs up before starting your project.

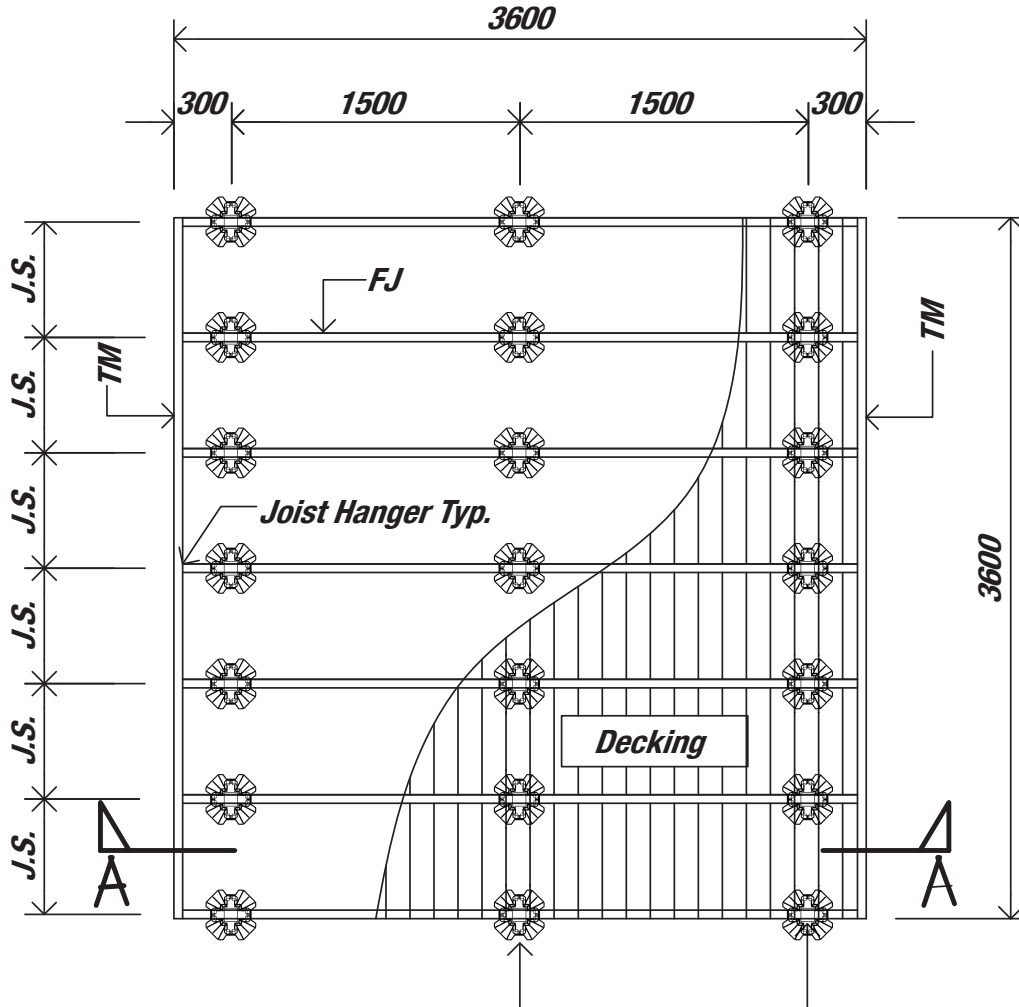

**OPTION 1**

- J.S.** Joist Spacing = 450mm (Centres)
- Decking** 90x22 H3 Treated Pine
- FJ** 120x45 MGP10 H3 Treated Floor Joists @ 450 CRS (Continuous)
- TM** 120x45 MGP10 H3 Treated Trimmer
- Post** 100x100 MGP10 H3 Treated

**OPTION 2**

- J.S.** Joist Spacing = 600mm (Centres)
- Decking** 90x35 H3 Treated Pine
- FJ** 140x45 MGP10 H3 Treated Floor Joists @ 600 CRS (Continuous)
- TM** 140x45 MGP10 H3 Treated Trimmer
- Post** 100x100 MGP10 H3 Treated

**Section A-A**

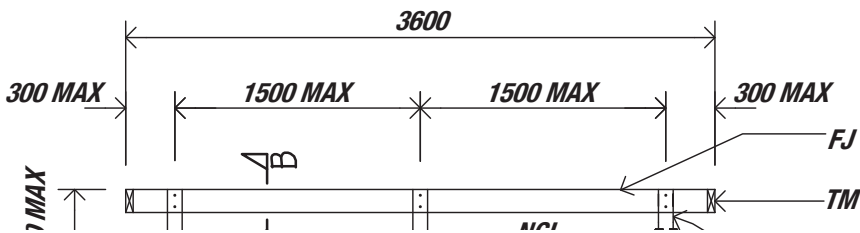

**Section B-B**

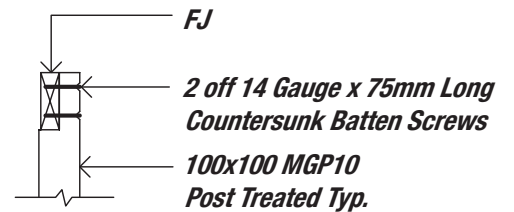

**GLOSSARY**

**J.S.** - Joist Spacing **FJ**- Floor Joists **TM** - 120x45 MGP10 H3 Treated Trimmer

NOTE: The above deck system is only suitable to construct on site class of A, S & M with compacted soil surface. Verify with your local building department before starting any construction.

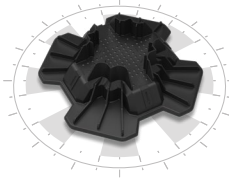

## PRECAUTIONS

### HOW TO POSITION TUFFBLOCKS ON AN UNEVEN SURFACE

In the event of placing a TuffBlock on uneven surface, please note that in no circumstances are you to 'build up' the footing beneath the TuffBlock. In every instance the underneath footing must be dug out in order for the TuffBlock to be level ground prior to commencing your project. (see images below)

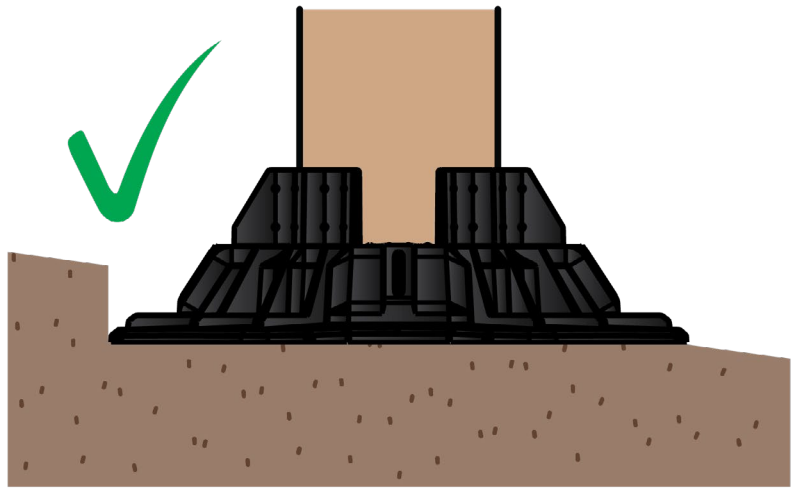
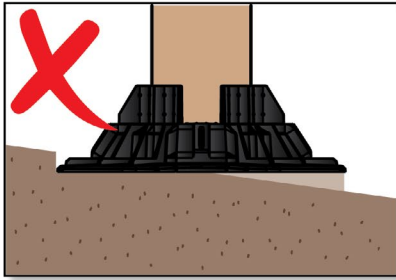
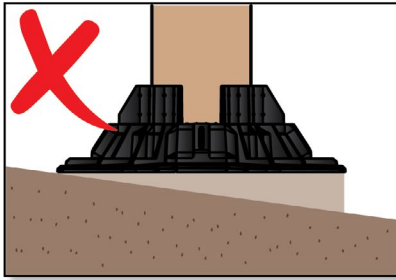

### DO NOT MODIFY, CUT, OR MANIPULATE TUFFBLOCKS

By modifying the TuffBlocks in any way shape or form may severely detract from it's structural integrity and not be able to perform it's designed task. Failure to adhere to this may lead to damage to property, injury or death.



# TUFFBLOCK

## INSTALLATION GUIDE

### DISCOVER SMARTER

The following illustrations are of an example deck build approximately 3 x 3 metres on a sloping surface using the following materials:

- ✓ TuffBlocks
- ✓ 90 x 90mm Posts
- ✓ 45 x 90mm Joists
- ✓ 90 x 18mm Decking boards
- ✓ Hardware (Nails, screws, brackets etc.)

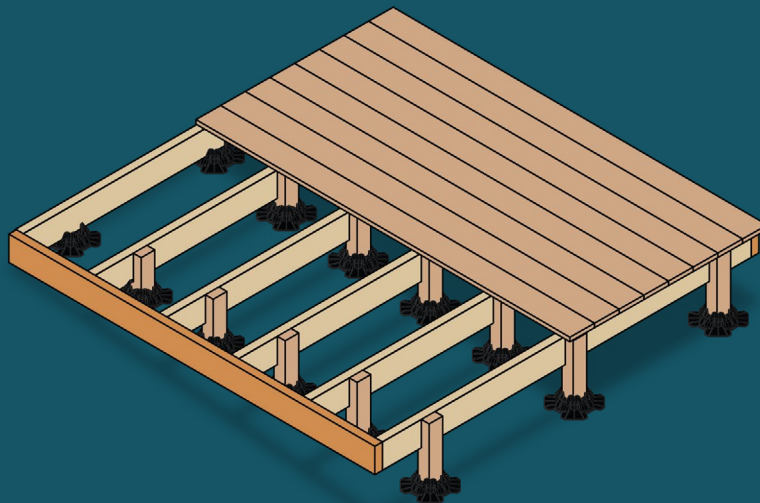

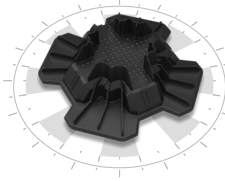

## STEP 1

### PLACE THE TWO CORNER TUFFBLOCK PIERS CLOSEST TO AN EXISTING STRUCTURE.



Place the TuffBlocks directly on the ground. If the ground is sloped, remove top soil from directly underneath the block until the block sits level. If the deck is going to be an extension of an existing structure, then the blocks should be as close to the structure as possible. Using the plan on the previous page, ensure the blocks are correctly spaced. The outside edge of the finished deck will extend out past the center of the TuffBlock piers by 350mm (14 inches) on both sides.



Don't spend an excessive amount of time leveling the TuffBlock piers. The block can be leveled with only your eye. Any slight difference will be made up with the post. However, you want to make sure the TuffBlock piers are sitting FLAT. You do not want any rocking of the piers on the ground.

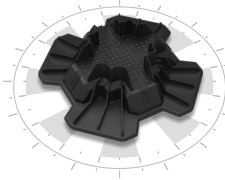

## STEP 2

### LEVEL THE FLOOR JOIST.

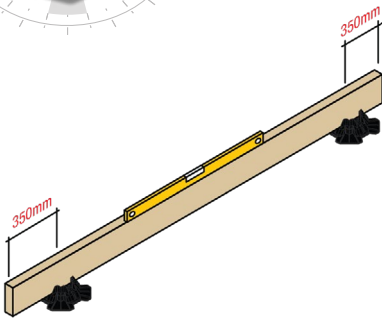

Locate the highest TuffBlock pier. Position a floor joist in or above this first block to your desired height. If the entire deck will be elevated, you will need to have a post in the first TuffBlock.

Place a floor joist in the slot of the TuffBlock pier or on the post and extend over the second corner TuffBlock pier. Now, using a level on top of the floor joist, measure the distance from the top of the floor joist to the bottom of the pocket in the TuffBlock pier. Next cut a post to length allowing for B-B and position the floor joist on top. Make sure to verify that the floor joist is level. Do not attach the floor joist to the post yet.

If the entire deck is to be elevated you will first need to establish the height of the first post, once this is completed continue following the directions above.

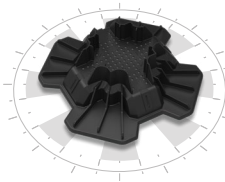

## STEP 3

### POSITION AND LEVEL REMAINING CORNER TUFFBLOCK PIERS.

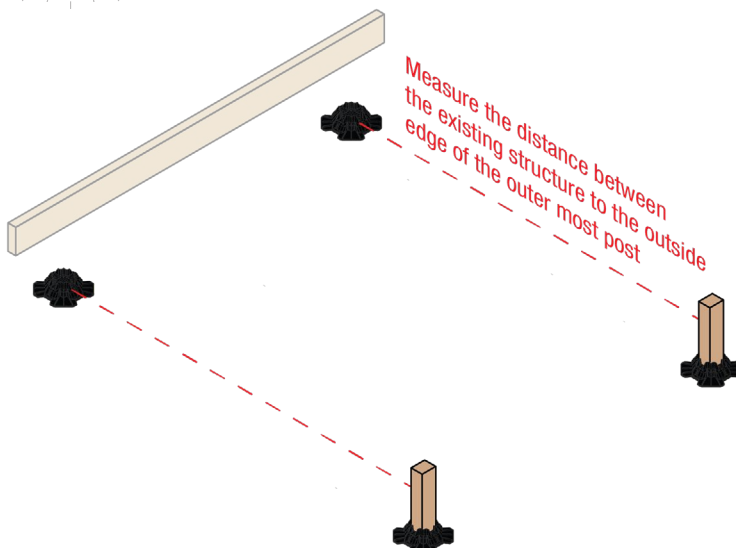

If building off an existing structure, measure from the structure to the outside edge of the post. (For example: If the deck will be 3 metres / 10 feet deep, position the block so that the outside edge of the post is 3 metres / 10 feet from the structure.) Do NOT use the first row of blocks as a measuring reference. Use the same width between the TuffBlock piers as the first row.



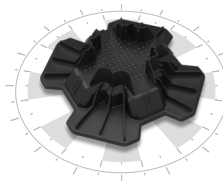

## STEP 4

### POSITION AND LEVEL REMAINING CORNER TUFFBLOCK PIERS.

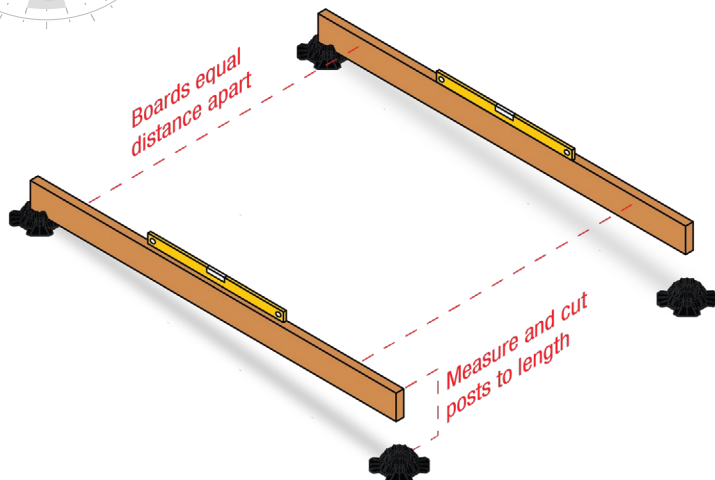

Next, remove the first floor joist closest to the structure. Temporarily position a trim board on top of the first row's post or block, and extend it to the outside corner block. Using a level on top of the trim board, measure the distance from the top of the trim board to the bottom of the pocket on the TuffBlock pier. Cut a post to length. Verify the trim board is level. When level, remove the trim board and repeat for opposite the side.

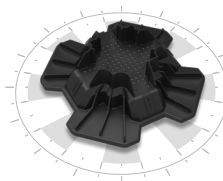

## STEP 5

### PLACE THE TWO CORNER TUFFBLOCK PIERS CLOSEST TO AN EXISTING STRUCTURE.

Place the TuffBlocks directly on the ground. If the ground is sloped, remove top soil from directly underneath the block until the block sits level. If the deck is going to be an extension of an existing structure, then the blocks should be as close to the structure as possible. Using the plan on the previous page, ensure the blocks are correctly spaced. The outside edge of the finished deck will extend out past the center of the TuffBlock piers by 350mm (14 inches) on both sides.

Don't spend an excessive amount of time leveling the TuffBlock piers. The block can be leveled with only your eye. Any slight difference will be made up with the post. However, you want to make sure the TuffBlock piers are sitting FLAT. You do not want any rocking of the piers on the ground.

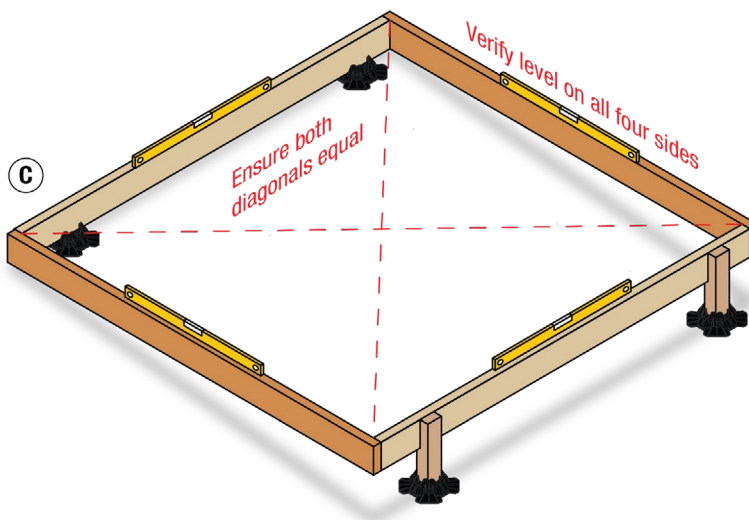

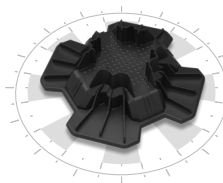

## STEP 6

### ATTACH REMAINING FLOOR JOISTS.

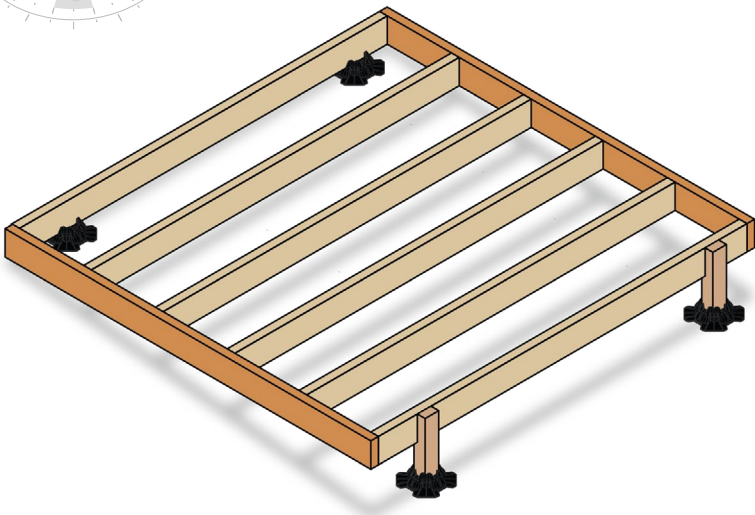

Position and attach the remaining floor joists to the trim boards using two 75mm (3 inches) counter sunk batten screws to attach the floor joist to the trim board.

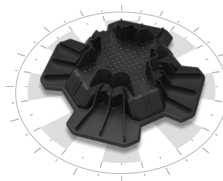

## STEP 7

### POSITION REMAINING TUFFBLOCK PIERS.

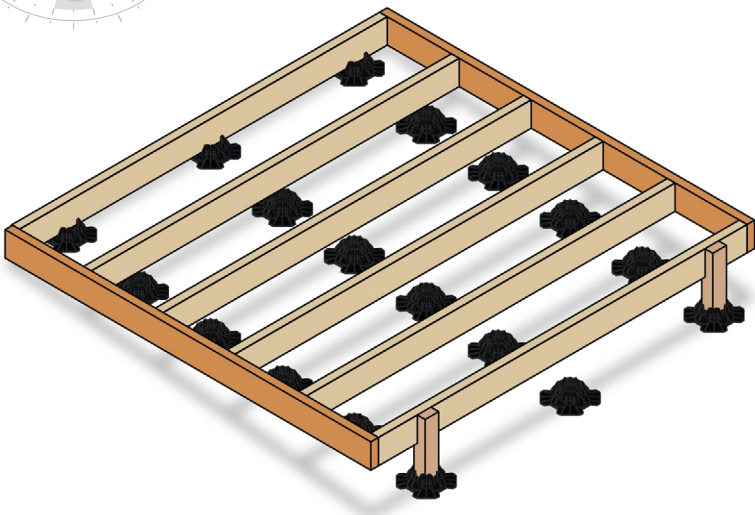

Using the frame as a guide, position the remaining TuffBlock piers directly beneath the frame. The blocks on the perimeter of the deck should be 300mm (12 inches) in from each end.

When positioning the blocks, the dimensions do not need to be exact, however, do not exceed the maximum span of 1.5 metres (5 feet) between blocks, just be sure to have all of the TuffBlock Piers aligned in a straight row and spaced evenly.

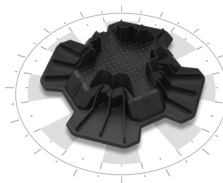

## STEP 8

### FILL THE REMAINING POSTS.

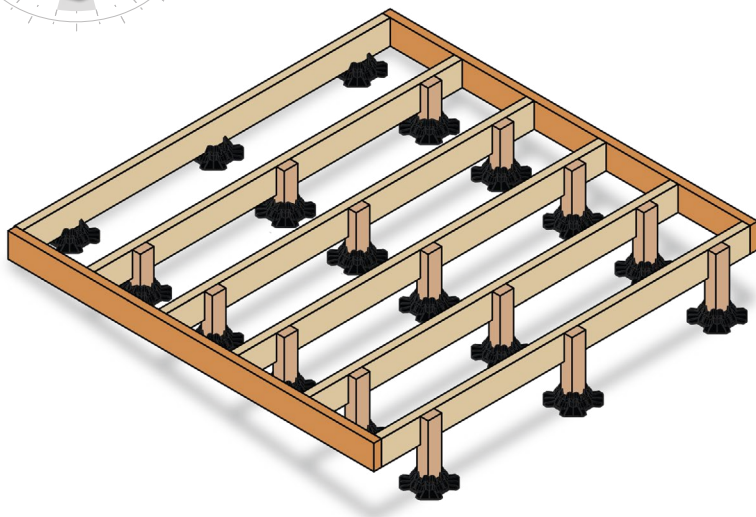

Cut posts to length and position them between the floor joist and the TuffBlock pier. Repeat this step until all posts are cut and positioned. Next, secure all floor joists and posts using two 75mm (3 inches) counter sunk batten screws.

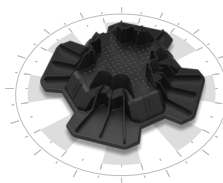

## STEP 9

### ATTACH THE DECKING.

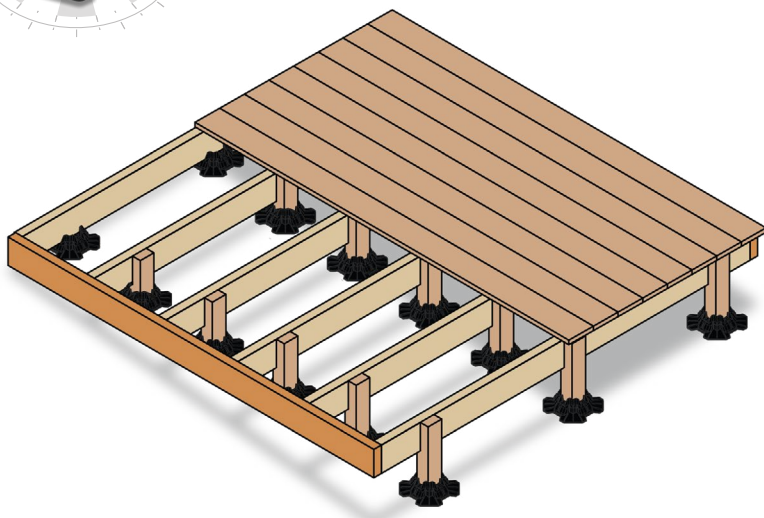

Starting from one side of the deck, attach the first decking board so it's flush to the edge of the deck. The decking board will overhang the first floor joist closest to the existing structure. Leave a 3mm to 6mm (0.125 - 0.25 inch) gap between the end of the decking board and the edge of the structure. Next, secure the remaining decking boards as per manufacturers instructions.

**BUILD↑UFF**

Smarter Building Systems

ENGINEER / MANUFACTURE / SUPPLY

[buildtuff.com.au](http://buildtuff.com.au)