

*Best Friend Mobility*



**USER'S MANUAL**



**Quad/Full Support Dog Wheelchair  
(Large)**

# TABLE OF CONTENTS

- INTRODUCTION ..... 1
  
- PRODUCT INFORMATION ..... 2
  - Measure Your Pet ..... 2
  
- ASSEMBLY ..... 6
  - Expanded View of Parts ..... 6
  - Assembling the Wheelchair ..... 9
  
- FITTING YOUR DOG TO THE WHEELCHAIR ..... 30
  
- ADDITIONAL MEASUREMENTS ..... 45
  
- CARE AND MAINTENANCE ..... 48
  
- CONTACT US ..... 49

# INTRODUCTION

## Best Friend Mobility® Rehabilitation Aids

Dear Pet Owner and Valued Customer:

The following guidelines, along with the attached assembly and fitting instructions, will help you get the best use of your dog wheelchair.

Please read and follow the Assembly instructions carefully before making any attempt to place your pet in the wheelchair. Should you encounter any problems with assembly and fitting, please call Best Friend Mobility directly through our hotline **(843) 492-5283**.

If you think you need a different size, we can process the exchange for you easily. Just contact us at **support@dogwheelchairscenter.com** or call our hotline.

This is a learning process and can take time. We realize that both you and your pet are most likely unfamiliar with the use of a dog wheelchair so do not hesitate to contact us for help. Please be advised that most dogs do not intuitively know how to use a wheelchair, and they will require training and practice. Some dogs may be afraid at first, so it is important to give positive reinforcement when placing them in the chair, especially for the first time.

Use treats. Treats held in front of your pet will encourage it to take steps and move forward; this will teach them to ambulate while in the chair. It may take several training sessions before a dog is able to actually use the chair. It is okay and normal if your dog does not take to the chair right away.

It is very important, especially with skittish animals, that they come into physical contact with the wheelchair in some way every day. This should always be coupled with positive reinforcement like praise, pets, and treats. This will help to create a positive association with the wheelchair and help the animal to eventually to love the wheelchair and be able to learn to use it. This process may take from days to months, so please don't lose hope, persistence will pay off. Contact us for any help or questions.

Thank you for purchasing a Best Friend Mobility dog wheelchair. Again, we love receiving feedback, stories, photos, and videos of how your pets are doing in their wheelchairs.

Sincerely,

*Tim Cantrell*

TIM CANTRELL

Vice President

Best Friend Mobility

Phone: (843) 492-5283



# PRODUCT INFORMATION

One, two, three, four, we're telling our best buds we love them more.

Because sometimes all four legs and paws need is just a little extra help. Introducing the Best Friend Mobility Quad/Full Support Dog Wheelchair. Made from the same light yet sturdy materials as our rear support pet wheelchairs, our new Quad/Full Support Dog Wheelchair are for pets with both forelimb and hind limb disabilities.

The Quad/Full Support Dog Wheelchair is made to fit dogs as prescribed in the measurement category shown below.

## MEASURE YOUR PET

Measure your pet to confirm that you have the correct size Best Friend Mobility Quad/Full Support wheelchair for your pet.

The only information you truly need to get the right size is the measurement from the floor to your pet's back—at its hindquarters. It's that simple!

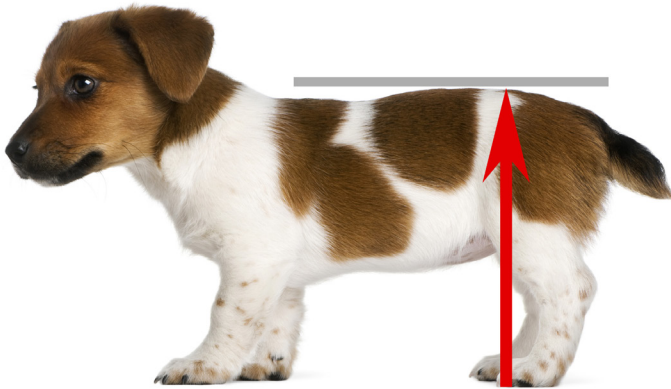

Depending on your pet's current capabilities and its willingness to cooperate, this can be a 1-person or 2-person job.

If your pet has very little or no rear-limb strength, one person can be the support while the other does the measuring.





## QUAD SUPPORT WHEELCHAIR SIZE CHART

XS	9"-14"
S	13"-17"
M	16"-20"
L	20"-27"

### Specifications:

- Lightweight, non-rust aluminum
- Stainless steel hardware
- Fully and easily adjustable height, length, and width
- Deluxe neoprene front and rear harness for comfortable support
- All terrain polyurethane wheels with sealed bearings
- Easy clip-on front harness system
- Comfortable paw slings
- Durable and easy-to-clean rear harness

### The Quad/Full Support Dog Wheelchair is best for:

- Advanced stages of degenerative myelopathy (DM)
- Cervical spondylomyelopathy (CSM) or wobblers syndrome
- Multiple injury rehabilitation
- Unilateral or bilateral forelimb weakness
- Strokes and other neurological disorders
- Pets with amputations
- Instability in the forelimbs or on all four legs
- Pets with deformity in the forelimbs or on all four legs



# ASSEMBLY

Let us begin with the assembly by checking out all the pre-assembled parts and tools.



Pre-assembled parts and tools

## EXPANDED VIEW OF PARTS

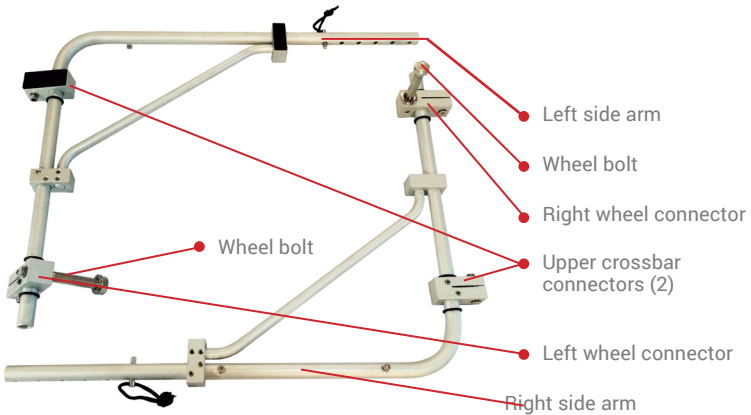

A. Left and Right Side Arm Assembly

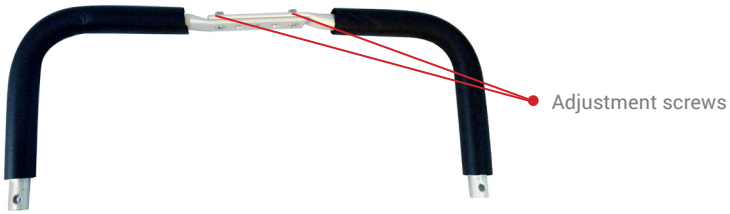

B. Lower Rear Crossbar

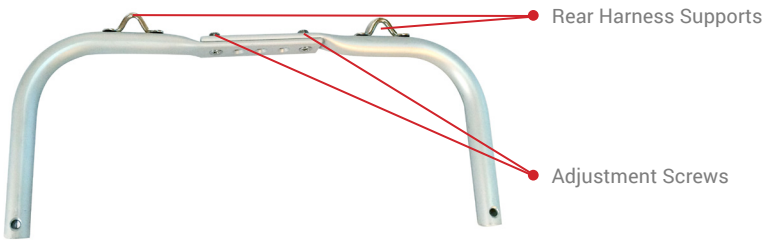

C. Upper Rear Crossbar

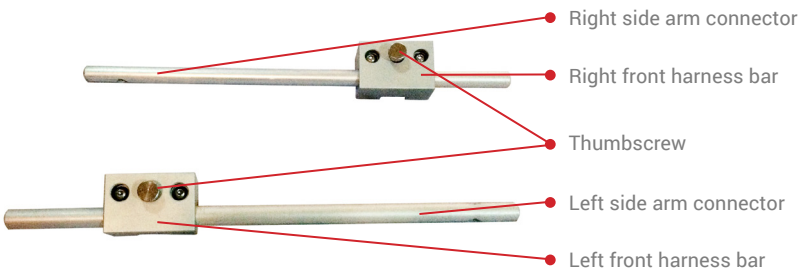

D. Left and Right Front Harness Assembly



E. Left and Right Front Wheel Assembly

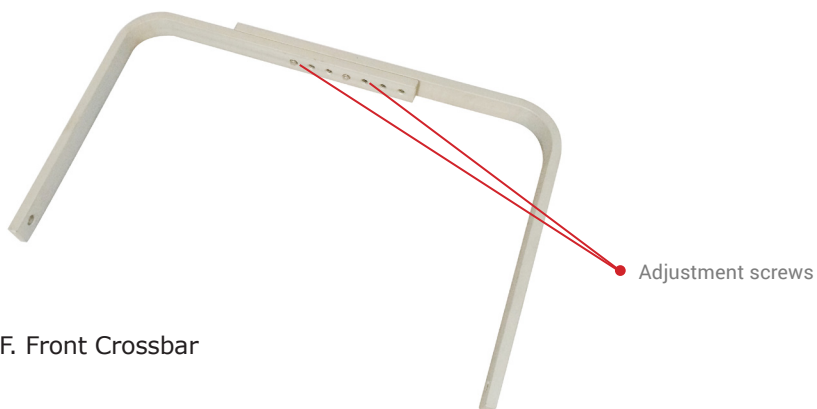

F. Front Crossbar

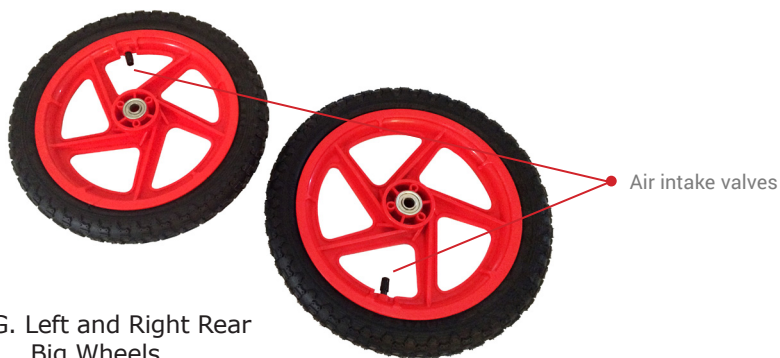

G. Left and Right Rear Big Wheels



H. Front Harness



I. Basic Rear Harness – gives better support for your dog's body while harnessed to the wheel chair.



J. Sports Rear Harness – gives better mobility for your pet while harnessed to the wheelchair.



K. Rear Leg Straps



- L-1. Big Hex Wrench (black)
- L-2. Small Hex Wrench (silver)
- L-3. Big and Small Wrench
- L-4. Spare Bolts

## ASSEMBLING THE WHEELCHAIR

1. Connecting the lower rear crossbar (B) to the left and right side arm assembly (A)

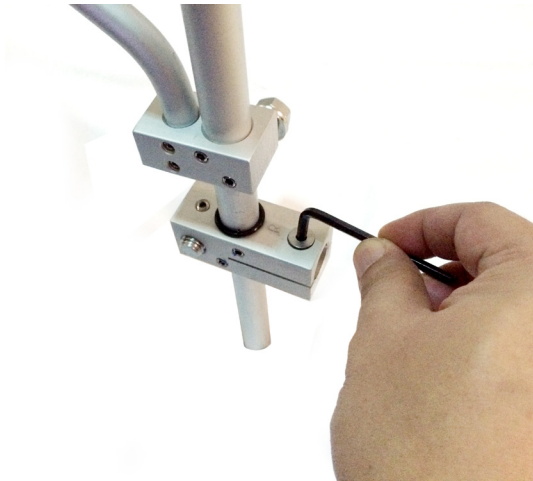

- 1.1. Insert big hex wrench (L-1) in bolt on the right wheel connector (B) of right side arm assembly (A).



- 1.2. On the opposite side of right wheel connector (B), insert nut in small wrench (L-3). Unscrew and remove nut and bolt entirely.

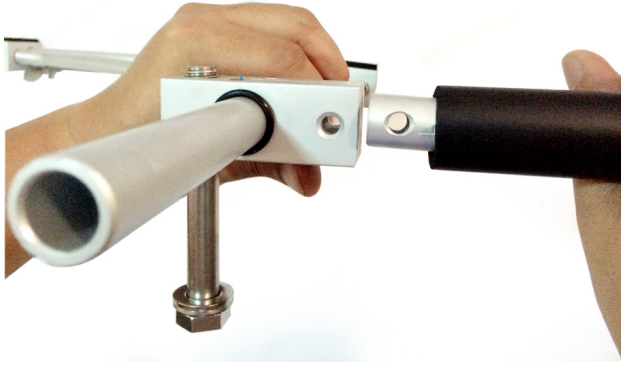

- 1.3. Insert one end of the lower rear crossbar (B) in the hole of right wheel connector (A). Make sure that the wheel bolt is facing in the opposite direction of the lower rear crossbar (B).



- 1.4. Make sure that the hole on lower rear crossbar (B) is aligned to the hole on right wheel connector (A).



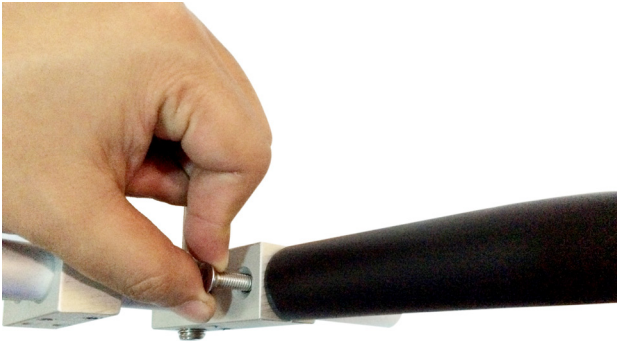

1.5. Re-insert bolt in hole until it comes out the other side.



1.6. Re-insert nut and turn using big hex wrench (L-1) and small wrench (L-3) until secure but do not tighten.

1.7. Repeat 1.1. to 1.6 to install the other end of the lower rear crossbar (B) in the hole of left wheel connector.

2. Connecting the upper rear crossbar (C) to the left and right side arm assembly (A)



2.1. On the upper crossbar connector of the right side arm assembly (A), insert nut in small wrench (L-3).

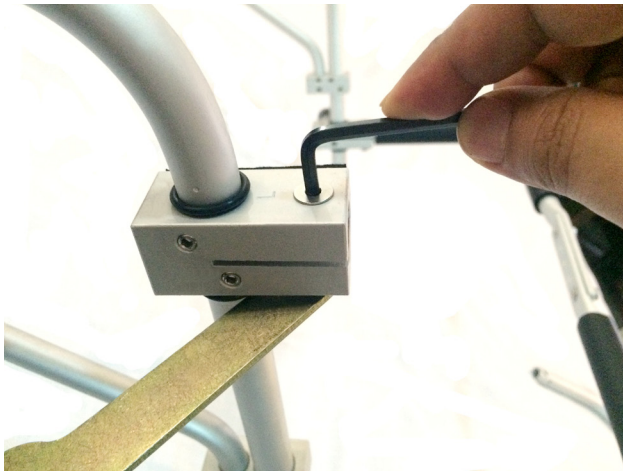

2.2. On the opposite side of upper crossbar connector (A), insert big hex wrench (L-1) in bolt. Unscrew and remove entirely.

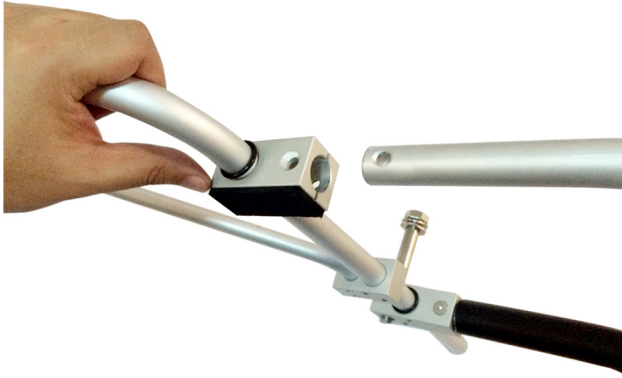

- 2.3. Insert one end of the upper rear crossbar (C) in the hole of the upper crossbar connectors (A). Make sure that the upper rear crossbar (C) is parallel with the lower rear crossbar.

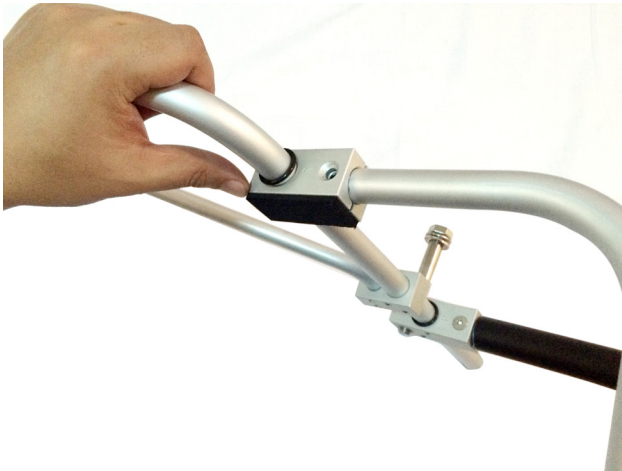

- 2.4. Make sure that the hole on upper rear crossbar (C) is aligned to the hole on upper crossbar connectors (A).



2.5. Re-insert bolt in hole until it comes out the other side.

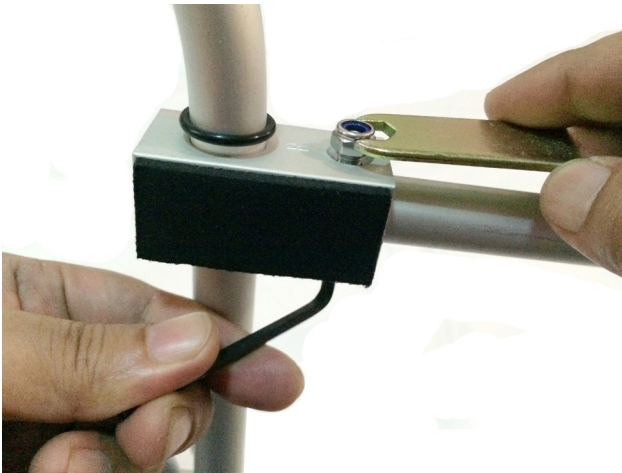

2.6. Re-insert nut and turn using big hex wrench (L-1) and small wrench (L-3) until secure but do not tighten.

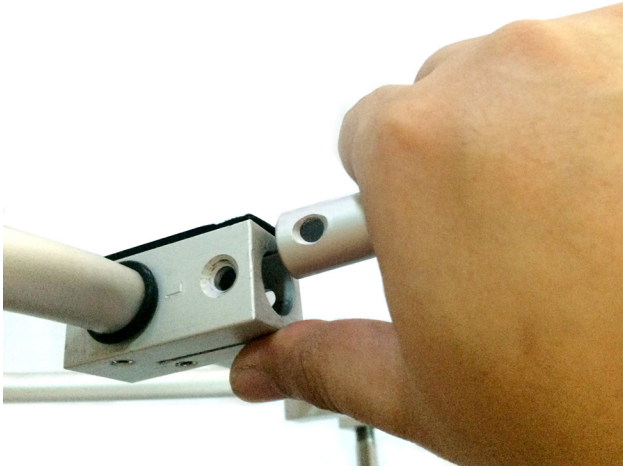

2.7. Hold the other end of the upper rear crossbar and pull towards the direction of the hole on the upper crossbar connector on the left side arm assembly (A).

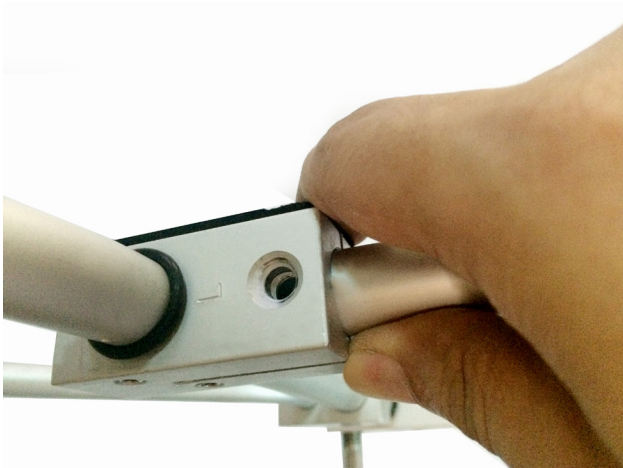

2.8. Insert the end into the hole as soon as it is aligned.

2.9. Re-insert bolt in hole until it comes out the other side. It may take some jiggling pulling and pushing of the bars to align the holes to allow the bolt to pass thru.

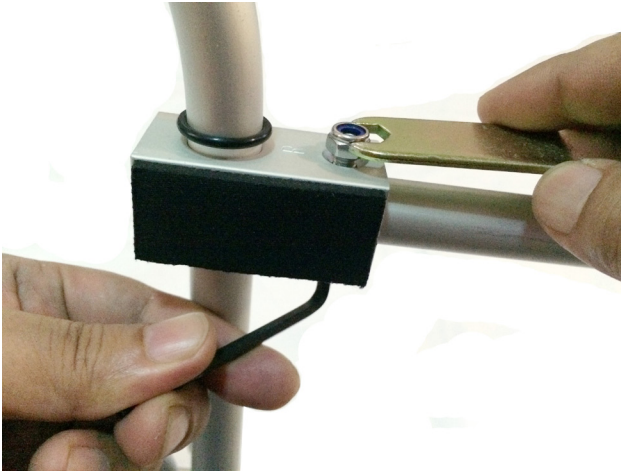

2.10. Re-insert nut and turn using big hex wrench (L-1) and small wrench (L-3) until secure. You may now tighten all the nuts and bolts of both upper (C) and lower rear crossbars (B).

This is what it should look like so far

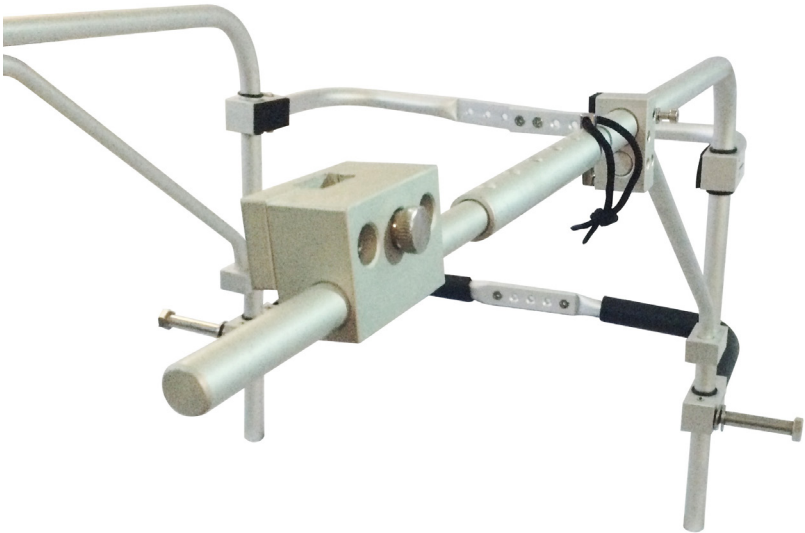

Figure 1

3. To install the left and right front harness assembly



3.1. Insert the left front harness bar (D) in the hole of the left side arm assembly (A).



3.2. Make sure the thumbscrew on the left side arm connector (D) is facing outwards.



- 3.3. Adjust to desired length. Make sure the hole on the left front harness bar (D) is aligned with a hole on the left side arm assembly (A).

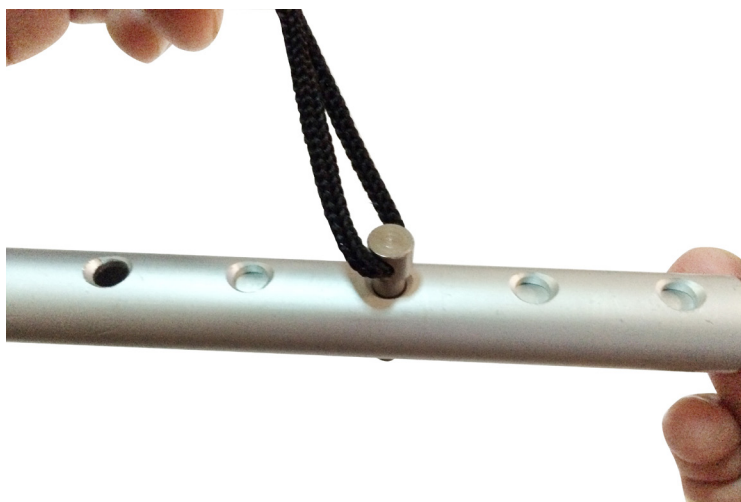

- 3.4. Insert metal lock in aligned hole until it comes out the other end.
- 3.5. Repeat 3.1. to 3.4. to insert the right front harness bar (D) in the hole of the right side arm assembly (A). Make sure the left and right front harness bars (D) are of equal distance when adjusting their length.



4. To attach front small wheels

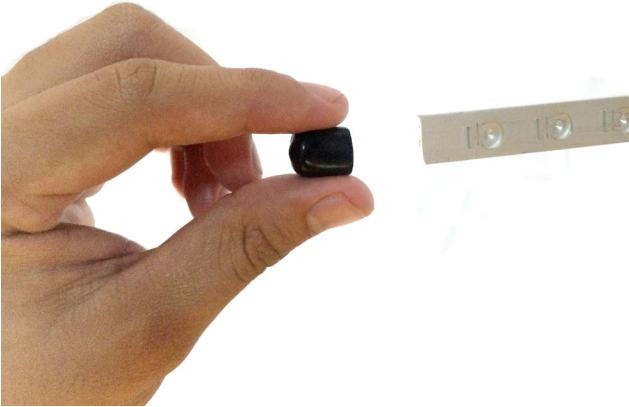

4.1. Remove rubber end cap from front wheel assembly (E).

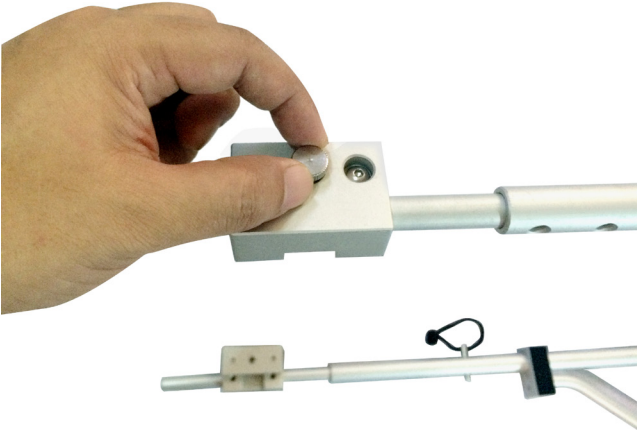

4.2. Loosen thumbscrew on left side arm connector (D).

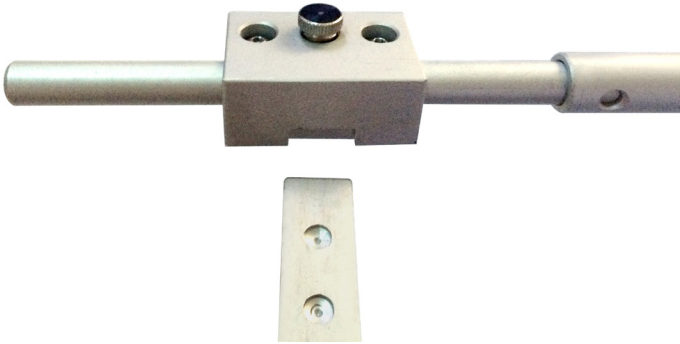

- 4.3. Insert front wheel assembly (E). Make sure the side with hollowed circles is facing the same side as the thumbscrew.

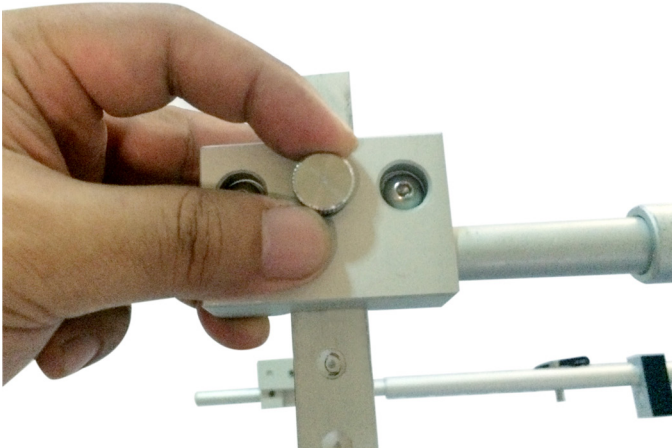

- 4.4. Adjust to desired height and align a hollowed circle to the thumbscrew. Tighten the thumbscrew.
- 4.5. Return rubber end cap.
- 4.6. Repeat 4.1. to 4.5. to install the right front wheel assembly (E) to the right side arm connector (D).

After installing front wheel assembly, it should look like this.

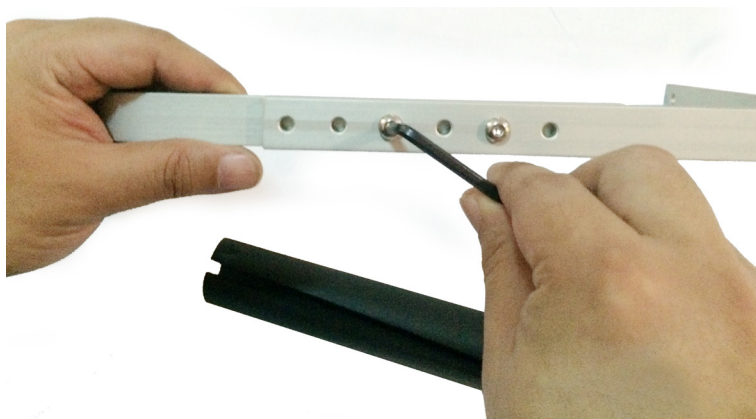

Figure 2

5. To install front crossbar (F)



5.1. Remove the black rubber cover from the front crossbar (F).



5.2. Loosen and remove screws with big hex wrench (L-1) and Phillips screwdriver (not included).

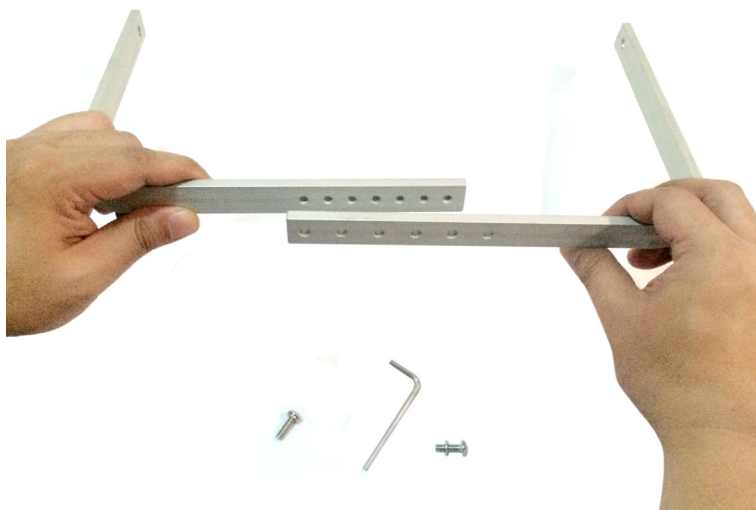

5.3. Move the metal bars to desired width.

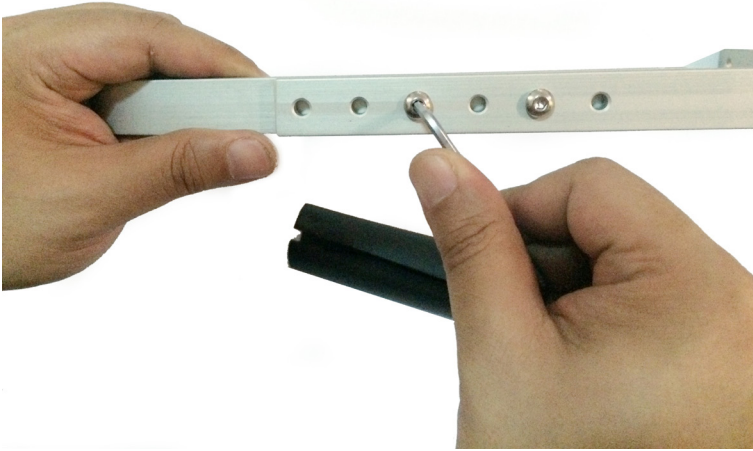

5.4. Return screws and tighten with big hex wrench (L-1) and Phillips screwdriver (not included). Return the black rubber cover on the front crossbar (F).

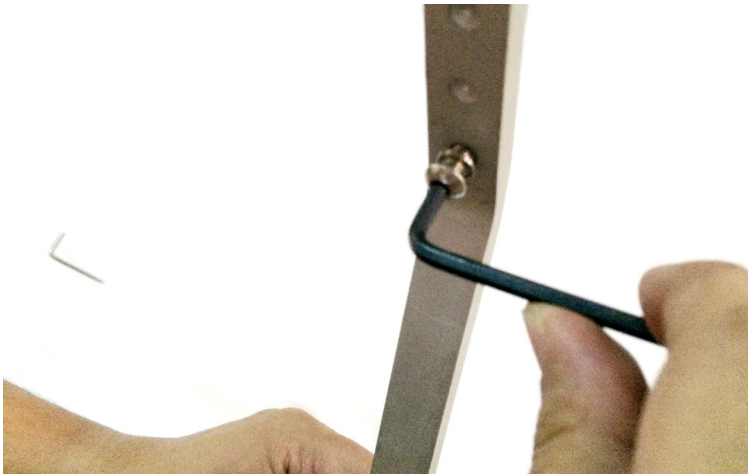

5.5. Unscrew the bolts on the left and right front wheel assembly (E) using the big hex wrench (L-1).



5.6. Position the front crossbar (F) so that the ends with holes are aligned to the holes on the sides of the left and right front wheel assembly (E).

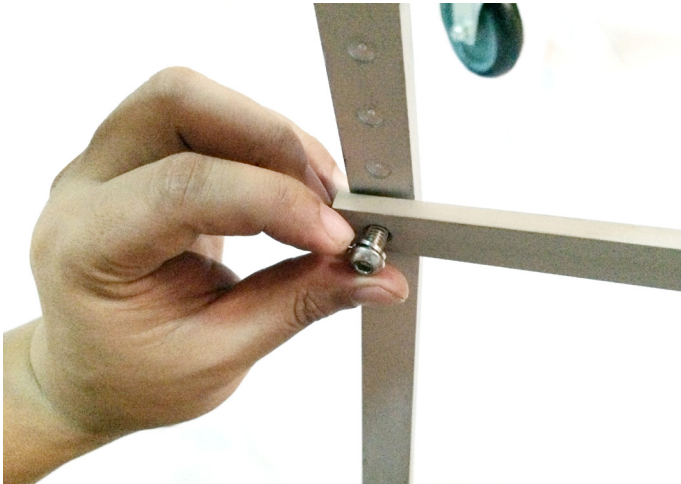

5.7. Insert a bolt thru the hole of the front crossbar (F) on each side and screw to the front wheel assembly (E) then tighten with the big hex wrench (L-1).

The front assembly should look like this



Figure 3

6. To install the big wheels (G)



6.1. Unscrew the wheel bolts from the right wheel connector (A) with big wrench (L-3.). Remove bolt and the two metal washers.

6.1.1. Insert a metal washer thru the bolt then insert the bolt thru the wheel hole.

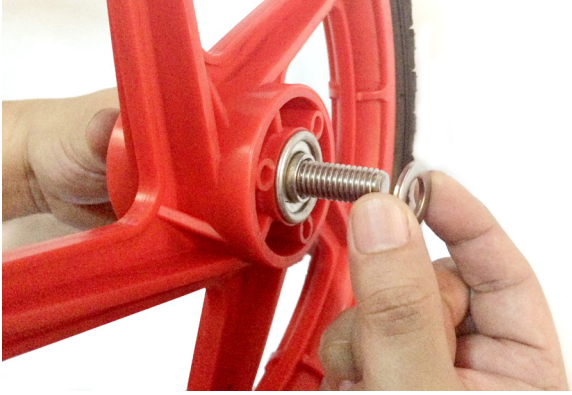

6.2. Insert the other metal washer thru the bolt on the other side of the wheel.



6.3. Screw the bolt back to the right wheel connector (A) and tighten with big wrench (L-3).





6.4. Repeat 6.1 to 6.4 to install the other wheel on the left wheel connector.

6.5. Inflate the wheel to the recommended 35 psi, if necessary, with any standard air pump.

7. To adjust the height of the rear big wheels (G)

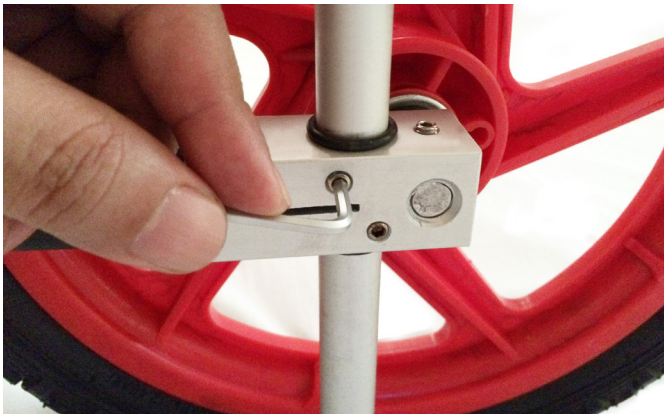

7.1. Loosen the small hex screws on the on the left and right wheel connector block with the small hex wrench (L-2).

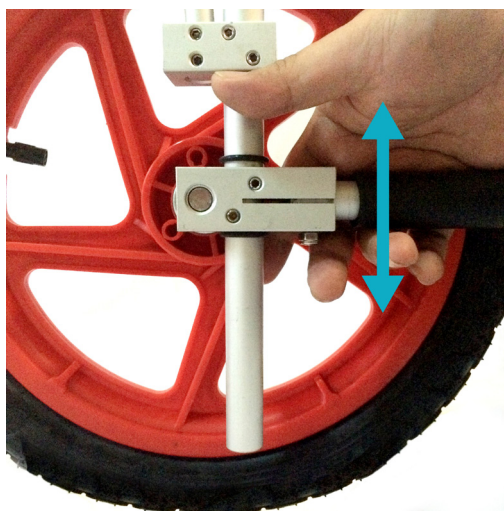

7.2. Adjust the heights of the wheel connectors and upper crossbar connectors according to desired position. Align on both sides.

7.3. Tighten the small hex screws on the on the left and right wheel connector block with the small hex wrench (L-2).

## 8. To make final adjustments



8.1. Loosen connector block screws with the small hex wrench (L-2) on the upper crossbar connectors.

8.2. Adjust the heights of the according to desired position.  
Align on both sides.

8.3. When aligned, tighten with the small hex wrench (L-2).

**You are done with the assembly!**



# FITTING YOUR DOG TO THE WHEELCHAIR

1. To put on the front harness (H) on your pet

1.1. Unlock the front leg strap (red strap) by pressing on the side release buckle.



1.2. Guide your pet's head thru the two black straps until middle black strap reaches your pet's upper chest below the neck and the upper black strap is across your pet's back shoulder area. Make sure the front leg strap (red strap) is at the bottom.

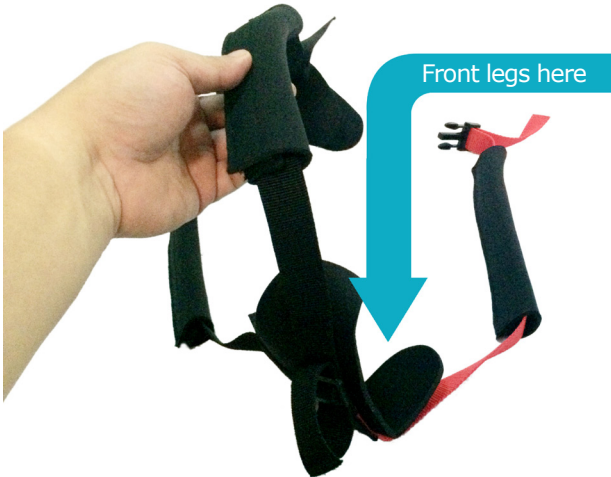

1.3. Place the front leg strap (red strap) behind the front leg, across the bottom chest, behind the other front leg until it reaches the partner of the side release buckle on the other side.

1.4. Lock the side release buckle.



1.5. Adjust straps for comfort and firmness. Lift rounded end of adjuster buckle to loosen. Pull on strap ends to tighten.

2. If you will be using the basic rear harness (I)

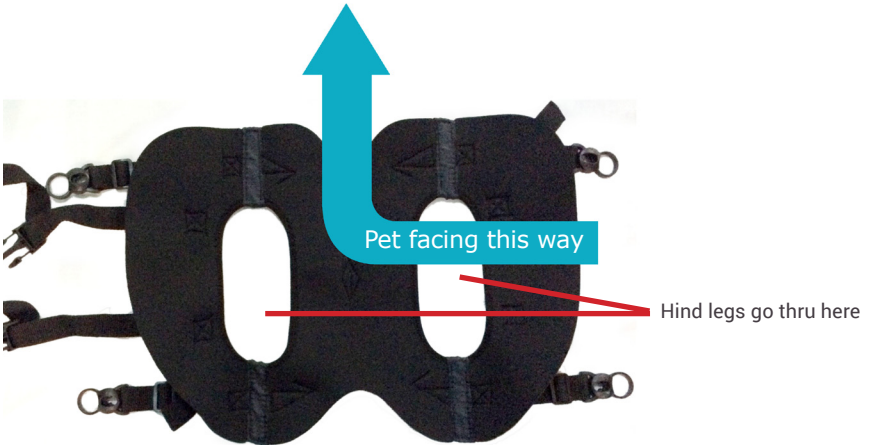

2.1. Guide each hind leg of your pet into each hole of the basic rear harness.



- 2.2. Place the two straps above your pet going across the back until it reaches the corresponding side release clasps on the other side.



- 2.3. Adjust the straps for comfort and firmness.





2.4. Lock the side release buckles.

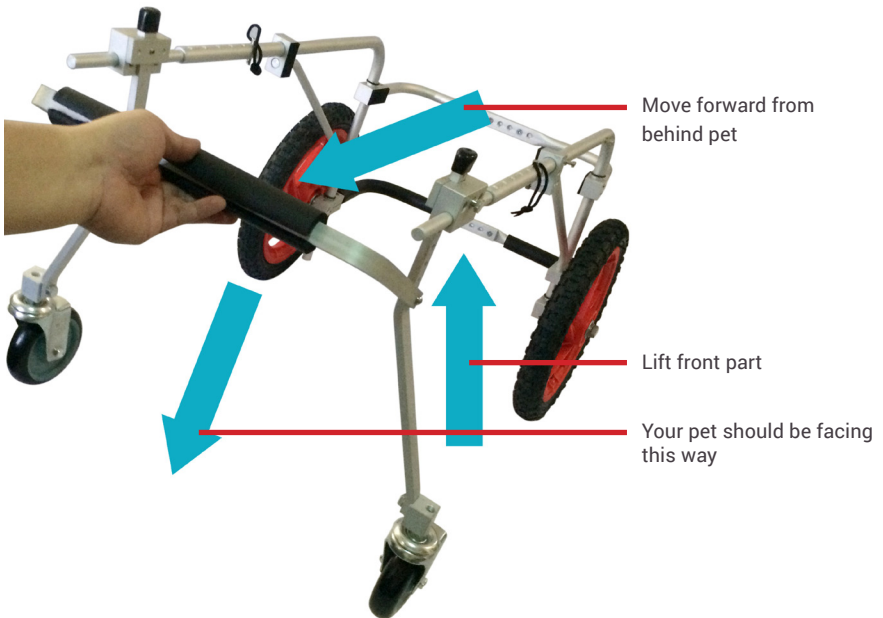

2.5. Bring up the wheelchair from behind your pet. Lift the front part to allow your pet to pass thru.

2.6. Move the wheel chair forward until your pet fits in the middle of the wheelchair. Lower the front part.



2.7. Make sure each plastic clamp on the basic rear harness (I) is level with and near a side arm bolt.

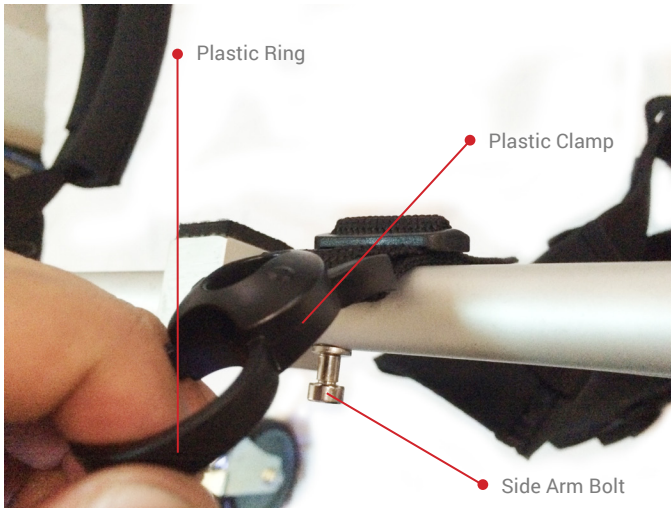

2.8. Put your finger in plastic ring. Position strap to go above and around the side arm assembly.





2.9. Fasten the plastic clamp to the side arm bolt.



2.10. Lock plastic clamp by pushing it upward.



2.11. Repeat steps 2.9. to 2.11. to attach remaining 3 plastic clamps.



2.12. Lengthen or shorten the straps attached to the plastic clamps to adjust the rear harness to a comfortable weight-bearing position for your pet.

3. If you will be using the Sports Rear Harness (J)

3.1. Install the sports rear harness to the main assembly before placing your pet in to the harness.



3.2. Place the sports rear harness so that each plastic clamp is level with and near a side arm bolt.

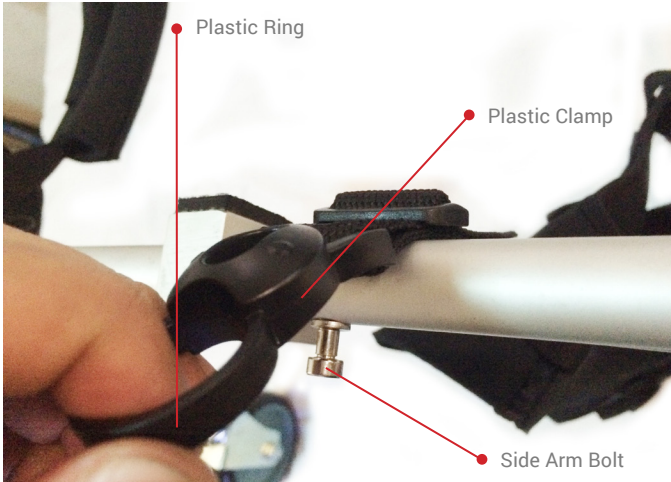

3.3. Put your finger in plastic ring. Position strap to go above and around the side arm assembly.



3.4. Fasten the plastic clamp to the side arm bolt.



3.5. Lock plastic clamp by pushing plastic clamp upward.



- 3.6. Repeat steps 3.3 to 3.5 to attach remaining 3 plastic clamps.
- 3.7. Lengthen or shorten the straps attached to the plastic clamps to adjust the rear harness to a comfortable weight-bearing position for your pet.
- 3.8. Bring up the wheelchair behind your pet. Lift the front part to allow your pet to pass thru.
- 3.9. Move the wheelchair forward until your pet fits in the middle of the wheelchair.

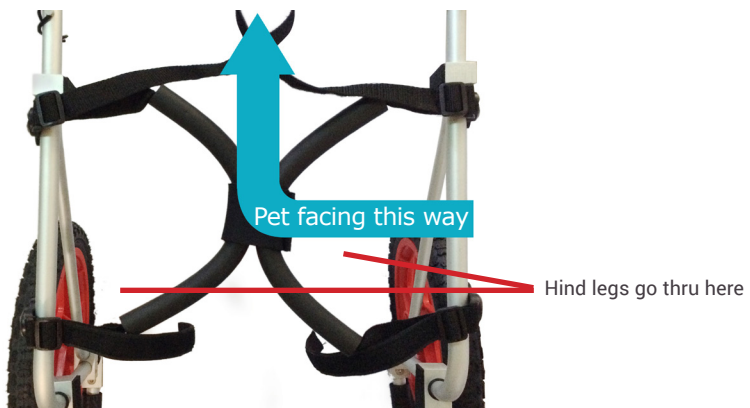

- 3.10. Lift each hind leg of your pet and insert in the corresponding hole of the attached rear sports harness.

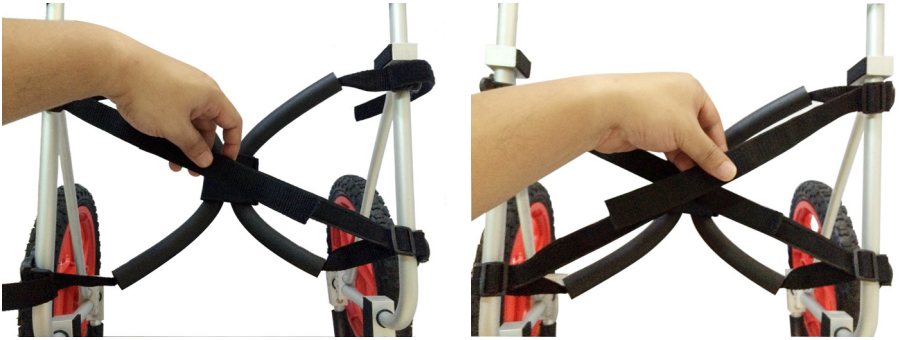

3.11. Place the back straps on the back of your pet. Strap the lower left strap to the upper right and the lower right to the upper left strap so that both straps cross your pet's lower back.

4. To fasten the front harness (H)



4.1. Unfasten harness straps on both sides of front harness.



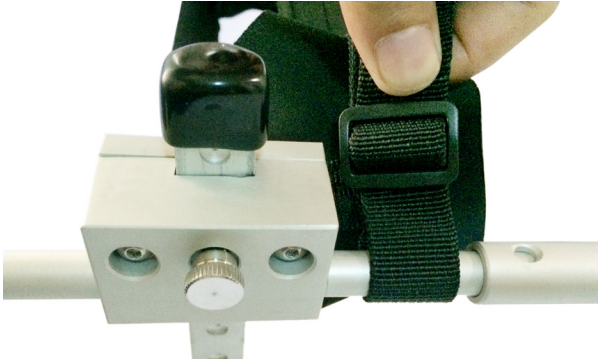

4.2. Wrap one strap around left front harness assembly.

4.3. Adjust then tighten straps.

4.4. Repeat to fasten other strap around right front harness assembly.

5. To use the rear leg straps (K).

5.1. Use the rear leg straps to protect your pet's paws and keep them from dragging.



5.2. Attach rear leg straps on the rear harness support on the upper rear crossbar.



5.3. Loosen the straps by pressing on the cord lock.

5.4. Insert each leg to corresponding rear leg strap.



5.5. Adjust to a comfortable tightness.



5.6. Make sure that legs can rest at a relaxed angle.

**CONGRATULATIONS!**

**Your pet is now ready to take the first steps towards mobility.**



Figure 4 – with Basic Rear Harness attached



Figure 5 – with Basic Rear Harness attached



Figure 6 – with Sports Rear Harness attached



Figure 7 – with Sports Rear Harness attached

# ADDITIONAL MEASUREMENTS FOR A PROPER FIT

Once you have assembled your pet's new Best Friend Mobility wheelchair, you can use the measuring guide below to give it a customized fit.

We always strive to keep things simple. The following are the key measurements you need to take to ensure a comfortable ride for your pet.

Please remember to use a rigid tape measure. If your pet has difficulty standing or staying upright, get someone to help either support your pet or do the measuring.

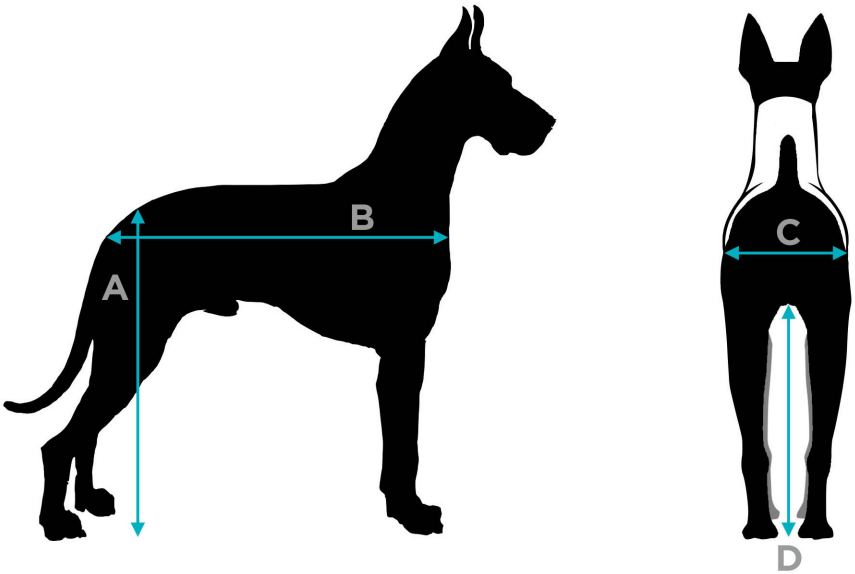

- A. Rear leg height, from floor all the way to the backbone (top of the pelvis)
- B. Body length
- C. Hip width—straight across
- D. Floor to groin height

## Notes on measurements

1. The rear leg height measurements (A and D) are to ensure that the wheelchair is set so that your dog's body is properly supported. When set at the correct height, your pet can use what movement and strength it has in its legs—allowing your pet some traction (instead of pawing air). If your pet has no hind leg strength, use the leg straps to prevent paw dragging.
2. The hip width measurement (C) will help you get the right setting for the crossbars. The right width setting will prevent painful chafing that can occur in improperly set wheelchairs, where your pet's body may end up repeatedly rubbing against the metal frame.

## Tips

- The front side arms should be approximately 2 inches below the top of your pet's shoulders.
- The rear side arms should be approximately 2 inches below the top of your pet's hip.
- The two side arms of the wheelchair's frame should be parallel to your pet's back
- Your pet's sides should be approximately 1 inch away from the side arms.
- Your pet's sides should not rub against the side arms while your pet is walking.
- The front harness should rest snugly but comfortably under your pet's forelegs.
- The front strap should sit slightly above the center of the chest.
- The front strap must not press against the throat.
- The front strap must not rest below the center of the chest.

Because Best Friend Mobility wheelchairs are adjustable in all three dimensions, it is important to get your pet fitted properly. Setting the height, length, and width will be your task. You might get it right on the first try or a bit of fine-tuning might be required. Please keep in mind that although some pets are able to ambulate in the chair on their first time, it is much more likely to take several sessions before your pet is able to use

the wheelchair with assistance, and even longer without. Please be patient and remember that this is a learning process.

**DO NOT LEAVE YOUR PET ALONE IN THE CART!**

**Using the Quad/Full Support Wheelchair**

It is usually best to attach a leash to the front bar to help with the training, and to help give the dog cues and assistance in moving the chair. Please note that if the dog has not ambulated in some time, they will not be able to push a full support chair on their own, they will require some exercise first. You must assist them with pushing the chair for several sessions before they can build the strength to walk and run in the quad chair unassisted.

Please feel free to call us for assistance or visit our YouTube Channel <https://www.youtube.com/channel/UCvcCwjFFW0kPZI6asNfBKmA> and our website's FAQ page <http://bestfriendmobility.net/faq-i-18.html?osCsid=268q8eqrmb1f2e20pslpdrn9n2> for more information.

## CARE AND MAINTENANCE

Keep the Best Friend Mobility wheelchair clean. Your pet will surely appreciate it and ride with pride. Wipe down aluminum surfaces with warm, soapy water using a soft cloth such as a microfiber or cotton rag. Rinse and dry.

Check the bolts and screws frequently; retighten if loose. Adjust or tighten loose straps as well.

Remember to hose or wipe down tires to keep them from tracking dirt. Check tire pressure every so often and inflate when needed. To reduce bounce and increase traction, lessen tire pressure (to just under 35 PSI) to give the wheelchair a more comfortable ride.

Wash the sling, harness, and straps in cool, soapy water and hang them to dry. Opting for a perfume-free detergent will help your pet avoid skin irritation. You may want to try odor neutralizers (homemade or storebought) to counter any smell that may remain in the harness.

## CONTACT US

If you find that you have further questions regarding the use of the Best Friend Mobility wheelchair, please contact us at:

**Best Friend Mobility**

**279 Hwy 57 S STE4**

**Little River, SC 29566**

**Phone: (843) 492-5283**

**Email: [support@dogwheelchairscenter.com](mailto:support@dogwheelchairscenter.com)**



Best Friend Mobility  
279 Hwy 57 S STE4  
Little River, SC 29566  
(843) 492-5283  
[support@dogwheelchairscenter.com](mailto:support@dogwheelchairscenter.com)

