

SHIKO MAGNUM

by e-ggs

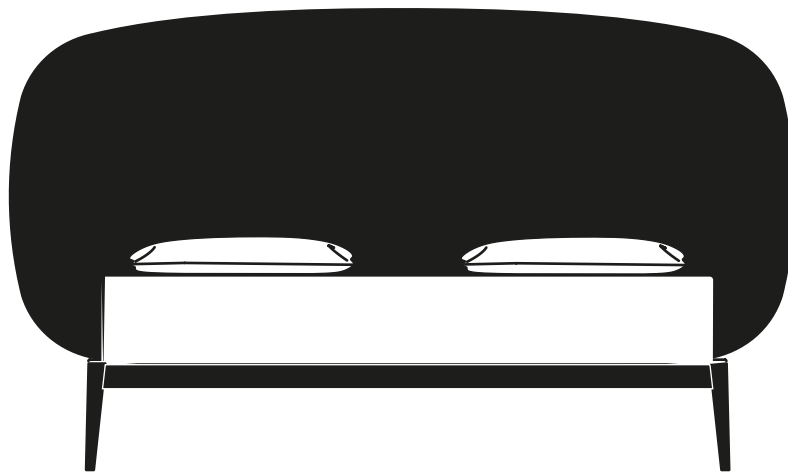

Lo Shiko è un rito dei lottatori di Sumo che consiste nell'alzare la gamba e poi sbatterla a terra con energia per mandare via gli spiriti cattivi. Come quel rito, abbiamo disegnato un letto che evoca solidità e sicurezza, che trova nella morbidezza della testiera la sua forza.

Shiko is a ritual exercise performed by Sumo wrestlers, which involves lifting the legs and stomping hard on the floor to chase away evil spirits. Like that ritual, we have designed a bed that evokes a sense of solidity and safety. Its strength lies in the softness of its headboard.

DIMENSIONI | DIMENSIONS

lunghezza | width: 216 cm

larghezza | depth: 220 cm

altezza | height: 130 cm

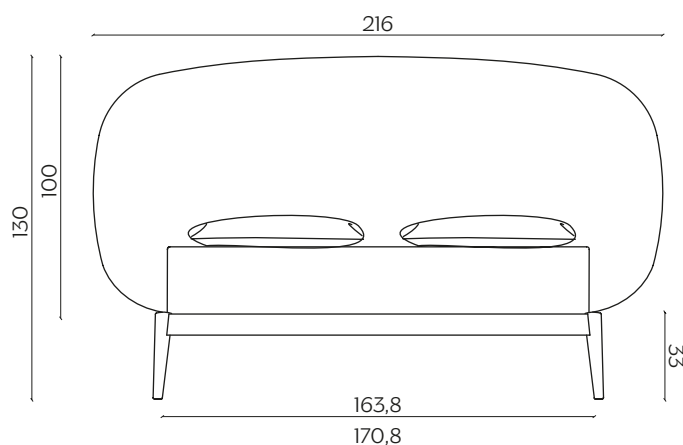

lunghezza | width: 236 cm

larghezza | depth: 220 cm

altezza | height: 130 cm

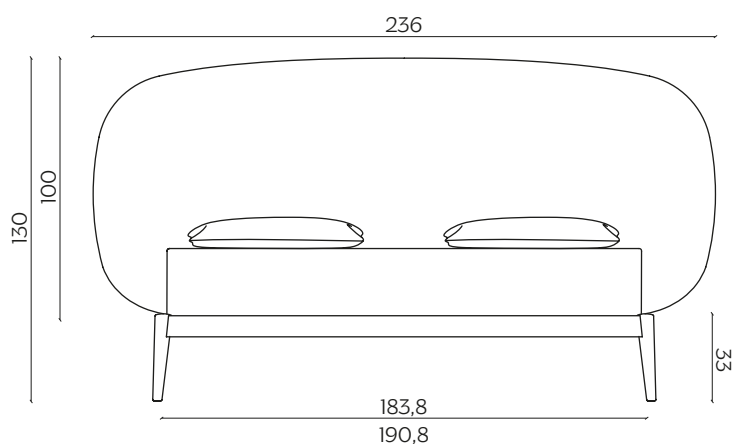

AMBIENTE | ENVIRONMENT

interno | indoor

DOWNLOAD | DOWNLOADS

la guida Cura e Manutenzione è disponibile su miniforms.com

Care and Maintenance guide is available at miniforms.com

file 2D, 3D e fotografie sono disponibili su miniforms.com

2D, 3D files and hi-res images are available at miniforms.com

FINITURE | FINISHES
STRUTTURA | STRUCTURE

Legno | Wood



Frassino
Ash



Frassino Nero
Black Ash



Anilina Blu
Intense Blue Aniline

FINITURE | FINISHES

TESSUTI | FABRICS

A

Fluxo Bloom Ecoleather



Avorio
Ivory



Bianco
White

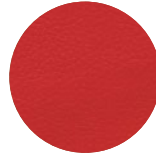

Rosso
Red



Tortora
Dove Grey



Testa di Moro
Dark Brown



Grigio Scuro
Dark Grey



Nero
Black

Tramè



Beije

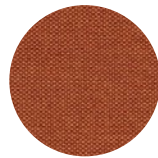

Arancio
Orange



Mela
Apple



Senape
Mustard

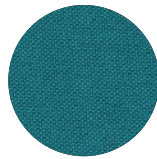

Pavone
Peacock

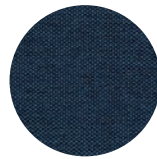

Blu Elettrico
Electric Blue



Nero
Black



Grigio Scuro
Dark Grey



Tortora
Dove Grey

Madrid

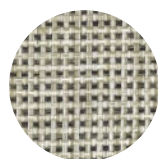

Burro
Butter

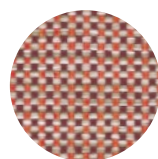

Melograno
Pomegranate

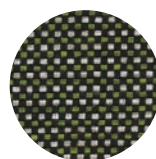

Menta
Mint



Notte
Night

TESSUTI | FABRICS

A

Salò

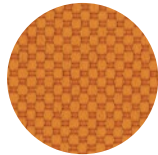

Arancio
Orange

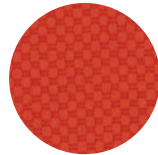

Rosso
Red

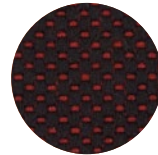

Marmellata
Jam

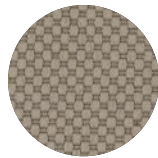

Grigio Chiaro
Light Grey



Marrone
Brown

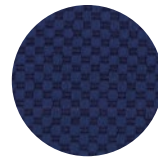

Blu Notte
Midnight Blue

Loop

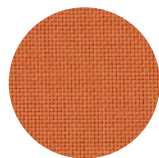

Arancione
Orange



Lime

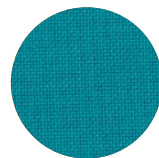

Turchese
Turquoise

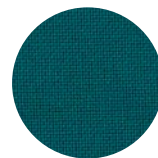

Ottanio
Teal Green

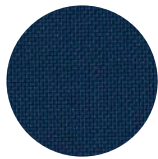

Blu Scuro
DarkBlue



Testa di Moro
Dark Brown

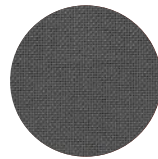

Grigio Fumo
Smoke Grey



Nero
Black

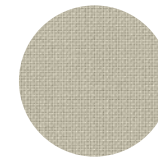

Avorio
Ivory

FINITURE | FINISHES

TESSUTI | FABRICS

B

Fluxo Rebel Econabuk



Seppia
Sepia



Nocciola
Light Brown



Marrone
Brown



Grigio
Grey



Antracite
Anthracite

Fluxo Platinum



Pesca
Peach

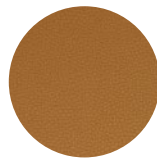

Nocciola
Hazelnut

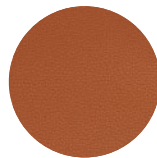

Mattone
Brick



Verde
Green

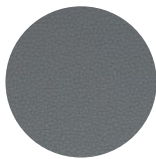

Nuvoloso
Cloudy

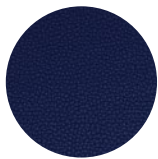

Blu
Blue



Porpora
Purple

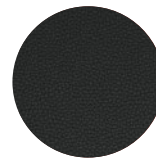

Nero
Black

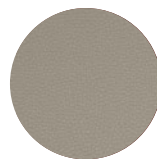

Tortora
Dove Grey

Mesh

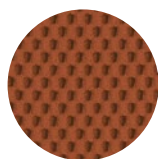

Rosso Corallo
Coral Red



Verde Salvia
Sage Green

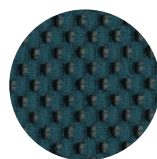

Foglia di Tè
Teal

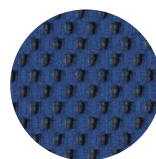

Blu Neon
Neon Blue

TESSUTI | FABRICS

B

Kvadrat Relate

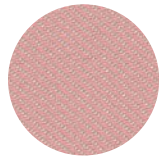

Rosa
Pink

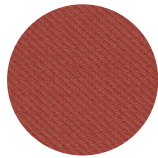

Rosso
Red

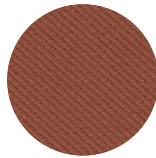

Terra
Ground



Snack

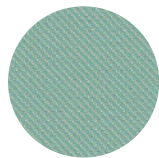

Menta
Mint

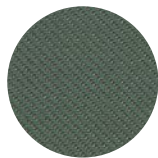

Verde Bosco
Forest Green

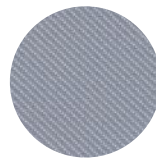

Nuvolo
Cloudy



Grigio
Grey

Torrilana Cubbio

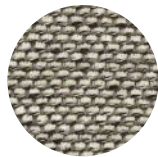

Sale e Pepe
Salt and Pepper

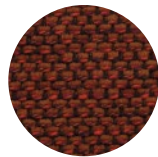

Ambra
Amber



Bordeaux

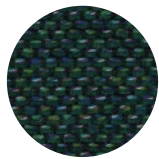

Verde Petrolio
Petrol Green

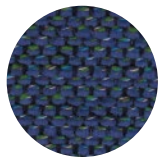

Blu Elettrico
Electric Blue



Castagna
Walnut



Tortora
Dove Grey

Lanee



Grigio
Grey

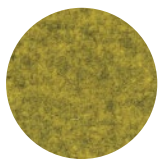

Giallo
Yellow

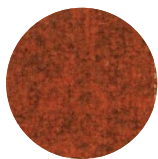

Rosso
Red

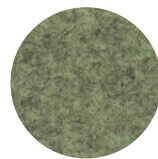

Menta
Mint

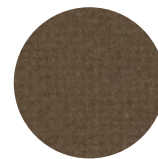

Marrone
Brown

FINITURE | FINISHES

TESSUTI | FABRICS

C

Shelter Velvet



Crema
Cream



Rosa Intenso
Intense Rose



Terra di Siena
Burnt Sienna



Cammello
Camel



Verde
Green

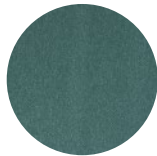

Turchese
Turquoise



Blu Notte
Midnight Blue



Testa di Moro
Dark Brown

Kvadrat Field 2

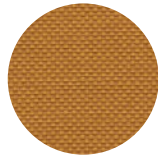

Zafferano
Saffron-Yellow

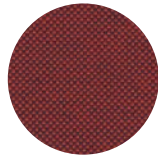

Ciliegia
Cherry

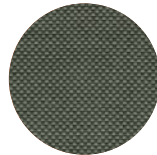

Menta
Mint

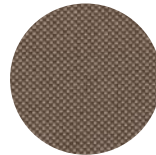

Nocciola
Hazel

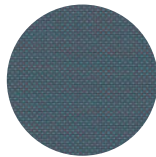

Zucchero
Sugar

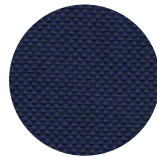

Blu
Blue

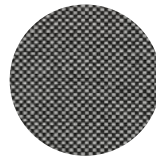

Sale e Pepe
Salt and Pepper

Torrilana Brionne



Black and White

TESSUTI | FABRICS

C

Vescom Harding

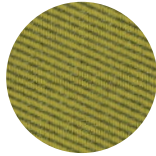

Ciallo
Yellow

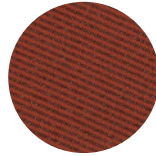

Rosso
Red

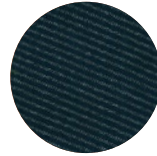

Petrolio
Blue-Green

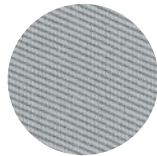

Grigio Chiaro
Light Grey

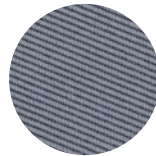

Nuvolo
Cloudy

Vescom Rolla

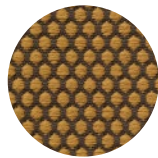

Mostarda
Mustard

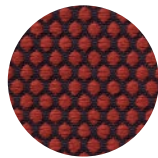

Ciliegia
Cherry

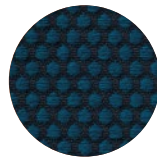

Blu Pavone
Peacock



Blu Notte
Midnight Blue

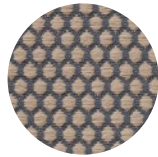

Latte
Steamed Milk

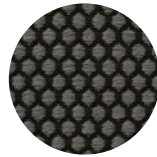

Antracite
Anthracite

Torrilana Rakam



Bacca
Berry

FINITURE | FINISHES

TESSUTI | FABRICS

D

Cloud



Panna
Cream



Noce
Walnut



Nocciola
Hazelnut



Bordeaux

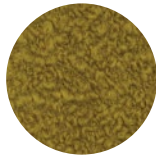

Senape
Mustard



Petrolio
Blue-Green



Blu Notte
Night Blue

Maharam Merit

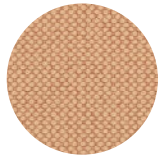

Salmone
Salmon

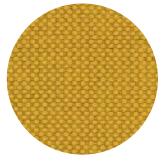

Ciallo
Yellow

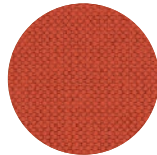

Rosso Corallo
Coral Red



Marrone
Brown

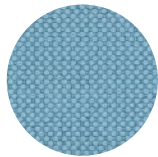

Celeste
Sky Blue

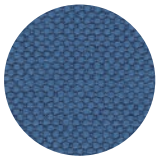

Blu Cobalto
Cobalt Blue

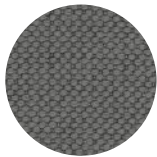

Grigio
Grey

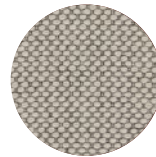

Sale e Pepe
Salt and Pepper

TESSUTI | FABRICS

D

Rohi Sera

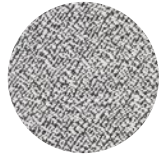

Pepper

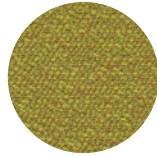

Tivoli

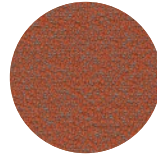

Glow

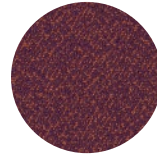

Berry

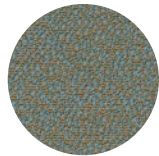

Mirage

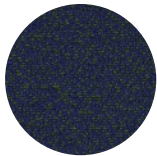

Mare

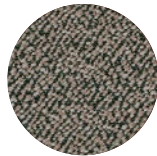

Walnut



Rosewood

Rohi Mica

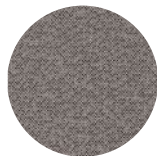

Pepper

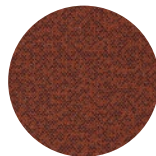

Indio

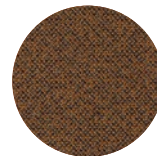

Amber

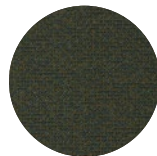

Jungle

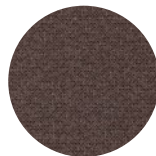

Mud

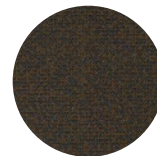

Secret

FINITURE | FINISHES

TESSUTI | FABRICS

E

Kvadrat Steelcut Trio 3

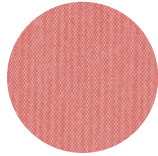

Arancia Rossa
Red Orange



Pavone
Peacock



Pesca
Peach

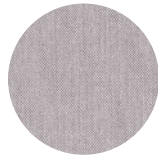

Sale e Pepe
Salt and Pepper



Elettricità
Electricity

Esedra Tricot



Sabbia
Sand



Borgogna
Burgundy



Niagara
Niagara Blue