

# OPERATION MANUAL

Model : AQ-23003

## Registration

Please visit the website below to register your new watch within the first 30 days of purchase. Registration within the first 30 days will activate your one year warranty.

<https://www.aquatrident.com/pages/product-registration>

Please keep your model number, order number and purchase date for future support. You can reach us at +852 21169137, also can send E-mail to Support@time-culture.com.

Model Number \_\_\_\_\_

Order Number \_\_\_\_\_

Purchase Date \_\_\_\_\_



## Unpacking

You will get an AQUATRIDENT watch, instruction manual and a plastic warranty Card.

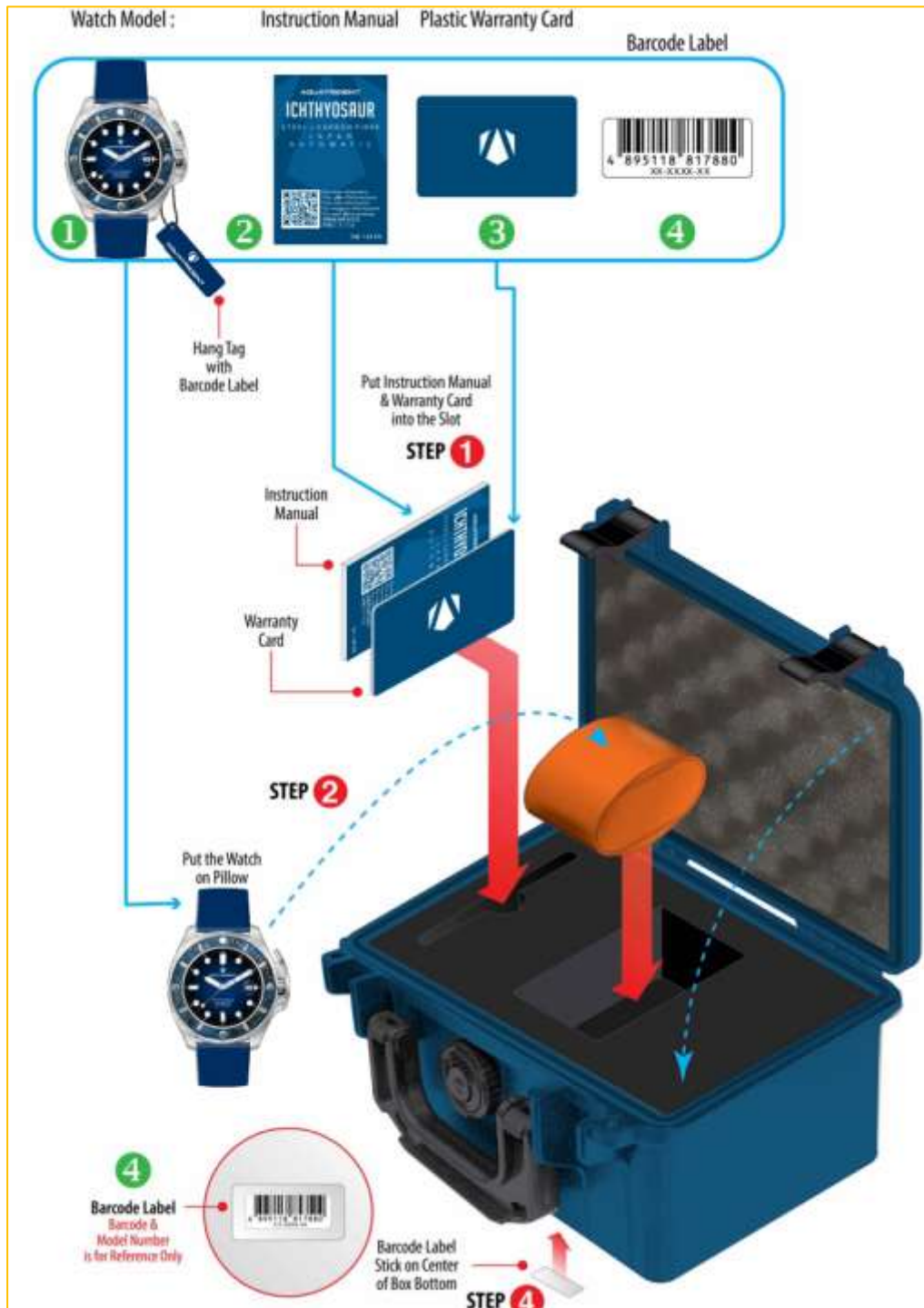

# User Guide and Maintenance

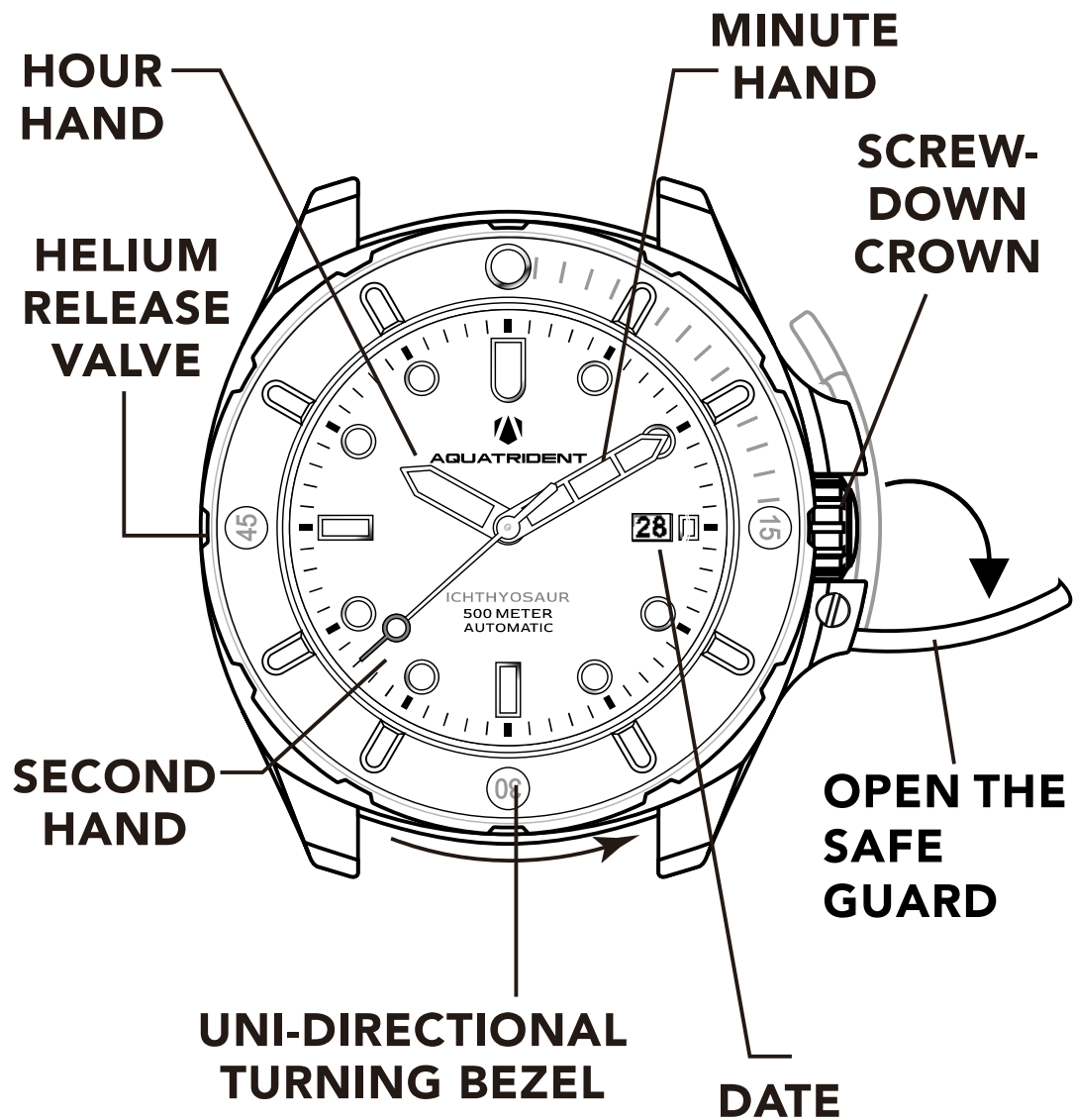

# User Guide and Maintenance

## PLEASE READ THE FOLLOWING BEFORE UNSCREWING THE CROWN

### Screw-down Crown

Screw-down crowns are used to ensure water resistance. **ALWAYS** be certain that your crown is securely screwed down (Position [0] is secured. Positions [1],[2] and [3] are not secured for water resistance ).

Do **NOT** unscrew your crown while you are in any environment where moisture is present.

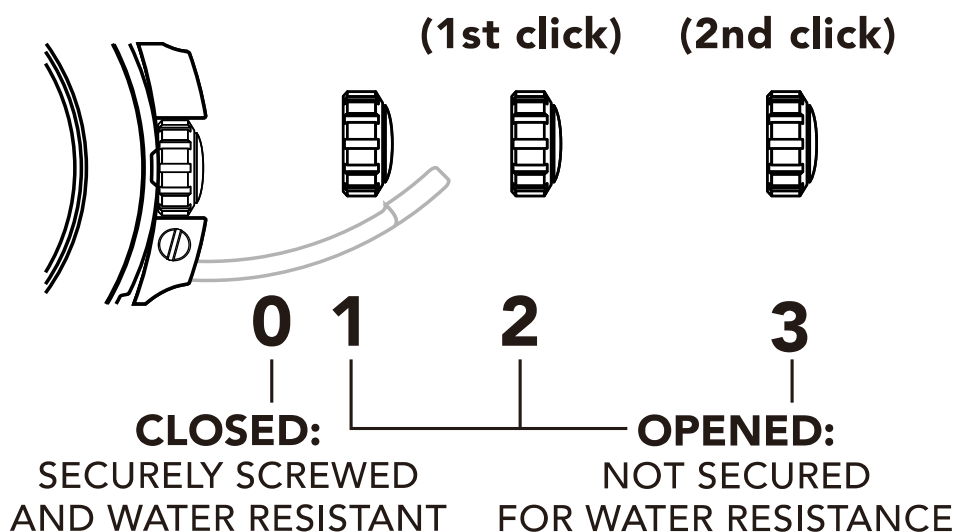

# User Guide and Maintenance

## USING THE SCREW-DOWN CROWN

Do **NOT** pull the crown unless it is **UNSCREWED** first:

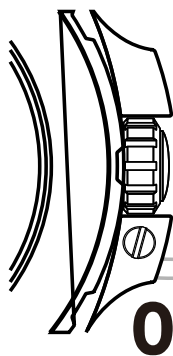

**TO UNSCREW:** Turn the crown anti-clockwise until it turns freely without tension. **GENTLY** pull the crown out to the other desired positions for watch setting (see specific operating instructions on the following pages).

### OPEN THE SAFE GUARD

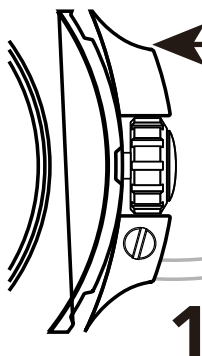

**TO SCREW:** Push the crown **ALL THE WAY IN** (towards the watch) **THEN** begin to turn clockwise until it is securely screwed down.

**NOTE:** Failure to **SECURELY** screw down the crown after setting the watch may affect its water resistance.

# User Guide and Maintenance

**Before you use this watch,  
It is recommended that you manually  
wind the mainspring to start it  
moving.**

THIS WATCH IS AN AUTOMATIC WATCH  
EQUIPPED WITH A MANUAL WINDING  
MECHANISM.

## WINDING THE MAINSPRING

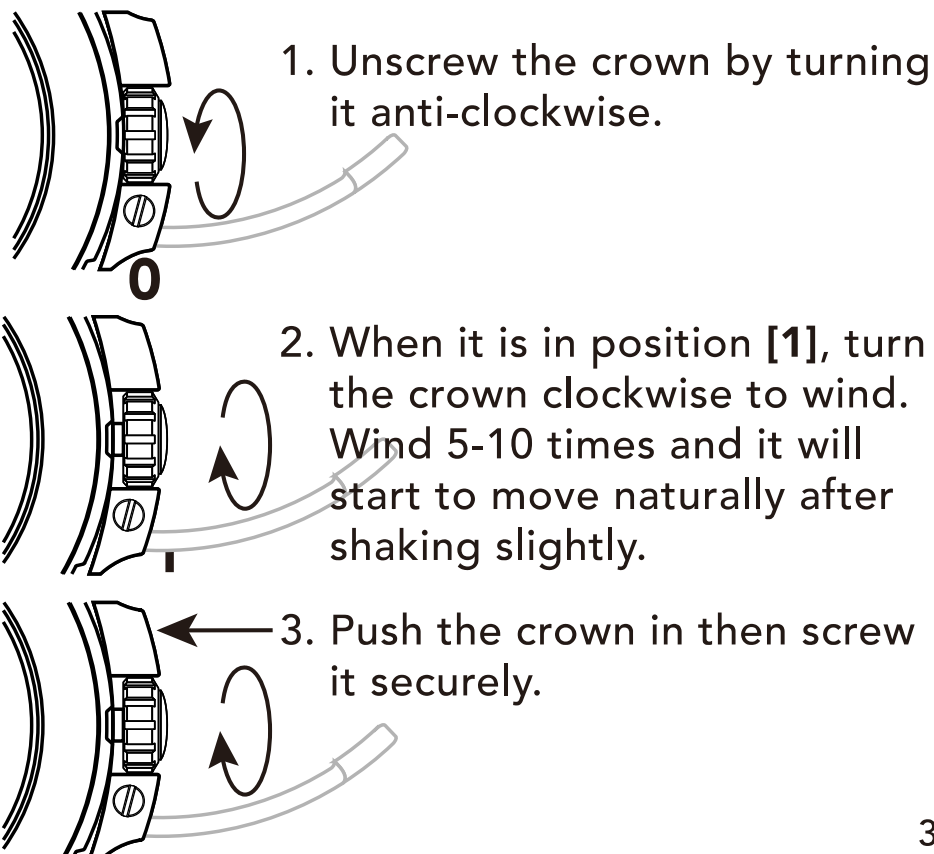

# User Guide and Maintenance

- \* This watch **MUST** be worn for at least 8 (Eight) hours each day to ensure it is fully wound.

An automatic watch will only wind when the watch is on your wrist and your arm moves. Winding the watch by the crown will put power on the spring but not enough to allow the watch to function fully.

If your watch stops overnight or loses time it means it is not being fully wound.

## **IMPORTANT NOTE**

1. If your watch is running smoothly, please do not wind the crown to avoid overwinding the movement. Provided you are wearing the watch frequently, your watch should have sufficient power to operate without any fuss.
2. If your watch has stopped running after a period of not wearing the watch, gently move the watch side to side 20 to 30 times to move the rotor or gently turn the crown 5 to 10 times to get the second hand run at its normal speed.

# User Guide and Maintenance

## HOW TO SET THE TIME

1. Unscrew the crown and pull it out to position **[3]**-(2nd click).
2. Turn the crown anti-clockwise to set the correct time.
3. Push the crown in then screw it securely.

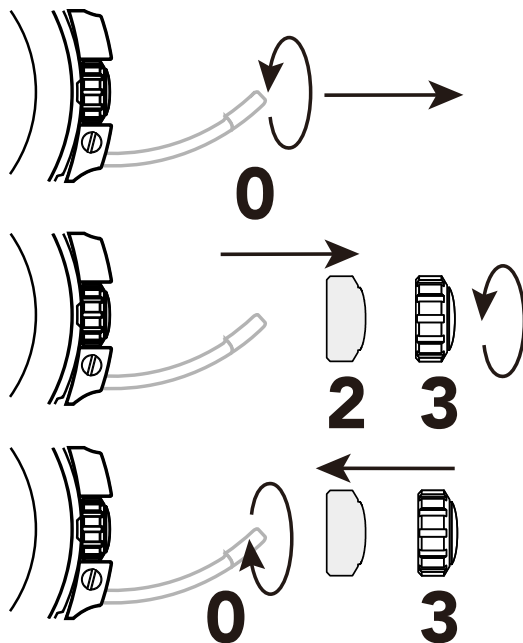

- \* Take a.m./p.m. into consideration when setting the hour and minute hands to the desired time.
- \* Always be certain that your crown is **SECURELY SCREWED**; this will prevent moisture from entering.



# User Guide and Maintenance

## HOW TO SET THE DATE

1. Unscrew the crown and pull it out to position **[2]**-(1st click).
2. Turn the crown clockwise to set the correct date.
3. Push the crown in then screw it securely.

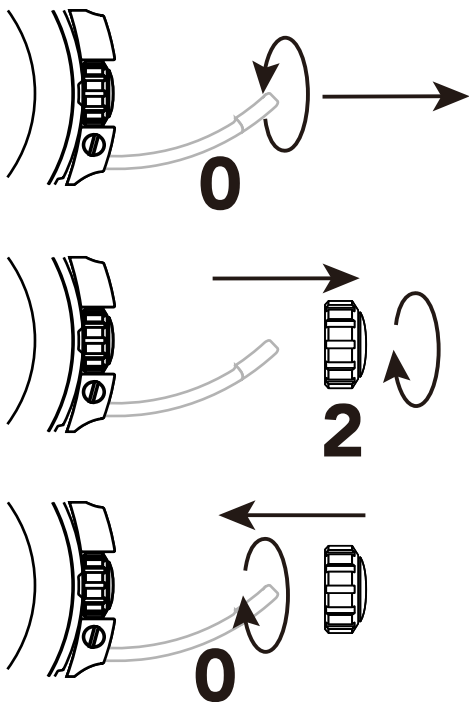

\* Do not set the date between 9:00 P.M. and 4:00 A.M.

# User Guide and Maintenance

## **HELIUM RELEASE VALVE**

The Helium release valve provides functionality for professional divers operating at great depths for prolonged periods of time.

Divers operating in such conditions often spend prolonged hours in diving bells under pressure breathing a gas mixture of helium or hydrogen. Since helium atoms are the smallest natural gas particles found in nature, these gas atoms are able to work their way inside the watch, around any o-rings or other seals the watch may feature.

This is not a problem as long as the divers stay under pressure, but when the decompression stops during resurfacing a pressure difference builds up between the trapped gas inside the watch case and its environment.

# User Guide and Maintenance

The Helium release valve safely allows the trapped gas to exit the case safely, without any damage to the integrity of the watch case.

The Helium Release valve does not need any manual intervention or adjustment.

Please make sure to employ the screw down crown on your timepiece for maximum water protection.

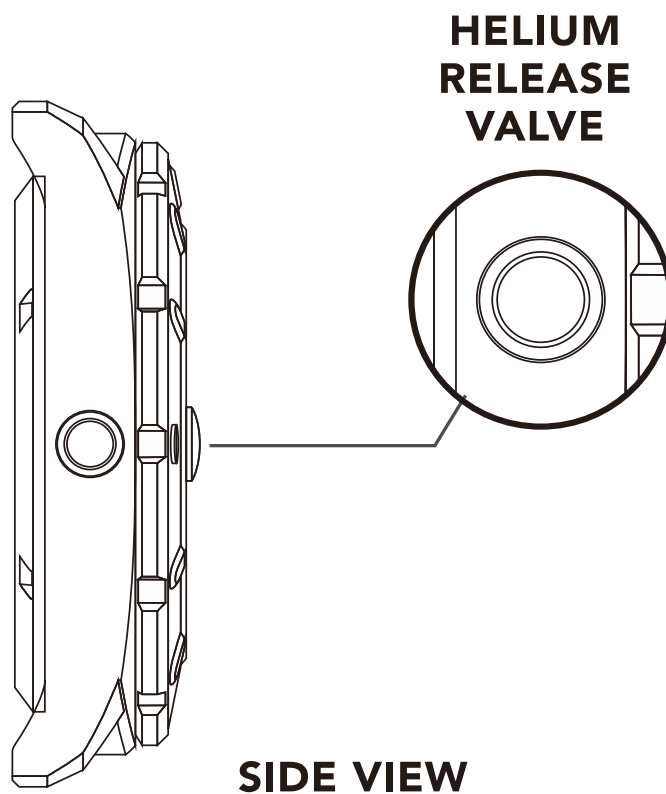

# User Guide and Maintenance

## **WATER RESISTANCE**

Note that the water resistance chart serves only as a guide (please refer to the water resistance chart on the next page). Actual water resistance may vary depending on a number of factors including water temperature, water salinity and use under water.

The water resistance of your timepiece may eventually be compromised over time with general wear and tear and use of your timepiece under adverse conditions.

Always remember to employ the screw down crown if available to maintain the water resistance of your timepiece. Warranty may be voided if the screw down crown has not been properly employed.

Note that you should NEVER wear your watch in a jacuzzi, hot shower or steam room where steam may enter the case despite the watertight seals used to protect your watch.

This may cause condensation inside your watch, which may affect and damage the inner workings of your watch.

# User Guide and Maintenance

<b>WATER RESISTANCE CHART</b>	<b>50M/ 5ATM</b>	<b>150M/ 15ATM</b>	<b>200M/ 20ATM</b>	<b>300M/ 30ATM</b>	<b>500M/ 50ATM</b>
<b>SPLASH/ SHOWERING</b>	<input checked="" type="checkbox"/>	<input checked="" type="checkbox"/>	<input checked="" type="checkbox"/>	<input checked="" type="checkbox"/>	<input checked="" type="checkbox"/>
<b>SWIMMING/ BATHING</b>	<input checked="" type="checkbox"/>	<input checked="" type="checkbox"/>	<input checked="" type="checkbox"/>	<input checked="" type="checkbox"/>	<input checked="" type="checkbox"/>
<b>BRIEF SWIMMING/ WATER SPORTS</b>	<input type="checkbox"/>	<input checked="" type="checkbox"/>	<input checked="" type="checkbox"/>	<input checked="" type="checkbox"/>	<input checked="" type="checkbox"/>
<b>PROLONGED SWIMMING/ FREE DIVING</b>	<input type="checkbox"/>	<input type="checkbox"/>	<input checked="" type="checkbox"/>	<input checked="" type="checkbox"/>	<input checked="" type="checkbox"/>
<b>SCUBA DIVING</b>	<input type="checkbox"/>	<input type="checkbox"/>	<input type="checkbox"/>	<input checked="" type="checkbox"/>	<input checked="" type="checkbox"/>
<b>PROFESSIONAL DEEP SEA DIVING</b>	<input type="checkbox"/>	<input type="checkbox"/>	<input type="checkbox"/>	<input type="checkbox"/>	<input checked="" type="checkbox"/>

Aquatrident

AQUATRIDENT In the deepest oceans  
BEST DIVE WATCHES

Explore the past with great ease



Thanks for choosing our product.

Start exploring new world with our watch now.



**AQUATRIDENT**