

Model : KS-SD-8545
Size : 850x450x250mm

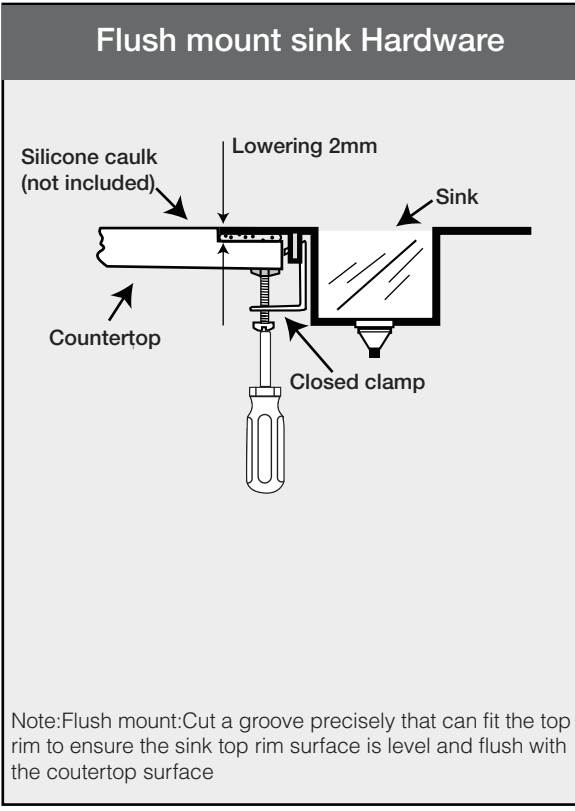

NOTE

- Always check the sink for blemishes or imperfections before installation, the cost of delivering and installing a replacement will be the responsibility of the customer.
- Always use the physical product measurements for Cut-Outs, the manufacturer's template is supplied as a Guide Only and may differ over time.
- ALWAYS check to ensure the product has all its components prior Installation.

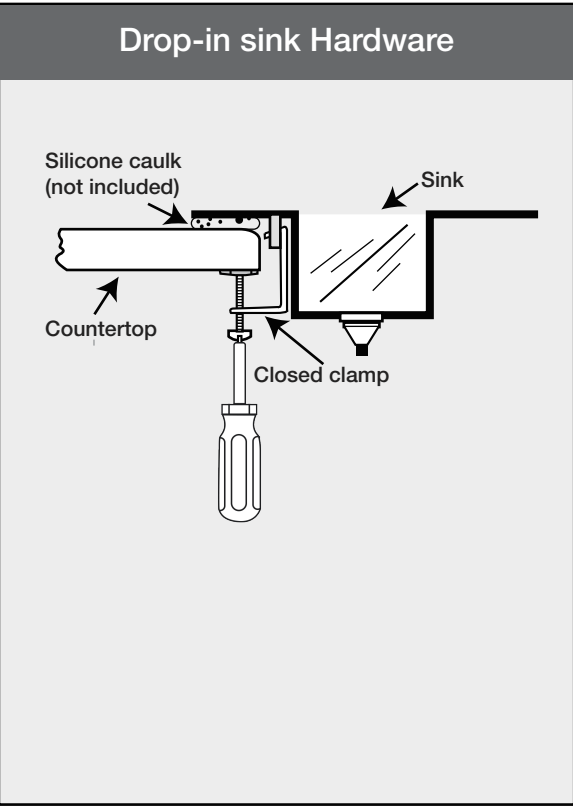
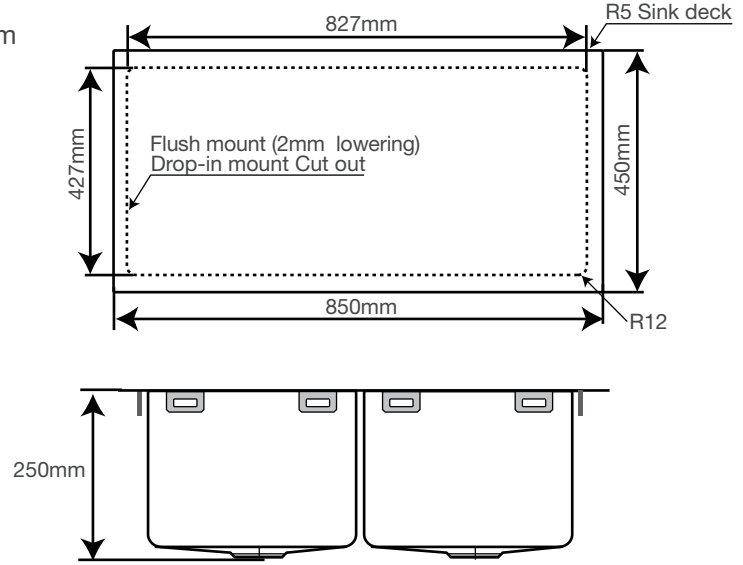
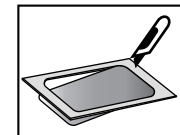

1. Use a level to check the counter/benchtop – if not level, have rectified. Ensure there is adequate space for tapware (including a splash back if specified).

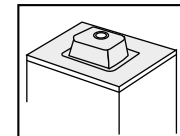

2. Follow the instructions on your template specific to your sink model. Please note that templates come as an outer or inner cut line. Illustrations on the left may not depict your template.

3. Place the template on the countertop in the exact location where the sink is to be installed. Take into account placement of the faucet and room for front deck. (If no template is available, carefully invert the sink over the counter/benchtop and trace around it.)

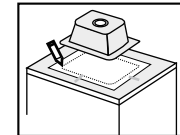

4. Mark cut out. Tape the template to the countertop in the final location chosen. Then trace on your countertop the indicated "Cut along this line" to achieve the proper hole pattern required for your sink.

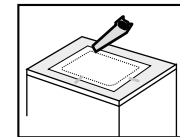

5. Cut & Finish hole. Drill a pilot hole inside the cut-out line. Using a jig saw, cut along the cut-out line.

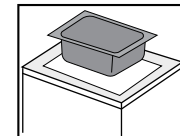

6. Trial fit the sink. Place the sink into the sink-opening. Check for proper clearance. If necessary, remove the sink and slightly proceed with remedial work.

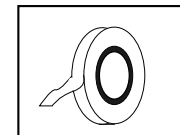

7. Depending on your cut-out specific to your sink, you may be able to use the sink if it has pre punched faucet holes to mark the faucet holes on the countertop. Alternatively, drill faucet

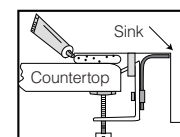

8. Masking. If using a sealant, masking is necessary to prevent sealant overrun. It is recommended that the edge of the sink and the edge of the cutout are both covered with a suitable masking tape. This tape should be removed within 2 days of application.

9. Mounting brackets . From the underside of the countertop, place the sink clamps in the mounting brackets around the sink . Do not fully tighten sink. See the illustrations on pages 1 (Sink Topmount Hardware))

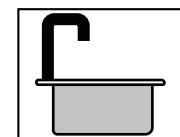

10. Apply silicone adhesive caulk to the underside of the sink rim and position sink into countertop opening

11. Position and align the sink correctly in the cutout and lower it onto the counter/benchtop. From underneath, tighten the clips with a screwdriver using a suitable tightening sequence (tighten from the centre of the sink to the outer edge) until the sink is secure and no gaps are visible. Take extra care if using power tools as over-tightening can damage clips.

Model : KS-SD-8545

Size : 850x450x250mm

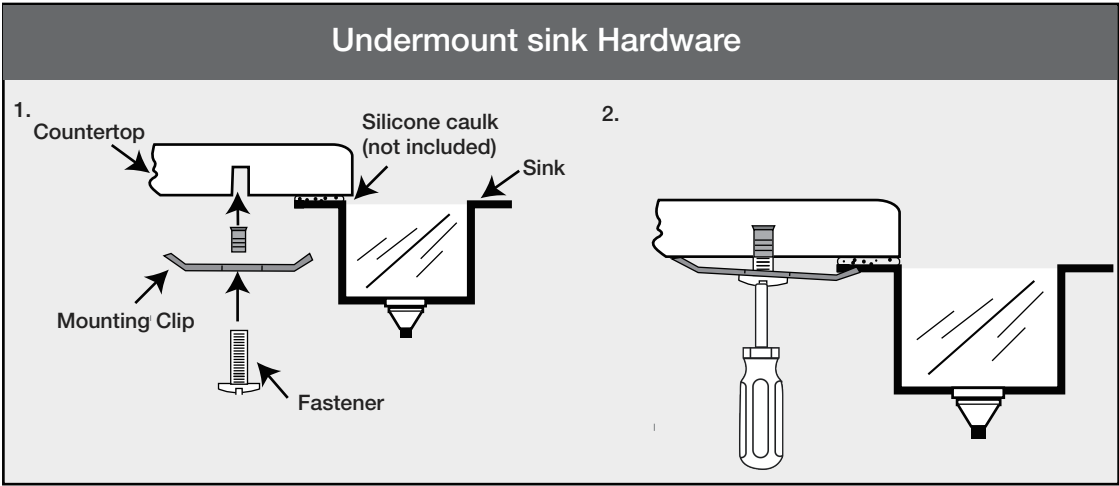
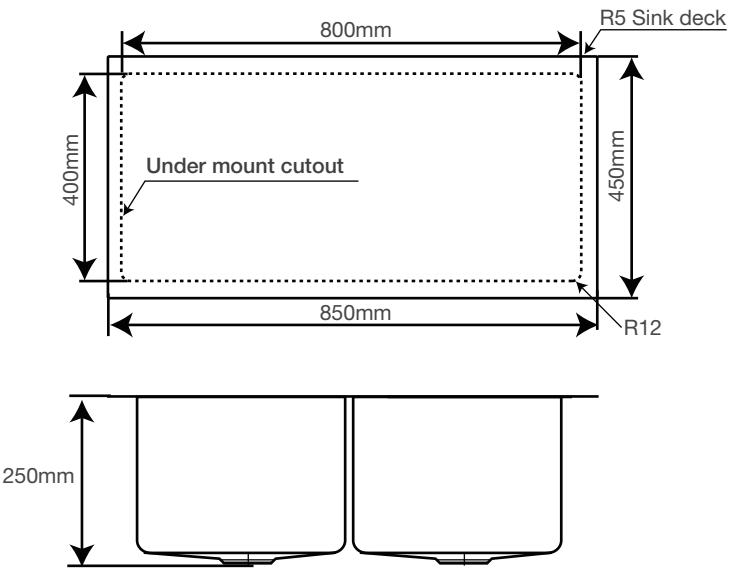

NOTE

- Always check the sink for blemishes or imperfections before installation, the cost of delivering and installing a replacement will be the responsibility of the customer.
- Always use the physical product measurements for Cut-Outs, the manufacturer's template is supplied as a Guide Only and may differ over time.
- ALWAYS check to ensure the product has all its components prior Installation.

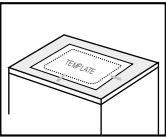

1. Use a level to check the counter/benchttop – if not level, have rectified. Ensure there is adequate space for tapware (including a splash back if specified) .

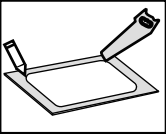

2. Follow the instructions on your template specific to your sink model. Please note that templates come as an outer or inner cut line. Illustrations on the left may not depict your template.

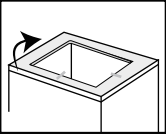

3. Mark cut out. Tape the template to the countertop in the final location chosen. Then trace on your countertop the indicated "Cut along this line" to achieve the proper hole pattern required for your sink.

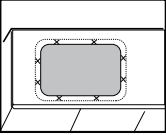

4. Cut & Finish hole. Drill a pilot hole inside the cut-out line. Using a jig saw, cut along the cut-out line.

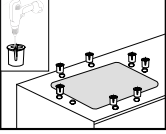

5. Turn countertop upside down to expose underside.

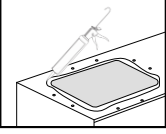

6. Drill mounting holes around countertop opening cut, dimension should be (33mm) from the edge of the sink bowl

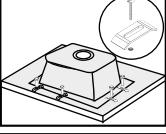

7. Drilling and anchoring may be required at this stage of installation. Locate and drill the mounting holes (following the countertop manufacturer's instructions) as shown. Make holes as even spacing of mounting brackets around the sink.

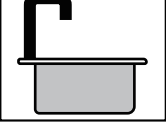

8. Clean underside of counter and top rim of sink thoroughly. Use a bead of silicon sealant 3-6mm away from edge of counter cutout and then attach sink on counter.

9. Install screws and clips into the countertop .

10. Complete counter installation and wipe away any excess caulk from sink rim.

11. Connect faucet and drain fittings.