

**GHARLENI** 

SPA, BEAUTY & WELLNESS

2021/2022

International Edition

Moers, Germany | Sales + Showroom // Gharieni Group GmbH • Gutenbergstr. 40 • D-47443 Moers

Moers, Germany | Distribution + Service // Gharieni Group GmbH • Am Schürmannshütt 24 • D-47441 Moers

Tel: +49 - (0) 28 41 - 88 300 - 0 • Fax: +49 - (0) 28 41 - 88 300 - 333 • www.gharieni.de • info@gharieni.com

Ettlingen // Gharieni Süd GmbH • Siemensstr. 11 • D-76275 Ettlingen

Tel: +49-(0)72 43-3322-363 • Fax: +49-(0)72 43-33 22-391 • ettlingen@gharieni.com

Nederweert | BeNeLux // Gharieni Nederland BV • Hulsenweg 14 • NL-6031 SP Nederweert

Tel: +31 (0) 495 - 63 30 36 • Fax: +31 (0) 495 - 62 66 63 • www.gharieni.nl • info@gharieni.nl

Dubai | UAE // Gharieni Middle East FZ-LLC • Park Hyatt Hotel • Dubai Creek Club St., P.O. Box 333203 • Dubai

Tel: +971 (0) 4 602 1819 • www.gharieni.ae • info@gharieni.ae

Aventura | USA // Gharieni USA Inc. • JW Marriott Miami Turnberry Resort & Spa • 19999 West Country Club Drive

Aventura Florida 33180 • Tel: +1 (855) 378 4772 • www.gharieni.com • info@gharieni.com



GREEN SPA is a sustainability initiative of the German Wellness Association for the spa and wellness industry. Our company supports the sustainable operation of spa and wellness facilities with suitable products and/or services.



# Contents

<b>Treatment Table Options</b>	<b>page 16</b>	<b>Loungers</b>	<b>page 144</b>	<b>Treatment Units</b>	<b>page 220</b>
<b>Wellness Concepts</b>	<b>page 26</b>	Evo Lounger	page 146	Spa Trolley HST	page 222
Psammo Concept	page 24	RLR	page 152	Spa Trolley GST	page 226
Wellmassage5D	page 34	RL Aqua	page 153	AluVap	page 230
Welnamis	page 40	RLX series	page 156	Twin	page 232
MLX i³Dome / iDome	page 46			Shiro Dhara series	page 234
Celliss	page 54			GlaStyle	page 236
				AluVap Junior	
<b>HydroSpa</b>	<b>page 58</b>	<b>Massage Tables</b>	<b>page 162</b>	<b>Furnishings</b>	<b>page 240</b>
PediSpa Square	page 60	MLW Transform	page 164	K8 Furniture series	page 242
PediSpa Compact	page 68	RLL	page 168	K9 Furniture series	page 246
PediSpa Curve	page 70	ML series	page 170	K10 Furniture series	page 248
Hair Swing	page 76	Ayurveda Table	page 176	MLX Trolley series	page 256
Libra Edge	page 78	Shiatsu Mat	page 182	MO Trolley	page 262
MLR Wet	page 84	Massage Tables accessories	page 184	Square Trolley	page 264
				CL Trolley	page 268
<b>Spa Tables</b>	<b>page 88</b>	<b>Treatment Beds</b>	<b>page 186</b>	GL Trolley series	page 270
MLX Limber series	page 90	Lina Select series	page 188	Cube Trolley series	page 272
MLX	page 98	601 series	page 196	Vario Trolley series	page 276
MLR Classic	page 104	SPL series	page 200	GlaStyle Trolley	page 278
MLR Select series	page 108	SLXP series	page 206	Lamica Trolley series	page 281
E-Line	page 116	Hydraulic series	page 212	Manicure Table Mano	page 284
MO1 Evo series	page 118	SLR	page 214	Manicure Table Cube Select	page 286
MLW F1 series	page 124	Treatment Beds accessories	page 218	Stools & Chairs	page 290
MLW Neo series	page 130				
MLE	page 137				
Spa Table accessories	page 140				

# Our awards

Various awards from the wellness, cosmetic, and medical industries for individual products, innovative developments, the highest quality, top design, as well as for excellent service and guarantee standards confirm our concept.

Pioneer Of Wellness 2020 (Gharieni Celliss)

Produkt Award „Innovativstes Produkt“ 2020 Spa & Wellness Mexicaribe (MLX i3Dome)

Innovation Award Deutscher Wellness Verband 2020 (MLX i3Dome)

Gold Award Aesthetic & Spa Awards 2020 Griechenland (Rubrik Spa Equipment)

Beauty Forum Sonderpreis der Redaktion – International Top Brand Spa Award 2018

ESPA Innovation Awards 2018 Special Jury Price (Spa.Wave System)

Spa & Wellness MexiCaribe Product Award 2017 (Spa.Wave System)

American Spa Magazine Professionals Choice Award 2017 (HydroSpa)

Beauty Forum Sonderpreis der Redaktion – Spa International Award 2016/17

Spa & Wellness Mexico Product Awards 2016 (Wellmassage5D)

ESPA – Winner „Innovative Spa Concept“ 2016 (Wellmassage5D)

Wellness & Spa Innovation Award 2016 (Wellmassage5D)

Dermascope Aesthetician Choice Awards 2016 (PediSpa Square)

Spa Professional Mexico Product Award for Best Spa Furniture 2015 (MLX Quartz)

Beauty Forum Sonderpreis der Redaktion – Spa International 2014

Beauty Forum Readers' Choice Award 2013/2014

Beauty Forum Award 2012/2013

Beauty Forum Readers' Choice Award 2011/2012

Beauty Forum Award 2010/2011

Beauty Forum Readers' Choice Award 2009/2010

u.v.m.





2019-2021

# For the third time Gharieni Group is Brand Official of Forbes Travel Guide

## About Forbes Travel Guide

Forbes Travel Guide is the only independent, global rating system for luxury hotels, restaurants and spas. Started as Mobil Travel Guide in 1958, the company created the first Five-Star rating system in the United States. Today, Forbes Travel Guide's incognito inspectors travel the world, evaluating properties based on up

to 900 rigorous, objective standards. The company's annual Star Ratings, reviews and daily travel stories help discerning travelers select the world's best luxury experiences.

Read more about Forbes Travel Guide: [www.forbestravelguide.com](http://www.forbestravelguide.com)

The Gharieni Group is the only spa supplier to have been selected by the prestigious international Forbes Travel Guide as one of its "Brand Officials" - for the third year in a row. This is because Gharieni's world-class products and excellent customer service in the spa and wellness sector meet the high benchmarks and standards that Forbes Travel Guide uses to evaluate spas, luxury hotels and restaurants. This great recognition reflects our engagement to provide our customers with outstanding service, highest comfort and first-class design.

From initial concept to installation, Gharieni strives to provide clients with a memorable and immersive treatment experience by incorporating multi-sensory components and extensive customisation options into its products. The designation by Forbes Travel Guide will reinforce our goal to pay utmost attention to the design details and differentiation of our equipment.

"We are pleased to name the Gharieni Group as the Official Spa & Wellness Equipment Manufacturer of Forbes Travel Guide," said Filip Boyen, CEO of Forbes Travel Guide. "Gharieni's team of experts oversees every step of design and customizes spa tables, treatment beds and more based on client need. The company, which has more than 25 years in the business, puts guest experience at the forefront of its innovative products."

# The Gharieni Group

With 30 years of experience, Gharieni Group GmbH is one of the leading international manufacturers of high-quality spa tables, treatment tables, and equipment for the areas of spa, wellness, cosmetics, and foot care/podiatry.

Our tables and device furnishings, as well as our cosmetic and medical equipment, are sold on all continents in nearly 100 countries worldwide. Luxury hotels as well as high-end spas and resorts around the globe rely on our "Made in Germany" products.

First-class material, outstanding quality, the best functionality, modern design, and exclusive innovations, coupled with the flexibility to respond quickly to customer requirements: that is our company's maxim.

We do not just think of ourselves as a manufacturer of equipment. We are in fact concerned with creating very special wellness experiences. Thus we have both the end

customer as well therapists in mind. We want to offer end customers unique relaxation and treatment experiences and therapists absolutely comfortable, ergonomic working with our products.

When developing our products, we think it's important to "think outside the box." Our in-house development department works continuously with specialists from other professions. This brainpool isn't just the birthplace of new ideas. The expertise and innovations of other industry branches are also profitably incorporated here, such as in the fields of medicine and technology. In addition, designers with their expert knowledge are available for visually and functionally convincing implementation.

Our vision is simple: We want to offer you as our customer nothing less than the best possible equipment for unforgettable moments.



# Certified Quality

for Gharieni treatment tables  
and treatment units

"Made in Germany" production



In order to always live up to the "Made by Gharieni" brand, the standard "quality without compromise" applies in our company. This also includes guaranteed quality, because only this offers customers both transparency and security. In order to provide you with clear facts about the proof of production and to show that social responsibility as well as consumer interests are very important to us, we have put ourselves through a costly certification procedure by TÜV NORD and since early 2012 it's "official." In accordance with the TÜV NORD test criteria, our products in the areas of treatment tables and treatment units may be awarded the seal "Made in Germany!"

Quality management  
in accordance with ISO 13485



Of course, our manufacturing and administration are also subject to constant quality control. Comprehensive quality management of business processes has been in existence for over ten years and includes ISO 13485 certifications. As a customer, this guarantees you both product quality and excellent service, a combination that can hardly be found elsewhere!



**Cruise Ships** AIDA-Cruises, Hyperion-Klasse // TUI Cruises, Mein Schiff 2 - 6 // MS Europa 2 // P&O Pacific Dawn // Celebrity Edge // Norwegian Bliss // Genting Dream, Dream Cruises

**Hotels/Spa Resorts** Severins Resort & Spa<sup>S</sup> Sylt, Germany // Grand Hotel & SPA Kurhaus Ahrenshoop Ahrenshoop, Germany // // Titanic Hotel Berlin Berlin, Germany // "Kreuz-Post" Hotel-Restaurant-Spa Vogtsburg, Germany // A-ROSA Scharmützelsee Bad Saarow, Germany // Hotel Bülow Palais Dresden, Germany // Hotel Hyatt Regency Düsseldorf/Mainz/Köln, Germany // Grand Hyatt Berlin Germany // Hotel Traube Tonbach Baiersbronn, Germany // Hotel Sofitel Frankfurt Opera Germany // Parkhotel Bansin Usedom, Germany // Steigenberger Hotel Frankfurter Hof Germany // Grand Hotel Heiligendamm Bad Doberan-Heiligendamm, Germany // The Westin Grand München Munich, Germany // A-Ja Resort Warnemünde, Germany // Althoff Seehotel Überfahrt Rottach-Egern, Germany // Lindner Hotel Dom Residence Cologne, Germany // Brenners Park-Hotel & Spa Baden-Baden, Germany // Nordseefarm Büsumer Deichhausen, Germany // Relais & Châteaux Hotel Die Sonne Frankenberg<sup>S</sup> Germany // Hotel Bergström Lüneburg, Germany // Wellnesshotel Bodenmaier Hof Bodenmais, Germany // Steigenberger Hotel am Kanzleramt Berlin, Germany // Titanic Deluxe Berlin Germany // Titanic Chaussee Berlin Germany // Hotel BEI SCHUMANN<sup>S</sup> Schirgiswalde, Germany // Budersand Hotel, Golf & Spa Sylt, Germany // Cliff Hotel Rügen - Resort & Spa Germany // Colombi Hotel Freiburg, Germany // Das Stue Berlin, Germany // Althoff Grandhotel Schloss Bensberg Bergisch-Gladbach, Germany // Kameha Grand Bonn Germany // Bodenmaier Hof Germany // Steigenberger Grandhotel & Spa Usedom, Germany // Swissôtel Dresden Am Schloss Germany // The Mandala Hotel Berlin, Germany // Das König Ludwig Wellness & SPA Resort Allgäu<sup>S</sup> Schwangau, Germany // Moselromantik-Hotel Keßler-Meyer<sup>S</sup> Cochem, Germany // Kempinski Hotel Frankfurt Gravenbruch Neu-Isenburg, Germany // Lindner Parkhotel & Spa Oberstaufen, Germany // InterContinental Düsseldorf Germany // Ulrichshof Baby & Kinder Bio-Resort Rimbach, Germany // Wellings Romantik Hotel zur Linde Moers, Germany // Steigenberger Grandhotel and Spa Heringsdorf, Germany // W Amsterdam Netherlands // Corendon City Hotel Amsterdam Netherlands // The Lamp Hotel Norrköping, Sweden // Hotel Kaiserblick Ellmau Austria // Domaine La Butte aux Bois Lanaken, Belgium // Hotel Sans Souci Vienna, Austria // Grand Tirolia Kitzbühel, Austria // Park Hyatt Vienna Austria // AIGO welcome family Aigen, Austria // Hilton Vienna Plaza Austria // Grand Hotel, Wien Austria // Genusdorf Gmachl<sup>S</sup> Bergheim, Austria // Alpenresort Schwarz Mieming, Austria // Bürgenstock Resort Lake Lucerne Switzerland // The Dolder Grand Zurich, Switzerland // InterContinental Davos Switzerland // W Verbier Switzerland // Seehotel Waldstätterhof Brunnen, Switzerland // The Alpina Gstaad Switzerland // Hotel Crans Ambassador Luxury Sport Resort Crans-Montana, Switzerland // Hotel Plunhof South-Tirol, Italy // Falkensteiner Resort Capo Boi Villasimius, Italy // JW Venice Spa Italy // Preidhof Luxury DolceVita Resort Naturno, Italy // Mandarin Oriental Milan Italy // Maison Albar Hotel Paris Champs-Élysées France // Hotel de Crillon Paris, France // Hotel Lutetia Paris, France // Hotel Molitor Paris - Mgallery Collection France // Hôtel les bains d'Arguin Arcachon, France // Hotel Sofitel Biarritz le Miramar Thalassa Sea & Spa France // Hôtel La Réserve Paris France // Grand Hôtel de Cala Rossa & Spa by Clarins R&C Korsika, France // Hotel Barriere Les Neiges Courchevel, France // The Ritz-Carlton, Budapest Hungary // The Beaumont London, England // Brimstone Hotel Langdale, England // Sopwell House St Albans England // The May Fair London, England // Mandarin Oriental Hyde Park, London England // Radisson Blu Edwardian Manchester, England // Jumeirah Carlton Tower London, England // Ramside Hall Hotel & Spa Durham, England // Grand Jersey Hotel & Spa St Helier, Jersey // Four Seasons Hotel Hampshire England // The Johnstown Estate Johnstownbridge, Ireland // Galgorm Resort & Spa Ballymena, Northern Ireland // Talacre Beach Holiday Home Park Wales // Gazelli House London, England // The Manor House Wiltshire, England // Four Seasons Hotel London at Ten Trinity Square England // Vila Vita Parc Resort and Spa Pórcos, Portugal // The One Barcelona Spain // Sheraton Mallorca Arabella Golf Hotel Palma de Mallorca, Spain // Park Hyatt Mallorca Spain // The Ritz-Carlton Istanbul, Turkey // Mandarin Oriental, Bodrum Turkey // The Grand Tarabya Istanbul, Turkey // Maxx Royal Kemer Resort Kemer, Turkey // Regnum Carya Golf & Spa Resort Belek, Turkey // JW Marriott Hotel Ankara Turkey // Raffles Istanbul Turkey // Vidago Palace Hotel Portugal // Hotel Metropol Monte Carlo, Monaco // Kempinski Hotel Grand Arena Bansko Bulgaria // Hotel Arłamów Poland // Hilton Tallinn Park Estonia // Four Seasons Hotel Moscow Russia // IDW Esperanza Resort Litauen // Belvedere Hotel (Six Senses Spa) Mykonos, Greece // Six Senses Hideaway Zighy Bay Oman // Mandarin Oriental Doha Qatar // The Ritz-Carlton Doha Qatar // Sofitel Dubai The Palm Resort & Spa UAE // Caesars Palace Bluewaters Dubai, UAE // The Oberoi Dubai, UAE // FIVE Palm Jumeirah UAE // Palazzo Versace Dubai UAE // Four Seasons Hotel Abu Dhabi At Al Maryah Island UAE // The Address Downtown Dubai UAE // Talise Spa Madinat Jumeirah Dubai, UAE // Burj Al Arab Dubai, UAE // Emirates Palace Abu Dhabi UAE // The Peninsula Hong Kong // Rosewood Beijing Peking, China // Four Seasons Resort Langkawi Malaysia // The Chateau Spa & Organic Wellness Resort Kuala Lumpur, Malaysia // Four Seasons Hotel Jakarta, Indonesia // Cheval Blanc Randheli Noonu-Atoll, Maldives // Velaa Private Island Maldives // The Oberoi Sukhvilas Resort & Spa Punjab, India // Anahita The Resort Mauritius // Four Seasons, Mahe Island Seychelles // Four Seasons Hotel The Westcliff Johannesburg, South Africa // Hotel Sofitel Agadir Royal Bay Resort Morocco // Sofitel Marrakech Morocco // The Residence Tunis, Tunisia // La Cigale Tabarka Hôtel-Thalasso & Spa - Golf Tunisia // Crown Towers Perth Australia // Sofitel Abidjan Hôtel Ivoire Côte d'Ivoire // Jumbo Bay, A Rosewood Resort Antigua // Hilton Barbados // Gran Caribe Kuba // Cheval Blanc St-Barth Saint-Barthélemy



// The Brando Tetiaroa French Polynesia // Four Seasons Resort Seychelles at Desroches Island // Jewel Grande Montego Bay Resort and Spa Jamaica // JW Marriott Miami Turnberry Resort & Spa Miami, USA // Four Seasons Hotel Los Angeles at Beverly Hills California, USA // Carlsbad Oceanfront Resort & Spa California, USA // Grand Hyatt New York USA // SeaHill Spa at The Cavalier Hotel, Autograph Collection Hotel Virginia Beach, USA // Four Seasons Surf Club Miami USA // Conrad Bora Bora Nui French Polynesia // Cosmopolitan Hotel East Tower Las Vegas, USA // Peninsula Chicago USA // Sothys Spa at Lucky Dragon Hotel & Casino Las Vegas, USA // Kona Kai Resort San Diego, USA // The Setai Hotel Miami, USA // La Cantera Hill Country Resort San Antonio, USA // The Breakers Palm Beach, USA // Bergamos Retreat, Friendswood Texas, USA // Four Seasons Hotel Houston Texas, USA

**Hot Springs/Thalasso** // 7 Welten Therme & Spa Fulda/Künzell, Germany // Rupertus Therme Bad Reichenhall, Germany // Caracalla Therme Baden-Baden, Germany // Bali Therme Bad Oeynhausen, Germany // Thalassozentrum ahoi! Cuxhaven Germany // Deep Nature Spa & Thalasso Algotherme Deauville France // Thalassothérapie Thalazur Cabourg France // Glen Ivy Hot Springs Corona, USA

**Day Spas** // Aiyasha Medical Spa Munich, Germany // Dermedis Germany // Babor Beauty Spa's Germany // Flughafen Düsseldorf Germany // Lufthansa Lounge Frankfurt Airport Germany // Nordseefarm Büsumer Deichhausen, Germany // Purezense Spa Baden-Baden, Germany // H2 Beauty Lounges Bad Nauheim, Germany // KaDeWe Berlin, Germany // H1-Spa Konstanz, Germany // Beauty Lounge Bolmerg Berlin, Germany // Lasmiranda Tattoo & Beauty Herrenberg, Germany // estetica Medical Beauty and Wellness Iserlohn, Germany // HAUT+ Kosmetikinstitut Frankfurt, Germany // BABOR Beauty Spa Wien Vienna, Austria // WAX! Baby Urban Beauty Salzburg, Austria // Dhevari Spa Wien Vienna, Austria // Cosmeda International Rinteln, Germany // Cosmetic Institute Munich Airport, Terminal 2 Germany // Phytomer Spa & Wellness à St Malo France // Clarins Skin Spa Neuilly sur Seine France // Les thermes d'Evian Evian les Bains, France // Printemps Lyon, France // THIRTY NINE Monte Carlo Monaco // Guerlain L'Institut Praha Prague, Czech Republic // Aether Institute Prague, Czech Republic // Limelight Spa (Rolex) Biel, Switzerland // The House of Elemis London, England // Lanes of London England // Zabeel Ladies Club Dubai, UAE // Maison Lutétia Paris & Dubai // Koroviar Spa Seoul, Korea // King Waterpark Dallas, USA // Island Spa Catalina Catalina Island, USA // Dr. Sears Center for Health and Wellness Palm Beach, USA // Bonita Bay Bonita Springs, USA // The Westin Ka'anapali Ocean Resort Villas Hawaii // Ocean Reef Club Key Largo, USA

**Medical** // Praxisklinik MKG-Chirurgie Pescheck/Romsdorfer Schwäbisch Hall, Germany // Dr. Jorjani Aesthetics Bonn, Germany // SH Better Skin Ismaning, Germany // Die Ästheten - Medical Spa Munich, Germany // Dermazentrum München, Germany // Hautarztpraxis im Vorderen Westen, Kassel, Germany // Dermatologie am Luegplatz Düsseldorf, Germany // Medical Skin Center - Dr. med. David Bacman Cologne, Germany // Ästhetik am HEH, Braunschweig, Germany // BLUSH Beauty & Skin Clinic Amsterdam, The Netherlands // Falck Clinic Amsterdam, The Netherlands // Médoc Beauty Belgium // Iuventu Anti-Aging Clinic Brussels, Belgium // Mohs Klinieken Amsterdam, The Netherlands // Prevention Center Zurich, Switzerland // Institut de Formation et de Perfectionnement aux Métiers Nanterre, France // Clinique La Prairie Madrid, Spain // New York Dermatology Group NYC, USA // Dr. Dennis Gross NYC, USA // Cosmetic Surgery & Aesthetic Lounge - Dr. Kevin Sadati Newport Beach, USA // Regenesis Cosmetic Surgery Kent Town, Australia // Highness Beauty Clinic & Spa Dubai

**Training Centers** // Cosmeda Rinteln, Germany // Traute de Lorenzi Cologne, Germany // Jean d'Arcel Cosmétique Kehl, Germany // Schulungszentrum Academie Scientifique de Beauté Baden-Baden, Germany // Dermalogica Schulungszentren Germany // Dr. Babor Schulungszentrum Aachen, Germany // Klapp Cosmetics Schulungszentren Germany // Malu Wilz Schulungszentrum Munich, Germany // Reviderm Munich, Germany // PUREBEAU Schulungszentrum Berlin, Germany // Dr. Spiller Elixhausen, Austria // KTA Stabroek, Belgium // Maria Galland Trainingscenter Bilthoven, Netherlands // Helene V - Skin Academy Beersel, Belgium // QMS Elen, Belgium // Chamomilla Vollenhove, The Netherlands // Absolution Creative Apothecary Appeldoorn, The Netherlands // Skins Cosmetics Groningen, The Netherlands // Dermalogica Breda, The Netherlands // Thalazur Arcachon, France // ENVIRON Benelux, France

**Brands** // Ligne St. Barth Munich, Germany // Hildegard Braukmann Kosmetik Germany // [comfort zone] Deventer, The Netherlands // IKARI Flagshipstore Antwerp, Belgium // Clarins USA Miami, USA // La Colline, Switzerland // NIANCE World of Luxury, Switzerland // Goldbad, Switzerland // Vinoble Fresing, Austria // Natura Bissé England // **and many more!**

are you  
next?

# Testimonials

” *It is the combination of an exclusive, elegant ambience, combined with tailor-made treatments and also staff who are passionate about what they do that makes the Onda Spa stand out. The Gharieni treatment beds play a major role in this. Thanks to the wide range of settings, the heat function and also the quality of the materials used, our guests experience enormous comfort when lying down. At the same time, our staff also have the possibility to individually adjust the couch to their needs.*

*Stefan Margesin, Director Quellenhof Luxury Resorts*



” *For many years, we have shared a passion for outstanding quality, technical innovation and absolutely unique spa experiences with Gharieni. We are just as enthusiastic about the professional, cooperative and always personal support as we are about the constant effort to find the best individual solution for our spa projects together with us.*

*Fatima Diagana, Founder of Diagana Spa Design*



” *I chose Gharieni beds because quality was of utmost importance to me and my clients. Our spa guests spend their entire treatment on a treatment bed. It is important they are comfortable (including our therapists!) Gharieni has a fabulous range of beds – they're all great! It depends on the spa, the concept and the treatment menu offering.*

*Sonal Uberoi, Owner & Founding Director of Spa Balance*





*"Cloud or water lounger?"*

*Every time my clients make themselves comfortable on one of our Gharieni spa tables, there's a, "Wow, this is beautiful, I'll never get up from here again. Gorgeous!"*

*You can see that wow, that smile in their eyes as they lie down on the wellness couch. We at REVIDERM skinmedics Berlin have a choice between our soft treatment bed with cloud feeling or the water spa table. Both adapt perfectly to the body and make you feel like you're floating. At the latest, when I activate the integrated heating function, my customers don't want to get up anymore. My clients love the Gharieni loungers and I love them too.*

*Bettina Greger, REVIDERM skinmedics berlin*

”



*We have custom-made Gharieni beds that feature our signature tarnished gold palette and have curvatures that are very characteristic of the spa design. We also have a Quartz bed, which is ideal for our various energy treatments, including our signature mental free one. We also use it for acupuncture. Guests find all our Gharieni beds extremely comfortable.*

*Marina Efraimoglou, Founder of Euphoria Retreat*

”



*We appreciate having a partner like Gharieni who shares this vision for bringing innovation and creativity into the spa experience. We have now placed the Gharieni Quartz Bed into three locations: Kuala Lumpur, Doha and Beijing. The nice thing about this treatment is that it is not trying to reinvent an entirely new spa experience, but rather enhances the spa treatments that our guests already enjoy. The heated quartz crystals and the unique features of the bed amplifies the positive effects of our therapeutic treatments.*

*Jeremy McCarthy, Group Director of Spa and Wellness, Mandarin Oriental*

”

# Our partners



[www.elemis.com](http://www.elemis.com)



[www.guerlain.com](http://www.guerlain.com)

CLARINS

[www.clarins.de](http://www.clarins.de)



[www.babor.com](http://www.babor.com)



[www.biologique-recherche.com](http://www.biologique-recherche.com)



[www.lignestbarth.com](http://www.lignestbarth.com)

PHYTOMER

[www.phytomer.com](http://www.phytomer.com)

MALU WILZ  
BEAUTY COLLECTION

[www.maluwilz.de](http://www.maluwilz.de)

THĒMAË  
PARIS

[www.themae.fr](http://www.themae.fr)

SHISEIDO

[www.shiseido.com](http://www.shiseido.com)



[www.academiebeaute.com](http://www.academiebeaute.com)

REVIDERM

[www.reviderm.de](http://www.reviderm.de)

SOTHYS  
PARIS

[www.sothys.de](http://www.sothys.de)

DR. BARBARA  
STURM

[www.drsturm.com](http://www.drsturm.com)



[www.rimpler.de](http://www.rimpler.de)



[www.vinoble-cosmetics.at](http://www.vinoble-cosmetics.at)

THALGO  
LA BEAUTÉ MARINE

[www.thalgo.de](http://www.thalgo.de)

Pietrulla

[www.pietrulla.de](http://www.pietrulla.de)



[www.pharmos-natur.de](http://www.pharmos-natur.de)

GOCO  
HOSPITALITY

[www.gocohospitality.com](http://www.gocohospitality.com)

RAUE  
Kosmetik- & Fußpflegebedarf

[www.raue-shop.de](http://www.raue-shop.de)



[www.monteil.com](http://www.monteil.com)

ANNEMARIE  
BÖRLIND  
NATURAL BEAUTY

[www.boerlind.com](http://www.boerlind.com)

VOYA

[www.voya.ie](http://www.voya.ie)



HILDEGARD  
BRAUKMANN

[www.hildegard-braukmann.de](http://www.hildegard-braukmann.de)

[ comfort zone ]  
a complete sense of beauty

[www.comfortzone.de](http://www.comfortzone.de)



[www.ist.de](http://www.ist.de)

La Colline  
Swiss Riviera Beauty Treatment

[www.colline.fr](http://www.colline.fr)

GAZELLI  
HOUSE

[www.gazelliskincare.com](http://www.gazelliskincare.com)

**JEAN D'ARCEL**  
COSMETIQUE

[www.jda.de](http://www.jda.de)

*Cinderella*  
PARIS

[www.cinderella.com](http://www.cinderella.com)

  
**KURLAND**  
MIT DER KRAFT DER NATUR

[www.kurland.de](http://www.kurland.de)

*Dr. Spiller*  
Pure SkinCare Solutions  
[www.dr-spiller.com](http://www.dr-spiller.com)

  
**Goldeneye**  
[www.goldeneye.de](http://www.goldeneye.de)

**NIANCE**  
SWITZERLAND

[www.niance.ch](http://www.niance.ch)

  
**SIX SENSES**  
RESORTS & SPAS

[www.sixsenses.com](http://www.sixsenses.com)

**DORN  
BRACHT**

[www.dornbracht.com](http://www.dornbracht.com)

**VITALIS**  
DR JOSEPH  
  
[www.vitalisdrjoseph.com](http://www.vitalisdrjoseph.com)

**URB'N  
NATURE**  
ORGANIC COSMETICS  
[www.urbn-nature.com](http://www.urbn-nature.com)

**KLAFS**  
MY SAUNA AND SPA  
[www.klafs.de](http://www.klafs.de)

 **PUREBEAU**  
[www.purebeau.com](http://www.purebeau.com)

**GERTRAUD  
GRUBER**  
KOSMETIK KULTUR  
[www.gertraud-gruber.de](http://www.gertraud-gruber.de)

*La mer*  
Der Ursprung der Schönheit  
[www.la-mer.com](http://www.la-mer.com)

**absolution**  
Creative Apothecary  
[www.absolution.nl](http://www.absolution.nl)

SUSANNE KAUFMANN™

[www.susannekaufmann.com](http://www.susannekaufmann.com)

**TRAUTWEIN**

[www.trautwein-gmbh.com](http://www.trautwein-gmbh.com)

**SPA CONNECTORS**

[www.spaconnectors.com](http://www.spaconnectors.com)

  
**MARIA GALLAND**  
PARIS  
[www.maria-galland.de](http://www.maria-galland.de)

  
**AROMATHERAPY  
ASSOCIATES**  
[www.aromatherapyassociates.com](http://www.aromatherapyassociates.com)

**CINQ MÖNDES**  
SPA PARIS  
[www.cinqmondes.com](http://www.cinqmondes.com)

*cNc*  
ULTRA CARE  
[www.cnc-cosmetic.de](http://www.cnc-cosmetic.de)

  
**RKF**  
L'ART DE LA BEAUTE  
[www.rkf.fr](http://www.rkf.fr)

  
*Doctor  
Eckstein*  
BioKosmetik  
[www.eckstein-kosmetik.de](http://www.eckstein-kosmetik.de)

**KERSTIN  
FLORIAN**  
[www.kerstinflorian.com](http://www.kerstinflorian.com)

**ANNE SEMONIN**  
PARIS  
[www.annesemonin.com](http://www.annesemonin.com)

**dermalogica**  
[www.dermalogica.de](http://www.dermalogica.de)

**DEYNIQUE**  
[www.deynique.org](http://www.deynique.org)

 **SKINCEUTICALS**  
[www.skinceuticals.com](http://www.skinceuticals.com)

**AURA | CHAKÉ** INST.  
PARIS  
[www.aurachake.fr](http://www.aurachake.fr)

**bamford**  
[www.bamford.co.uk](http://www.bamford.co.uk)

  
**BURGENER**  
SWITZERLAND  
[www.drburgener.com](http://www.drburgener.com)

...and  
many more

# FIVE Palm Jumeirah Dubai, UAE





Photos: © FIVE Palm Jumeirah

# Table Options

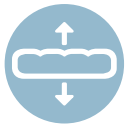

## Soft Upholstery

In addition to the standard upholstery, tables with this symbol can also be equipped with a significantly thicker, very soft cushioning. Depending on the type of table, this soft upholstery is available with both a PU and synthetic leather cover. The extra-soft upholstery provides an even higher degree of lying comfort, in particularly for longer treatment sessions.



## Electrical Arm supports

For even more comfort, the arm supports - as well as the height, the back, leg, and foot section - can be fitted with actuators for electrical adjustment. In addition to direct control via pushbuttons on the arm supports themselves, their position can be conveniently saved using the memory functions. This can bring the entire table into the preprogrammed position with the push of a button.



## Vibro-Wellness

Vibro-Wellness is a pleasantly massaging vibration system. Ten different vibration motors in the upholstery can be controlled individually via a manual switch. The vibrations work on shoulder (back part), seat, and calves.

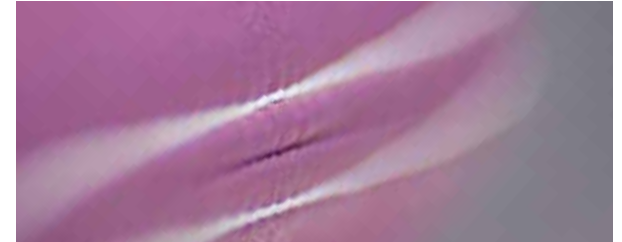

## Electrical Triple-Airback®

Many of our spa tables and a few of our cosmetics models can be equipped with an electrically-controlled Triple-Airback®. This lordosis support system is divided into three individually controllable zones and perfectly adapts the cushion in the lower back area to the physical needs of your customers. Airback® is particularly appreciated during longer treatment sessions or by people with back problems.

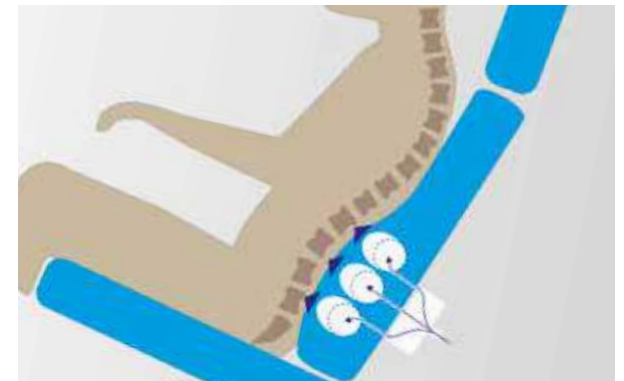





## Smart-Thermo Heating System

The intelligent Smart-Thermo heating system is integrated into the upholstery of the table and works with modern microprocessor technology. During the start-up phase, it heats with full power to achieve a comfortable temperature on the surface as soon as possible. Then, it is kept constant until the safety switch automatically turns off the heating after a predefined time. The variable parameters can be set via a programming sequence, which is initiated by a specific key combination. The Smart-Thermo heating system works with DC and is therefore almost free from electrosmog.



## Logo embroidery

Treatment beds with this symbol have the option of having your logo embroidered into the upholstery or the neck rest. Only possible with synthetic leather upholstery.



## (Multi-)Color upholstery

For the table models with this symbol, two or three colors can be selected from our various trendy colors and combined in a multi-color upholstery. You can find our color charts with the current collection on page page 21 of the catalog.



## Dual Headrest

Spa tables with this symbol can be equipped with the new, unique dual headrest. With this version, the face cradles can be swapped between a classic o-shaped and a softer horn-shaped insert.



## Multifunctional Headrest

The special headrest holder allows a variety of individual settings thanks to its double-joint system, which can not be achieved with a normal headrest. In conjunction with the separately available head sections, this makes almost every treatment in the head area possible. The following attachments are available:

### Crescent headrest

This headrest made of soft, washable PU, is ideal for cosmetic treatments, because the areas of the throat, neck, and shoulders are completely free and can thus be treated comfortably. At the same time, the customer's head is held in a comfortable and stable fashion. Also ideal for permanent makeup and foot care/podiatry!

### U-shaped headrest

With washable synthetic leather, soft upholstery. Both headrests can only be used in conjunction with the multifunctional mounting. Ideal for back massages!



Crescent headrest



U-shaped headrest

### Accessories for multifunctional headrest

Synthetic leather cover for crescent headrest, Art. 48005    -,-

10 single-use covers for crescent headrest, Art. 75236    -,-

Terrycloth cover for U-headrest, Art. 45018    -,-

# Table Options



## XL Extension

This clever alternative to the conventional headrest allows individual adaptation to each customer: Simply remove the standard headrest and replace it with the XL Extension. This way both slimmer and wider individuals can be treated in a fashion that is ergonomically best for them. This is particularly useful in the massage position because the XL Extension serves as a support surface for the arms. The XL Extension can of course also be adjusted by simply pulling it out. For the Lina, SLXP and SPL treatment beds, the XL Extension is also available with a face cradle! (Not available with soft upholstery!)



## Color- XL Extension

The XL extension can of course also come in a color from our current collection, as can the table itself. You can find our color charts at page page 21.



## Color Basic

### Color casing

A treatment bed with this symbol is also available with the base, in addition to the standard white, in titanium-colored casing..



Casing in  
titanium

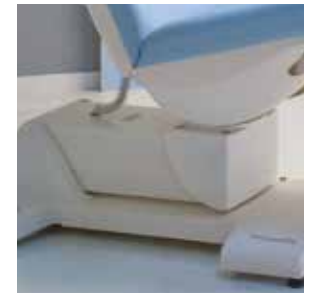

White standard  
Casing

### Special coating of the metal parts

A special coating of the metal parts in RAL colors is possible in models with this symbol. The colors black-brown, white, and titanium (RAL 9007) are included in the table price.



## Spa Ambience Light

Present your spa table in the proper light! This symbol indicates tables with hidden LED bar at the base. The indirect lighting creates an atmospheric ambience. With most tables you can choose from eight different light colors as well as an automatic color change at the push of a button.



## Wood Decor

Most of our spa tables are available standard in wenge-pattern or white. For tables with this symbol, you can also select your own favorite decor and before you know it, your table will be a perfect fit for your space! Ask for our current decor palette or visit our website at:

[www.gharieni.de/farbpalette-holzdecore](http://www.gharieni.de/farbpalette-holzdecore)

### Gharieni Standard-Dekore



## Rotonde

The Rotonde function enables treatment beds to be rotated to the left or right a total 330°. Due to this rotation, the customer can be easily put into the ideal position during treatment. By means of a side lever, the desired position of the table can be determined and also released again. 360° rotation is possible with our hydraulic models. Here the Rotonde function is included for technical reasons.



## Castors

### Additional castors

Treatment beds with this symbol can be equipped with braked castors. This makes it possible to easily move the table.



### Electrically retractable castors

Instead of the mechanical castor mechanism, our spa tables with this symbol are also available with electrically extendable castors. These are controlled via the table's manual switch. That means: Mobility at the push of a button; it doesn't get any easier!



# Table Options



## Foot Switch

Depending on the table model, foot switches with different functions can be used.

For example, on the MO1, MLW F1, and SPL all actuators and memory positions can be programmed and accessed with the memory foot switch.

Models such as the MLW or MLK use a footswitch to control the basic functions.

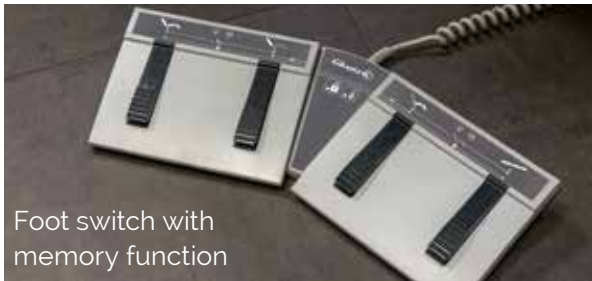

Foot switch with memory function



Foot switch for basic functions



## IR Remote Control

For table models with this symbol, a wireless infrared remote control is available. This allows the table positions to be retrieved even at a greater distance, wherein the functions correspond to the wired manual switch.



## Memory Remote Control

These tables can be optionally equipped with a memory manual switch, which allows up to four or eight individual positions to be stored. A simple manual switch to operate the basic functions is included with the equipment by default.



## Aroma Therapy

Enveloped by pleasant scents during treatment - with the Aroma Therapy option you can turn your treatment into a wellness experience for all the senses.

Depending on the table model, you can release aromas from one or three integrated fragrance chambers at the push of a button. The fragrances can be exchanged as desired.





## Multimedia

### Multimedia sound system

The sound experience for your table! The built-in audio interface offers a modern interface between many playback devices and your spa table. With the speaker integrated into the table, customers can relax to their own favorite music. At the touch of a button, you can choose between targeted playback on the head area or the entire room. Connection options: Bluetooth, SD card, USB, AUX, and iPhone.



### Audio-Relax-Headrest

Speakers integrated invisibly into the headrest guarantee a pleasantly relaxing sound experience with maximum comfort.

The supplied MP3 player is attached to the outside of the upholstery so that it is easy to use at any time. Around 50 minutes of GEMA free relaxation music have already been loaded onto it. The player can also be reloaded via USB connection.

## Gharieni Color Charts

### PU upholstery colors

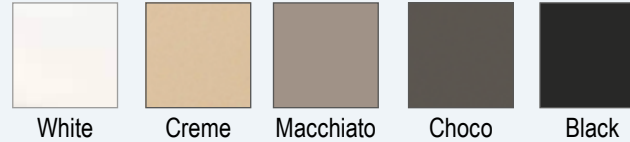

### Synthetic leather upholstery colors



## Serge Ferrari Color Charts

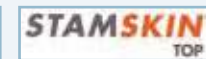

### "Stamskin Top" synthetic leather



# Wellness Concepts

Psammo Concept



Gharieni  
MLX Quartz

Wellmassage5D



Gharieni  
MLX 5D

Binaural Acoustic &  
Dynamic Stimulation



Gharieni  
MLW Welnamis

Infrared Warmth



Gharieni  
MLX i³Dome/iDome

Body Contouring



Gharieni  
Celliss

# Psammo Concept





## Gharieni MLX Quartz

Warm sand for body and soul – Psammo therapy (from the Greek psammo = sand) is a tradition going back thousands of years. Because the gentle, deeply effective warmth provides pure relaxation and stimulates metabolism and detoxifies. The Psammo concept from Gharieni offers you these advantages in an innovative design.

As a massage, treatment, and lounger, the MLX Quartz with its continuously adjustable alpha quartz sand combines all the possibilities for you. This allows poultices and many other applications to be carried out with little effort and high degree of efficiency. In addition, the sand table can combine numerous treatments and special signature treatments of high quality; And last but not least, the massage/treatment results are significantly increased by the deep warming.

Pamper your customers with this natural wellness treatment and offer a "quick getaway in the meantime..

### Features:

- Made of real wood
- Filled with alpha quartz sand
- Continuously adjustable heating system
- Intense deep relaxation through mild, long-lasting warmth
- Two lifting columns for height and inclination adjustment
- Storage compartment and two drawers in the base
- Integrated facial surface made from soft PU upholstery
- Optional, foldable upholstery overlay for massages
- Standard upholstery color: White. Other colors from our color collection for an additional charge
- Optional scent diffuser (see page page 28)
- Optional Dynamic Flow System (see page 30)
- Optionally with salt tiles inserts in the frame



- Height: approx. 65-90 cm
- Length: 216 cm
- Width: 86 cm
- Lifting capacity: 130 kg
- Load capacity of the table surface: 150 kg

### MLX Quartz

Standard wood	---
Walnut	---
Salt tiles	---

# Psammo Concept



The two lifting columns of the MLX Quartz allow for easy height and inclination adjustment, allowing you to safely and easily operate the table from any position via the desk panels integrated in the table frame and the touch display. The adjustable height of 65-90 cm allows back-friendly working; and the inclination of the MLX to the zero-gravity position offers effective possibilities, especially with massage treatments of the back and shoulder area. In addition,

this inclination adjustment of the table for your customers has a pressure-relieving effect on the head and back as well as a mobilizing effect on blood circulation.

The warm alpha quartz sand offers more than "just" a spa experience, with personalized color mixes for custom signature treatments and table looks available on request.

## Quartz Varieties

We offer you four different quartz sand fillings for the MLX Quartz:

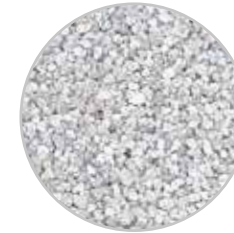

Standard



Gold

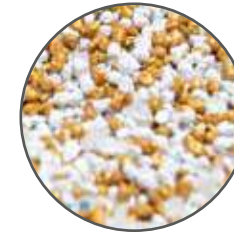

Golden Rain

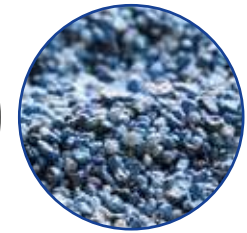

Solid Ocean

Quartz varieties, 180 kg

Standard	included.
Gold	,-,-
Golden Rain	,-,-
Solid Ocean	,-,-

## Additions

The following additions can be added to the quartz mixtures (see next page):

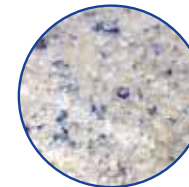

Persian Treasure



Himalayan Touch



Baltic Sunset

# Persian Treasure



Persian blue salt is among the rarest rock salts on Earth and is therefore particularly precious. The salt crystals shimmer in harmonizing, relaxing shades of blue – from delicate aquamarine to dark sapphire blue.

In addition, other beneficial effects are attributed to the "color of the sky." Blue is said to have a psychologically and physically balancing effect, both soothing and regenerating. The released ions of the salt also have a positive effect on the respiratory tract. In the blend with natural alpha quartz sand, Persian blue salt gives all treatments a particularly sophisticated and exclusive touch.

Blue salt Standard quartz	,-,-
Blue salt Golden Rain or Gold	,-,-
Blue salt Solid Ocean	,-,-

# Himalayan Touch

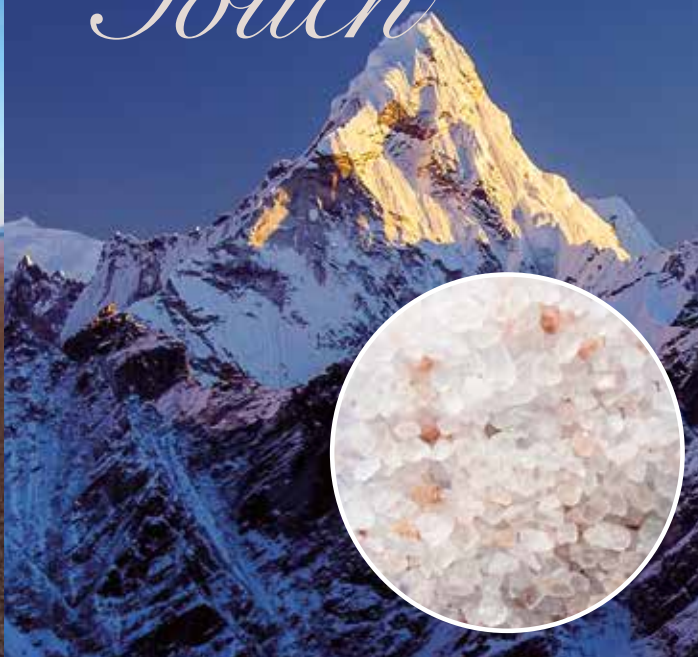

The mixture of quartz sand and Himalayan rock salt brings the soothing microclimate as we know it from mountains, coast, and forests into your treatment room! The continuously adjustable heating of the quartz salt mixture releases the ions of the salt. Once ionized in this way, the air increases respiration oxygenation and this has positive effects on the whole body as well as on the psyche. These include:

- general refreshment and vitalization
- physical relaxation and easing of tension
- spiritual calming
- metabolic stimulation
- immune system stimulation

Himalayan salt Standard quartz	,-,-
Himalayan salt Golden Rain or Gold	,-,-
Himalayan salt Solid Ocean	,-,-

# Baltic Sunset



The mix of quartz sand and high quality Baltic amber uses the soothing powers of the "Gold from the Baltic Sea." As a stone of security, trust, and "salvation," Amber is credited with the following effects:

- spiritual harmonization
- an energizing effect
- a balancing effect on the hormone balance
- an increase in the joy of life
- detoxification of the body
- anti-inflammatory effects – also on the skin
- support of the immune system

This mixture is recommended for extraordinary Signature and Thalasso treatment.

Amber Standard quartz	,-,-
Amber Golden Rain or Gold	,-,-
Amber Solid Ocean	,-,-

# Psammo Concept

## Scent Diffuser

Lying on warm quartz sand, carried away by heavenly scents into a world of comforting relaxation? That too is possible with the MLX Quartz! Because the innovative Essential Oil Function literally offers a fragrant equipment plus. The function with its three integrated fragrance chambers – like all other table extras – is easily controlled via the touch display. However, you do not have to limit yourself to just one essential oil. Thanks to the individual fragrance chambers, you can combine up to three fragrances. With these individual, ethereal fragrance compositions, your treatments will be an unforgettable experience!

Scent diffuser for aroma therapy



Easily control the essential oil feature via the integrated, intuitive touch screen.



## Salt tiles

Illuminated and heated salt tiles, which can be optionally integrated into the sides of the spa table, generate negative ions to purify the air.



Facial surface

The facial surface with face cradle is extremely practical for all treatments in prone position.



Optional upholstery overlay

With this upholstery overlay, the MLX Quartz can be turned into a "normal" massage table in no time at all. The four-piece upholstery is foldable and can be stored away to save space.



Cushions and covers

Our exclusive accessory set consists of various cushions and covers. The extensive set allows you to optimize your work perfectly.



Illuminated base

The concealed LED strip under the table surface provides a light accent in your desired color on the MLX quartz. In addition, it creates an atmospheric lighting in your workspace.

Options (more info. after page 16)

- 🖌️
**Color upholstery:**  
 PU (white or choco included in price), each color ,-,-  
 Synthetic leather standard, per color ,-,-  
 Synthetic leather Ferrari Stamskin Top, per color ,-,-
- 🔧
 Metal parts in special colors (white, titanium, or dark brown are included in the table price) ,-,-
- 📦
 Other woods and paints ,-,-
- 💡
 Spa Ambience Light: Base with LED lighting ,-,-
- 🌸
 Aroma therapy ,-,-

Accessories (see also page page 140)

- Standard upholstery cover, white (Additional color charge, see options) ,-,-
- Maxi accessory set for MLX Quartz consisting of: Sand poultice warmer, 7 sand poultices of var. sizes, storage cushions, shoulder cushions, oil massage sheets, small pelvis bowl, small heart bowl, gel ring, Dentalax neck rest, and slotted tissues for face cradle ,-,-

# Psammo Concept

Sand in Motion

## Dynamic Flow System

For special types of massages

The innovative MLX Quartz sand spa table is available with the exclusive Dynamic Flow System - for even more intensive and efficient treatments:

Air chambers integrated into the table, which are pre-programmed to fill with air and empty out, move the pleasantly warm quartz sand around. This way, even without therapists, your customers will experience a soothing back massage, which relaxes the muscles and mobilizes the body as a whole.

For a massage treatments by a therapist, the MLX Quartz and the Dynamic Flow System offer a 360°-treatment: The controlled-temperature sand warms the body, while the gentle movement from below support the massage of the practitioner from above. An extraordinary, all-round relaxation experience for your customers!

Dynamic Flow System



The Dynamic Flow System...

...shifts the sand in the area of the back in gentle, wavy movements. These have a pleasant and relaxing effect.

## Quartz Poultice

They are an excellent enhancement for treatment on the MLX Quartz. Because you can perform various heat treatments with the sand poultices in different sizes. The individual sand poultices can be found in our Medical, Feet & Care catalog.

### Quartz Poultice Warmer

Large, incl. 10 Quartz poultices  
small, incl. 10 Quartz poultices

---

---

## Quartz Poultice Warmer including 10 quartz poultices

The Gharieni quartz poultice warmers ensure a constant temperature for the quartz poultices. The heating system can be easily controlled from the front panel and an LED indicator provides information on the temperature status. The design of the real wood frames is adapted to the MLX series and is a perfect complement for your ambience. In addition, the included cover ensures efficient heat storage and can even be used as a tray for the sand poultices on the large model.

### Features:

- Table device for keeping the sand poultices warm
- Also suitable for heating hot-stones
- Made of real wood
- In two sizes
- Filled with alpha quartz sand
- Continuously adjustable heating system
- Including four large, two medium, and four small sand poultices

### Quartz Poultice Warmer, large

- Height: approx. 28,5 cm
- Length: 63,5 cm
- Width: 23,5 cm



### Quartz Poultice Warmer, small

- Height: approx. 28,5 cm
- Length: 45 cm
- Width: 23,5 cm



Filled with quartz sand

Like the MLX Quartz, the poultice warmer is also filled with alpha quartz sand. This guarantees a uniform and sustainable heat release.



No unnecessary heat loss

The practical cover panel of the device prevents heat loss inside. In addition, it can be used as a practical tray on the large sand poultice warmer.







# Mandarin Oriental, Doha Qatar



# Wellmassage5D



# Gharieni MLX Wellmassage5D

## The innovative treatment concept

Up to now, you were only familiar with massages where customers are lying flat. With WellMassage5D that's now completely different! This signature treatment was created especially for the MLX spa table.

The unique treatment concept combines high-tech & high touch to create high impact. With its innovative mix of strokes, pressure massage, sliding massage strokes, and mobilization and meridian stimulation in combination with eight programmed table positions, the WellMassage5D offers an extraordinary full-body treatment for sustained deep relaxation.

You will learn the innovative treatment concept in our Well-Massage5D training course, where the eight special table positions are also explained and saved.

## MLX Features:

- Exclusive designer table for spa and wellness
- Four actuators for electrical adjustment of height, back, leg, and foot sections
- Face cradle
- Two removable arm pads
- Trendelenburg feature
- Eight treatment positions can be saved
- Locking feature
- Soft, robust PU upholstery
- Also available in synthetic leather
- Optional soft upholstery
- PU standard upholstery color: white or choco other colors from our color collection for an additional charge
- Base in five standard decors (see page 19), optionally in other decors
- Large storage space with one folding compartment and two drawers



MLX

Wellmassage5D Edition



- Height: approx. 58-98 cm
- Length: 203 cm
- Width: 85 cm
- Upholstery width: 80 cm
- Lifting capacity: 300 kg
- Load capacity of the table surface: 350 kg

## The award-winning treatment concept

Three awards all went to WellMassage5D in 2016: We received the innovation prize from the German Wellness Association and the European Spa Association; and Spa & Wellness México honored our innovative treatment concept with its Product Award.





## Step by Step

### The WellMassage5D in eight steps

With the WellMassage5D with its eight special treatment steps, the perfect flexibility of our high-tech MLX spa table is fully utilized. With unique motion sequences and pre-set positions, MLX offers treatment options unlike any other spa table!

The combination of high tech & high touch ensures a unique spa and relaxation experience. At the same time, it offers the therapist the opportunity to work ergonomically in the best possible way, i.e. back-friendly and saving their strength.

WellMassage5D can be run as 50- and 80-minute treatments in two versions:

#### "RELAX"

The deep relaxing effect of this program lets your customers forget the stress of everyday life.

#### "DEEP"

The focus of this program version is on the additional relaxation of stress-related tense, aching muscles.



Position 1

At the beginning, the customer assumes the classic massage position to "arrive" and to tune in to the subsequent symphony of touch.



Position 2

The elevation of the back by 40° and slight angling of the legs relieves the area of the lumbar spine. At the same time, the head, neck, and shoulder girdle are relaxed. This position allows the therapist to give a gentle pressure massage.



Position 5

Lower legs and feet are elevated above chest height. This allows the foot reflex zones to be massaged.



Position 6

The legs are moved one step higher and the back is positioned a bit lower. This supports the return of the venous blood as well as the lymph from the lower extremities.



Position 3

The knees remain in the same position while the back is lowered by 10°. This allows the therapist to treat the customer's hands, arms, and shoulder blades as well as their lower back and upper torso right up to the waist in a way that rests the back.



Position 4

While the position of the back remains unchanged, the angle of the knees is increased. This shifts the weight of the thighs to the hips and relaxes the thigh muscles. It can now be treated effectively with significantly less effort.



Position 7

The elevation of the back and lower leg support prepares the customer gently for the end of the treatment and stimulates their circulation.



Position 8

The customer spends a few minutes more relaxed in a sitting position, then they can easily get up from the bed.

Options (more info. after page 16)

-  Smart-Thermo: programmable heating system with automatic shut-off ,-,-
-  Color upholstery PU: max. 2 different colors possible, per color ,-,-
-  Audio-Relax-Headrest: with integrated speakers to connect to common players ,-,-
-  Metal parts in special colors (white, titanium, or dark brown are included in the table price) ,-,-
-  Decor surfaces: our extended collection (standard collection: see page 19), ,-,-
-  Foot switch memory function: for controlling the basic functions and the memory positions ,-,-
-  IR Handheld remote control: wireless operation for controlling the table ,-,-
-  Spa Ambience Light: Base with LED lighting ,-,-

Accessories (see also page 140)

- Dentalax neck rest, PU ,-,-
- Gel cushions for the face cradle ,-,-
- Terrycloth (white, macchiato, or choco) ,-,-
- PU protective cover, Art. 49051 ,-,-

# Hôtel de Paris Saint-Tropez France





# Welnamis

Binaural Acoustic & Dynamic Stimulation







Targeted stimulation of brain waves

Healing in harmony  
with body, mind and nature

Deep relaxation  
with added value

## The exclusive sound massage system

### Anti-stress experience

Welnamis – The Binaural Acoustic & Dynamic Stimulation – combines the gentle sound waves of a special music with a highly efficient vibration massage system integrated in the table surface. While the special sounds soothe the mental activity, the vibration massage specifically affects the energy centers (chakras) of the body. Thus, this innovative sound massage system combines the effects of deep relaxation techniques with those of meditation and mindfulness practice. In this way, Welnamis offers a very exceptional and particularly effective relaxation and anti-stress experience.

### Waves make the difference

The electrical impulses of brain cells reveals whether our brain is in the waking or resting state. They can be measured as brainwaves with different frequencies in brain wave curves. Thus, our semi-sleep and our state during light meditation are both characterized by low-frequency alpha waves. Theta waves can be found during the sleep and dream phases, as well as in deep meditation. If our brain waves vibrate in the alpha or theta modes, we are in a state of deep relaxation. Delta waves on the other hand determine deep sleep. Our self-healing powers become active during this phase.

### Relaxation – better than sleeping!

The Welnamis system uses the soothing power of the slow, evenly vibrating brainwaves very specifically. The basic technology here is Quantum Harmonic Audio Therapy: Special music with binaural tones (two simultaneously very slightly different frequencies) generates gentle sound waves in time to a calm heartbeat. They stimulate the brain and put it in alpha to delta mode. This way body, mind, and soul find deep, soothing, and regenerating rest.

## Far more than relaxation!

If brain waves oscillate in the alpha to delta or theta mode, the deep inner peace it generates has an effect not only on the soul, but on the entire organism. Because as a "control center," our brain also regulates the autonomic nervous system and thus our organ functions. The positive effects:

- Heart rate and pulse rate slow down, blood pressure drops.
- Breathing becomes deeper and calmer.
- The muscles relax.
- Blood vessels dilate, which increases the blood flow.
- The production of stress hormones is reduced.
- The immune system is activated.

With the Welnamis system, all these beneficial effects can be achieved within a very short time.

## An optimal combination

If the sounds of the Welnamis put the brain into relaxation mode, the fine vibrations of the integrated vibration massage system harmonize with the body's energy centers (chakras). Thus, the Welnamis allows for rapid, unique, mental as well as physical relaxation and regeneration. As a perfect complete system it offers the ultimate way to:

- Recovery
- Refreshment
- Vitalization

## Scientists are convinced!

Clinical studies from the US confirm the effectiveness of the Quantum Harmonic Audio Therapy on which the Welnamis system is based. The scientists also found that the specific sound frequencies are suitable for a wide range of applications:

- As little as one single session can reduce everyday and work-related stress.
- Within 14 days, sleep quality and quantity improve by up to 80 percent.
- Anxieties and depressive symptoms, as well as psychological effects of trauma, are reduced by 40 to 60 percent.
- The psychological consequences of persistent pain diminish.

Soothing versatile effects

Easy to use.

Proven effectiveness

Sound & Vibration

for body, mind, and soul



The features of the Welnamis are controlled by the intuitive touch display.

Welnamis System

for MLW Amphibia and MLW (Soft)



# Upper House

Gothenburg, Sweden





Photos: © Upper House

# MLX i3Dome



# Gharieni MLX i³Dome/iDome

## Far Infrared (FIR) • Plasma • Light

The proven Gharieni MLX iDome with far-infrared technology can be enhanced with another effective feature, the Plasma Light Therapy.

The Gharieni Triple Detox Therapy „MLX i³Dome“ is the new generation of detox treatments. Combining Far Infrared technology with Plasma and Light, this spa table offers 3 ultra-effective detox treatment methods in one.

### Charge your batteries and detox

While the Gharieni FIR-technology stimulates the metabolism and the perspiration of the body with long-wave infrared rays through the MLX iDome, the additional Plasma- and Light-Therapy device (PLT) at the head section provides visible skin rejuvenation and detoxification already after the first use. Using the three therapies in such a well thought-out combination is much more effective, as all three therapies support and multiply the results of all individual treatments.

### No therapist needed

The Gharieni MLX i³Dome concept works as a stand-alone therapy, where no therapists is needed. After the client is positioned on the MLX iDome and the PLT device, no hands are necessary to support the Gharieni MLX i³Dome detox therapy.

### Features:

- Available as iDome with Gharieni FIR technology or i³Dome with FIR technology and Plasma Light Therapy (PLT)
- Dome pneumatically adjustable with 2 gas lifts
- Lying surface height adjustable and inclinable
- Also available as Static model without lying surface adjustment
- Spacious drawer
- Standard upholstery color: White. Other colors from our Stamskin color collection at extra charge
- Base in white or wenge, optional in other decors
- Including lying surface extension and neck pillow



Lying surface extension



- Table surface height:  
approx. 53-83 cm (electric version)  
53 cm (static version)
- Length: 225 cm (245 cm with extension)
- Total width: 90 cm
- Width lying surface: 70 cm
- Lifting capacity: 300 kg
- Load capacity of the table surface: 350 kg

### MLX iDome

With electric adjustment	---
Static version	---

### MLX i³Dome (incl. Plasma Light Therapy)

With electric adjustment	---
Static version	---

# MLX i3Dome

The ultimate Detox Booster

(Far)Infrared

Plasma

Light

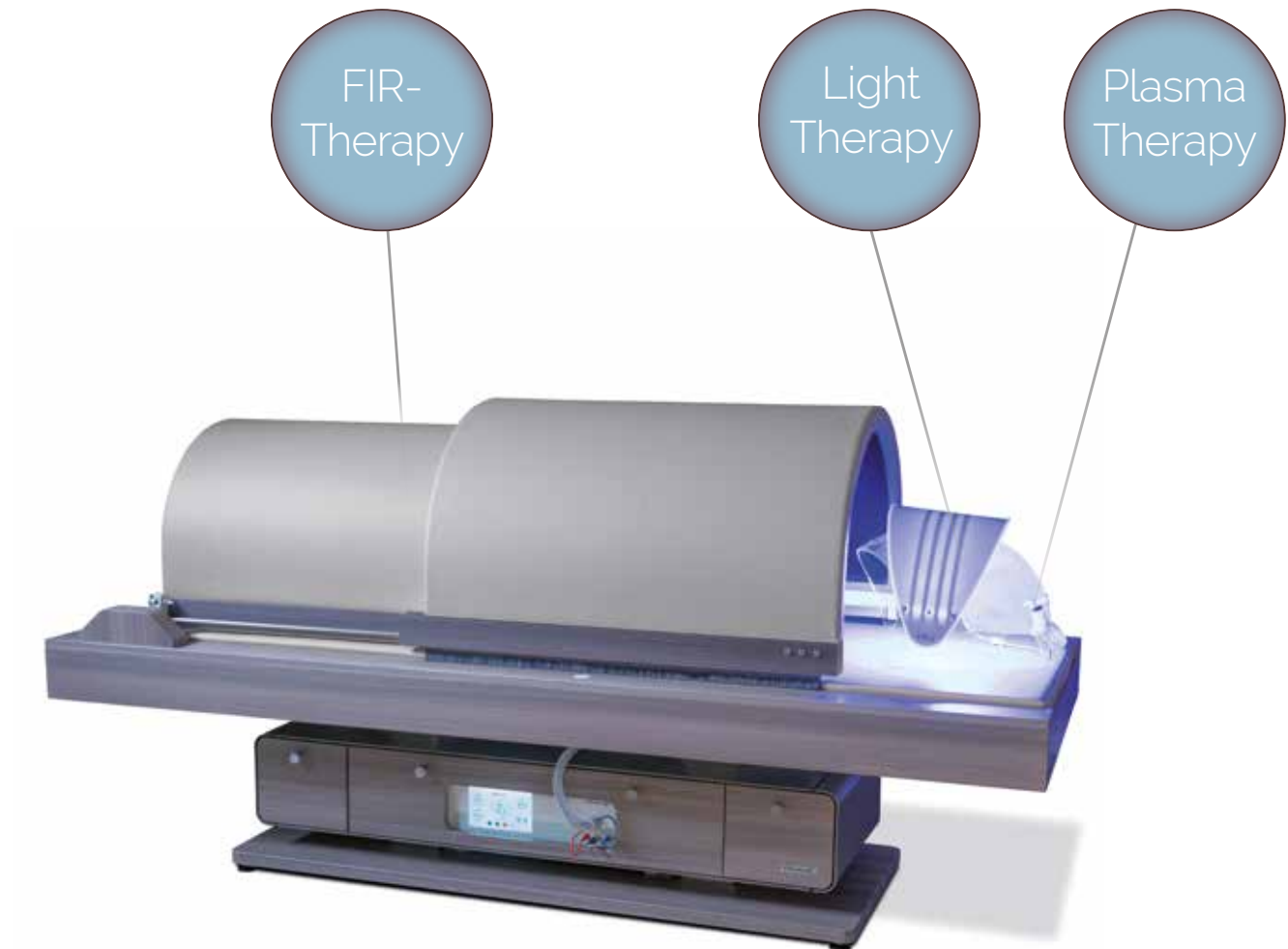



## Far Infrared-Therapy

**Gharieni FIR technology stimulates the body with far infrared rays**

Traditional infrared saunas are only one way to deliver radiation in a controlled environment and within an acceptable treatment time. With the development of better technology to deliver pure far infrared radiation (FIR), recognition of the benefits of its action has grown significantly in recent years and is now included in wellness protocols worldwide.

With the special Gharieni FIR technology of the MLX i3Dome, we bring the beneficial effects of infrared rays into a treatment couch so that your clients can enjoy the pleasant effects of this heat treatment in a small space.

- Increases energy
- Relieves inflammation, stiffness and soreness
- Stimulates metabolism
- Promotes detoxification
- Increases blood circulation
- Enhances Recovery after physical efforts



## Light Therapy

**Light therapy: scientifically proven and effective**

Light treatment has been known for a long time and has been successfully used in treatments for decades. The effect of the colored light is reinforced by the negative ions.

### Applications of red light therapy:

- Increase in collagen formation / collagen synthesis
- Skin repair & renewal (anti-aging)
- Prevents and reduces scar tissue
- Supports wound healing
- Stimulates ATP in cells and increases cellular reproduction

### Applications of green light therapy:

- Detoxification
- Antibacterial properties
- Relieves stress
- Strengthens immune system
- Builds muscle and bone
- As aphrodisiac and sexual tonic

### Applications of blue light therapy:

- Eczema / psoriasis
- Acne
- Antiseptic and antibacterial
- Anti-inflammatory and astringent effects
- Anti sebum production
- Relieves anxiety
- Strengthens the immune system



## Plasma Therapy

**Plasma for problem skin, anti-aging and revitalization**

Plasma Therapy is an innovative method for cosmetic treatments. During the application, clients are exposed to the energy of oxygen (O2) in the form of applied electrically negatively charged ions.

Benefits include:

- Visible skin rejuvenation already after a few applications
- Maintenance of skin health
- Visible improvement of problem skin
- Increase of vitality & suppleness
- Positive support of the metabolism in the entire organism

Based on findings of quantum physics, Plasma Therapy are the negative ions collected from the ambient air and then directed into the specially coated PLT device where it combines with Light therapy. Ions penetrate through the skin to stimulate cell metabolism while there is simultaneous inhalation through mouth and nose thereby providing positive benefits for the whole body including organs and muscles..



# MLX i3Dome

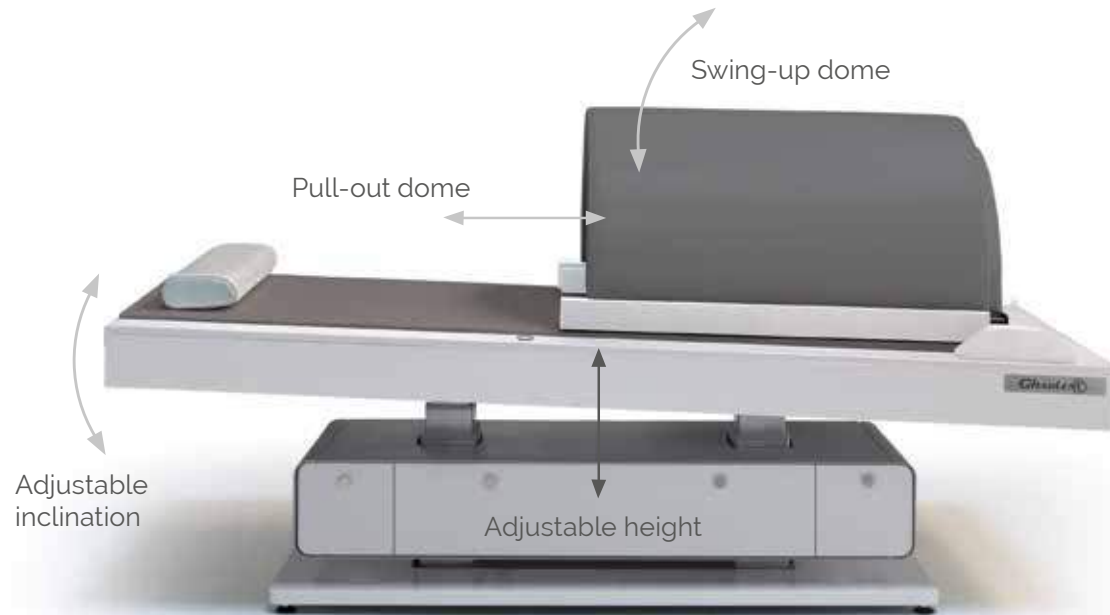

The MLX Dôme has numerous features. By means of its height adjustment, a low entry height of about 57 cm can be achieved along with a maximum working height of 97 cm.

For easy access, the dome can be opened and pushed together manually.





### Extension of the lying surface





With the included, removable upholstery extension, the lying surface can be extended by 20 cm. Thus, a relaxed lying position is also possible for tall customers.



### Neck cushion included

To increase ergonomics, the MLX iDome is equipped with a separate lying neck support in addition to a pleasantly soft padded lying surface and thus offers the best lying comfort.

### Options

- 
 Color upholstery dome (Ferrari Stamskin)  
 White included in the price of the table ,-,-
- 
 Metal parts in special color  
 (anodized, white, titanium or dark brown are included in the price of the table) ,-,-
- 
 Decor surfaces our extended collection (standard collection: see page 19), ,-,-
- 
 Spa Ambience Light: Base with LED lighting ,-,-



### Tension strap for towels

To increase the effect of the IR sauna, a towel can be attached at the open side with a strap. This will keep even more heat inside the dome..



### Storage space

On the Gharieni MLX iDome (without PLT unit), two drawers and a spacious storage compartment in the base provide plenty of space for towels, work utensils and much more.

### Accessories

- Cover cloth for dome opening  
 Art.45860WE, 1 pc. ,-,-
- Art.45860WE-10, 10 pcs.
- Cover cloth for lying surface  
 Art.45861WE, 1 pc. ,-,-
- Art.45861WE-10, 10 pcs.

# The Johnstown Estate Meath, Ireland





Photos: © The Johnstown Estate



# Celliss



## Gharieni Celliss

In cooperation with our partner DMS Group, proven experts in the medical diagnostic imaging field, we are pleased to present "CELLISS", an innovative body contouring device that doesn't even need a therapist to treat Cellulite and help to reduce weight.

This completely unique slimming machine relies on the patented "Total Slimming System" (T.S.S.) technology, a non-invasive aspiration/percussion process that simultaneously treats thighs and hips as well as buttocks or abdominals (depending on the client's position).

Gharieni CELLISS is a powerful tool designed to satisfy all your requirements. Via the intuitive touch screen interface, the treatment program can be personalized. Protocols can be accessed with one quick touch, and once the treatment is launched, it does not require any intervention. The integrated protocols were developed by health/ beauty/sport professionals and allow operators to adjust the Cellumassage according to the selected treatments and the client's profile. Easy to use, this high technology device is remarkably efficient.

### Features:

- efficient anti-cellulite treatment
- simultaneous treatment of different zones
- customizable treatments
- fully automated
- non-invasive
- simple operation



Celliss  
Total Slimming System



- Height: 61-97 cm
- Length: 200 cm
- Width: S 76 cm / M 85 cm / L 92 cm
- Lifting capacity: 300 kg
- Load capacity of the table surface: 350 kg

# Celliss

## Technology

The Cellumassage method, featured on the CELLISS, provides the ONLY solution capable of treating a significant surface of the body, simultaneously. The adjustable and adaptable aspiration/ percussion cycle, with variable intensities and speeds, massages the skin and muscles in three dimensions. The Gharieni CELLISS optimizes treatment goals through the complete, "whole" approach of its treatment programs. Stimulating and treating such a large zone at the same time makes the overall effect of the treatment more efficient.

Orange-peel is reduced, skin radiance and firmness are improved, the silhouette is reshaped and thighs, abdominals and buttocks are toned.

### How does it work?

- The aspiration stretches and moves skin giving a 'lightness' sensation.
- The percussion triggers a mechanical shockwave and compresses fat, while stimulating the body's natural detoxification process.
- The combination aspiration/percussion over such a large surface at the same time optimizes the treatment's effects.







One-touch technology

Using the intuitive touchscreen interface of the CELLISS, the treatment programs can be personalized for each customer and called up and started with a quick press of a button.



Total Slimming System (TSS)

The TSS is the DNA of the Gharieni Celliss. 96 nozzles take action on the adipose and muscular tissues of the buttocks, abdominals or hips with a series of noninvasive aspiration/percussion movements



Efficient anti-cellulite treatment

Cellumassage method reduces subcutaneous fat and improves the appearance of the skin. It also optimizes the flow in the vascular and lymphatic system.



Fully automated treatment

Once started, the preset treatment program runs fully automatically.



# HydroSpa



Gharieni  
PediSpa Square



Gharieni  
PediSpa Compact



Gharieni  
PediSpa Curve



Gharieni  
Hair Swing



Gharieni  
Libra Edge



Gharieni  
MLR Wet

# PediSpa Square



## Gharieni PediSpa Square

More than a foot spa! Whether pedicure, manicure, cosmetics, makeup, or hair care: the PediSpa Square offers a wide range of treatment options thus making it a real all-rounder! Highest demands on functionality, quality, and design make this model with its base made of high-end Corian® the ultimate premium treatment unit.

The following equipment versions are available from the PediSpa:

### PediSpa Square Basic

- Manual or mechanical water control via Symetrics handles or controls
- Pouring tube

### PediSpa Square Comfort

- Electronic water control via SMART TOOLS
- Pouring tube

### PediSpa Square Superior

- Electronic water control via SMART TOOLS
- Pouring tube
- Automatic filling via the pouring tube
- SPA programs: Vitalize & Relax

### PediSpa Square Deluxe

- Electronic water control via SMART TOOLS
- Pouring tube
- Automatic filling via the Water Fall with Pearlstream
- SPA programs: Vitalize & Relax

### Features:

- Base made from high-quality Corian®
- Height-adjustable footrest
- Comfortable seat with many adjustment options
- Two possible headrest versions: removable (option) **or** inclinable (standard, included in the price)
- Seat upholstery in two strengths
- Upholstery made from synthetic leather
- Standard upholstery color: White. Other colors from our color collection for an additional charge
- Two armrests selectable
- Optional: higher armrests with integrated tray

### PediSpa Square

Basic	7,--
Comfort	7,--
Superior	7,--
Deluxe	7,--

Armrests (pair) with folding tray	7,--
Removable headrest	7,--
Pipeless Massage Funktion	7,--



- Seat height: approx. 63-99 cm
- Base length: approx. 142 cm
- Width: max. approx. 76 cm
- Lifting capacity: 130 kg
- Load capacity of the table surface: 150 kg

# PediSpa Square

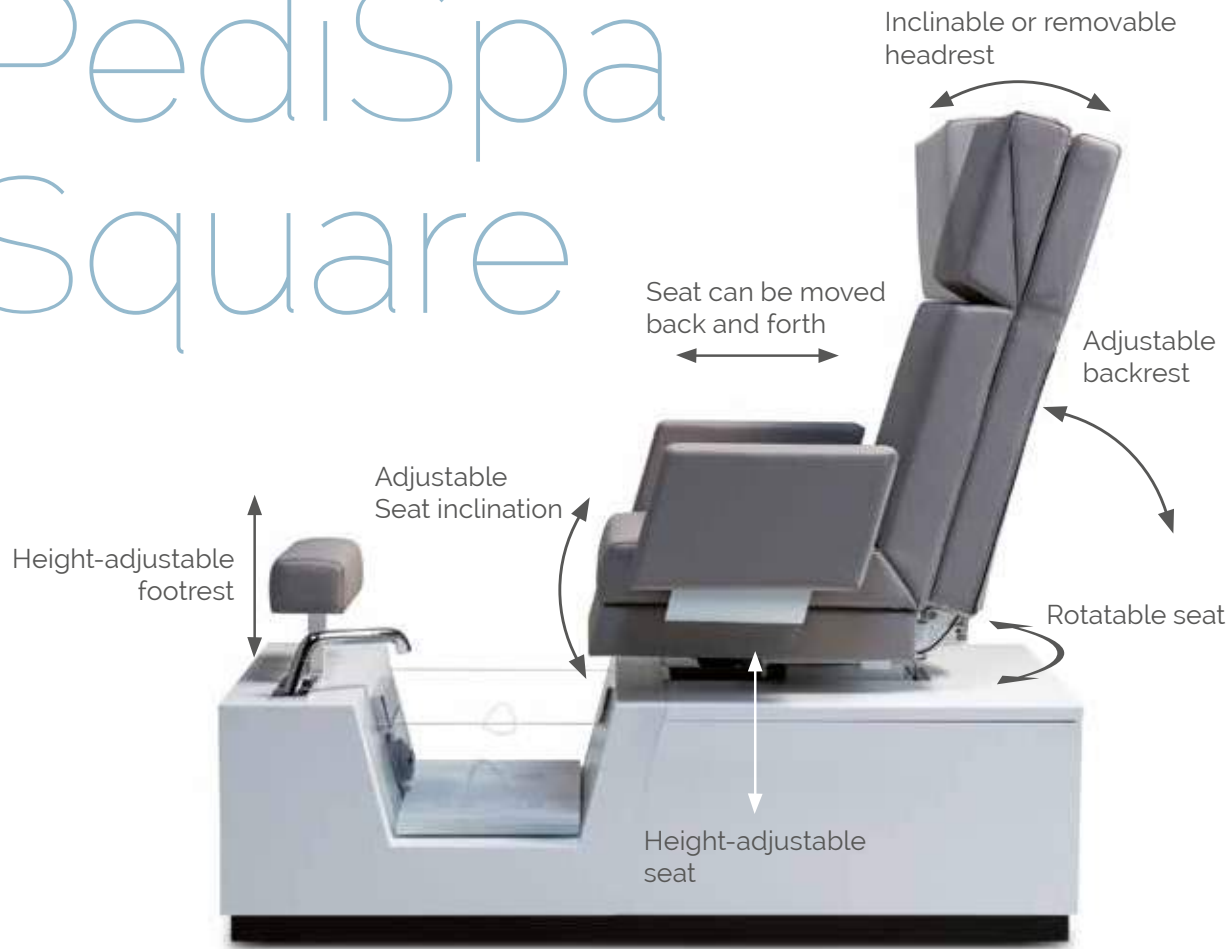

## Extremely flexible

The PediSpa Square has a variety of adjustment options that make a treatment comfortable:

In addition to the headrest which swivels forward by 25°, the backrest can be tilted back by up to 75°. The seat is electrically height adjustable from 63-99 cm, tiltable by 14°, and

can be moved 17 cm forward and backward. The footrest can also be easily adjusted at the touch of a button by up to 21 cm in height. The swivel function of the seat ensures easy access – 90° to both the left and right.

# 5 in 1

PEDICURE  
MANICURE  
FACIAL  
HAIR CARE  
MAKEUP



Pedicure

A rotatable seat, the adjustable seat distance to the foot basin, a height-adjustable footrest, and easy-to-use fittings – this is foot care in a class of its own.

1



Manicure bowl + folding tray

Practical options for manicure: The fold-out trays integrated into the armrests, as well as the flexible manicure bowl, make hand and nail care on PediSpa Square child's play.

2



Cosmetics

The backrest, which can be tilted by up to 75°, enables a low reclining position for the customer – perfect for cosmetic treatments.

3



Hair care

Care from head to toes! Together with the Hair Swing basin, the Pedispa Square with removable headrest also makes hair care easy.

4



Makeup

Simply put the seat in a lateral position, remove the headrest (option!), and move the chair to the appropriate height – Ready for makeup!

5



### Membrane panel

The membrane control panel, which is set into the Corian® at the front of the table base, allows for particularly easy handling of the treatment chair.



### Removable headrest

The PediSpa Square is also available with a removable headrest. This equipment version is recommended for all hair treatments.

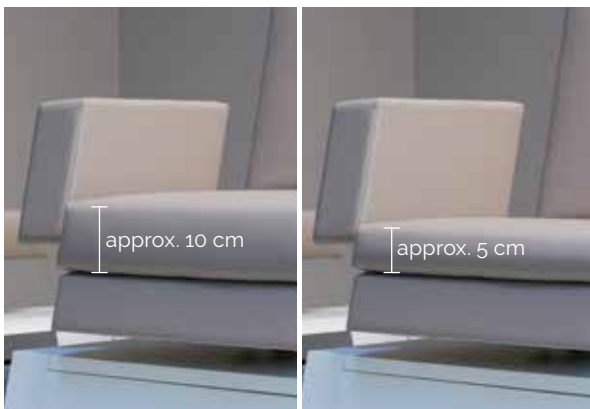

### Exchangeable seat upholstery

The optional Comfort upholstery (pictured left) is made of durable, hygienic PU and is very soft. This allows customers to enjoy their treatments even more relaxed.



### Corian® versions

The precious mineral material Corian® fulfills all color and structure wishes. Thus, the base of the PediSpa Square can be visually adapted to any interior and ambience.

### Options (more info. after page 16)



Color upholstery: max. 2 different colors possible  
Synthetic leather standard, per color

,-,-  
,-,-



Corian® surfaces our collection,  
(White is included in the table price)

,-,-

### Accessories

Neck cushion, white

,-,-

Neck cushion, in colors

,-,-



# DORN BRACHT

## Equipment Versions

SPA programs: Vitalize & Relax  
for PediSpa SUPERIOR and DELUXE.

The FOOT BATH<sup>ATT</sup> from Dornbracht combines different spray modes, comfort functions, and pre-programmed scenarios. Each of their effects remains noticeable long after use.

There are two scenarios to choose from in the FOOT BATH<sup>ATT</sup>:



FOOT BATH<sup>ATT</sup> scenario 1: VITALIZE

This program refreshes, invigorates, and gives new energy. Four nozzles massage the reflex zones on the soles of the feet with increasing pressure intensity and changing temperatures.



FOOT BATH<sup>ATT</sup> scenario 2: RELAX

This scenario stimulates, relaxes, and warms. After the feet are immersed in the warm, shallow water, the temperature and water levels rise slowly, until the customer leaves the foot bath after 10 minutes.

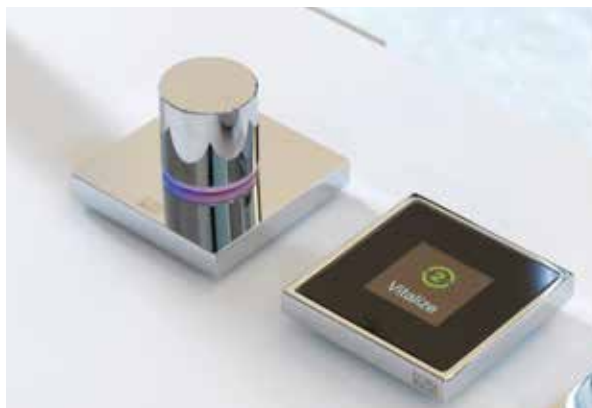

### SMART TOOLS

Operating the FOOT BATH<sup>ATT</sup> is simple and easy via the digital SMART TOOLS.

For PediSpa COMFORT, SUPERIOR, and DELUXE.



### Pouring Tube

The pull-out pouring tube allows for refreshing, individual Kneipp pours.

For all four PediSpa versions.



### Water Fall Filling

The pool is automatically filled with fresh sparkling water via the Water Fall with Pearlstream.

For PediSpa DELUXE.

# PediSpa Compact



## Gharieni PediSpa Compact

With our PediSpa models, you can not only work perfectly professionally, but the foot bath also becomes a special wellness experience. Because these treatment tables offer exceptionally comfortable seating. The space saver among the PediSpas is the PediSpa Compact, which is permanently installed on the floor and has an integrated water inlet and outlet as well as a pull-out hand shower. Its basin is covered by the frame as soon as the seat is pushed forward. In addition, the little step on the front can be pulled out. Featuring a non-slip surface, customers can comfortably and safely be seated and also "descend" back down again. In addition, the PediSpa Compact is available with two armrests: standard with low armrests or optionally with high armrests, each of which can be equipped with an integrated folding tray.

### Features:

- Two-part base
- Seating area completely movable to the rear
- Foot basin made of high quality Corian® securely installed on the floor
- When the seat is pushed forward, the basin is covered by the frame
- Compact construction
- Adjustable backrest
- Two possible headrest versions: removable (option) **or** inclinable (standard, included in the price)
- Height-adjustable footrest
- Upholstery made from synthetic leather
- Standard upholstery color: White. Other colors from our color collection for an additional charge
- Basin with pull-out hand shower, integrated water inlet, and drain
- Optionally with Pipeless Massage
- If there is no connection to the ground, the installation of a drainage pump is possible
- Optionally with a folding tray integrated in the armrest
- Retractable, non-slip step on the front



- Base length (retracted): approx. 80 cm
- Base length (retracted): approx. 150 cm
- Overall width including armrests: approx. 86 cm
- Base width: approx. 80 cm



### PediSpa Compact

Standard	,-
Armrests (pair) with folding tray	,-
Removable headrest	,-
Drainage pump	,-
Pipeless Massage Funktion	,-

# PediSpa Compact



Practical in every respect

With this PediSpa, the base and seat can be pushed over the foot basin to save space. The pull-out step makes it easy for customers to take their seats and descend again; and the headrest, which can be tilted forwards by 25°, offers perfect sitting comfort.

The footrest, which can be adjusted up to 21 cm in height, allows for ergonomic working during pedicures. Thanks to the backrest, which can be tilted backwards by up to 75°, the PediSpa Compact is also perfect for use with cosmetic treatments.





### Space-saving construction

This foot bath does not take up much space, because by simply moving the seat forward it is covered by the table base. In addition, a pull-out step is integrated into its front.



### Removable headrest

The PediSpa Compact is also available with a inclinable headrest, in addition to a removable/retractable headrest. This equipment version is recommended for all hair treatments.



### Manicure bowl + folding tray

Optionally available: The fold-out trays integrated into the armrests, as well as the flexible manicure bowl, make hand and nail care on PediSpa Compact child's play.

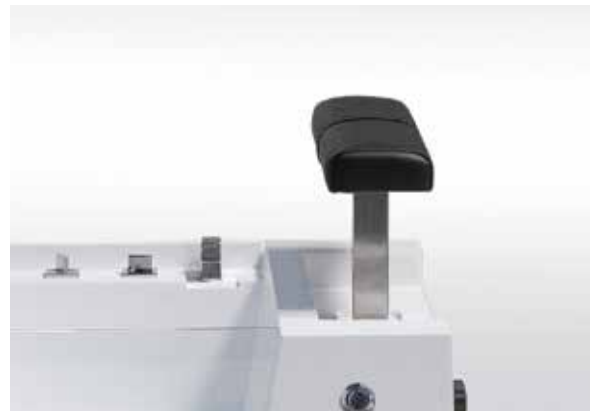

### Height-adjustable footrest

Simply manually adjust the footrest to the desired height and you'll be working ergonomically in no time!

### Options (more info. after page 16)



- Color upholstery: max. 2 different colors possible
- Synthetic leather standard, per color
- Synthetic leather Ferrari Stamskin Top, per color

;-;

;-;

### Accessories

Neck cushion, white

;-;

Neck cushion, in colors

;-;

# PediSpa Curve



## Gharieni PediSpa Curve

This PediSpa model features an impressive dynamic and elegant design, as well as high-quality workmanship. The height-adjustable foot section and the tiltable and removable head section are easy to handle and also make work easier. Made from the best materials, the PediSpa Curve is a real highlight for every spa, whether in the Basic or Comfort equipment version. With optional extras such as heated seats, pipeless foot massage, as well as auto-filling, the PediSpa Curve Comfort meets your customers' highest demands for exceptional treatments.

### Features:

#### PediSpa Curve Basic

- Base partly made from high-quality Corian®
- Compact construction
- Height-adjustable footrest
- Adjustable backrest
- Headrest inclinable and removable
- Fold-out armrests removable
- Upholstery made from synthetic leather
- Optionally with heating
- Standard upholstery color: White. Other colors from our color collection for an additional charge
- With hand shower

#### PediSpa Curve Comfort

- Details like Basic
- Pipeless foot massage
- Auto-filling



- Base length: approx. 120 cm
- Width including armrests: approx. 80 cm
- Base width: 70 cm

#### PediSpa Curve

Basic	---
Comfort	---

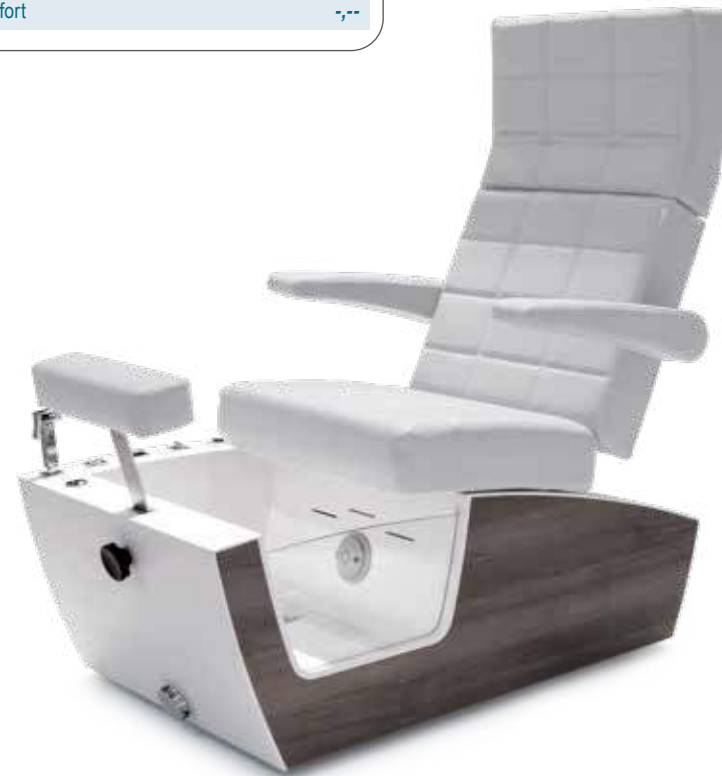

# PediSpa Curve



Set-up on request

The seat, which can be moved forwards and backwards a total of approx. 17 cm and the forward-inclinable head section, ensure perfect seating comfort. In addition, the head section can also be removed. This way the PediSpa Curve is

perfect for use with all hair treatments. The armrests swivel to the rear and can also be removed; The backrest can be tilted back by up to 75° – ideal for cosmetic treatments.







### Easy-to-use fittings

The elegantly designed fittings make it easy to regulate the water temperature and divert the flow of water to the shower head.



### High-end wood decor

For an extraordinarily elegant look: Choose the side panel of the base in one of our numerous fine wood decors.



### Footrest height-adjustable

The footrest is manually height-adjustable. This puts your customers' feet at the appropriate working height for perfect ergonomic sitting during the pedicure.



### Removable head section

The head section of the PediSpa Curve can be both tilted and removed. Thus this table is also well equipped for hair care.

### Options (more info. after page 16)

-  Color upholstery: max. 2 different colors possible
- Synthetic leather standard, per color
- Synthetic leather Ferrari Stamskin Top, per color
-  Side decor surfaces our collection, (white is included with the table price)

### Accessories

- Neck cushion, white
- Neck cushion, in colors



# W Amman Jordan



Photos: © W Amman

# Hair Swing

## Washing System Hair Swing

The Hair Swing washing system is a real highlight for all hair care applications. With three articulated elements, the Hair Swing has a particularly wide radius of 120 centimeters. This allows convenient operation of two stations next to each other. The porcelain basin also offers optimal comfort with its tilting mechanism: If the washing system is not in use, it takes up little space thanks to its swivel arm supported by three bearings.

### Features:

- Porcelain basin with tilting mechanism for hair washing
- Completely 360° rotatable
- Single-handle faucet row with ceramic sealing
- Hand shower with hose lead-through and shower hose in black, 100/140 cm long
- Foot color: White aluminum
- Basin color: White or black



### Hair Swing

White  
Black



- Maximum reach 120 cm
- High basins: 94-100 cm depending on the tilt angle



Practical hand shower

The modern, flexible hand shower with its long hose and the practical single-hand faucet allows for optimal hair care..



Flexible articulated arm

After use, the Hair Swing basin can easily be swung aside. This way you have sufficient space for your other treatments.



# Libra Edge



# Gharieni Libra Edge

This table made of stone-like, yet skin-friendly Corian® is ideal for all wet applications. Because the edge of the heated table surface and the integrated 4-point drain let the water run off even in inclined table position.

The Libra Edge Wet Table is the perfect treatment table for wet treatments, while the Libra Edge with horizontal shower guarantees an exceptional showering experience while lying down. The shower arm can be equipped with two different technologies:

1. With standard shower heads that supply water evenly and continuously. Thus the front table area and the rear area can be controlled independently.
2. With Kohler® technology: These ensure a kind of special water choreography through a temporary, pre-programmed start and stop.

Many functions can also be accessed via an intuitive touch screen display.

## Features:

### Libra Edge Wet Table

- Base made from Corian®
- Table surface with air/water cushion
- Electrical height and inclination adjustment
- Integrated 4-point water drain for optimum drainage, even in an inclined position
- Optional: Heating system for table surface
- Splash guard to protect the face
- Optional: integrated steam sauna with attachable steam cover

### Libra Edge with horizontal shower

- Features such as Libra Edge Wet Table
- Shower arm in three versions: with standard shower heads, with Kohler® technology,
- Intuitive operation via touch screen display
- Splash guard to protect the face
- Optional: LED chromotherapy system
- Optional: Aroma capsule system for hand shower
- Optional: Kohler® Music Soundsystem
- Optional: Integrated steam sauna with steam cover

### Libra Edge

With standard horizontal shower

---

With Kohler® technology

---



### Libra Edge Wet Table

Without horizontal shower

---



- Table surface height: approx. 63-100 cm
- Height including arm: approx. 190 cm
- Table surface length: approx. 203 cm
- Length including arm: approx. 236 cm
- Width: approx. 85 cm max.
- (Recommended) lifting capacity: 300 kg
- Load capacity of the table surface: 350 kg

# Libra Edge

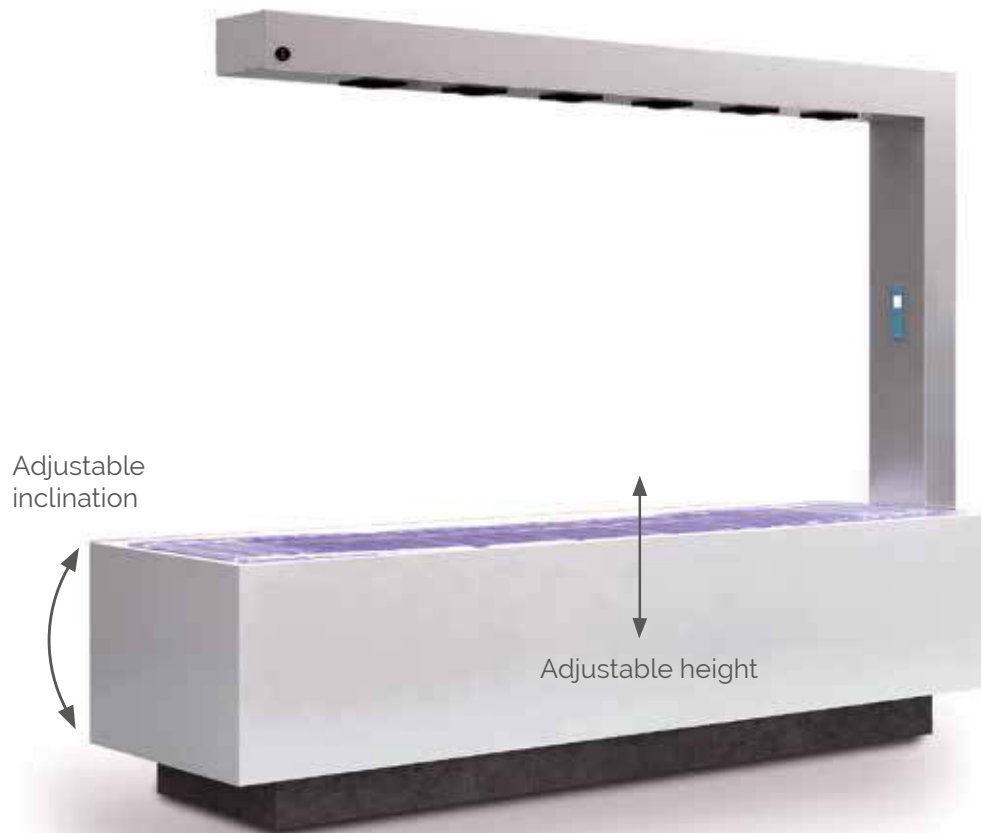

Steam sauna

With the attachable steam cover and steam nozzles integrated into the table surface, the Libra Edge can quickly and easily turn into a steam sauna.



Water or air cushion

The water or air inflatable table cushions offer your customers perfect lying comfort, a relaxing waterbed feeling, and the relaxing sensation of floating on clouds.





Face Shield

We offer the Face Shield for those for whom splashing on the face is uncomfortable. In the lying position, it effectively protects the customer's face from unwanted contact with water.



Music and sound system

The optional Kohler® sound system waterproof speakers integrated into the shower arm provide relaxing sounds during treatments.

Special options

- Heating system for table surface ,--
- Integrated steam sauna with attachable steam cover ,--
- LED chromotherapy system ,--
- Kohler® Music Soundsystem ,--
- Hand shower with aroma capsule system ,--



Aroma capsules

The optional aroma capsule system at the outlet of the hand shower completes the relaxing water experience perfectly: Just insert the aroma capsule and the soothing aromatic water starts flowing.



LED lighting

The integrated LED lighting bathes the table surface and base with a changing color gradient or individually selectable shade in atmospheric light. This can also be used for chromotherapy.

Accessories

- Face Shield replacement membranes, 6 piece ,--
- Aroma capsules, 10-pack with one variety, 8 different scents to choose ,--



# The Lamp Hotel Norrköping, Sweden





Photos: ©The Lamp Hotel

# MLR Wet



## Gharieni MLR Wet

Be it spa treatments in the open air or wet treatments indoors at your spa – with its waterproof coating and the water-resistant materials of the base, the MLR Wet meets exactly these requirements. The purist-elegant spa table offers many electrical adjustment options, such as height, inclination, and back and foot sections. In addition, the MLR Wet is equipped with a Trendelenburg feature and optionally with a locking feature. The upholstery has a face cradle for comfortable prone body treatments.

**Important note: for wet and outdoor use, the supplied waterproof cover is required!**

### Features:

- Exclusive wet/outdoor table
- Table surface with electrical height, back, leg section, and inclination adjustment
- Including removable, waterproof cover for wet treatments
- Two removable batteries for independent power supply
- Standard upholstery color:  
Synthetic leather: White. PU: White and Choco  
Other colors from our color collection for an additional charge



- Height: approx. 57-87 cm
- Length: approx. 203 cm
- Width: max. approx. 80 cm
- Lifting capacity: 300 kg
- Load capacity of the table surface: 350 kg

### MLR Wet

Including 2 waterproof covers

,-,-



MLR Wet with  
waterproof cover

# MLR Wet



For indoor & outdoor treatments

With its two lifting columns, the MLR Wet can be set at a height of 57-97 cm and the inclination angle of the table surface can be adjusted to +/- 15° to the Trendelenburg position. Also electrically, the back and leg area can be angled at

70° or 25°. Thus, the MLR Wet offers optimal table and working comfort for all wet indoor treatments or outdoor spa treatments.



Waterproof materials

Made with waterproof materials and a removable, waterproof cover, the MLR Wet is the ideal choice for both wet and outdoor treatments.



Trendelenburg position

This zero-gravity table position with low head and elevated foot section allows customers to relax in comfort.



Battery operation

Thanks to the battery integrated into the table, the MLR Wet can also be operated electrically independent of the power supply. It is removable and can easily be exchanged for a supplied second battery.



Waterproof cover

The water-resistant PU cover is skin-friendly, hygienic, tough, and essential for all wet treatments. The cover is available in white or choco..

Options (more info. after page 16)

- 🖌️
 Color upholstery:
  - PU, each color ,--
  - Synthetic leather standard, per color ,--
  - Synthetic leather Ferrari Stamskin Top, per color ,--
- 🔩
 Metal parts in special colors (white, titanium, or dark brown are included in the table price) ,--

Accessories (see also page 140)

- Waterproof replacement cover ,--
- Replacement battery ,--
- Dentalax neck rest, ,--
- Gel cushions for the face cradle ,--
- Terrycloth cover ,--
- Foot protective cover, PVC, transparent ,--

# Spa Tables



Gharieni  
MLX Limber series



Gharieni  
MLX series



Gharieni  
MLR series





Gharieni  
E-Line series



Gharieni  
MO1 series



Gharieni  
MLW F1 series



Gharieni  
MLW Neo series

# MLX Limber series



## Gharieni MLX Limber

With its numerous adjustment options, the MLX Limber enables unique flexibility – for a new dimension in your treatments.

Four different model versions, each available with or without storage space, provide the optimal tool for every need. In the "Flex" top model, the arm supports can be lowered at both ends, which makes the table usable on all sides. The oval-shaped table surface and the extremely narrow base allow for better access to the head/neck and leg areas. Up to six actuators allow extreme positions and thus make the Limber a multifunctional table with unmatched flexibility. The optional storage space in the table base allows for the practical storage of work instruments and equipment such as two medium-sized Hot Cabis.

### Features:

- Available in four table surface versions
- Depending on the version, height, inclination, head, back, leg, and/or foot section are electrically adjustable
- Up to eight pre-stored positions can be called up at the push of a button
- Lowerable arm supports
- Arm supports swivel horizontally
- Inclined head section(s) with face cradle
- Trendelenburg feature
- Locking feature
- With PU comfort upholstery in two thicknesses or synthetic leather upholstery
- Standard upholstery color:  
Synthetic leather: White. PU: White and Choco  
Other colors from our color collection for an additional charge
- Base in white or wenge, optional in other decors
- Doors made of Corian®
- Depending on the model with generous storage space in the base, for example for up to two medium-sized Hot Cabiss



- Height: approx. 63-100 cm
- Length: approx. 203 cm
- Width: max. approx. 85 cm
- Lifting capacity: 300 kg
- Load capacity of the table surface: 350 kg



### MLX Limber

MLX Limber Classic	7,--
MLX Limber Pro	7,--
MLX Limber Flex	7,--
MLX Limber Podo	7,--

### MLX Limber without storage compartment

MLX Limber Classic	7,--
MLX Limber Pro	7,--
MLX Limber Flex	7,--
MLX Limber Podo	7,--



MLX Limber with soft upholstery

# MLX Limber series



## Gharieni Limber Flex

For ultimate maneuverability, the Limber Flex is equipped with lowerable, swiveling arm supports on both the head and foot sides, as well as an inclinable head section with face

cradle. This makes it possible to use this table model from both sides, and completely new treatment positions can be set for a spa table. – Limber Flex: Treatments without limits!





## Gharieni Limber Pro

Thanks to its lowerable arm supports and inclinable head section with face cradle, the Limber Pro is also suitable for treatments in prone position. The fold-down foot section

provides relief for the feet. In addition, it also allows foot treatments.



# MLX Limber series



## Gharieni Limber Podopdo

The Limber Podopdo is extremely versatile. In addition to the complete functions of a high-class spa table, the Podopdo version offers laterally swiveling and lowerable footrests. These

allow, in addition to classic foot treatments, the use of our matching mobile PediSpa tub. This way your customers are well taken care of!









PediSpa Mobile

Footspa on castors



## Options (more info. after page 16)

	Soft Upholstery	,-,-
	Smart-Thermo: programmable heating system with automatic shut-off	,-,-
	Color upholstery: PU (white or choco included in price), each color Synthetic leather standard, per color Synthetic leather Ferrari Stamskin Top, per color	,-,- ,-,- ,-,-
	Metal parts in special colors (white, titanium, or dark brown are included in the table price)	,-,-
	Decor surfaces our extended collection (standard collection: see page 19),	,-,-
	Foot switch memory function: for controlling the basic functions and the memory positions	,-,-



## Gharieni Limber Classic

This version is equipped with two lowerable arm supports, a tiltable head section with face cradle, and a full-length table surface. For classic facial and spa treatment.

## Accessories (see also page 140)

Back/arm upholstery for Limber Podo	,-,-
Dentalax neck rest, synthetic leather	,-,-
Dentalax neck rest, PU	,-,-
Gel cushions for the face cradle	,-,-
Terrycloth (white, macchiato, or choco)	,-,-
Foot protective cover, PVC, transparent	,-,-
PU protective cover, Art. 49051	,-,-



Bergamos Spa Retreat  
Friendswood, Texas, USA





# MLX



## Gharieni MLX

Our exclusive designer table for spa and wellness. Despite the customer-friendly low step height of 57 cm, the table base offers practical storage space. The removable arm supports and covers, for example, and other table accessories can be stowed within reach here.

Four actuators allow for optimal adjustment options, of which up to eight can be stored as memory positions. Removable arm supports and fold-down frame in the head area make the MLX a perfect work tool for professionals. For individual requests, the features of the MLX as well as its "look" can also be customized.

### Features:

- Large storage space
- Two removable arm pads
- Face cradle
- Four actuators for electrical adjustment of height, back, leg, and foot sections
- Trendelenburg feature
- Eight treatment positions can be saved
- Locking feature
- Soft, robust PU upholstery
- Also available in synthetic leather
- Optional: Soft upholstery
- Standard upholstery color:  
Synthetic leather: White. PU: White and Choco  
Other colors from our color collection for an additional charge
- Base in five standard decors (see page 19), optional in other decors
- Base with two small drawers and a folding compartment
- Frame in the head area folds away, for a better accessibility of face and décolleté



- Height: approx. 58-98 cm
- Length: 203 cm
- Width: 80 cm
- Lifting capacity: 300 kg
- Load capacity of the table surface: 350 kg



MLX

4-actuator



# MLX



### Exclusive, practical, & comfortable

This exclusively-designed spa table can be optimally adjusted electrically via four actuators. Thus, not only is a customer-friendly step height of 57 cm possible, but also the adjustability of the backrest by approx. 70°, the leg area by about 23°, and the inclination angle of the table surface by

about +/- 15°. Eight storable memory positions also allow the Wellmassage5D, which is specially-designed for the MLX. Thus, customers experience an innovative, extraordinary massage experience and therapists are able to work effortlessly and in a back-friendly fashion.



### Trendelenburg feature

In this zero-gravity table position, the head section is particularly low and the foot section is raised. This allows customers to relax very deeply.



### Spa table with large storage space

The MLX is equipped with a spacious storage space in its base. It consists of a combination of two drawers and a large folding compartment.



### Removable arm support upholstery



Simply remove the upholstery of the arm supports at the height of the head section and fold the frame down – your customer will then be able to lay down their arms comfortably during all prone treatments.



### Available as a Wellmassage5D special edition

With eight pre-set table positions and special treatment steps, high tech & high touch come together to form a treatment for exceptional deep relaxation (page 34).

### Options (more info. after page 16)

-  Soft Upholstery ,--
-  Smart-Thermo: programmable heating system with automatic shut-off ,--
-  Color upholstery:  
PU (white or choco included in price), each color ,--
-  Multimedia sound system  
Audio-Relax-Headrest ,--
-  Metal parts in special colors (white, titanium, or dark brown are included in the table price) ,--
-  Decor surfaces: our extended collection (standard collection: see page 19), ,--
-  Foot switch memory function: for controlling the basic functions and the memory positions ,--
-  IR Handheld remote control: wireless operation for controlling the table ,--
-  Spa Ambience Light: Base with LED lighting ,--

### Accessories (see also page 140)

- Dentalax neck rest, synthetic leather ,--
- Dentalax neck rest, PU ,--
- Gel cushions for the face cradle ,--
- Terrycloth (white, macchiato, or choco) ,--
- PU protective cover, Art. 49051 ,--

# Fairmont Royal Palm Marrakesh Morocco





Photos: ©Fairmont Royal Palm Marrakesh

# MLR Classic





## Gharieni MLR Classic

The purist MLR Classic has – like the MLX designer bed – two strong lifting columns, which permit a wide range of reclining positions. The absence of storage space in the lower area ensures optimal legroom during treatment.

Height, inclination, as well as back and foot sections are electrically adjustable. In addition, the MLR is equipped with a Trendelenburg feature and a locking feature; and of course there is also a face cradle in the rest.

As an additional option, the Smart-Thermo offers a programmable heating system with automatic switch-off as well as a foot switch for controlling the basic functions.

### Features:

- Face cradle
- Height, inclination, as well as back and foot areas are electrically adjustable.
- Base made from wood decor
- Metal edge protection at the base
- Trendelenburg feature
- Locking feature
- Robust synthetic leather upholstery
- Optional PU and soft upholstery
- Standard upholstery color:  
Synthetic leather: White. PU: White and Choco  
Other colors from our color collection for an additional charge
- Base in five standard decors (see page 19), optional in other decors



- Height: 57-87 cm
- Length: 203 cm
- Width: 80 cm
- Lifting capacity: 300 kg
- Load capacity of the table surface: 350 kg

MLR

4-actuator



# MLR Classic



Clear design, high degree of functionality

The MLR Classic can be optimally adjusted electrically via four actuators. Thus, not only is a low step height of 57 cm possible, but also the adjustability of the backrest by ap-

prox. 70°, the leg area by around 25°, and the inclination angle of the table surface by about +/- 15°. The four-part table surface can thus adapt to almost all treatment requirements.



#### Edge protection on the base

The high-end edge protection on both ends of the table base prevents unsightly wear and damage to the decor. This keeps the MLR always looking well-maintained.



#### Trendelenburg position

Customers will find particularly pleasant relaxation in the zero gravity bed position with lowered head and raised feet.



#### Extreme legroom







The MLR offers maximum legroom for all treatments thanks to the particularly slim and elegantly designed lifting columns and the absence of storage space in the bed base.



#### Also as a wet table version

With a water-resistant PU cover and water-resistant base, the MLR is also perfect for all wet and outdoor treatments (for details see page 84).

#### Options (more info. after page 16)

-  Soft Upholstery ,-,-
-  Smart-Thermo: programmable heating system with automatic shut-off ,-,-
-  Color upholstery:
  - PU, each color ,-,-
  - Synthetic leather standard, per color ,-,-
  - Synthetic leather Ferrari Stamskin Top, per color ,-,-
-  Metal parts in special colors (white, titanium, or dark brown are included in the table price) ,-,-
-  Decor surfaces our extended collection (standard collection: see page 19), ,-,-
-  Foot switch to control the basic functions ,-,-

#### Accessories (see also page 140)

- Dentalax neck rest, synthetic leather ,-,-
- Dentalax neck rest, PU ,-,-
- Gel cushions for the face cradle ,-,-
- Terrycloth (white, macchiato, or choco) ,-,-
- PU protective cover, Art. 49051 ,-,-

# MLR Select series



## Gharieni MLR Select

Your very own personal wellness couch. Our Gharieni MLR Select follows this principle with its three different basic variants, "Alu", "Wood", and "Static", each in four upholstery widths.

Intentionally, storage space has been omitted here to ensure optimum legroom. With its reduced design, this couch does not need to hide behind its "big sister", the MLX. Two strong lifting columns, lowerable and swiveling arm supports, adjustable head, back and leg sections as well as an optional fold-down foot section make the MLR Select a versatile work tool. In addition, the couch is equipped with a Trendelenburg function and a locking function.

Another option is the Smart-Thermo, a programmable heating system with automatic switch-off, as well as a foot switch for controlling the basic and memory functions.

### Features:

- Three basic versions with wood or aluminum trim or for direct floor mounting
- Height, inclination, as well as back and foot areas are electrically adjustable.
- Swiveling and lowering arm supports
- also available in a pro version with fold-out foot section
- Trendelenburg feature
- Robust PU upholstery in four widths
- Face cradle
- Optional soft upholstery
- Standard upholstery color: White or choco. Other colors from our color collection for an additional charge
- Hand switch with locking feature (Design hand switch on Select Alu)
- Optional: Hand switch with memory feature for up to eight table positions (included with Select Alu)
- Optional with scent generator for aroma therapy



- Height: 61-91 cm
- Length: 200 cm
- Width: 76 cm / 80 cm / 85 cm / 92 cm
- Lifting capacity: 300 kg
- Load capacity of the table surface: 350 kg

### MLR Select Alu

Small (width: 76 cm)	,-,-
SmallMedium (width: 80 cm)	,-,-
Medium (width: 85 cm)	,-,-
Large (width: 92 cm)	,-,-

Fold-down foot section, manual	,-,-
Fold-down foot section, electrical	,-,-



MLR Select Alu including  
Alu Design hand switch

MLR Select Alu  
mit Soft Upholstery



MLR Select Wood  
with standard upholstery

### MLR Select Wood

Small (width: 76 cm)	,-,-
SmallMedium (width: 80 cm)	,-,-
Medium (width: 85 cm)	,-,-
Large (width: 92 cm)	,-,-

Fold-down foot section, manual	,-,-
Fold-down foot section, electrical	,-,-

### MLR Select Static

Small (width: 76 cm)	,-,-
SmallMedium (width: 80 cm)	,-,-
Medium (width: 85 cm)	,-,-
Large (width: 92 cm)	,-,-

Fold-down foot section, manual	,-,-
Fold-down foot section, electrical	,-,-



# MLR Select series



## MLR K8

Medium (width: 85 cm) ---

Large (width: 92 cm) ---

Fold-down foot section, manual ---

Fold-down foot section, electrical ---Warming  
drawer ---

With the optional warming drawer, compresses, herbal pouches or preparations can be brought to the perfect temperature through six preset heating programs. Internal dimensions: 97 mm (H) x 535 mm (W) x 410mm (D), power, max: 810 W .



Optional lighting (Spa Ambience Light)



## Gharieni MLR K8

Equipped with storage compartments and an optional integrated warming drawer, the MLR K8 has the same features as our proven MLR Select models.

Two strong lifting columns, lowerable and swiveling arm supports, adjustable head, back, leg and foot sections as well as an optional fold-down foot section make the MLR K8 a versatile work tool. In addition, the couch is equipped with a Trendelenburg function and a locking function.

Another option is the Smart-Thermo, a programmable heating system with automatic switch-off, as well as a foot switch for controlling the basic and memory functions.

### Features:

- Base with storage compartments and optional warming drawer
- Height, inclination, as well as back and foot areas are electrically adjustable.
- Swiveling and lowering arm supports
- also available in a pro version with fold-out foot section
- Trendelenburg feature
- Robust PU upholstery in four widths
- Face cradle
- Optional soft upholstery
- Standard upholstery color: White or choco. Other colors from our color collection for an additional charge
- Hand switch with locking feature
- Base design selectable from three different decors, optionally in other decors
- Optional: Hand switch with memory feature for up to eight table positions
- Optional with scent generator for aroma therapy

Base combinable in the colors:

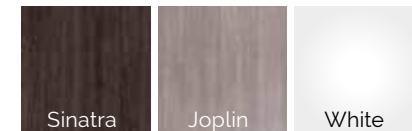

- Height: 61-91 cm
- Length: 200 cm
- Width: M 85 cm / L 92 cm
- Lifting capacity: 300 kg
- Load capacity of the table surface: 350 kg

## Gharieni MLR Select Vintage

The unique MLR version with storage space in a retro design is an absolute highlight. The base with exclusive metal-wood look offers extensive storage space for towels and everything else you need for your work.

Like the other members of the MLR Select family, the Vintage has two strong lift columns, lowering and swiveling arm supports, adjustable head, back, leg, and foot sections, and an optional fold-down foot section. In addition, the table is equipped with a Trendelenburg feature and a locking feature.

As an additional option, the Smart-Thermo offers a programmable heating system with automatic switch-off as well as a foot switch for controlling the basic and memory functions.

### Features:

- Base with vintage design in metal-wood look (standard monochrome decor)
- Multicolor design possible
- With side panels
- Height, inclination, as well as back and foot areas are electrically adjustable.
- Swiveling and lowering arm supports
- Also available in a pro version with fold-out foot section
- Trendelenburg feature
- Robust PU upholstery in three widths
- Face cradle
- Optional soft upholstery
- Standard upholstery color: White. Other colors from our color collection for an additional charge
- Hand switch with locking feature
- Optional: Hand switch with memory feature for up to eight table positions
- Optional with scent generator for aroma therapy



- Height: 61-91 cm
- Length: 200 cm
- Width: M 85 cm / L 92 cm
- Lifting capacity: 300 kg
- Load capacity of the table surface: 350 kg

### MLR Select Vintage

Medium (width: 85 cm)	,-,-
Large (width: 92 cm)	,-,-
Fold-down foot section, manual	,-,-
Fold-down foot section, electrical	,-,-



## Vintage Trolley

Matching the design of the MLR Select Vintage, the Vintage Trolley with its three drawers and two shelves offers plenty of space for your work instruments.

With its brakable lightweight wheels, it can be positioned wherever you need it..

### Vintage Trolley

Single-color	,-,-
--------------	------

# MLR Select series

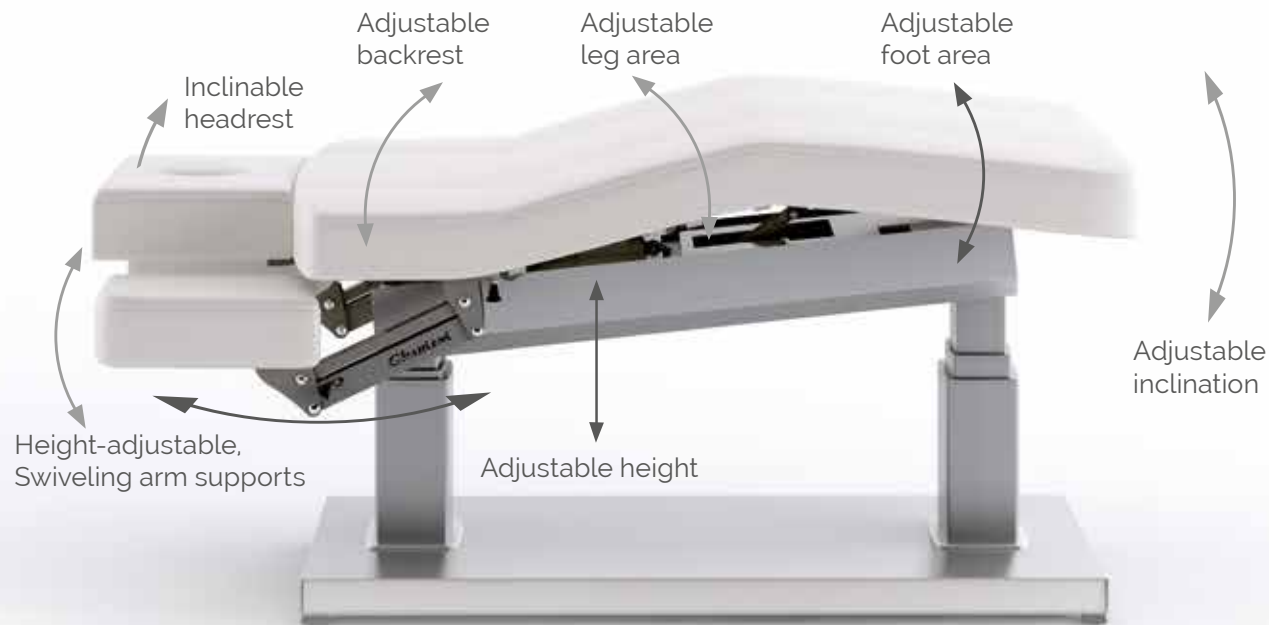

## Practical & Versatile

Do not be fooled by the simplified design of our MLR Select! In terms of adjustability, versatility, and ergonomics, it also meets the highest demands. The head section can be tilted by  $\pm 30^\circ$ . With two lifting columns, the height of 57-97 cm

can be adjusted electrically, the back and leg sections can be adjusted by  $70^\circ$  or  $30^\circ$ , and the arm supports can be lowered by approx. 15 cm. The inclination of the table surface can be adjusted by  $\pm 15^\circ$ .





### Fold-out foot section

The optionally available fold-out foot section not only facilitates treatment of the feet; but also allows their relaxed, natural position with massages in the prone position.



### Trendelenburg position

Customers will find particularly deeper relaxation in the zero gravity bed position with lowered head and raised feet.



### Swiveling arm supports









The swiveling arm supports give your treatments the necessary freedom: Simply swivel them backwards and you're able to "freely" work on the head, neck, and décolleté area. The pads can be locked in four positions.



### Holder for magnifying lamp

A practical option is the retractable magnifying lamp holder made of stainless steel. It was developed for the "Circle" LED magnifying lamp and simply disappears under the bed surface when not in use.

### Options (more info. after page 16)

-  Soft Upholstery ,-,-
-  Smart-Thermo: programmable heating system with automatic shut-off ,-,-
-  Color upholstery:  
PU (white or choco included in price), each color ,-,-
-  Metal parts of the base made of aluminum (only for Select Alu) ,-,-
-  Metal parts in special colors (white, titanium, or dark brown are included in the table price) ,-,-
-  Decor surfaces our extended collection (standard collection: see page 19), ,-,-
-  Dual headrest ,-,-
-  Hand switch with memory function: up to four table positions can be stored (included in the price of MLR Select Alu) ,-,-
-  Foot switch memory function: for controlling the basic functions and the memory positions ,-,-
-  Base with white LED illumination (only for MLR K8) ,-,-
-  Aroma Therapy ,-,-

### Accessories (see also page 140)

- Dentalax neck rest, PU ,-,-
- Gel cushions for the face cradle ,-,-
- Terrycloth (white, macchiato, or choco) ,-,-
- Foot protective cover, PVC, transparent ,-,-
- Double-sided (magnifying) lamp mount ,-,-
- LED Magnifying Lamp "Circle" ,-,-
- PU protective cover, Art. 49051 ,-,-

# FÄHRHAUS Koblenz

Germany





Photos: © FÄHRHAUS Koblenz

# E-Line



E-Line with soft upholstery



E-Line with standard upholstery  
without storage space



## E-Line without storage space

Small (width: 76 cm)	---
Medium (width: 82 cm)	---

## E-Line with storage space

Small (width: 76 cm)	---
Medium (width: 82 cm)	---

High-Performance lifting columns	---
Warming drawer	---

## Gharieni E-Line

The practically designed spa table Gharieni E-Line offers perfect lying and working equally. The special feature: the compact base of the table moves upwards with the lying surface and can be equipped with normal storage compartments as well as -optional- with a warming drawer. This ensures both optimal legroom and easy access to your work utensils during treatment.

Four preset and two storable treatment positions as well as control via wired hand switch or optional Bluetooth foot switch additionally make daily work easier. The pleasantly soft PU upholstery is available in the sizes "Small" and "Medium".

### Features:

- Base with storage compartments and optional warming drawer
- Also available without storage compartment
- Height, leg and back area electrically adjustable
- Foot area manually adjustable
- Arm supports can be lowered
- Robust PU upholstery in two widths
- Soft upholstery optional
- Also available with lower flat upholstery
- Standard upholstery color: white or choco. other colors from our color collection available at extra charge
- Base in five standard decors (see page 19), optional in other decors
- Four treatment positions preset, two additional positions freely programmable
- Automatic safety lock after 30 minutes
- Optional: Bluetooth foot switch
- Optional with fragrance generator (aroma therapy)
- Also available with High Performance lifting columns with approx. 60% more lifting force and 25% higher speed



- Height: 54-92 cm (49-87 cm mit Flat-Polster)
- Length: 204 cm
- Width: S 76 cm / M 82 cm
- Lifting capacity: 250 kg / 400 kg (High Performance)
- Load capacity of the table surface: 300 kg / 450 kg (High Performance)



### Lift-up storage space

The special feature of the E-Line: The storage compartments are located directly under the lying surface and are lifted up with it. This means they are easily accessible at all times..

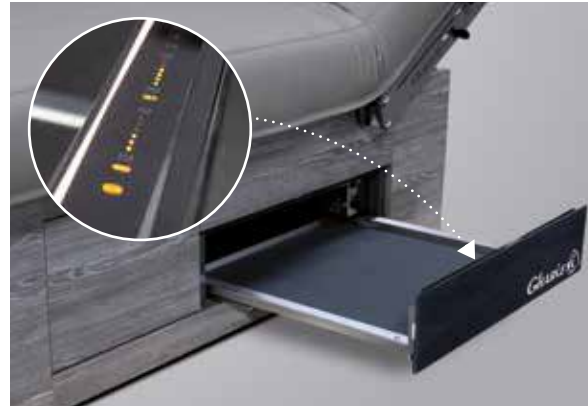

### Warming drawer

With the optional warming drawer, compresses, herbal pouches or preparations can be brought to the perfect temperature through six preset heating programs. Internal dimensions: 97 mm (H) x 535 mm (W) x 410mm (D), power, max: 810 W



### Spa Ambience Light









The hidden LED strip at the base of the couch adds a light accent in your desired color to the E-Line and provides atmospheric lighting in your treatment room.



### Integrated Hot Cabi

The storage compartment in the base of the E-Line treatment table allows you to store a small Hot Cabi. This allows you to work in a particularly practical way and your treatment room is always tidy.

## Optionen

-  Soft Upholstery ,-,-
-  Smart-Thermo: programmable heating system with automatic shut-off ,-,-
-  Color upholstery:  
PU (white or choco included in price), each color ,-,-
-  Metal parts in special colors (white, titanium, or dark brown are included in the table price) ,-,-
-  Decor surfaces: our extended collection (standard collection: see page 19, ,-,-
-  Bluetooth Foot switch with memory function: for controlling the basic functions and the memory positions ,-,-
-  Spa Ambience Light: Base with LED lighting ,-,-
-  Aroma Therapy ,-,-

## Accessories

- Dentalax neck rest, PU ,-,-
- Gel cushions for the face cradle ,-,-
- Terrycloth (white, macchiato, or choco) ,-,-
- Foot protective cover, PVC, transparent ,-,-
- Double-sided (magnifying) lamp mount ,-,-
- LED Magnifying Lamp "Circle" ,-,-
- PU protective cover, Art. 49051 ,-,-

# MO1 series



## Gharieni MO1 Evo

Our MO1 Evo has an extremely low access height from 50 cm. This table allows even very short or physically restricted customers comfortable and convenient access. The arm supports can be electrically lowered and swiveled on request (exception: the MO1 with removable headrest). The optional storage space in the base is flexible and configurable. This way, Hot/Cool Cabis can be integrated on the head and/or foot side. Three table surface versions ensure individual adaptability.

Whether it's standard/soft upholstery or full-length table surface with attachable headrest (without arm supports) – simply choose the table that best suits your needs! Optionally, the MO1 can even be equipped with Breast Contouring System. This ensures that for women, the chest area is relieved in the prone position.

Of course, all models can also be individually configured for upholstery color and basic decor. Ask for our current color and decor patterns!

### Features:

- Extremely low access height of 50 cm
- Up to six actuators for adjusting the height, back, leg, and foot sections and optionally for the arm supports as well
- Swiveling arm supports (not on the MO1 with removable headrest)
- Eight treatment positions can be saved
- Hand switch with locking feature
- Quilted PU upholstery in three widths
- Three available upholstery versions
- Optional storage space in the base (open or closed)
- Mechanical (optionally electrical) extendable castors
- Standard upholstery color: white or choco. Other colors from our color collection for an additional charge
- Base in five standard decors (see page 19), optional in other decors
- Optional LED lighting strip for base lighting
- Bracket for attaching a (magnifying) lamp optional
- Optional with scent diffuser for aroma therapy



- Height: 50-82 cm
- Length: 205 cm
- Width: S 76 cm / M 85 cm / L 92 cm
- Lifting capacity: 250 kg
- Load capacity of the table surface: 300 kg



MO1 Evo with standard upholstery

#### MO1 Evo

Small (width: 76 cm)	7,--
Medium (width: 85 cm)	7,--
Large (width: 92 cm)	7,--

Integrated storage space	7,--
(Magnifying) lamp holder on both sides	7,--
Breast Contouring System	7,--



MO1 Evo with soft upholstery



MO1 EVO with removable headrest (without arm supports!)

# MO1 series



## Extremely low access height

With a height adjustability of 50-82 cm, the MO1 Evo and MO1 Square are the ideal table models, even for short or physically restricted customers; because the minimum height of 50 cm makes it easier to get in and out of the table. In addition, the MO1 offers optimal adjustability. Thus, the head section can be tilted by + 60°/-35° and the arm sup-

ports can optionally be electrically lowered at the push of a button. The backrest can be set up to 70° and the leg section up to 20°. And for "your" perfect table model, configure the MO1 with a soft, super-soft upholstery, or a full-length upholstery with a clip-on headrest.







### Integrated Hot/Cool Cabi

Integrated compartments in the MO1 Evo on the head and/or foot side of the table base allow Hot and Cool Cabis to be stored. It's a great way to work and your workspace will always be tidy.

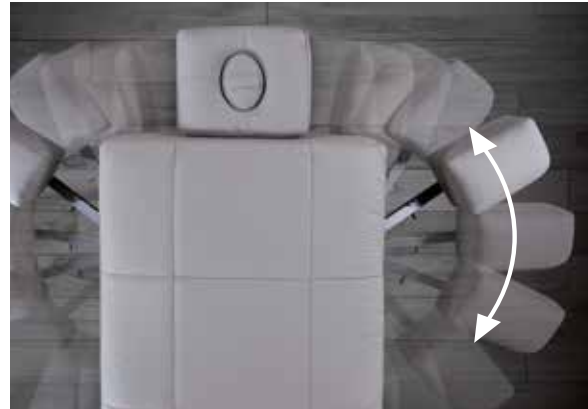

### Swiveling arm supports

If you need a lot of space for the facial, you don't necessarily have to go without arm supports. The swiveling arm supports give you the necessary free space. Simply swivel them backwards and you're ready to "freely" work on the head, neck, or décolleté area.



### Optional: Holder for (magnifying) lamps













The extendable (magnifying) lamp holder made of stainless steel is completely new. When not in use, it simply disappears under the table – a feature no other manufacturer offers. The matching Flex LED magnifying lamp allows for precision while working.



### Optional: Aroma therapy

Wellness with all the senses: Immerse your customers into a world of soothing scents during treatment. Your treatment will be a fragrant experience thanks to the integrated scent diffuser.

### Options (more info. after page 16)

-  Soft Upholstery ,--
-  Electrically lowerable arm supports (swiveling) ,--
-  Triple-Airback® technology: electro-pneumatic 3-zone lordosis support system of the upholstery ,--
-  Smart-Thermo: programmable heating system with automatic shut-off ,--
-  Vibro-Wellness: gently pulsating vibration system with many adjustment options ,--
-  Color upholstery: PU (white or choco included in price), each color ,--
-  Multimedia sound system Audio-Relax-Headrest ,--
-  Metal parts in special colors (white, titanium, or dark brown are included in the table price) ,--
-  Decor surfaces our extended collection (standard collection: see page 19), ,--
-  Dual headrest ,--
-  Electrically lowerable castors ,--
-  Foot switch memory function: for controlling the basic functions and the memory positions ,--
-  IR Handheld remote control: wireless operation for controlling the table ,--
-  Spa Ambience Light: Base with LED lighting ,--
-  Aroma Therapy ,--

### Accessories (see also page 140)

- Double-sided (magnifying) lamp mount ,--
- LED Magnifying Lamp "Circle" ,--
- Dentalax neck rest, synthetic leather ,--
- Dentalax neck rest, PU ,--
- Terrycloth (white, macchiato, or choco) ,--

# The Address Downtown Dubai United Arab Emirates





Photos: © The Address Downtown Dubai

# MLW F1 series



## Gharieni MLW F1

The spa table with a special design! The advancement of the MLW Classic has a narrow base, is just 57 cm wide, and features specially curved front ends. These features allow more foot and legroom, making it easier to work on massages and cosmetic treatments. The comfortable full-length upholstery is available in two thicknesses, offering exceptional comfort for every need – even for longer treatment sessions.

A particular highlight is that the wood side panels can be replaced with new ones if necessary. This way you can always adapt the table to your personal ambience.

### Features:

- Narrow base trim and gently curved front ends for more legroom
- Configurable equipment
- Exchangeable side wood decor casing
- Up to six actuators for adjusting the height, back, leg, and foot sections and optionally for the arm supports as well
- Up to eight treatment positions can be saved
- Control selectable from wired hand switch, footswitch, or infrared remote control
- Lowerable and swiveling arm supports
- Head section +/- 30° tiltable
- Full-length molded PU upholstery with memory foam in three widths
- Standard upholstery color: white or choco. Other colors from our color collection for an additional charge
- Base in five standard decors (see page 19), optional in other decors
- Mechanically lowerable castors

### MLW F1

Small (width: 76 cm)	7,--
Medium (width: 85 cm)	7,--
Large (width: 92 cm)	7,--



MLW F1 with standard upholstery



MLW F1 with soft upholstery



- Height: 58-91 cm
- Length: 203 cm
- Width: S 76 cm / M 85 cm / L 92 cm
- Lifting capacity: 250 kg
- Load capacity of the table surface: 300 kg

# MLW F1 series

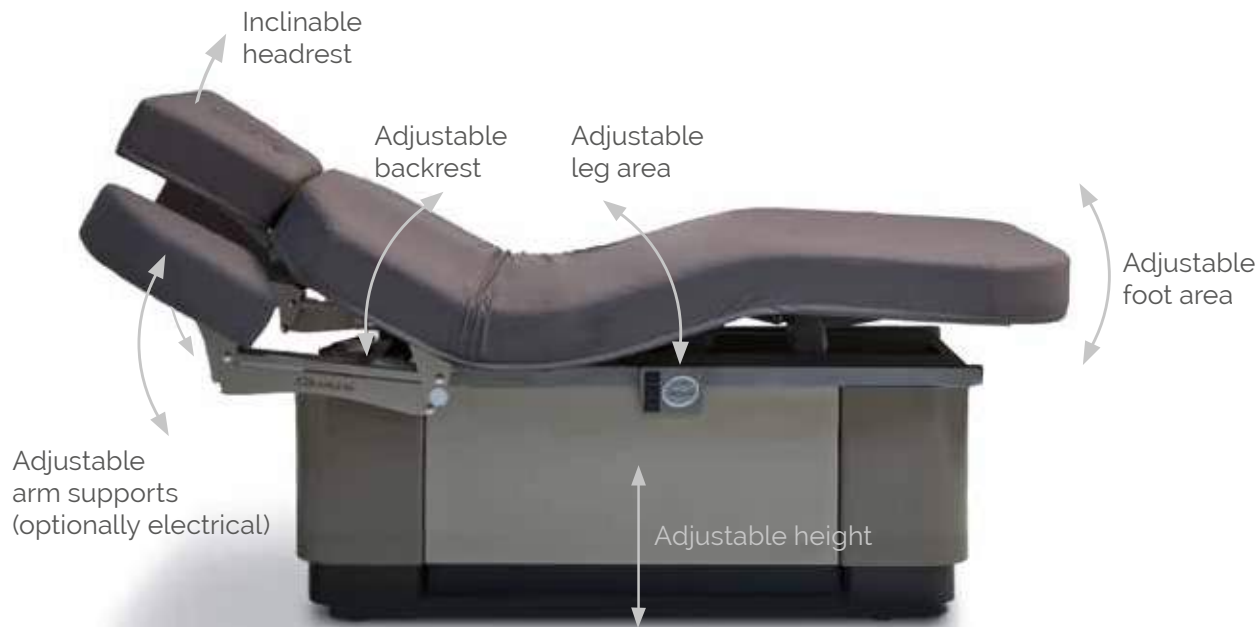

## More comfort with six actuators

Our size M and L MLW F1 models are now also available with six actuators. For more comfort, the arm supports – in addition to height, back, leg, and foot area adjustment – can also be controlled synchronously. In addition to direct settings via pushbuttons on the arm supports themselves, their setting can be conveniently saved using the memory functions.

This allows the F1 to be moved to the programmed positions with a single push of a button. The table surface can be adjusted from 58-91 cm in height, the backrest by about 70°, the leg area by about 25°, and the foot by up to 18°. The head section can be tilted by +/- 30°.





### Swiveling arm supports

If you need a lot of space for the facial, you don't necessarily have to go without arm supports. The swiveling arm supports give you the necessary free space. Simply swivel them backwards and you're able to "freely" work on the head, neck, and in the décolleté area.

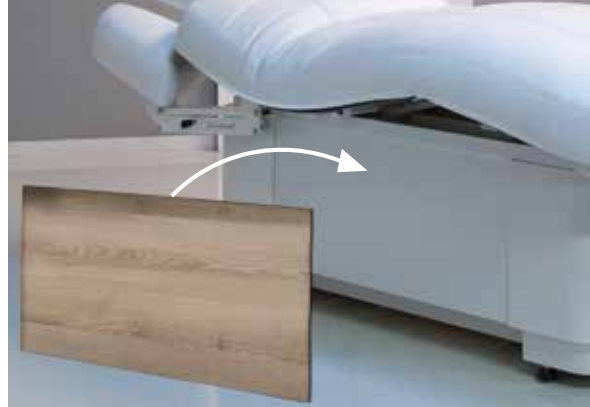

### Exchangeable wood trim

Looking for a new design? Why not just swap out the entire table? The side trim on our MLW F1 Wood can be very easily exchanged. Our numerous decors offer something for every ambience and a new, fresh look!



### Specially formed front ends



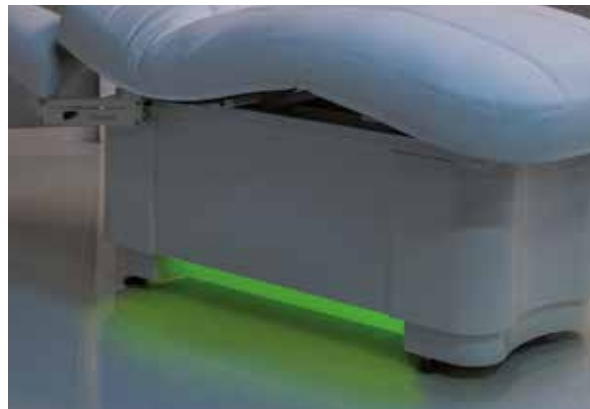









The curved shape of the front ends made of aluminum provide you with enough legroom for all kinds of treatments. This way you can work in comfortably and enjoyably. The parts are available in different anodized colors.



### Spa Ambience Light

The concealed LED strip on the table base adds a light accent in your desired color to the MLW F1 and ensures atmospheric lighting in your workspace.

### Options (more info. after page 16)

-  Soft Upholstery ,-,-
-  Electrical lowerable arm supports ,-,-
-  Triple-Airback® technology: electro-pneumatic 3-zone lordosis support system of the upholstery ,-,-
-  Smart-Thermo: programmable heating system with automatic shut-off ,-,-
-  Vibro-Wellness: gently pulsating vibration system with many adjustment options ,-,-
-  Color upholstery PU: max. 2 colors possible, each color ,-,-
-  Multimedia sound system Audio-Relax-Headrest ,-,-
-  Metal parts in special colors (white, titanium, or dark brown are included in the table price) ,-,-
-  Decor surfaces our extended collection (standard collection: see page 19), ,-,-
-  Dual headrest ,-,-
-  Foot switch memory function: for controlling the basic functions and the memory positions ,-,-
-  IR Handheld remote control: wireless operation for controlling the table ,-,-
-  Spa Ambience Light: Base with LED lighting ,-,-

### Accessories (see also page 140)

- Dentalax neck rest, PU ,-,-
- Gel cushions for the face cradle ,-,-
- Terrycloth (white, macchiato, or choco) ,-,-
- Foot protective cover, PVC, transparent ,-,-
- PU protective cover, Art. 49051 ,-,-

# Quellenhof Luxury Resort Lazise Italy







Photos: © Quellenhof Luxury Resort Lazise

# MLW Neo series



## Gharieni MLW Neo

Variable and individual: From the upholstery to the casing, many elements can be individually selected with this classic spa table.

The low height of about 57 cm facilitates access and the maximum height of 92 cm allows back-friendly working. Table area widths in Small (76 cm), Medium (85 cm), and Large (92 cm) are available. In addition to the standard version, there is a soft PU upholstery available as well, offering exceptional comfort to meet every need – even during longer treatment sessions.

Equipped with four actuators, the treatment positions can be set on this couch as well as four freely storable memory positions with the optional memory handset. The arm supports can be lowered by pneumatic springs.

### Features:

- Table surface in three widths (S, M, and L)
- Height, back, leg, and foot section electrically adjustable
- Four storable positions with optional memory hand switch
- Hand switch with locking feature
- Lowerable arm supports
- Head section +/- 30° tiltable
- Soft PU upholstery as standard and soft version
- Standard upholstery color: white or choco. Other colors from our color collection for an additional charge
- Base in five standard decors (see page 19), optional in other decors
- Mechanically extendable castors



- Height: 57-92 cm
- Length: 203 cm
- Width: S 76 cm / M 85 cm / L 92 cm
- Lifting capacity: 250 kg
- Load capacity of the table surface: 300 kg



MLW with standard upholstery

### MLW Neo

Small (width: 76 cm)	,-,-
Medium (width: 85 cm)	,-,-
Large (width: 92 cm)	,-,-



MLW with soft upholstery

# MLW Neo series



## Gharieni MLW Amphibia Neo

Whether for classic facial and whole-body treatments "on land" or relaxing spa applications "on water," the MLW Amphibia combines both: The Aqua upholstery, as well as the firm padding, allow for a very flexible variety of treatments, even those currently in vogue.

The four actuators allow for a variety of height, back, thigh, and leg section adjustments. The access height is 54 cm. Four treatment positions can conveniently be stored and retrieved as required via the memory function. The head section can be tilted up and down by 30° each with a pneumatic spring and the arm supports are also continuously lowerable and therefore ideal for back treatments!

### Features:

- Table surface with heated Aqua upholstery
- Height, inclination, as well as backrest and foot section electrically adjustable.
- Lowerable arm supports
- Head section +/- 30° tiltable
- Four treatment positions can be saved
- Illuminated table surface and sides
- Soft PU upholstery can be exchanged for Aqua upholstery
- Triple-Airback technology: electro-pneumatic 3-zone lordosis support system of the upholstery
- Inflation connection for optional Ayurveda cover
- Standard upholstery color: white or choco. Other colors from our color collection for an additional charge
- Base in five standard decors (see page 19), optional in other decors
- Mechanically extendable castors



- Height: 54-90 cm
- Length: 202 cm
- Base width: 55 cm
- Table surface width: 85 cm
- (Recommended) lifting capacity: 250 kg
- Load capacity: approx. 300 kg



MLW Amphibia Neo

Including water cushion



# MLW Neo series



## Perfect for any treatment

With four actuators, a height of 54-96 cm can be electrically adjusted on the MLW series table models. The backrest can also be adjusted electrically by approx. 70°, the leg area by approx. 25°, and the foot section by up to 18°. The arm sup-

ports can be lowered by up to 15 cm using a pneumatic spring and the head section can be tilted by +/- 30°. The four storable treatment positions are also quite practical at work.





### Comfortable soft upholstery

The extra-soft soft upholstery version of the MLW Classic will leave your customers floating on air. Made of skin-friendly, hygienic PU, the table upholstery is particularly suitable for long treatments.



### Optimally regulated warmth

The Smart-Thermo table heater has a temperature control with an automatic shut-off. This way you can ensure an optimal table upholstery temperature.



### Side shelves



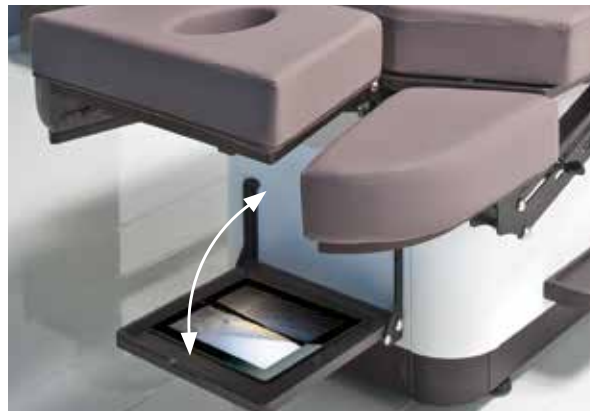







On request, the table can be equipped with two shelves running along the side area. There's plenty of space for everything you need during your treatments.



### Folding tray with magnetic closure

The practical folding tray at the head of the MLW allows e.g. a tablet with relaxing pictures or films to be placed there that make the view through the face cradle more comfortable for your customers.

### Options (more info. after page 16)

-  Soft Upholstery (not possible with MLW Amphibia) ,-,-
-  Smart-Thermo: programmable heating system with automatic shut-off (included with MLW Amphibia) ,-,-
- Color upholstery:
-  PU (white or choco included in price), each color ,-,-
-  Only with MLW Soft:  
Synthetic leather standard, per color ,-,-
-  Synthetic leather Ferrari Stamskin Top, per color ,-,-
-  Audio-Relax-Headrest: with integrated speakers to connect to common players ,-,-
-  Metal parts in special colors (white, titanium, or dark brown are included in the table price) ,-,-
-  Decor surfaces: our extended collection (standard collection: see Seite 23), ,-,-
-  Dual headrest ,-,-
-  Hand switch with memory function: up to four table positions can be stored ,-,-
-  Foot switch to control the basic functions ,-,-

### Accessories (see also page 140)

- Dentalax neck rest, synthetic leather ,-,-
- Dentalax neck rest, PU ,-,-
- Gel cushions for the face cradle ,-,-
- Terrycloth (white, macchiato, or choco) ,-,-
- Foot protective cover, PVC, transparent ,-,-
- PU protective cover, Art. 49051 ,-,-

# Sparkling Jewel

The high-end trim with quilted upholstery and sparkling Swarovski Elements adds sparkling elegance to your workspace or spa, making the MLW Amphibia a real eye-catcher. And that little extra: The perfectly integrated LED strips not only immerse the water cushions in wonderful and – depending on the setting – changing color light, but the base of the lounger as well. This gives the Swarovski Elements a really impressive sparkle. On request, the quilted base is also available without Swarovski Elements.



Quilted upholstery	
With Swarovski Elements	,-,-
Without Swarovski Elements	,-,-



## Gharieni MLE Neo

The MLE Neo is an absolute all-rounder, because it is suitable for cosmetics, wellness, and massage alike. With three actuators, the height as well as the back and leg sections can be adjusted electrically. The head section can be inclined via a pneumatic spring by +/- 30°. To relieve the shoulder and neck area during massages, the arm supports can be lowered manually

### Features:

- Height, back, and leg section adjustment via three actuators
- Head section +/- 30° tiltable
- Adjusting the head area via pneumatic spring
- Upholstery firmness: 10 cm
- Available in wenge with black-brown corners and choco-colored upholstery
- Including mechanically lowerable castors



- Height: 58-92 cm
- Length: 204 cm
- Width: 84 cm
- Lifting capacity: 250 kg
- Load capacity of the table surface: 300 kg

### Options (more info. after page 16)

- |   |   |      |
|---|---|------|
|  | Smart-Thermo: programmable heating system with automatic shut-off | ,-,- |
|---|---|------|

### Accessories (see also page 140)

- |   |      |
|---|------|
| Dentalax neck rest, PU                  | ,-,- |
| Gel cushions for the face cradle        | ,-,- |
| Terry cloth cover                       | ,-,- |
| Foot protective cover, PVC, transparent | ,-,- |
| PU protective cover, Art. 49051         | ,-,- |

MLE Neo

3-actuator

,-,-

# JW Marriott Hotel Ankara Turkey





Photos: © JW Marriott Hotel Ankara

# Spa Tables Accessories

## Upholstery Covers

With the right covers your spa table will always be well protected against different types of stresses and strains. Our table-specific covers fit exactly the individual upholstery segments and thereby the function of the table is not limited.

Thanks to the high-quality terrycloth material, machine washing up to 60° C is possible and therefore hygienic cleaning is possible. Our covers are available in white, choco, and macchiato.

It is best to order the right cover directly when you buy your table. Our team would be happy to help you decide!



## Dentalax Neck Rest

This little tool can significantly improve the comfort of lying on your treatment table. Because the Dentalax supports the position of the neck and helps to stabilize the head. This creates a more comfortable table experience while relieving the neck vertebra. We recommend the Dentalax neck rest for each of our treatment tables as an optimal supplement for the best lying comfort and an increase in treatment ergonomics. The Dentalax is available to match the upholstery color of the table.

Dentalax with PU, white	-,-
Dentalax with PU, choco, creme, or cappuccino	-,-
Dentalax with synthetic leather, white	-,-
Dentalax with synthetic leather, in standard colors	-,-
Dentalax with synthetic leather, in Stamskin colors	-,-



## Foot protective cover

To protect the table areas at the foot end, we offer a suitable protective cover made of robust, transparent PVC for all tables. It can be securely fixed to the upholstery via Velcro.

Protective cover -,-



## Gel cushion for face cradles

Prevent unpleasant pressure points on the face with this gel cushion. In addition, the gel fluid has a pleasantly cooling effect. The transparent gel cushion can be securely attached to our tables by means of one or two tabs.

Gel ring with 2 tabs	-,-
Gel ring with 1 tab	-,-



## Cover towel with face cradle, large

There is this special single-use cover towel with face cradle for improved hygiene. What makes it special: Thanks to its width, it not only protects the headrest, but also the arm supports against contamination. Ideal for all our tables with lowerable arm supports or wide head sections. Size: 130 x 35 cm

Package with 50 items, Art. 45310, 1-2 packages, ea. -,-

Package with 50 items, Art. 45310, 3-4 packages, ea. -,-

Package with 50 items, Art. 45310, 5 packages, ea. -,-



## Face cradle towels

Extra soft, slotted disposable towel to protect the headrest upholstery; extremely practical and hygienic. Recommended for all headrests with face cradle. Size: 30 x 21 cm

Package with 100 items, Art. 45305 -,-



## PU protective cover

With this practical cover made of robust PU material, nothing stands in the way of your special treatment any longer. Whether it's oil massages, packs, or the like, the upholstery is always well-protected. The cover has an elastic band to prevent unwanted slipping and can be washed at up to 90 °C. Available in white, choco, or creme.

PU protective cover, Art. 49051 -,-



## Ayurveda cover

The transparent Ayurveda cover is ideal for pouring oil. It features a drain which allows the oil to be cleanly drained away. The side edge is inflatable allowing the cover be stored to save space after use.

Ayurveda cover, Art. 49050 -,-



## mikrozyd® sensitive

For the gentle and thorough care of our upholstery we recommend mikrozyd® sensitive. Available as liquid or ready-to-use cloths in a handy dispenser, it eliminates bacteria, fungi, and viruses (such as HBV, HIV, Rota, vaccinia). Without alcohol!

mikrozyd® sensitive Wipes, Art. 79418 -,-

mikrozyd® sensitive Liquid, Art. 79417 -,-



# Spa tables accessories





## PlexiShield

Gharieni's Plexi-Shield is the perfect solution to meet all strict hygiene requirements at work, especially during facial treatments. The thermoformed and ergonomic Gharieni Plexi-Shield can be easily attached to the metal frame under the headrest of all Gharieni spa tables of the MLW Neo, MLW F1 and MO1 series.

The direct connection to the frame ensures maximum legroom for the therapist when working on the headrest. Moreover, it eliminates the need for any additional height adjustment, as the shield automatically changes with the height of the spa table.

The depth (distance between the headrest and the shield) is also adjustable. When not in use, the shield can be easily removed and stored away, wasting no space in your treatment room. In this way, the entire shield, can be easily cleaned and disinfected. The Gharieni Plexi Shield set includes the thermoformed shield, two rails and brackets for easy installation.

Art. W-SHIELDI



## PlexiShield with stand

- Height adjustable from approx. 115-145 cm
- Flat foot design for sliding under Gharieni treatment tables
- Easy running castors
- Perfect protection for flexible treatments

Art. 76119



## Magnifying lamp with PlexiShield

- Lamp head with plexiglass screen
- 3 diopters
- Standpipe and flex hose made of robust metal
- 21 LEDS
- Dimmable
- Arm length approx. 83 cm

Art. 41999-SHIELD

# Loungers



Gharieni  
Evo Lounger





Gharieni  
RLR



Gharieni  
RL Aqua



Gharieni  
RLX series



# Evo Lounger

## Gharieni Evo Lounger

This exclusive lounger offers pure relaxation. Equipped with four actuators, the head, back, leg, and foot sections can be adjusted separately via handheld remote control. The three most common table positions are preset and can be called up at the push of a button. Thanks to its special material, the upholstery is able to perfectly adapt to every body type. With a pull-out shelf on the left and right as well as an LED reading light, the Evo Lounger offers moments of well-being with maximum comfort.

And that little extra: The lounger color can be individually designed. The standard white PU upholstery is also optionally available in creme, choco, black, and macchiato. The casing comes equipped standard in white or with wenge decor. This allows the lounger to integrate perfectly into any atmosphere, making it a truly personalized highlight for any relaxation area.

### Features:

- Four actuators for adjusting the head, back, leg, and foot areas.
- Four pre-set positions
- Quilted PU upholstery
- Standard upholstery color: White. Other colors from our color collection for an additional charge
- Base in five standard decors (see page 19), optional in other decors
- Pull-out tray on both sides
- Optional LED reading light



- Lounger surface height: approx. 50 cm
- Length: 205 cm
- Width: 85 cm
- Load capacity of the table surface: 250 kg



Evo Lounger

4-actuator



# Evo Lounger



## Relaxing lounger comfort

With four actuators and a handheld remote control, the Evo Lounger can be easily adjusted for optimal lying comfort. The head section can be raised by 35°, the back by 50°, the leg section by 20°, and the foot section by 18°. In addition, the

upholstery adapts to each customer individually and thus provides an additional relaxation factor. And the practical trays on both sides of the lounger can be easily pulled out with a handle.



LED reading light

Equipped with a LED reading light, the lounge offers everything your customers need for a relaxing break (picture similar).



Pull-out tray

The pull-out tray on both sides is the perfect spot for setting something down or putting something away while reading with a wellness beverage.



Multimedia sound system







The integrated multimedia sound system allows you to load relaxing sounds and music on demand.



Easy to use

Three preset lounge positions can be accessed at the simple press of a button. Of course, the Evo Lounger is also individually adjustable.

Options (more info. after page 16)

-  Triple-Airback® technology: electro-pneumatic 3-zone lordosis support system of the upholstery ---
-  Smart-Thermo: programmable heating system with automatic shut-off ---
-  Vibro-Wellness: gently pulsating vibration system with many adjustment options ---
-  Color upholstery: PU (white or choco included in price), each color ---
-  Multimedia sound system Audio-Relax-Headrest ---
-  Decor surfaces our extended collection (standard collection: see page 19), ---

Accessories

- LED reading lamp ---
- Dentalax neck rest, PU ---
- Foot protective cover, PVC, transparent ---

# Jumeirah Beach Hotel Dubai, UAE





Photos: © Jumeirah Beach Hotel

# RLR & RL Aqua



RLR

In various colors

---

## Gharieni RLR

Our extremely comfortable and practical recliner presents itself as if made of one piece. With its sophisticated, elegant design and many color options, it fits into almost any ambience. The soft upholstery impresses with its excellent reclining properties as well as a durable, water-repellent cover with a pleasant feel. The ergonomic shape and the optional flexible reading lamp make the Gharieni RLR a first-class lounge for exclusive, spas, hotels and many other areas.



### Features:

- Modern design
- Robust manufacturing
- Pleasantly soft upholstery
- Easy-care, water-repellent cover
- Available in different colors
- Optionally with flexible reading lamp



Choose your favorite color from the RLR color palette or our standard upholstery colors (page 25)!

### Options (more info. after page 16)

-  Synthetic leather standard, per color ---
-  Synthetic leather Ferrari Stamskin Top, per color ---
-  Spa Ambience Light: Base with LED lighting ---

### Accessories

- LED reading lamp ---



- Height: 86 cm
- Length: 173 cm
- Width: 64 cm
- Load capacity of the table surface: 350 kg





# Gharieni RL Aqua

This lounger offers pure relaxation "with water." For the best possible comfort, the heated waterbed also has an intermediate layer of foam. The robust and easy-to-clean synthetic leather surface is available in various colors. Accessories include a matching cushion and a knee roll. The RL Aqua is available in different dimensions for an additional charge.

## Features:

- Heated water bed
- Soft intermediate layer of foam
- Easy-to-clean synthetic leather surface
- Standard upholstery color: White. Other colors from our color collection for an additional charge
- Base in five standard decors (see page 19), optional in other decors
- Optionally in various lengths and widths

RL Aqua

Including heating

,-,-

## Options (more info. after page 16)



Synthetic leather standard, per color  
Synthetic leather Ferrari Stamskin Top, per color

,-,-  
,-,-

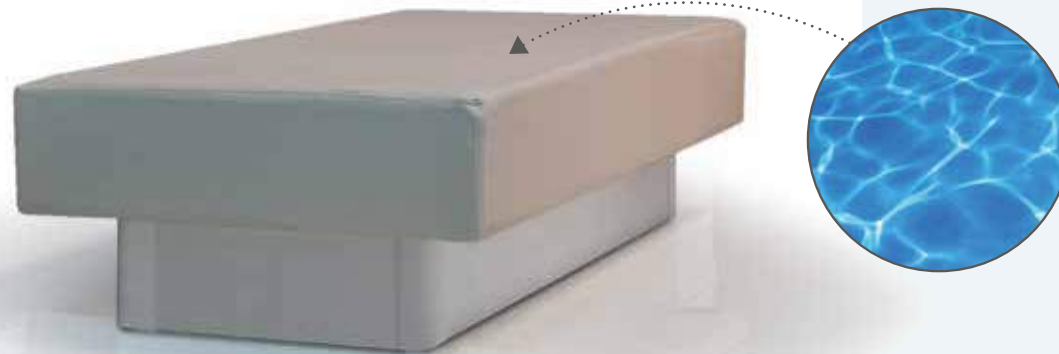

- Height: 49 cm
- Length: 202 cm
- Width: 91 cm
- Load capacity of the table surface: 160 kg

Aqua Sana Spa County Longford  
Ireland

Silence is golden...





Photos: ©Aqua Sana Spa County Longford

# RLX series



RLX Light

# Gharieni RLX Series

The RLX, with its soft and easy-to-clean synthetic leather upholstery is specially designed for the rest area of a spa. With its exceptional design and different equipment options, the lounge fulfills all desires. For example, the motorized tilt adjustment makes the RLX Electric a truly unique lounge. This lounge, like the RLX as well, can also come with heating upon request.

With optional reading light and removable neck cushion, the RLX models are the perfect solution for pleasant relaxation.

## Features:

- Lounge in three versions
- Extraordinary design
- Choose from numerous design variants
- Easy-to-clean synthetic leather cover
- Standard upholstery color: White. Other colors from our color collection for an additional charge
- RLX Electric with electrical lounge surface adjustment
- Firm lounge surface position on RLX and RLX Light
- Heating optional for RLX and RLX Electric lounge surface
- Choose from short or long standpipes at the base
- Optional color-matched neck rest
- Optional LED reading light

### RLX + RLX Electric

- Access height: 45 cm
- Projection length: 190 cm
- Width: 70 cm
- Load capacity of the table surface: 160 kg



### RLX Light

- Access height: 38 cm
- Projection length: 174 cm
- Width: 66 cm
- Load capacity of the table surface: 160 kg



RLX Electric

1-actuator



RLX

Without actuators



RLX Light

Without actuators



# RLX series



## The models to choose from

With their high-end design and high degree of quality, the RLX models truly stand out. While the position of the lounge surface is fixed with the RLX and RLX Light, on the RLX Electric the lounge surface can be electrically adjusted. You're not just choosing "your" model, but also the best upholstery color and coating of the metal parts for your atmosphere –

for your relaxation area's perfect look. With optional extras such as the Smart Thermo heating system for a comfortable temperature of the lounge surface, downtime on the RLX for your customers becomes a real relaxation experience!



LED reading lamp

The optionally available LED light for reading makes relaxation time on the RLX even more enjoyable for your customers. Its flexible neck makes it easy to put it in the right position..



Removable neck cushion

The neck cushion, which can be easily removed if necessary, offers perfect lying comfort. It can be optimally positioned via a Velcro fastener.



Standpipes in various lengths



Select the length of your standpipes and thus the design of your lounger model. By the way: For an appealing look, the color of the standpipe end caps corresponds to that of the lounger upholstery.



Especially stable

An elegant appearance combined with maximum stability - this is ensured by the sophisticated metal construction of the RLX. This can optionally be coated in your personally favorite color.

Options (more info. after page 16)

- 
Smart-Thermo: programmable heating system with automatic shut-off (nicht bei RLX Light)
,-,-
- 
Color upholstery: max. 2 different colors  
Synthetic leather standard, per color  
Synthetic leather Ferrari Stamskin Top, per color
,-,-  
,-,-
- 
Metal parts in special colors (white, titanium, or dark brown are included in the table price)
,-,-

Accessories

- Neck cushion, white
,-,-
- Neck cushion, in colors
,-,-
- LED reading lamp
,-,-

# HOTEL NIKKI BEACH MONTENEGRO







# Massage Tables



Gharieni  
MLW Transform



Gharieni  
RLL



Gharieni  
ML series



Gharieni  
Ayurveda



Gharieni  
Shiatsu mat

# MLW Transform



# Gharieni MLW Transform

The MLW Transform gives the term "feel-good sofa" a whole new dimension, because this high-end couch transforms into a massage table in no time.

The massage table, with its independent battery and pull-out cable is of course height-adjustable and can be heated for a cozy, feel-good experience. For optimum comfort, the head section can also be adjusted for height and inclination. If you need more seat space, the three cushions on the backrest of the couch can simply be removed. The high-quality, elegant synthetic leather cover of the upholstery is available in various decors and colors. For a very personalized look, the sofa can also be equipped with a leather cover or a (customer's) cover fabric on request.

## Features:

- Massage table and sofa in one
- Pull-out massage table
- Height electrically adjustable
- Electrically extending lightweight castors
- With integrated battery and power connection
- Removable, crescent-shaped head section
- Storage compartment in the base
- Robust synthetic leather upholstery in black
- Optional in various decors, leather, or (customer's) cover material
- Three removable cushions on the backrest

### MLW Transform

Sofa-massage table combination	,-,-
Individual massage table	,-,-
Sofa as purely seating furniture	,-,-



- Couch height: approx. 80 cm
- Table height: approx. 45-75 cm
- Couch width: approx. 212 cm
- Spa Table:
- Length without head section: approx. 166 cm
- Couch depth: approx. 87 cm
- Spa Table: Width approx. 75 cm
- (Recommended) lifting capacity: 250 kg
- Load capacity of the table surface: 300 kg

# MLW Transform

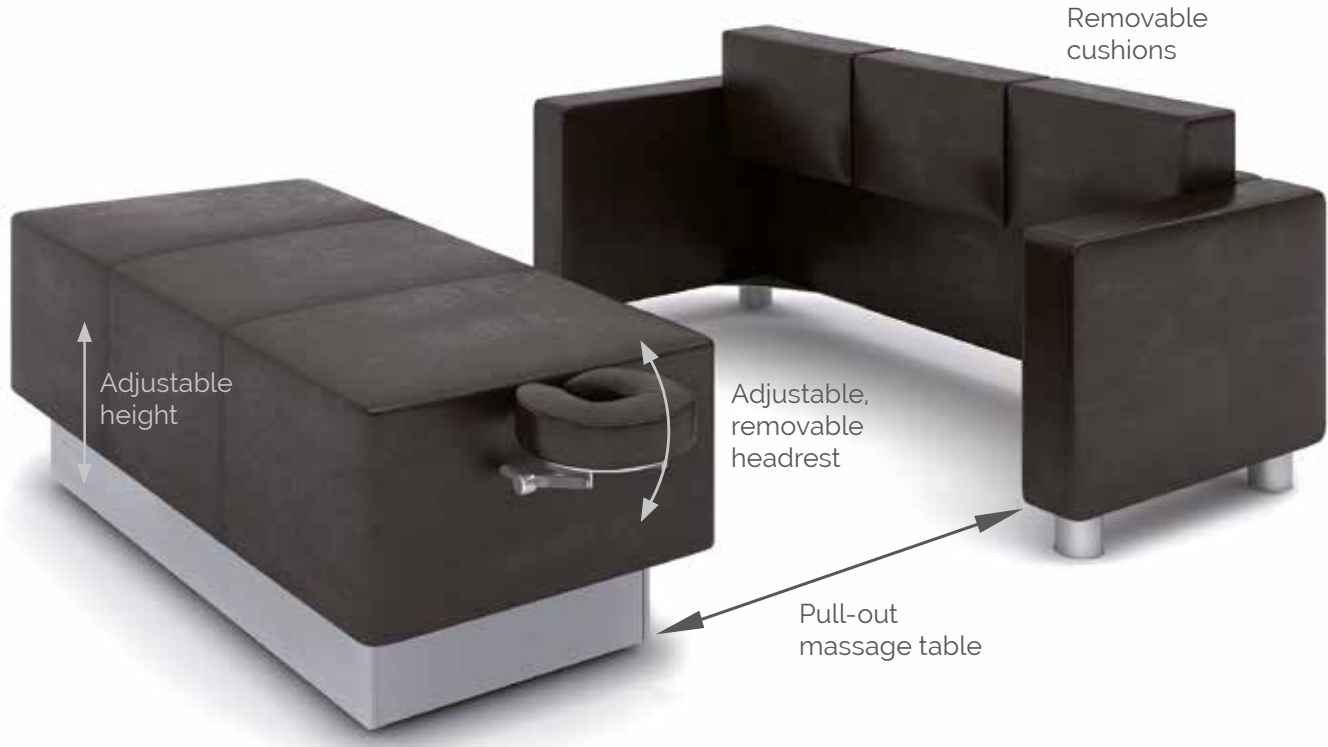

### Two-in-one

The high-end "feel-good sofa" can easily transform into a massage table: Pull out with the electrically retractable light-weight castors and attach the adjustable crescent-shaped head section – done! For massage treatments, the height can be adjusted electrically from 45-75 cm. In addition to a

cord connection, the MLW Transform also has a battery and can thus be used away from a wall power outlet. With the optional Smart-Thermo feature, you can also ensure a cozily warm table experience during operation while plugged in.



Flexible headrest

The crescent-shaped, adjustable headrest is easy to put on – the massage table is ready!



Practical storage compartment

With a practical storage compartment in the base of the massage unit, the headrest is always ready at hand.



Battery operation



With its integrated battery, the MLW Transform can be used independently of a wall power outlet. It is charged via the pull-out power cord.



Easy to use

Thanks to the integrated touch panel, the electrically extendable lightweight castors can be easily activated and the height of the table surface can be adjusted.

Options (more info. after page 16)

-  Color upholstery: max. 2 different colors  
Synthetic leather Ferrari Stamskin Top, per color ;-)
-  Decor surfaces: our extended collection (standard collection: see page 19), ;-)

# RIL





# Gharieni RLL

As a massage table, Gharieni RLL with its double lifting column technology allows quick and easy adjustment without any effort. At the same time, its base with solid steel construction ensures maximum stability. In terms of technology and functionality, the RLL can be customized. For example, it can be equipped with "Smart-Thermo", an integrated heating system for a pleasantly tempered lying surface.

## Features:

- Massage bench with double lifting column technology
- Base with solid steel construction for maximum stability
- Electrical height adjustment
- Back section adjustable via pneumatic spring
- With classic synthetic leather
- Standard upholstery color: White. Other colors from our color collection for an additional charge







RLL  
1-actuator -,-



- Height: 57-103 cm
- Length: 198 cm
- Width: 75 cm
- Head section length: 66 cm
- Table surface length: 132 cm
- (Recommended) lifting capacity: 300 kg
- Load capacity of the table surface: 350 kg

## Options (more info. after page 16)

-  Smart-Thermo: programmable heating system with automatic shut-off -,-
-  Synthetic leather standard, per color -,-  
 Synthetic leather Ferrari Stamskin Top, per color -,-
-  Logo embroidery: depending on effort, -,-
-  Metal parts in special colors (white, titanium, or dark brown are included in the table price) -,-
-  Foot switch to control the basic functions -,-

## Accessories (see also page 184)

- Dentalax neck rest, synthetic leather -,-
- Gel cushions for the face cradle -,-
- Terrycloth (white, macchiato, or choco) -,-

# ML series



# Gharieni ML series

All tables in the ML series are electrically height-adjustable. The head section can be inclined pneumatically via pneumatic spring by +/-30°. In the two-actuator version, the head area of the MLK can be adjusted electrically as well as on the MLL. The MLK ABS and MLK Physio are equipped with arm supports that can lower you for prone treatments, while the MLL offers a larger head section. The base is available in both white (standard) and titanium (optional).

## Features:

### MLK ABS

- Electrical height adjustment
- Lowerable arm supports
- Head section with face cradle inclinable +/-30°
- White synthetic leather upholstery, optional in other colors

### MLK Physio

- Electrical height adjustment
- electrical adjustment of the elevated center position
- Lowerable arm supports
- Head section with segmented face cradle inclinable +/-30°
- White synthetic leather upholstery, optional in other colors

### MLK

- Electrical height adjustment
- Head section with face cradle inclinable +/-30° via pneumatic spring (optional electric)
- White synthetic leather upholstery, optional in other colors
- Short head section with face cradle

### MLL

- Electrical height adjustment
- Head section inclinable +/-30° via pneumatic spring (optional electric)
- White synthetic leather upholstery, optional in other colors
- Long head section with face cradle



- Height: 61-91 cm
- Length: 196 cm
- MLK (ABS) head section length: 42 cm
- MLL head section length: 67 cm
- Width: 70 cm
- (Recommended) lifting capacity: 200 kg
- Load capacity of the table surface: 250 kg



MLK ABS

1-actuator (height)

,-,-



MLK Physio

2-actuator (height, elevated center)

,-,-



MLK

1-actuator (height)

,-,-

2-actuator (height, head section)

,-,-



MLL

1-actuator (height)

,-,-

2-actuator (height, head section)

,-,-

# ML series



## The massage specialists

The "MLK ABS," "MLK Physio," "MLK," and "MLL" massage tables are electrically height-adjustable from 61-91 cm and their head section can be tilted via pneumatic spring; on the MLL and MLK this is +/- 30° also possible electrically on

the two-actuator version. The MLK ABS and MLK Physio are also equipped with lowerable arm supports, with the MLK Physio also having a segmented table surface for setting an elevated center position.

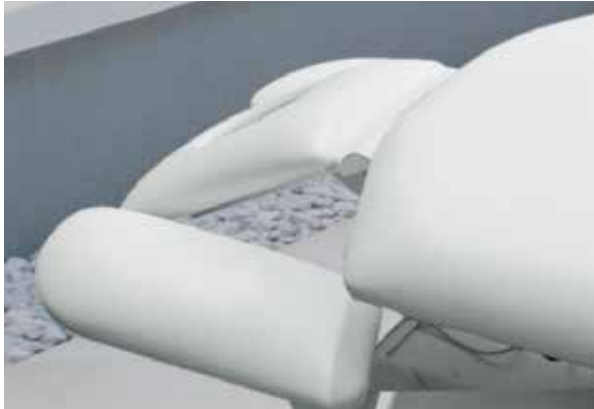

For prone treatments

The MLK ABS and MLK Physio models are equipped with lowerable arm supports and a downwards and upwards tilting headrest with face cradle. This makes them suitable for all prone treatments.



Special elevated center position

To provide relief for your customer's lumbar spine area, the table surface can be brought into an elevated center position by the actuator on the MLK Physio.



Paper roll holder







With a paper roll holder mounted at the foot of the table, you can always pull protective paper over the table.



Everything within reach

The compartment under the MLK and MLK ABS serves as a handy storage space, e.g. for hand towels. If necessary, the compartment can be supplemented with a second shelf.

Options (more info. after page 16)

-  Smart-Thermo: programmable heating system with automatic shut-off ,-,-
-  Color upholstery: max. 2 different colors ,-,-  
 Synthetic leather standard, per color ,-,-  
 Synthetic leather Ferrari Stamskin Top, per color ,-,-
-  Logo embroidery: depending on effort, ,-,-
-  Base casing in titanium color ,-,-
-  Castor set, brakable, Art. 73006 ,-,-
-  Foot switch to control the basic functions ,-,-  
 on the single-actuator version ,-,-  
 on the two-actuator version ,-,-

Accessories (see also page 184)

- Dentalax neck rest, synthetic leather ,-,-
- Dentalax neck rest, PU ,-,-
- Gel cushions for the face cradle ,-,-
- Terrycloth (white, macchiato, or choco) ab ,-,-

# Thalassozentrum ahoi! Cuxhaven, Germany



Photos: © Nordseeheilbad Cuxhaven GmbH

# Rogner Bad Blumau Austria



Photos: © Rogner Bad Blumau @ Hundertwasser Architekturprojekt



# Ayurveda Table

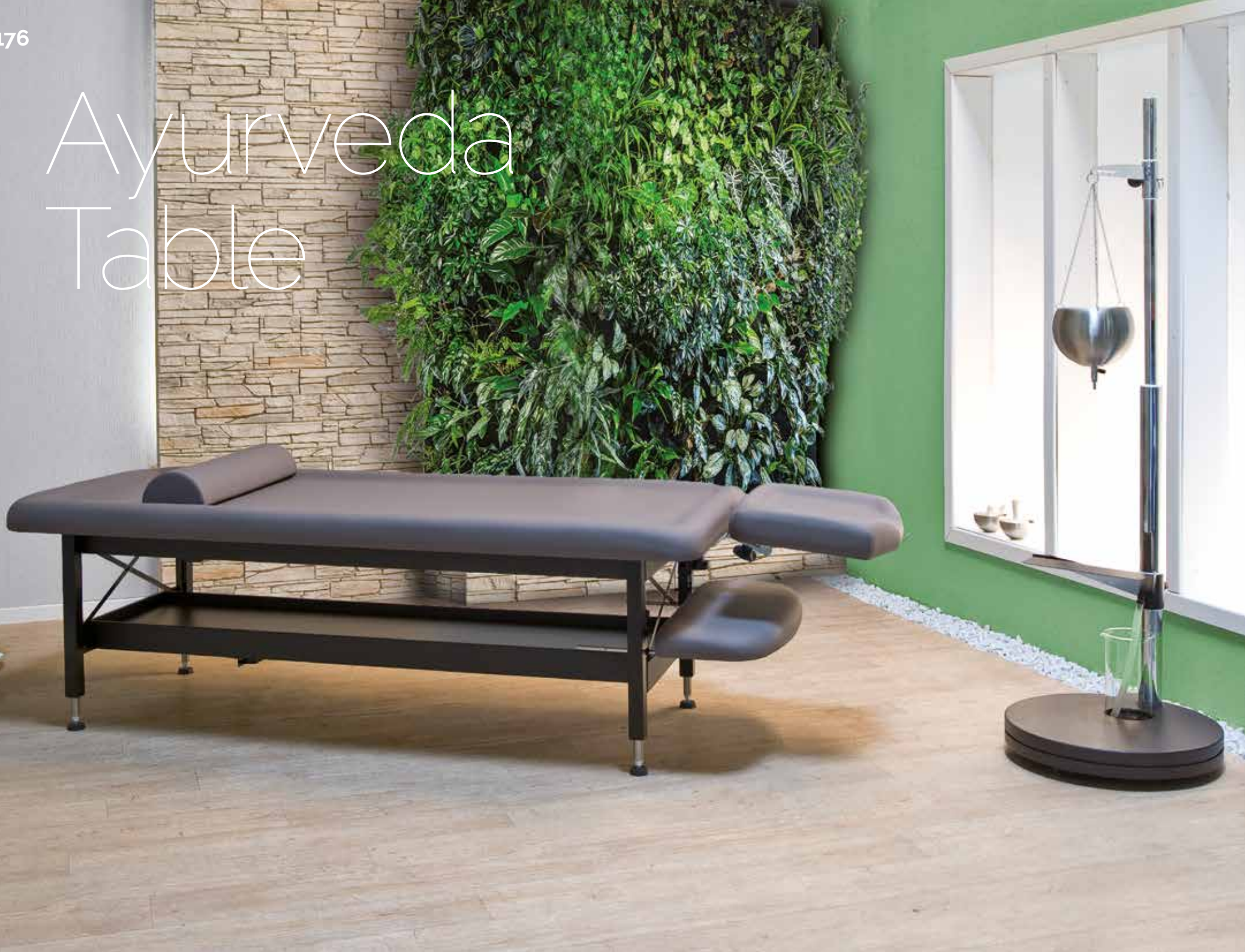



# Gharieni Ayurveda Table

Thanks to its special design, this table is suitable for all Ayurvedic treatments. The upholstery features a raised edge for use with larger quantities of oil and an oil-resistant PU cover. The accompanying four-piece PU accessory set consists of an Ayurveda half roll, a crescent-shaped massage headrest, an arm support, and a headrest with drainage device.

The table height can be manually adjusted hydraulically or electro-hydraulically. The large shelf below the bed can be used for everything you need for treatment.

## Features:

- Upholstery especially for Ayurvedic treatment methods
- Elevated upholstery edge for use of larger amounts of oil
- Oil-resistant PU cover
- With hydraulic, electro-hydraulic or without height adjustment
- Four-piece PU accessory set with Ayurveda half roll, special headrest with drain, crescent-shaped massage headrest, and arm support

### Ayurveda Table

Electrohydraulic, Art 49043	,-
Hydraulic, Art 49042	,-
w/o height adjustment, Art 49040	,-



- Height (without edge): 58-88 cm
- Length: 200 cm
- Width: 85 cm
- Lifting capacity: 200 kg
- Load capacity of the table surface: 200 kg

# Ayurveda Table



The oil can flow here

The height of the Ayurveda table can be adjusted hydraulically by hand crank or electro-hydraulically by pressing a button from 58 -88 cm. The headrest can be tilted up

and down and the arm support can be attached at different heights. For the use of larger quantities of oil, the seat cushion is equipped with a raised edge and an oil-resistant PU cover.



Perfect for oil treatments

The head section is designed so that the oil can run off cleanly during forehead pouring.



Headrest for massages

With the crescent-shaped, tiltable, and removable headrest with face cradle, massage treatments can also be performed prone.



Pull-out arm support

The arm support can be mounted at two different heights or completely removed. There is enough space there if the customer is lying prone.



Practical storage shelf

On the surface below the table, you can store or set aside everything important for your treatments.

Options (more info. after page 16)



Smart-Thermo: programmable heating system with automatic shut-off

,--

Accessories (see also page 184)

Oil-resistant protective cover, washable, choco, Art. 49051

,--

Face cradle towels, 100 pieces, Art. 45305

,--

Washable fleece, 10 pieces, Art. 45302

,--

Fleece cover, 10 pieces, Art. 45303

,--

# Four Seasons Limassol Cyprus





Photos: © Four Seasons Limassol



# Shiatsu mat





# Gharieni Shiatsu mat

Do you prefer relaxing shiatsu massages, a form of energetic body work developed in Japan? Then we have a practical solution for you: A Shiatsu mat with skin-friendly and hygienic PU cover in the color Choco. The mat with firm foam filling is collapsible and the optional real wood frame is easy to share. In addition, the high-end frame is available in different colors. On request, it can also be equipped with an LED light bar. This way you can create a very special, atmospheric ambience!

## Features:

- Collapsible
- Firm foam filling
- PU cover optional in five different colors
- Optional high-end real wood frame in different colors
- LED light bar optional

## Options (more info. after page 16)

-  Color upholstery PU: max. 2 colors possible, each color ,-
-  Other frame woods and coatings ,-
-  LED lighting in the frame ,-



- Mat thickness: 8 cm
- Width: 180/90 cm
- Depth: 200 cm



Shiatsu mat	
Without frame	,-
With frame	,-

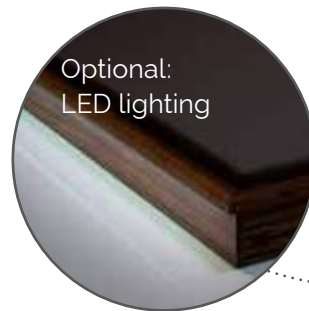

Optional:  
LED lighting



# Massage Tables Accessories

## Upholstery Covers

With the specially adapted covers your massage table is always well protected against different types of stress. The table-specific covers are an exact match to the individual upholstery segments.

Thanks to the high-quality terrycloth material, machine washing up to 60° C is possible and therefore hygienic cleaning is possible. With their integrated elastic bands, the individual segments stay exactly where they belong, thus preserving the function of the tables.

Our covers are available in three colors: White, choco, and macchiato.

It is best to order the right cover directly when you buy your table. Our team would be happy to help you decide!

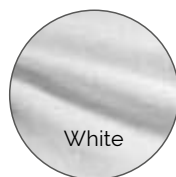

White



Macchiato

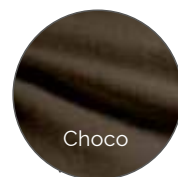

Choco



## Roll holder including 1 paper roll

The optional paper roller provides you with a practical, disposable protection for your table. As needed, the 50 cm wide paper is unrolled and pulled over the lying surface. After use simply tear it off at the perforation line and discard. A neat thing!

Roll holder 1 paper roll, 60 cm width, Art. 42068/60 -,-

Roll holder 1 paper roll, 70 cm width, Art. 42068/70 -,-

Sanitary paper rol, 50 x 0,5 m, Art. 42065, up to 8 pieces, ea. -,-

Sanitary paper rol, 50 x 0,5 m, Art. 42065, 9 pieces, ea. -,-





## Face cradle towels

Extra soft, slotted fleece disposable towel to protect the headrest; extremely practical and hygienic. Recommended for all headrests with face cradle. Size: 30 x 21 cm

Package with 100 items, Art. 45305

---



Practical disposable towel specially for u-shaped headrests. Thanks to the one-sided opening in the towel, it can be perfectly adapted to the massage head rest.

Package with 100 items, Art. 45301

---



## Cover towel with face cradle, large

There is this special single-use cover towel with face cradle for improved hygiene. The special thing about it: its width not only protects the headrest but also the arm supports against contamination. Ideal for all our tables with lowerable arm supports or wide head sections. Size: 130 x 35 cm

Package with 50 items, Art. 45310

---



## mikrozyd® sensitive

For the gentle and thorough care of our upholstery we recommend mikrozyd® sensitive. Available as liquid or ready-to-use cloths in a handy dispenser, it eliminates bacteria, fungi, and viruses (such as HBV, HIV, Rota, vaccinia). Without alcohol!

mikrozyd® sensitive wipes, Art. 79418

---

mikrozyd® sensitive liquid, Art. 79417

---

## Washable fleece

Practical and comfortable cotton wool table cover. The material is washable up to 10 times. 80 x 200 cm

Package with 10 pieces, Art. 45302

---



# Treatment Beds

Our treatment beds are functional and flexible. The seats are versatile and adjustable and can be controlled by hand switch. Depending on the bed model, up to eight positions can be saved via memory function. The quality actuators from Linak have the "Spline" safety feature, which prevents the danger of crushing on moving parts. For non-actuator-driven table parts, Stabilus pneumatic springs provide easy adjustment without much effort.

The construction of the tables was designed taking ergonomic aspects into account. Numerous elaborate details, such as the optional Rotonde turning function, make the job easier. Pull-out head and foot sections provide comfort to customers of all body types.

A particular highlight is the Airback®, a lumbar support system whose adjustment is controlled by air pressure via a

hand pump. Airback® comes standard in all treatment beds. The treatment beds always come equipped with a white Gharieni synthetic leather upholstery. Here you can choose from a large number of colors in addition to the standard

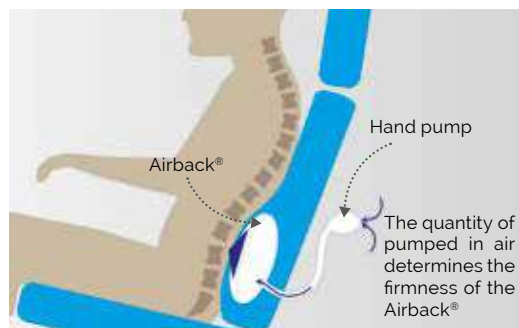

equipment. These can be found in the rear flap of the catalog. Choose your favorite from the Gharieni color chart or from the exclusive Ferrari Stamskin top collection! On some bed models, you can put together your own personalized bed from up to three different colors. The casing is made from robust, easy-to-clean, and colorfast plastic. It is available on almost all models in addition to the standard white in titanium.

The options table will show you which equipment options you have that can be found on the corresponding beds. The individual options are then page 16 explained from there. You can find an extensive list of accessories at the end of each bed section.



Gharieni  
Lina Select series



Gharieni  
601 series



Gharieni  
SPL series



Gharieni  
SL XP series



Gharieni  
SLR



Gharieni  
Hydraulic series

# Lina Select series



## Lina Select series

Slim, elegant design, maximum comfort and variability. – Our Lina Select series is the ultimate for you as a beautician! Because the innovative Lina's program is "Select," which combines optimal working and table comfort as well as individual versatility.

You can thus choose from the following versions of the one-piece upholstery cover with memory foam:

- Standard – the perfect "bottom layer" for massages
- Soft – for even more comfort, even with time-consuming cosmetic treatments

Particularly practical: On all models, the armrests for massage treatments feature double-sided upholstery and can be folded down. In addition, the head and foot sections can be pulled out and removed. And of course you can adjust the height, inclination, back, and leg sections electrically and store up to four positions. In addition, the bed can be equipped with the upholstery-warming Smart-Thermo heating system. All Lina Select models are also available as Podo version with segmented foot section.

## Gharieni Lina Select Alu

The Lina Select Alu features a sophisticated designer aluminum base with upholstery or wood applications.

### Features:

- Metal-clad base in the colors titanium, white or black (optionally in aluminum)
- With side wood or synthetic leather applications
- Pull-out and removable head and foot sections
- Electrical height, back, and seat adjustment
- Including designer hand switch with memory function to store four bed positions
- Fold-back armrests upholstered on both sides
- Upholstery with a memory foam layer
- Upholstery sewn into one piece
- "Airback" lordosis support system integrated into the upholstery (see page 186)



- Height: 54-96 cm
- Bed surface length: max. 202 cm
- Width without/with armrests: 62/80 cm
- Lifting capacity: 200 kg
- Load capacity of the seat: 250 kg



Lina Select Alu  
with standard upholstery



Lina Select Alu including  
Alu Design hand switch

### Lina Select Alu

4-actuator, incl. designer hand switch



Lina Select Alu  
with Soft upholstery

## Gharieni Lina Select Wood

Equipped with the same features as the other Lina Select models, the Lina Select Wood has a delicate, yet stable base. The foot is available in one of our numerous wood decors. This allows the bed to be perfectly adapted to your interior design – giving your workspace a particular bit of elegance.

### Features:

- Delicate base in five standard decors (see page 19)
- Additional decors optionally available
- Pull-out and removable head and foot sections
- Height, back, seat inclination, and leg section electrically adjustable via hand switch
- Upholstery sewn into one piece
- Standard upholstery color: White and choco.
- Other colors from our color collection for an additional charge
- With a memory foam layer
- Fold-back armrests upholstered on both sides
- "Airback" lordosis support system integrated into the upholstery (see page 186)
- optional: hand switch with memory function for saving four bed positions



Lina Select Wood  
with standard upholstery

Lina Select Wood

4-actuator

---



Lina Select Wood  
with Soft upholstery



- Height: 54-96 cm
- Bed surface length: max. 202 cm
- Width without/with armrests: 62/80 cm
- Lifting capacity: 200 kg
- Load capacity of the seat: 250 kg

## Gharieni Lina Select Static

With its one-pillar technology and solid floor installation, the Lina Select Static looks particularly elegant. At the same time it gives you practical legroom with maximum stability. In addition, this model has the same features as the "Wood" and "Alu."

### Features:

- Bolted to the floor for maximum stability and legroom
- Four-actuator
- Height, back, seat inclination, and leg section electrically adjustable via hand switch
- Pull-out and removable head and foot sections
- Upholstery sewn into one piece
- Standard upholstery color: White and choco. Other colors from our color collection for an additional charge
- With a memory foam layer
- Fold-back armrests upholstered on both sides
- "Airback" lordosis support system integrated into the upholstery (see page 186)
- optional: hand switch with memory function for saving four bed positions



Lina Select Static  
with standard upholstery

Lina Select Static

4-actuator



Lina Select Static  
with Soft upholstery



- Height: 54-96 cm
- Bed surface length: max. 202 cm
- Width without/with armrests: 62/80 cm
- Lifting capacity: 200 kg
- Load capacity of the seat: 250 kg

# Lina Select series



## Extraordinarily variable

All of the Lina Select series models are extraordinarily versatile. The height is adjustable from 54-96 cm and the head and foot sections can each be pulled out by 10 cm. The backrest can be set up to 70° and the seat can be tilted by

25°. In addition, the leg area can be tilted down by 75°. And for massage treatments, the double-upholstered arm supports can be folded down.





High-end application

The sides surfaces of the foot of the Lina Select Alu feature the same synthetic leather as the bed upholstery. Optionally, however, it is also possible to choose an elegant wood decor.



Usable on both sides

Particularly practical: On all Lina Select models, the armrests feature double-sided upholstery and can be folded down. This allows them to be used for prone massage treatments.



Lightweight, elegant, & stable













The foot of the Lina Select Wood looks elegant, but at the same time it is extremely stable. With a wood decor of your choice, the bed can be perfectly adapted to the ambience of your workspace.



Dentalax Neck Rest

Indispensable for a pleasant treatment: the Dentalax neck rest. It supports the position of the neck and the head and thus ensures maximum comfort.

Options (more info. after page 16)

-  Soft Upholstery ,-,-
-  Smart-Thermo: programmable heating system with automatic shut-off ,-,-
-  Vibro-Wellness: gently pulsating vibration system with many adjustment options ,-,-
-  Color upholstery:  
 PU (white or choco included in price), each color ,-,-  
 Synthetic leather standard, per color ,-,-  
 Synthetic leather Ferrari Stamskin Top, per color ,-,-
-  Logo embroidery: depending on effort, ,-,-
-  XL Extension Attachment to expand the bed in the upper back area ,-,-
-  Color XL Extension: max. 2 diff. colors  
 Synthetic leather standard, per color ,-,-  
 Synthetic leather Ferrari Stamskin Top, per color ,-,-
-  Base parts made of aluminum (only for Select Alu) ,-,-  
 Metal parts in special colors (white, titanium, or dark brown are included in the table price) ,-,-
-  Decor surfaces our extended collection (standard collection: see page 19), ,-,-
-  Hand switch with memory function: up to four table positions can be stored (included in the price for Lina Select Alu) ,-,-
-  Castor set, brakable, Art. 73006 ,-,-
-  Foot switch memory function: for controlling the basic functions and the memory positions ,-,-

Accessories (see also page 218)

- Dentalax neck rest, synthetic leather ,-,-
- Dentalax neck rest, PU ,-,-
- Terrycloth (white, macchiato, or choco) ,-,-
- Foot protective cover, PVC, transparent ,-,-

# BABOR Amsterdam Netherlands





Photos: © BABOR/Alexander Sporre Photography

# 601 series



# Gharieni 601

The Gharieni 601 combines the best features of a spa table and treatment bed in one: comfort, stability and practical handling are the main features of this double lifting column supported combination table. Whether cosmetic treatments, make-up, haircare, massages, pedicures or manicures, the 601 always performs well. The multifunctional, removable head and arm rests make it one of our most variable treatment tables.

## Features:

- Double lifting column technology for extreme loads
- Fully electrically adjustable
- Upholstery of the treatment bed available in three widths: 75 cm (small), 80 cm (medium-small) and 85 cm (medium)
- Upholstery available in two thicknesses: standard and soft
- Three different headrests possible::
  1. Dual headrest with interchangeable face cradles
  2. U-shaped face cradle
  3. Standard headrest with face cradle
- Fold-away head rest for free access to the head and neck (e.g. for hair wash)
- Thermal heatable surface to keep clients cozy and comfortable.
- Swiveling, detachable side armrests for easy access
- Laterally swiveling and lowerable arm support at the head section for effective massages
- Can be operated via hand or foot switch
- Four preset and two freely storable memory positions
- 30 minutes automatic operation safety lock
- Mountings for magnifying lamps
- Mountings for manicure bowls under the lateral armrests
- Available in many different finishes and fully customizable to any décor.
- Also available as High Performance version with approx. 60% more lifting force and 25% higher speed



- Height: approx. 59 cm - 99 cm (Standard upholstery)
- Length: max. 200 cm
- Width (without armrests): 75/80/85cm
- Lifting capacity: 250 kg/400 kg (High Performance)
- Load capacity of the table surface: 300 kg / 450 kg (High Performance)



601 with  
arm supports



601 with lateral  
armrests without  
headrest



601 with standard  
upholstery



601 High Performance  
with Soft upholstery

### 601

(without armrests/arm supports/headrest)

Small (width: 75 cm)	5,--
Medium-Small (width: 80 cm)	5,--
Medium (width: 85 cm)	5,--

### 601 High Performance

(without armrests/arm supports/headrest)

Small (width: 75 cm)	5,--
Medium-Small (width: 80 cm)	5,--
Medium (width: 85 cm)	5,--

Standard headrest	5,--
U-shaped face cradle	5,--
Dual headrest	5,--
Lateral armrests (pair)	5,--
Arm supports at head section (pair)	5,--

## 601



## Practical &amp; versatile

In terms of adjustability, versatility and ergonomics, the 601 meets the highest demands. The headrest can be tilted by  $-90/+10^\circ$  and extended by up to 15 cm. Two lifting columns allow the height to be electrically adjusted from 59-99 cm, the

back and foot sections can be adjusted by  $70^\circ$  and  $91^\circ$  respectively, and the armrests can be swiveled back by  $180^\circ$  cm. The lying surface can be tilted by  $\pm 25^\circ$  and extended by approx. 10 cm with the adjustable foot section.





Three different headrests







In addition to the standard headrest, the 601 can be equipped with two other variants: the Dual, with an exchangeable round or crescent-shaped face cradle or U-shaped headrest



Adjustable armrests

For optimal adaptation to the customer, the armrests can be moved outwards. Thus, the 601 offers even more comfort for every body type..

Options (more info. after page 16)

-  Soft Upholstery ,--
-  Thermo: three-stage heating system with automatic switch-off ,--
-  Color upholstery:  
 PU, each color ,--  
 Synthetic leather standard, per color ,--  
 Synthetic leather Ferrari Stamskin Top, per color ,--
-  Metal parts in special colors (white, titanium, or dark brown are included in the table price) ,--
-  Decor surfaces our extended collection (standard collection: see page 19), ,--
-  Foot switch memory function: for controlling the basic functions and the memory positions ,--
-  Castor set, brakable, Art. 73006 ,--



Paper roll holder

With a paper roll holder mounted on the back of the couch, you can always pull protective paper over the treatment bed.



Holder for (magnifying) lamps

A surprising and handy feature is the extendable magnifying lamp holder made of stainless steel. Designed to fit the Circle LED magnifying lamp, it simply disappears under the bed when not in use.

Accessories

- Dentalax neck rest, synthetic leather ,--
- Dentalax neck rest, PU ,--
- Roll holder 1 paper roll ,--
- Gel cushions for the face cradle ,--
- Terrycloth (white, macchiato, or choco) ,--
- Foot protective cover, PVC, transparent ,--
- Double-sided (magnifying) lamp mount ,--
- LED Magnifying Lamp "Circle" ,--
- Manicure bowl holder (both sides) ,--

# SPL series





## Gharieni SPL series

If you are looking for a solid treatment bed, our "SPL" and "SPL Soft" are just right for you. With their four actuators, the two bed models can be adjusted as quickly as you want: From starting position to the classic treatment position, to the massage position, you can save up to eight different settings and retrieve them simply by pressing a button. With the "Standard" and "Soft" upholstery versions, the two beds offer different degrees of firmness especially for your treatments. Fold-down armrests as well as a lower bed access height make it easier for shorter customers to step up. At the same time, the pull-out headrest and footrest offer taller people optimal comfort. The seat surface rotates thanks to the optional Rotonde function. This gives you even more flexibility when working. You can choose the color of the bed upholstery – for the best look to match the ambience of your workspace – from our large PU and synthetic leather collection. The SPL is also available as a Podo version.

### Features:

- Four particularly quick actuators
- Height, inclination, as well as back and leg areas are electrically adjustable.
- Fold-down armrests
- Pull-out headrest and footrest
- "Airback" lordosis support system integrated into the upholstery (see page 198)
- Spline safety actuators to avoid the danger of crushing
- Optional Rotonde seat surface rotating function
- Bed surface available with Standard and Soft upholstery
- Upholstery made from PU (Soft version) or synthetic leather
- Standard upholstery color:  
Synthetic leather: White, PU: White and Choco  
Other colors from our color collection for an additional charge
- Multicolor upholstery also possible
- Base in white or titanium



- Height: 59 cm – 100 cm
- Length: 144 cm – 203 cm
- Width without/with armrests: 62 / 80 cm
- Lifting capacity: 200 kg
- Load capacity of the seat: 250 kg

SPL

4-actuator



SPL with Standard upholstery



SPL with Soft upholstery



# SPL series

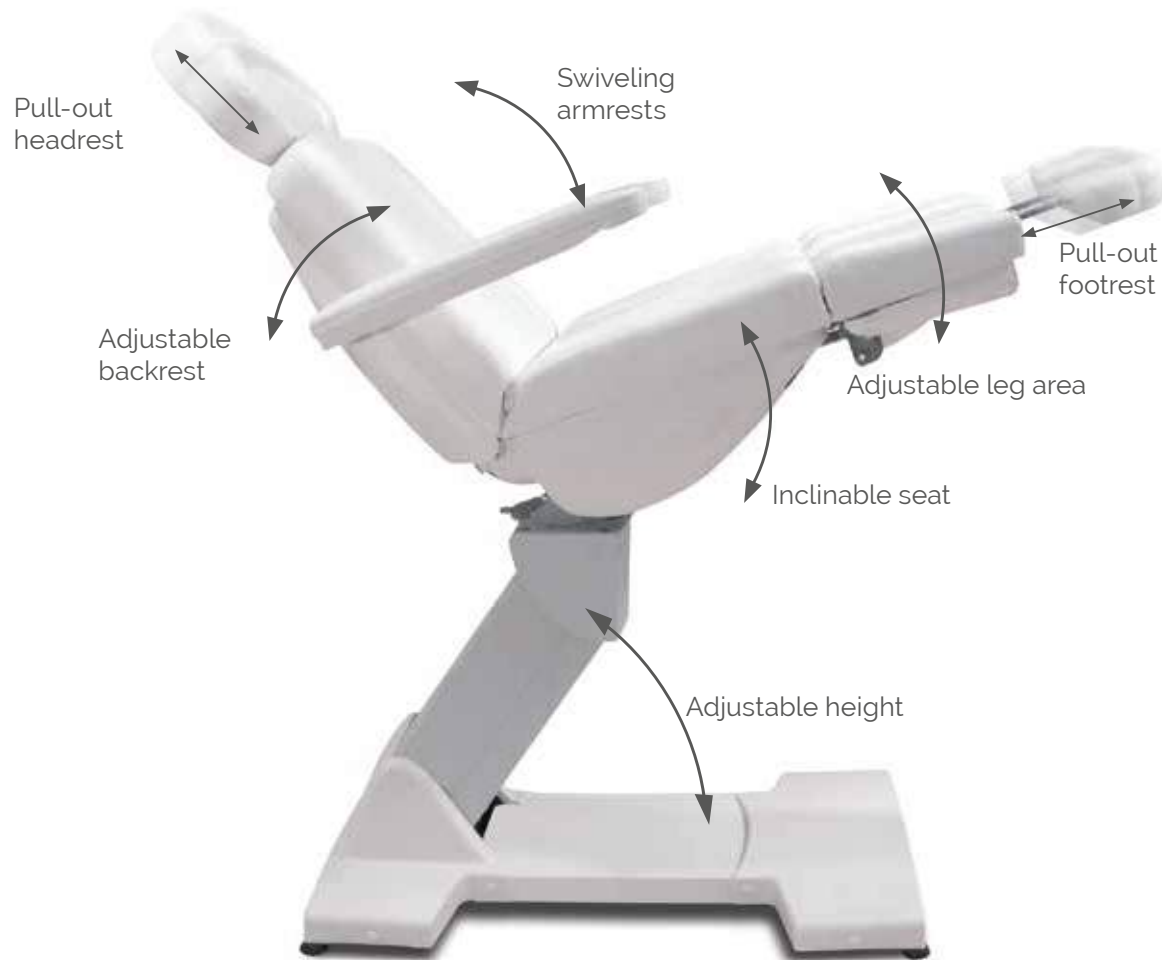

For all cosmetics treatments

The SPL and SPL Soft can be perfectly positioned for your cosmetic treatments. So you can adjust the chair height to 63-100 cm, set the backrest to 70°, tilt the seat by 25°, and

adjust the leg range from 0 to -90°. Headrest and footrest can be extended by 10 cm and the armrests can be swiveled backwards.





### Rotonde function

This feature allows the seat to be turned left or right by up to 330°. By means of the side-mounted locking it can be easily fixed in any position.



### Headrest with XL extension

The adjustable and retractable XL extensions is a support surface for the arms, especially for prone body massages.



### Manicure bowl









As with many other Gharieni treatment beds, the SPL also allows the installation of a detachable manicure bowl on the armrest (Exception: Soft upholstery).



### Footrest

This practical chrome-plated footrest protects the plastic casing of the base from mechanical wear and tear and dirt during head-side treatments.

### Options (more info. after page 16)

-  Soft Upholstery ,--
-  Airback elektrisch: elektro-pneumatisches Lordosen-Unterstützungssystem des Polsters ,--
-  Smart-Thermo: programmable heating system with automatic shut-off ,--
-  Vibro-Wellness: gently pulsating vibration system with many adjustment options ,--
- Color upholstery:
  -  PU (white or choco included in price), each color ,--
  - Synthetic leather standard, per color ,--
  - Synthetic leather Ferrari Stamskin Top, per color ,--
-  Logo embroidery: depending on effort, ,--
- Multifunctional headrest:
  -  Joint mounting, stainless steel ,--
  - Crescent-shaped attachment ,--
  - U-shaped attachment ,--
-  XL Extension Attachment to extend the table in the upper back area ,--
- Color XL Extension: max. 2 diff. colors
  -  Synthetic leather standard, per color ,--
  - Synthetic leather Ferrari Stamskin Top, per color ,--
-  Audio-Relax-Headrest: with integrated speakers to connect to common players ,--
-  Rotonde 330° (approx. 2 cm higher table access height): Seat rotatable by 330° ,--
-  Casing in titanium color ,--
-  Castor set, brakable, Art. 73006 ,--
-  Foot switch to control the basic functions ,--

### Accessories (see also page 218)

- Terrycloth (white, macchiato, or choco) ,--
- Dentalax neck rest ,--
- Manicure bowl Holder ,--
- Footrest ,--

# Aesthetic Lounge by Dr. Kevin Sadati

Newport Beach, California, USA





Photos: © Nathaniel Padilla Bowen/ Aesthetic Lounge

# SLXP series



## Gharieni SLXP series

The up to four electrical and maintenance-free low-voltage actuators of these treatment beds work quietly and are vibration-free. You can save and retrieve three personalized bed positions via the memory buttons. The ergonomically-shaped, full-length XP upholstery is quilted, breathable, and available in many different colors.

The treatment bed is available as SLXP with the classic basic orientation and as SLXP Reverse. With its "reversed" base, the Reverse offers optimal freedom of movement for the legs, especially for taller therapists – a small but subtle difference that significantly improves day-to-day work. The SLXP is also available as a Podo version.

### Features:

- Height, seat inclination, back, and leg section electrically adjustable via hand switch
- Pull-out foot and head sections
- Armrests fold backwards
- Three freely-selectable memory positions
- "Airback" lordosis support system integrated into the upholstery (see page 198)
- Spline safety actuators to avoid the danger of crushing
- Full-length ergonomic synthetic leather comfort upholstery
- Standard upholstery color: White. Other colors from our color collection for an additional charge
- Also available as a Podo version



SLXP

4-actuator

,-

SLXP Reverse

4-actuator

,-



- Height: 59-90 cm
- Length: 144-204 cm
- Width without/with armrests: 62/80 cm
- Lifting capacity: 200 kg
- Load capacity of the seat: 250 kg

# SLXP series

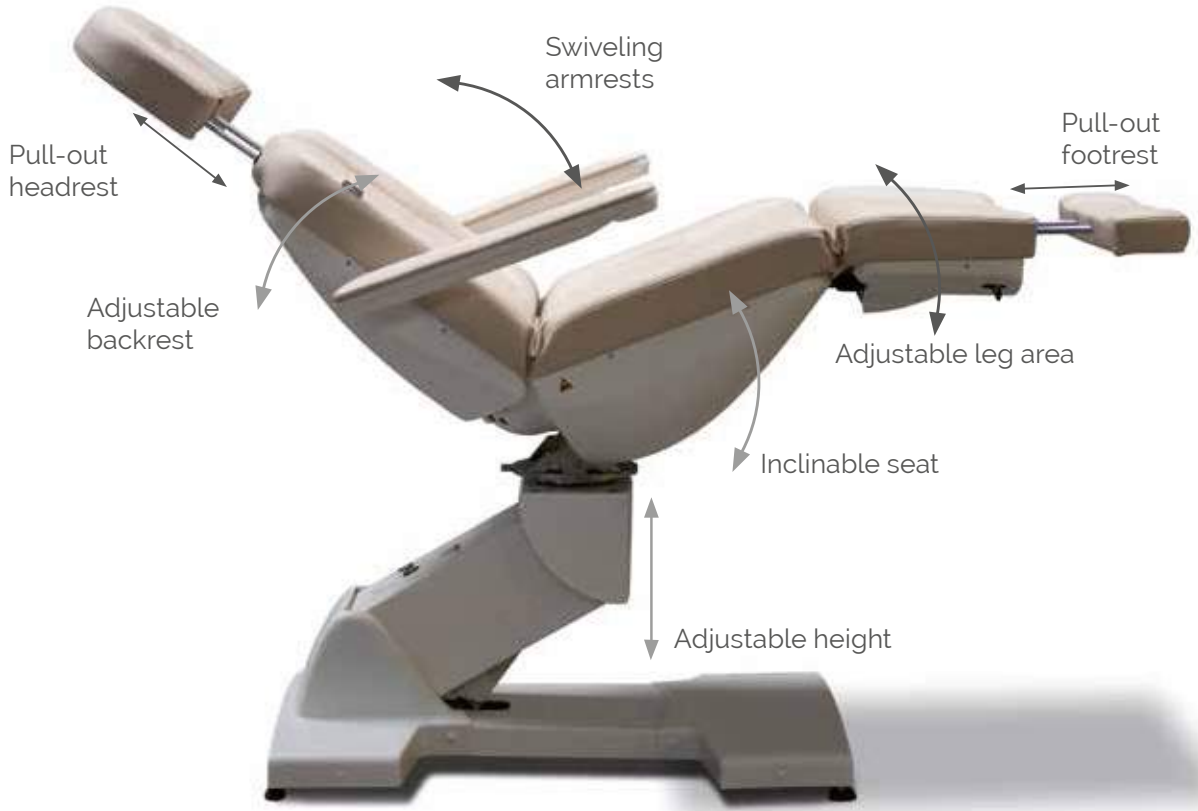

### Flexible classic

In addition to the adjustment of the chair height of 59-90 cm, the back section can be raised by 70° and the seat can be tilted by 21° and the foot section by -90°. For especially

tall customers, the headrest and the footrest can each be extended by 10 cm. The upholstered armrests can be swivelled backwards for massage treatments.





### Rotonde function

This feature allows the seat to be turned left or right by up to 330°. By means of the side-mounted locking it can be easily fixed in any position.



### Headrest with XL extension

For massages, the XL extension provides a pleasant arm rest area for relaxed shoulder muscles. The standard headrest can be easily exchanged for the XL extension.



### Footrest

The practical chrome-plated footrest protects the plastic casing of the base from mechanical wear and tear during head-side treatments. (Not compatible with the Reverse version!)



### Dentalax Neck Rest

A useful accessory for a pleasant treatment: the Dentalex neck rest. It supports the position of the neck as well as the head and thus ensures maximum comfort.

### Options (more info. after page 16)

- 🌡️
Smart-Thermo: programmable heating system with automatic shut-off
,-,-
- 🌊
Vibro-Wellness: gently pulsating vibration system with many adjustment options
,-,-
- 🖌️
Color upholstery: max. 2 different colors
,-,-
- 🖌️
Synthetic leather standard, per color
,-,-
- 🖌️
Synthetic leather Ferrari Stamskin Top, per color
,-,-
- 🔤
Logo embroidery: depending on effort,
,-,-
- 🛋️
XL extension with face cradle
,-,-
- 🛋️
XL extension without face cradle
,-,-
- 🖌️
Color XL Extension: max. 2 diff. colors
,-,-
- 🖌️
Synthetic leather standard, per color
,-,-
- 🖌️
Synthetic leather Ferrari Stamskin Top, per color
,-,-
- 🎵
Audio-Relax-Headrest: with integrated speakers to connect to common players
,-,-
- 🔄
Rotonde 330° (approx. 2 cm higher step-up height): seat rotatable by 330°
,-,-
- 👜
Casing in titanium color
,-,-
- 🛞
Castor set, brakable, Art. 73006
,-,-

### Accessories (see also page 218)

- Terrycloth (white, macchiato, or choco)
,-,-
- Dentalax neck rest, synthetic leather
,-,-
- Manicure bowl Holder
,-,-
- Footrest
,-,-
- Foot protective cover, PVC, transparent
,-,-

# DTM Beauty

Brasschaat, Belgium





Photos: © DTM Beauty

# Hydraulic series



## Hydraulic models

Without actuators, but with total comfort: Our hydraulic models offer almost everything their siblings with actuators can. In the case of the PLS Cos and SLXP Hydraulic, the height, seat angle, backrest, and leg section can be adjusted using a pneumatic spring without much effort. The armrests can be swiveled backward for easier starting positions for customers; and the upholstery is available in many colors.

### Features:

#### PLS Cos Hydraulic

- Height, seat inclination, back, and leg section adjustable via pneumatic spring
- Armrests fold backwards
- Inclinable head section
- Seat rotates 360°
- Synthetic leather comfort upholstery
- Standard upholstery color: White. Other colors from our color collection for an additional charge
- Also available as a Podo version

#### SLXP Hydraulic

- Height, seat inclination, back, and leg section adjustable via pneumatic spring
- Armrests fold backwards
- Pull-out foot and head sections
- Seat rotates 360°
- "Airback" lordosis support system
- Full-length ergonomic synthetic leather upholstery
- Standard upholstery color: White. Other colors from our color collection for an additional charge
- Also available as a Podo version

#### PLS Cos Hydraulic

- Height: approx. 59-79 cm
- Length: max. 144-203 cm
- Width without/with armrest: approx. 49/68 cm
- (Recommended) lifting capacity: 300 kg
- Load capacity of the table surface: 300 kg

#### SLXP Hydraulic

- Height: approx. 64-83 cm
- Length: approx. 144-203 cm
- Width without/with armrest: approx. 62/83 cm
- (Recommended) lifting capacity: 300 kg
- Load capacity of the table surface: 300 kg

#### PLS Cos Hydraulic

With pneumatic spring

,-,-



#### SLXP Hydraulic

With pneumatic spring

,-,-

#### Options PLS Cos (more info. after page 16)



Color upholstery: max. 2 different colors  
Synthetic leather standard, per color  
Synthetic leather Ferrari Stamskin Top, per color

,-,-

,-,-



Logo embroidery: depending on effort,

,-,-

#### Options SLXP (more info. after page 16)



Color upholstery: max. 2 different colors  
Synthetic leather standard, per color  
Synthetic leather Ferrari Stamskin Top, per color

,-,-

,-,-



Logo embroidery: depending on effort,

,-,-



XL Extension: Attachment to extend the table in the upper back area

,-,-



Color XL Extension: max. 2 diff. colors  
Synthetic leather standard, per color  
Synthetic leather Ferrari Stamskin Top, per color

,-,-

,-,-



Casing in titanium color

,-,-



Castor set, brakable, Art. 73006

,-,-

#### Accessories (see also page 218)

Terrycloth (white, macchiato, or choco)

,-,-

Dentalax neck rest

,-,-

Manicure bowl Holder (bei SLXP)

,-,-

Foot protective cover, PVC, transparent

,-,-

# SLR



## Gharieni SLR

From the classical treatment position to massage setups – as a treatment bed, the SLR is multifunctional. Equipped for four actuators, you can electrically adjust the height, back, seat inclination, and leg section via a hand switch and in addition store four memory positions. The minimal width of the back section also allows for flexible working. Thanks to its mechanically extendable castors, the SLR is also easy to move.

At 58 cm, the bed provides a low starting height; and the anatomically-shaped, one-piece synthetic leather upholstery with its mechanical Airback offers your customers optimum comfort.

The base of the SLR is available in a titanium with stainless steel elements. It comes standard with no armrests, this bed can also be optionally extended with various exchangeable and removable armrests.

### Features:

- Minimal back width for flexible working
- Height, back, seat inclination, and leg section electrically adjustable via hand switch
- Hand switch
- Four storable memory positions
- Optionally, different removable armrest versions can be used
- Base in a titanium with stainless steel elements
- Low starting height
- Anatomically molded and made from one piece synthetic leather upholstery including "Airback" mechanical lumbar support system
- Standard upholstery color: White. Other colors from our color collection for an additional charge
- Mechanically extendable castors



- Starting height with inclined seat position: 48 cm
- Height: 58–85 cm
- Length: 188–210 cm
- Width without armrests: 64 cm
- (Recommended) lifting capacity: 200 kg
- Load capacity: approx. 250 kg

SLR	
Without armrests	,-
Standard armrests	,-
PU armrests	,-



Without armrests



Standard armrests



PU armrests

# SLR



### Suitably adjustable

The SLR can be adjusted according to your needs and those of your customers. In terms of height, the bed can be set to 58-85 cm. The seat can be inclined by 12°. The backrest can be tilted in relation to the seat from 0 to 75° and the leg sec-

tion from 0 to -80°. The headrest as well as the footrest can be extended by 10 cm. The armrests can be swiveled back and folded down for massage treatments.







Variable PU armrests

The optional PU armrests, thanks to their special design, allow for use at variable heights. They can be effortlessly removed and used on opposite sides. This results in a high or low position for resting the arms. In addition, you can also remove the armrests altogether if the treatment requires it.



Mechanically extendable castors



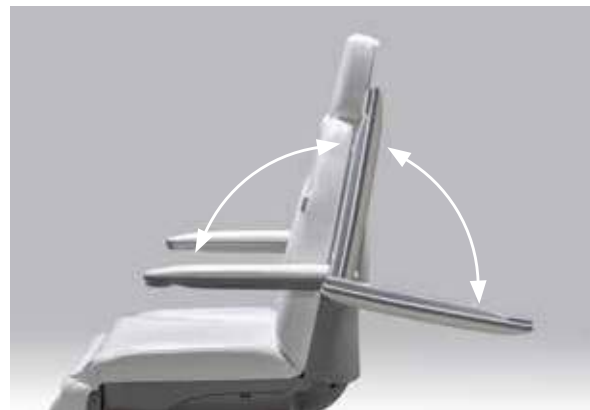



Thanks to the mechanically extendable and retractable castors, the bed can be easily moved and safely positioned.



Locking function of the armrests

The armrests can be fixed parallel to the backrest or completely folded backwards. They automatically stay there in their final position.

Options (more info. after page 16)

-  Airback electrical: electro-pneumatic lordosis support system of the upholstery ,-,-
-  Smart-Thermo: programmable heating system with automatic shut-off ,-,-
-  Vibro-Wellness: gently pulsating vibration system with many adjustment options ,-,-
-  Color upholstery: max. 2 different colors  
Synthetic leather standard, per color ,-,-  
Synthetic leather Ferrari Stamskin Top, per color ,-,-
-  Logo embroidery: depending on effort, ,-,-
-  Multifunctional headrest: ,-,-  
Joint mounting, stainless steel ,-,-  
Crescent-shaped attachment ,-,-  
U-shaped attachment ,-,-
-  XL Headrest ,-,-
-  Color XL Extension: max. 2 diff. colors  
Synthetic leather standard, per color ,-,-  
Synthetic leather Ferrari Stamskin Top, per color ,-,-
-  Foot switch to control the basic functions ,-,-

Accessories (see also page 218)

- Terrycloth (white, macchiato, or choco) ,-,-
- Dentalax neck rest ,-,-
- Manicure bowl Holder ,-,-
- Foot protective cover, PVC, transparent ,-,-

# Treatment Beds Accessories



## Upholstery Covers

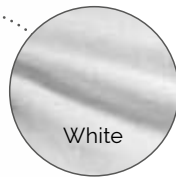

With the right covers your treatment bed will always be well protected against different types of stresses and strains. The table-specific covers are an exact match to the individual upholstery segments. With their integrated elastics, the parts of the terrycloth stay exactly where they belong, thus having no effect on the functioning of the bed.

Thanks to the high-quality material, machine washing up to 60° C is possible and therefore hygienic cleaning is possible. Our covers are available in three different colors: White, choco, and macchiato.

It is best to order the right cover directly when you buy your table. Our team would be happy to help you decide!

## Dentalax Neck Rest

This little accessory supports the neck and helps to stabilize the head. This creates a more comfortable table experience while relieving the neck vertebra. We recommend the Dentalax for each of our treatment tables as an optimal supplement for the best lying comfort and an increase in treatment ergonomics. The neck rest is available to match the upholstery color of the table.

Dentalax with PU, white	,-,-
Dentalax in PU, color	,-,-
Dentalax with synthetic leather, white	,-,-
Dentalax with synthetic leather, in standard colors	,-,-
Dentalax with synthetic leather, in Stamskin colors	,-,-



## Roll holder including paper roll

The optional paper roller provides you with a practical, disposable protection for your table. This can easily be attached to the bed. As needed, the 50 cm wide paper is unrolled and pulled over the lying surface. After use tear it off at the perforation line and discard. A neat thing!

Roll holder including 1 paper roll, Art. 42064	,-
Sanitary paper roll, 50 x 0.5 m, Art. 42065, up to 8 pieces, ea.	,-
Sanitary paper roll, 50 x 0.5 m, Art. 42065, 9 pieces, ea.	,-



## Foot protective cover

To protect the table areas at the foot end, we offer a suitable protective cover made of robust, transparent PVC for all tables. It can be securely fixed to the upholstery via Velcro.

Protective cover	,-
------------------	----



## Manicure bowl

Practical manicure accessories: This drip tray can be easily attached to the armrests of most Gharieni tables (with the exception of double-upholstered and PU armrests).

Manicure bowl, Art. 42020	,-
Manicure bowl holder, Art. 42017	,-



## mikrozyd® sensitive

For the gentle and thorough care of our upholstery we recommend mikrozyd® sensitive. Available as liquid or ready-to-use cloths in a handy dispenser, it eliminates bacteria, fungi, and viruses (such as HBV, HIV, Rota, vaccinia). Without alcohol!

mikrozyd® sensitive wipes, Art. 79418	,-
mikrozyd® sensitive liquid, Art. 79417	,-



## Neck/Knee rolls

To support a comfortable reclining position, we offer cylindrical and semi-cylindrical-shaped knee and neck rolls, each in two widths.

White, semi-cylindrical, 40 cm, Art. 42006/40	,-
White, semi-cylindrical, 60 cm, Art. 42006/60	,-
White, cylindrical, 40 cm, Art. 42005/40	,-
White, cylindrical, 60 cm, Art. 42005/60	,-

# Treatment units



Gharieni  
Spa Trolley  
HST



Gharieni  
Spa Trolley  
GST



Gharieni  
Treatment unit  
AluVap series



Gharieni  
Treatment unit  
Twin series



Gharieni  
Shiro Dhara  
Trolley series



Gharieni  
Treatment unit  
GlaStyle



Gharieni  
Treatment unit  
Junior

# Spa Trolley HST

## Gharieni Spa Trolley HST

Designed as an exclusive piece of furniture, this treatment unit not only offers a storable steamer with herbal diffuser, but also an FDS, or Foam Detecting System. This serves to shut off the steamer in the event of foaming by contamination. Also particularly practical are the swiveling steamer arm, a large storage space, an extendable tray, a drawer with subdivision, as well as a Hot Cabi compartment and a magnifying lamp holder. Equipped with four low-noise lightweight castors and available in numerous decors, the HST Spa Trolley is an indispensable and perfectly integrated work unit.

### Features:

- Integrated steamer
- Swiveling steamer arm
- With herbal diffuser
- With FDS (Foam Detecting System) serves to shut off the steamer in the event of foaming by contamination.
- Pull-out tray
- Large storage space
- Drawer with subdivision
- Including Hot Cabi and magnifying lamp
- Hot Cabi compartment
- Magnifying lamp holder
- Storage compartment for Flex magnifying lamp
- Castors
- In numerous decors and different designs



Spa Trolley HST

Including steamer, Hot Cabi  
and magnifying lamp



HST Trolley with  
storable steamer



- Height: 89 cm
- Width (closed): 50 cm
- Width (including steamer): 82 cm
- Depth (without handle): 48 cm
- Depth (including handle): 54 cm



### Everything in one location

You'll see how practical the Spa Trolley is during your treatments: With its extendable tray, storage space, integrated steamer, and Hot Cabi, it has everything you need for your cosmetic treatments. Thanks to its mobility, you have everything at hand during treatment. It doesn't get any more practical!



### Storable steamer

For organization in your workspace: When not in use, simply let the steamer and magnifying lamp "disappear" into the back of the spa trolley.



### Integrated Hot Cabi

Best organized: A Hot Cabi is integrated into the lower compartment of the HST. This means that your warm compresses are always on hand.

# Spa Trolley GST



## Spa Trolley GST

Including steamer, Hot Cabi  
and magnifying lamp



## Gharieni Spa Trolley GST

This treatment unit is exclusive and practical in the form of a trolley. This piece of furniture offers everything that makes your job easier: a storable swivel-mounted steamer, a herbal diffuser, and the Foam Detecting System (FDS) to shut down the steamer in the event of foaming by contamination. Also, the large storage space with four drawers, which can be divided in different ways according to what you want, proves itself in all treatments.

In addition, the integrated Hot Cabi offers warm towels at hand. What's more, a magnifying lamp holder and a storage compartment for the Flex magnifying lamp make the Spa Trolley GST the optimal work partner for you and in any desired location at that! Thanks to the low-noise, lightweight castors, you can easily push the Spa Trolley anywhere you need it. And last, but not least: Available in numerous decors, the Spa Trolley GST can also be perfectly integrated into any studio or workspace interior.

### Features:

- Integrated steamer with herbal diffuser
- FDS (Foam Detecting System) serves to shut off the steamer in the event of foaming by contamination.
- Swiveling steamer arm
- Large storage space
- Drawer with variable partitioning system
- Hot Cabi compartment
- Magnifying lamp holder
- Storage compartment for Flex magnifying lamp
- Castors
- In many decors
- Including Hot Cabi and lamp

- Height: approx. 117 cm
- Width (closed): approx. 70 cm
- Width (including steamer): approx. 109 cm
- Depth: 50 cm





### Extensive storage space

With its numerous different drawers and compartments, the trolley offers perfect organization for any workspace.



### For secure positioning

Thanks to the flexible drawer divider, the space in the drawers can be individually divided as needed. That way nothing can tip over when opening and closing drawers.



### Drawer dividers

The changeable dividing interior of the drawers allows for convenient and clear organization of small instruments and preparations.



### Steamer with many functions

The steamer is not only equipped with a herbal diffuser, but also with a Foam Detecting System (FDS). This shuts off foaming in the event of contamination.



### Integrated steamer

As soon as you no longer need the steamer, you can stow it away in the Trolley. Simply swivel it into the appropriate storage compartment.



### Practical with Hot Cabi

Thanks to the integrated Hot Cabi, warm towels and compresses are always at hand.

# AluVap



- Height: approx. 100 cm
- Steamer arm reach: approx. 70 cm
- Base diameter: approx. 46 cm

## Gharieni AluVap

The space-saving AluVap treatment unit is your ideal partner in professional cosmetics. Made of sturdy, high-quality aluminum, it offers all the functions for modern cosmetic treatments even in the smallest of spaces. Because of its modular structure, the device configuration can be put together individually. Four modules can be integrated as needed, such as Peeling, Vac/Spray, Iono, High-frequency, and Rotating Drawer. In addition, the steamer can be expanded by an aroma or herbal option.

Another highlight is the LED colored light option. This LED technology turns the steamer into an exclusive "face bio sauna." Depending on the color choice, the light enhances the psychological well-being of your customers. Thus, depending on your needs, it can have a relaxing, regenerating, balancing, stress-relieving, or revitalizing effect.

Additional equipment extras also include an Ultrasound and a Hot/Cold device, as well as a magnifying lamp in different versions; and a sanitary container as well as a beaker and cup holder are also available.

Available standard in white, black-brown, or with a titanium, you can also choose from more than 200 RAL colors. This perfect treatment unit can thus also be color-matched to integrate into any workspace.

### Features:

- Compact construction
- Slim Rotary-shaped design
- Aluminum body
- Modular construction
- Assembled according to your needs
- Up to four modules to choose from
- Large radius of action
- Easy-to-use
- Short heating-up phase
- Swiveling steamer arm
- Water supply via funnel from above
- Easy to remove water tank
- Felt ring for aroma treatment
- Herbal diffuser (optional)
- Can be expanded with additional devices, magnifying lamp, and other accessories
- Comes standard in white, black-brown, and with a titanium
- Other colors possible for an additional charge

## Configurator

The following modules can be used to create your own personal treatment unit:

### Basic module

Base including power block	,-
Wood decor base	,-

### AluVap steamer

AluVap steamer	,-
Herbal option	,-
Colored light	,-

### Modules (choose from a total of four)

Peeling	,-
Vac/Spray	,-
Iono	,-
High-frequency	,-
Rotating drawer	,-

### Additional devices

Hot/Cold	,-
DeLuxe Plus magnifying lamp, white, Art. 41833	,-
DeLuxe Plus magnifying lamp, titanium, Art. 41834	,-
Adapter for magnifying lamps	,-



## Accessories

Beaker and cup holder, Art. 90300	,-
Felt rings, 10 pieces, Art. 90318	,-



### For modules to choose from

Whether it's with Peeling, Vac/Spray, Iono, High-frequency, or Rotating Drawer – configure the treatment unit with up to four perfectly matching modules according to your needs.



### Colored light

The optionally available colored light for the steamer head of the AluVap is the perfect addition: Depending on your choice of color, the light has a relaxing, regenerating, balancing, stress-relieving, or revitalizing effect.



### Device holder

With this special holder you can place handpieces and their accessories, which you need for your treatments, near the AluVap treatment unit. – For particularly practical and efficient work.



### Basic module base

The base of the basic module is equipped with braked castors and is available in metal as standard. For a particularly high-end look, you can also optionally choose from one of our numerous wood decors.

# AluVap

Versions:



## AluVap steamer

The simplest version: The AluVap steamer without additional devices with rotating storage compartments.

AluVap with steamer, without devices      -,-



## AluVap workstation

Also without steamer, as an equipment trolley, the AluVap cuts a fine figure. With its slim design, it has the right device for every application.

AluVap with devices, without steamer      -,-



## AluVap Mini

Small, compact, and at the same time just as functional as its "big brother:" the AluVap Mini.

AluVap with steamer, without devices      -,-

## Gharieni AluStyle

Based on the Rotary design of the AluVap, the devices from our treatment units are also available individually in robust aluminum housing. With their non-slip base and compact design, the AluStyle devices fit on almost all furniture items and equipment trolleys.

### Features

- Robust aluminum housing
- Continuous adjustment, partly with illuminated display
- Exclusive lamp elements
- Exclusive Rotary design

### Peeling AluStyle

- Including a soft 20 mm and 45 mm brush
- Including a hard 45 mm brush
- Sponge holder including ten small sponges

### Vac/Spray AluStyle

- Including one round, flat, and curved ventouse and a large and small suction cup
- With two spray bottles and hose set

### High-frequency AluStyle

- Including one 20 mm and 45 mm round electrode, one neck electrode, and one indirect electrode

### Iono AluStyle

- Including one hand and two roller electrodes



AluStyle Peeling

Art. 91300



AluStyle Vac/Spray

Art. 91301



High-frequency AluStyle

Art. 91302



AluStyle Iono

Art. 91301



# Twin



Twin

For price see configurator



Twin with Ayurveda attachment

For price see configurator

## Gharieni Twin

Elegant and stable, this metal treatment unit offers optimal flexibility for all facial treatments. Configure your Twin with up to four perfectly integrating modules according to your needs. You can choose from Peeling, Vac/Spray, Iono, High-frequency, and Rotating Drawer.

What's more, the AluVap steamer can optionally be equipped with an herbal option as well as with colored light. In addition, the Twin can be extended by a magnifying lamp and a Hot/Cold device; and up to three trays provide ample storage space.

Alternatively, the Twin can also be equipped with a Shiro Dhara attachment for ayurvedic oil forehead pouring. This makes it the perfect treatment unit for deep mental, spiritual, and physical relaxation.

### Features:

- Flexible unit versions
- Steamer body made from stable aluminum
- Modular construction
- Assembled according to your needs
- Choose from up to four device modules
- Glass or wood decor storage shelves
- Up to three trays
- Optionally with Shiro Dhara attachment
- Can be expanded with devices, magnifying lamp, and other accessories
- Steamer features: See AluVap (page 258)



- Twin height: approx. 100 cm
- Height incl. Ayurveda attachment: 178 cm
- Width: approx. 69 cm
- Depth: approx. 49 cm
- Steamer arm reach: approx. 70 cm

## Configurator

The following modules can be used to create your own personal treatment unit:

### Basic module

Twin Trolley including power block	---
Tray (glass or wenge decor)	---

### AluVap steamer

AluVap steamer	---
Herbal option	---
Colored light	---

### Modules (choose from a total of four)

Peeling	---
Vac/Spray	---
Iono	---
High-frequency	---
Rotating drawer	---

### Additional devices

Hot/Cold	---
Shiro Dhara attachment	---
DeLuxe Plus magnifying lamp, white, Art. 41833	---
DeLuxe Plus magnifying lamp, titanium, Art. 41834	---
Adapter for magnifying lamps	---

### Accessories

Sanitary container with holder	---
Beaker and cup holder, Art. 90300	---
Felt rings, 10 pieces, Art. 90318	---



Work tools as modules

Up to four of the Peeling, Vac/Spray, Iono, High-frequency, or Rotating Drawer modules can be perfectly integrated in the AluVap steamer. For the features of the AluVap see page 258



Colored light option

Complete the steamer with soothing colored light. Depending on the color, the light has a stress-reducing, relaxing, regenerating, balancing, or vitalizing effect.



Device holder

With this special holder, you have everything you need for your treatments at hand – whether it's brush attachments, electrodes, or ventouses. Even so, the twin is the optimal treatment unit

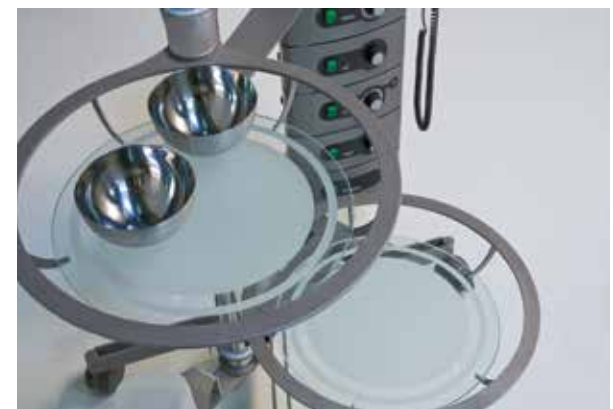

Choice of trays

With up to three height-adjustable trays, the Twin offers plenty of storage space. And for a custom look, the trays are available in glass or wood decor.

# Shiro Dhara series



Shiro Dhara Trolley Wood  
in black-brown     :-  
in chrome         :-



Shiro Dhara Trolley Junior  
in chrome/titanium     :-



## Gharieni Shiro Dhara Trolley series

There are two models available for deep relaxing ayurvedic oil forehead pouring:

The Shiro Dhara Trolley Wood with a base featuring wood decor is equipped with a tray for various collection containers and an oil drainage device with collection glass. These elements are height adjustable.

On the Shiro Dhara Trolley Junior, the forehead pouring bowl has an adjustable valve. This makes it easy to regulate the flow rate. The holder for the forehead pouring bowl is height adjustable.

### Features

#### Shiro Dhara Trolley Wood:

- Base in wood decor
- With tray and oil drainage device including collection glass
- Different collection containers available
- Height-adjustable elements
- Castors
- Available in chrome colors and black-brown

#### Shiro Dhara Trolley Junior:

- For oil forehead pouring
- Trays and arm height adjustable
- Choose from glass or wenge wood for tray bottoms
- Forehead pouring bowl with adjustable valve and suspension device
- Expandable with two additional trays
- Brakable castors
- Available in chrome and black-brown

### Accessories

Additional tray in glass or wood decor including holder

---



- Height: approx. 178 cm
- Wood base width: approx. 55 cm
- Junior base width: approx. 70 cm



Elegant forehead pouring bowl

The forehead pouring bowl of the Shiro Dhara Trolley Junior is equipped with an adjustable valve. This makes it easy to regulate the flow rate. The holder for the forehead pouring bowl is height adjustable.



Oil collection device

The Shiro Dhara Trolley Wood includes an oil drainage device with collection glass. This makes it easy to collect and dispose of the returning oil – for convenient and clean work.



Oil bowl

The Shiro Dhara trolley collects the returning oil in a stainless steel bowl. The tray for the bowl is height adjustable and can be optionally equipped with glass or wood decor bottom.

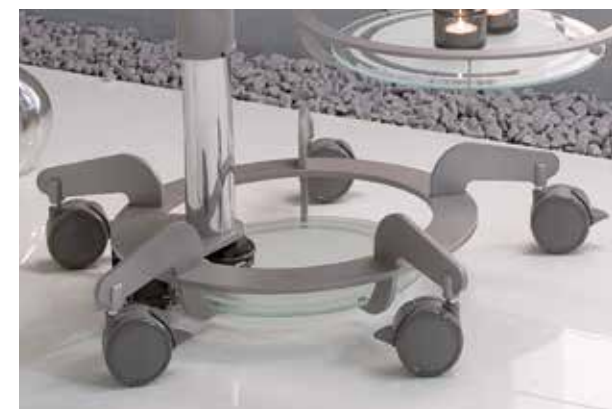

Easy-rolling castors

The five lightweight castors of the Shiro-Dhara-Wood and Junior models ensure perfect mobility and stability. This way you can easily move the trolley anywhere you need it.

# GlaStyle



GlaStyle

Treatment unit

## GlaStyle

This elegant treatment unit with white or titanium-colored base leaves nothing to be desired in terms of configuration. For example, the GlaStyle can be equipped not only with up to four device modules, but also with a steamer, a Hot/Cold device, and the DeLuxe Plus magnifying lamp. Up to three glass trays also ensure sufficient storage space. Select from the following options for the rotatable device modules: Peeling, Vac/Spray, Iono, and High-frequency. In addition, you can expand the steamer that also rotates to include colored light and a herbal option. As accessories, sanitary container with holder as well as a beaker and cup holder round out this extremely practical treatment unit.

### Features:

- Your choice of steamer configuration and device modules
- Choose from up to three glass trays
- Rotatable devices and steamer
- Can be expanded with magnifying lamp and devices
- Base in white or titanium
- Four brakable lightweight castors
- Steamer features: See AluVap (page 258)



- Height: approx. 96 cm
- Width (closed): approx. 50 cm
- Length: approx. 70 cm

### Configurator

The following modules can be used to create your own personal treatment unit:

#### Basic module

Base in white or titanium 7,-

Glass tray 7,-

#### AluVap steamer

AluVap steamer including arm 7,-

Herbal option 7,-

Colored light 7,-

#### Modules (choose from a total of 4)

Power block including arm 7,-

Peeling 7,-

Vac/Spray 7,-

Iono 7,-

High-frequency 7,-

#### Additional devices

Hot/Cold 7,-

DeLuxe Plus magnifying lamp, white, Art. 41833 7,-

DeLuxe Plus magnifying lamp, titanium, Art. 41834 7,-

Adapter for magnifying lamps 7,-

### Accessories

Sanitary container with holder 7,-

Beaker and cup holder, Art. 90300 7,-

Felt rings, 10 pieces, Art. 90318 7,-



Your choice of device modules

Up to four device modules entirely of your choosing can be perfectly and in a rotating fashion integrated into the GlaStyle. In this case the power block is obligatory. It supplies the device modules with the necessary power.



Two base versions

The GlaStyle base is available in both white and titanium. The brakable lightweight castors ensure smooth and silent mobility on every type of ground.



Attractive glass trays

Up to three glass trays provide sufficient storage space for your treatments. The stainless steel railing ensures that your work instruments and care products will stay where they belong.



Sanitary container

Small but excellent: This small sanitary container with its practical swiveling lid and own holder is perfectly suited for disposal of used items such as cotton pads, facial tissues, among others.

# AluVap Junior

## Gharieni AluVap Junior

Height adjustable, easy to fill with a funnel, with a removable water tank made of glass, and a rotatable steamer head, the AluVap Junior Trolley allows for perfect, practical work. The modular assembly of the treatment unit is equipped with a steamer housing made from high-end aluminum and a storage area in the base. It can be expanded by up to three glass or wood decor trays as well as the DeLuxePlus magnifying lamp and an adapter for magnifying lamps. With the AluVap Junior with stand, we also offer a simpler version of the steamer.

### Features:

- Aluminum steamer housing
- Modular composition
- Steamer height-adjustable
- Rotatable steamer head
- With up to three trays
- Glass or wood decor trays
- Easily fillable via funnel
- Removable glass water tank
- Attachment for felt rings
- Additional shelf in the base
- Also available as a simple steamer with stand



Aluvap Junior Trolley

Treatment unit



Aluvap Junior

Steamer with stand

---

### Aluvap Junior

- Height including steamer: max. 148 cm
- Steamer reach: approx. 65 cm
- Base diameter: approx. 65 cm



### Aluvap Junior Trolley

- Height including steamer: max. 144 cm
- Steamer reach: approx. 76 cm
- Base diameter: approx. 70 cm

### Configurator

The following modules can be used to create your own personal treatment unit:

#### Basic module

Base in titanium/chrome	,-
Glass or wood tray with bracket	,-

#### AluVap steamer

AluVap Junior steamer including arm	,-
-------------------------------------	----

#### Additional devices

DeLuxe Plus magnifying lamp, white, Art. 41833	,-
DeLuxe Plus magnifying lamp, titanium, Art. 41834	,-
Adapter for magnifying lamps	,-



Glass or wood trays

The up to three height-adjustable trays with railing can be selected in glass or with a wood decor. They offer a practical storage space during your treatments.

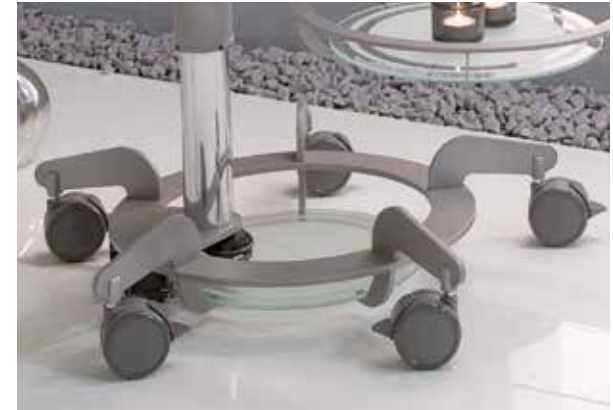

Stable base with castors

Equipped with five brakable lightweight castors, the AluVap Junior is mobile and at the same time stable and secured from falling over.



Steamer arm with rotating head

The compact, height-adjustable steamer has a rotatable head, a filling funnel, and a removable glass water tank.



Magnifying lamp holder

The magnifying lamp holder allows the corresponding adapter to attach to different magnifying lamp models. Magnifying lamps can be found in our "Medical, Feet and Care" catalog.

### Accessories

Felt rings, 10 pieces, Art. 90318	,-
Additional tray in glass or wood decor including holder	,-

# BAYSIDE Hotel Scharbeutz Germany

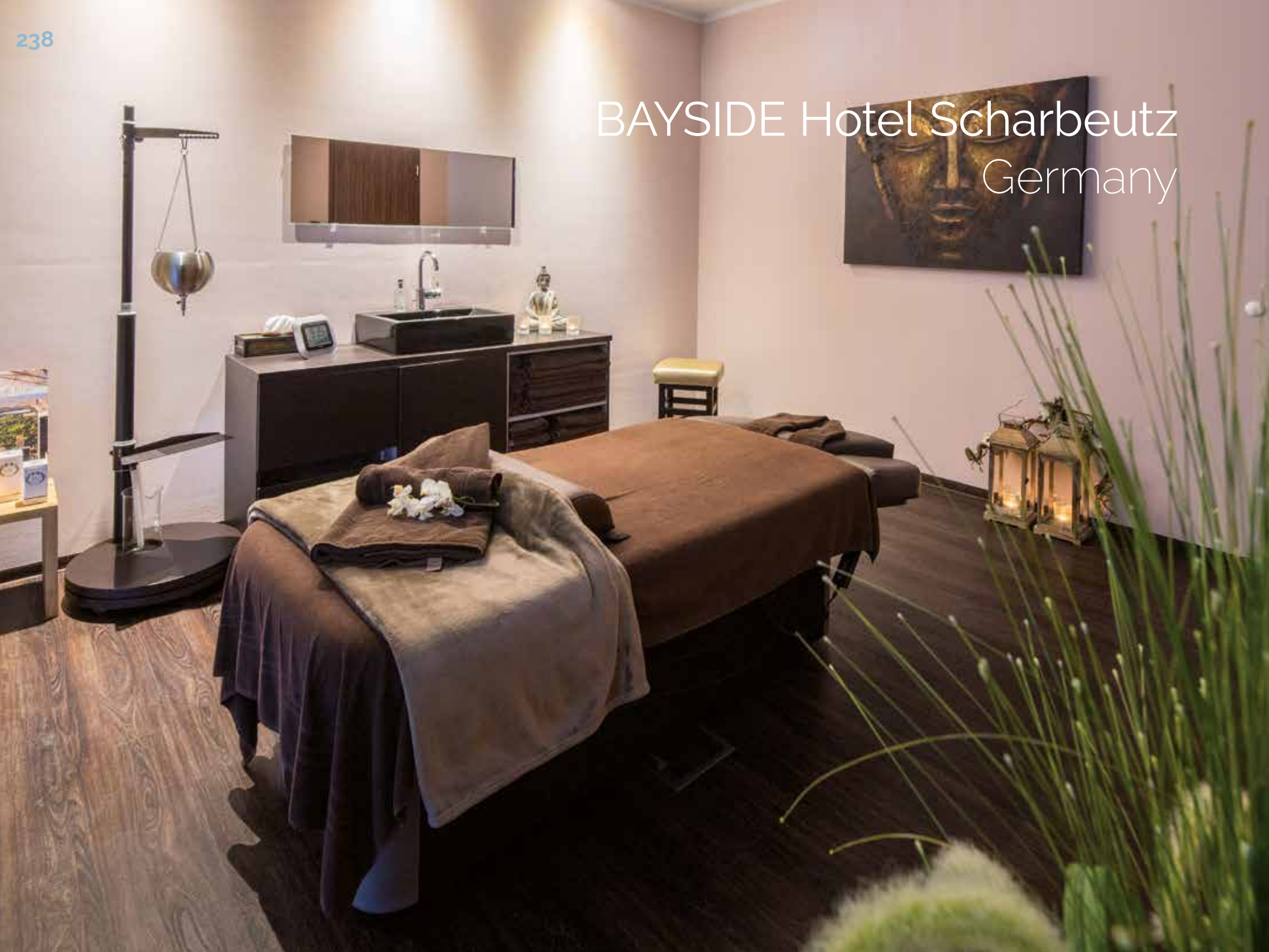



Photos: © BAYSIDE Hotel Scharbeutz

# Furnishings

## Furniture series



Gharieni  
K8



Gharieni  
Kg



Gharieni  
K10

## Equipment trolley series



Gharieni  
MLX Trolley



Gharieni  
MO Trolley



Gharieni  
Square Trolley



Gharieni  
CL Trolley



Gharieni  
GL



## Manicure tables

Gharieni  
ManoGharieni  
Cube Select

## Stools + Chairs

Gharieni  
CubeGharieni  
VarioGharieni  
GlaStyleGharieni  
Lamica

# K8 Furniture series



# Gharieni K8 Sideboards

The K8 series provides aesthetic design for your treatment cubicle; because the elements of this modular system are enclosed by a joint-free frame. According to your needs and the size of your workspace, the basic frame module is available in four versions: for one, two, three, or four individually assembled built-in modules in a width of 107 to 207 cm. With the built-in elements – a drawer, cabinet, and floor unit module – you can also choose according to your needs.

### Features:

- In four widths: up to four modules
- Individually assembled built-in modules
- Frame available in three decors: White, Joplin, and Sinatra
- Front in white
- Also as a washbasin cabinet version
- Additional attachment basin possible
- Optionally with LED lighting



K8 Sideboard with 1 module

Without lighting	,-
With lighting	,-



K8 Sideboard with 2 modules

Without lighting	,-
With lighting	,-



K8 Sideboard with 3 modules

Without lighting	,-
With lighting	,-



K8 Sideboard with 4 modules

Without lighting	,-
With lighting	,-

#### K8 Sideboard with 1 module

- Height: 94.5 cm
- Width: 57 cm
- Depth: 60 cm

#### K8 Sideboard with 2 modules

- Height: 94.5 cm
- Width: 107 cm
- Depth: 60 cm

#### K8 Sideboard with 3 modules

- Height: 94.5 cm
- Width: 157 cm
- Depth: 60 cm

#### K8 Sideboard with 4 modules

- Height: 94.5 cm
- Width: 207 cm
- Depth: 60 cm



# K8 Furniture series



Optional LED bar

The integrated LED bar provides sophisticated lighting along the upper frame surface.



For perfect organization

For easy disposal of used textiles, the drawer of the K8 laundry module can be equipped with a removable laundry basket.

K8 frame:



K8 frame for 1 module

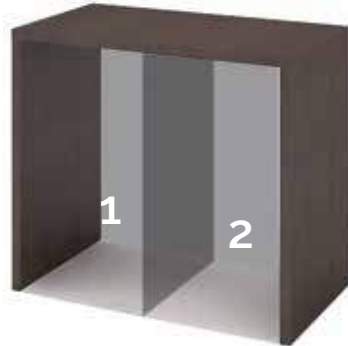

K8 frame for 2 modules

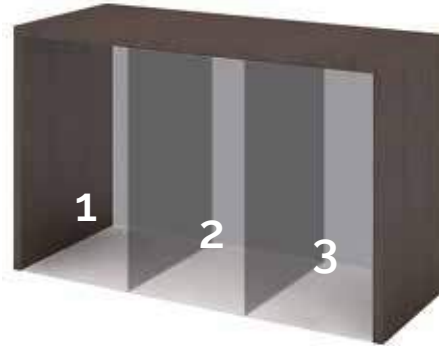

K8 frame for 3 modules

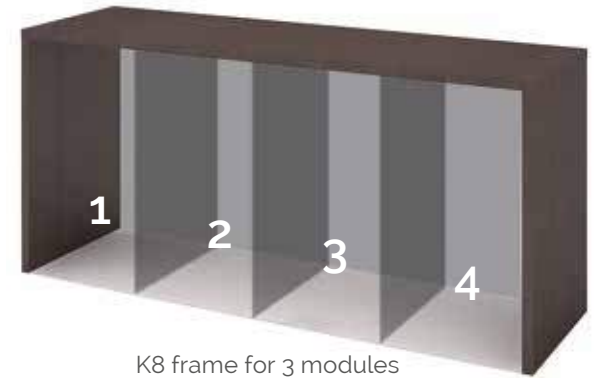

K8 frame for 3 modules



K8 built-in modules



K8 drawer module



K8 laundry module



K8 floor unit module



Basin, round  
Including fittings



Basin, rectangular  
Including fittings



Organizer, gray



Organizer, white



Waste container, 11 l



Waste container, 5 l



Laundry basket



Waste container, 11 l



Waste container, 5 l



Laundry basket



# Kg Furniture series



Kg washbasin cabinet  
With three compartments



Kg Laundry Trolley  
On castors



Kg Cosmetic Trolley  
On castors

## Gharieni K9 Furniture series

The flexible K9 furniture series meets the highest aesthetic and functional requirements. The K9 cosmetics trolley offers four spacious drawers and thus enough space for your practical work. The modern tip-on technology facilitates the use of the trolley: With light pressure, the drawers slide out gently and quietly. The elegant handle and smooth-running castors make it easy to slide the trolley into the needed position.

The exclusive K9 laundry cart offers the ideal solution for dirty laundry. Used towels, covers, and other textiles disappear immediately through the opening at the front. Like the cosmetics trolley, the position of the laundry trolley can also be adjusted by smooth-running castors.

The K9 washbasin cabinet is just as elegant as it is practical. Divided into three areas, there's plenty of space for equipment, towels, used textiles, and more. On request, an attachment washbasin can be integrated.

And for just the right look, choose from our wood and color decors in matt or high gloss!

### K9 washbasin cabinet features:

- Individually assembled
- Three sections for towels, various devices, used laundry, and much more.
- Additional attachment basin possible

### K9 Cosmetic Trolley features:

- Four spacious drawers
- Gentle sliding out of the drawers via "Tip-On-Automatic"
- Elegant handle for moving the furniture
- Rubber castors for pushing

### K9 Laundry Trolley features:

- Easy disposal of used laundry through wide insertion slot
- Laundry easily removable via large front flap
- Drawer with Tip-On-Technology
- Rubber castors for pushing



Attachment washbasin

The attachment washbasin is optionally available and makes the washbasin cabinet an optimally practical unit. For the current collection of attachment washbasins, ask our staff.



Compartment for dirty laundry

Towels, covers, and other textiles can be stowed immediately after use via the large slot of this fold-out compartment. This way your workspace will always look tidy even during treatment.



Hot Cabi

For a clean look in your workspace: Just let your Hot Cabi "disappear" into the K9 washbasin cabinet! Find out about our range of matching Hot Cabis in our "Medical, Feet & Care" catalog.



#### K9 washbasin cabinet

- Height: 77 cm
- Width: 176.5 cm
- Depth: 50 cm

#### K9 Cosmetic Trolley

- Height: 81.5 cm
- Width: 66 cm
- Depth: 43 cm

#### K9 Laundry Trolley

- Height: 81.5 cm
- Width: 66 cm
- Depth: 43 cm

# K10 Furniture series





## Gharieni K10 Sideboards

The K10 furniture series is the innovative development of the successful K9 series. As a modular system with a frame that can include up to four built-in modules, the K10 series offers perfect, aesthetic organization for your workspace. According to your needs, you can assemble your K10 Sideboard from the following modules:

a drawer, cabinet, and floor unit module. The Spa Trolley HST treatment unit K10 module, which can be perfectly integrated, is particularly practical. This module on noiseless lightweight castors can be easily pulled out for treatment and then pushed back into the unit.

### Features:

- In three versions: with two, three, or four modules
- Individually assembled built-in modules
- Choose from various wood and color decors
- Also as a washbasin cabinet version
- Additional attachment basin possible



K10 Sideboard

With 4 modules



K10 Sideboard

With 2 modules



K10 Sideboard

With 3 modules

#### K10 Sideboard with 4 modules

- Height: 93 cm
- Width: 207 cm
- Depth: 60 cm



#### K10 Sideboard with 3 modules

- Height: 93 cm
- Width: 157 cm
- Depth: 60 cm

#### K10 Sideboard with 2 modules

- Height: 93 cm
- Width: 107 cm
- Depth: 60 cm

# K10 Furniture series



Spa-Trolley HST



Equipment-Trolley HST

Trolley-HST modules for K10 furniture

These modules are available in two versions: As a Spa-Trolley HST with retractable steamer and Hot Cabi for your treatments (see page 252), as well as Equipment Trolley with Hot Cabi and drawers for practical storage space.



Spa & Equipment-Trolley HST

The treatment trolleys can be easily inserted under the frame when not in use and thus form a solid unit with it.

K10 frames:



K10 Built-in modules (permanently installed):

K10 Drawer modules



K10 Cabinet modules



K10 Trolley modules (pull-out, on castors):

K10 Drawer Trolleys



K10 Equipment-Trolley HST with integrated Hot Cabi



K10 Spa-Trolley HST with integrated steamer and Hot Cabi



K10 handles:

Choose the right handle for your K10 furniture! There are four different models available for this purpose – recessed shell handles, an attached bar handle, or attached bow handles made of metal or with leather insert.



Shell handle

- Recessed handle
- Aluminum
- Chrome-plated, matte

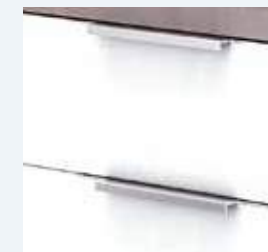

Bar handle

- Attached bar handle
- Zinc die-casting
- Aluminum-colored

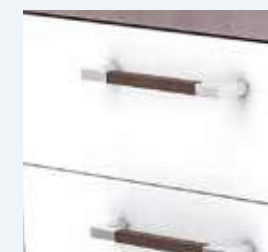

Furniture handle leather

- Attached handle strip
- Zinc die-casting chrome-plated, matte
- Lining: Leather

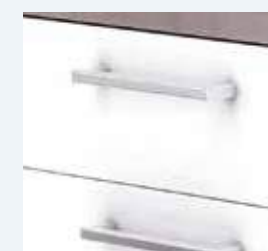

Furniture handle stainless steel

- Attached handle strip
- Stainless steel
- Brushed matte

# K10 Furniture series



K10 Presentation Showcase

Including LED lighting

,-

Individual logo

,-



K10 Presentation Wall

Including LED lighting

,-

## Gharieni K10 Presentation Showcase

With the refined and discreetly illuminated showcase with glass cover, for example, you can show your premium products "in the right light" in an appealing and classy fashion. And for your very own personalized look, the logo of your institute can be featured on the front of the showcase.

### Features:

- Glass cover to protect the products
- Pull-out tray
- High-end bi-color design
- Choose from various wood and color decors
- Including illuminated frame
- Enough room for your personalized logo on the front side

## K10 Presentation Wall

Put your goods in the spotlight with the K10 Presentation Wall. The modern, purist appearance of the Wall in an individual wood decor or a color surface of your choice, together with the subtly refined illumination is absolutely high-end and allows for a perfectly professional presentation of your products.

### Features:

- Three shelves
- Including backlight illumination for discreet lighting
- Exclusive bi-color design or monochrome
- Choose from various wood and color decors

### K10 Presentation Showcase

- Height: 116 cm
- Width: 40 cm
- Depth: 40 cm



### K10 Presentation Wall

- Height: 230 cm
- Width: 160 cm
- Shelf depth: 40 cm

## Gharieni K10 Reception Counters

First impressions count! Therefore, welcome your customers right in your entrance area with a visual highlight. Our K10 Reception Counters offer everything you need: ample storage space for everything you need at reception and plenty of additional storage space. In addition, a subtle illumination of the front frame and a personal branding on the large front surface are possible. With an individual wood decor or color surface and the two selectable sizes, the K10 Counters fit in almost every reception area.

### Features:

- Available in two sizes
- Various drawers and compartments for keyboard, computer, and materials
- Exclusive bi-color design
- Choose from various wood and color decors
- Illuminated frame on the front
- Enough room for your personalized logo on the front side

### K10 Reception Counter, small

Including LED lighting -,-

Individual logo -,-



### K10 Reception Counter, large

Including LED lighting -,-

Individual logo -,-



### K10 Reception Counter, small

- Height: 90 cm
- Width: 120 cm
- Depth: 70 cm

### K10 Reception Counter, large

- Height: 90 cm
- Width: 160 cm
- Depth: 70 cm



# Kosmetikinstitut Jungbrunnen

## Vohburg on River Danube, Germany



# SH Better Skin

Ismaning, Germany



# MLX Trolley series



## MLX Trolley versions

No matter for what purpose: Choose your suitable MLX Trolley from our offering!



Large (Height: approx. 99 cm)

Medium (Height: approx. 88 cm)

Small (Height: approx. 77 cm)

Mini (Height: approx. 55 cm)



# MLX Trolley

Do you love to work when things are "tidied up" and are organization and clarity a must for you in your workspace? Then the multifunctional MLX Trolley is just right for you! With the multifunctional trolley with its variety of versions, you're guaranteed to find the right model.

Whether you opt for a small, medium, or large Trolley, combine low and high Tip-On drawers, as it best suits you. Practical, too: With the all-round handle and the high-quality lightweight castors, the trolley can be moved effortlessly. In addition, it can be equipped with a magnifying lamp holder on request. Also: Thanks to the possibility of choosing from a variety of matte and glossy color and wood decors, the trolley is a perfect fit in every workspace!

## Features:

- Multifunctional trolley
- Combination of high and low Tip-On drawers
- All-round handle
- Choose from a large variety of versions and designs
- High-quality castors
- Optionally with magnifying lamp holder

## Accessories

Tray attachment	,-
Magnifying lamp adapter, integrated, Art. 41812	,-
Magnifying lamp adapter, side assembly, Art. 41804	,-



- Height: 76.5 cm (small), 88 cm (medium), 99 cm (large)
- Width without handle: 45 cm
- Width including handle: 54 cm
- Depth without handle: 45 cm
- Depth including handle: 54 cm



Tip-On drawers

Just tap it a little bit: The Tip-On technology allows you to effortlessly open the drawers.



Tray attachment

Everything at hand with the optional detachable tray attachment. This allows you to provide the necessary products for your treatments and at the same time use the tray as a storage surface.



Railing

With its all-round handle in a look of your choice, the MLX Trolley is "at hand" in the truest sense of the word from all sides. In this way, it can be pushed anywhere where you need it.



Magnifying lamp holder

Optionally, the MLX Trolley can also be equipped with a holder for a magnifying lamp. In this way your "mobile storage space" offers the possibility of the right lighting for your treatments at the same time.

# MLX Trolley series



MLX Display Trolley Plus  
 Including Hot Cabi Maxi -,-  
 Display lighting -,-



MLX Display Trolley  
 Without Hot Cabi -,-  
 Display lighting -,-

# Gharieni MLX Display Trolley

The MLX Display Trolley features side compartments with flap, a fold-out compartment, and a drawer in the front area as well as a Hot Cabi compartment for optimal storage space.

With an optional illuminated display, you can also perfectly present your preparations. Of course, you can also choose your decor from a variety of colors and textures to suit your taste in these elegant designer pieces. The Display Trolley is available in two versions: narrow and as a wider Plus version including a Hot Cabi.

## Features:

- Fold-out compartment and drawer in the front area
- Side compartments
- Optional illuminated display for attractive placement of your preparations
- Available in different decors
- Lightweight castors
- All-round handle

## Accessories

Tray attachment	,-,-
Magnifying lamp adapter, integrated, Art. 41812	,-,-
Magnifying lamp adapter, side assembly, Art. 41804	,-,-

### MLX Display Trolley

- Height: 99 cm
- Width (without handle): 45 cm
- Width (including handle): 54 cm
- Depth (without handle): 45 cm
- Depth (including handle): 54 cm



### MLX Display Trolley Plus

- Height: 99 cm
- Width (without handle): 50.5 cm
- Width (including handle): 60 cm
- Depth (without handle): 52 cm
- Depth (including handle): 62 cm



### Hot Cabi

The wider display Trolley Plus has a standard integrated Hot Cabi. This way your warm compresses are always at hand.



### Side storage compartments

For practical working: Reachable from both sides, the side storage compartments offer quick access. With the Display Trolley Plus, the storage compartments can also be closed with a flap.



### Lighting display

For optimal product presentation and a sophisticated appearance, the base plate can be equipped with lighting.



### Tip On

A light press is all it takes: Thanks to the Tip-On technology, the drawers open effortlessly and quietly.

# MLX Trolley series



MLX Wax Trolley  
Including wax heater ---



MLX Wax Trolley Plus  
Including 1 wax heater ---  
Including 2 wax heaters ---

## Gharieni MLX Wax Trolleys

The flexible MLX Wax Trolleys with lightweight castors offer simple and clean depilating: In the upper compartment there is an integrated wax heater and recesses for wax cans. The integrated folding waste container allows for easy disposal. The full-length storage compartment in the back area permits access from both sides. The MLX Wax Trolley Plus can also store a supply of three wax pistols in the middle drawer. The Trolleys are available in various decors.

### Features:

- With integrated wax heater
- Optional second wax heater possible
- Extendable compartment e.g for wax pistols on the MLX Wax Trolley Plus
- Cover can be pushed back and used as a storage area
- Side storage compartments
- Practical folding waste container
- Available in different decors
- On castors

### Accessories

Magnifying lamp adapter, side assembly, Art. 41804

,-,-



- Height: 99 cm
- Width without handle: 45 cm
- Width including handle: 54 cm
- Depth (without handle): 45 cm
- Depth (including handle): 54 cm



### Practical cover

The wax heater integrated in the upper compartment and the wax can recesses are covered by a sliding plate. When opened, this can be used as a practical storage space.



### Drawer for wax pistols

In its extendable middle drawer, the MLX Wax Trolley Plus offers the possibility to accommodate three wax pistols.



### Integrated hinged waste container

The integrated hinged waste container in the MLX Wax Trolley makes it easy to dispose of your consumables.



### Side storage compartments

For practical working: Reachable from both sides, the side storage compartments offer quick access.

# MO Trolley



MO Trolley  
Including 4 insert baskets

## Gharieni MO Trolley

Our MO Trolley provides clear design and lots of storage space with its spacious drawer and the large storage baskets. Thanks to its invisible castors, the Trolley can be positioned anywhere it is needed. With its different wood and color decors, it not only fits into any ambience, but thanks to its design, also perfectly matches our MO1 spa tables.

### Features:

- Mobile trolley
- Compact, low construction
- With a spacious drawer
- Pull-out shelf for devices or preparations
- Drawers with soft-close technology
- Sturdy metal baskets for secure storage
- Available in different decors
- Lightweight, invisible castors

### Accessories

Magnifying lamp adapter, side assembly, Art. 41804

,-,-



Stable storage baskets

The aluminum baskets specially made for the MO Trolley ensure safe storage; Rubber feet effectively prevent slipping. When not in use and during cleaning, the shelves can be easily removed.



Gently closing drawers

The spacious drawers offer plenty of space for your work instruments and equipment. Also: Thanks to their Soft-close technology, the drawer and pull-out shelf close quietly and gently.



- Height: 68 cm
- Width: 61 cm
- Depth: 46 cm

# Square Trolley



Square Trolley  
Complete ,-



## Gharieni Square Trolley

This mobile preparation trolley is the practical helper for all your treatments. The side compartments and two drawers in the front area allow you to store everything you need. An extendable tray in the front provides a useful storage space; The folding compartment stores used materials and the side handles can be used as towel holders. Equipped with castors, the Trolley can effortlessly and quietly move to any desired place. And if the Square Trolley is to be used with a magnifying lamp, it can be optionally equipped with a magnifying lamp holder.

### Features:

- Mobile preparation trolley
- Two drawers in the front area
- Drawers with Tip-On-Technology
- Side compartments
- Fold-out compartment for waste
- Handles on the sides that can be used as towel holders
- Pull-out tray
- Available in different decors
- On castors
- Optionally with magnifying lamp holder

### Accessories

Magnifying lamp adapter, integrated, Art. 41812	,-
Magnifying lamp adapter, side assembly, Art. 41804	,-



- Height: approx. 82 cm
- Width (without handle): 45 cm
- Width (including handle): 54 cm
- Depth: 45 cm



### Pull-out tray

The extendable tray offers a convenient storage area for all treatments.



### Drawer with Tip-On-Technology

The drawers can be easily opened with their Tip-On-Technology with the touch of a finger.



### Integrated fold-out compartment

Used materials can be disposed of immediately in the folding compartment in the front.



### Side storage compartments

The side compartments accessible from both sides provide additional practical storage space.

# Abadía Retuerta

## Valladolid, Spain





# CL Trolley



CL Trolley  
 With 3 drawers

## CL Trolley

A visual highlight for your workspace and a practical helper at the same time - this is the CL Trolley mobile preparation trolley. Extraordinarily designed in its shape and in a modern semi-metal look, it offers everything that makes work simple: There is plenty of room for your products in the compartments of the semicircular front; and three rear-facing drawers guarantee clarity and quick access to everything you need for your treatments. You can also dispense individual facial tissues very practically from a special device. Equipped with a railing and pleasantly quiet lightweight castors, the preparation trolley can be easily transported wherever you need it. And of course you can choose "your" CL Trolley from a variety of decors to match your workspace equipment.

### Features:

- Mobile preparation trolley in modern semi-metal look
- Recessed storage surface for preparations above
- Device for individually dispensing facial tissues
- Storage compartments on the front side
- Three drawers in the rear area, arranged in a terrace pattern
- Railing
- Available in different decors
- With lightweight castors

### Accessories

Magnifying lamp adapter, integrated, Art. 41812	,-,-
Magnifying lamp adapter, side assembly, Art. 41804	,-,-

 • Height: approx. 78 cm  
 • Width: approx. 44 cm  
 • Depth: approx. 67 cm



#### Recessed storage surface

In the recessed storage surface, products can be securely set aside during your treatments. The built-in facial tissue dispenser is also practical.



#### Clear & handy

Thanks to the three terraced drawers on the back of the CL Trolley, you can store everything clearly and within easy reach.



#### Enough space

The two compartments in the semicircular front can be used for a supply of products.

# GL Trolley series



GL60 Trolley  
Art. 35120



GL45 Trolley  
Art. 35121



GL Square Trolley  
Art. 35117

## Gharieni GL Trolley series

The GL Trolleys are equipped with a practical pull-out shelf for various devices and three drawers. In different sizes, it offers you the storage space that you need for tidy work. Comes standard in white or wenge, but other decors are also optionally possible. On request, the Trolley is also available with a magnifying lamp holder. Four large rubber castors, two of which are brakable, make the GL Trolley mobile.

### Features:

#### GL 60/45 Trolley

- Pull-out shelf for various devices
- Three drawers
- Four large rubber castors, of which two are brakable
- In five standard decors (see page 19), optional in other decors
- Optionally with magnifying lamp holder

#### GL Square Trolley

- Pull-out shelf for various devices
- Three drawers
- Four large rubber castors, of which two are brakable
- In five standard decors (see page 19), optional in other decors
- Optionally with magnifying lamp holder

### Accessories

Magnifying lamp adapter, side assembly, Art. 41804

,-,-

#### GL60 Trolley

- Height: 80 cm
- Width: 60 cm
- Depth: 40 cm



#### GL45 Trolley

- Height: 80 cm
- Width: 45 cm
- Depth: 40 cm

#### GL Square Trolley

- Height: 102 cm
- Width: 40 cm
- Depth: 42 cm



#### Removable storage shelf

The removable storage shelf provides space for devices or your work instruments.



#### Suitable for magnifying lamp

The optional magnifying lamp holder allows you to equip the trolley with the right lighting for your treatments.



#### Space for one Hot Cabi

The Trolley GL Square offers the possibility to integrate a Hot Cabi.

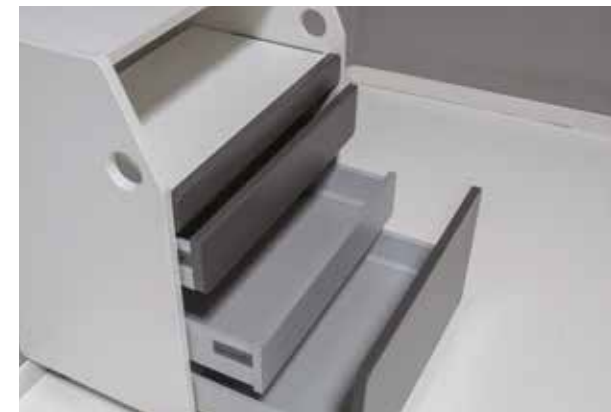

#### Spacious drawers

Three drawers provide ample storage space, so you can accommodate all the important things for your work.

# Cube Trolley series



Cube Square Trolley

With castors	-,-
Without castors	-,-
Base in chrome,	-,-



## Gharieni Cube Square

The Cube Square Trolley, with its modern, simple design, is available in three versions: a large drawer and an internal storage compartment, with two drawers, or a drawer and a storage compartment. Particularly practical: The smaller drawers can be pulled out on both sides. The trolley is available in different decors (up to two colors); and the square metal base can be (optionally) selected in white, titanium, black, or chrome. For a look that fits your workspace, you can also configure the Cube Square into one of our numerous other decors.

Equipped with lightweight castors, the trolley is also perfectly mobile.

### Features:

- Modern, clear design
- Wood decor in white and wenge
- Optional two-tone
- High-end metal-wood combination
- Square metal base in white, titanium, or black-brown
- Chrome base optional
- Additional decor versions possible
- Available in three versions: With a large drawer and internal storage compartment, with two drawers, or with a drawer and a storage compartment
- Small drawers can be pulled out on both sides
- Brakable lightweight castors

### Accessories

Magnifying lamp adapter, integrated, Art. 41812	,-
Magnifying lamp adapter, side assembly, Art. 41804	,-



- Height: 78.5 cm
- Width: 43.6 cm
- Depth: 46 cm



Drawers can be pulled out on both sides

A clever detail on the Cube Trolley: the drawers can be pulled out on both sides. This way you have quick access to your work instruments from all sides.



Modern design

Its wood-paint-metal look makes the Cube Square Trolley a visual highlight. Of course, it can also be configured in a monochrome design. Ask about our current wood decor palette!



Optional: Chrome base

In addition to the standard colors white, black-brown, and titanium, the base of the Cube Trolleys is also available in elegant chrome.



With or without castors

In addition to the large smooth-running castors, the Cube Square Trolley can be equipped with a simple immovable stand.

# Cube Trolley series



## Cube Select Trolley

With castors	7,500
Without castors	7,500
Base in chrome,	7,500

## Gharieni Cube Select

With the Cube Select trolley, you can choose between two equipment variants: a large-capacity drawer and two medium-sized drawers. In the version with smooth-running wheels, the Gharieni Cube Select can be moved wherever you need it.

With its noble metal-wood combination - from five standard decors and its round metal base in white, titanium look, black-brown or optionally in chrome - this practical trolley looks extremely classy. It is also available in other décor variants on request.

### Features:

- Optionally with a large drawer and two spacious inner surfaces or with two medium-sized drawers
- High-end metal-wood combination
- In five standard decors (see page 19), optional in other decors
- Metal base with round column in white, titanium, or black-brown
- Large lightweight castors
- Also without castors
- Optional metal base in chrome available
- Additional decor versions optional

### Accessories

Magnifying lamp adapter, integrated, Art. 41812 -,-

Magnifying lamp adapter, side assembly, Art. 41804 -,-



- Height with castors: 74 cm
- Width: 41 cm
- Depth: 43 cm



### Various drawers

With the Cube Select, you can choose between a large-capacity drawer with two spacious inner compartments or two medium-sized drawers.



### Elegant metal base

The metal base with its slim, round column makes the trolley look very light. Available in white, black-brown, titanium, and chrome.

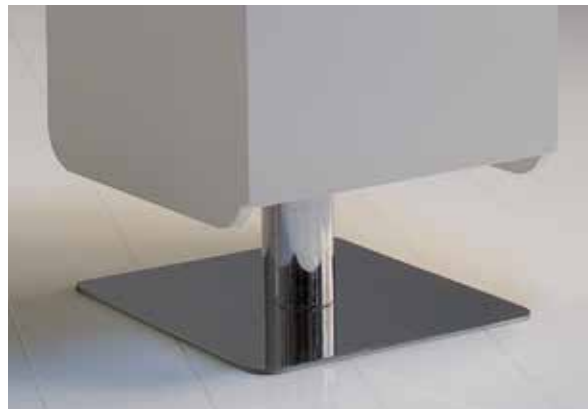

### With or without castors

In addition to the large lightweight castors, the Cube Trolley can be equipped with a simple stationary stand.



### Matching: Manicure table Cube

On page 286 in this catalog you will also find the matching manicure tables from our Cube series.

# Vario series



Vario Select

With doors	,-,-
Without doors	,-,-



Vario Square

With doors	,-,-
Without doors	,-,-



# Gharieni Vario Series

The Vario Square and Vario Select trolleys offer a wide range of options for practical work in any location. The upper shelf can be swiveled to the side and the inner shelves can be mounted at different heights as required. Depending on your needs, a Hot Cabi or Hot Stone Warmer can also be optionally integrated into the Vario Square. Our wide decor range also gives you the opportunity to adapt the trolley perfectly to your ambience.

### Features:

- Upper shelf can be swiveled laterally
- Inner shelves can be mounted at different heights
- Installation of a Hot Cabi or Hot Stone Warmer optional
- In five standard decors (see page 19), optional in other decors
- Metal curves in white, titanium, or black-brown
- Special equipment possible
- with lightweight castors



Sophisticated curves or classical square

Its curved metal parts give the Vario Select a particularly elegant look. However, the Vario Square appears classically straight with its angular edges. The choice is yours!



Swiveling shelves

The top compartment holds a Hot Cabi or a Hot Stone Warmer. The split cover can be swiveled sideways. This gives you access to the Hot Stone Warmer from the top.



Storage space

The shelves inside the cabinet are individually mountable. Instead of the Hot Stone Warmer, other devices such as our small Hot Cabi can be installed.



- Height: 80 cm
- Width (closed): 70 cm
- Width (with open panels): 130 cm
- Depth: 43 cm

# GlaStyle



GlaStyle	
With 1 tray	7,77
With 2 trays	7,77
With 3 trays	7,77

## Gharieni GlaStyle

An equipment trolley with an extraordinary design – that's the GlaStyle. The combination of metal and glass and its curved design make it an exceptional helper in your studio. With up to three height-adjustable and swiveling glass tops, it offers you enough storage space for everything you need for your treatments. Also practical are the integrated magnifying lamp holder and the lightweight castors. These allow you to easily move the GlaStyle to where you need it. In addition to the number of glass surfaces, you can also choose the color of the base to your liking in white or titanium.

### Features:

- Up to three swiveling shelves in glass decor with chrome-plated edging
- Height-adjustable and swiveling glass tops
- Railing can be shortened
- Base in white or titanium
- Magnifying lamp holder
- With brakable lightweight castors



- Height: 89 cm
- Width (closed): 50 cm
- Width (including steamer): 82 cm
- Depth (without handle): 48 cm
- Depth (including handle): 54 cm



Glass surfaces with railing

The glass shelves are equipped with a railing that can be shortened. This allows everything to be stored securely to prevent it from falling.



Color of your choice

You can choose the base of the trolley in white or titanium.



With magnifying lamp

Thanks to the integrated holder, you can also equip the preparation and device trolley with a magnifying lamp.



Easy to move

With its large lightweight castors, the GlaStyle is mobile and at the same time stable. In addition, the base of GlaStyle offers a practical little waste container.

# Lamica Trolley series



Lamica Decor Line Trolley

With 2 tray compartments	,-,-
With 3 tray compartments	,-,-
Drawer	,-,-



Lamica Wood Decor Trolley

With 2 tray compartments	,-,-
With 3 tray compartments	,-,-
Drawer	,-,-



Lamica Glass Decor Trolley

With 2 tray compartments	,-,-
With 3 tray compartments	,-,-
Drawer	,-,-
Glass drawer holder	,-,-



## Gharieni Lamica Trolley

Do you need a versatile trolley in your workspace? Then the Lamica model is just right for you! Because the trolley can be customized. This way you can choose from two or three shelves as well as a drawer. In addition, it can be equipped with a sanitary container with holder.

The design can also be chosen as desired: The shelves are available with an elegant glass and wood look or in classic white. The frame is available in titanium, black-brown, or chrome; and the large lightweight castors are color-matched to it.

### Features:

- With two or three shelves
- With railing
- With or without drawer
- In a sophisticated glass and wood look or in classical white
- Frame in titanium, black-brown, or chrome-plated
- On large, color-matched lightweight castors
- Optionally with magnifying lamp holder,

### Accessories

Magnifying lamp adapter, Art. 41820

---

Water bowl with holder, Art. 41180

---



Optional magnifying lamp holder

For practical work, the trolley optionally offers a holder for a magnifying lamp. In addition to your work instruments, you will always have the right lighting in your area.



Optional collection container

Used material can be stored in the stainless steel bowl attached to a holder. For best positioning, the holder can be adjusted horizontally and vertically.



#### Lamica Wood Decor Trolley

- Height with 2 shelves: 76 cm
- Height with 3 shelves: 94 cm
- Width: 65 cm
- Depth: 42 cm

#### Lamica Decor Line Trolley

- Height with 2 shelves: 76 cm
- Height with 3 shelves: 94 cm
- Width: 59,5 cm
- Depth: 42 cm

#### Lamica Glass Decor Trolley

- Height with 2 shelves: 79 cm
- Height with 3 shelves: 95,5 cm
- Width: 65 cm
- Depth: 42 cm



Optional drawer

On request, the Lamica can also be equipped with a drawer to match the look.

# Four Seasons Hotel at The Surf Club

Surfside, Florida, USA





Photos: © Four Seasons

# Mano



Mano manicure table  
Glass top in white or black

## Gharieni Mano

This manicure table looks particularly light and elegant with its special curved glass top. The practical drawer container with its easy-open Tip-On compartments offers space for everything you need for a manicure. And of course, the manicure table also has an integrated lamp holder. When it comes to design, the Mano leaves nothing to be desired. Thus you can choose its glass top in white or black and the metal parts in white, titanium, or black-brown. So that the Mano optimally matches the ambience of your workspace, we have a large collection of wood decors ready for you.

### Features:

- Worktop made of special curved glass
- With drawer container
- Drawers with Tip-On-Technology
- With black or white glass top
- Container available in different wood decors
- Metal elements in white, titanium, black-brown
- Integrated lamp holder (without lamp)

### Accessories

Slimline LED working light, Art. 41820



#### For perfect lighting

The integrated lamp holder is suitable for our Slimline LED working light. This not only ensures optimal lighting, but also a visually compelling overall appearance.



#### Large amount of space

With three drawers, the Mano container provides ample space for all the tools you need for a manicure.

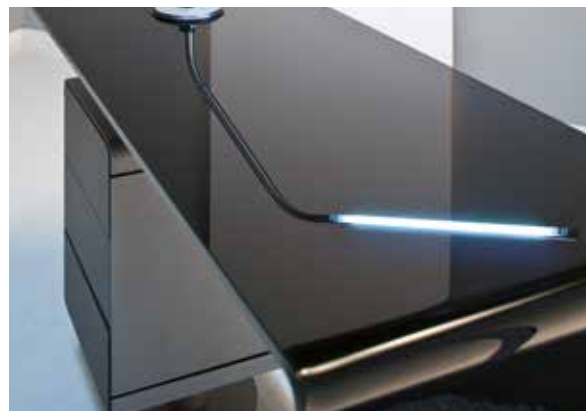

#### Curved glass top

The curved plate made of special glass in black or white looks light and sophisticated at the same time.



#### Just simply Tip-On

A slight pressure is all it takes and the drawers open quietly. As a result, no handles are needed. This creates a clean look.



- Height: 79.5 cm
- Width: 129 cm
- Depth: 57 cm

# Cube Select



Cube Select manicure table

Without suction	,-
With suction	,-
Metal parts in chrome	,-



Cube Select Duo manicure table

Without suction	,-
With suction	,-
Metal parts in chrome	,-

## Gharieni Cube Select

The Cube Select manicure table looks very sophisticated with its metal-wood combination. With five standard decors and its round metal base in white, titanium, black-brown, or chrome (optional), it integrates into any workspace ambience. Upon request, it is additionally available in other decor versions. Choose the manicure table with one maxi or two medium-sized drawers with soft-close.

### Features:

- With one or two drawer containers
- Container with one maxi or two medium-sized drawers with soft-close.
- With or without suction
- In five standard decors (see page 19), optional in other decors
- Metal elements in white, titanium, black-brown, or chrome (additional charge)



### Optional suction

If you opt for the suction system embedded in the table top, you'll no longer be bothered by annoying nail dust.



### Storage space upon request

When equipping the container(s), you can choose between one large-capacity drawer with two spacious inner compartments or two medium-sized drawers.



### Metal parts in chrome

In addition to the standard colors white, black-brown, and titanium, the bases of the Cube manicure table are also available in elegant chrome.



### Perfectly combinable

For practical working and a uniform appearance, the Cube Select manicure table can be combined with the Cube Select Trolley (see page 274).

### Manicure Table Cube Select

- Height: 81 cm
- Width: 125 cm
- Depth: 50 cm



### Manicure Table Cube Select Duo

- Height: 81 cm
- Width: 154 cm
- Depth: 50 cm

# Le Lana Courchevel, France







© Le Lana

# Stools & Chairs



# Stools & Chairs

Not only your customers should be comfortable during the treatment! In order to be able to work comfortably and efficiently, the working chair factor plays a role that is not to be underestimated. Here, the focus is on ergonomics. This includes not only a comfortable seat surface, but also optimum adjustability. Our stools and chairs offer you all these features. Find exactly the right chair to suit you and your work from our wide range of products.

We also don't come up short in terms of looks. Optionally, you can configure our working chairs, in addition to the standard white, in different colors to suit your personal ambience. In addition, with our four castor base versions, we offer optimum possibilities to configure your personal working chair. Optional extras like our Floating feature and Airback-Technology round out our offering.

### Features:

- Stools and chairs come standard with white upholstery (except PU stools) and black base
- Rotatable seat
- Rubber castors with Roll-Stop function
- Comfortable upholstery
- Washable and durable cover
- Synthetic leather cover optional in various colors from the current Gharieni or Ferrari Stamskin color collection (see catalog cover)
- Pneumatic height adjustment
- 5-castor safety base
- Four different castor base versions

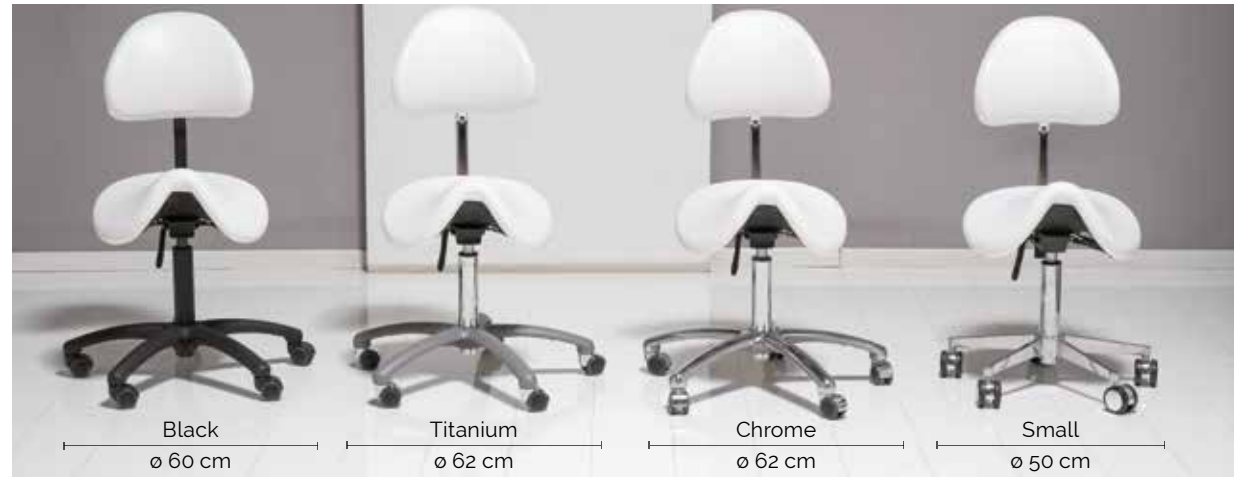

Four stool bases to choose from

For most of our stools we offer four bases to choose from. By default, a black star with black pneumatic spring is included in the price.

Stool-Star, black, ø 60 cm	,-,-
Stool-Star, titanium, ø 62 cm	,-,-
Stool-Star, chrome, ø 62 cm	,-,-
Stool-Star, small, chrome, ø 50 cm	,-,-



Foot release (height adjustment by foot) 42518	,-,-
Footrest ring (Footrest for high stools/chairs) 42500	,-,-



Upholstery in different colors

Our stools and chairs come standard equipped with white synthetic leather. Optionally, you can also choose a colorful cover from our current Gharieni or Ferrari Stamskin color chart (page 21).

Additional color charge stool, standard upholstery	,-,-
Additional color charge stool, Ferrari Stamskin upholstery	,-,-
Additional color charge chair, standard upholstery	,-,-
Additional color charge chair, Ferrari Stamskin upholstery	,-,-

# Stools & Chairs



Anatomical saddle-seat stool  
Large

59-80 cm height adjustment

Art. 42512



Integrated  
air chambers

Manual  
air chamber  
pump

Anatomical saddle-seat stool  
Large "Air"

59-80 cm height adjustment  
integrated air chambers for pressure relief

Art. 42412



Adapted to the  
male anatomy

Anatomical saddle-seat stool  
Large "For Men"

59-80 cm height adjustment  
Cut-out in the front seat area

Art. 42411



## Chair/Stool "Anatomical saddle-seat"

Our specialists when it comes to ergonomics are the anatomical saddle-seat stools and chairs. Thanks to their specially curved seat design in the Large and Small versions, the saddle-shaped seats ensure optimal pressure distribution in the buttock-area while relieving the strain on the thighs. The "For Men" model, with its recess in the front part of the seat, also caters to the special ergonomic needs of men.

The "floating" version also offers a seat that swings in all directions to maintain the mobility of the pelvis and promote the flexibility of the discs.

All models have the obligatory height adjustment and the five-caster safety base. The chair model is also equipped with an adjustable backrest and a tilting seat.

### Features:

- Anatomically-shaped saddle-seat
- Pneumatic height adjustment
- Rotating saddle-seat
- Comfortable upholstery
- Chair version with inclinable seat to relieve pressure on the thighs
- "Air" chair version with air chambers to relieve pressure
- Washable and durable cover
- Synthetic leather cover in white
- 5-caster safety base
- Rubber castors with Roll-Stop function
- Optional with floating equipment: swinging, adaptable to the movement of the seat, in two types of firmness (soft and medium)
- Base in three colors: Black (standard), titanium, or chrome
- Four base versions (see page 291)



Anatomical saddle-seat stool  
Small "Floating"

47-63 cm height adjustment  
with movable seat with 2 degrees of firmness

Art. 42401W	soft	-,-
Art. 42401M	medium	-,-
Art. 42401OF	without floating	-,-



Anatomical "Small" saddle-seat  
chair

Height adjustment 47-63 cm (short pneumatic spring), 56-80 cm (long pneumatic spring)

Art. 42501	with short pneumatic spring	-,-
Art. 42498	with long pneumatic spring	-,-

# Stools & Chairs

## Chair/Stool "Saddle-seat"

Our saddle-seat chairs or stools have a specially shaped seat similar to a bicycle. The advantage here: The recesses on the seat minimize the unpleasant pressure of the seat on the thighs.

The durable synthetic leather upholstery is available in different colors (see color chart in the cover)

All models have the obligatory height adjustment and the five-castor safety base. The chair model is also equipped with an adjustable backrest as well as a tilting seat.

### Features:

- 50-62 cm height adjustment
- Saddle-shaped, flat seat
- Pneumatic height adjustment
- Rotating saddle-seat
- Chair version optionally with inclinable seat to relieve pressure on the thighs
- Comfortable upholstery
- Washable and durable cover
- Synthetic leather cover in white, additional colors optional
- 5-castor safety base
- Rubber castors with Roll-Stop function
- Base in three colors: Black (standard), titanium, or chrome
- Four base versions (see page 291)



Saddle-seat stool

Art. 42502



Saddle-seat chair

Art. 42506

Art. 42509 with inclinable seat

## "Round" chair/stool

Our round stools and chairs feature comfortable and robust upholstery.

The durable synthetic leather cover is available in different colors (see color chart in the cover)

All models have the obligatory height adjustment and the five-caster safety base. The chair model is also equipped with an adjustable backrest as well as a tilting seat.

### Features:

- 50-62 cm height adjustment
- Round, flat seat
- Pneumatic height adjustment
- Rotatable seat
- Chair version optionally with inclinable seat to relieve pressure on the thighs
- Comfortable upholstery
- Washable and durable cover
- Synthetic leather cover in white, additional colors optional
- 5-caster safety base
- Rubber castors with Roll-Stop function
- Base in three colors: Black (standard), titanium, or chrome
- Four base versions (see page 291)



Stool with round seat

Art. 42503

,-,-



Chair with round seat

Art. 42505

,-,-

Art. 42508 with inclinable seat

,-,-

# Stools & Chairs



"PU" stools

Art. 42420



"PU" chair with curved rest

Art. 42430



## "PU" stools

The stool with the exceptional design and integrated backrest is available in both polyurethane and synthetic leather upholstery. Its specially shaped seat supports upright spinal posture during work.

The stool is height-adjustable via a lever and has a 5-caster safety base.

### Features:

- Pneumatic height adjustment of 46-59.5 cm
- Ergonomically-shaped seat and integrated PU backrest
- Comfortable upholstery
- Washable and durable surface in anthracite
- Also available with synthetic leather cover
- 5-caster safety base
- Rubber castors with Roll-Stop function
- Base in three colors: Black (standard), titanium, or chrome
- Four base versions (see page 329)

## "PU" chair

In this functional chair, both the seat and the backrests are made of robust and easy-to-clean polyurethane. The backrest can be moved to the left and right while seated and can therefore also be used as an armrest.

The chair is also height-adjustable via a lever and has a 5-caster safety base.

### Features:

- Pneumatic height adjustment of 50-63 cm
- Round seat and independently rotatable backrest made of PU
- Comfortable upholstery
- Washable and durable surface in grey
- 5-caster safety base
- Rubber castors with Roll-Stop function
- Comes standard with a black base, optional in titanium or chrome
- Four base versions (see page 291)



## "Oval" chair

With its wider seat and curved, height-adjustable backrest, the chair with oval seat provides comfort. In addition, it can be equipped with the Air-Floating system, which with its air chambers allows the adjustment of the seat upholstery to your personal needs. The optional seat tilt adjustment provides relief for the thighs.

### Features:

- Pneumatic height adjustment of 50-63 cm
- Rotating oval seat
- Optionally with inclinable seat to relieve pressure on the thighs
- Washable and durable cover
- Synthetic leather cover in white or color
- Optionally with Air-Floating System (AFS) for more comfort and to avoid pressure points
- 5-castor safety base
- Rubber castors with Roll-Stop function
- Base in three colors: Black (standard), titanium, or chrome)
- Four base versions (see page page 291)

## "Dental type" chair

With this functional chair, the backrest can also be moved to the left and right while seated and can therefore also be used as an armrest.

The chair is height-adjustable via a lever and has a 5-castor safety base.

### Features:

- Pneumatic height adjustment of 50-62 cm
- Round seat and rotating backrest
- Comfortable upholstery and upholstered backrest
- Optional with floating equipment: swinging, adaptable to the movement of the seat, in two types of firmness
- Durable cover in white or color
- 5-castor safety base
- Rubber castors with Roll-Stop function
- Standard with black base, optional in titanium or chrome
- Four base versions (see page 291)

Air-Floating System:  
Integrated air chambers  
for more seating comfort



"Oval" chair

Art. 42515	,-,-
Art. 42516 with inclinable seat	,-,-
Art. 42515AF with Air-Floating-System	,-,-
Art. 42516AF inclinable AFS	,-,-



"Dental type" chair

Art. 72100	,-,-
Art. 72101 with Floating-Option	,-,-

# Stools & Chairs

## "Square" chair

A modern design with clean lines and extremely comfortable – this is the "Square" Chair. Whether as a working chair with and without a backrest or as a makeup chair, the Square offers an exclusive solution for most requirements. The robust, easy-to-clean synthetic leather upholstery is available as standard in white or optionally in other colors from our current color charts (see cover). In addition to the obligatory height adjustment, the makeup chair has a footrest ring for optimum seating comfort.

### Features:

- In three chair versions: Working chair with and without armrests or makeup chair
- Pneumatic height adjustment from 47-63 cm (working chair), approx. 57 - 83 cm (makeup chair)
- Rotating, angular chair
- Comfortable upholstery and backrest
- Armrests
- Washable and durable cover
- Synthetic leather cover in white or color
- Optionally with castors or fixed base
- Rubber castors with Roll-Stop function



"Square" chair without armrest

Art. 42802

,-



"Square" chair with armrest

Art. 42800

,-



"Square" makeup chair

Art. 42801

,-

## "Small" chair

With its angular shape, the "Small" is one of the classic working chairs. It features enormous versatility: Whether with or without armrests, with or without castors, or as a makeup chair, the "Small" offers the right seating to meet every need.

The standard white seat and backrest can also be chosen in one color from our color chart (see cover).

In addition to the obligatory height adjustment, the makeup chair has a foot rest ring for optimum seating comfort.

### Features:

- "Small" without armrests height adjustment: 47-60 cm, "Small" with armrests: 40-53 cm, "Small" makeup chair: 57-83 cm
- Rotating, angular chair
- Optional: inclinable seat to relieve pressure on the thighs
- Comfortable upholstery and backrest
- Washable and durable cover
- Synthetic leather cover in white or color
- Choose from castors or fixed base
- Rubber castors with Roll-Stop function
- Comes standard with a black base, optional in titanium or chrome (depends upon the model)
- Four base versions (see page page 291)



"Small" chair without armrest

Art. 42504

,-,-

Art. 42507 with inclinable seat

,-,-

"Small" chair with armrest

Art. 42555

,-,-

"Small" makeup chair

Art. 42076

,-,-

# Sofitel Frankfurt Opera Germany







Moers, Germany | Sales + Showroom // Gharieni Group GmbH • Gutenbergstr. 40 • D-47443 Moers  
Moers, Germany | Distribution + Service // Gharieni Group GmbH • Am Schürmannshütt 24 • D-47441 Moers  
Tel: +49 - (0) 28 41 - 88 300 - 0 • Fax: +49 - (0) 28 41 - 88 300 - 333 • [www.gharieni.de](http://www.gharieni.de) • [info@gharieni.com](mailto:info@gharieni.com)

Ettlingen | Germany // Gharieni Süd GmbH • Siemensstr. 11 • D-76275 Ettlingen  
Tel: +49-(0)7243-3322-363 • Fax: +49-(0)7243-3322-391 • [ettlingen@gharieni.com](mailto:ettlingen@gharieni.com)

Nederweert | BeNeLux // Gharieni Nederland BV • Hulsenweg 14 • NL-6031 SP Nederweert  
Tel: +31 (0) 495 - 63 30 36 • Fax: +31 (0) 495 - 62 66 63 • [www.gharieni.nl](http://www.gharieni.nl) • [info@gharieni.nl](mailto:info@gharieni.nl)

Dubai | UAE // Gharieni Middle East FZ-LLC • Park Hyatt Hotel • Dubai Creek Club St., P.O. Box 333203 • Dubai  
Tel: +971 (0) 4 602 1819 • [www.gharieni.ae](http://www.gharieni.ae) • [info@gharieni.ae](mailto:info@gharieni.ae)

Aventura | USA // Gharieni USA Inc. • JW Marriott Miami Turnberry Resort & Spa • 19999 West Country Club Drive  
Aventura Florida 33180 • Tel: +1 (855) 378 4772 • [www.gharieni.com](http://www.gharieni.com) • [info@gharieni.com](mailto:info@gharieni.com)