



SUPERBOLT

ELECTRIC BALANCE BIKE MANUAL

BEFORE RIDING SUPERBOLT ELECTRIC BALANCE BIKE

PLEASE READ MANUAL CAREFULLY BEFORE OPERATING

Read and understand this entire manual before allowing a child to use this product!

NOTE: Manual illustrations are for demonstration purposes only. Illustrations may not reflect exact appearance of actual product. Specifications are subject to change without notice. Please have your product Serial Number (S/N) and a copy of your receipt before contacting Superbolt for warranty assistance and/or replacement parts.

⚠ WARNING: Riding an electric balance bike does present potential risks, and caution is required. Like any riding product, an electric balance bike has inherent hazards associated with its use (for example, falling off or riding it into a hazardous situation). Like any riding product, electric balance bikes can and are intended to move; therefore, it is possible to lose control or otherwise get into dangerous situations. Both children and the adults responsible for supervising them, must recognize that if such hazards occur, a rider can be seriously injured or die even when using safety equipment and other precautions. **RIDE AT YOUR OWN RISK AND USE COMMON SENSE.**

⚠ WARNING: PARENTAL AND ADULT RESPONSIBILITY AND SUPERVISION NECESSARY:

This manual contains important safety information. It is your responsibility to review this information and make sure that all riders understand all warnings, cautions, instructions, and safety topics, and assure that young riders are able to safely and responsibly use these products. Superbolt recommends that you periodically review and reinforce the information in this manual with younger riders, and that you inspect and maintain your children's product to ensure their safety. If you delegate this task to another adult, it is YOUR RESPONSIBILITY to pass this owner's manual and all relevant information to whomever will take on this role and to ensure without question that the



rider is supervised, controlled, and taught in a safe manner.

⚠ WARNING: THESE MODELS ARE NOT FOR CHILDREN HEAVIER THAN 132 LB (60 KG). No children should ride any Superbolt electric balance bike if they cannot sit on the seat and touch both feet flat on the ground at the same time. Because products, like electric balance bikes, can and do present potential hazards plainly associated with their use, it is well recognized THE NEED FOR EXERCISE OF PARENTAL RESPONSIBILITY IN SELECTING RIDING PRODUCTS APPROPRIATE TO THE AGE, SIZE AND DEVELOPMENTAL PROGRESS OF A CHILD, OR PARENTAL SUPERVISION IN SITUATIONS IN WHICH CHILDREN OF VARIOUS AGES MAY HAVE ACCESS TO THE SAME RIDING PRODUCTS, IS IMPORTANT. This recommendation is based not just on age or weight or height – it reflects consideration of coordination and skills as well as physical size. Certainly, any rider unable to fit comfortably on the Superbolt electric balance bike should not attempt to ride it, but a parent’s decision to allow his or her child to ride these products should be based on the child’s maturity, skill, and ability to follow directions and rules. These products are intended for use only by children who are, at a minimum, completely comfortable and competent while operating these products in conjunction with parental assistance. Children with any mental or physical conditions that may make them susceptible to injury, or impair their physical dexterity or mental capabilities to recognize, understand, and follow safety instructions and to be able to understand the hazards inherent in a product’s use should not use or be permitted to use this product if determined inappropriate for their abilities. Children or adults with heart conditions, head, back or neck ailments (or prior surgeries to these areas of the body), or pregnant women should not operate or provide supervision to these products. Not every product is appropriate for every age or size of child, and different age recommendations are found within this category of product which is intended to reflect the nature of the hazards and the expected mental or physical ability, or both, of a rider to cope with the hazards.

NOTE: In order to ensure the product capability, the test is based on a load of 154lb (70kg) as a test standard. However, the product load is still recommended not to exceed 132lb (60kg). For more information, please visit: ridesuperbolt.com

TABLE OF CONTENTS

1. COMPONENTS	4
2. ASSEMBLE YOUR ELECTRIC BALANCE BIKE	6
3. ACCEPTABLE RIDING PRACTICES & CONDITIONS	9
Pre-Ride Inspection and Checklist	
Battery	
Powering On/Off	
Changing Speed Mode	
4. BEFORE RIDING	15
The Starting Process	
Battery Status	
5. TROUBLESHOOTING	18
Troubleshooting Problems	
Technical Processes	
Checking the Battery	
Replacing the Fuse	
Replacing the Throttle, Monitor, and Power Switch	
Replacing the Brake Lever	
Replacing the Control Board	
Replacing the Motor	
6. WARRANTY	27
7. FREQUENTLY ASKED QUESTIONS	30



1. COMPONENTS

- | | |
|-----------------------|---------------------|
| 1. THROTTLE GRIP | 12. SIDE COVER |
| 2. STEM | 13. CHAIN GUARD |
| 3. GRIP | 14. CHAIN TENSIONER |
| 4. POWER OFF BRAKE | 15. REAR AXLE NUTS |
| 5. HANDLEBAR | 16. DRUM BRAKE |
| 6. HEADSET | 17. REAR WHEEL |
| 7. FORK | 18. SEAT CLAMP |
| 8. FRONT WHEEL | 19. SEAT POST |
| 9. FRONT AXLE NUTS | 20. SADDLE |
| 10. BATTERY | 21. FRAME |
| 11. FOOTREST PLATFORM | |

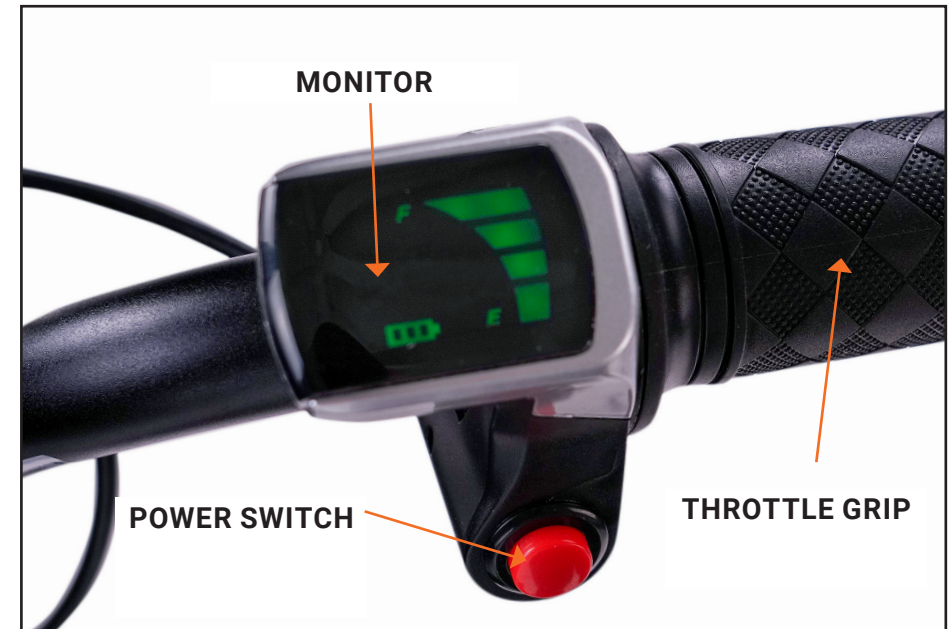
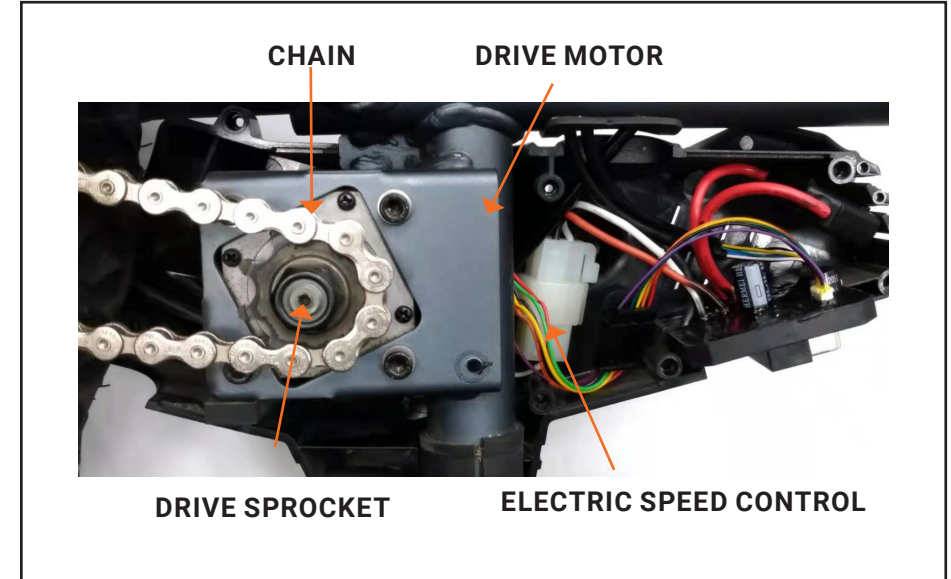



2. ASSEMBLE YOUR ELECTRIC BALANCE BIKE

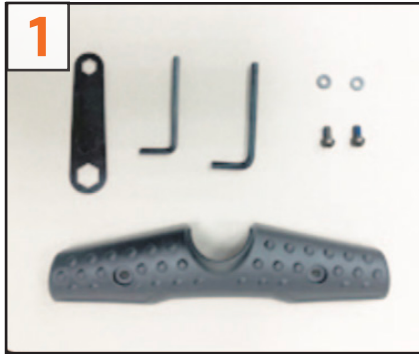

1
You should have the following parts:
Box end wrench, 4mm Hex key, 5mm
Hex key, Foot rest platform (x1), Screw
(x2), Washer (x2).



2
Remove front cap from handlebar
stem.



3
Put handlebar on the stem and adjust
the angle.



4
Secure the stem cap by threading
the screws in an alternating diagonal
pattern. Ensure that the handlebars
are at the proper angle and tighten
fully.



5
Assemble front wheel to the fork.



6
Shown above: secondary retention
washer for front wheel.



7
Assemble secondary retention washer
on front wheel axle and hook onto
lower hole of the front fork. Tighten
screw nut using the box end wrench.

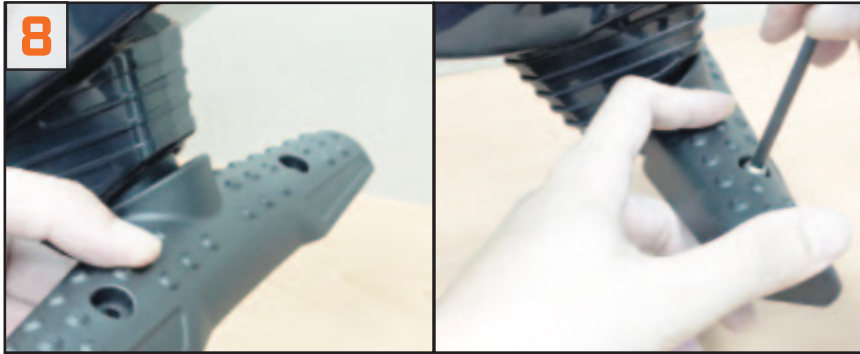

Align the foot rest platform and secure with the washers and screws using the 4mm Hex key.



Loosen the seat clamp to adjust seat height. After adjustment, tighten the seat clamp using the 5mm Hex key.

3. ACCEPTABLE RIDING PRACTICES AND CONDITIONS

⚠ WARNING: Always check and obey any local laws or regulations, which may affect the locations where the electric balance bike may be used. Keep safely away from cars and motor vehicle traffic at all times, and only use where allowed and with caution. Never ride your Superbolt electric balance bike on public streets, roads, highways, at night, or when visibility is limited.

Do not activate the speed control on the hand grip unless you are on the electric balance bike and in a safe, outdoor environment suitable for riding. The maximum speed of the bike is limited by the selected power mode (See Throttle Operation section below). Avoid excessive speeds that can be associated with downhill rides. Maintain a grip on the handlebars with both hands at all times. Do not touch the brake or motor on your electric balance bike when in use or immediately after riding, as these parts can become very hot. Ride defensively. Watch out for potential obstacles that could catch your wheel or force you to swerve suddenly or lose control. Be careful to avoid pedestrians, skaters, skateboards, scooters, bikes, children, or animals who may enter your path, and respect the rights and property of others. This electric balance bike is intended for use on flat, dry surfaces, without loose debris, such as sand, leaves, rocks, or gravel. Wet, slick, bumpy, uneven, or rough surfaces may impair traction and contribute to possible accidents. Do not ride your electric balance bike through mud, over ice, through puddles, in wet or icy weather and never immerse or wash the electric balance bike with water, as the electrical and drive components could be damaged by water or create other possibly unsafe conditions. Never use near steps or swimming pools.

Avoid sharp bumps, drainage grates, and sudden surface changes. Do not attempt or do stunts or tricks on your electric balance bike. This electric balance bike is not made to withstand abuse from misuse such as jumping, curb grinding, or any other type of stunts. Racing, stunt riding, or other maneuvers also enhance risk of loss of control or may cause uncontrolled rider actions or reactions. Never allow more than one person at a time to ride the electric balance bike. Do not ride at night or when visibility is limited. Never use headphones, a cell phone or text when riding. Never risk damaging surfaces, such as carpet or flooring, by use of an electric balance bike indoors. Never tow anything or anyone with or allow your electric balance bike to be towed by any other person or vehicle, motorized or not.

Please ride your electric balance bike in a controlled environment and do not ride on public streets, open roads and highways.



POWERED & ROTATING PARTS WARNING:

Never operate the electric balance bike without the side panels and chain guard properly installed. Do not allow hands, feet, hair, body parts, clothing, or similar articles to come in contact with any rotating or moving parts, wheels, or drive train components and chain while the motor is running or while the wheels and tires are rotating.

PROPER RIDING ATTIRE:

Always wear proper protective equipment, such as an approved and properly fitted safety helmet (with chin strap securely buckled), eye protection, athletic shoes (lace-up shoes with rubber soles), elbow pads, and kneepads. Keep shoelaces tied and out of the way of the wheels, motor, and drive system. Never ride barefoot or in sandals. Long-sleeved shirt, long pants, and gloves are recommended. Furthermore, a helmet may be required by local law or regulation in your area. Your child's brain is their most valuable asset, MAKE THEM WEAR AN APPROVED, PROPERLY FITTED, AND BUCKLED HELMET!

SAFELY APPROACHING OR RE-MOUNTING THE ELECTRIC BALANCE BIKE:

During adult supervision always teach children to approach the electric balance bike with caution; before use, while standing back up if knocked over, or after a spill.

POWERING OFF AND ON

1. Press and hold power switch for 3 seconds to turn off the electric balance bike
2. Ensure all wheels/tires and drive train components have stopped rotating or moving.
3. Inspect for any obvious damage.
4. Perform a "Pre-Ride Inspection" (below)
5. Have rider mount the electric balance bike, gripping the handlebars with both hands, sitting on the saddle with both feet flat on the ground.
6. Press and hold power switch for 3 seconds to turn electric balance bike on.
7. Finally, carefully resume riding your electric balance bike.

LOADING AND UNLOADING (Putting An Electric Balance Bike Into A Vehicle)

1. Press and hold power switch for 3 seconds to turn off electric balance bike.
2. Remove battery.
3. Load into vehicle for transport.
4. After unloading, ensure power is off. The LED light or screen should be dark.
5. Install battery.
6. Perform pre-ride Inspection.

⚠ WARNING: FAILURE TO USE COMMON SENSE AND HEED THE ABOVE WARNINGS INCREASES RISK OF SERIOUS INJURY. USE WITH APPROPRIATE CAUTION AND SERIOUS ATTENTION TO SAFE OPERATION.

3A) PRE-RIDE INSPECTION & CHECKLIST:

Never ride your electric balance bike on public streets, roads, highways, at night, or when visibility is limited.

POWER OFF: Ensure power is off (all LED lights or screen still dark) during the pre-ride Inspection and remains "OFF" until the rider is sitting on the saddle, both hands gripping the handle bars, both feet flat on the ground.

THROTTLE: Ensure the battery is removed and the power is off. Check that the throttle rotates freely. Ensure there are no cracks or visible damage.

BRAKE: Check brake for proper function. When you squeeze lever, brake should provide positive braking action. Make sure that brake is not rubbing when lever is released. Adjust as required prior to use.

SIDE PANELS AND CHAIN GUARD: Verify side panels and chain guard are properly installed.

TIRES: Periodically inspect tires for excess wear and aging. Regularly check tire pressure and inflate per the tire manufacturer's recommendation on the tire sidewall.

FRAME, FORK, STEM, AND HANDLEBARS: Check for cracks and loose hardware. Broken components are rare; however, it is possible for a reckless rider to run into a curb or object and cause damage. Get into the regular habit of inspecting your electric balance bike every time you ride it!

HARDWARE/LOOSE PARTS: Check all hardware such as nuts, bolts, cables, fasteners, etc. to ensure they are secure. There should not be any unusual rattles or sounds from loose parts or broken components. If the unit is damaged, do not ride it. Reference "Warnings" listed in this manual.

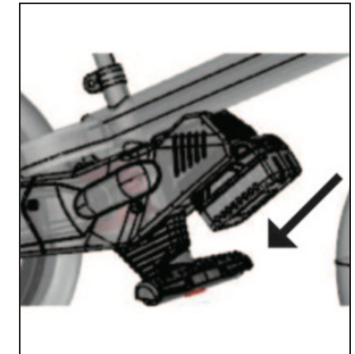

FIGURE 2

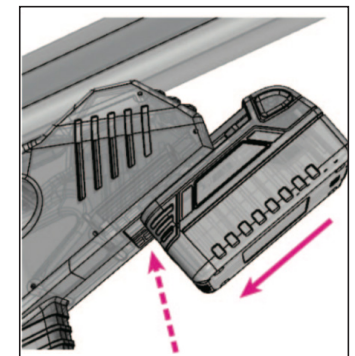

FIGURE 3



SAFETY GEAR: Check that proper protective gear; such as an approved and properly fitted safety helmet, eye-wear, athletic shoes (closed toe shoes with rubber soles), elbow pads, kneepads, etc., are in place prior to riding. Keep shoelaces tied and out of the way of the wheels, motor and drive system.

⚠ WARNING: NEVER RIDE BAREFOOT OR IN SANDALS.

LAWS AND REGULATIONS: Check and obey any local laws or regulations prior to riding.

3B) BATTERY

NOTE: The electric balance bike consumes the most power at start-up, so it is recommended to use your feet to propel forward at the start instead of using only the throttle. This can increase battery life.

This battery can only be used on your electric balance bike! Do not use for other applications.

NOTE: The electric balance bike should be turned OFF and battery removed when unit is not in use. The electric balance bike will turn off automatically when not use for one minute to avoid battery charge loss.

BATTERY INSTALLATION

NOTE: The electric balance bike should be turned OFF and the battery removed when unit is not in use. If the power switch is left on, the battery loses its charge.

1. Locate battery and orient as shown. [Figure 2].
2. Slide battery into slot on the front of the down tube of the electric balance bike. [Figure 3]
3. There is a point where the battery release latch/button provides some resistance. Push the battery past this point. You should hear a click, and this gap should be closed. [Figure 4]

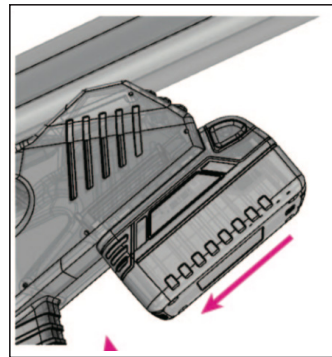

FIGURE 4

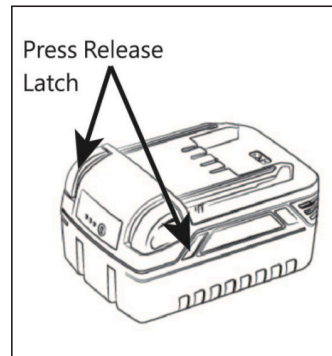

FIGURE 5

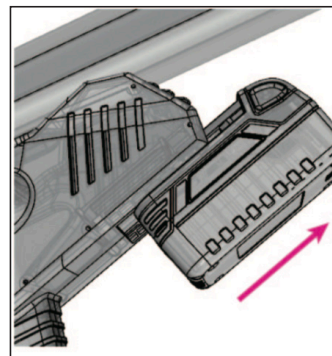
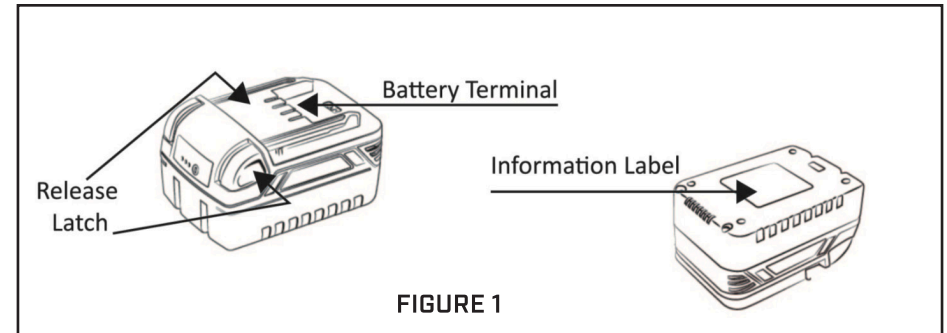

FIGURE 6



BATTERY REMOVAL

1. Turn the handlebar 45 degrees
2. Press the battery release latch/button and slide battery out of slot in the direction shown. [Figure 5 & 6]

CHARGING THE BATTERY

Remove battery from electric balance bike and place on charger. Refer to instructions provided by battery and charger manufacturer. The electric balance bike should be turned OFF and the battery removed when unit is not in use. If the power switch is left on, the battery loses its charge. Do not charge outdoors.

BATTERY DISPOSAL

Your product uses sealed lithium cell batteries which must be recycled or disposed of in an environmentally safe manner. Do not dispose of a lithium cell battery in a fire; the battery may explode or leak. Do not dispose of a lithium cell battery in your regular household trash. The incineration, land filling, or mixing of sealed lithium cell batteries with household trash is prohibited by law in most areas. Return exhausted batteries to a federal or state approved lithium cell battery recycler or a local seller of batteries. Many states have laws prohibiting the disposal of lithium cell batteries in the municipal waste stream. Check with your local state law.

3C) POWERING ON/OFF

POWER ON

- Press the red power switch for 3 secs until you hear the beep tone.
- (1) One beep: Low Speed Mode 5mph (8Km/h) (Default mode)
- (2) Two beeps: Mid Speed Mode 7.5mph (12Km/h)
- (3) Three beeps: High Speed Mode 11mph (17.7Km/h)



POWER OFF

Press the red power switch for 3 secs until you hear the beep tone. Monitor or LED (Different model) will go dark.

NOTE: Electric kid's bike will turn off automatically when not use for 1 minute, to avoid battery charge loss.

3D) CHANGING SPEED MODE

(Performed strictly under adult advisory!)

Your Superbolt is equipped with 3 speed modes for different skill levels. Low, Middle, and High speed modes. We do not advise showing children how to adjust the modes. Each child should have the speed set by an adult who will be closely supervising the child.

DO NOT put your child on the High speed mode without working through the process of learning the low and mid speed modes.

1. Press and hold the brake lever
2. Rapidly press the power switch twice (in 1 second). You will hear a "beep" tone.
 - *One beep: Low speed mode 5mph (8Km/h)
 - *Two beep: Mid speed mode 7.5mph (12Km/h)
 - *Three beep tones: High speed mode 11mph (17.7Km/h)
3. The three speeds are cycled in succession.
4. Repeat "STEP 2" to select the speed mode you prefer.

4. BEFORE RIDING YOUR ELECTRIC BALANCE BIKE

4A) THE STARTING PROCESS: SIT, PUSH, COAST, BRAKE, PRACTICE

(Perform under adult supervision, wearing protective equipment, in an open and safe area) We recommend that children start practicing in the unpowered mode before starting to ride the electric balance bike with power. When the child can balance the electric balance bike, then install the battery and start the power ride.

NON-POWERED TRAINING:

(Turn power switch to the "OFF" position and remove battery)

1. Sit on bike with feet on ground. Familiarize rider with seat, foot platform, brake, handlebars, throttle, and their functions.
2. Push bike around with feet on ground learning balance and confidence.
3. Coast and practice controlled turning with feet on platform.
4. Brake to a safe stop using hand brake while maintaining control.
5. Practice standing and stopping while maintaining control without falling.

POWERED MODE QUALIFYING CHECKLIST:

- Can rider push and coast safely with feet on platform?
- Can rider maintain control while standing on platform?
- Can rider control bike from start to stop?
- Can rider use hand brake to stop on command?
- Can rider coast and turn while navigating mild hills and obstacles?
- Has rider demonstrated enough control to move to powered riding without being a risk to themselves and others?
- If so move to Powered Mode training!



POWERED MODE:

LOW SPEED MODE:

1. Install battery.
2. Press and hold power switch for 3 seconds to turn on.
Ensure you are in the low speed mode to start.
If not, see CHANGE SPEED MODE sections in this manual.
3. Have child carefully push forward and practice slightly twisting throttle learning to feel the bike beginning to move forward under power.
4. With feet on ground have child progressively increase throttle use until moving forward balancing on their own.
5. Have child practice rolling throttle on and off as well as safe stops with hand brake.
6. As child gains balance and demonstrates throttle and brake skills, advance to riding with feet on the platform.
7. Coach child to maintain a safe distance from obstacles and other riders.

MID SPEED MODE:

1. Install battery.
2. Press and hold power switch for 3 seconds to turn on.
Ensure you are in the mid speed mode.
If not, see CHANGE SPEED MODE sections in this manual.
3. Adult should supervise child as the top speed and acceleration have both increased in this mode.
4. Coach child to demonstrate ability to roll off throttle and use brake to slow to a stop and maintain a safe distance for obstacles and other riders.
5. A majority of users will find this speed to be adequate for significant skill building and lots of fun!

HIGH SPEED MODE:

1. Install battery.
2. Press and hold power switch for 3 seconds to turn on.
Ensure you are in high speed mode.
If not, see CHANGE SPEED MODE sections in this manual.
3. Adult should supervise child as the top speed and acceleration are at their maximum in this mode.
4. Coach child to demonstrate ability to roll off throttle and use brake to slow to a

stop and maintain a safe distance for obstacles and other riders.

5. This mode is for advanced and older riders only!

4B) BATTERY STATUS

⚠ WARNING: Please use the exclusive charger that came with your electric balance bike.

⚠ WARNING: Do not charge outdoors.

BATTERY CHARGE

To know the charge of your battery, look at the figure below and read the indicator lights on the charger. [Figure 7]

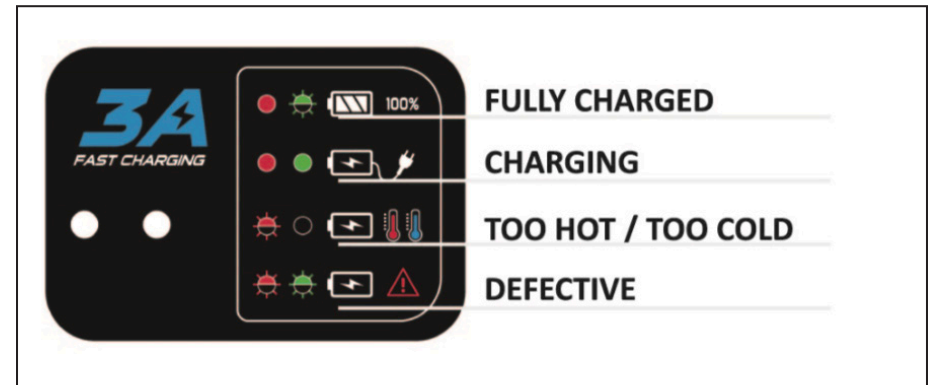

FIGURE 7





5. TROUBLESHOOTING GUIDE

A fully charged battery must be installed prior to performing any troubleshooting and must ONLY be performed by an adult. **IF YOU ARE NOT CONFIDENT IN EXECUTING TECHNICAL PROCESSES, PLEASE CONSULT A BICYCLE MECHANIC. DISCONTINUE USE WHILE TROUBLESHOOTING AND NORMAL FUNCTION IS RESTORED!**

PROBLEM	POSSIBLE CAUSE	SOLUTION
Electric balance bike does not work	Battery not installed or fully seated	Verify a fully charged battery is installed. Push battery until release buttons click
	Battery not fully charged	Verify the battery is fully charged
	Did not press and hold button for 3 seconds	Press and hold the power switch for 3 seconds

PRODUCT PARTS: Keep your electric balance bike running for years with genuine Superbolt parts. Visit ridesuperbolt.com for information on spare part availability. (Illustrations may not reflect exact appearance of actual product, specifications subject to change without notice.)

FUSE REPLACEMENT

1. Remove the left side cover. [Figure 8]
2. Locate the inline fuse holder and remove the cover to access the fuse. [Figure 9]
3. Remove the damaged fuse and replace with a new one. Replace the cover on the inline fuse holder and ensure the power cable is routed neatly. [Figure 10]
4. Reinstall the left side cover and tighten the screws. [Figure 11]

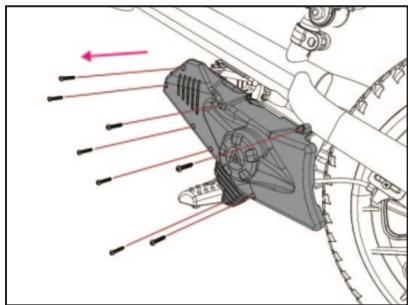

FIGURE 8

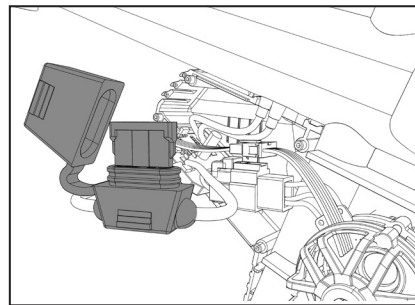

FIGURE 9

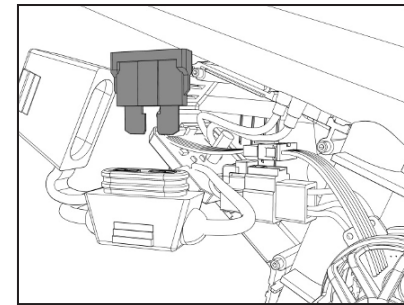

FIGURE 10

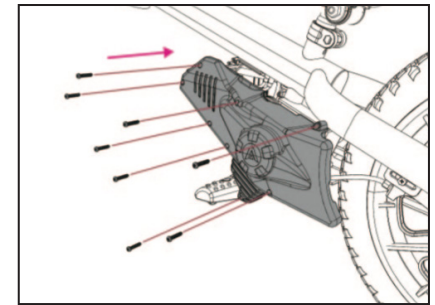

FIGURE 11

5A) TROUBLESHOOTING PROBLEMS

Follow steps to find resolution. Contact Superbolt if problems persist or you need assistance

PROBLEM	POSSIBLE CAUSE	SOLUTION
Balance bike will not power on	Switch not pressed correctly	<ol style="list-style-type: none"> 1. Review Owner's Manual. 2. Attempt to start again.
	Battery not installed correctly	<ol style="list-style-type: none"> 1. Remove and reinstall. 2. Check installation is secure.
	Wire connections loose	<ol style="list-style-type: none"> 1. Check wire connections. 2. Reconnect as needed.
	Check battery function	<ol style="list-style-type: none"> 1. Check battery indicators. 2. Check if battery is charged. 3. Remove and reinstall. 4. Check installation is secure.
	Fuse blown	<ol style="list-style-type: none"> 1. See technical process "Replacing the Fuse." 2. If problems persist, contact Superbolt. <p>NOTE: If no "Beep" after powering on could indicate faulty control board, contact Superbolt.</p>



Troubleshooting

PROBLEM	POSSIBLE CAUSE	SOLUTION
"Beep" continuous after powering on	Check battery function	<ol style="list-style-type: none"> 1. Check battery indicators. 2. Check if battery is charged. 3. Remove and reinstall. 4. Check installation is secure. 5. If problems persist, contact Superbolt.
"Beep" sound while in use	Check battery function	<ol style="list-style-type: none"> 1. Check battery indicators. 2. Check if battery is charged. 3. Remove and reinstall battery. 4. Check installation is secure. 5. If problems persist, contact Superbolt.
Stops operating during use	Check for Improper Use	<ol style="list-style-type: none"> 1. Exceeding weight limit 2. Starting on incline without assistance 3. Obstructions in moving parts
	Battery not installed correctly	<ol style="list-style-type: none"> 1. Remove and reinstall. 2. Check installation is secure.
	Wire connections loose	<ol style="list-style-type: none"> 1. Check wire connections. 2. Reconnect as needed.
	Check battery function	<ol style="list-style-type: none"> 1. Check battery indicators. 2. Check if battery is charged. 3. Remove and reinstall. 4. Check installation is secure.
	Fuse blown	<ol style="list-style-type: none"> 1. See technical process "Replacing the Fuse." 2. If problems persist, contact Superbolt.

Troubleshooting

PROBLEM	POSSIBLE CAUSE	SOLUTION
Battery indicator errors	Battery not installed correctly	<ol style="list-style-type: none"> 1. Remove and reinstall. 2. Check installation is secure.
	Check battery function	<ol style="list-style-type: none"> 1. Check battery indicators. 2. Check if battery is charged. 3. Remove and reinstall. 4. Check installation is secure. 5. If problems persist, contact Superbolt.
Motor does not disengage while braking	Wire connections loose	<ol style="list-style-type: none"> 1. Check wire connections. 2. Reconnect as needed. <ul style="list-style-type: none"> • IF PROBLEM PERSISTS AFTER CHECKING ALL CONNECTIONS DISCONTINUE AND CONTACT SUPERBOLT!!!
Will not accelerate	Wire connections loose	<ol style="list-style-type: none"> 1. Check wire connections. 2. Reconnect as needed. 3. If problems persist, contact Superbolt.
Speed control not operating properly	Wire connections loose	<ol style="list-style-type: none"> 1. Check wire connections. 2. Reconnect as needed. 3. If problems persist, contact Superbolt.

NOTE: Please contact Superbolt for any assistance you may need! Stay SAFE and have fun!



2. TECHNICAL PROCESSES

CHECKING THE BATTERY

1. Install the battery on the charger.
2. Confirm the message displayed. [Figure 12]



REPLACING THE FUSE

1. Remove the battery.
2. Remove the left side protective cover.
3. Remove screws. [Figure 13]
4. Open fuse cover.
5. Remove fuse and inspect [Figure 14];
6. Replace if needed with 40amp fuse.
7. Install fuse cover.
8. Install left side protector.
9. Install battery. Install the battery on the charger.

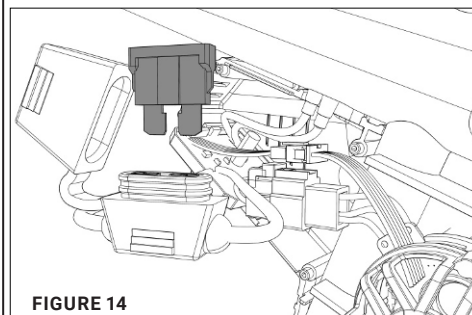
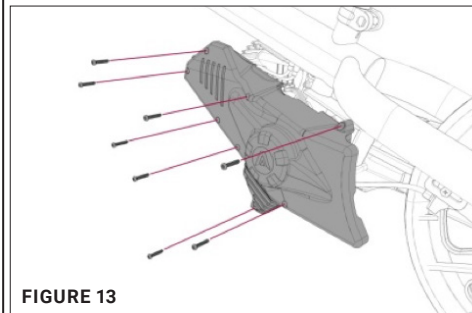

REPLACING THROTTLE, MONITOR, AND POWER SWITCH

1. Remove battery.
2. Remove the left side protective cover. [Figure 15]
3. Remove the controller and disconnect the wire. [Figure 16]
4. Remove Dust Plug. [Figure 17]
5. Remove and replace;
6. Loosen throttle fixing screw and remove throttle and wire.
7. Replace throttle and tighten fixing screw. [Figure 18]
8. Run wire back through the frame tube and out the lower hole to reconnect. [Figure 19]
9. Complete reassembly;
10. Install controller.
11. Install protective cover.
12. Install dust plug.
13. Install battery.

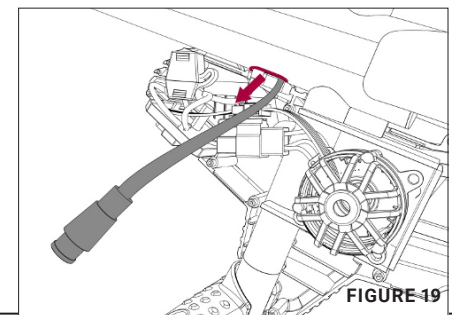
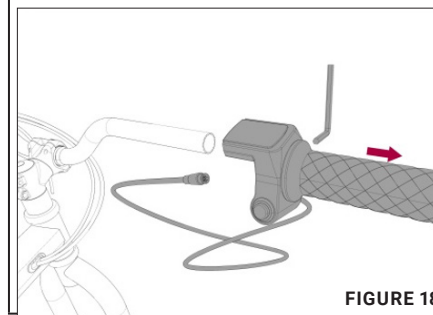
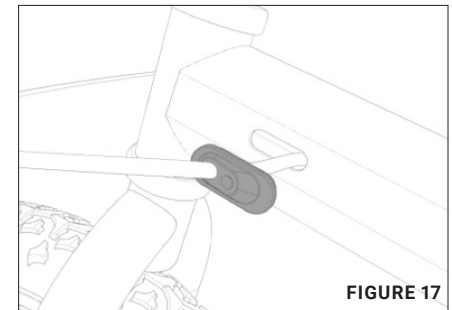
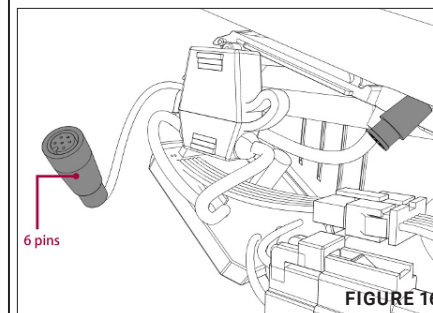
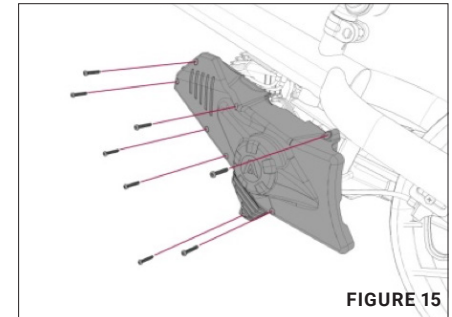



REPLACING BRAKE LEVER

1. Remove battery.
2. Remove the left side protective cover. [Figure 20]
3. Remove the controller and disconnect the brake wire. [Figure 21]
4. Remove the dust plug and left grip. [Figure 22]
5. Unlock the brake cable from the lever. [Figure 23]
6. Remove and replace;
 - Loosen the fixing screw of the lever and remove with the wire.
 - Install new lever with wire and tighten fixing screw.
7. Attach the brake cable. [Figure 24]
8. Run the wire back through the frame and reconnect. [Figure 25]
9. Complete reassembly;
 - Install controller.
 - Install protective cover.
 - Install dust plug.
 - Install battery.

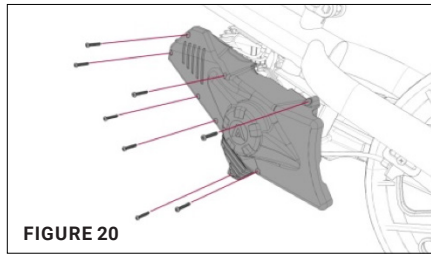

FIGURE 20

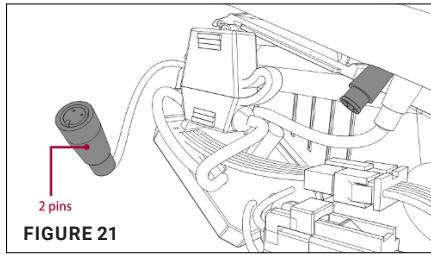

FIGURE 21

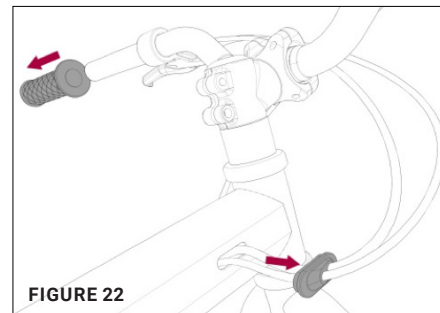

FIGURE 22

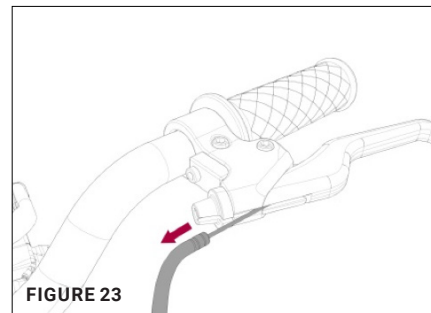

FIGURE 23

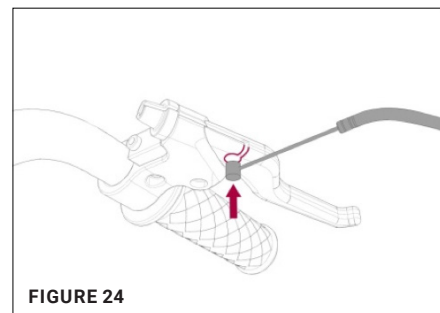

FIGURE 24

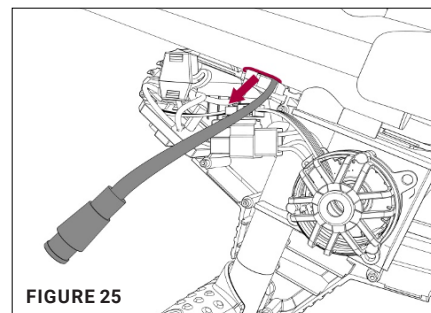

FIGURE 25

REPLACING THE CONTROL BOARD

1. Remove battery.
2. Remove the left side protective cover. [Figure 26]
3. Remove and replace;
 - Take out the control board, remove cable tie and disconnect all wires.
 - Insert new control board and reconnect. [Figure 27]
4. Complete reassembly;
 - Install controller.
 - Install protective cover.
 - Install battery.

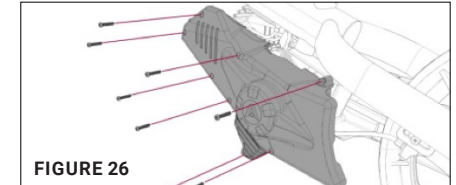

FIGURE 26

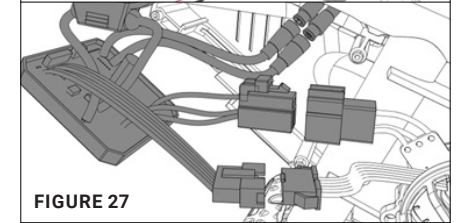

FIGURE 27

REPLACING THE MOTOR

1. Remove battery.
2. Remove the left side and left side protective cover. [Figure 28]
3. Disconnect the motor and control board wires. [Figure 29]
4. Remove the chain protective cover.
5. Remove cover screw, right axle, and chain tensioner [Figure 30 & Figure 31]
6. Loosen left axle nuts. [Figure 32]
7. Push the rear wheel forward and remove chain. [Figure 33]
8. Remove and replace;
 - Loosen and remove motor fixing screws, remove motor.
 - Place new motor and install fixing screws. [Figure 34]
9. Reinstall chain;
 - Hang chain on motor flywheel and wheel cog. The chain will be loose. [Figure 35]
 - Replace rear protective cover.
 - Pull the rear wheel back to make the chain tight. [Figure 36]
 - Tighten the chain tensioner and axle nut. [Figure 37]
 - Tighten the left side axle nut.
10. Complete reassembly;
 - Install controller.
 - Install protective covers.
 - Install battery.

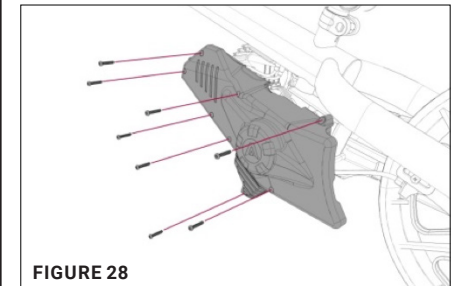

FIGURE 28

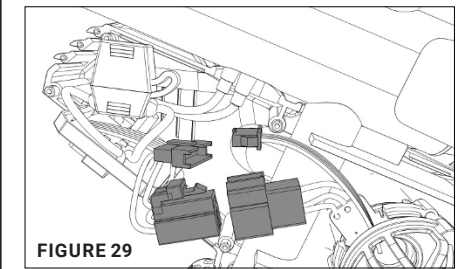
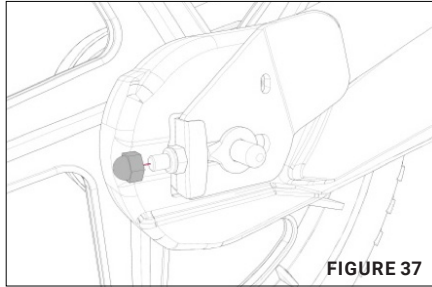
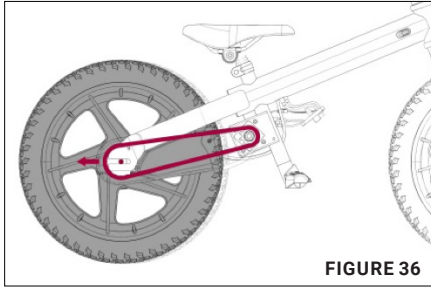
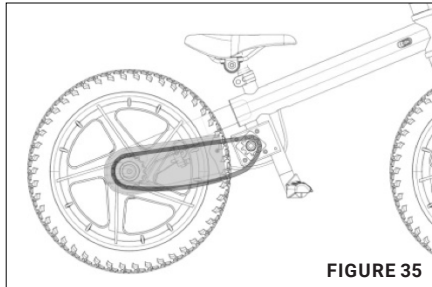
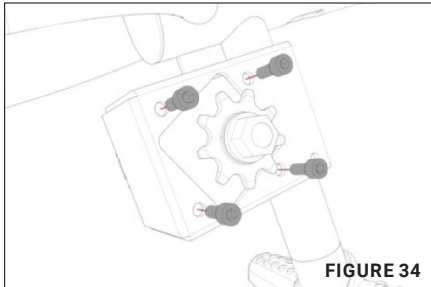
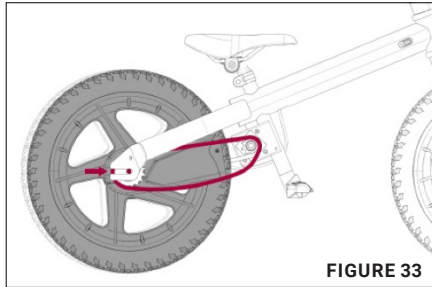
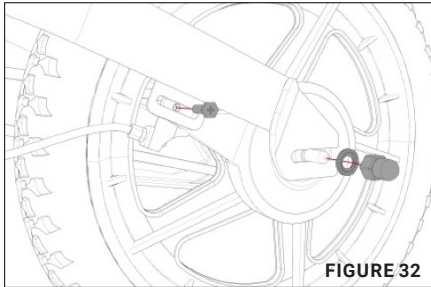
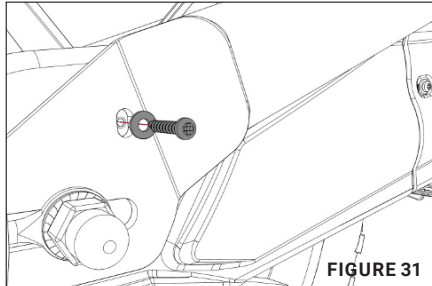
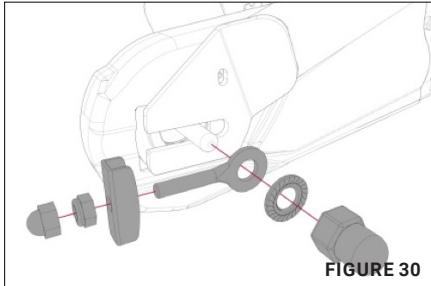

FIGURE 29



REPLACING THE MOTOR (CONT.)



6. WARRANTY

All Superbolt bikes, e-bikes, and the individual covered components are protected against all manufacturing defects in material or workmanship under a Limited Warranty.

The following components are covered for a 2-year period after receipt of the bike by the original purchasers:

- Bicycle frame

The following components are covered for a 1-year period after receipt of the bike by the original purchasers:

- Lithium ion battery
- Forks
- Stem
- Handlebar
- Headset
- Freewheel
- Cassette
- Derailleur
- Shifter
- Motor
- Throttle
- Controller
- Wiring harness
- LCD display
- Hardware

The Limited Warranty does not cover:

- Normal wear and tear of any of the covered components
- Consumables or normal wear and tear parts, including without limitations:
 - Tires
 - Tubes
 - Brake pads
 - Cables



Warranty

- Housing
 - Grips
 - Chain
 - Spokes
 - Seat
- Any damage or defects to the covered components resulting from failure to follow instructions in the owner's manual, unauthorized modifications, acts of God, improper assembly, accident, misuse, neglect, abuse, commercial use, installation of parts and accessories not compatible with the bike, operator error, water damage, extreme riding, stunt riding, or improper maintenance.
 - The battery is not warranted from damage resulting from power surges, charging with an improper charger, improper maintenance, normal wear or water damage.

SHIPPING DAMAGE

Damage to a covered component during shipping is not covered by the Limited Warranty, however, Superbolt Bike will replace such covered components if you:

1. Notify Superbolt Bike of a covered component damaged in shipping within 10 days of your receipt of the e-bike.
2. Provide Superbolt Bike with a picture of the damaged component.

If there is noticeable damage to the box of your electric balance bike when it is delivered it is advisable to take pictures before unpacking in the event you need to file a claim. If damage is noticed during unpacking please contact Superbolt Bike support team by email at:

info@ridesuperbolt.com

or by phone at: 833.647.RIDE (7433).

HOW TO FILE A WARRANTY CLAIM

In order to file a warranty claim on a covered component you must:

- Contact the Superbolt Bike support team by email at info@ridesuperbolt.com or by phone at 833.647.RIDE (7433). The support team will work with you to identify the issue with your bike and offer potential fixes to the issue.
- If the support team determines that a covered component needs replacement, they will walk you through the process for returning the defective component and receiving a replacement.
- After you receive the replacement component the support team will assist you in determining how to replace or install the new replacement component
- Replacement covered components covered under this limited warranty will only be shipped to the address of the original purchaser.

Warranty

LEGAL DISCLAIMER

This warranty is expressly limited to the repair or replacement of a defective product, at the option of Superbolt, and is the sole remedy of the warranty. This limited warranty applies only to the original purchaser of the Superbolt product and is not transferable. This warranty applies only to Superbolt products purchased through an authorized dealer or distributor. In no event shall Superbolt be liable for any loss, inconvenience or damage, whether direct, incidental, consequential, or otherwise resulting from breach of any express or implied warranty or condition of merchantability, fitness for a particular purpose, or otherwise with respect to our products except as set forth herein. This warranty gives the consumer specific legal rights, and those rights and other rights may vary from place to place. This warranty does not affect your statutory rights. The English version of the warranty shall prevail.

TO THE EXTENT NOT PROHIBITED BY LAW, THESE WARRANTIES ARE EXCLUSIVE AND THERE ARE NO OTHER EXPRESS OR IMPLIED WARRANTIES OR CONDITIONS INCLUDING WARRANTIES OR CONDITIONS OF MERCHANTABILITY AND FITNESS FOR A PARTICULAR PURPOSE.



7. FREQUENTLY ASKED QUESTIONS

Don't see the answer you're looking for, shoot us an email at info@ridesuperbolt.com.

WHO SHOULD I CONTACT IF I HAVE COMMENTS AND SUGGESTIONS REGARDING SUPERBOLT PRODUCTS?

If you have any questions or comments on Superbolt products, please contact us at info@ridesuperbolt.com.

WHO SHOULD I CONTACT IF MY SUPERBOLT PRODUCT HAS A DEFECT?

If you think your Superbolt product is defective, please contact us at: info@ridesuperbolt.com or 833.647.RIDE (7433)

WHAT IS COVERED BY YOUR LIMITED WARRANTY?

Refer to our Limited Warranty policy in the Owner's Manual.