

# **VORSPRUNG**<sup>®</sup>

## Electric Vehicle AC Charging Unit



### **User Manual**

Model: 20145 (Q9)

Thank you for choosing one of our Vorsprung AC charging unit products. To help you correctly use, operate, maintain, check, troubleshoot and maintain this AC charging unit, please carefully read this User Manual before use, operate according to this User Manual only, and keep safe for future use.

## **This Unit must only be installed & fitted by a Certified Engineer**

Installation must only be performed by a Certified Engineer competent in accordance with the current legislation in force in the geographical location of the installation.

- Advice provided in this manual does not override any legislation.
- If the advice in this manual is not understood, contact the distributor for further advice and/or training before attempting installation/operation of the equipment.

The manufacturer/distributor cannot accept any responsibility for improper installation or any problems arising from improper installation.

**NOTE:** Damage to the equipment, connected systems or to property caused by improper installation are the responsibility of the installer.

**NOTE:** All electrical work must be performed in accordance with the current Electrical Wiring Regulations.

## **CONTENTS**

<b>1- Safety rules.....</b>	<b>3</b>
<b>2- Introduction.....</b>	<b>3</b>
2.1. Composition.....	4
2.2. Main features.....	4
<b>3- Design Specification.....</b>	<b>5</b>
<b>4- Technical Specification.....</b>	<b>6</b>
<b>5- Installation.....</b>	<b>7</b>
5.1. Parts included.....	7
5.2. Site requirements.....	7
5.3. Wiring mode.....	7
5.4. Installation method.....	9
<b>6- Charger status indication.....</b>	<b>11</b>
<b>7- Using the APP.....</b>	<b>12</b>
<b>8- Screen display.....</b>	<b>13</b>
<b>9- Appendix.....</b>	<b>14</b>
9.1. Precautions.....	14
9.2. Troubleshooting.....	14
<b>10- Guarantee.....</b>	<b>15</b>

# 1- Safety rules

## **Installation of this Unit must be Performed by a Certified Engineer**

- 1.1. Turn off the power supply prior to and during the installation, to prevent electric shock.
- 1.2. The charging unit's power cable must be firmly connected and well insulated. Loose connection and damages will cause circuit failure, which may cause a fire or casualties in severe cases.
- 1.3. The installation of the charging unit and connection to the power grid must be conducted by a trained, certified engineer.
- 1.4. If the unit is dropped at any point prior to installation, it should not be installed until the engineer has inspected the unit to determine whether or not it can safely be installed.
- 1.5. Do not wash or cover the charging unit with any liquid. To clean the charging body, wipe gently with a lightly damp cloth, avoiding the connector area.
- 1.6. Any faults which arise that may impact the safety of the unit should be addressed by a certified engineer. Please do not attempt any repairs yourself.
- 1.7. The charging unit should only be installed by a certified engineer. The seller will not bear any responsibility for any loss caused by uncertified engineers and personnel for any modifications.

## 2- Introduction

The AC charging unit is a charging device developed to meet charging needs of new electric vehicles. It is used together with the electric vehicles onboard charger to provide fast charging service for electric vehicles. This product is easy to install, occupies a small area, is easy to operate and has a stylish appearance. It is suitable for private car parks, public car parks, residential parking driveways, enterprise dedicated car parks, and other outdoor and indoor parking areas. As this product is high-voltage equipment, please do not disassemble the housing or modify the circuit of the equipment. This charging unit is intelligent, with timing, billing (optional), electricity metering, charging (optional), and human-computer interaction interface.

## 2.1. Composition

The charging unit is composed of a shell, back cover, main control board, human-computer interface, fuse, emergency stop switch, charging interface, charging gun line.

## 2.2. Main Features

- 2.2.1. This charging unit has an operation background monitoring system (only for connected devices).
- 2.2.2. This charging unit has a dynamic human-computer interaction function and is equipped with LED status indication, so the charging process is clear at a glance.
- 2.2.3. The charging unit is equipped with an embedded emergency stop mechanical switch, which can greatly increase the safety of equipment control.
- 2.2.4. The charging pile has built in Wi-Fi connectivity capabilities.
- 2.2.5. The charging unit has system protection functions: overvoltage, undervoltage protection, overcurrent protection, short circuit protection, leakage protection, over temperature protection, lightning strike protection.
- 2.2.6. Data storage and fault identification.
- 2.2.7. The whole structure of the charging unit is rainproof and dust-proof, with IP55 protection grade, suitable for indoor and outdoor use in a wide and flexible environment.
- 2.2.8. The charging unit is easy to install, operate and maintain.



# 3- Design Specification

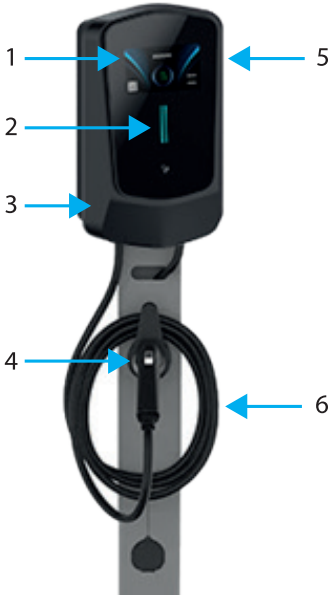

- 1- Display screen 4.3-inch LCD screen, displaying charging information ;
- 2- LED indicator: different colors indicate different states ;
- 3- Shell: PC/ABS material ;
- 4- Charging gun: IEC 62196 Type 2 charge connector ;
- 5- Emergency stop switch: in case of emergency, press the emergency stop switch to cut off the power ;
- 6- Cable: 5-meter charging cable ;

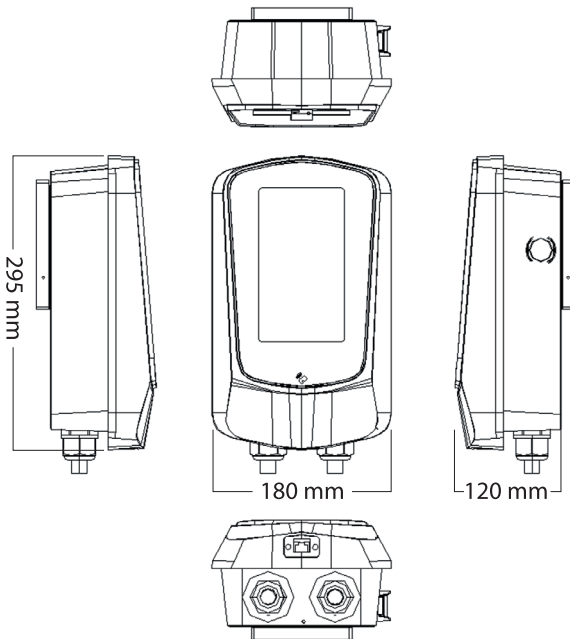

## 4- Technical Specification

Table-1 Technical parameters of AC charging unit

Name	Three-phase
Maximum output power	22KW
Input voltage	AC 380V
Input voltage frequency	50Hz/60Hz
Output voltage	AC 380V
Output current	32A
Efficiency	≥98%
Insulation resistance	≥10MΩ
Power consumption of control module	≤22W
AC & DC Fault Protection	AC: Type A 30mA RCD + DC: 6mA
Operating ambient temperature	-30°C~+50°C
Storage ambient temperature	-40°C~+80°C
Ambient humidity	5% ~95% No frost, no condensation
Altitude	Not more than 2000 meters
Status indication	LED indicator
Screen	4.3-inch LCD color screen
Startup mode	Plug and charge
Communication mode	WiFi, Bluetooth
Charging interface	IEC 62196 Type 2
Degree of protection	IP55, IK10
Safety protections	Overvoltage protection, undervoltage protection, grounding protection, lightning protection, leakage protection, flame retardant protection, vercurrent protection
Cable Length	5 meters
Weight	4.5 KG

# 5- Installation

## 5.1. Parts Included

### **Please check you have all parts before installation**

1 x AC Wall Unit Charger

1 x User manual for AC Wall Unit Charger

1 x Certificate

Wall mount fixtures: 7 x M6 30mm rubber plugs

1 x Wall Bracket

4 x KA30 10mm hexagon socket self-tapping screws

## 5.2. Site Requirements

5.2.1. The charging unit meets the IP55 protection level and can be installed both indoors & outdoors.

5.2.2. Please ensure that the ambient temperature is within the range of - 30°C~+50°C.

5.2.3. The altitude of the installation site shall not be higher than 2000 meters.

5.2.4. There should be no vibration, flammables, and explosives near the installation site.

5.2.5. The installation site should not be located in low-lying areas or areas prone to water accumulation or flooding.

5.2.6. The unit must be installed onto a wall. If there is no wall support, it is recommended to use a special EV floor post for installation and fixing.

5.2.7. The unit must be installed vertical, the centre point of the gun base to the horizontal ground should be between 1200~1300mm.

## 5.3. Wiring mode

5.3.1. The charging unit comes with an independent power circuit which cannot be shared with any other electrical devices.

5.3.2. When installing; use a Phillips screwdriver to open the rear wiring cover on the charging unit, connect the three cables (live wire L, neutral wire N and ground wire PE) to the terminal according to the wiring markings.

5.3.3. To prevent the risk of electric shock, the equipment should ensure that the input ground wire is firmly grounded.

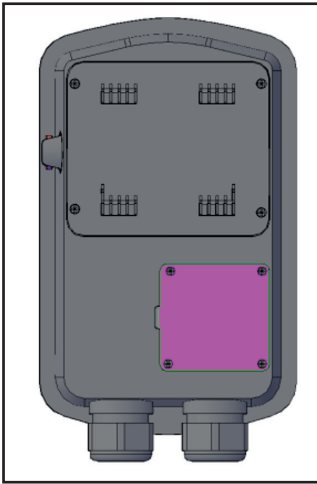

**1-** Loosen four screws of the input cable cover on the rear of the charging unit.

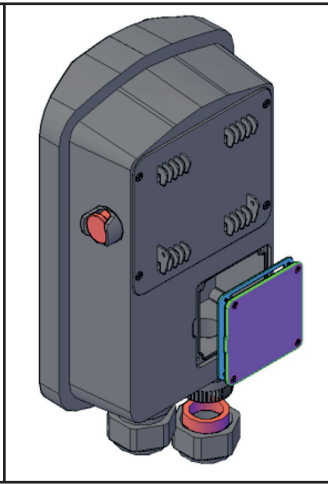

**2-** Remove the input line cover and waterproof rubber ring respectively, unscrew the gland on the input line side and remove the rubber ring.

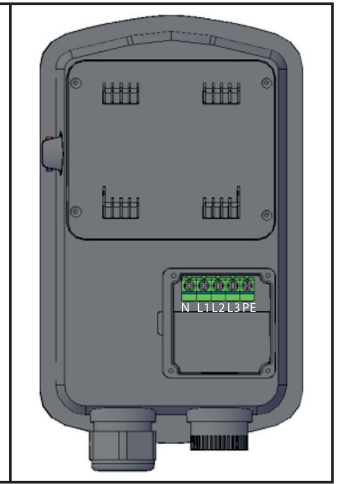

**3-** Internal view once cover is removed.

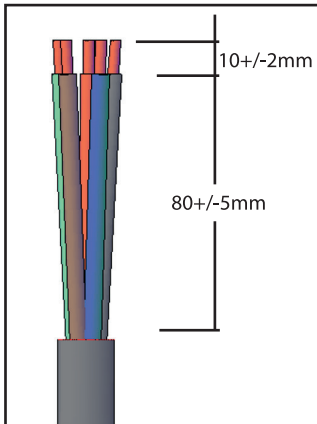

**4-** Use a 5-core 10mm<sup>2</sup> multi-strand flexible copper cable (single-phase charging unit uses 3-core 6mm<sup>2</sup>), and the stripping method is shown in the figure above.

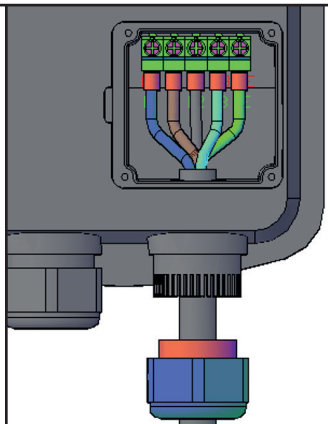

**5-** The input cable shall be threaded into the gland to tighten the nut and rubber ring. Then it passes through the inner hole of the gland head and enters the interior of the charging unit.

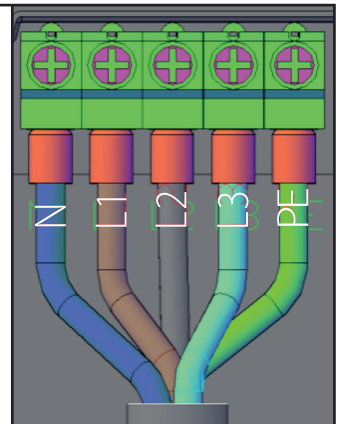

**6-** The wiring sequence is N, L1, L2, L3 and PE from left to right. Terminals must be tightened securely.

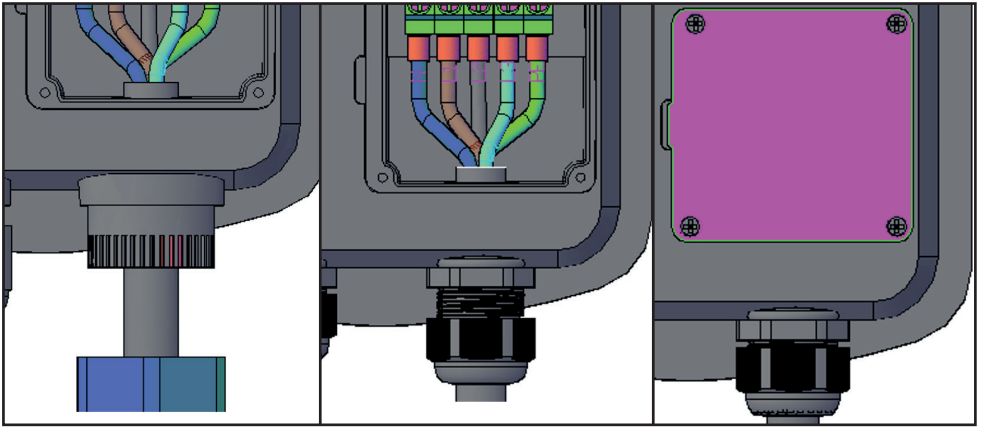

**7-** Install the rubber ring along the cable to the end of the gland.

**8-** The cable shall be squeezed to the interior of the charging unit to prevent the internal cable from stretching. Tighten the screws again for fixation.

**9-** Place the waterproof rubber ring in turn (pay attention to the left side of the wide edge), and fix the input line cover with screws.

## 5.4. Installation Method

For the sake of safety, only a Certified Engineer can install and fit the charging unit. Please do not attempt to install it yourself.

According to the position of the mounting hole on the wall frame, mark the hole position on the wall and then use a drill to make holes; 6mm wide and 40mm deep. Then put in the plastic rubber plugs, hammer the pointed end into the hole to make it flush to the wall surface. Once the wall bracket is fixed, you can slide the wall charging unit onto it, as per the diagram below.

Once the wall charging unit has been attached to the wall bracket, please secure it with the anti-theft KA30 10mm hexagon socket self-tapping screws.

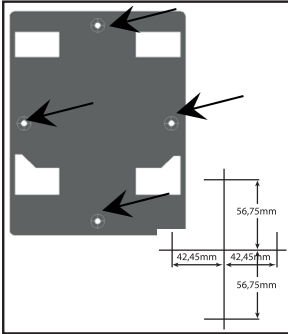

**1-** Wall bracket should be placed flat on the wall at an appropriate position, and the screw hole position shall be marked (or marked in mm according to the above figure).

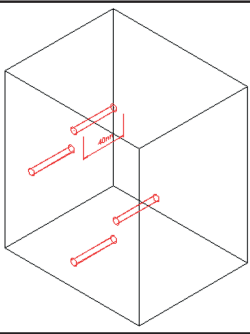

**2-** Use a 6mm drill bit to drill holes at the marked position, with the depth >40mm.

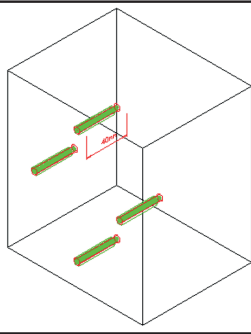

**3-** Insert the rubber plugs, ensuring the surface of the rubber plug is flush with the wall surface.

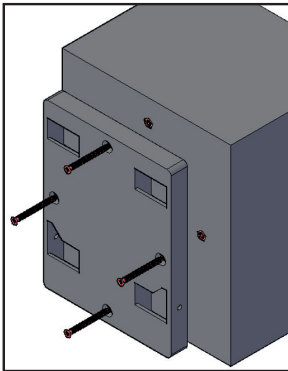

**4-** Secure the wall bracket to the wall ensuring it is the correct way up (as shown in the diagram).

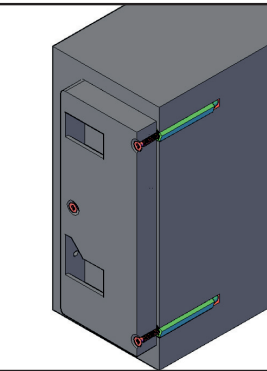

**5-** Ensure the screws are secured fully and the wall bracket is not loose.

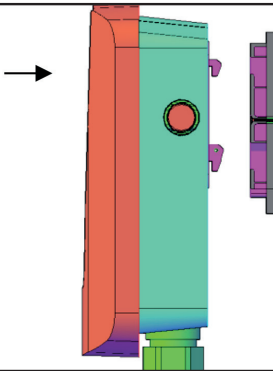

**6-** Attach the charging unit to the wall mounted bracket by matching the clips and sliding it down.

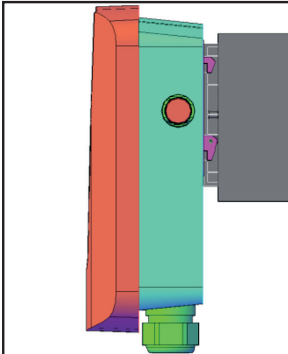

**7-** Push the unit towards the wall to check it is properly clipped on.

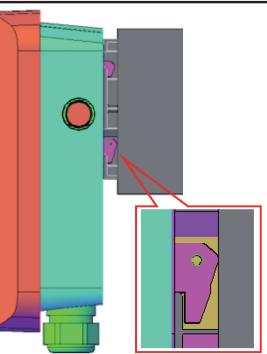

**8-** Push the unit downwards so that it is completely clipped on.

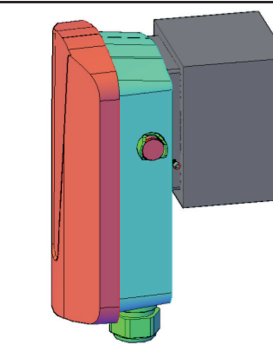

**9-** Lock the anti-theft screws into the holes on both sides of the wall bracket.

## 6- Charger Status Indication

	Status	Charge Unit Status	LED status	Remarks
1	Normal	Standby	The blue light is always on	
2		Ready to Charge	The green light is always on	Charging hasn't begun
3		Charging	Green light flashes (500ms on, 500ms off)	Charging has begun
4		Charging completed	The green light is always on	The vehicle is fully charged and the charger has not been unplugged.
5	Fault	Emergency stop fault	The red light is always on	Contact Certified Engineer to inspect
6		Ungrounded fault	The red light flashes twice every 5s	
7		CP error fault	The red light flashes 3 times every 5s	
8		Overcurrent fault	The red light flashes 4 times every 5s	
9		Overcurrent fault	The red light flashes 5 times every 5s	
10		Undervoltage fault	The red light flashes 6 times every 5s	
11		Breaker adhesion fault	The red light flashes 7 times every 5s	
12		Leakage fault	The red light flashes 8 times every 5s	
13		Overtemperature fault	The red light flashes 9 times every 5s	
14		Meter fault	The red light flashes 10 times every 5s	
15		Other fault	The red light is on for 1 second	

# 7- Using the APP

- Download APP **Tuya Smart** or **Smart Life** from the APP store and Google Play.



Tuya Smart



Smart Life

- Configure the network of the charging device.

You must connect the charging unit to the same WiFi your phone is connected to.

Please note 5GHz WiFi is not supported. Stand near the charger, open the app and the network status of the charger will be displayed as follows:



WiFi Internet access



No Internet access



Waiting for WiFi connection

- If the network connection fails, please check that the router is working, and operating at a frequency of 2.4Ghz (if applicable). Please also ensure that you aren't too far away from the charger!

---

## • App Demonstration

Ensuring that the phone's WiFi and Bluetooth are on, click on the "+" in the top right hand corner to automatically search for devices. Select 'ChargePoint' and enter the WiFi name and password

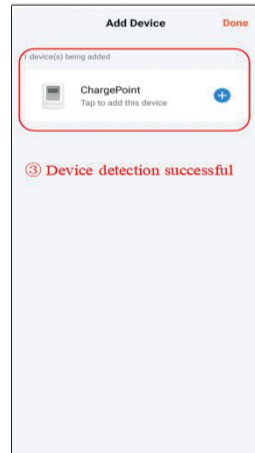
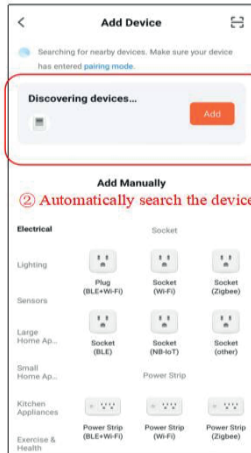



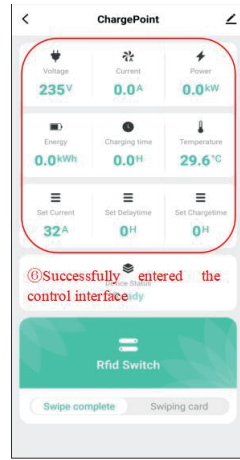
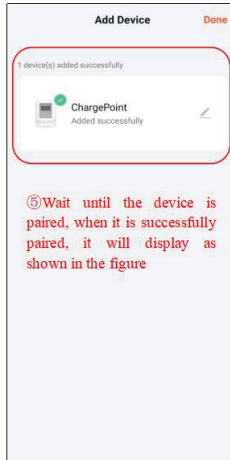
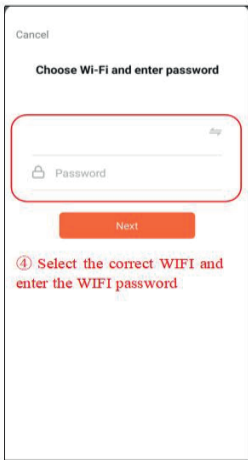

**Note:** Please Note: If you delete the charger after it has been successfully linked to the app, you must repeat the above process and pair them again.

## 8- Screen Displays

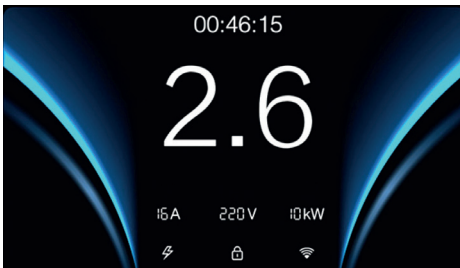

The default screen will show the time elapsed, the charging power, the voltage, the current and the power provided during the current charge.

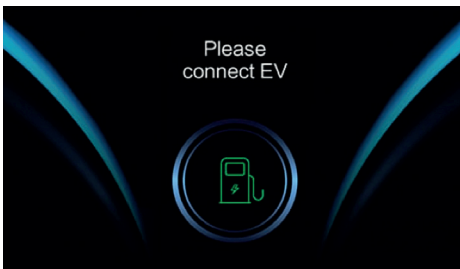

The standby screen shows the charger is waiting for connection.

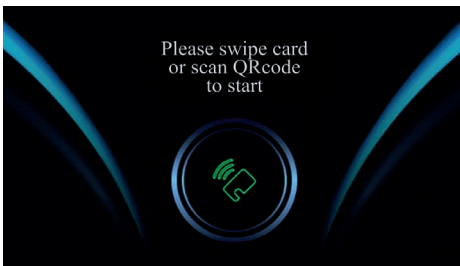

Unlocking screen shows methods to unlock charging, by swiping a RFID card or scanning a QR code.

# 9- Appendix:

## 9.1. Precautions

- 9.1.1. The power supply used must be consistent with the requirements of this equipment and the three core power cord must be reliably grounded.
- 9.1.2. Please strictly follow the design parameters and use conditions during use, and do not exceed the threshold value in this user manual, otherwise the equipment may be damaged.
- 9.1.3. Please do not change the specification of electrical components, and do not change the internal circuit or graft other circuits.
- 9.1.4. After the unit has been installed, if it is not working and there are no flashing red lights, please get your engineer to check the power wiring.
- 9.1.5. The equipment has limited dust-proof and water-proof capacity. Power it off immediately and stop using it.
- 9.1.6. The device has limited anti-theft function. Please install it in a safe and reliable environment.
- 9.1.7. Please do not unplug the charger from the vehicle unnecessarily during charging.

## 9.2. Troubleshooting

- 9.2.1. **Line Problems:** The minimum incoming cable of each charging unit is 5 x 10mm<sup>2</sup>, and the length shall not exceed 40 meters. If the length exceeds 40 meters, Use a 5 x 16mm<sup>2</sup> cable. The 32A equipment uses the C60 air switch.
- 9.2.2. **Charging while the car is on:** There is a battery icon on the upper right of the display interface. If it is grey, that is because the vehicle is on and the unit will not charge when the vehicle is on. Please turn the car off and try again.
- 9.2.3. **Overvoltage and Undervoltage:** The lower right corner of the equipment shows overvoltage or undervoltage. Please check the circuit. The voltage may be too high or too low. Use a multimeter to measure the voltage at the incoming line of the equipment, and then measure the voltage at the incoming line of the distribution box.

Fault phenomenon	Possible causes	Solution
Charge unit LED or display screen does not light up	The power supply is not well connected	Check whether the incoming power line is energized and whether the power switch is closed.
	Circuit breaker trip	The leakage tripping function is tripped, so open the side switch cover and close the circuit breaker switch.
	Equipment damage	Please contact the customer service center for maintenance.
Unable to start charging	The charging gun is not fully connected	Check whether the charger is firmly connected to the vehicle socket and ensure that the charger is plugged fully into socket.
Charging current is less than rated value	Equipment failure or vehicle approaching full load	When the vehicle is nearly fully charged, it is expected that the charging current will drop. If the current is dropping before full charge, please contact customer service center for maintenance.
Equipment Failure Lights On	Fault light flashes	Contact the customer service center for maintenance.
	The fault light is always on	

- 9.2.4. **Leakage alarm-** If leakage is displayed on the device screen, it may be the vehicle leakage or the screws at the equipment incoming line are not tightened. First check whether the equipment incoming line is firmly connected. If it is, then please try charge a different vehicle or charge your vehicle elsewhere to confirm there is not a fault with the vehicle (for example at a charging station).

# 10- Guarantee

Subject to the provisions described below, this product is protected for 1 year from the date of purchase against defects in material and workmanship.

Prior to returning any defective products to Vorsprung, the end user must report the faulty product to Vorsprung. This can be done through emailing [info@vorsprungofficial.com](mailto:info@vorsprungofficial.com). If Vorsprung agrees that the product should be returned, It will Issue a Return Authorisation Number. This number must be clearly marked on the packaging of the product to be returned. The customer will return the product at their own cost.

Should the product fail to perform as described within the relevant guaranteed period as set out above, it will be repaired or replaced with the same or functionally equivalent product by Vorsprung at its discretion, free of charge, provided the customer:

- 1) Provides Vorsprung with proof of purchase.
- 2) Returns the failed product to Vorsprung with shipping charge prepaid.

Replacement products may be refurbished or contain refurbished materials. If Vorsprung, by its sole determination, is unable to repair or replace the defective product, It will replace or refund the purchase price of the product.

The guarantee does not apply and will be null and void if, in judgement to Vorsprung, the product fails due to damage from shipment handling, storage, Incorrect Installation, accident, inappropriate use or cleaning of the product, relocation of the product after its first Installation, abuse, misuse, or if It has been used or maintained in a manner not conforming to product manual instructions, has been modified in any way, or has had any serial number or other Identification markings removed or defaced.

Repair by anyone other than a qualified engineer will void this guarantee.

All defective products should be returned to Vorsprung with shipping charges prepaid.

Should an issue be found with your unit. Vorsprung will return your repaired/replaced unit free-of-charge to any UK address. Should the return address be outside of the UK return postage will be at Vorsprung's discretion. If the unit is found not to be defective return postage will need to be paid for by the customer.

Nothing in this agreement will affect the end consumer's statutory rights. Vorsprung only supply products for domestic, light commercial and private use.

Vorsprung only supply products for domestic, light commercial and private use. Vorsprung accept no liability to the end consumer for any loss of profit, loss of business, business interruption, loss of business opportunity or time travel incurred.

# Electric Vehicle AC Charging Unit

## User Manual

Models: 20145 (Q9)

**VORSPRUNG**<sup>®</sup>