



Fixed Down Sconce



Technical Specifications

Materials	Steel or brass
Product weight	1.25 lbs
Lead time	Painted metal: 2 weeks Brass: 4 weeks
Bulbs included (1)	E12 / 110 V / 3.0 W / 180 lm / 2700 K
Dimmer	TRIAC
Max wattage	10 W
Certifications	UL listed, damp-rated



Notes

1. This fixture can be specified with a rotary dimmer switch installed on its base. The dimmer switch scan be located on either the left or right side of the shades.

Updated April 10, 2023

Front View

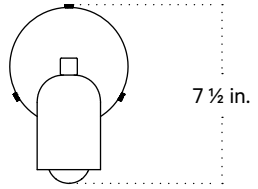

Side View

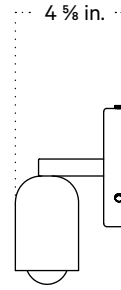

Top View

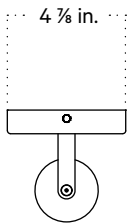

Isometric View

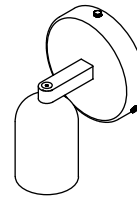

Fixed Down Sconce, Left Switch



Technical Specifications

Materials	Steel or brass
Product weight	1.25 lbs
Lead time	Painted metal: 2 weeks Brass: 4 weeks
Bulbs included (1)	E12 / 110 V / 3.0 W / 180 lm / 2700 K
Dimmer	Integrated dimmer switch
Max wattage	10 W
Certifications	UL listed, damp-rated



Notes

1. This fixture can be specified with a rotary dimmer switch installed on its base. The dimmer switch can be located on either the left or right side of the shades.

Updated April 10, 2023

Front View

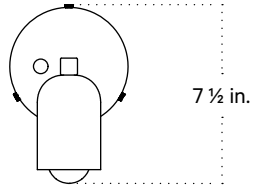

Side View

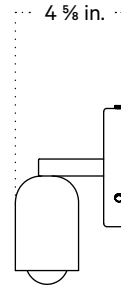

Top View

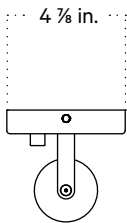

Isometric View

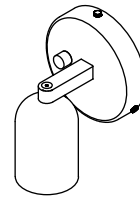

Fixed Down Sconce, Right Switch

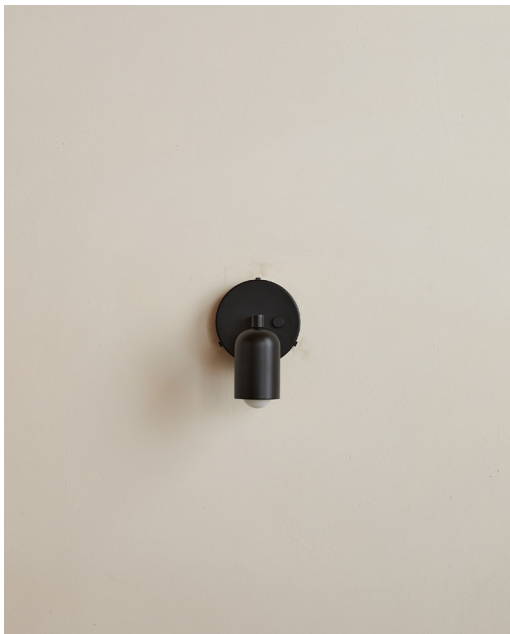

Technical Specifications

Materials	Steel or brass
Product weight	1.25 lbs
Lead time	Painted metal: 2 weeks Brass: 4 weeks
Bulbs included (1)	E12 / 110 V / 3.0 W / 180 lm / 2700 K
Dimmer	Integrated dimmer switch
Max wattage	10 W
Certifications	UL listed, damp-rated



Notes

1. This fixture can be specified with a rotary dimmer switch installed on its base. The dimmer switch can be located on either the left or right side of the shades.

Updated April 10, 2023

Front View

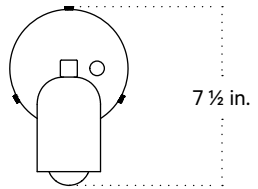

Side View

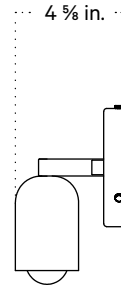

Top View

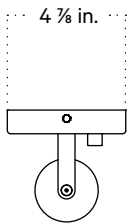

Isometric View

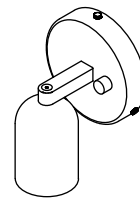



Fixed Down Sconce, Plug-in

Technical Specifications

Materials	Steel or brass
Product weight	1.75 lbs
Lead time	Painted metal: 2 weeks Brass: 4 weeks
Bulbs included (1)	E12 / 110 V / 3.0 W / 180 lm / 2700 K
Dimmer	Optional in-line dimmer switch
Cord length	10 ft
Max wattage	10 W
Certifications	UL listed, damp-rated



Notes

1. This fixture can be ordered with an on/off switch or an inline dimmer; see additional details below.
2. Fixtures ordered in painted metal with an on/off switch come with a 10-foot black fabric cord. The on/off switch is located 2 feet from the plug.
3. Fixtures ordered in painted metal with an inline dimmer have a 16-foot black nylon cord. The dimmer switch is our black painted metal finish and is located 8 feet from the plug.
4. Fixtures ordered in brass finishes with an on/off switch come with a 10-foot chocolate brown fabric cord. The on/off switch is located 2 feet from the plug.
5. Fixtures ordered in brass finishes with an inline dimmer have a 16-foot chocolate brown fabric cord. The dimmer switch is our black painted metal finish and is located 8 feet from the plug.
6. Custom cord color can be specified for an additional cost; please inquire.

Updated April 10, 2023

Front View

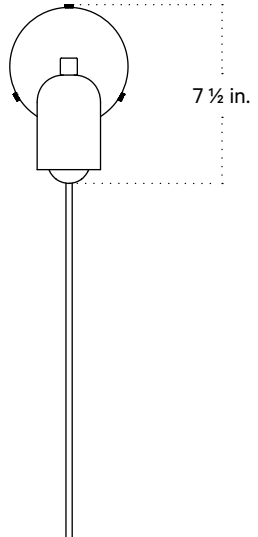

Side View

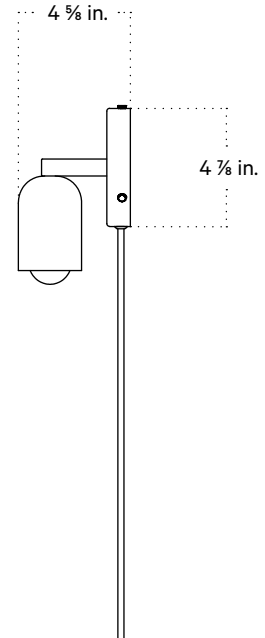

Inline Dimmer Switch Detail

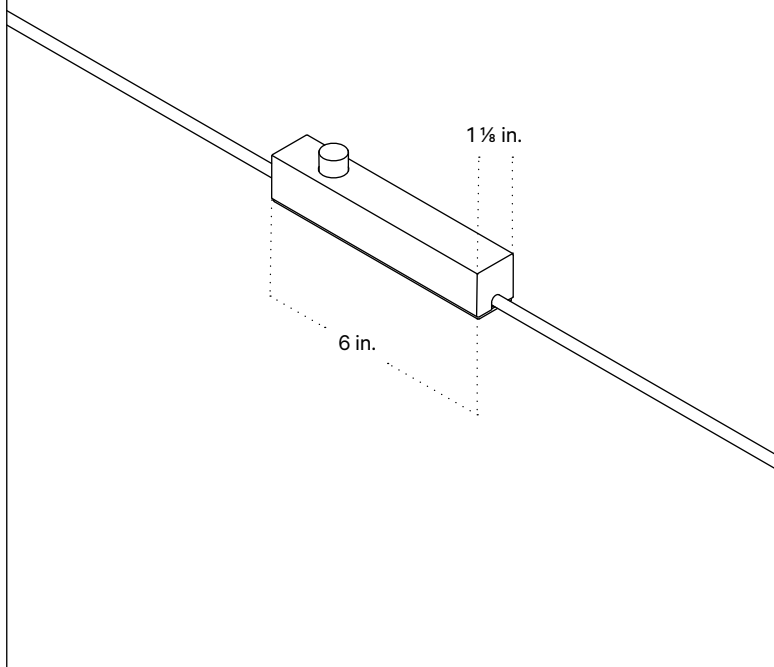

On/off Switch Detail

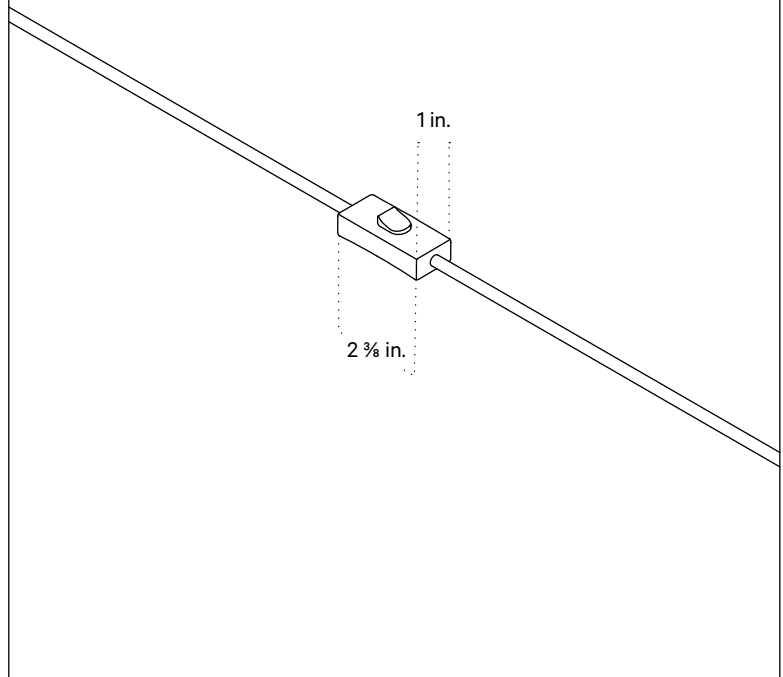



Fixed Down Sconce, Plug-in Left Switch

Technical Specifications

Materials	Steel or brass
Product weight	1.75 lbs
Lead time	Painted metal: 2 weeks Brass: 4 weeks
Bulbs included (1)	E12 / 110 V / 3.0 W / 180 lm / 2700 K
Dimmer	Integrated dimmer switch
Cord length	10 ft
Max wattage	10 W
Certifications	UL listed, damp-rated



Notes

1. This fixture can be ordered with an on/off switch or an inline dimmer; see additional details below.
2. Fixtures ordered in painted metal with an on/off switch come with a 10-foot black fabric cord. The on/off switch is located 2 feet from the plug.
3. Fixtures ordered in painted metal with an inline dimmer have a 16-foot black nylon cord. The dimmer switch is our black painted metal finish and is located 8 feet from the plug.
4. Fixtures ordered in brass finishes with an on/off switch come with a 10-foot chocolate brown fabric cord. The on/off switch is located 2 feet from the plug.
5. Fixtures ordered in brass finishes with an inline dimmer have a 16-foot chocolate brown fabric cord. The dimmer switch is our black painted metal finish and is located 8 feet from the plug.
6. Custom cord color can be specified for an additional cost; please inquire.
7. This fixture can be specified with a rotary dimmer switch installed on its base. The dimmer switch can be located on either the left or right side of the shades.

Updated April 10, 2023

Front View

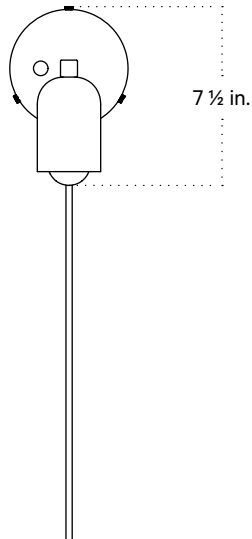

Side View

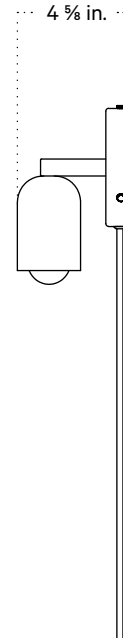

Top View

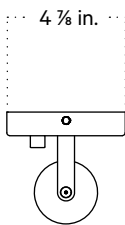

Isometric View

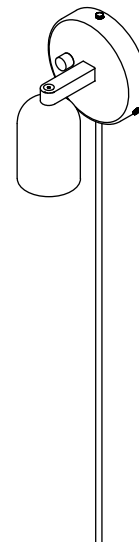

Fixed Down Sconce, Plug-in Right Switch

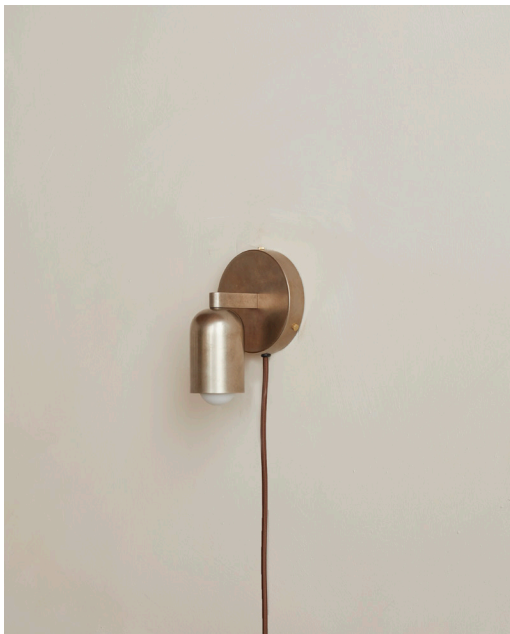

Technical Specifications

Materials	Steel or brass
Product weight	1.75 lbs
Lead time	Painted metal: 2 weeks Brass: 4 weeks
Bulbs included (1)	E12 / 110 V / 3.0 W / 180 lm / 2700 K
Dimmer	Integrated dimmer switch
Cord length	10 ft
Max wattage	10 W
Certifications	UL listed, damp-rated



Notes

1. This fixture can be ordered with an on/off switch or an inline dimmer; see additional details below.
2. Fixtures ordered in painted metal with an on/off switch come with a 10-foot black fabric cord. The on/off switch is located 2 feet from the plug.
3. Fixtures ordered in painted metal with an inline dimmer have a 16-foot black nylon cord. The dimmer switch is our black painted metal finish and is located 8 feet from the plug.
4. Fixtures ordered in brass finishes with an on/off switch come with a 10-foot chocolate brown fabric cord. The on/off switch is located 2 feet from the plug.
5. Fixtures ordered in brass finishes with an inline dimmer have a 16-foot chocolate brown fabric cord. The dimmer switch is our black painted metal finish and is located 8 feet from the plug.
6. Custom cord color can be specified for an additional cost; please inquire.
7. This fixture can be specified with a rotary dimmer switch installed on its base. The dimmer switch can be located on either the left or right side of the shades.

Updated April 10, 2023

Front View

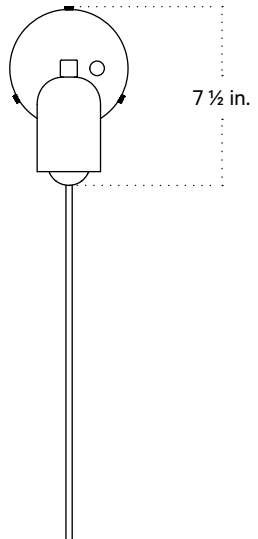

Side View

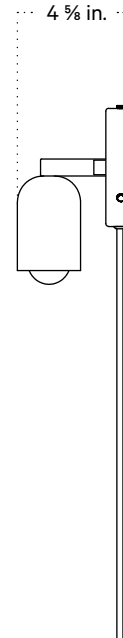

Top View

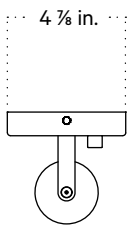

Isometric View

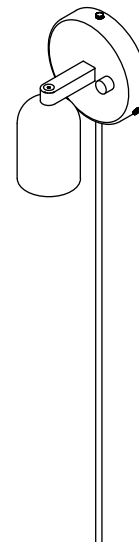

Finish Options

Brass, glass, and ceramic samples made or finished by hand may exhibit variability. Available for purchase at incommonwith.com/finishes.

Painted Metal



Black



Bone



Oxide Red



Reed Green



Peach

Brass



Brass



Patina Brass



Blackened Brass



Pewter