

# Operating Instructions

**AUSTROMAT™**

**664i™ / 674i™**



Version 03/2020

DEKEMA Dental-Keramiköfen GmbH  
Industriestrasse 22  
D-83395 Freilassing  
Tel. +49-8654-4639-0  
Fax +49-8654-66195  
E-mail: [info@dekema.com](mailto:info@dekema.com)  
Website: [www.dekema.com](http://www.dekema.com)

Copyright © DEKEMA Dental-Keramiköfen GmbH 2020. All rights reserved.

This document may not be passed on and copied and its contents may not be used or disclosed without the express permission of DEKEMA Dental-Keramiköfen GmbH. We retain the right to assert damages upon the violation of this provision. All rights retained, especially when a patent has been granted or a utility model has been registered.

The software uses several icons made by [Freepik](https://www.freepik.com) from [www.flaticon.com](http://www.flaticon.com).

#### **Exclusion of liability**

Although we have reviewed the contents of this document to determine its correspondence with the described hardware and software, some differences may exist. We assume no liability for complete agreement. The information in this document is regularly reviewed. The necessary corrections appear in subsequent editions.

We reserve the right to make changes

# Table of Contents

1.	Usage, data .....	8
1.1.	Introduction .....	8
1.2.	Proper use .....	9
1.3.	Scope of delivery .....	9
1.4.	Name plate .....	10
1.5.	Technical data .....	11
1.6.	Ambient conditions.....	12
2.	Safety .....	13
2.1.	This section must be read!.....	13
2.2.	Organization of the safety instructions .....	13
2.3.	General safety regulations .....	14
2.3.1.	Personnel.....	14
2.3.2.	Operating instructions.....	14
2.3.3.	Operation.....	15
2.3.4.	Maintenance and Service .....	16
2.3.5.	Disposal.....	16
2.4.	Risks .....	17
2.5.	Access rights .....	20
2.6.	Stop function.....	20
3.	Design and function .....	21
3.1.	Front of system .....	21
3.2.	Touchscreen and function elements.....	22
3.2.1.	Touchscreen.....	22
3.2.2.	Function elements .....	23

<b>3.3.</b>	<b>Rear of device .....</b>	<b>24</b>
<b>4.</b>	<b>Start-up .....</b>	<b>25</b>
<b>4.1.</b>	<b>Unpacking and setting up .....</b>	<b>25</b>
<b>4.2.</b>	<b>Requirements at the setup site.....</b>	<b>26</b>
<b>4.3.</b>	<b>Installing the heating elements .....</b>	<b>27</b>
<b>4.4.</b>	<b>First Startup.....</b>	<b>28</b>
4.4.1.	Procedure .....	28
4.4.2.	Installation assistant (country-specific).....	29
<b>4.5.</b>	<b>Connect the firing furnace to the network.....</b>	<b>29</b>
4.5.1.	Determine the IP address .....	30
4.5.2.	Setting up the operation of the firing furnace using a VNC program.....	31
4.5.3.	Setting up the operation of the firing furnace using a browser .....	33
4.5.4.	Setting up a permanent IP address for the firing furnace .....	34
4.5.5.	Specify authorizations.....	35
<b>4.6.</b>	<b>Connect the firing furnace to an individual PC.....</b>	<b>36</b>
4.6.1.	Operating the firing furnace using a VNC program .....	36
4.6.2.	Setting up the operation of the firing furnace using a browser .....	36
<b>5.</b>	<b>User interface .....</b>	<b>37</b>
<b>5.1.</b>	<b>Basic information.....</b>	<b>37</b>
5.1.1.	Terms .....	37
5.1.2.	Screen elements .....	38
5.1.3.	Numeric screen keyboard .....	39
5.1.4.	Alphanumeric keyboard window .....	40
5.1.5.	Keyboard window for the classic editor .....	41
<b>5.2.</b>	<b>Screen display.....</b>	<b>42</b>
<b>5.3.</b>	<b>Program Manager .....</b>	<b>43</b>
<b>5.4.</b>	<b>Program display .....</b>	<b>46</b>
5.4.1.	Professional programs .....	46
5.4.2.	Classic programs .....	49
5.4.3.	Chairside programs.....	51
5.4.4.	Pictures .....	52



<b>5.5.</b>	<b>Program sequence.....</b>	<b>54</b>
5.5.1.	Professional programs.....	56
5.5.2.	Classic programs.....	56
5.5.3.	Chairside programs.....	57
<b>5.6.</b>	<b>Program editor.....</b>	<b>58</b>
5.6.1.	Editing professional programs.....	58
5.6.2.	Editing classic programs.....	59
5.6.3.	Editing chairside programs.....	61
5.6.4.	Creating a new program.....	62
5.6.5.	Programming Suggestions.....	63
<b>5.7.</b>	<b>Setup menu.....</b>	<b>64</b>
5.7.1.	Settings.....	67
5.7.1.1.	Units.....	67
5.7.1.2.	Language.....	68
5.7.1.3.	Date/time.....	69
5.7.1.4.	Screen settings.....	70
5.7.1.5.	Network.....	71
5.7.1.6.	General code.....	73
5.7.1.7.	Furnace ID.....	75
5.7.1.8.	Acoustic signal.....	76
5.7.1.9.	Lift settings.....	77
5.7.2.	Programs.....	78
5.7.2.1.	Drying.....	78
5.7.2.2.	Check program.....	79
5.7.2.3.	Oxidation.....	80
5.7.2.4.	Temperature calibration.....	81
5.7.3.	Communication.....	82
5.7.3.1.	Printer.....	82
5.7.3.2.	Quality management.....	83
5.7.3.3.	Diagnostic data.....	84
5.7.3.4.	Login data.....	85
5.7.3.5.	Backup / Recovery.....	86
5.7.3.6.	Circle Login.....	89
5.7.3.7.	FTP Server Login.....	91
<b>6.</b>	<b>Operation.....</b>	<b>93</b>
<b>6.1.</b>	<b>Turning on and off.....</b>	<b>93</b>

<b>6.2.</b>	<b>Mounting and removing a firing object.....</b>	<b>94</b>
<b>6.3.</b>	<b>Select programs and start them .....</b>	<b>96</b>
6.3.1.	With the touchscreen .....	96
6.3.2.	With web interface .....	96
6.3.3.	With VNC program.....	97
6.3.4.	With iOS device .....	97
6.3.5.	Operating layout for the menu control .....	98
<b>6.4.</b>	<b>Program end.....</b>	<b>99</b>
<b>6.5.</b>	<b>Some practical tips .....</b>	<b>100</b>
6.5.1.	General operation of the furnace .....	100
6.5.2.	Heating element.....	100
6.5.3.	Thermocouple - temperature calibration.....	100
6.5.4.	Programming and program steps .....	101
6.5.5.	Firing programs.....	101
<b>6.6.</b>	<b>Backing up and restoring firing programs .....</b>	<b>102</b>
<b>6.7.</b>	<b>Backing up and restoring data .....</b>	<b>102</b>
<b>6.8.</b>	<b>Loading sets and firing programs .....</b>	<b>103</b>
6.8.1.	Sets and programs on the local memory .....	103
6.8.2.	Sets and programs on a USB stick.....	104
6.8.3.	Sets and programs from the Internet.....	104
6.8.4.	Sets and programs in the Circle .....	105
6.8.5.	Sets and programs from an FTP Server.....	105
<b>6.9.</b>	<b>Access the firing furnace via FTP .....</b>	<b>106</b>
<b>6.10.</b>	<b>Quality assurance .....</b>	<b>108</b>
6.10.1.	QM logs.....	108
6.10.2.	X-Dream (optional).....	109
6.10.3.	OPC (optional) .....	109
<b>6.11.</b>	<b>After a power failure .....</b>	<b>110</b>
<b>7.</b>	<b>Maintenance and Service .....</b>	<b>111</b>
<b>7.1.</b>	<b>Care .....</b>	<b>111</b>
<b>7.2.</b>	<b>Calibrate temperature .....</b>	<b>112</b>
<b>7.3.</b>	<b>Check program.....</b>	<b>116</b>

---

<b>7.4.</b>	<b>Change the heating element .....</b>	<b>117</b>
<b>7.5.</b>	<b>Software update .....</b>	<b>117</b>
<b>7.6.</b>	<b>Service and Transport .....</b>	<b>118</b>
<b>8.</b>	<b>Storage and disposal .....</b>	<b>119</b>
<b>8.1.</b>	<b>Storage.....</b>	<b>119</b>
<b>8.2.</b>	<b>Disposal .....</b>	<b>120</b>
8.2.1.	Personnel qualifications.....	120
8.2.2.	Legal guidelines.....	120
8.2.3.	Disposal: Electrical and electronic materials.....	121
8.2.4.	Disposal: Other assemblies and components.....	121
<b>9.</b>	<b>Safety data sheets .....</b>	<b>122</b>
<b>9.1.</b>	<b>"Altraform" safety data sheet .....</b>	<b>123</b>
<b>9.2.</b>	<b>"Kerform" safety data sheet .....</b>	<b>129</b>
<b>9.3.</b>	<b>"Isolrath" (Super-Isol) safety data sheet.....</b>	<b>141</b>
<b>10.</b>	<b>Index .....</b>	<b>144</b>

# 1. Usage, data

## 1.1. Introduction

Dear customer,

You are in possession of a new, exceptional AUSTROMAT™ firing furnace.

DEKEMA's many years of experience in the field of firing furnace construction have gone into this equipment ensuring a very high level of quality, and exceptional performance and reliability. In order to take full advantage of the possibilities that your firing furnace offers and obtain superior results, we would like to ask you to spend a little time studying these operating instructions.

- The technical data and description of the usage of the firing furnace can be found in section 1 Usage, data.
- Before you start using the firing furnace, it is essential that you read section 2 Safety to prevent personal injury and property damage.
- Section 3 Design and function provides a short description of the firing furnace.
- How to set up and start the firing furnace is described in section 4 Start-up. Here you will find how to connect the firing furnace to a network or an individual computer.
- The menu control of the firing furnace is described in detail in section 5 User interface.
- The operation of the firing furnace is explained in section 6 Operation, from the first steps in to the creation of firing programs. Practical examples and tips will help you identify the sources of troubles and assist you in eliminating them.
- Follow the suggestions for the service and maintenance of the device in section 7 Maintenance and Service.
- Finally, the index enables you to quickly find specific functions or commands.



Fig. 1-1 AUSTROMAT™ 664i™ (left) and AUSTROMAT™ 674i™ (right)

## 1.2. Proper use

The AUSTROMAT™ firing furnace was designed for firing dental ceramic objects. In every task that you perform with the firing furnace, observe the safety instructions in the section Safety.

Every use that goes beyond these instructions is held to be improper and can cause personal injury or property damage. We assume no guarantee when the device is improperly used handled or not used according to instructions. DEKEMA assumes no liability for damages that are thereby incurred.

In particular, materials may not be heated that may trigger explosions, implosions and hazardous or hazardous or flammable gases.

Proper use also includes the following:

- Read and following these instructions for use,
- Observe the technical data. See section 1.5,
- Perform service tasks in a timely manner. See section 7.

## 1.3. Scope of delivery

The following components are included in the delivery of the firing furnace:

- AUSTROMAT™ 664i™ or 674i™ firing furnace with power cable,
- Insulation table, one sinter ring, one sinter plate, and furnace tweezers (only 664i™),
- Operating instructions,
- Packaging material:
  - Cardboard boxes,
  - Foam material for protecting against impacts,
- Calibration set for calibrating the temperature.

Ensure that delivery is complete, and that the components have not suffered any visible damage in transport. If this is not the case, please immediately contact your service partner. Please store the packaging in case you need to ship the equipment at a later date.

## 1.4. Name plate

The information on the name plate describes the firing furnace and also offers potential customer-specific adaptations. In all correspondence with DEKEMA, please indicate all of the data that is on the name plate.

The name plate is on the back of the firing furnace.



Fig. 1-2 Example of name plate

## 1.5. Technical data

The technical data of the firing furnace are summarized in the following table. The cited connection values and tolerances must be maintained for the firing furnace to operate properly and for the warranty to take effect.

### Dimensions and weight

- Dimensions: 383 x 780 x 343 mm (width x height x depth)  
see Fig. 1-3
- Firing chamber useful dimensions:
  - Firing function:
    - AUSTROMAT™ 664i™: 60 mm x 50 mm (diameter x height)
    - AUSTROMAT™ 674i™: 100 mm x 50 mm (diameter x height)
- Weight:
  - AUSTROMAT™ 664i™: 23 kg
  - AUSTROMAT™ 674i™: 25 kg

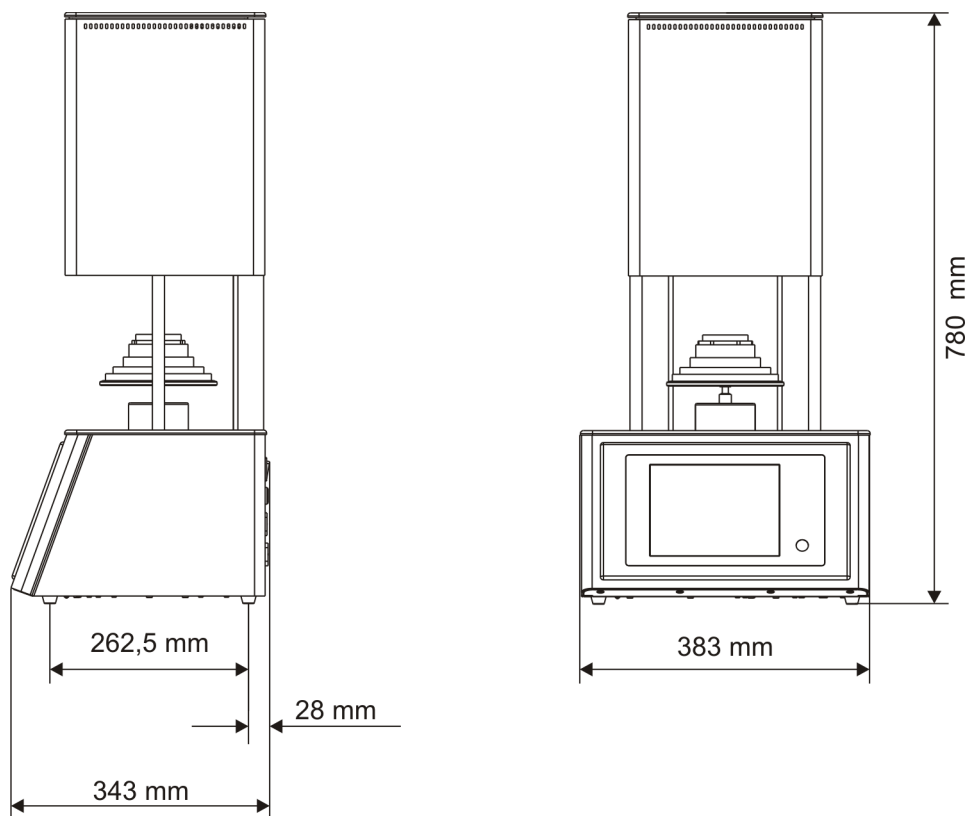

Fig. 1-3 Dimensions

### Electrical supply data

**NOTE:**

**Only use fuses with the indicated lag and nominal current.**

- Supply voltage: See rating plate on the rear:
  - ~ 230 VAC / 50...60 Hz
- Fuses: See rating plate on the rear:
  - ~230 V: 2 x 16 A T 250 V

### Service data

- Power consumption: max. 2000 W for 230 V
- Firing temperature: max. 1560 °C

### Interfaces

- USB interface
- Network interface

## 1.6. Ambient conditions

**NOTE:**

**The firing furnace should not be operated for some time after sudden change of ambient temperature as otherwise condensation may occur in the electronic components, thus causing damage.**

The data for the ambient temperature and humidity are designed for conditions at sea level.

- During operation:
  - Temperature: +15°C...+35°C
  - Humidity: max. 60 %, non-condensing
  - Height above sea level max. 2000 m
- When not operating and during storage:
  - Temperature: +10 °C...+50 °C
  - Humidity: max. 80 %, non-condensing
- During transport:
  - Temperature: -10 °C...+55°C
  - Humidity: max. 80 %, non-condensing



## 2. Safety

### 2.1. This section must be read!



Read this entire section before you start working with the firing furnace! It contains important instructions for your personal safety.



This section must be read and understood by all persons who work with this firing furnace in any phase of the product life of the AUSTROMAT™ to prevent damage to persons and/or material.

### 2.2. Organization of the safety instructions

The following safety instructions Safety instructions refer to various hazard levels.

	 <b>DANGER</b>
	<p><b>DANGER</b> identifies a direct, high risk hazard that can cause death or serious bodily injury if it is not avoided.</p>

	 <b>WARNING</b>
	<p><b>WARNING</b> identifies a potential, medium-level hazard that can cause death or serious bodily injury if it is not avoided.</p>

	 <b>CAUTION</b>
	<p><b>CAUTION</b> identifies a low-risk hazard that can cause slight or moderate bodily injury or property damage if it is not avoided.</p>

**NOTE:**

A note such as this refers to particularly important information that, however, does not concern safety.

## 2.3. General safety regulations

### 2.3.1. Personnel

All personnel who work with the AUSTROMAT™ must have the required technical qualifications and have received appropriate instruction and training. They must be informed about all dangers and risks in conjunction with this system.

### 2.3.2. Operating instructions

#### Read and learn



Anyone who works on or with the AUSTROMAT™ firing furnace in any phase of the product life must read these operating instructions and understand them. This concerns in particular chapter 2 Safety.

#### Retention

The operating instructions are delivered along with the firing furnace and are considered an essential component of the product. They must be stored with the firing furnace in a highly visible location and be directly accessible. You can order additional copies of the operating instructions from DEKEMA (see page 2).

#### Completeness

Always use the complete original version of these operating instructions. The instructions in the operating instructions contain cross-references to other sections containing important information. Incomplete copies or copies of individual pages can not provide all the necessary information of the operating instructions.

 <b>WARNING</b>	
	<p><b>Incomplete operating instructions.</b></p> <p><b>A lack of safety instructions due to incomplete operating instructions can cause serious injury and property damage.</b></p> <p><b>Always perform work with a complete copy of the operating instructions. Do not copy individual pages.</b></p>

### 2.3.3. Operation

**Use**

The AUSTROMAT™ firing furnace may only be used for its intended purpose (see section 1.2). All instructions and procedures that can affect the safety of persons or the firing furnace are forbidden. The branch-specific and local regulations concerning accident prevention must be observed.

Please keep the lift closed. Due to increasing surface temperatures the furnace shall not operate for more than one hour with an open lift above 800 °C.

Chemical substances can contaminate the firing chamber during firing and sintering processes. At high temperatures volatile ingredients can affect system components and reduce their lifetime significantly. In particular, take this into account when using glazing material and colorants for zirconium.

- Always observe the application instructions.
- Use only cycles that are approved by the manufacturer.
- Contact your ceramics manufacturer when you are unsure or have questions.

**Condition**

The firing furnace may only be operated when it is functioning properly, and with supervision. Observe the technical data in section 1.5.

If the firing furnace can no longer be operated safely, immediately unplug it and prevent it from being unintentionally operated. Reasons for assuming that the equipment cannot be used safely:

- An alarm message appears,
- Visible damage to the housing or power cable,
- Malfunctions,
- Frequently required fuse changes,
- Long storage in a problematic environment (moisture, see section 1.6).

**Safety stickers**

Safety stickers are affixed to the firing furnace and provide notification of residual danger. The safety stickers may not be removed. They must be replaced if they are lost or are no longer clearly legible.

**Workplace**

The operator must provide corresponding instructions and inspections to ensure order and cleanliness of the workplace and the surroundings of the AUSTROMAT™ firing furnace.

**Waste**

If polluting waste arises from use, the operator is responsible for the proper disposal.

### 2.3.4. Maintenance and Service

#### Spare parts

	<b>⚠ WARNING</b>
	<p><b>Non-original spare parts.</b></p> <p><b>Malfunctions can arise if third-party parts are used. In certain circumstances, this can cause serious injury and substantial property damage.</b></p> <p><b>Always use original spare parts from DEKEMA. See section 7.6.</b></p>

#### Retrofitting



Independent retrofitting and changes that affect the safety of the firing furnace are forbidden.

### 2.3.5. Disposal

The operator must carefully dispose of the firing furnace in accordance with regulations. He can give it to a licensed, private or public collection facility, or recycle it or dispose of it himself. See section 8.2.

## 2.4. Risks

Observe the following hazard instructions in all of your jobs with the firing furnace.

 <b>DANGER</b>	
	<p><b>Electrical shock from voltage-conducting parts.</b></p> <p>The firing furnace is operated using mains voltage. Death may result due to electrical shock from touching voltage-conducting parts.</p> <p><b>Observe the following instructions:</b></p> <ul style="list-style-type: none"><li>• Never contact voltage-conducting parts,</li><li>• Do not use your hands or any objects to grasp things in the firing chamber,</li><li>• Maintenance and service jobs may only be performed when a device is not powered. Turn off the firing furnace, and pull the power plug,</li><li>• The protective conductor (inside and outside of the unit) must always be safe for operation and may never be disabled. The connection may never be intentionally severed.</li></ul>

**NOTE:**

**Only personnel with electrotechnical training and experience with handling devices that operate on mains voltage may perform work on the electrical components.**



**Protection of personnel against electric shock**

The equipment has to be connected with a supply source, which incorporates a circuit-breaker that interrupts the supply at a differential current of 30 mA or less.

The operator has to be protected against electric shock, including electric shock resulting from the possibility of simultaneous contact with hazardous live parts and parts connected to the protective conductor terminal. The following protective means are recommended:

- using insulated tools,
- wearing insulating clothing,
- standing on an insulating surface,
- shrouding of parts connected to the protective conductor terminal with which the operator might come into contact in normal use.

<b>⚠ WARNING</b>	
	<p><b>Fire hazard.</b></p> <p>The firing chamber can reach temperatures above 1,500 °C during operation. Hot firing objects can fall down or flake off when opening the firing chamber. Heat-sensitive materials close to the firing furnace can easily ignite and cause a fire.</p> <p>Observe the following instructions:</p> <ul style="list-style-type: none"><li>• When setting up the firing furnace perform proper fire protection measures (such as fire-proof table, floor cover, and protective panels),</li><li>• Never operate the firing furnace without the insulation table being mounted,</li><li>• The vent holes in the cover of the firing chamber must be unobstructed,</li><li>• Make sure that flammable materials (such as cleaning alcohol, wiping cloths, etc.) or objects that can be damaged by heat are sufficiently distance from the firing furnace,</li><li>• Never operate the firing furnace without supervision.</li></ul>

<b>⚠ WARNING</b>	
 	<p><b>Hot surfaces.</b></p> <p>The firing chamber can reach temperatures above 1,500 °C during operation. There is an extreme burning hazard from touching hot surfaces after the firing chamber is opened.</p> <p>Never directly contact hot parts of the firing furnace. The firing furnace requires several hours to cool after it is turned off.</p> <p>Observe the following instructions:</p> <ul style="list-style-type: none"><li>• Do not use your hands or any objects to grasp things in the firing chamber,</li><li>• Do not grasp the lift seat, insulation table or firing objects with your bare hands,</li><li>• Use suitable tools (tweezers) to remove the firing objects, or wear safety gloves.</li></ul>

	<b>⚠ WARNING</b>
	<p>The firing furnace is heavy.</p> <p>When the firing furnace is transported, there exists the danger of crushing, and the device may become damaged.</p> <p>At least two persons must transport the firing furnace. Wear safety gloves.</p>

	<b>⚠ CAUTION</b>
	<p>Ceramic dust from insulation materials.</p> <p>The firing chamber and insulation table consist of ceramic insulating material. Inhaling ceramic dust can be hazardous to your health.</p> <p>Do not inhale the dust. To remove ceramic dust, use a suitable vacuum cleaner. Read the safety data sheets for the insulation materials in section 9.</p>

## 2.5. Access rights

Three levels are defined for accessing the user interface of the AUSTROMAT™ firing furnace via web browser or VNC software. Access levels 1 and 2 (see following table) are password-protected. The passwords are defined in the "Service" menu using the "Password" function.

The access rights should be issued to the users of the firing furnace based on their knowledge, experience and responsibility.

The firing furnace normally starts in the "Operation" menu. When "General Code" is used, it starts one level higher (level 0).

Access levels	Description
General code (level 0)	<ul style="list-style-type: none"> <li>• Restricted access to the "Setup" menu</li> <li>• Selecting blocked programs and starting them</li> <li>• Edit and create unblocked programs</li> <li>• Unlocking the General Code</li> </ul>
Operation (level 1)	<ul style="list-style-type: none"> <li>• Select all programs and start them</li> <li>• Edit and create all programs</li> <li>• Access to the "Setup" menu</li> </ul>
Service (level 2)	<ul style="list-style-type: none"> <li>• Access to the "Service" menu</li> </ul>

Tab. 2-1 Access levels

## 2.6. Stop function

Press the [ON/OFF] key on the graphical user terminal. See section 3.2.2. All the commands that the firing furnace is executing in standby mode, i.e. no program is running, are immediately interrupted without a query.



### 3. Design and function

#### 3.1. Front of system

The following figure shows the front of the AUSTROMAT™ firing furnace and identifies the most important components.



Fig. 3-1 Front view of the firing furnace (example AUSTROMAT™ 674i™)

- |   |                                    |   |                                   |
|---|------------------------------------|---|-----------------------------------|
| 1 | Firing chamber cover               | 5 | Lift seat with sealing ring       |
| 2 | Top of furnace with firing chamber | 6 | Bottom cover plate                |
| 3 | Back column                        | 7 | Bottom oven part with electronics |
| 4 | Insulation table                   | 8 | User interface with touchscreen   |

The top of the firing furnace contains the firing chamber and ventilation slots for cooling the firing furnace. The area in the bottom of the housing contains the electronic and mechanical furnace components. They are used to move the lift system comprising the lift rod, lift seat with sealing ring (O-ring), and the insulation table on which the objects to be fired are placed. The firing furnace is operated using a touchscreen and function keys.

## 3.2. Touchscreen and function elements



Fig. 3-2 Touchscreen and function elements

- 1 Touchscreen  
3 On-Off-key

- 2 Swiping bar for lift

### 3.2.1. Touchscreen

**NOTE:**

**Never use hard or sharp objects (such as screwdrivers, tweezers, etc.) to operate the touchscreen. This will scratch and damage the screen.**



The touchscreen allows you to operate the firing furnace by fingers as known from a smartphone. The integrated swipe gestures allow e.g. scrolling lists.

Please note: After the firing furnace is turned on, the control starts. This can take approximately 1 minute. Only then does the touchscreen appear.

The description of the user interface is found in section 5.

### 3.2.2. Function elements

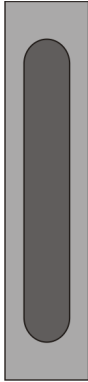
You can use the swiping bar next to the touchscreen to move the lift up or down, and the ON/OFF button to terminate the current program or go to standby mode. When the firing furnace is connected to a network or an individual computer and is correspondingly set up (see section 4.5), you can execute these functions using the computer keyboard.

Element	Name	Computer keyboard *)	Description
	Swiping bar for lift	[F1]	<ul style="list-style-type: none"> <li>Swipe from bottom to top to move the lift upward.</li> <li>Press again to stop the lift.</li> </ul>
		[F4]	<ul style="list-style-type: none"> <li>Swipe from top to bottom to move the lift downward.</li> <li>Press again to stop the lift.</li> </ul>
			Move the lift in a defined position: <ul style="list-style-type: none"> <li>Press on the top of the swiping bar to move the lift in the top position (closing),</li> <li>Press on the bottom of the swiping bar to move the lift in the bottom position (opening).</li> </ul>
	[ON/OFF]	[F9]	<ul style="list-style-type: none"> <li>Stop function: Press this to end all current commands.</li> <li>On/off switch in standby mode: Press the key and hold it for about 5 seconds.</li> <li>For the first startup (see section 4.4) without any function.</li> </ul>

Tab. 3-1

#### Function elements

\*) The function keys on the computer keyboard must be released to be used See section 5.7.3.4.

### 3.3. Rear of device

The following figure shows the back of the bottom part of the AUSTROMAT™ firing furnace and identifies the most important components.



Fig. 3-3 Rear view of the firing furnace (example)

- |   |                               |   |                                       |
|---|-------------------------------|---|---------------------------------------|
| 1 | Name plate with serial number | 4 | Connection socket for the power cable |
| 2 | Main switch                   | 5 | USB interface                         |
| 3 | Fuse holder with fuses        | 6 | Network interface                     |

The standard equipment on the back of the device comprises:

- The main switch for turning the device on and off,
- Two fuse holders with integrated fuses (see section 1.5),
- Connection socket for the power cable,
- Three interfaces:
  - Two USB interfaces for connecting a USB device such as a USB stick, USB keyboard or USB mouse,
  - Network interface for connecting an Ethernet cable (connecting the firing furnace to a network), or a crossed network cable (connecting the firing furnace to an individual computer).

## 4. Start-up

### 4.1. Unpacking and setting up

<b>⚠ WARNING</b>	
	<p><b>The firing furnace is heavy.</b></p> <p><b>When the firing furnace is transported, there exists the danger of crushing, and the device may become damaged.</b></p> <p><b>Two persons must transport the firing furnace. Wear safety gloves.</b></p>

#### Packaging symbols.

The packaging can be labeled with the packaging symbols shown below. The symbols must be followed.

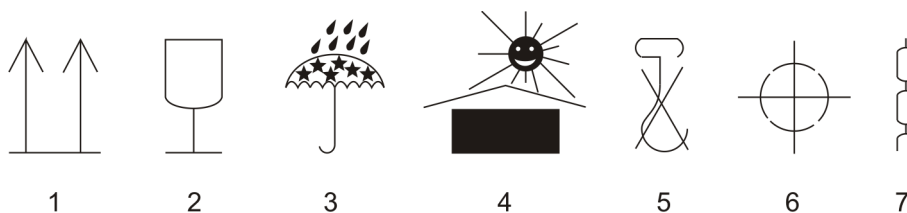

Fig. 4-1

Packaging symbols

- |   |                       |   |                   |
|---|-----------------------|---|-------------------|
| 1 | Top                   | 5 | Do not use hooks  |
| 2 | Fragile               | 6 | Center of gravity |
| 3 | Protect from moisture | 7 | Lifting point     |
| 4 | Keep away from heat   |   |                   |

#### Unpacking

1. Remove the packaging, and keep the packaging material for storing the firing furnace or for later transport.
2. Make sure that all of the parts listed in the scope of delivery are in the delivered package; see section 1.3.
3. Check the delivery for transportation damage. Notify immediately of any complaints.
4. Transport the firing furnace to the provided setup site (see section 4.2).

#### NOTE:

**It is possible that the firing furnace may not be safe to use when there is visible damage to the housing or power cable.**

## 4.2. Requirements at the setup site

	<b>⚠ WARNING</b>
	<p><b>Fire hazard.</b></p> <p>The firing chamber can reach temperatures above 1,500 °C during operation. Hot firing objects can fall down or flake off when opening the firing chamber. Heat-sensitive materials close to the firing furnace can easily ignite and cause a fire.</p> <p>Meet all the requirements at the setup site of the firing furnace.</p>

**NOTE:**

The following instructions must be followed each time the firing furnace is moved and repaired.

**NOTE:**

Set up the firing furnace on a place where you can easily remove the power cable.

**Firing furnace**

The setup site of the firing furnace must meet the following requirements:

- Set up the furnace on a dry, flat, solid, and fire-proof surface.
- The surface must be able to bear the weight of the firing furnace (see section 1.5).
- When setting up the firing furnace perform proper fire protection measures (such as fire-proof table, floor cover, and protective panels) against hot firing objects falling down or flaking off.
- Materials and objects that can be damaged by heat must be sufficiently distant from the firing furnace.
- The vents in the firing furnace must not be obstructed to enable the circulation of cooling air.
- A power socket must be close to the device and easily accessible.
- The conditions in the environment at the setup site must meet the requirements in section 1.6.

### 4.3. Installing the heating elements

The firing furnace is delivered with the heating elements removed. They have to be installed prior to the first startup.

#### How to install heating elements

DEKEMA has extended the portfolio on YouTube ([Dekema Academy™](https://www.youtube.com/channel/UC80C1iRkrHY69XIEEGudx3w), "https://www.youtube.com/channel/UC80C1iRkrHY69XIEEGudx3w"). You find a huge range of movies for application and service of DEKEMA devices.

The video for the assembly of the heating elements is available through the following link. You can also request the videos from DEKEMA (address see p. 2).

- [AUSTROMAT™ 664i™](https://www.youtube.com/watch?v=TFMwG1T8JTk) ("https://www.youtube.com/watch?v=TFMwG1T8JTk")
- [AUSTROMAT™ 674i™](https://www.youtube.com/watch?v=caA8T_mloYY) ("https://www.youtube.com/watch?v=caA8T\_mloYY")

#### NOTE:

Install the heating element wires with a huge distance to the heating elements itself, see Fig. 4-2.

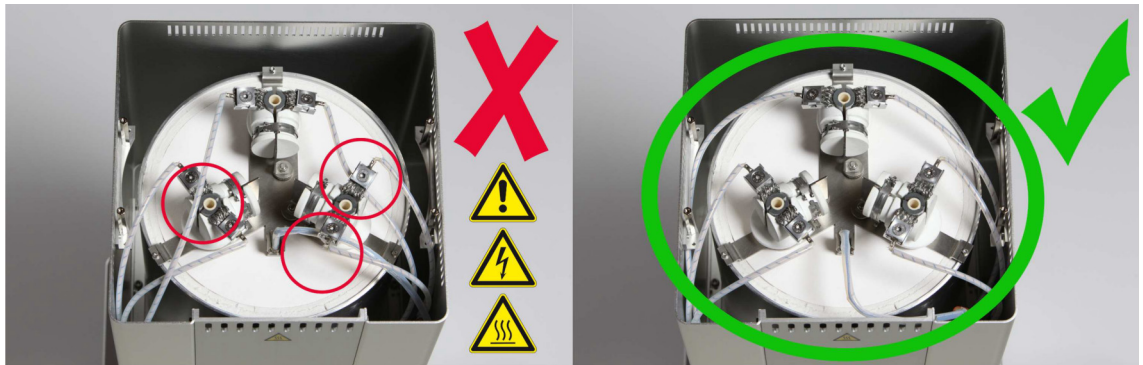

Fig. 4-2 Correct running of the heating element terminal wires

You have installed the heating elements.

## 4.4. First Startup

### 4.4.1. Procedure

**NOTE:**

**When connecting the firing furnace:**

- **The firing furnace is operated using mains voltage.**
- **Use only suitable power sockets with ground contacts, and never use adapter plugs.**
- **Do not run the connection lines past places of the firing furnace that are hot, and especially avoid direct contact.**

1. Make sure that the firing furnace is turned off. The ON/OFF switch is on the back of the furnace (see section 3.3).
2. If you want to operate the firing furnace through a network (Ethernet): Connect a network cable to the interface on the back of the furnace (see section 3.3).
3. If you want to operate the firing furnace with a computer: Connect a crossover network cable to the interface on the back of the furnace (see section 3.3).
4. Plug in the power cable of the firing furnace into a power socket with a ground contact.
5. Turn on the firing furnace. The control of the firing furnace starts up over a period of about 1 minute. The firing furnace performs an internal software and hardware check, and the lift moves down automatically.
6. Make sure that the insulating table is mounted on the lift seat. If not: Turn the firing furnace off, and mount the insulating table.
7. If necessary: Remove any ceramic dust from the lift seat and the sealing ring. Brush the dust into a receptacle. Do not blow away the dust, and do not inhale it.
8. The following ways exist to operate the firing furnace (control software):
  - Operation using the touchscreen and function elements, see section 3.2,
  - Operation using the touchscreen with the USB mouse and USB keyboard (via a USB hub), see section 3.2,
  - Optional operation using a network computer: Connect the firing furnace to the network (see section 4.5).
  - Optional operation using an individual computer: Connect the firing furnace to the computer (see section 4.6).



### 4.4.2. Installation assistant (country-specific)

The (country-specific) Installation Assistant program is also activated in the factory before the delivery.

The installation assistant asks you to mount the insulation table, and runs an installation routine after you confirm by pressing the [START] key: The firing chamber is dried, and the firing furnace is checked. The installation routine takes approximately three hours, and can be terminated at any time with the [STOP] key. The installation assistant is started each time the furnace is turned on until the entire installation routine has run once.

**NOTE:**

**After the installation routine is finished, a message appears and asks you to close the firing chamber to prevent wear. This message always appears when the firing chamber is opened for more than 15 minutes and the chamber temperature is above 200 °C.**

- Acknowledge the message.
- Close the firing chamber.

### 4.5. Connect the firing furnace to the network

**NOTE:**

**The unit shall not be connected directly to TNV networks.**

**Overview of the procedure**

1. Determine the IP address of the firing furnace. See section 4.5.1.
2. Set up remote access to the firing furnace (operation):
  - Access via a VNC program. A VNC program must be installed on your computer. See section 4.5.2.
  - Access through a browser. To do this, Java must be installed on a computer and the browser must be a Java-enabled. See section 4.5.3.
3. Set up a permanent IP address for the firing furnace. See section 4.5.4.
4. Establish access rights for users of the firing furnace. See section 4.5.5.

You can now operate the firing furnace using either the VNC program or a browser.

### 4.5.1. Determine the IP address

**NOTE:**

**Consult your network administrator if you are uncertain.**

1. Make sure that the firing furnace is connected to the Ethernet (interface for the network cable on the back of the unit),
2. Turn on the firing furnace and confirm any error messages. After the furnace is turned on, the Program Manager automatically appears.
3. Tap on [Setup] > [Network] in the Program Manager. The window "Network settings" opens.

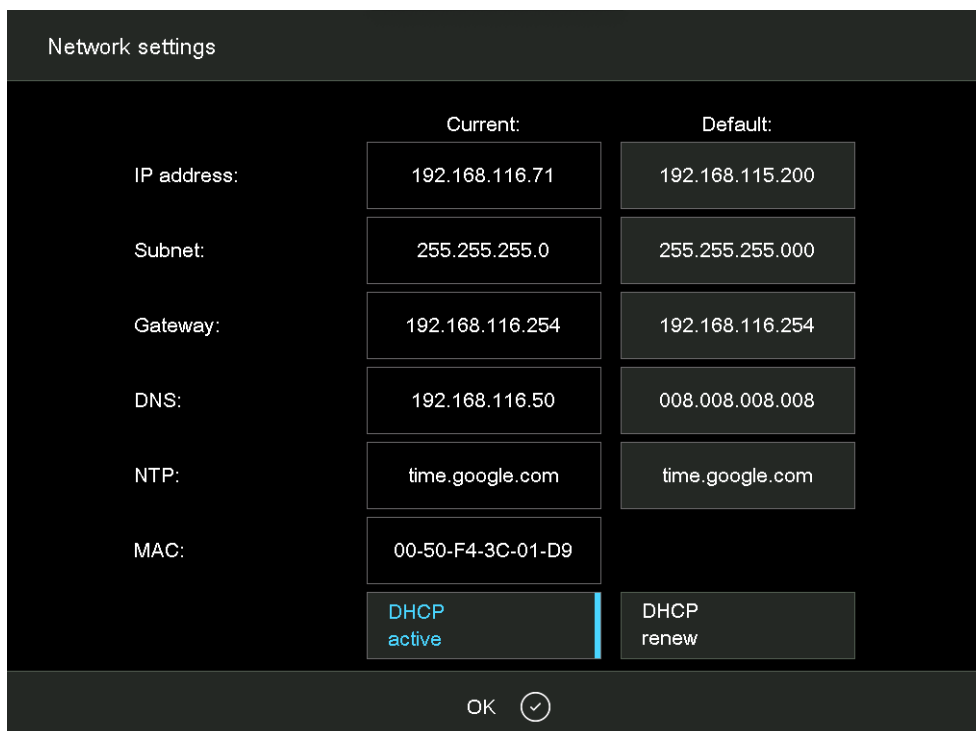

Fig. 4-3 Setup > Network

4. Tap the button [DHCP active]. Use the button to assign an IP address to the firing furnace from you network server. A highlighted button indicates that the DHCP function is active.
5. Tap on [OK]. The message and "Network settings" window close.
6. Turn the furnace off and on. The control accepts the changed network settings, and the firing furnace automatically searches an IP address in the Ethernet network.
7. After restarting, open the "Network settings" menu.
8. Write down the current IP address.

## 4.5.2. Setting up the operation of the firing furnace using a VNC program

### NOTE:

To use the firing furnace via a VNC, a suitable VNC program needs to be installed on the computer.

1. Open a VNC program on a computer network (such as RealVNC or UltraVNC).

### Creating a new connection (example VNC)

2. Select the menu item "File" > "New connection...".

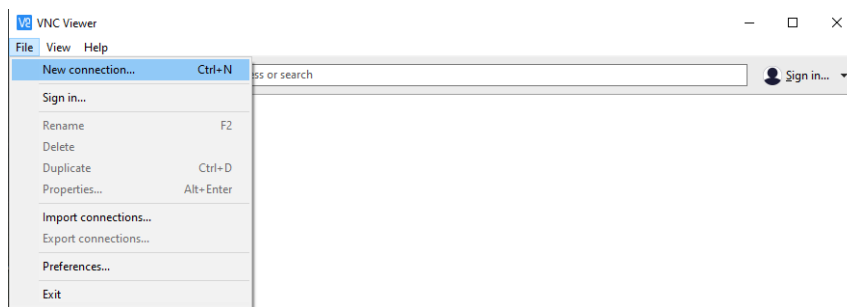

Fig. 4-4 VNC: New connection (example)

3. The "Properties" window appears.
  - a. Enter the noted IP address in the "VNC Server" entry line ("192.168.115.220" in the following example).
  - b. Enter a name for the firing furnace in the "Name" entry line ("AUSTROMAT" in the following example).
  - c. Click on [OK].

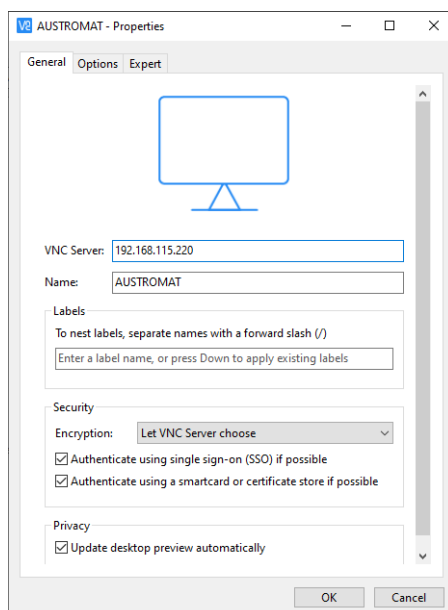

Fig. 4-5 VNC: Entering IP address and name (example)

### Opening an existing connection (example VNC)

1. Double click on the icon of the existing connection.

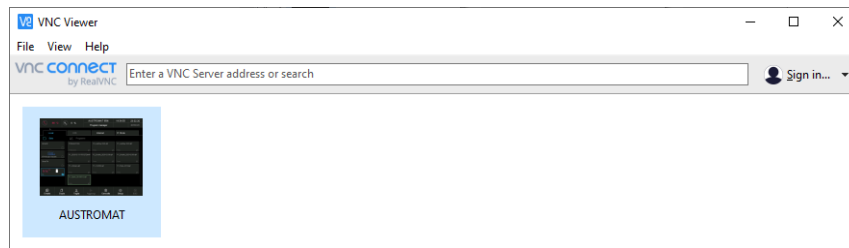

Fig. 4-6 VNC: Opening an existing connection (example)

2. The "Authentication" window appears.
  - a. Enter the password in the "Password" entry line. The standard password is "DEKEMA".
  - b. Click on [OK].

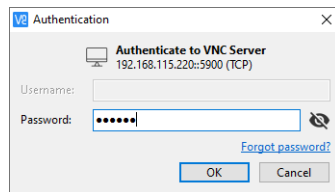

Fig. 4-7 VNC: Kennwort eingeben (Beispiel)

3. The Program Manager appears in the VNC window. See section 5.3.

Set up a permanent IP address for the firing furnace. See section 4.5.4.

### 4.5.3. Setting up the operation of the firing furnace using a browser

**NOTE:**

To operate the firing furnace using the web interface, your browser must be Java-capable, and the Java application must be activated.

**NOTE:**

Most modern browsers do not allow to run Java applications due to security reasons. Therefore, we recommend to set up the operation of the firing furnace via a VNC software. See chapter 4.5.2.

1. Open a Java-capable browser on a computer network (such as Internet Explorer or Mozilla Firefox).
2. In the address line of the browser, enter the recorded IP address ( "http://192.168.115.156" in the following example), and press the Enter key.

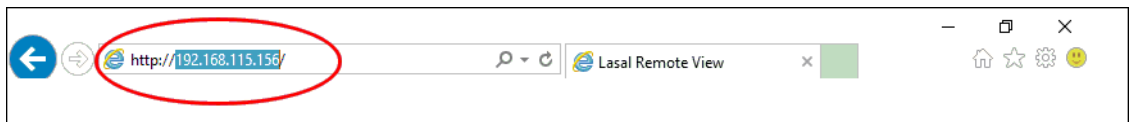

Fig. 4-8 Enter the IP address in the browser (example)

3. The login window appears.
  - a. Enter the password in the "Password" entry line.
  - b. Select the desired data compression for transmitting data between the firing furnace and the computer. We recommend using the default setting, "RL encoding".
  - c. Click on [OK].

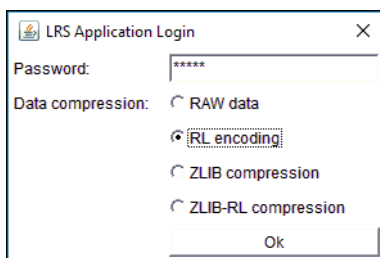

Fig. 4-9 Login window

4. The Program Manager appears in the browser. See section 5.3.

Set up a permanent IP address for the firing furnace. See section 4.5.4.

**Recommendation: Define bookmarks in the browser**

You can define a bookmark in the browser for easily opening the firing furnace control: In the browser, enter the permanent IP address, and start the Java application. Wait until the Program Manager is displayed. Define the bookmark.

#### 4.5.4. Setting up a permanent IP address for the firing furnace

You can now operate the firing furnace using the VNC program. Depending on the network settings, a different IP address can be used each time the unit is started. So that you do not have to repeatedly find and enter the IP address, the firing furnace should be assigned a fixed IP address in the network.

1. Contact your network administrator, and have him assign an IP address and subnet mask and gateway address for the firing furnace.
2. In the "Setup" menu, open the "Network" function (> Setup > Network).

	Current:	Default:
IP address:	192.168.116.71	192.168.115.200
Subnet:	255.255.255.0	255.255.255.000
Gateway:	192.168.116.254	192.168.116.254
DNS:	192.168.116.50	008.008.008.008
NTP:	time.google.com	time.google.com
MAC:	00-50-F4-3C-01-D9	
	DHCP active	DHCP renew

OK

Fig. 4-10 Assign permanent IP address

3. Under "Default IP address", enter the IP address that was assigned to the firing furnace by the network administrator.
4. Under "Default Subnet mask", enter the subnet mask that was assigned to the firing furnace by the network administrator.
5. Under "Gateway", enter the gateway address that was assigned to the firing furnace by the network administrator.
6. Deactivate the DHCP function.
7. Tap on [OK].

The firing furnace now has a fixed IP address and can be accessed using a browser or the VNC program at this address.

**NOTE:**

**The new IP address is only activated after the firing furnace is restarted.**

Now set up the authorizations for accessing the firing furnace. See section 4.5.5.

### 4.5.5. Specify authorizations

After connecting the firing furnace to a network or individual computer, each network participant or computer user can access the firing furnace control. You can restrict the access to the firing furnace to authorized persons by providing a password (the user name is always fixed).

1. In the "Setup" menu, open the "Login data" function. See section 5.7.3.4.
2. Define the password: In the "Password" field, enter the password,
3. Activate the functions "Start/stop functionality" and "Function keys via the Web server".

When opening the firing furnace control through a browser or VNC program, the password has to be entered to obtain access to the firing furnace, i.e., the firing furnace is password-protected. Communicate the password to the persons who are authorized to access the firing furnace.

**NOTE:**

**If the password becomes lost, contact your service partner or directly contact DEKEMA (see page 2).**

## 4.6. Connect the firing furnace to an individual PC

**NOTE:**

**Consult your network administrator if you are uncertain.**

1. Make sure that the firing furnace is connected to a computer with a network cable (interface on the back of the device). Note that older computers may require a crossover network cable.
2. In the plant, the firing furnace was assigned to DHCP by DEKEMA. You have to identify the present IP address of the firing furnace: See section 4.5.1.
3. If necessary, enter the correct IP address for your computer.

You can operate the firing furnace using either the VNC program or a browser.

### 4.6.1. Operating the firing furnace using a VNC program

1. Section 4.5.2 describes the procedure to set up the operation of the firing furnace via a VNC program.
2. Now set up the authorizations for accessing the firing furnace. See section 4.5.5.

### 4.6.2. Setting up the operation of the firing furnace using a browser

**NOTE:**

**To operate the firing furnace using the web interface, your browser must be Java-capable, and the Java application must be activated.**

**NOTE:**

**Most modern browsers do not allow to run Java applications due to security reasons. Therefore, we recommend to set up the operation of the firing furnace via a VNC software. See chapter 4.5.2.**

1. Section 4.5.3 describes the procedure to set up the operation of the firing furnace via a browser. You may have to release this IP address in the firewall of the computer (see the operating instructions of the operating system).
2. In the "Setup" menu, open the "Login data" function (> Setup > Network > Login data). See section 5.7.3.4.
3. Activate the functions "Start/stop functionality" and "Function keys via the Web server". See also section 5.7.3.4.

**Recommendation: Define bookmarks in the browser**

You can define a bookmark in the browser for easily opening the firing furnace control: In the browser, enter the permanent IP address, and start the Java application. Wait until the Program Manager is displayed. Define the bookmark.

4. Now set up the authorizations for accessing the firing furnace by the browser. See section 4.5.5.



## 5. User interface

### 5.1. Basic information

#### 5.1.1. Terms



The following table explains some of the basic terms that will make it easier to operate the AUSTROMAT™.

<b>Term</b>	<b>Explanation</b>
Program, Firing program	Firing programs or other programs contain the individual control commands for the AUSTROMAT™. A typical example of a program is the preheating program that is the first program memory for most firing furnaces.
Program parameter Firing parameters	The individual values within a program are termed the program parameters or firing parameters. Program parameters are for example the starting temperature, drying time, and closing time.
Set	Compilation of all programs (program list) in the Program Manager.

Tab. 5-1 Definition of terms

### 5.1.2. Screen elements

The following table contains screen elements that are used in the user interface of the AUSTROMAT™.

Name	Example	Description
Button		A button is associated with a function. Run the function by tapping the button.
On/off button		An on/off button is associated with a function. A bar and the color show the status of the function: <ul style="list-style-type: none"> <li>• Colored: The function is active</li> <li>• White: The function is deactivated.</li> </ul>
Drop-down list		Select the desired list entry as follows: <ul style="list-style-type: none"> <li>• Tap the entry to open the complete selection list,</li> <li>• Tap on the desired entry. The list closes, and the selected list entry is displayed.</li> </ul>
Numeric keyboard window		(see section 5.1.3).
Alphanumeric keyboard window		(see section 5.1.4).
Keyboard window for the classic editor		(see section 5.1.5).

Tab. 5-2 Screen elements

### 5.1.3. Numeric screen keyboard

The numeric screen keyboard is for entering text such as the firing parameters. The keyboard automatically appears when the firing furnace control expects a number to be entered.

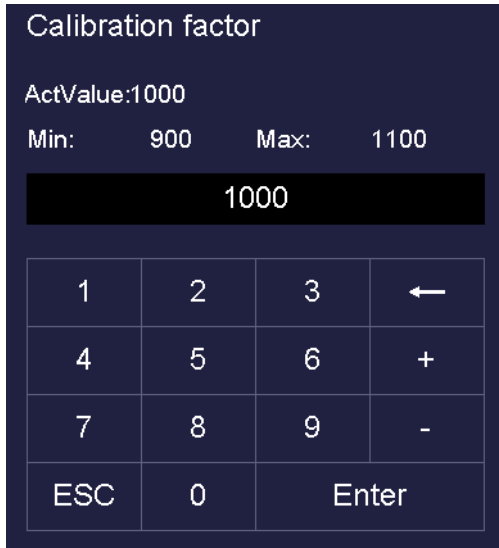

Fig. 5-1 Numeric keyboard window (example)

#### Valid values

When entering parameters, the following values are automatically displayed in the numeric keyboard:

- "ActValue" shows the currently set value,
- "Min" shows the smallest permissible value (minimum),
- "Max" shows the highest permissible value (maximum),

#### Entering the value

- Enter the desired value.
- Tap [Enter] to close your entry.
- The value is accepted when it lies within the valid range,
- The numeric keyboard window is closed.

#### Terminating an entry

- Tap [ESC] to terminate the entry,
- An entered value is not accepted, the current value ("ActValue") is retained,
- The numeric keyboard window is closed.

### 5.1.4. Alphanumeric keyboard window

The alphanumeric screen keyboard is for entering text such as the names of firing programs. The keyboard automatically appears when the firing window control expects text to be entered.

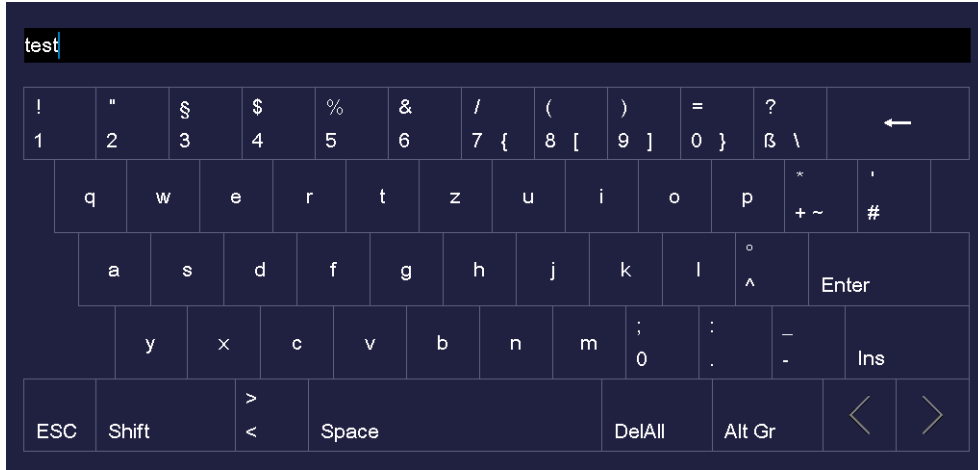

Fig. 5-2 Alphanumeric keyboard window

#### Entering text

- Enter the desired text. Use [Shift] to toggle between upper and lower case input,
- Tap [Enter] to close your entry,
- The alphanumeric keyboard window is closed.

#### Terminating an entry

- Tap [ESC] to terminate the entry,
- An entered text is not accepted
- The alphanumeric keyboard window is closed.

### 5.1.5. Keyboard window for the classic editor

The keyboard window for the classic editor automatically appears when you tap a command line or the graphic display of a classic program in the program editor.

Temperature [C]	1	2	3
Vacuum [V]	4	5	6
Time/Signal [T]	7	8	9
Lift [L]	0	.	DelAll
Autodry [A]	←		
Skip program [/]	<	>	

Fig. 5-3 Keyboard window for the classic editor

#### Editing the command line

- Tap [Edit] to edit the command line. The text appears in blue frame,
- Use the cursor keys to edit the command line at the desired place, or tap the desired position on the graphic display of the program sequence,
- Tap [Enter] to close your entry,
- The classic keyboard window is closed.

#### Terminating an entry

- Tap [ESC] to terminate the entry,
- An entered command line is not accepted,
- The classic keyboard window is closed.

## 5.2. Screen display

The screen display for operating the AUSTROMAT™ is divided into different areas.

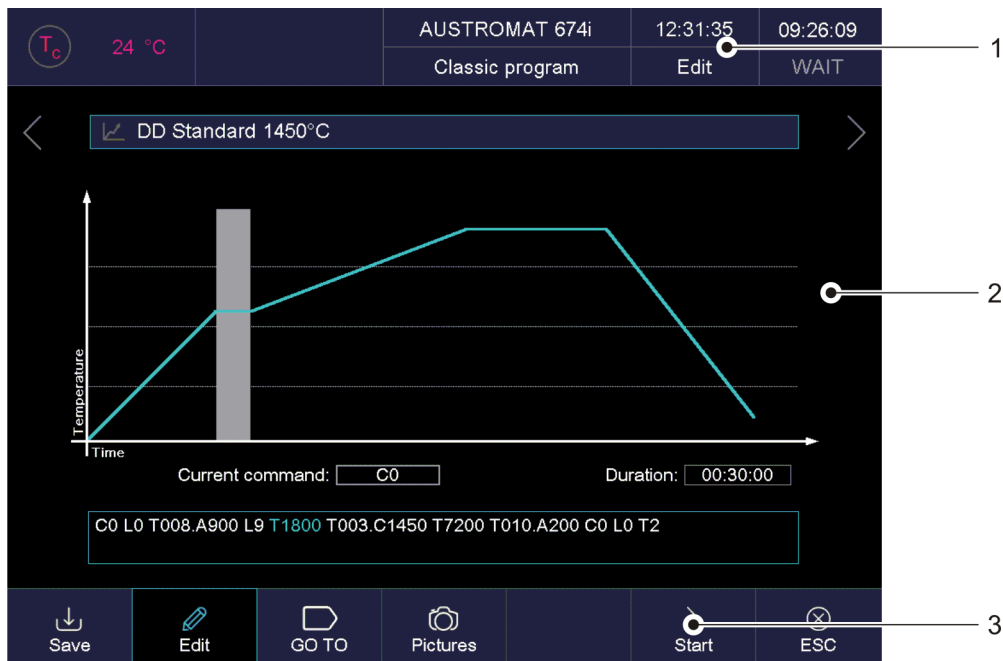

Fig. 5-4 Screen display (example of the Program Manager)

- 1 Information bar
- 2 Function bar
- 3 Display area

### Information bar

Shows all of the important parameters:

- The Temperature in the firing chamber: "Tc",
- The furnace model, or the firing number "#", that is, how many firings have been properly concluded. Tap the button to toggle between the displays,
- The time of the firing furnace control,
- The date of the firing furnace control, or if a program has been selected, the probable remaining time or completion of the program. Tap the button to toggle between the displays,
- The current menu (in this case, the "Program Manager"). A lock indicates that a program is protected by the general code,
- The status of the firing furnace:  
 "Wait": The firing furnace is in wait mode,  
 "Run": A program is being processed (program is running),  
 "Edit": A program is being edited (program editor).

### Display area

The display area shows the current menu of the firing furnace control such as the Program Manager.

### Function bar

The function bar contains the buttons for controlling and operating the firing furnace. The names of the buttons depend on the selected menu.

## 5.3. Program Manager

Use the Program Manager menu to manage the firing programs or sets (such as copy or delete firing programs), and to navigate between programs.

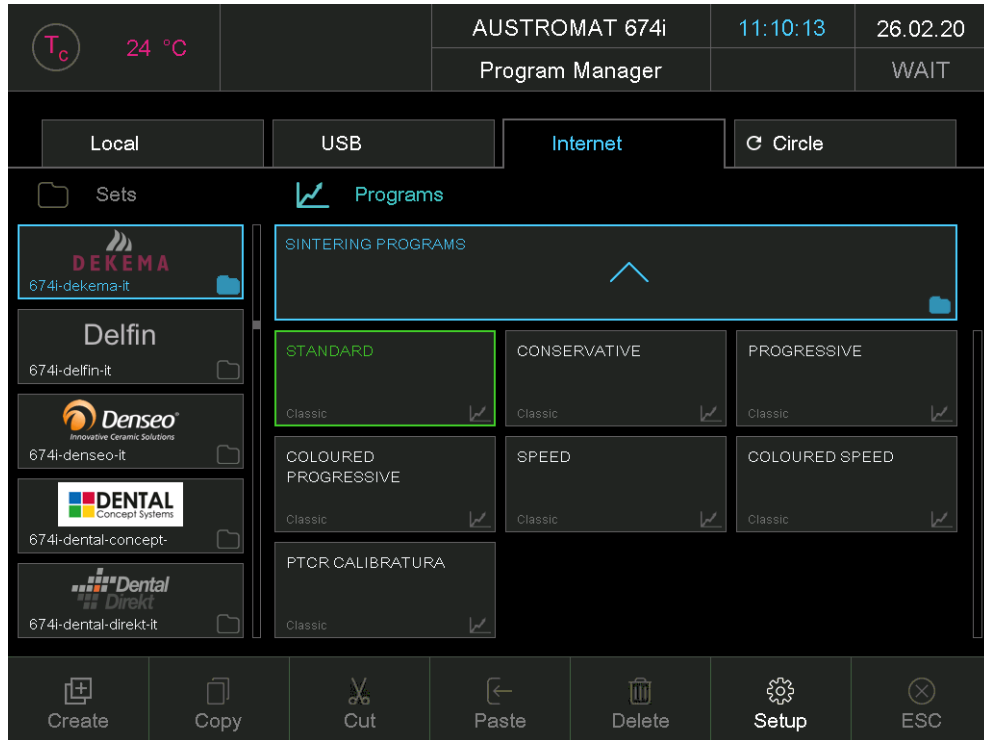

Fig. 5-5 Program Manager (example)

### Display area

The display area of the Program Manager includes the following elements:

- Storage medium of the programs and sets:
  - "Local" displays the programs and sets that are saved in the firing furnace control,
  - "USB" displays the programs and sets that are saved in the memory stick. Only active when a memory stick is inserted in the interface of the firing furnace,
  - "Internet" allows you to use the programs and sets that are available on the DEKEMA server. Only active when the firing furnace is connected with the Internet,
  - "Circle" displays the programs and sets in the Circle of all DEKEMA devices. See section 5.7.3.6. When the firing furnace is not connected with the circle the "Circle Login" window appears. See Fig. 5-36.
  - "FTP Server" displays the programs and sets that are saved on an FTP server. Only active when the firing furnace is connected with an FTP server. See section 5.7.3.7,
- The set list "Sets" shows all of the sets in the selected storage medium. The folder icon in the button indicates a set,
- The program list "Programs" shows all of the firing programs in the loaded set. The program icon in the button indicates a firing program. The program list may contain folders for a more clear arrangement of programs,
- The most recently opened program is displayed with a green frame in order to make easier the navigation, and the orientation within the program sequence.
- Scroll bar. This allows you to scroll through the table (swipe function).

### Select program

1. Tap on the desired storage medium.
2. Scroll through the set list until the desired set is displayed. Tap on a set to select it. The corresponding button is highlighted, and the related firing programs appear in the program list.
3. Scroll through the program list until the desired program is displayed. Tap on a program to select it. The program display appears. See section 5.4.

### Mark program

Tap on a firing program for about two seconds. The program will be marked but not opened, the corresponding button is highlighted.

Marking multiple programs is possible.

### Function bar

The buttons in the function bar refer to the selected element "Sets" or "Programs".

#### NOTE:

**Programs that are protected by the general code cannot be deleted or overwritten (see also the section 5.7.1.6).**

The buttons in the right function bar refer to individual firing programs.

[Create]

#### Creating a new set:

- Tap on "Sets".
- Tap on [Create].
- The window "Save as" opens.
- Enter the name for the new set and tap on [Save].

**Creating a new firing program:** See section 5.6.4.

#### Creating a new folder:

- Tap on "Programs".
- Tap on [Create].
- The "Program Selection" window opens. See Fig. 5-6.
- Tap on "Folder".
- Tap on [ICON] when you want to assign an icon to the folder. The "Folder picture selection" window opens. Select the desired icon.
- Tap on the folder name. The alphanumerical keyboard window opens. Enter the folder name. Note that the input must not exceed 40 characters.
- Tap [OK] in the "Program Selection" window in order to save the changes.

[Copy]

Copies the selected element. Procedure:

- Mark the desired element (source).
- Tap on [Copy].
- Navigate to the target and tap on the area where the element should be copied. A blue bar indicates the paste position.
- Tap on [Paste].



[Cut]	Moves the selected element. Procedure: <ul style="list-style-type: none"><li>• Mark the desired element (source).</li><li>• Tap on [Cut].</li><li>• Navigate to the target and tap on the area where the element should be moved. A blue bar indicates the paste position.</li><li>• Tap on [Paste].</li></ul>
[Paste]	Inserts an element. This function is only relevant along with the commands [Copy] or [Cut].
[Delete]	Deletes the selected element. Procedure: <ul style="list-style-type: none"><li>• Mark the desired element.</li><li>• Tap on [Delete].</li><li>• A confirmation message is displayed. Tap [OK] if you want to delete the program.</li></ul>
[Setup]	Opens the "Setup" menu (see section 5.7).
[ESC]	No function in the Program Manager.

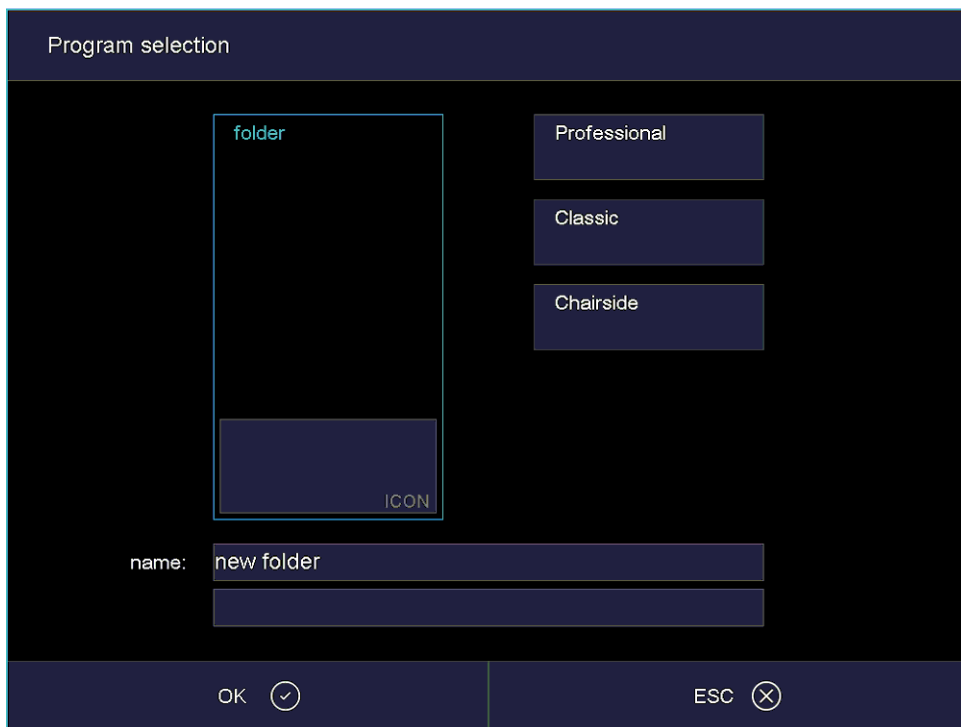

Fig. 5-6 Window "Program selection": Folder

## 5.4. Program display

**NOTE:**

The available program types depend on the customer specific model of your firing furnace.

The program display with the firing parameters appears when you select a program in the Program Manager. The display depends on the type of program that has been selected:

- Program display for professional programs. See section 5.4.1,
- Program display for classic programs. See section 5.4.2,
- Program display for chairside programs. See section 5.4.3.

### 5.4.1. Professional programs

The following illustration shows a typical program display for professional programs.

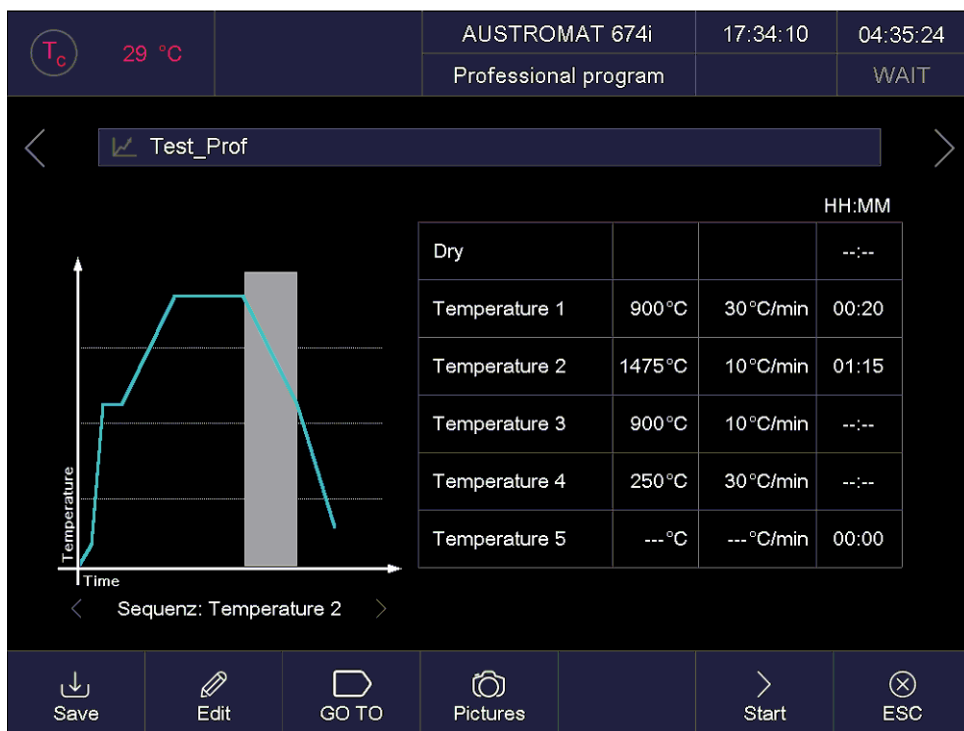

Fig. 5-7 Program display for professional programs (example)

The display is divided into four parts: The information line, the graphic display of the program progress, the command line with the firing parameters, and the function bar.

Information line                      Displays the program name.

[<]                                      Use the two arrow keys next to the information line for scrolling to the next and previous program, respectively. Or swipe the touchscreen rightward and leftward.

[>]

Graphic representation	<p>The graphic display shows the progress of the program run and contains the following elements:</p> <ul style="list-style-type: none"> <li>• The vertical axis shows the temperature.</li> <li>• The horizontal axis shows the time.</li> <li>• The cursor shows the current position (time) in the program run.</li> <li>• The diagram shows the progress of the program as a colored curve. The temperature and pressure over time is shown at the fired object.</li> </ul>
[<] [>]	<p>The two sequence buttons below the graphic move the cursor through the individual program steps. The intervals have a colored background in the graphic.</p>
Entry mask with firing parameters	<p>The table contains the entry fields for the respective program steps with the firing parameters:</p> <ul style="list-style-type: none"> <li>• Each line corresponds to a program step. The program steps are executed sequentially from top to bottom.</li> <li>• The first column contains the name of the program step.</li> <li>• The second column indicates the temperature at which the program step is executed.</li> <li>• The third column indicates the heating rate at which the temperature in column 2 is activated and the vacuum for firing.</li> <li>• The fourth column indicates the holding period for the program step.</li> </ul> <p>An empty entry cell in column 2,3,4 means that the respective value is automatically specified by the program step or is not required.</p>

Buttons in the function bar:

- [Save] Saves the program.
- [Edit] Opens the program editor to change the firing parameters. See section 5.6.
- [GO TO] Opens the "GO TO selection" window. See Fig. 5-8. You can select another program within the set.
- [Pictures] Opens a window for selecting a picture. See section 5.4.4.
- [Start] Starts the program. See also section 5.5. The [Start] button is automatically replaced by the [Stop] button after the program starts.
- [Stop] Prematurely stops a running program. The [Stop] button is then automatically replaced by the [Start] button. After a program is stopped, the heating system turns off, and the firing furnace cools down. The firing is counted, i.e. the firing number is increased, when the program has run longer than 30 s.
- [ESC] Terminates the program display and opens the Program Manager. 5.3.

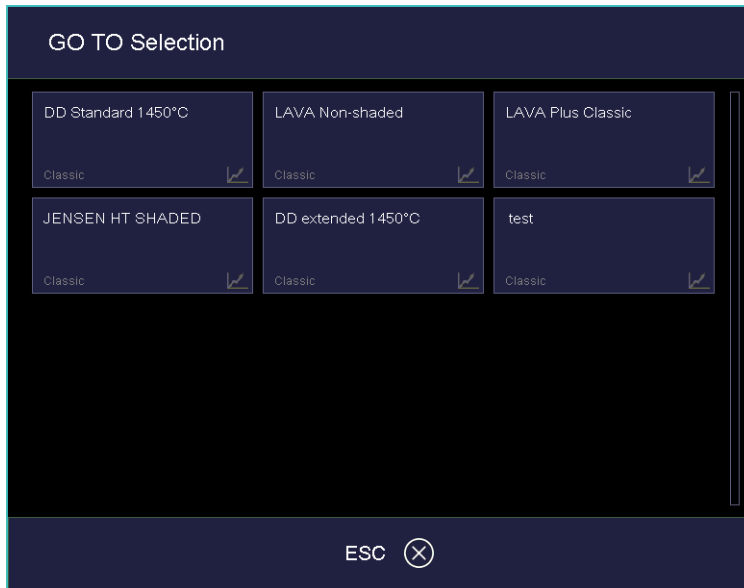

Fig. 5-8 "GOTO Selection" window (example)

## 5.4.2. Classic programs

The following illustration shows a typical program display for classic programs.

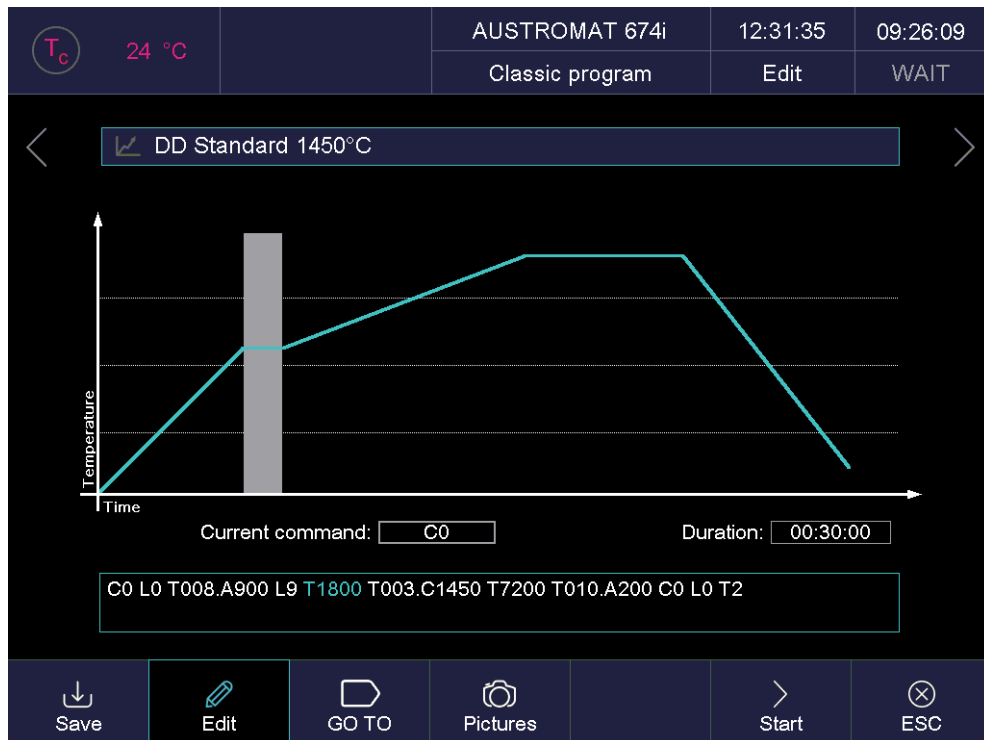

Fig. 5-9 Program display for classic programs (example)

The display is divided into four parts: The information line, the graphic display of the program progress, the command line with the firing parameters, and the function bar.

Information line      Displays the program name.

[<]  
[>]      Use the two arrow keys next to the information line for scrolling to the next and previous program, respectively, or swipe the touchscreen rightward and leftward.

Graphic Representation      The graphic display shows the progress of the program and contains the following elements:

- The vertical axis shows the temperature.
- The horizontal axis shows the time.
- The cursor shows the current position (time) in the program.
- The diagram shows the progress of the program as a colored curve. The temperature over time at the fired object is displayed.

Tap on the graphic in order to select individual program steps. The firing parameters are displayed and edited in the command line.

Double tapping on the graphic representation opens the program editor to change the firing parameters. See section 5.6.

---

Command line	Shows the individual program steps with the firing program in "CVTL" syntax. Tap on the command line to open the program editor to change the firing parameters. See section 5.6.2.
Buttons in the function bar	
• [Save]	Saves the program.
• [Edit]	Opens the program editor to change the firing parameters. See section 5.6.
• [GO TO]	Opens the "GO TO selection" window so that you can select another program within the set. See Fig. 5-8
• [Pictures]	Opens a window for selecting a picture. See section 5.4.4.
• [Start]	Starts the program. See section 5.5. The [Start] button is automatically replaced by the [Stop] button after the program starts.
• [Stop]	Prematurely stops a running program. The [Stop] button is then automatically replaced by the [Start] button. After a program is stopped, the heating system turns off, and the firing furnace cools down. The firing number is increased when the firing program has been running longer than 30 s.
• [ESC]	Terminates the program display and opens the Program Manager. See section 5.3.

### 5.4.3. Chairside programs

The following illustration shows a typical program display for chairside programs.

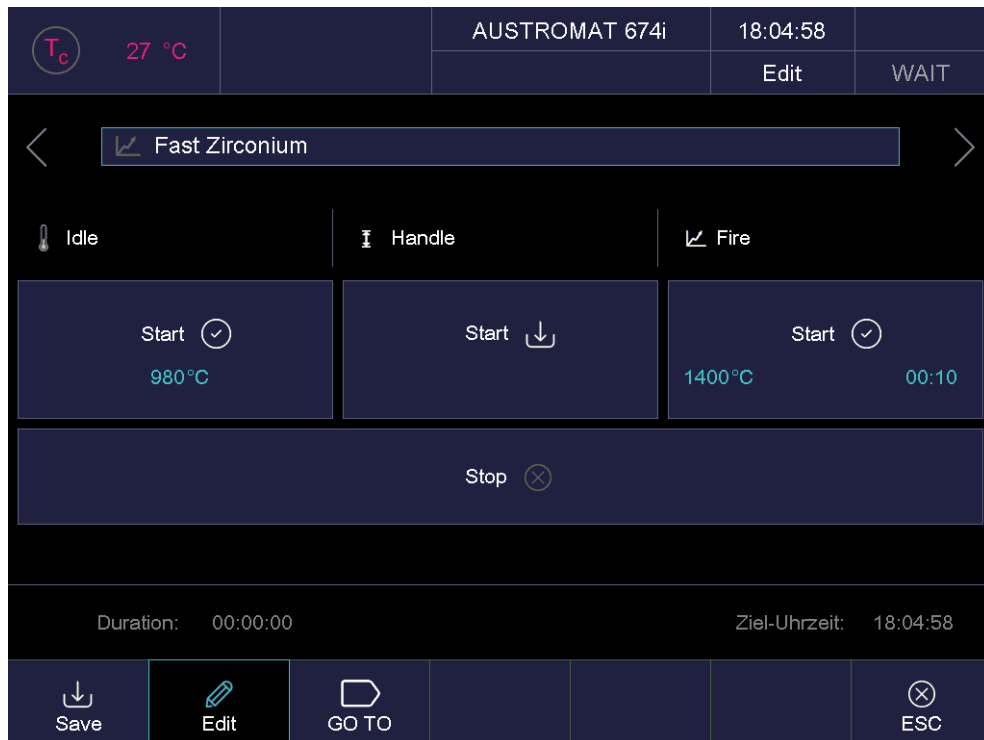

Fig. 5-10 Program display for chairside programs (example)

The display is divided into three parts: The information line, the display of the program run with the firing parameters, and the function bar.

Information line	Displays the program name.
[<] [>]	Use the two arrow keys next to the information line for scrolling to the next and previous program, respectively, or swipe the touchscreen rightward and leftward.
Program representation	The representation shows the three sections of the program run: <ul style="list-style-type: none"> <li>• Idle. The firing furnace is prepared for the sintering process.</li> <li>• Handle. The firing object can be placed on the insulation table.</li> <li>• Fire. Starts the firing program using the set firing parameters.</li> </ul>
• [Start]	Starts the corresponding program section.
• [Stop]	Prematurely stops a running program. After a program is stopped, the heating system turns off, and the firing furnace cools down. The firing number is increased when the firing program has been running longer than 30 s.

Program duration	The expected duration and end time of the program is displayed below the program run sections.
Buttons in the function bar:	
• [Save]	Saves the program.
• [Edit]	Opens the program editor to change the firing parameters. See section 5.6.
• [GO TO]	Opens the "GO TO selection" window so that you can select another program within the set. See Fig. 5-8
• [ESC]	Terminates the program display and opens the Program Manager. See section 5.3.

#### 5.4.4. Pictures

**NOTE:**

**The screen of your AUSTROMAT™ firing furnace is not color calibrated. It is therefore not suitable for accepting color.**

You can save files in the memory of the firing furnace electronics:

- Photographs, for example to compare your firing results with pictures of sample firings,
- PDF files, for example to have at any time access to these operating instructions.

The screen page offers a simplified functionality for selecting and opening a file as in Windows Explorer. To overwrite the files, you can use the FTP functionality (see section 5.7.3.7) or a USB stick.



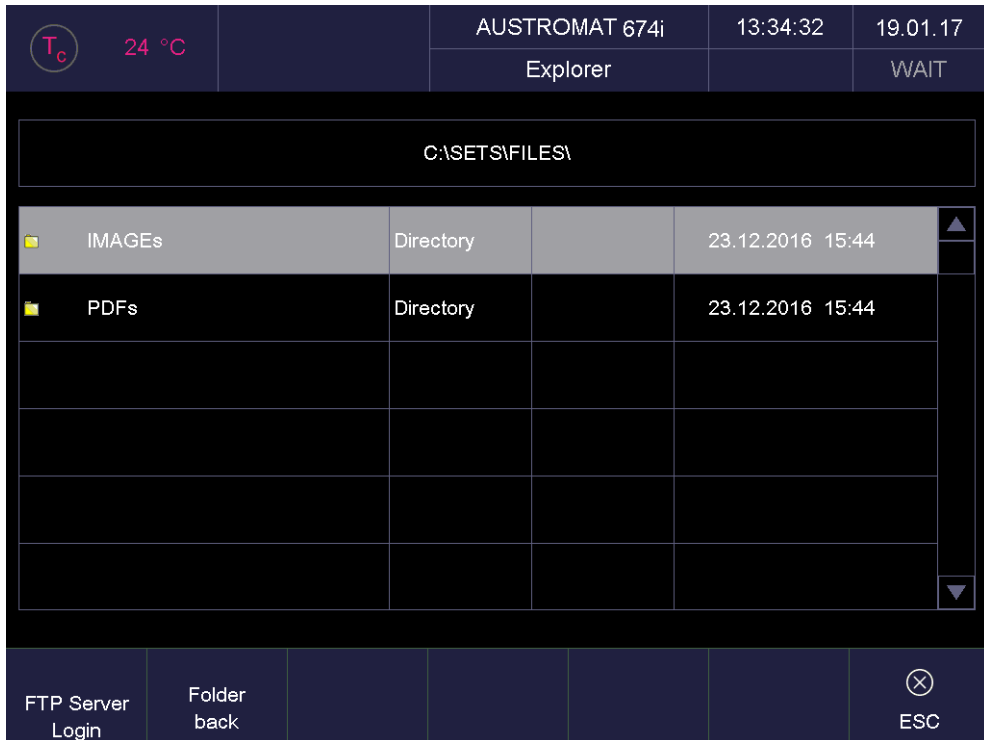

Fig. 5-11 Program Manager > Pictures (example)

The Screen is divided into tables that list all the files and folders in the selected directory, and the function bar.

**Table** The table provides the following information:

- Title line: Name of the current directory,
- First column: Name of files and folders,
- Second column: File extension or directory,
- Third column: File size,
- Fourth column: Date and time of the file.

**Open file** Double-tap the line of the desired file.

**Buttons in the function bar:**

- [FTP Server Login] Open the "FTP Server Login" to access an externally-linked FTP server. See section 5.7.3.7.
- [Folder back] Moves one level up in the directory structure.
- [ESC] Ends picture selection and switches to the normal program display. See section 5.4.2.

## 5.5. Program sequence

**NOTE:**

The available program types depend on the customer specific model of the firing furnace.

A firing program is started from the Program Display by pressing [Start]. Please note:

- The program steps are executed in the specified sequence in the input mask (see section 5.4),
- Select [Stop] to prematurely terminate a running program. In this case, all the commands are stopped and the heat system is turned off. The firing furnace cools down. The firing number is increased when the firing program has been running longer than 30 s.
- The QM information (if activated) will be displayed after the program run. See section 5.7.3.2.

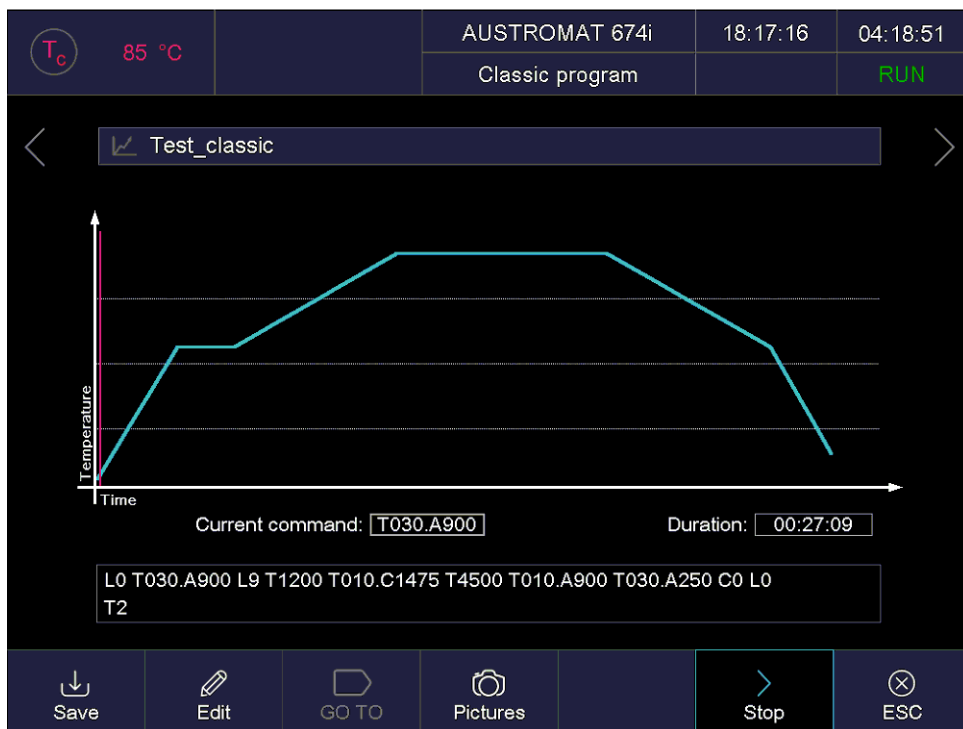

Fig. 5-12 Example of the sequence of a classic firing program

The example of Fig. 5-12 generates the following firing run:

Step 0: [Start]	"L0": The program starts when the firing chamber is open, i.e. the lift moves down if necessary.  The firing program is normally processed after the correct temperature has been reached for starting the selected program. Otherwise the Tc display flashes, and a message is displayed indicating that the firing furnace is too hot or the firing furnace is still heating.
Step 1	"T030.A900": Set the object temperature (900 °C) with a rise of 30 °C/min. The lift travels partially upward while the firing chamber is being heated.
Step 2	"L9": Close (the lift moves upward).
Step 3	"T1200": Wait time 1200 s.
Step 4	"T010.C1475": Set firing temperature (1475 °C) with a rate of 10 °C/min (900 °C to 1475 °C)
Step 5	"T4500": Wait time 4500 s.
Step 6	"T010.A900": Set object temperature (900 °C) with a rate of 10 °C/min (1475°C to 900 °C). The lift travels downward somewhat while the firing chamber is being heated.
Step 7	"T030.A250": Set object temperature (250 °C) with a rate of 10 °C/min (900 °C to 275 °C). The lift travels downward somewhat while the firing chamber is being heated.
Step 8	"C0": Turning off the heater.
Step 9	"L0": The lift moves down all the way.
Step 10	"T2": The acoustic signal for the end of the program sounds. The firing number is automatically increased by one.

### 5.5.1. Professional programs

Specifically, the program steps execute the following functions:

Program step	Definition
Drying	The firing object is dried for the specified holding time.  In the "Drying" program step, the lift is automatically moved to the correct position. This position depends greatly on the temperature of the firing chamber. The lift may therefore move up and down several times in small steps.
Temperature 1	The closed firing chamber is heated up to temperature 1 from preheating temperature at the specified heat-up rate 1. When temperature 1 is reached, the firing object is subjected to temperature 1 for the specified holding time.
Temperature 2	Starting from temperature 1, temperature 2 is activated at the specified heat-up rate 2 and held for holding time 2. The firing chamber may be open (e.g. cooling).
Temperature 3 ... Temperature 5	Starting from temperature 2, temperature 3 is activated at the specified heat-up rate 3 and held for holding time 3. The firing chamber may be open (e.g. cooling).  Temperatures 4 and 5 will be processed likewise.

Tab. 5-3 *Meaning of the program steps for professional programs*

### 5.5.2. Classic programs

The individual program steps are displayed in the "CVTL" syntax and processed from left to right in the given sequence.

You can find a description of the "CVTL" syntax in section 5.6.2.

### 5.5.3. Chairside programs

Chairside programs are designed for quick sintering processes, and are not run automatically, i.e. the individual program sections have to be started manually. Die Programmschritte bewirken im einzelnen folgendes:

Program step	Definition
Idle	The firing chamber is closed, the firing furnace heats up to the set temperature. The firing chamber is kept closed.
Handle	The heating is switched off, the firing chamber drives fully open. The firing object can be placed on the insulation table. The heating remains off, and the firing chamber open.  Sintering should be started in "Fire" as soon as possible.
Fire	Closes the firing chamber and starts sintering with maximum heating rate for the set time. Afterwards, the acoustic signal for the end of the program sounds. The firing number is automatically increased by one. The firing chamber keeps closed, and the heating switches off. The firing furnace cools down to the "Idle" temperature.

Tab. 5-4 Bedeutung der Programmschritte für Chairside-Programme

## 5.6. Program editor

**NOTE:**

The available program types depend on the customer specific model of the firing furnace.

**NOTE:**

Programs that are protected by the general code cannot be edited. See also the section 5.7.1.6.

You can download programs for any program type from the data base area of the DEKEMA website (requires registration).

With the program editor, you can change existing programs or create new firing programs. Furthermore, it is possible to edit a firing program in progress.

When editing a firing program, note the following:

- The keyboard windows are described in sections 5.1.3, 5.1.4 and 5.1.5,
- An entered value must be confirmed by pressing [Enter]. Otherwise, the entry or changed value has no effect,
- Incorrect values cannot be entered. The original value is retained. The permissible value range is displayed in the keyboard window.

**Editing while the program is running**

You can edit parameters while a firing program is in progress. However, you can only edit the values of the program steps that have not yet been processed.

### 5.6.1. Editing professional programs

Professional programs are characterized by:

- fast and easy programming,
- specified firing with an entry mask that provides the basic program steps,
- all individual firing parameters can be changed. The corresponding entry fields are displayed in the program display in color.

**Opening the program editor**

- In the Program Manager, select the desired firing program. The program display appears. See section 5.4.
- Tap on [Edit]. A highlighted button indicates that the program editor is active. The editable parameters are displayed in color. In addition, the "Edit" status is displayed in the information bar.
- Click on a parameter field to edit it. The corresponding keyboard window is automatically opened.

### Closing the program editor

- Tap on [Save] to save the changes.
- Tap on [Edit]. The button goes white to indicate that the program editor is inactive. In addition, the "Edit" status in the information bar disappears.

The following table gives an overview of the permissible values for the individual program steps. The buttons in the function bar correspond to the program display. See section 5.4.1.

Program step	Temperature in °C	Temperature rise in °C/min	Holding time in hrs:min
Drying			00:00...2:30
Temperature 1	100...1560	0...MAX <sup>1)</sup>	00:00...2:30
...			
Temperature 5			

Tab. 5-5 Permissible value range of the program steps for professional programs

1) maximum rise for input 0 °C/min

For programming examples, go to the download area of the DEKEMA website <https://www.dekema.com/service-login/>

## 5.6.2. Editing classic programs

Classic programs are characterized by:

- variable and flexible programming,
- unrestricted firing control,
- all individual firing parameters can be changed as desired.

### Opening the program editor

- In the Program Manager, select the desired firing program. The program display appears. See section 5.4.2.
- Tap on [Edit]. A highlighted button indicates that the program editor is active. In addition, the "Edit" status is displayed in the information bar.
- Tap on the command line below the program display to edit it. The keyboard window for the Classic editor appears.

The command line shows the commands in the sequence in which they are processed. However, you will need a bit of practice as well as an understanding of ceramics and firing techniques to program with the CVTL commands.

### Closing the program editor

- Tap [Save] to save the changes.
- Tap on [Edit]. The button goes white to indicate that the program editor is inactive. In addition, the "Edit" status in the information bar disappears.

### CVTL commands

In particular, the CVTL commands execute the following functions:

- "A" defines the temperature in °C on the insulation table (**A**utodry),
- "C" defines the temperature in °C in the firing chamber (degrees **C**elsius)
- "V" defines the vacuum (**V**acuum). Does not apply to the AUSTROMAT™ 664i™ and 674i™,
- "L" defines the lift position (**L**ift): L0 = Lift all the way down, L9 = Lift all the way up,
- "T" and at least a double-digit number define the time (**T**ime) in seconds.
- "T" and a single-digit number define the number of audible signals,
- "T0xx.Cxxxx" defines a temperature ramp with the temperature gradient, T defines the ramp in °C/min, C defines the end temperature in °C in the firing chamber,
- "T(x)xx.Cxxxx", (x) <> 0 defines a temperature ramp, T defines the time in s, C the end temperature in °C in the firing chamber,
- "T(x)xx.Lx" defines a lift ramp, T defines the time in s, L the lift end position,
- "T0xx.Axxxx" defines a temperature ramp with the temperature gradient, T defines the ramp in °C/min, A defines the end temperature in °C in the insulation table,
- "T(x)xx.Axxxx", (x) <> 0 defines a temperature ramp, T defines the time in s, A the end temperature in °C on the insulation table,
- Two sequential commands are be separated by a space for clarity.

The syntax is checked when you confirm your entry. If the entered command line contains an error, then a warning appears. In this case, correct for the command line.

### Examples

Examples of programming are found in the download area of the DEKEMA website <https://www.dekema.com/service-login/>



### 5.6.3. Editing chairside programs

Chairside programs are designed for quick sintering processes. You can edit only the following firing parameters:

- Temperature "Idle": Idle temperature of the firing furnace,
- Temperature "Fire": Sintering temperature,
- Duration "Fire": Duration of the sintering process.

#### Opening the program editor

- In the Program Manager, select the desired firing program. The program display appears. See section 5.4.2.
- Tap on [Edit]. A highlighted button indicates that the program editor is active. In addition, the "Edit" status is displayed in the information bar.
- Tap on the parameter field in the corresponding program section [Start] button to edit it. The numeric keyboard window appears.

#### Closing the program editor

- Tap [Save] to save the changes.
- Tap on [Edit]. The button goes white to indicate that the program editor is inactive. In addition, the "Edit" status in the information bar disappears.

The following table gives an overview of the permissible values for the individual program steps. The buttons in the function bar correspond to the program display. See section 5.4.3.

Program step	Temperature in °C	Holding time in min:sec
Idle	900...980	
Fire	900...1560	00:00...99:59

Tab. 5-6 Permissible value range of the program steps for chairside programs

#### Examples

Examples of programming are found in the download area of the DEKEMA website <https://www.dekema.com/service-login/>

### 5.6.4. Creating a new program

Follow the procedure below to create a new program:

1. Open the Program Manager. See section 5.3.
2. Tap on the desired storage medium.
3. Tap on the set where you want to save the new program.
4. Tap on "Programs". Now, the program list is active.
5. Tap on [Create]. The "Program selection" window opens.

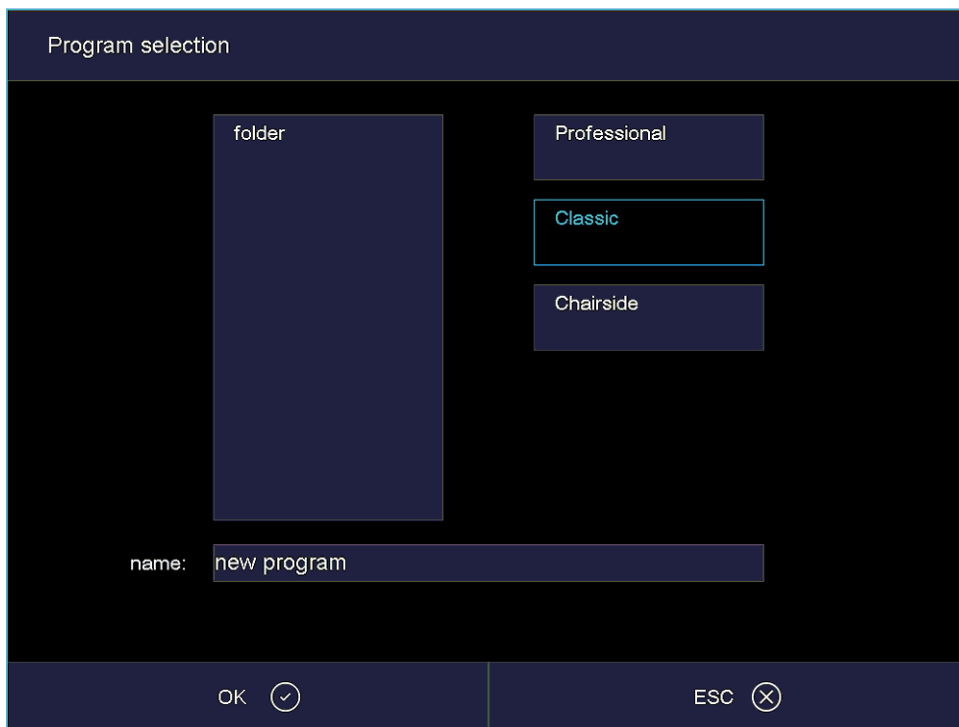

Fig. 5-13 "Program selection" window

- Select the desired program type,
  - Tap on the program name. The alphanumeric keyboard window opens. Enter a program name,
  - Tap on [OK]. The program editor opens.
6. Edit the new program. You can find programming suggestions in section 5.6.5.
  7. Tap on [Save] to save the changes.
  8. Tap on [ESC] to close the program editor. The program manager appears.

It is always possible to subsequently change the program name: In the program editor, tap the field for the program name. The alphanumeric keyboard window opens.

### 5.6.5. Programming Suggestions

You can find non-binding programming suggestions at <https://www.dekema.com/service-login/> . The programs are firing programs converted according to manufacturer's instructions for DEKEMA dental ceramic furnaces of the AUSTROMAT™ series. You can load these programs into your firing furnace. See section 6.8.3.

The parameters such as heating rates, temperatures and hold times indicated by the respective manufacturer are transferred to the programs. These quantities depend on the conditions of use such as the size and material of the firing tray or soft firing cushion, the size and weight of the fired object, or the firing furnace used when the ceramic manufacturer was determining the firing parameters.

## 5.7. Setup menu

The "Setup" menu is used for system control, to change global settings of the firing furnace, to launch maintenance programs, and to record data. The "Setup" menu can be opened by tapping on the [Setup] function key in the Program Manager. It is accessible to laboratory users if not blocked by the supplier for a specific customer.

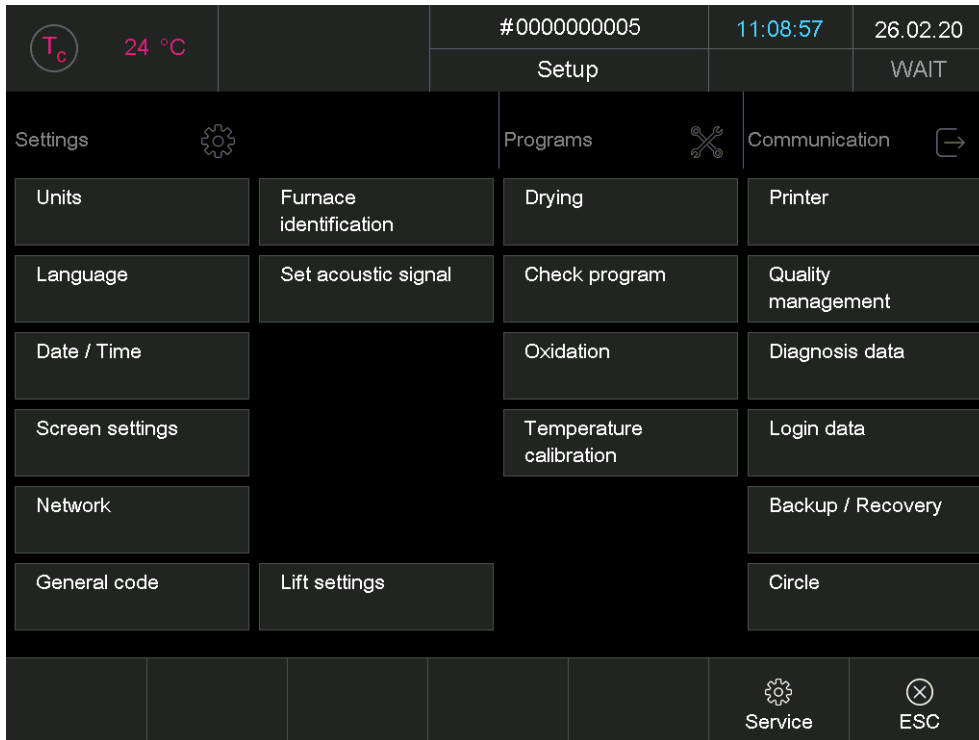

Fig. 5-14 "Setup" menu

Buttons in the function bar

- [Service]:  
Opens the "Service" menu. The "Service" menu is only available when you are authorized for level "2". See section 2.5.
- [ESC]:  
Return to the Program Manager. See section 5.3.

The following table lists the available functions in the "Setup" menu and provides a short description. A detailed explanation can be found in the indicated section in the column "See section".

Function	Description	See section
<b>Settings</b>		
[Units]	Select the unit for the user temperature.	5.7.1.1
[Language]	Select a language for the user interface.	5.7.1.2
[Date/time]	Current date and time in the firing furnace control.	5.7.1.3
[Screen settings]	Determines how long to wait until the screensaver is activated after an entry is made.	5.7.1.4
[Network]	Network settings for the firing furnace.	5.7.1.5
[General code]	Access levels for the firing furnace.	5.7.1.6
[Furnace ID]	Enter the furnace ID.	5.7.1.7
[Acoustic signal]	Set the acoustic signal at the end of the program.	5.7.1.8
[Lift settings]	Specifies if a warning is displayed before opening the lift when the firing chamber is hot.	5.7.1.9
<b>Programs</b>		
[Drying]	Runs a program for drying the firing furnace.	5.7.2.1
[Check program]	Executes the check program to check the function of the most important components.	5.7.2.2
[Oxidation]	Runs the oxidation program.	5.7.2.3
[Temperature calibration]	Calibrates the temperature and sets the CCF value (calibration factor).	5.7.2.4
<b>Communication</b>		
[Printer]	Specifies a printer for the firing furnace.	5.7.3.1

Function	Description	See section
[Quality management]	Determines if a QM report is displayed after a program.	5.7.3.2
[Diagnostic data]	Shows the diagnostic data that is created by the check program.	5.7.3.3
[Login data]	Defines the authorizations to use the firing furnace via the web interface.	5.7.3.4
[Backup / Recovery]	Backs up and restores the data in the firing furnace control.	5.7.3.5
[Circle]	Defines the access to the firing furnace on the Circle or on an FTP server. <ul style="list-style-type: none"> <li>• Circle functionality</li> <li>• FTP functionality</li> </ul>	5.7.3.6 5.7.3.7

Tab. 5-7 Functions in the "Setup" menu

## 5.7.1. Settings

### 5.7.1.1. Units

In the "Setup" menu, tap the [Units] button. The following window for selecting the units for temperature appears. The set unit is marked.

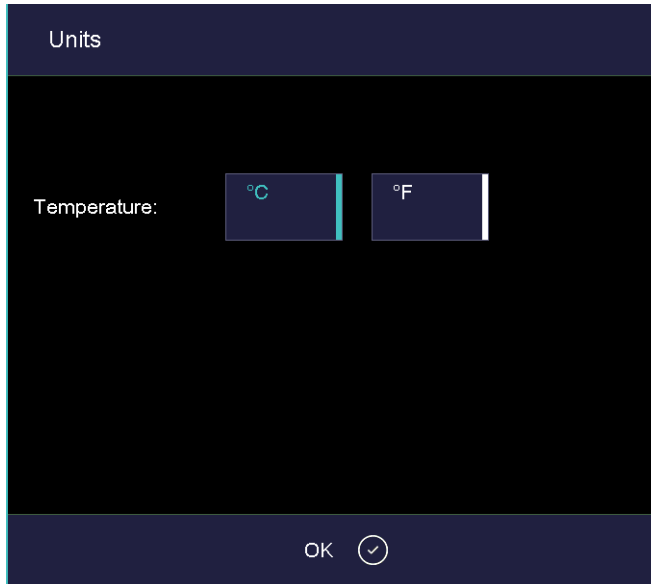

Fig. 5-15 Setup > Units

#### Buttons

- [OK]: Accepts the settings and switches back to the "Setup" menu.

#### Select unit

Tap on the relevant unit. A highlighted button indicates that the corresponding unit is selected:

- Temperature: Choose °C or °F (Fahrenheit);  
Conversion formula:  $T_F = T_C \times 1.8 + 32$  or  $T_F = 9/5 T_C + 32$

### 5.7.1.2. Language

In the "Setup" menu, tap the [Language] button. The following window appears for selecting the language of the user interface. The highlighted button identifies the currently set language.

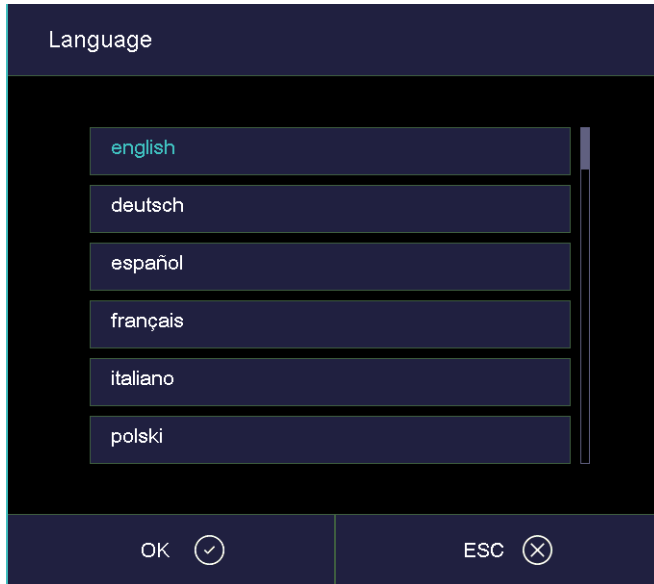

Fig. 5-16 Setup > Language

- |                 |  |
|-----------------|--|
| Buttons         | <ul style="list-style-type: none"><li>• [OK]:<br/>Accepts the settings and switches back to the "Setup" menu.</li><li>• [ESC]:<br/>Closes the window and switches back to the "Setup" menu. The changes will not be saved.</li></ul> |
| Select language | <ul style="list-style-type: none"><li>• Tap on the button for the desired language. The highlighted button identifies the currently set language.</li></ul>  |



### 5.7.1.3. Date/time

In the "Setup" menu, tap the [Date / time] button. The following window opens for setting a date and time of the firing furnace control. The current date and time are displayed.

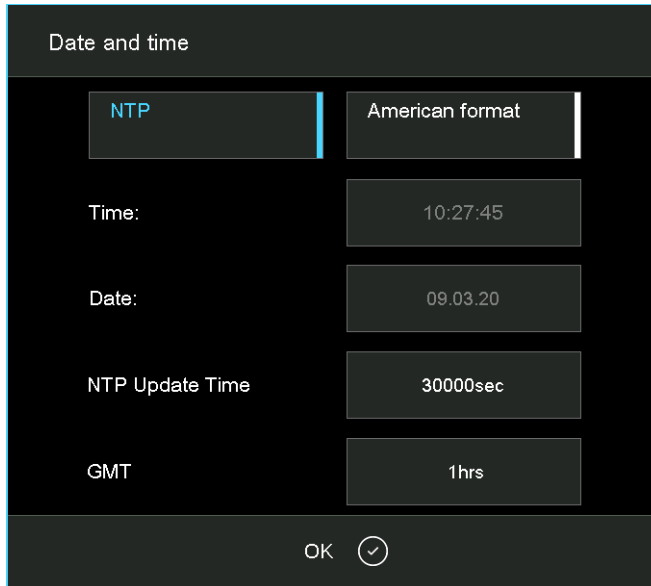

Fig. 5-17 Setup > Date/time

Buttons	<ul style="list-style-type: none"> <li>• [OK]: Accepts the settings and switches back to the "Setup" menu.</li> </ul>
NTP	<p>The time can be synchronized with an NTP server when the firing furnace is connected to the network.</p> <ul style="list-style-type: none"> <li>• The NTP server is defined in the network settings. See section 5.7.1.5,</li> <li>• The synchronization interval is defined by the "NTP Update Time".</li> </ul>
Select the date format	<p>With this button, you can choose the European or American format for the date and time. A highlighted button indicates that the American date format is active.</p> <ul style="list-style-type: none"> <li>• European format, such as "14:29:12", and "15.5.2005" for May 15, 2005</li> <li>• American format, such as "02:29:12 pm" and 5/15/2005 for May 15, 2005.</li> </ul>
Change date/time	<p>You can change the date and time as follows:</p> <ul style="list-style-type: none"> <li>• Tap on the date or time. The numeric keyboard window appears.</li> <li>• Enter the desired date or time.</li> </ul>
NTP Update Time	<p>The update time in [s] defines the interval between two time synchronizations with an NTP server.</p> <ul style="list-style-type: none"> <li>• Tap on the input field. The numeric keyboard window appears.</li> <li>• Enter the desired value.</li> </ul>

- GMT
- Use this button to adjust your local time zone (deviation from the **Greenwich Mean Time**).
- Tap on the input field. The numeric keyboard window appears.
  - Enter the desired value.

### 5.7.1.4. Screen settings

In the "Setup" menu, tap the [Screen settings] button. The following window appears for setting the screen saver.

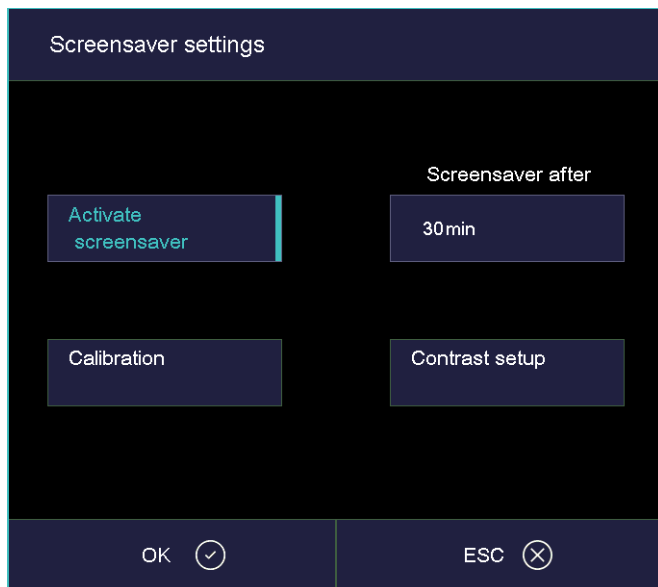

Fig. 5-18 Setup > Screensaver settings

- Buttons
- [OK]: Accepts the settings and switches back to the "Setup" menu.
  - [ESC]: Closes the window and switches back to the "Setup" menu. The changes will not be saved.
- Activate screen saver
- You can activate and deactivate the screensaver with the button. A highlighted button indicates that the screensaver is active.
- Screensaver after...min
- The screen saver makes the screen go dark after the device has not been used for a while (less power consumption and longer screen life). When you press any key or touch the touchscreen, the original display appears. The screensaver starts after the indicated time without an entry (inactivity of the entry device). Change this time as follows:
- Tap on the time. The numeric keyboard window appears.
  - Enter the desired time.

Calibration	Starts a process for calibrating the screen. Crosshairs are displayed on a black background. Tap the white dot in the middle of the crosshairs. The crosshairs change position. Again tap the white dot and continue until calibration is finished (a total of six crosshair positions).
Contrast setup	Opens a window where you can set the screen contrast. See Fig. 5-19. <ul style="list-style-type: none"><li>• Higher value = stronger contrast,</li><li>• lower value = weaker contrast.</li></ul>

### Contrast setup

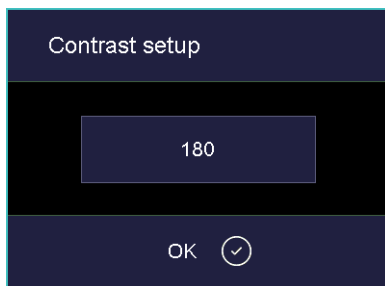

Fig. 5-19 Setup > Screen settings > Contrast setup

### 5.7.1.5. Network

**NOTE:**

**Consult section 4.5 about connecting the firing furnace with a network.**

In the "Setup" menu, tap the [Network] button. The following window appears with the network settings for the firing furnace. The current addresses in the network are displayed.

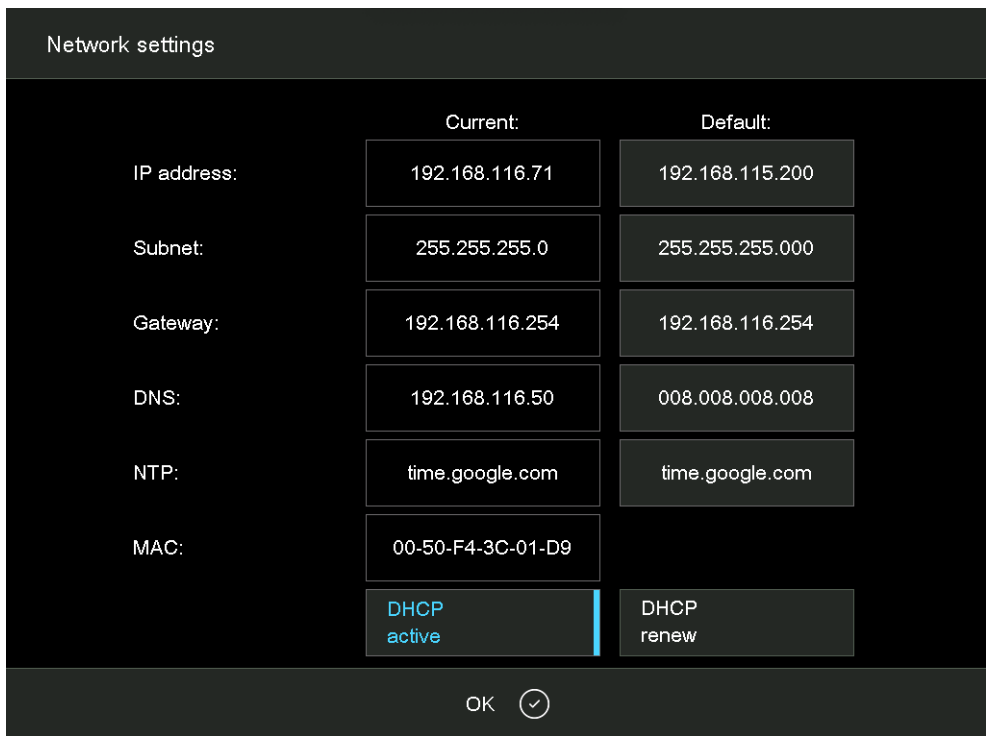

Fig. 5-20 Setup > Network

Buttons

- [OK]: Accepts the settings and switches back to the "Setup" menu. Note that changed settings are only applied when restarting the firing furnace.

Change address:

- IP-Adresse
- Subnet
- Gateway
- DNS
- NTP
- MAC

Please note: The current addresses cannot be edited. Change an address as follows:

- Tap on the corresponding address. The alphanumeric keyboard window appears.
- In the keyboard window, tap on [Edit].
- Enter the desired address.

DHCP active

Use the button to assign an IP address to the firing furnace from your network server. A highlighted button indicates that the DHCP function is active.

DHCP renew

Only available when DHCP is active. Use the button to automatically assign a new IP address to the firing furnace from your network server.

### 5.7.1.6. General code

You can use this function to protect (lock) firing programs from changes). See also section 2.5. Note the following usage restrictions before activating the general code.

- Only programs in the local memory "Local" of the firing furnace control can be locked by the general code,
- The general code locks and releases all programs in a set. Individual usage of programs is not possible,
- Programs protected by the general code cannot be edited or changed. The program editor cannot be opened for these programs,
- Programs protected by the general code cannot be deleted (program manager),
- The functionality in the "Setup" menu is strongly restricted.

#### Activate general code

- In the "Setup" menu, tap the [General code] button. The alphanumeric keyboard window appears.
- Enter the password for the general code. The following "General code" window appears.

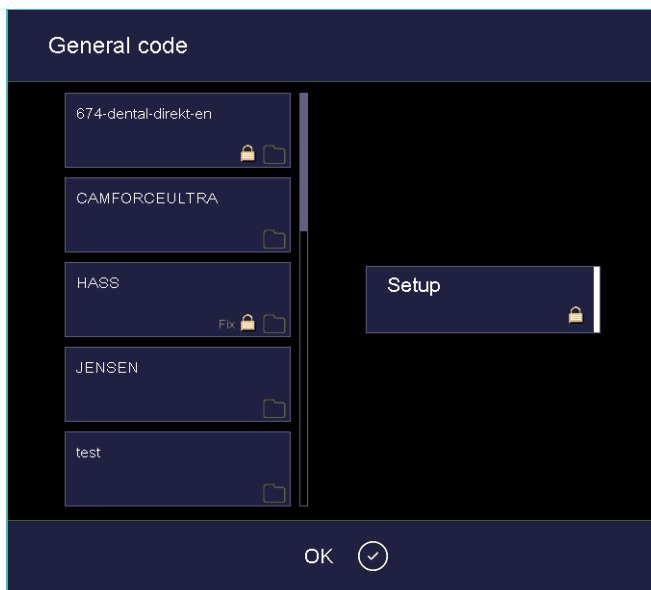

Fig. 5-21 "General code" window (example)

Buttons	<ul style="list-style-type: none"> <li>• [OK]: Accepts the settings and switches back to the "Setup" menu.</li> </ul>
Lock set	<p>Lock the programs within a set as follows:</p> <ul style="list-style-type: none"> <li>• Tap on the corresponding set. A lock symbol in the button indicates that all programs in this set are protected.</li> <li>• Tap again on this set. The word "Fix" appears next to the lock symbol, and indicates that all programs in this set are run as fix programs.</li> <li>• Tap a third time on this set. The lock symbol disappears. The programs in this set are no longer protected.</li> <li>• Lock all desired sets as described.</li> <li>• Tap on [OK].</li> </ul> <p>Fix: The firing programs in a locked set are run as fix programs. The firing parameters of these programs can be adjusted for a single program run, but they cannot be saved. The Program Manager automatically appears when a fix program execution is completed. The word "Fix" next to the lock symbol indicates that the Fix function is active for the programs in this set.</p>
Setup	<p>A lock symbol in the button indicates that the functionality in the "Setup" menu is strongly restricted. You can still edit the network settings (see section 5.7.1.5) and select the drying program (see section 5.7.2.1).</p>

Sets protected by the general code are marked in the Program Manager with a lock symbol in the button. In the program display, a lock symbol in the information bar indicates that a program is protected.



Fig. 5-22 Lock symbol for protected programs

### Deactivate general code

- In the "Setup" menu, tap the [General code] button. The alphanumeric keyboard window appears.
- Enter the password for the general code.

The general code is deactivated.

### Change locked sets

Change the locked sets when the general code is activated as follows.

- Deactivate the general code.
- Reactivate the general code, and lock the sets as desired.

### 5.7.1.7. Furnace ID

In the "Setup" menu, tap the [Furnace ID] button. The following window appears for entering the furnace ID. The current furnace ID is displayed together with the current, furnace-specific hardware and software versions.

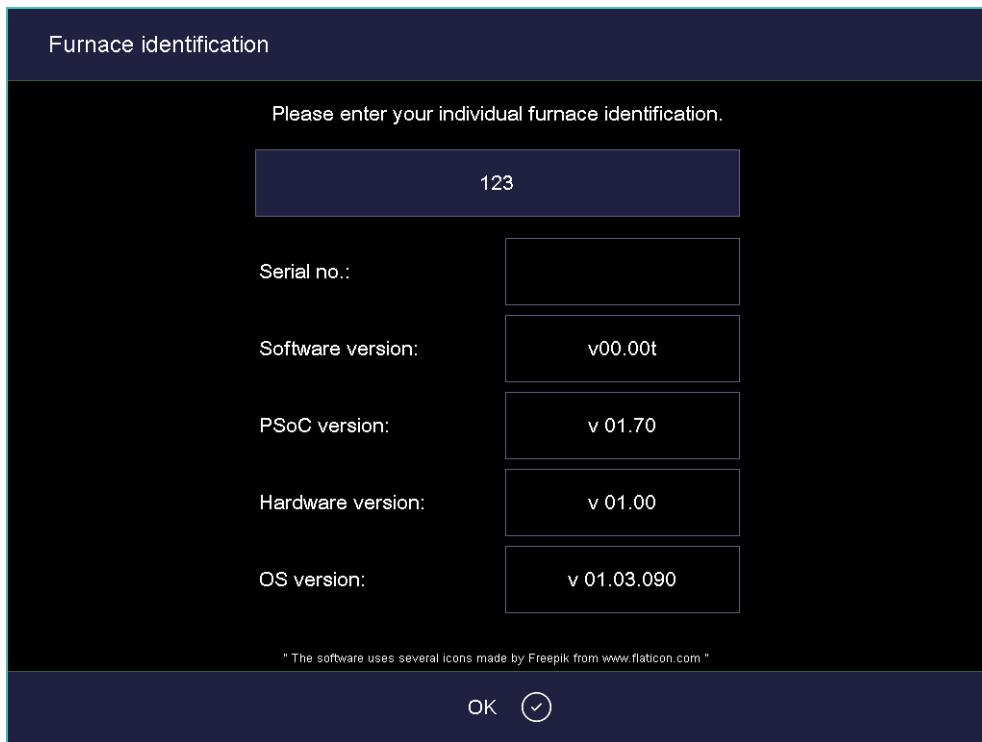

Fig. 5-23 Setup > Furnace ID

#### Buttons

- [OK]: Accepts the settings and switches back to the "Setup" menu.

#### Change furnace ID

To prevent confusing firing furnaces from each other (for example when printing records), an individual ID can be entered for each firing furnace.

- Tap the entry field for the furnace ID. The alphanumeric keyboard window appears.
- Enter your individual furnace ID.
- Tap on [OK].

### 5.7.1.8. Acoustic signal

In the "Setup" menu, tap the [Acoustic signal] button. The following window appears for selecting and testing the acoustic signal at the end of the program. The current signal is displayed.

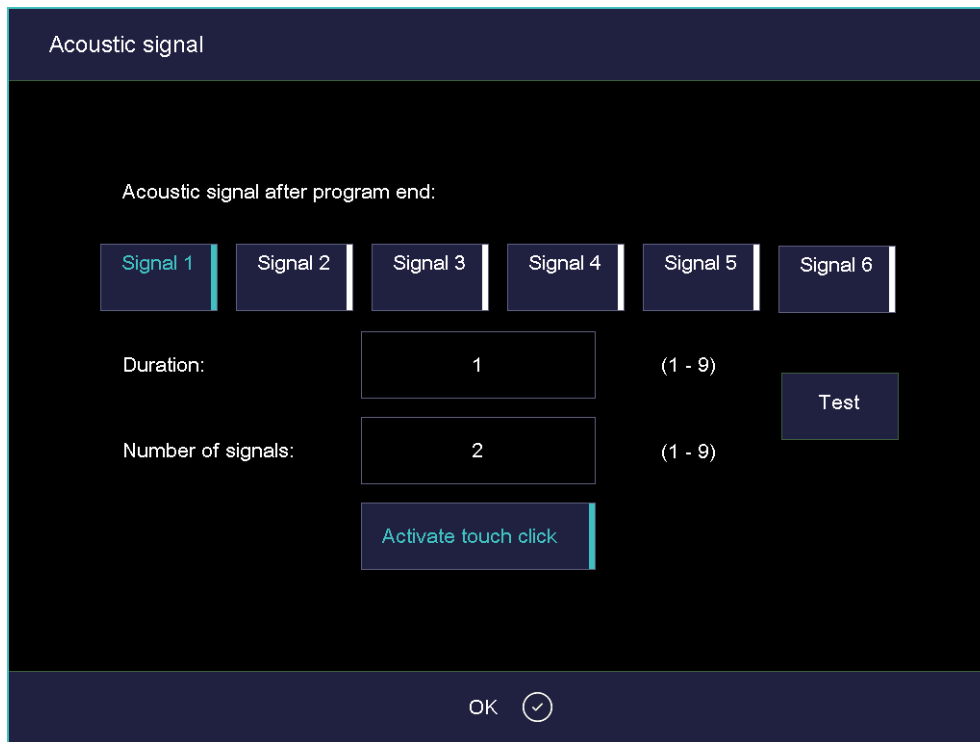

Fig. 5-24 Setup > Acoustic signal

Buttons	<ul style="list-style-type: none"> <li>• [OK]: Accepts the settings and switches back to the "Setup" menu.</li> </ul>
Select acoustic signal	<p>There are six default acoustic signals you can select that each consist of individual tones. The duration (in seconds) and number of tones varies from 1 to 9.</p> <p>Tap on the corresponding button to select the desired signal. A highlighted button indicates that the signal is active</p>
Test	<p>The selected signal sounds for a test.</p>
Activate Touchclick	<p>When touchclick is activated, the firing furnace emits a confirmation signal each time a key is pressed. A highlighted button indicates that the function is active</p>



### 5.7.1.9. Lift settings

**NOTE:**

**For safety reasons, it is recommended not deactivating the warning.**

When the "Warning" function is turned on, a warning appears before you open a hot firing chamber (temperature higher than 200 °C). You are asked, "OPEN LIFT?". Confirm the query when you want to move the lift down and open the hot firing chamber.

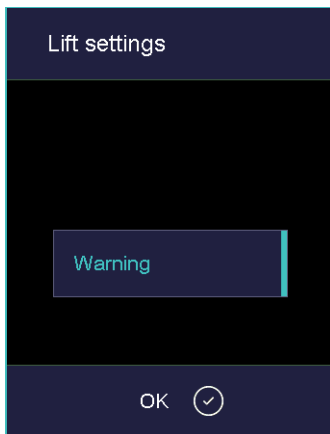

Fig. 5-25 Setup > Lift settings

**Buttons**

- [OK]: Accepts the settings and switches back to the "Setup" menu.

**Warning**

Tap the button to activate the warning display. A highlighted button indicates that the function is active

## 5.7.2. Programs

### 5.7.2.1. Drying

Use the drying program to dry the firing chamber, for example when the firing furnace has been exposed to a high-level of humidity for a long time.

In the "Setup" menu, tap the [Drying] button. The following window appears for starting the drying program.

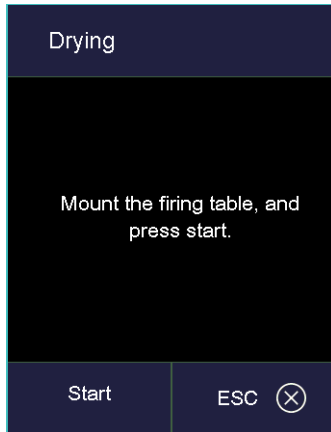

Fig. 5-26 Setup > Drying

#### Buttons

- [Start]: Starts the drying program (duration: approximately 90 minutes).
- [ESC]: Closes the window and switches back to the "Setup" menu.

#### Start the program

Mount the firing table and tap [Start]. The "Dry" window is displayed as long as the program is running. You can terminate the program at any time when you tap the [Stop] button. A safety query opens and asks you whether you really want to end the program:

- [OK]: Confirm your decision and stop the program,
- [ESC]: Change your decision and continue the program.

### 5.7.2.2. Check program

The AUSTROMAT™ 664i™ / 674i™ has an internal program, the check program, that checks the function of the major components. Regularly using this non-editable program makes it easier for you and the responsible service personnel to identify aged components (such as heating element wear) and troubleshoot malfunctions. After approximately 500 firings, the firing furnace displays a recommendation on the screen to start the self check program.

In the "Setup" menu, tap the [Check program] button. The following window appears for starting the check program.

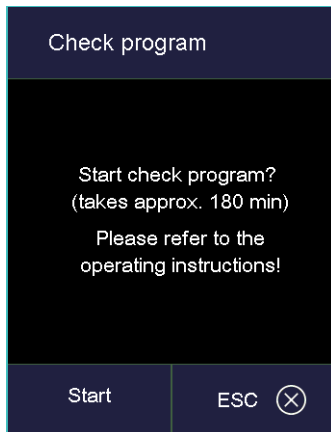

Fig. 5-27 Setup > Check program

Buttons	<ul style="list-style-type: none"> <li>• [Start]: Starts the check program; duration approx. 180 min.</li> <li>• [ESC]: Closes the window and switches back to the "Setup" menu.</li> </ul>
Start the program	<p>Tap on [Start]. The "Check program" window is displayed as long as the program is running. You can terminate the program at any time when you tap the [Stop] button. A safety query appears and asks if you really want to end the program:</p> <ul style="list-style-type: none"> <li>• [OK]: Confirm your decision and in the program,</li> <li>• [ESC]: Change your decision and continue the program.</li> </ul>
Check program	You can find instructions on the check program in section 7.3.

### 5.7.2.3. Oxidation

Use the oxidation program to clean the heating elements, the firing chamber and the thermocouples.

In the "Setup" menu, tap the [Oxidation] button. The following window appears to start the oxidation firing. The set end temperature is displayed.

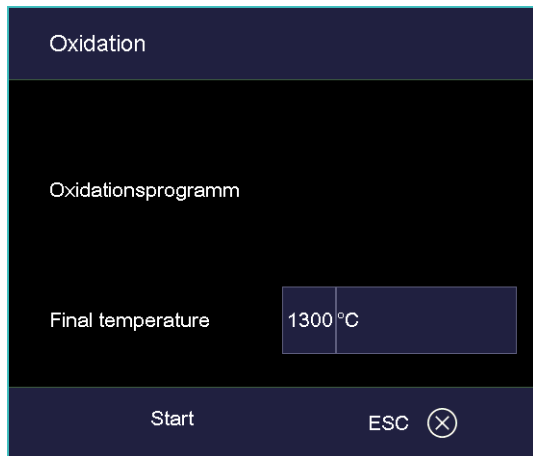

Fig. 5-28 Setup > Oxidation firing

- |                        |   |
|------------------------|---|
| Buttons                | <ul style="list-style-type: none"> <li>• [Start]: Starts the oxidation program (duration: approximately 200 minutes depending on the end temperature).</li> <li>• [ESC]: Closes the window and switches back to the "Setup" menu.</li> </ul>  |
| Change end temperature | <ul style="list-style-type: none"> <li>• Tap on the end temperature. The numeric keyboard window appears.</li> <li>• Enter the desired temperature.</li> </ul>  |
| Start the program      | <p>Tap on [Start]. The "Oxidation" window is displayed as long as the program is running. You can terminate the program at any time when you tap the [Stop] button. A safety query appears and asks if you really want to end the program:</p> <ul style="list-style-type: none"> <li>• [OK]: Confirm your decision and in the program,</li> <li>• [ESC]: Change your decision and continue the program.</li> </ul> |

### 5.7.2.4. Temperature calibration

**NOTE:**

**DEKEMA recommends that the AUSTROMAT™ 664i™ / 674i™ temperature is calibrated annually.**

In the "Setup" menu, tap the [Temperature calibration] button. The following temperature calibration window appears. The set CCF value is shown.

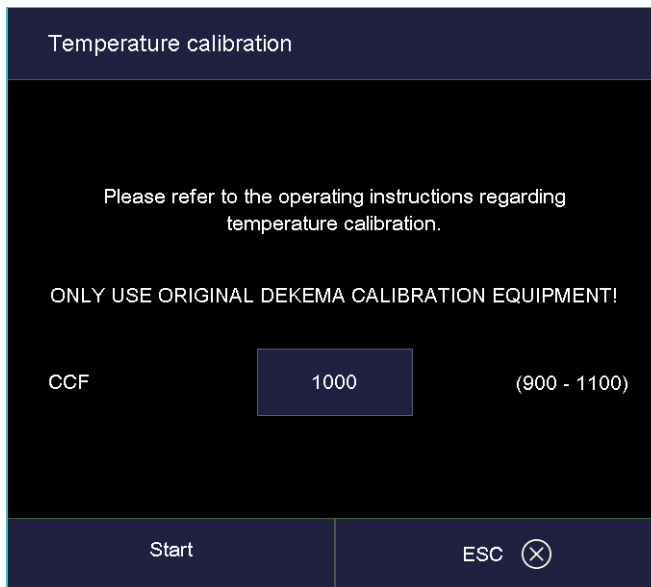

Fig. 5-29 Setup > Temperature calibration

Buttons	<ul style="list-style-type: none"> <li>• [Start]: Starts temperature calibration.</li> <li>• [ESC]: Closes the window and switches back to the "Setup" menu. The changes will not be saved.</li> </ul>
Calibrate temperature	<p>The procedure for calibrating the temperature is in section 7.2. You can terminate the program at any time when you tap the [Stop] button. A safety query appears and asks if you really want to end the program:</p> <ul style="list-style-type: none"> <li>• [OK]: Confirm your decision and end the program.</li> <li>• [ESC]: Change your decision and continue the program.</li> </ul> <p>Refer to section 7.2 for further information on temperature calibration.</p>
Change CCF value	<ul style="list-style-type: none"> <li>• Tap on the CCF value. The numeric keyboard window appears.</li> <li>• Enter the desired CCF value.</li> </ul>

### 5.7.3. Communication

#### 5.7.3.1. Printer

In the "Setup" menu, tap the [Printer] button. The following printer settings window appears.

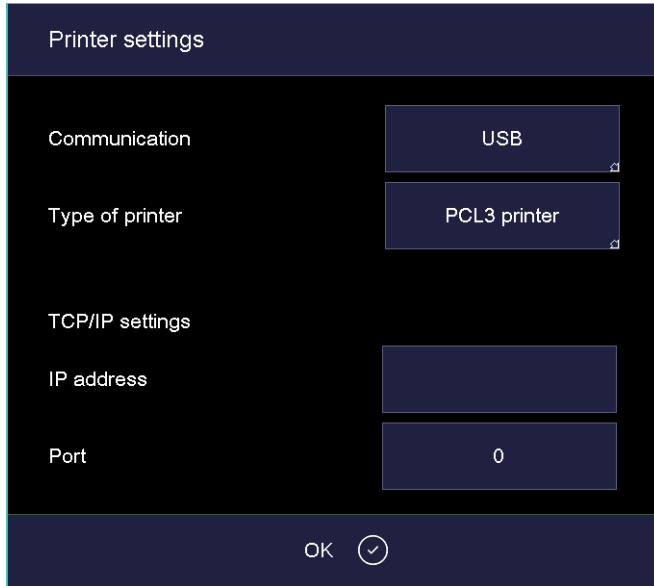

Fig. 5-30 Setup > Printer

Buttons	<ul style="list-style-type: none"><li>• [OK]: Closes the window and switches back to the "Setup" menu.</li></ul>
Communication	Specifies the interface for the printer (drop-down list).
Printer type	In the printer type fields, you can specify the printer (drop-down list) for example to print out record data.
TCP/IP settings	Settings for a network printer.

### 5.7.3.2. Quality management

In the "Setup" menu, tap the [Quality management] button. The following quality management window appears.

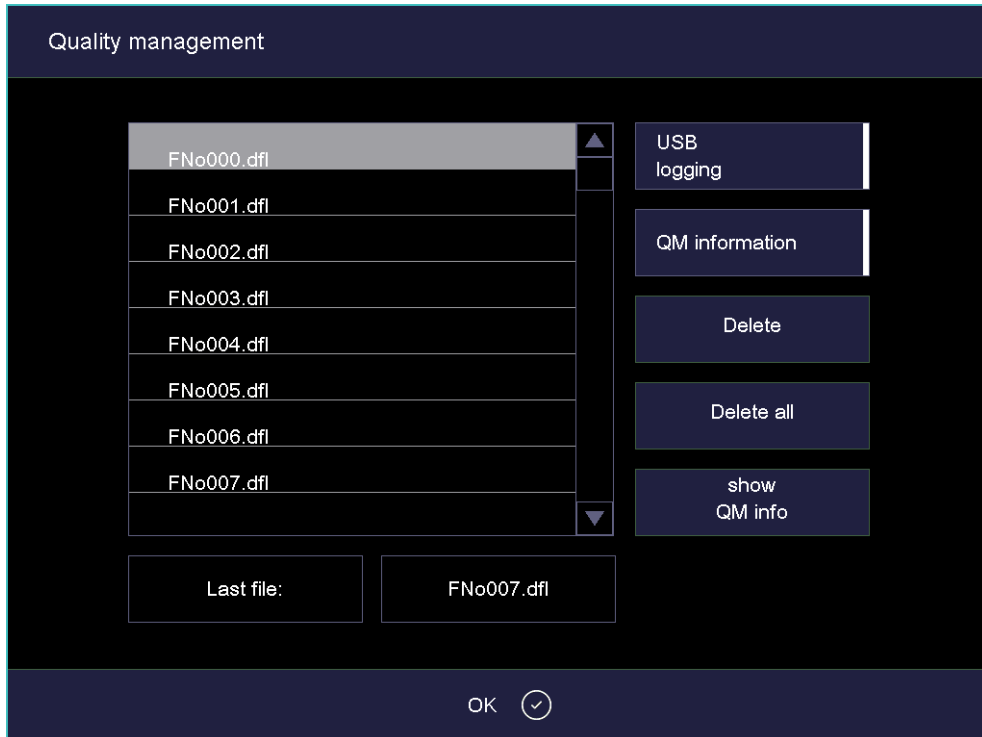

Fig. 5-31 Setup > Quality management

The firing furnace logs the ten last firing programs that have run. If more than ten firing programs have run, these QM files are overwritten starting with the last one.

Buttons	<ul style="list-style-type: none"> <li>[OK]: Accepts the settings and switches back to the "Setup" menu.</li> </ul>
Last file	The name of the QM file of the last run firing program.
USB logging	Tap this button to activate or deactivate the recording of data to an external USB stick. A highlighted button indicates that the function is active. The QM files are additionally updated on the USB stick (USB record).
QM information	<p>Tap on the button to display the QM information after each firing program is over. A highlighted button indicates that the function is active</p> <ul style="list-style-type: none"> <li>Not active: QM information is logged but not displayed.</li> <li>Active: After a firing program is over, the related detailed firing information appears on the display.</li> </ul>
QM files	<ul style="list-style-type: none"> <li>[Delete]: Deletes the selected QM file.</li> <li>[Delete all]: Deletes all QM files.</li> <li>[show QM info]: Displays the selected QM file.</li> </ul>

### 5.7.3.3. Diagnostic data

In the "Setup" menu, tap the [Diagnosis data] button. The following diagnostic data window appears.

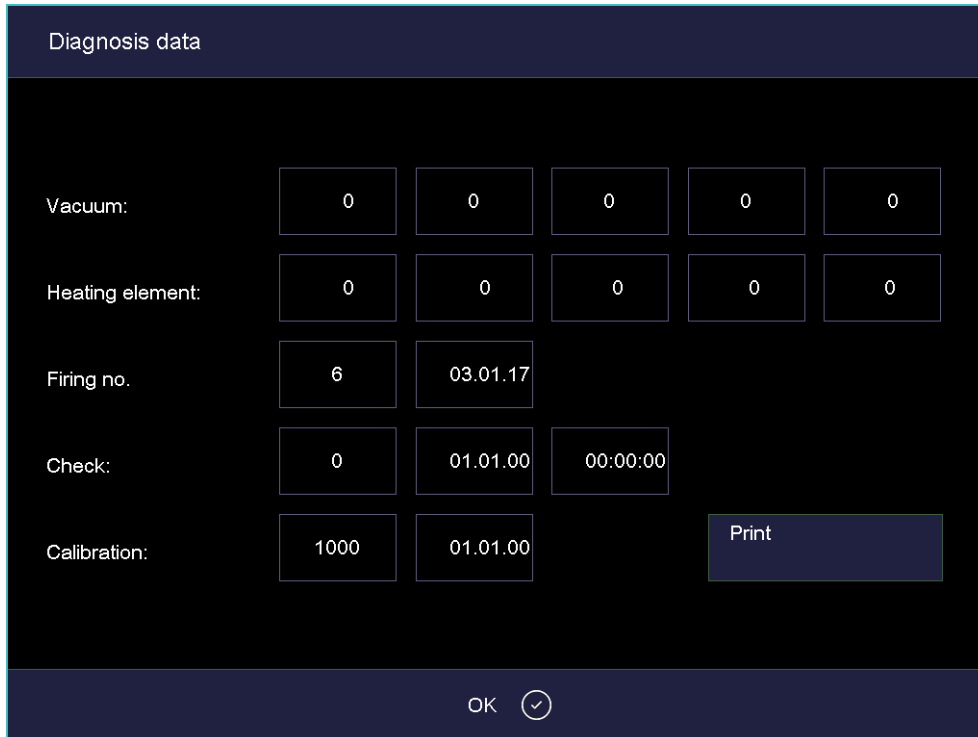

Fig. 5-32 Setup > Diagnosis data

#### Buttons

- [Print]: Prints the diagnostic data. Note that a printer must be connected and set up (see section 5.7.3.1).
- [ESC]: Closes the window and switches back to the "Setup" menu.

The diagnostic data are created by the check program and saved in a diagnostic file (see section 5.7.2.2). The values and interpretation of the diagnosis data are important for the service personnel. For remote diagnosis, you can output the diagnostic file on the screen or send it by e-mail (address see page 2). The data have little significance for the user. They are therefore not detailed here.



### 5.7.3.4. Login data

**NOTE:**

As long as no HTML access is defined (that is, the fields "Username" and "Password" are empty, each user of the computer can access the firing furnace.

**NOTE:**

If the username or password becomes lost, contact your service partner or directly contact DEKEMA. See page 2.

HTML access authorizes you to remotely access (through a web interface or a VNC program) the control of the firing furnace. The password is defined in the "HTML access" window. This password must be entered in the browser on the computer to obtain access to the firing furnace. See also the section 4.5.

In the "Setup" menu, tap the [Login data] button. The following HTML access window appears.

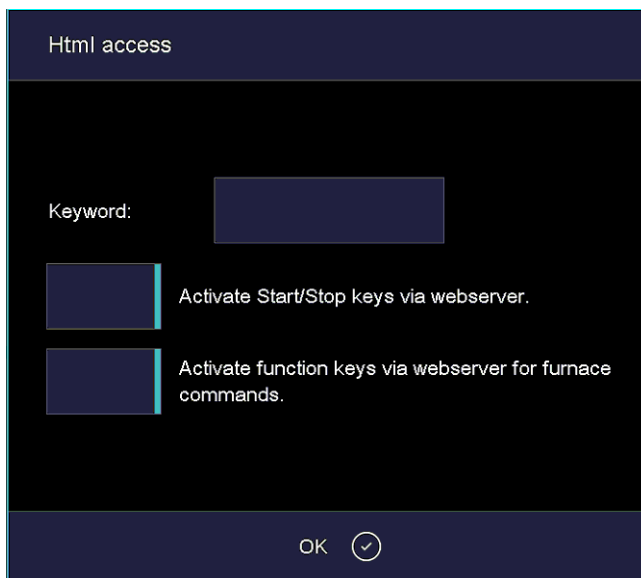

Fig. 5-33 Setup > Login data

Buttons	<ul style="list-style-type: none"> <li>[OK]: Accepts the settings and switches back to the "Setup" menu.</li> </ul>
Password	<p>Specify the password as follows:</p> <ul style="list-style-type: none"> <li>Tap on the "Password" entry field. The alphanumeric keyboard window appears.</li> <li>Enter the password.</li> </ul>
Activate Start/Stop keys via webservice	<p>In order for you to use the firing furnace via the user interface on the computer (start firing programs, move lift, etc.), the start/stop function must be activated.</p> <p>Tap the button to activate or block the start/stop function via the Webservice. A highlighted button indicates that the function is active.</p>

Activate function keys via webserver for furnace commands In order for you to execute touchscreen functions (see section 3.2) via the Webserver, the function keys of the computer keyboard must be activated.

Tap the button to activate or block the function keys for the furnace commands. A highlighted button indicates that the function is active

### 5.7.3.5. Backup / Recovery

**NOTE:**  
**For reasons of data safety and to prevent the loss of firing furnace data, it is recommendable to regularly back up all your data.**

In the "Setup" menu, tap the [Backup/Recovery] button. The following window for backing up and recovering data appears.

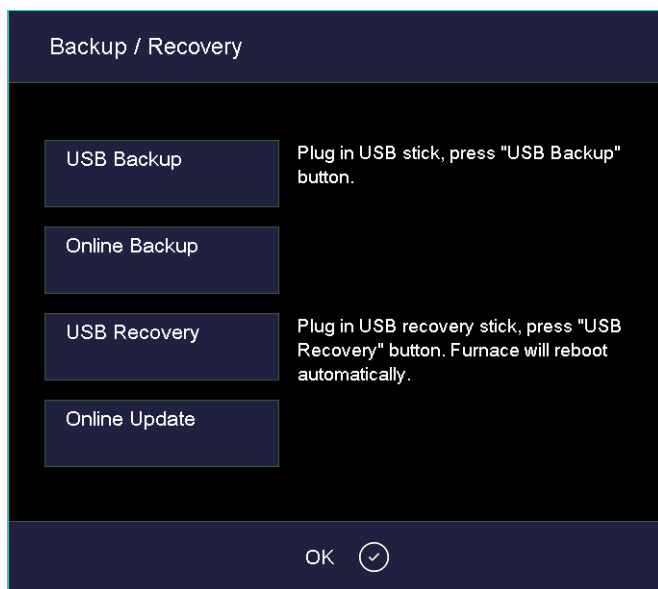

Fig. 5-34 Setup > Backup / Recovery

- Buttons
- [USB Backup]: Starts backing up the data on a USB stick.
  - [Online Backup]: Starts backing up the data via the network connection (online).
  - [USB Recovery]: Starts recovering the data from a USB stick.
  - [Online Update]: Starts an online update of the software of the firing furnace.
  - [OK]: Closes the window and switches back to the "Setup" menu.

**USB Backup**

Follow the instructions under "USB Backup" in the "Backup / Recovery" window.

**NOTE:**

**All data on the USB stick are deleted at the start of the backup.**

1. Insert a USB stick (make sure there is enough free memory) into the USB port in the back of the firing furnace.
2. Tap on [Backup Start]. All the data of the firing furnace (operating system, software, set parameters and firing programs) are written to the USB stick. A progress bar indicates the remaining time until the backup is completed.
3. Wait until an acknowledgment beep sounds. It signals the conclusion of the backup process.
4. Remove the USB stick.

You have successfully backed up the firing furnace data. If data is lost, you can restore the data with the USB stick. Be sure to carefully store the USB stick and do not accidentally overwrite the backed up data.

**USB Recovery**

Follow the instructions under "USB Recovery" in the "Backup / Recovery" window:

1. Insert the USB stick with the backed up data into the USB port in the back of the firing furnace.
2. Tap on [Recovery Start]. All the data of the firing furnace (operating system, software, set parameters and firing programs) are restored.
3. Wait until an acknowledgment beep sounds. It signals the conclusion of the recovery process.
4. Remove the USB stick.

You have successfully restored the firing furnace data.

**NOTE:**

**You can restore the data in the same manner as when updating the software (see section 7.5).**

Proceed as follows:

1. Turn off the firing furnace.
2. Plug the USB stick with the backup data into the USB port.
3. Turn on the firing furnace. While booting up, the firing furnace restores the backup.
4. Withdraw the USB stick once a corresponding message appears on the screen.

The firing furnace then reboots and is ready to use.

**Backup data – Online backup****NOTE:**

**An online backup requires an active internet connection. Note that only data backup and software update can be performed online, but no data recovery.**

1. Tap on the [Online Backup] button.
2. All data of the firing furnace control (operating system, software, set parameters, and firing programs) are written to the DEKEMA server. A progress bar indicates the remaining time until the backup is completed.
3. Wait until the backing up is completed. This may last some minutes.

You have successfully backed up the firing furnace data.

**Online Update**

Proceed as follows to update the software of the firing furnace:

**NOTE:**

**Updating the software of the firing furnace requires an active internet connection.**

1. Tap on the [Online Update] button.
2. A message indicates that the firing furnace is searching for a new software version. See section 5.7.1.7.
3. A message requests you to download the new software version if there is one available.
4. Tap [OK] to confirm the message.
5. Wait until the firing furnace has downloaded the new version. This may last some minutes.

Afterwards, the firing furnace reboots, and then is ready for use.

### 5.7.3.6. Circle Login

The DEKEMA devices trix™CAD, trix™print and AUSTROMAT™ i firing furnaces can communicate with each other directly in the "Circle". This enables access to personalized firing, press, and sinter programs. The programs can be uploaded into the circle via remote control, or directly via the firing furnace.

The communication of the DEKEMA devices requires that each device is connected with this circle.

1. In the "Setup" menu, tap the [Circle] button. The function selection window appears.
2. Select "Circle" from the drop-down list "Function".

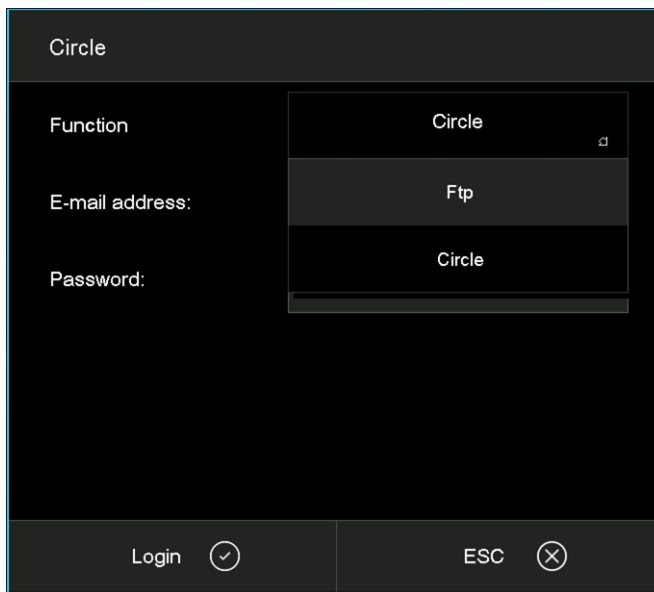

Fig. 5-35 Setup > Circle > selecting "Circle"

3. Tap on the [Login] button. The following window appears to log-in the firing furnace into the circle.

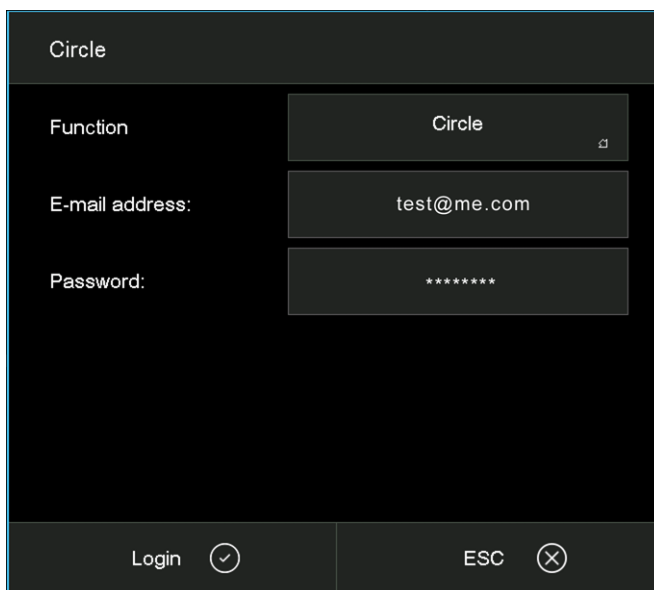

Fig. 5-36 "Circle Login" window

---

Buttons	<ul style="list-style-type: none"><li>• [Login]: Login the firing furnace into the circle. Closes the window and returns to the "Setup" menu.</li><li>• [Logout]: Logout the firing furnace from the circle. Closes the window and returns to the "Setup" menu.</li><li>• [ESC]: Closes the window and returns to the "Setup" menu.</li></ul>
Function	Selected function.
E-mail address:	E-mail address for connecting the firing furnace with the circle. <ul style="list-style-type: none"><li>• Tap on the "E-mail address" entry field. The alphanumeric keyboard window appears.</li><li>• Enter your E-mail address for the circle.</li></ul>
Password	Password with which the firing furnace has access to the circle. <ul style="list-style-type: none"><li>• Tap on the "Password" entry field. The alphanumeric keyboard window appears.</li><li>• Enter your password.</li></ul>

**Establish a connection with the circle**

The connection with the circle is only established if all access data (E-mail address, password) are correct.

When you want to terminate the connection, tap [Logout] in the "Circle Login" window.

### 5.7.3.7. FTP Server Login

**NOTE:**

**There are many DEKEMA-independent programs available to set up an external FTP server. For further information, please contact your network administrator.**

With the FTP functionality, you can access an externally-linked FTP server. You can for example link picture folders and files to the firing furnace and view them while the program is running.

1. In the "Setup" menu, tap the [FTP Server Login] button. The function selection window appears.
2. Select "Ftp" from the drop-down list "Function".

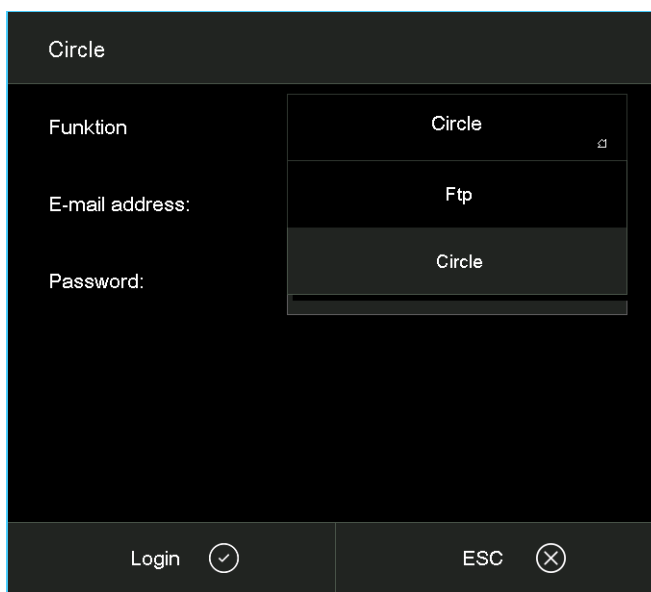

Fig. 5-37 Setup > Circle > selecting "Ftp"

3. Tap [Login]. The following window appears for access to an FTP server.

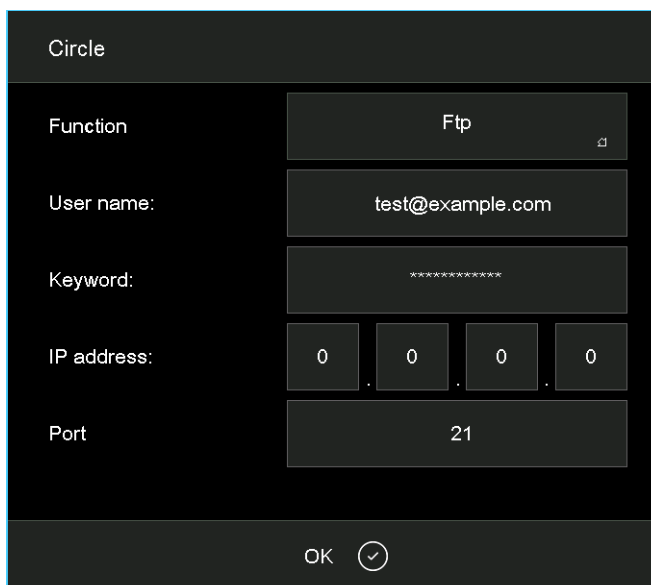

Fig. 5-38 Setup > FTP Server Login

---

Buttons	<ul style="list-style-type: none"><li>• [OK]: Closes the window and switches back to the "Setup" menu.</li></ul>
Function	Selected function.
User name	User name for your access the FTP server. <ul style="list-style-type: none"><li>• Tap on the "User name" entry field. The alphanumeric keyboard window appears.</li><li>• Enter your user name.</li></ul>
Password	Password with which you have access to the FTP server. <ul style="list-style-type: none"><li>• Tap on the "Password" entry field. The alphanumeric keyboard window appears.</li><li>• Enter your password.</li></ul>
IP address	IP address of the FTP server. <ul style="list-style-type: none"><li>• Tap on the corresponding "IP address" entry field. The numeric keyboard window appears.</li><li>• Enter the IP address of the FTP server.</li></ul>
Port	Port of the FTP server. <ul style="list-style-type: none"><li>• Tap on the "Port" entry field. The numeric keyboard window appears.</li><li>• Enter the port of the FTP server.</li></ul>

**Establish a connection to the FTP server**

The connection with an FTP server is only established if all access data (user name, password, IP address) are correct. Proceed as follows to connect the firing furnace to an FTP server.



## 6. Operation

**NOTE:**

When using the firing furnace, observe section 2, Safety.

### 6.1. Turning on and off

**NOTE:**

Never operate the firing furnace without supervision.

**Preparations**

Check if

- the AUSTROMAT™ is connected by a power cable to a socket with a protected contact. See section 4.4,
- the firing furnace is connected via a Web interface to an individual computer or network. See section 4.5.



**Switching on**

- Turn on the firing furnace:
  - Main switch on the back of the firing furnace: The control of the firing furnace starts up over a period of about 1 minute. The firing furnace performs an internal software and hardware check, and the lift moves down automatically. Or
  - On/off switch in standby mode next to the touchscreen if the firing furnace is already in standby mode. The firing furnace is immediately ready for use.
- Make sure that the insulating table is mounted on the lift seat. If not: Turn the firing furnace off, and mount the insulating table. Then turn on the firing furnace again.

**Switching off**

- Close the firing chamber before switching off the firing furnace to avoid any condensation in the ceramic furnace.
- Turn off the firing furnace:
  - Main switch on the back of the firing furnace, or
  - On/off switch in standby mode next to the touchscreen.

## 6.2. Mounting and removing a firing object

<b>⚠ WARNING</b>	
 	<p><b>Hot surfaces.</b></p> <p>The firing chamber can reach temperatures above 1,500 °C during operation. There is an extreme burning hazard from touching hot surfaces after the firing chamber is opened.</p> <p>Never directly contact hot parts of the firing furnace. The firing furnace requires several hours to cool after it is turned off. Observe the following instructions:</p> <ul style="list-style-type: none"> <li>• Do not use your hands or any objects to grasp things in the firing chamber,</li> <li>• Do not grasp the lift seat, insulation table or firing objects with your bare hands,</li> <li>• Use suitable tools (tweezers) to remove the firing objects, or wear safety gloves.</li> </ul>

### Mounting the firing object

- Place the sinter plates and sinter rings on the insulation table:
  - Mount the wave-shaped sinter ring and optionally cover it with a sinter plate. This unit forms one level.
  - Create up to two levels as needed.
  - Cover the top level with another sinter plate if desired.



Fig. 6-1 Stacking the levels (example of two levels for AUSTROMAT™ 664i™)

- 1 Insulation table
- 2 Sinter ring
- 3 Sinter plate

**NOTE:**

**Stack the levels as precise as possible. The levels may not tilt. Given the dimensional tolerances, the sinter plates and sinter rings may tilt when stacked. Make sure that this does not happen since the insulation may be contacted while the lift is being closed causing undesirable wear.**

- Place the firing object on the sinter ring, and place the sinter plate in the middle of the insulation table.
- When positioning the firing object, ensure that no parts jut out over the edge of the top sinter plate. There is a danger of damaging the firing object and thermal insulation material when closing the firing furnace.

**Removing the firing object**

- Use suitable tools (tweezers) to remove the firing objects, or wear safety gloves.

## 6.3. Select programs and start them

### 6.3.1. With the touchscreen

1. After turning on the firing furnace, the Program Manager automatically appears on the touchscreen. Select the desired program. See section 5.3.
2. The firing of the selected program is displayed (program display, see section 5.4).
3. Tap on [Start] in the program display. The program is processed automatically. See section 5.5.
4. While the program is running, the lift automatically moves up and down. Make sure that no objects are in the way that could hinder the lift movement. Also do not attempt to manually stop or accelerate the lift.
5. While the program is running, you can stop the program by tapping on [Stop].

### 6.3.2. With web interface

**NOTE:**

**To operate the firing furnace using the web interface, your browser must be Java-capable, and the Java application must be activated.**

**Start Web interface**

1. Start the browser on the computer.
2. Click on the bookmark for the firing furnace (if available), or enter the IP address for the firing furnace in the address line of the browser. See section 4.5.
3. Enter your login data, i.e. the password. The Program Manager opens. See section 5.3.

The remaining procedure is the same as that in section 6.3.1.

### 6.3.3. With VNC program

**NOTE:**

To use the firing furnace via a VNC, a suitable VNC program needs to be installed on the computer. The VNC function of the firing furnace must be activated (section 5.7.1.5).

**Start the VNC program**

1. Start the VNC program on the computer.
2. Enter the IP address for the firing furnace and the password. See section 4.5. The Program Manager opens. See section 5.3.

The remaining procedure is the same as that in section 6.3.1.

### 6.3.4. With iOS device

**NOTE:**

Remote operation of the firing furnace via smartphone requires installing the iDREAM™ (DEKEMA Remote Access Management) app. iDREAM™ v2.0 can easily be updated or downloaded through the Apple® App Store.

1. Start the iDREAM™ -App on the smartphone.

The remaining procedure is the same as that in section 6.3.1.

### 6.3.5. Operating layout for the menu control

The basic operating layout for the menu control is shown in the following illustration. It can help you become familiar with the operation of the firing furnace. The arrows in the diagram indicate how to get from one menu item to another. The individual menus are described in section 5.

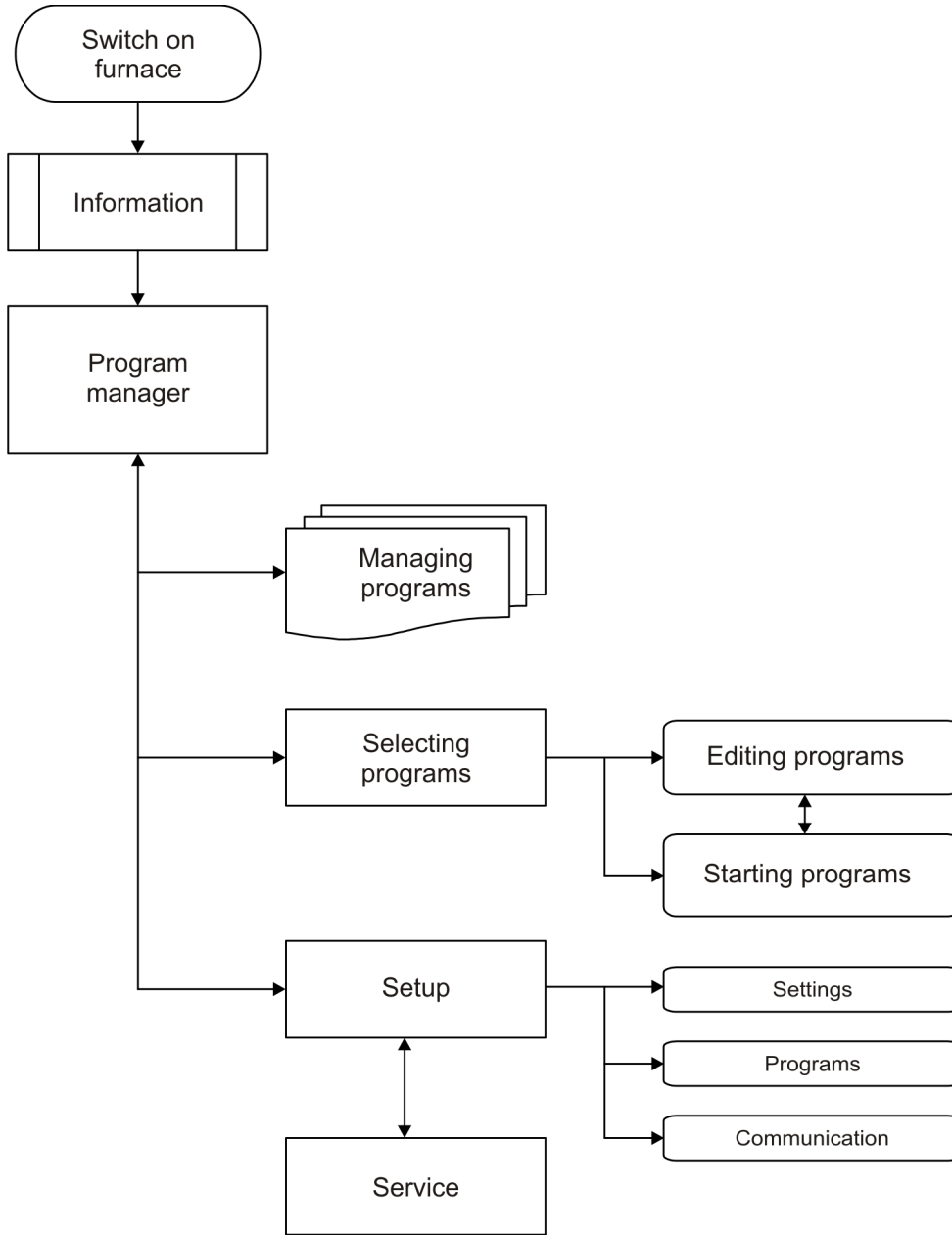

Fig. 6-2 Operating layout for the menu control

## 6.4. Program end

**NOTE:**

**The firing chamber is generally closed at temperatures  $T > 999\text{ °C}$ . The chamber only opens for chamber temperatures below  $999\text{ °C}$ .**

- While the program is running, you can stop the program by tapping [Stop]. In this case, all the commands are stopped and the heat system is turned off. The firing furnace cools down. The firing number is increased when the firing program has been running longer than 30 s.
- An acoustic signal sounds after a regular program end.
  - The lift moves down,
  - The firing number is automatically increased,
  - A log file for the firing is created and printed (if a printer is configured).
- You can remove the fired object. See section 6.2.

**NOTE:**

**If, after the firing program is over, the firing chamber is opened longer than 15 minutes while the chamber temperature is above  $200\text{ °C}$ , a message appears and asks you to close the firing chamber to prevent wear.**

- **Acknowledge the message.**
- **Close the firing chamber.**

## 6.5. Some practical tips

### 6.5.1. General operation of the furnace

#### **Ceramics and chemicals**

Chemical substances can contaminate the firing chamber during firing and sintering processes. At high temperatures volatile ingredients can affect system components and reduce their lifetime significantly. In particular, take this into account when using glazing material and colorants for zirconium.

- Always observe the application instructions.
- Use only cycles that are approved by the manufacturer.
- Contact your ceramics manufacturer when you are unsure or have questions.

#### **Lift noise**

After switching on the firing furnace, the lift moves down and performs automatic lift calibration. The brief buzzing noise is due to technical reasons and is completely normal. Please note that the firing furnace does not react to any commands during this calibration time.

#### **Save energy**

Close the firing chamber in the event of prolonged breaks between firings. This will save energy and avoid unnecessary wear on the heating element and unnecessary warming of the lid.

#### **Condensation**

Close the firing chamber before switching off the furnace to avoid unnecessary condensation in the firing furnace.

### 6.5.2. Heating element

The heating elements are wear-sensitive parts, whose service life depends on how much it is used. Running the check program regularly makes it easier to identify the correct time to replace a heating element. Another way of identifying heating element wear is visual inspection. Look into the open firing chamber from below while the firing furnace is switched off and cold. If the heating strips are deformed or there is strong glass formation, the heating element should be replaced.

### 6.5.3. Thermocouple - temperature calibration

The thermocouples are wear-sensitive parts, whose service life depends on how much they are used. Visually inspect the thermocouples regularly - particularly before temperature calibration - while the firing furnace is cold and switched off and the firing chamber is open. A mirror held at an angle under the firing chamber can be very helpful. The thermocouples jut out into the firing chamber. Ensure that they are not bent since this influences temperature measurement and hence the firing results.



#### 6.5.4. Programming and program steps

**Drying the firing object**

The insulation table is still very hot immediately after firing. The temperature near the firing object may thus be too high for drying. Wait a few minutes until the insulation table has cooled down before placing the new firing object on the sinter plate for drying.

#### 6.5.5. Firing programs

**Firing tray and kiln furniture**

Every type of firing tray and kiln furniture has an effect on the temperature of the firing object due to its color and composition. Using a standardized firing tray can thus ensure constant firing results. Ensure the quality of the firing tray and kiln furniture. Deformation at high temperatures, minimum shrinkage and thermal shock resistance are parameters affecting quality.

**Firing parameters and test firings**

Care in creating firing programs and editing firing parameters has a significant effect on the quality of firing results. The recommended firing parameters are thus to be seen only as guidelines. Perform test firings to identify your individual firing parameters based upon these guidelines.

## 6.6. Backing up and restoring firing programs

**NOTE:**

**Backing up the data by using the Backup/Recovery function in the "Setup" menu saves also the firing programs in the local memory of the firing furnace control. See section 6.7.**

For reasons of data security and to prevent the loss of firing programs, it is recommendable to regularly back up your firing programs. Therefore, you should save your data on two different storage media. At least you should write down your firing program parameters on paper or print them out.

Use the "Copy" and "Paste" function of the program manager for backing up individual sets and firing programs. See section 5.3.

**Backing up firing programs**

Copy the sets and firing programs (source) to the backup storage (target).

For example, you can copy the firing programs on the local memory of the firing furnace control to a USB stick (USB interface at the firing furnace rear side).

**Restoring firing programs**

Copy the backed-up sets and firing programs (source) to the original storage (target).

For example, you can copy the backed-up firing programs on a USB stick to the local memory of the firing furnace control.

## 6.7. Backing up and restoring data

You can back up or restore all the data for the firing furnace control (used operating systems, software, set parameters and firing programs) with the backup/recovery function of the "Setup" menu". See section 5.7.3.5.

**NOTE:**

**For reasons of data security and to prevent the loss of firing furnace data, it is recommendable to regularly back up all your data.**

## 6.8. Loading sets and firing programs

A "set" is a group of all manufacturer-related programs. The AUSTROMAT™ can access sets and firing programs on the following sources:

- "Local". The sets and firing programs are stored on the local memory of the firing furnace control. See section 6.8.1,
- "USB". The sets and firing programs are stored on a USB stick. See section 6.8.2,
- "Internet". The sets and firing programs are stored on the DEKEMA server. See section 6.8.3,
- "Circle". The sets and firing programs in the Circle. See section 6.8.4,
- "FTP Server". The sets and firing programs are stored on an FTP server. See section 6.8.5.

### 6.8.1. Sets and programs on the local memory

You can access the sets and firing programs on the local memory of the firing furnace control at any time. Proceed as follows to load an individual firing program from the internal memory of the firing furnace.

1. Open the Program Manager.
2. Tap the "Local" storage area. The set list displays all sets that are saved on the local memory of the firing furnace control.



Fig. 6-3 Program Manager: local sets

3. Tap on the desired set in the set list. The program list displays all firing programs in this set.
4. Tap on the desired firing program in the program list. The program display appears. See section 5.4.

You can start or edit the firing program.

### 6.8.2. Sets and programs on a USB stick

You can access the sets and firing programs on a USB stick when it is plugged in the interface at the firing furnace backside. Proceed as follows to load an individual firing program from the USB stick.

1. Open the Program Manager.
2. Tap the "USB" storage area. The set list displays all sets that are saved on the USB stick. See also Fig. 6-3.
3. Tap on the desired set in the set list. The program list displays all firing programs in this set.
4. Tap on the desired firing program in the program list. The program display appears. See section 5.4.

You can start or edit the firing program.

### 6.8.3. Sets and programs from the Internet

You can access the sets and firing programs on the DEKEMA server when the firing furnace is connected with the internet. See section 5.7.1.5. Proceed as follows to load an individual firing program from the DEKEMA server.

1. Open the Program Manager.
2. Tap the "Internet" storage area. Only "Classic" programs are available via Internet.
3. The set list displays all sets that are saved on the DEKEMA server. See also Fig. 6-3.
4. Tap on the desired set in the set list. The program list displays all firing programs in this set.
5. Tap on the desired firing program in the program list. The program display appears. See section 5.4.

You can start or edit the firing program.

## 6.8.4. Sets and programs in the Circle

**NOTE:**

**The circle may contain programs, that your firing furnace type cannot process. You can only view but not start and edit these programs.**

You can access the sets and firing programs in the circle when the firing furnace is connected with the circle. See section 5.7.3.6. Proceed as follows to load an individual firing program from the circle.

1. Open the Program Manager.
2. Tap the "Circle" storage area. The set list displays all sets that are saved in the circle. See also Fig. 6-3.
3. Tap on the desired set in the set list. The program list displays all firing programs in this set.
4. Tap on the desired firing program in the program list. The program display appears. See section 5.4.

You can start or edit the firing program.

## 6.8.5. Sets and programs from an FTP Server

You can access the sets and firing programs on an FTP server when the firing furnace is connected with the FTP server. Proceed as follows to load an individual firing program from the FTP server.

1. Open the Program Manager.
2. Tap the "FTP Server" storage area. The set list displays all sets that are saved on the FTP server. See also Fig. 6-3.
3. Tap on the desired set in the set list. The program list displays all firing programs in this set.
4. Tap on the desired firing program in the program list. The program display appears. See section 5.4.

You can start or edit the firing program.

## 6.9. Access the firing furnace via FTP

**NOTE:**

Consult your network administrator if you are uncertain.

**NOTE:**

Several programs can be used to access an FTP site including a web browser like Internet Explorer. The following procedure describes how to create an FTP connection between a computer and the firing furnace.

The computer and firing furnace have to be connected via an Ethernet connection.

1. Start Windows Explorer on the computer.
2. In the address line of Windows Explorer, enter the IP address of the firing furnace ("http://192.168.2.109" in the following example), and press the Enter key.

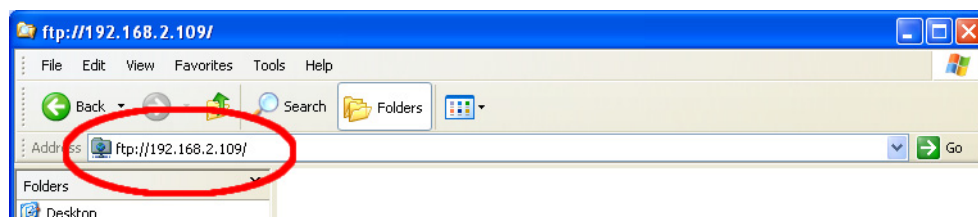

Fig. 6-4 Enter the IP address in Windows Explorer (example)

**NOTE:**

For immediate access, you can enter the complete FTP address for the firing furnace. An FTP address such as "ftp://ftp\_username:ftp\_PWD@IP\_address" is composed of the following elements (observe the separators between the individual elements):

- The network protocol "ftp",
- the username "ftp\_username" and password "ftp\_PWD" for FTP access to the firing furnace,
- the IP address "IP\_address" of the firing furnace in the network. See section 4.5.1.

3. An error message appears (FTP folder error) because the firing furnace is password-protected. Click [OK] to confirm the error message.
4. Open the context menu (right click) in the empty window of Windows Explorer. Select "Login as...".

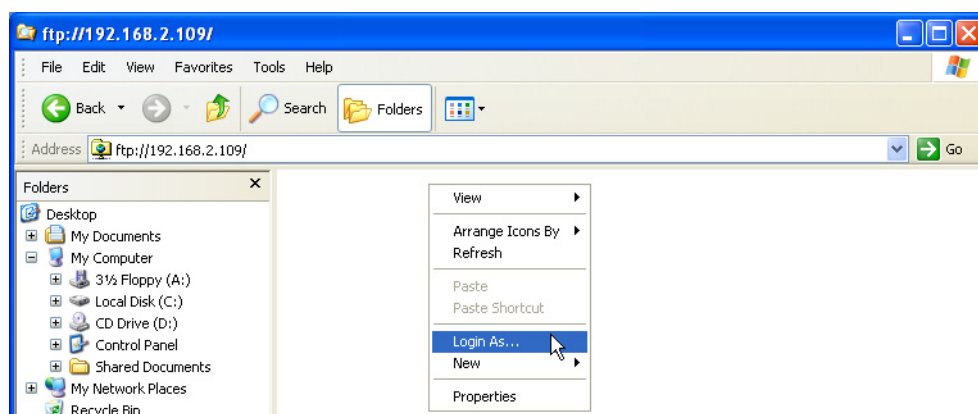

Fig. 6-5 Logging into the firing furnace

5. The window “Login as” appears.
  - Enter your user name for FTP access to the firing furnace,
  - Enter the corresponding FTP password.

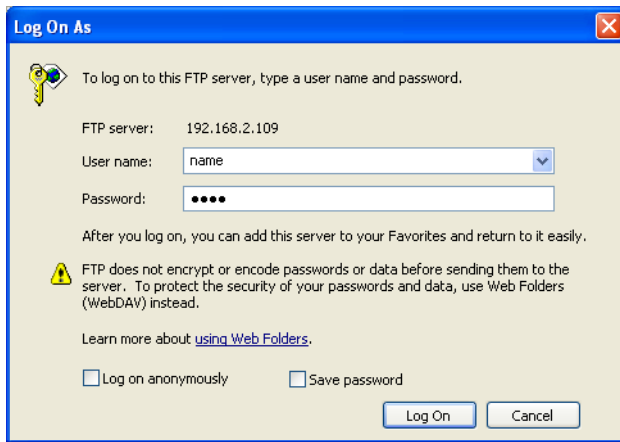

Fig. 6-6 Enter username and password

6. Click on [Log On].
7. After you have logged in, Windows Explorer shows the memory of the firing furnace.

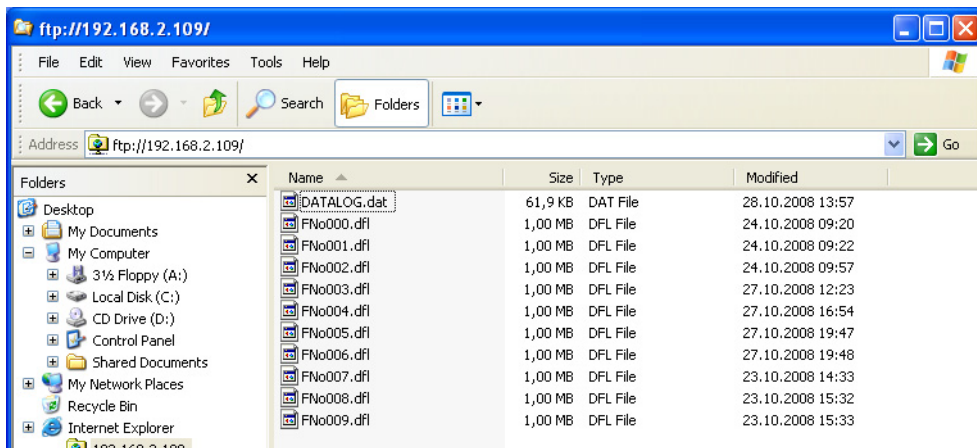

Fig. 6-7 Memory of the firing furnace in Windows Explorer

8. You can move, delete, etc. files in Windows Explorer as usual.
- Close Windows Explorer when you no longer need FTP access to the firing furnace.

## 6.10. Quality assurance

### 6.10.1. QM logs

The AUSTROMAT™ allows you to log a completed firing program for quality assurance documentation.

The log is internally fixed and cannot be changed by the user. The log monitors and documents the progress of the set program, especially the target and actual values of the Firing parameters , as well as fluctuations in temperature during the holding periods (only when the firing chamber is closed).

A precise description of quality management can be found in section 5.7.3.2.

Example of a log:

QM record:	
Firing no.:	# 0000000019
Firing program:	
Program no.:	006
Program name:	test
Start date:	13.02.2017
Start time:	12:45:35
Finish date:	13.02.2017
Finish time:	12:46:28
Duration of firing:	00:00:54
Program sequence:	C0 L0 L9 L0
Lab information:	
Order no.:	
Type of work:	
Furnace data:	
Furnace id:	123
Last check program:	01.01.00
Temperature calibration:	1000
Firing completed correctly	
ESC ⊗	

Fig. 6-8 QM log



### 6.10.2. X-Dream (optional)

**NOTE:**

The requirements for using X-DREAM™ are:

- X-DREAM™ is installed on the computer,
- the firing furnace is configured for a network connection,
- the firing furnace is configured for access via an FTP server.

The optional X-DREAM™ program ("Extended DEKEMA Remote Access Management") offers an additional level of quality management for firing furnaces:

- Handling dfl files,
- Querying the status of the firing furnace via a computer using QM information,
- Automatically sending QM logs by e-mail.

Start X-DREAM™ (for example by double-clicking the program name "X-DREAM\_v20.exe"). The following window offers an example.

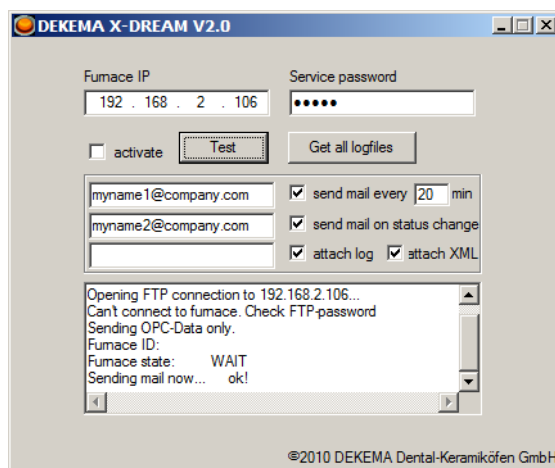

Fig. 6-9 Example of X-DREAM

For additional information, please contact DEKEMA. See section 7.6.

### 6.10.3. OPC (optional)

**NOTE:**

The requirements for using OPC are:

- OPC is installed on the computer,
- the firing furnace is configured for a network connection,
- the firing furnace is configured for access via an FTP server.

OPC ("OLE for Process Control") is a standardized software interface that allows you to exchange data between applications by different manufacturers.

By using the optional OPC program by DEKEMA, you can integrate quality management for the firing furnace into an ERP system ("enterprise resource planning").

For additional information, please contact DEKEMA (see section 7.6).

## 6.11. After a power failure



**NOTE:**

**If a running program is interrupted by a temporary power failure (less than 2 hours), the firing furnace attempts to properly terminate the program when the power comes back on. The quality of the firing results is not guaranteed in this case. Make sure to take particular care to inspect the firing results.**

After a power failure, the control remembers the status of the firing furnace at the time of the interruption for up to two hours.

- If the power comes back on within two hours, the firing furnace returns to the status at the time of the power failure. A firing program is continued if the temperature drop in the firing chamber does not exceed 150 °C.
- Otherwise, the AUSTROMAT™ asks you if you want to continue the program.

## 7. Maintenance and Service

	 <b>WARNING</b>
	<p><b>Non-original spare parts.</b></p> <p><b>Malfunctions can arise if third-party parts are used. In certain circumstances, this can cause serious injury and substantial property damage.</b></p> <p><b>Always use original spare parts from DEKEMA</b></p>

**NOTE:**

**When performing all maintenance and service tasks, maintenance and service tasks observe section 2, Safety.**

If technical servicing or repairs are necessary, they should only be performed by authorized professionals.

**NOTE:**

**After the ceramic furnace has been restored to operation, check for safety:**

- **Federal Republic of Germany: VDE 0701**
- **International: According to the legal requirements of your own country.**

### 7.1. Care

**NOTE:**

**Before each maintenance and service task: Read section 2, Safety. In particular, be aware of the hazards listed in section 2.4.**

- Clean the housing and control elements with a soft cloth moistened with a mild cleanser. Do not use scouring agents, scouring pads or solvents such as alcohol, gasoline or acetone.
- Always keep the sealing ring of the lift seat free of dust to ensure a reliable seal. Use a brush with a receptacle (for ceramic dust), or a moist cloth.

## 7.2. Calibrate temperature

**NOTE:**

**Before each maintenance and service task: Read section 2, Safety. In particular, be aware of the hazards listed in section 2.4.**

**Required auxiliaries**

- DEKEMA calibration set, including PTC ring and calibration table,
- Caliper gauge, measurement accuracy better than  $\pm 0.01$  mm (= 10  $\mu$ m).

A number of factors influence the temperature of the firing object. These can include: The color and shape of the firing tray, or the number and type of firing objects. Other major influences can be age-related effects such as heating element wear and changes to the thermoelectric properties of the temperature sensor. We therefore recommend calibrating the temperature of the firing furnace to adapt these factors and achieve the desired firing results. Calibrate the temperature whenever the firing results are inconsistent and at least once annually. Calibration is carried out by means of the calibration factor (CCF). Observe the following instructions:

- For new furnaces, we recommend that you calibrate the temperature for the first time after approximately six months.
- Make sure that the heating element and thermocouples are not damaged.
- Only use the DEKEMA calibration set that is for the specific furnace (part of the scope of delivery). This consists of a PTC ring and a ring-specific calibration table.
- For calibration, always use the sinter plate!
- Note that the temperatures of all the firing programs are adjusted when the CCF value changes. The firing temperatures of individual programs may have to be corrected.

**Calibrating the temperature with the calibration set:**

1. The firing furnace must be thoroughly preheated before calibrating.
2. Place the PTC ring of the DEKEMA calibration set on the center of the sinter plate.

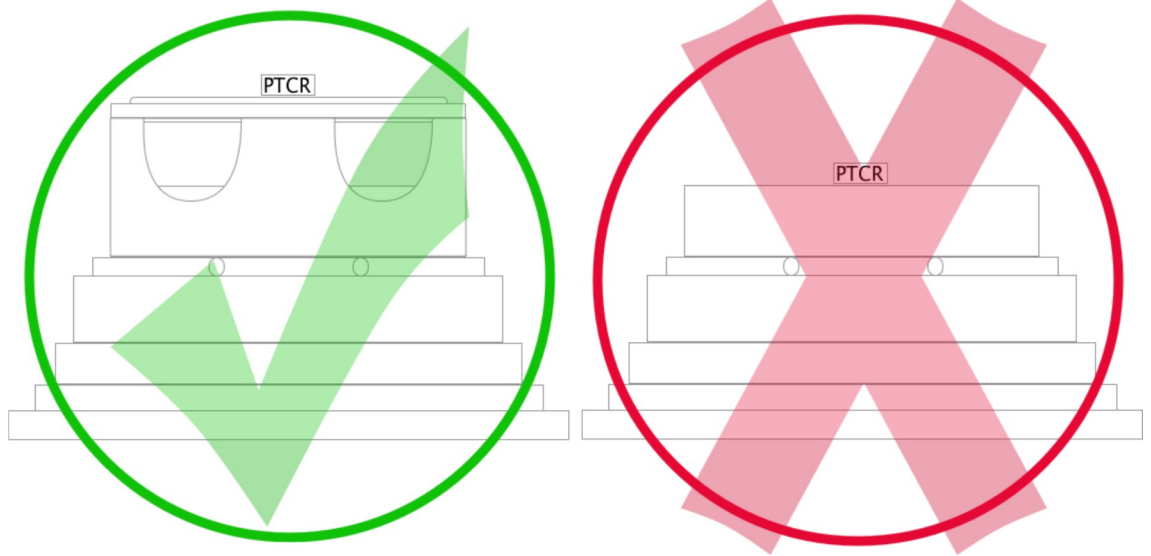

Fig. 7-1 Centering the PTC ring on the sinter plate. See also Fig. 6-1.

3. Start the temperature calibration program:  
In the "Setup" menu, select the program "Temperature calibration", and press [Start]. See section 5.7.2.4.

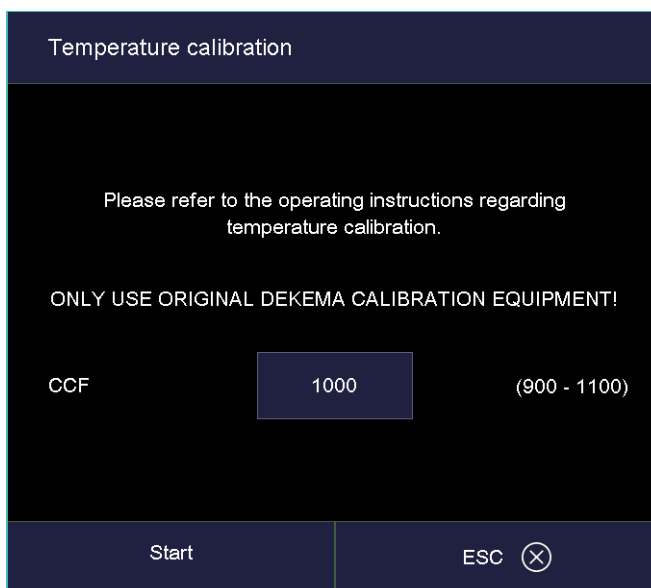

Fig. 7-2 Starting the temperature calibration

4. When the program is finished let the sintered PTC ring cool down on the sinter plate.
5. Use an appropriate auxiliary tool, e.g. tweezers, or wear safety gloves when removing the PTC ring. Place the PTC ring (cooled down to room temperature) on a clean even surface.

**NOTE:**

**In order to exactly determine the diameter it is recommended to forward the sintered PTC ring to your service partner or to DEKEMA.**

6. Use a caliper gauge in order to determine the diameter of the sintered PTC ring.
  - The measurement accuracy must be better than  $\pm 0.01 \text{ mm}$  ( $= 10 \text{ }\mu\text{m}$ ). Otherwise, an exact evaluation and temperature calibration cannot be guaranteed.
  - Measure the diameter  $D$  between the two center digits of the three-digit batch number of the PTC ring (for example, the "2" digits in the following figure).

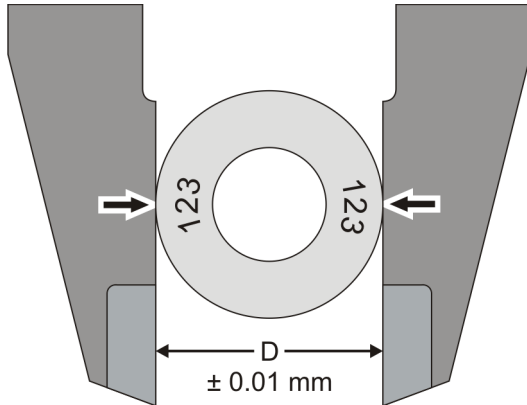

Fig. 7-3 Measuring the diameter of the sintered PTC ring

7. Compare the measured diameter  $D$  with the values given in the ring-specific calibration table: The corresponding table value shows the actual firing temperature.
8. Change the CCF value if the actual firing temperature deviates from the nominal temperature of  $1500 \text{ }^\circ\text{C}$ .

#### Changing the CCF

Proceed as follows to change the CCF:

1. In the "Setup" menu, select the program "Temperature calibration". See Fig. 7-2.
2. Tap on the input field for the CCF value. The numeric keyboard window "Calibration factor" appears, see following figure.

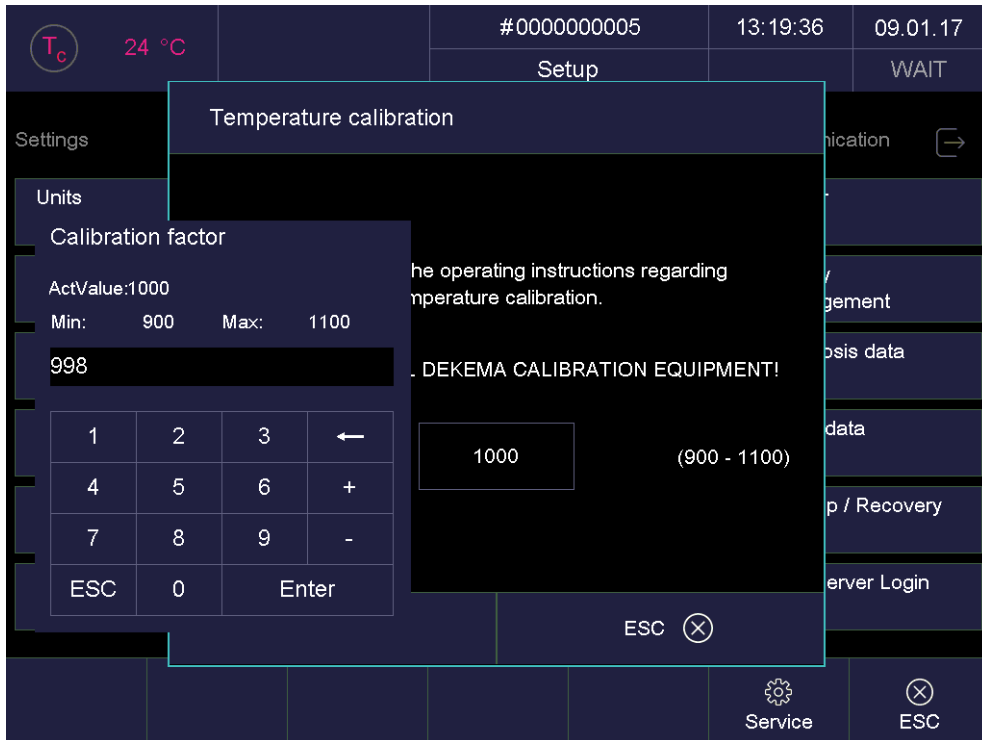

Fig. 7-4 Changing the CCF

3. Enter the new value for the CCF.
  - Increasing the CCF by one point results in an increase of the firing temperature by 1 °C,
  - Reducing the CCF by one point results in a decrease of the firing temperature by 1 °C.

If there are very large or sudden deviations from the original CCF, check for technical faults, and inform your service partner.

## 7.3. Check program

### NOTE:

**Start the check program only after running several firing programs, or after a cleaning firing so that the firing furnace is warmed up.**

The AUSTROMAT™ has an internal program, the check program, that checks the function of the major components: the check program. Regularly running in this unchangeable program makes it easier on you and the responsible service personnel

- to identify old components such as heating element wear,
- and eliminates malfunctions.

### Start check program

After approximately 500 firings, the device will display a recommendation on the screen to start the self-check program (this takes approximately 180 minutes).

In the "Setup" menu, select the program "Check program", and press [Start]. See section 5.7.2.2.

### Results of the check program

The results of the self-check are saved in a diagnosis file (see section 5.7.3.3). If the diagnostic data reveal that a firing program may not be able to be processed correctly, then the AUSTROMAT™ automatically points this out when a firing program is started. This is the case for example when the heating element is too old, and you want to reach a firing temperature quickly.

### Error messages after running the check program

Error messages	Measures
1. "NO ERRORS FOUND"	No errors were found.
2. "CHANGE HEATING ELEMENT"	Contact your service partner (see section 7.6).

Tab. 7-1

Overview of error messages

The error message "CHANGE HEATING ELEMENT" can also arise when the heating element is technically functional. However, the check program requires a nominal power supply to operate. When the power supply is below the nominal value, the error diagnosis of the heating element can be incorrect. This problem generally only occurs in Asian countries. Consult your local power company.



## 7.4. Change the heating element

**NOTE:**

**Before each maintenance and service task: Read section 2, Safety. In particular, be aware of the hazards listed in section 2.4.**

**NOTE:**

**If technical servicing or repairs are necessary, they should only be performed by authorized professionals (see section 7.6).**

Over time, the heating element wears out from use. This can have a negative influence on your firing results. For this reason, change the heating element at the proper time. If the self-check program is run regularly (see section 7.3), a recommendation will be displayed when the heating element wear exceeds the permissible limit. Follow the accompanying installation and safety instructions in section 2 to install the replacement heating element. Heating elements should only be replaced by trained professionals.

## 7.5. Software update

Contact DEKEMA to update the software program for your firing furnace. An update can be obtained in the following ways:

- by mail on a USB stick,
- by e-mail,
- by online update. See section 5.7.3.5.

The mail deliveries come with detailed step-by-step instructions to install the program update (on paper or in a PDF file).

## 7.6. Service and Transport

**NOTE:**

**Before each maintenance and service task: Read section 2, Safety. In particular, be aware of the hazards listed in section 2.4.**

**NOTE:**

**These operating instructions are part of the documentation for the AUSTROMAT™ firing furnace. Read the service instructions before servicing.**

**Service partners**

We recommend regular maintenance of the firing furnace by your service partner. This will ensure superior firing results. Contact the responsible service partner if you need to replace wearing parts or if the firing furnace needs further repairs.

**Spare parts**

Only use original DEKEMA parts for servicing and maintaining the firing furnace. Contact your service partner, or contact DEKEMA directly.

**Manufacturer address**

Please direct any questions for the manufacturer to the following address:

DEKEMA Dental-Keramiköfen GmbH  
Industriestrasse 22  
D-83395 Freilassing  
Tel. +49-8654-4639-0  
Fax +49-8654-66195  
E-mail: [info@dekema.com](mailto:info@dekema.com)  
Website: [www.dekema.com](http://www.dekema.com)

**Transport**

- Turn off to the firing furnace as described in section 8.1.
- To transport the firing furnace, only use the original box and the supplied packaging material.

## 8. Storage and disposal

### 8.1. Storage

#### Turn off the firing furnace

	<b>⚠ WARNING</b>
	<p><b>Fire hazard.</b></p> <p><b>A fire hazard exists when the firing furnace is hot when packaged.</b></p> <p><b>Let the firing furnace cool for several hours to room temperature with the firing chamber open after turning it off.</b></p>

Proceed as follows:

1. Turn the firing furnace off, and let it cool to room temperature. Note that the device needs several hours to cool down.
2. Turn the firing furnace on, and move the insulation table up to close the firing chamber.
3. Turn the device off, and fold the power cable from the plug.

#### **Storage Requirements**

The firing furnace may only be stored in the original packaging. Observe the packaging symbols (see Fig. 4-1), and maintain the storage conditions in section 1.6.

## 8.2. Disposal

### 8.2.1. Personnel qualifications

The operator can recycle or dispose the AUSTROMAT™ in accordance with legal provisions. A good knowledge of mechanics and how to differentiate between waste materials is required to properly disassemble the AUSTROMAT™ and separate the materials.

### 8.2.2. Legal guidelines

#### **Responsibilities**

The owner is responsible for proper disposal of the AUSTROMAT™. The owner can give the firing furnace to a licensed private or public collection facility, or the owner can recycle or dispose of the firing furnace himself.

#### **NOTE:**

**If the owner gives the AUSTROMAT™ to a recycling facility, he must also provide the instructions for use. The operating instructions contain all the important instructions for disposal of the firing furnace.**

#### **Obligation to report**

Companies that dispose of or recycle their own waste are subject to official approval and inspection. Under certain circumstances, they can be freed from the approval requirement if they take the requirements of environment protection into account. These companies are subjected to a reporting requirement. You can find out more information at the responsible office for environmental protection.

#### **Environmental protection requirements**

Wastes must be recycled or disposed of in such a manner that it does not pose a hazard to human health. Only those procedures or methods may be used that do not harm the environment. In particular, care must be taken that:

- The air, water and earth are not contaminated,
- Animals and vegetable life are not endangered,
- No excessive noise or odor arises,
- The surroundings and the landscape are not impaired.

#### **Sort**

After the firing furnace has been disassembled, the individual parts must be sorted into waste groups. This is done according to the list in the current European Waste Catalog (EWC) or comparable documents. The EWC catalog applies for waste independent of whether it is disposed or recycled.

### 8.2.3. Disposal: Electrical and electronic materials

#### WEEE

The European Commission has issued a directive on the disposal of electrical and electronic materials (WEEE; 2002/96/EC). According to this directive, manufacturers have been responsible since August 2005 for returning and recycling electronic and electrical devices if no exception has been granted. As a manufacturer of laboratory equipment, DEKEMA Dental-Keramiköfen GmbH is freed from this requirement. Dental ceramic furnaces do not have to be returned to DEKEMA Dental-Keramiköfen GmbH.

	<b>⚠ CAUTION</b>
	<p><b>Electrical and electronic materials</b></p> <p><b>Electrical and electronic materials can negatively influence the environment.</b></p> <p><b>Do not treat electrical and electronic trails as unsorted garbage. Collect old electrical and electronic devices separately.</b></p>

### 8.2.4. Disposal: Other assemblies and components

The components of the AUSTROMAT™ are composed of the following materials:

- Metals and alloys
  - Aluminum (housing, cover panels, etc.)
  - Copper (cooling plates, electrical lines)
  - Steel (sections, fastening materials such as screws, etc.)
  - High-grade steel
- Glass and ceramic materials
  - Glass (screens and displays)
  - Ceramic insulation material (insulation table, firing chamber)
- Plastics and rubber
  - Plastics (hoses, covers, wheels, etc.)
  - Rubber (seals, silicone hoses)
- Composites
  - Electrical materials (cables, motors, components)
  - Electronic materials (printed circuit boards, computer, printer)
- Packaging
  - Styrofoam (cushion material)
  - Plastic (films)

## 9. Safety data sheets

The relevant safety data sheets for the AUSTROMAT™ 664i™ / 674i™ firing furnace are on the following pages.

- For "Altraform" material, see section 9.1,
- For "Kerform" material, see section 9.2.
- For "Isolrath" (Super-Isol) material, see section 9.3.

## 9.1. "Altraform" safety data sheet



### Safety Data Sheet

in dependence of regulation 1907/2006

#### Altraform

Print date: 31.07.2015

Product code: 012

Page 1 of 6

### SECTION 1: Identification of the substance/mixture and of the company/undertaking

#### 1.1. Product identifier

Altraform

#### Further trade names

Altraform KVF, Altraform KVR, Altraform KVS, Altraform KVS-SiC

#### 1.2. Relevant identified uses of the substance or mixture and uses advised against

##### Use of the substance/mixture

The following list describes in broad terms actual and potential use categories of Altra:

- High temperature insulation (HTI): Industrial (eg iron & steel, petrochemical, glass, ceramics), Aerospace, Power generation.
- Reinforcement of various matrices for a variety of specialty and industrial applications: Metals (eg. light alloys in industrial and automotive components), Ceramics and glasses, Plastics.
- Thermal insulation and mechanical support in emission control systems used in plant and vehicles in various industries, for example: Automotive, SUV, Agricultural, Power generation, Marine.
- Acoustic insulation
- Filtration: High temperature gas filtration devices used for industrial and automotive emission control, Water purification systems.
- Support material for precious metal catalysts in industrial and domestic flameless heaters and driers.

#### 1.3. Details of the supplier of the safety data sheet

Company name:	Chamottewaren- und Thonöfenfabrik Aug. Rath jun. GmbH	
Street:	Hafnerstraße 3	
Place:	A-3375 Krummnußbaum	
Telephone:	+43 (2757) 2401 - 0	Telefax: +43 (2757) 2401 - 86
e-mail:	sdb@rath-group.com	
Internet:	www.rath-group.com	
Responsible Department:	Labor	

**1.4. Emergency telephone number:** +43 (2757) 2401 - 0  
This number is serviced during office hours.

### SECTION 2: Hazards identification

#### 2.1. Classification of the substance or mixture

##### Classification according to Directive 67/548/EEC or 1999/45/EC

This mixture is not classified as hazardous according to Directive 1999/45/EC.

##### Classification according to Regulation (EC) No. 1272/2008 [CLP]

This mixture is not classified as hazardous according to Regulation (EC) No. 1272/2008.

#### 2.2. Label elements

##### Special labelling of certain mixtures

Restricted to professional users.

### SECTION 3: Composition/information on ingredients

#### 3.2. Mixtures

##### Chemical characterization

Refractory shape based on polycrystalline alumina wool with colloidal silica bonding and/without organic bonding



## Safety Data Sheet

in dependence of regulation 1907/2006

### Altraform

Print date: 31.07.2015

Product code: 012

Page 2 of 6

#### Hazardous components

EC No	Chemical name	Quantity
CAS No	Classification according to Directive 67/548/EEC	
Index No	Classification according to Regulation (EC) No. 1272/2008 [CLP]	
REACH No		
614-074-2	Polycrystalline alumina wool	< 90 %
675106-31-7		
01-2119456884-25		

Full text of R-, H- and EUH-phrases: see section 16.

#### SECTION 4: First aid measures

##### 4.1. Description of first aid measures

###### General information

Repeated, extensive dust exposure may cause pneumoconiosis.

###### After inhalation

Provide fresh air.

###### After contact with skin

Subsequently wash off with: Water.

If skin irritation or rash occurs: Get medical advice/attention.

Affected organs: skin contact. Do not subject to friction.

Change contaminated clothing. Subsequently wash off with: Water (with cleaning agent).

###### After contact with eyes

If product gets into the eye, keep eyelid open and rinse immediately with large quantities of water, for at least 5 minutes. Subsequently consult an ophthalmologist.

Following eye contact: Do not subject to friction.

###### After ingestion

Rinse mouth thoroughly with water.

#### SECTION 5: Firefighting measures

##### 5.1. Extinguishing media

###### Suitable extinguishing media

Co-ordinate fire-fighting measures to the fire surroundings.

##### 5.3. Advice for firefighters

Use appropriate respiratory protection. (FFP2)

In the case of the formation of dust. Long Term (repeated)/Long Term (continuous): FFP3/Wear a self-contained breathing apparatus and chemical protective clothing.

#### SECTION 6: Accidental release measures

##### 6.1. Personal precautions, protective equipment and emergency procedures

Wear personal protection equipment.

Provide adequate ventilation.

##### 6.2. Environmental precautions

Do not allow to enter into surface water or drains.

##### 6.3. Methods and material for containment and cleaning up

Use approved industrial vacuum cleaner for removal. High efficiency particulate air filter (HEPA filter).

Do not use a dry brush as dust clouds or static can be created. Knock down dust with water spray jet.

Do not use a brush or compressed air for cleaning surfaces or clothing.





## Safety Data Sheet

in dependence of regulation 1907/2006

### Altraform

Print date: 31.07.2015

Product code: 012

Page 3 of 6

#### 6.4. Reference to other sections

Avoid generation of dust.

### SECTION 7: Handling and storage

#### 7.1. Precautions for safe handling

##### **Advice on safe handling**

Avoid generation of dust.  
Provide adequate ventilation as well as local exhaust at critical locations.

#### 7.2. Conditions for safe storage, including any incompatibilities

##### **Requirements for storage rooms and vessels**

Requirements for storerooms and containers: Keep the packing dry and well sealed to prevent contamination and absorption of humidity.  
Protect containers against damage.

##### **Advice on storage compatibility**

No special handling instructions are necessary.

##### **Further information on storage conditions**

Keep container dry. Store in a cool dry place.  
Protect from moisture.

#### 7.3. Specific end use(s)

Observe technical data sheet.

### SECTION 8: Exposure controls/personal protection

#### 8.1. Control parameters

##### **Exposure limits (EH40)**

CAS No	Substance	ppm	mg/m <sup>3</sup>	fibres/ml	Category	Origin
1344-28-1	Aluminium oxides, respirable dust	-	4		TWA (8 h)	WEL
		-	-		STEL (15 min)	WEL
409-21-2	Silicon carbide (not whiskers), respirable	-	4		TWA (8 h)	WEL
		-	-		STEL (15 min)	WEL
9005-25-8	Starch, respirable	-	4		TWA (8 h)	WEL
		-	-		STEL (15 min)	WEL

#### 8.2. Exposure controls

##### **Appropriate engineering controls**

If handled uncovered, arrangements with local exhaust ventilation have to be used. Do not breathe dust.

##### **Protective and hygiene measures**

Change contaminated clothing. Used working clothes should not be worn outside the work area. Separate storage of work clothes.  
Wash hands before breaks and after work.  
Do not eat, drink, smoke or sneeze at the workplace.  
Avoid contact with skin, eyes and clothes.

##### **Eye/face protection**

Respiratory protection: FFP2  
Protective respiration apparatus not using surrounding air (breathing apparatus) (DIN EN 133).

##### **Hand protection**

Tested protective gloves are to be worn:



## Safety Data Sheet

in dependence of regulation 1907/2006

### Altraform

Print date: 31.07.2015

Product code: 012

Page 4 of 6

Suitable gloves type: Natural fibres (e.g. cotton) Wear cotton undermitten if possible.

#### Skin protection

Only wear fitting, comfortable and clean protective clothing.

#### Respiratory protection

Respiratory protection:/Recommended breathing protection brand: FFP2

In the case of the formation of dust. Long Term (repeated)/Long Term (continuous): FFP3/Protective respiration apparatus not using surrounding air (breathing apparatus) (DIN EN 133).

#### Environmental exposure controls

Collect in closed containers for disposal.

## SECTION 9: Physical and chemical properties

### 9.1. Information on basic physical and chemical properties

Physical state: solid  
 Colour: white  
 Odour: odourless

#### Test method

pH-Value: not applicable

#### Changes in the physical state

Melting point: > 1650 °C

Initial boiling point and boiling range: not applicable

Flash point: not applicable

#### Flammability

Solid: not applicable

#### Explosive properties

not applicable

#### Auto-ignition temperature

Solid: not applicable

Vapour pressure: not applicable

Density: not applicable

Water solubility: < 0.001 g/L

Partition coefficient: not applicable

### 9.2. Other information

## SECTION 10: Stability and reactivity

### 10.6. Hazardous decomposition products

Thermal decomposition: organic bonding

## SECTION 11: Toxicological information

### 11.1. Information on toxicological effects

#### Irritation and corrosivity

Irritant effect on the eye: Irritant.

Irritant effect on the skin: Irritant.

#### Carcinogenic/mutagenic/toxic effects for reproduction

The evaluation based on observed symptoms obtained from single or repeated inhalation toxicity animal tests.



## Safety Data Sheet

in dependence of regulation 1907/2006

### Altraform

Print date: 31.07.2015

Product code: 012

Page 5 of 6

#### Specific effects in experiment on an animal

Longterm animal experiment.: not determined  
No known symptoms to date.

### SECTION 12: Ecological information

#### 12.1. Toxicity

No risks worthy of mention. Please observe the information on the safety data sheet at all times.

#### Further information

The classification was carried out according to the calculation method of the Preparations Directive (1999/45/EC).

### SECTION 13: Disposal considerations

#### 13.1. Waste treatment methods

##### Advice on disposal

Dispose of waste according to applicable legislation.

##### Contaminated packaging

Non-contaminated packages may be recycled. Handle contaminated packages in the same way as the substance itself.

### SECTION 14: Transport information

#### Land transport (ADR/RID)

**14.2. UN proper shipping name:** No special handling instructions are necessary.

#### Inland waterways transport (ADN)

**14.2. UN proper shipping name:** No special handling instructions are necessary.

#### Marine transport (IMDG)

**14.2. UN proper shipping name:** No special handling instructions are necessary.

#### Air transport (ICAO)

**14.2. UN proper shipping name:** No special handling instructions are necessary.

#### 14.5. Environmental hazards

ENVIRONMENTALLY HAZARDOUS: no

### SECTION 15: Regulatory information

#### 15.1. Safety, health and environmental regulations/legislation specific for the substance or mixture

##### EU regulatory information

##### Additional information

The product is classified and labelled according to EC directives or corresponding national laws.

##### National regulatory information

Employment restrictions: Observe employment restrictions for young people. Observe employment restrictions for child bearing mothers and nursing.

Water contaminating class (D): 1 - slightly water contaminating

#### 15.2. Chemical safety assessment

For this substance a chemical safety assessment has been carried out.

### SECTION 16: Other information

#### Changes



## Safety Data Sheet

in dependence of regulation 1907/2006

### Altraform

Print date: 31.07.2015

Product code: 012

Page 6 of 6

The information presented herein is based on data considered to be accurate as of the date of preparation of this Safety Data Sheet. However, no warranty or representation, express or implied, is made as to the accuracy or completeness of the foregoing data and safety information, nor is any authorization given or implied to practice any patented invention without a license. In addition, no responsibility can be assumed by the vendor for any damage or injury resulting from abnormal use, from any failure to adhere to recommended practices, or from any hazards inherent in the nature of the product.

*(The data for the hazardous ingredients were taken respectively from the last version of the sub-contractor's safety data sheet.)*

## 9.2. "Kerform" safety data sheet



## Safety Data Sheet

based on Regulation (EC) No 1907/2006

## Kerform, Kerasetter, Kerheat

Print date: 16.06.2015

Page 1 of 12

## SECTION 1: Identification of the substance/mixture and of the company/undertaking

**Product identifier**

Kerform, Kerasetter, Kerheat

**Relevant identified uses of the substance or mixture and uses advised against****Use of the substance/mixture**

Use of the products is restricted to "professional users" for application as thermal insulation, heat shields, heat containment, gaskets and expansion joints at temperatures up to 1400°C in industrial furnaces, ovens, kilns, boilers and other process equipment and in the aerospace and automotive industries. Products are not intended for direct sale to the general public.

- Primary Use: Manufacture of fibre (refers to the initial production of the fibre and is therefore not relevant to the downstream user, secondary and tertiary use are relevant to users)
- Secondary Use: Conversion into wet and dry mixtures and articles (refer to section 8)
- Tertiary Use: Installation, removal (industrial and professional) / Maintenance and service life (industrial and professional) (refer to section 8)

**Uses advised against**

Do not use for injecting or spraying.

**Details of the supplier of the safety data sheet**

Company name:	Rath GmbH	
	Mönchengladbach	
Street:	Krefelderstrasse 680-682	
Place:	D-41066 Mönchengladbach	
Telephone:	+49 (2161) 9692 - 0	Telefax: +49 (2161) 9692 - 61
Contact person:	Heinz Wimmer	
e-mail:	heinz.wimmer@rath-group.com	
Internet:	www.rath-group.com	
<b>Emergency telephone:</b>	+49 (2161) 9692 - 12	
	This number is serviced during office hours.	

## SECTION 2: Hazards identification

**Classification of the substance or mixture**

Indications of danger : Toxic

R-phrases:

May cause cancer by inhalation.

**GHS classification**

Hazard categories:

Carcinogenicity: Carc. 1B

Hazard Statements:

May cause cancer by inhalation.

**Label elements**

Signal word:	Danger
Pictograms:	GHS08





## Safety Data Sheet

based on Regulation (EC) No 1907/2006

### Kerform, Kerasetter, Kerheat

Print date: 16.06.2015

Page 2 of 12

#### Hazard statements

H350i May cause cancer by inhalation.

#### Precautionary statements

P201 Obtain special instructions before use.  
 P202 Do not handle until all safety precautions have been read and understood.  
 P281 Use personal protective equipment as required.  
 P308+P313 IF exposed or concerned: Get medical advice/attention.  
 P405 Store locked up.

#### Special labelling of certain mixtures

Restricted to professional users.

#### Other hazards

The International Agency for Research on Cancer (IARC) reaffirmed in 2001 that group 2B ("possibly carcinogenic to humans") remains the appropriate classification for RCF/ASW. In accordance with 31st adaptation to Technical Progress of Directive 67/548/ECC as published 15th January 2009 the classification as "irritant" has been removed for all types of man made vitreous fibres (MMVFs). Mild mechanical irritation to skin, eyes and upper respiratory system may result from exposure. These effects are usually temporary.

### SECTION 3: Composition/information on ingredients

#### Mixtures

##### Chemical characterization

Refractory shape based on alumino-silicate wool.  
 None of the components are radioactive under the terms of European Directive Euratom 96/29.

##### Hazardous components

EC No	Chemical name	Quantity
CAS No	Classification	
Index No	GHS classification	
REACH No		
266-046-0	Alumino-silicate wools	> 10 %
142844-00-6	Carc. Cat. 2 R49	
	Carc. 1B; H350i	
01-2119458050-50		
231-668-3	sodium hypochlorite, solution ... % Cl active	< 0,2 %
7681-52-9	C, N R34-31-50	
017-011-00-1	Skin Corr. 1B, Aquatic Acute 1; H314 H400	

Full text of R- and H-phrases: see section 16.

### SECTION 4: First aid measures

#### Description of first aid measures

##### After inhalation

If nose or throat becomes irritated move to a dust free area, drink water and blow nose. If symptoms persist, seek medical advice.

##### After contact with skin

After contact with skin, wash immediately with plenty of water and soap.

##### After contact with eyes

Rinse immediately carefully and thoroughly with eye-bath or water. Do not subject to friction.

**Safety Data Sheet**

based on Regulation (EC) No 1907/2006

**Kerform, Kerasetter, Kerheat**

Print date: 16.06.2015

Page 3 of 12

**SECTION 5: Firefighting measures****Extinguishing media****Suitable extinguishing media**

Extinguishing materials should be selected according to the surrounding area.

**Additional information**

The product itself is not combustible. Packaging and surrounding materials may be combustible. Fire class: 0

**SECTION 6: Accidental release measures****Personal precautions, protective equipment and emergency procedures**

Avoid generation of dust. Wear personal protection equipment. Restrict access to the area to a minimum number of workers required.

**Environmental precautions**

Beat down dust with water spray. Do not empty into drains or the aquatic environment. Moreover, national legislation has to be observed!

**Methods and material for containment and cleaning up**Use approved industrial vacuum cleaner for removal. High efficiency particulate air filter (HEPA filter). Absorb wet solids or soak them up. Don't use a brush or compressed air for cleaning surfaces or clothing.  
Do not allow to be wind blown.**SECTION 7: Handling and storage****Precautions for safe handling****Advice on safe handling**

Avoid exposure - obtain special instructions before use.

In case of open handling equipment with built-in suction must be used. If suction of the immediate vicinity is impossible or insufficient, the entire working place must be sufficiently ventilated using appropriate machines.

Conditions to avoid: dust deposits

**Conditions for safe storage, including any incompatibilities****Requirements for storage rooms and vessels**

Keep/Store only in original container. Keep container tightly closed. Protect containers against damage.

Contaminated packing must be completely emptied and can be re-used following appropriate cleaning.

Packaging materials: Recyclable Cardboard and/or plastic films

**Specific end use(s)**

Specific use(s):

The product is intended for professional use.

**SECTION 8: Exposure controls/personal protection****Control parameters**





## Safety Data Sheet

based on Regulation (EC) No 1907/2006

### Kerform, Kerasetter, Kerheat

Print date: 16.06.2015

Page 4 of 12

#### Exposure limits (EH40)

CAS No	Chemical name	ml/m <sup>3</sup>	mg/m <sup>3</sup>	F/ml	Category	Origin
675106-31-7	Polycrystalline alumina wool			500000	TWA (8 h) STEL (15 min)	
1344-28-1	Aluminium oxides, respirable dust	-	4		TWA (8 h) STEL (15 min)	WEL WEL
-	Refractory Ceramic Fibres and Special Purpose Fibres	-	5	1	TWA (8 h) STEL (15 min)	WEL WEL
9005-25-8	Starch, respirable	-	4		TWA (8 h) STEL (15 min)	WEL WEL

#### Additional advice on limit values

The Scientific Committee on Occupational Exposure Limit Values (SCOEL) as set up by a Commission Decision (95/320/EC) have proposed an OEL for RCF/ASW of 0.3 f/ml.

DNEL/DMEL (DERIVED NO-EFFECT LEVEL/DERIVED MINIMAL EFFECT LEVEL) The calculation of DMELs for fibres alone is not possible; a precautionary value is assigned based on fibrosis. An inhalation DMEL of 0.5 mg/m<sup>3</sup> with an assessment factor of 25 can be calculated based on repeated dose toxicity, this value in the correct units would give a DMEL of 4 f/ml.

#### Exposure controls

##### Occupational exposure controls

United Kingdom: MDHS 59 specific for MMVF: "Man-made mineral fibre - Airborne number concentration by phase-contrast light microscopy" and MDHS 14/3 "General methods for sampling and gravimetric analysis of respirable and inhalable dust". World Health Organisation Geneva 1997 ISBN 92 4 154496 1.

##### Protective and hygiene measures

Review your application(s) and assess situations with the potential for dust release. The use of products specially tailored to your application(s) will help to control dust. Some products can be delivered ready for use to avoid further cutting or machining. Some could be pre-treated or packaged to minimise or avoid dust release during handling. Consult your supplier for further details. Designate work areas and restrict access to informed and trained workers. Use operating procedures that will limit dust production and exposure of workers.

Avoid generation of dust. Beat down dust with water spray. Take up dust-free and set down dust-free. High efficiency particulate air filter (HEPA filter).

##### Respiratory protection

For dust concentrations below the exposure limit value, RPE is not required but FFP2 respirators may be used on a voluntary basis. For short term operations where excursions are less than ten times the limit value, use FFP3 respirators. In case of higher concentrations or where the concentration is not known, please seek advice from your company and/or your supplier. You may also refer to the ECFIA code of practice available on the ECFIA's web site: [www.ecfia.eu](http://www.ecfia.eu)

##### Hand protection

Suitable gloves type: Chromate-free leather. Used working clothes should not be used outside the work area. Wash hands before breaks and at the end of work. Wash contaminated clothing prior to re-use. Street clothing should be stored separately from work clothing.

##### Eye protection

Tightly sealed safety glasses. Dust protection goggles.





## Safety Data Sheet

based on Regulation (EC) No 1907/2006

### Kerform, Kerasetter, Kerheat

Print date: 16.06.2015

Page 5 of 12

#### Skin protection

INFORMATION AND TRAINING OF WORKERS: This should include: The applications involving RCF/ASW-containing products; The potential risk to health resulting from the exposure to fibrous dust; The requirements regarding smoking, eating and drinking at the workplace; The requirements for protective equipment and clothing; The good working practices to limit dust release; The proper use of protective equipment.

#### Environmental exposure controls

RCF/ASW is inorganic, inert and stable and it is not soluble in water (solubility <1mg/litre) and as such does not pose a detrimental effect on the environment.  
Do not allow to be wind blown.



**Safety Data Sheet**

based on Regulation (EC) No 1907/2006

**Kerform, Kerasetter, Kerheat**

Print date: 16.06.2015

Page 6 of 12

**Table of Uses and Risk Management Measures (RMM)**

Intended use	RMM - Hierarchy of Controls
<p>Secondary use – Conversion into wet and dry mixtures and articles.</p> <p>Process would include: Mixing forming operations, handling of RCF/ASW products, assembly of RCF/ASW containing products, machine and hand finishing of RCF/ASW products.</p> <p>Reference ES 2</p>	<ul style="list-style-type: none"> <li>- Where it is practical to do so, automatically feed RCF/ASW in to the process</li> <li>- Where practical to do so, segregate dry and wet processing</li> <li>- Enclose the process where practically possible.</li> <li>- Where practical to do so, segregate machine areas and restrict access to operators involved in the process.</li> <li>- Enclose Machines as far as practically possible.</li> <li>- Install LEV where possible, when machine finishing, handling, compressing and hand cutting to remove dust at source</li> <li>- Employ experienced personnel – trained in the correct use of fibrous products</li> <li>- PPE and RPE used for all dusty tasks</li> <li>- Provide vacuum cleaner connection point to central system where practical or use a portable HEPA vacuum</li> <li>- Regular clean up – using a wet scrubbing unit where practically possible and in general a HEPA vacuum should be used.</li> <li>- Dry brushing and use of compressed air should be prohibited</li> <li>- Waste materials to be contained at source, labelled and stored separately for disposal or recycling.</li> </ul>
<p>Tertiary use - maintenance and service life (Industrial or professional use)</p> <p>Process: Small scale repairs involving removal and installation of RCF/ASW products. Use of the product in an enclosed system, where there is occasional control access or no access.</p> <p>Reference ES 3</p>	<ul style="list-style-type: none"> <li>- Use pre-cut, pre-sized pieces where practically possible.</li> <li>- Allow access only to trained (authorised ) operators</li> <li>- Where practically possible, perform all hand cutting in a segregated area, on a down draft bench.</li> <li>- Clean up work area regularly during the shift using a HEPA equipped vacuum cleaner.</li> <li>- Prohibit use of dry brushing and compressed air cleaning.</li> <li>- Bag and seal waste immediately at source.</li> <li>- Use PPE and RPE appropriate to task.</li> <li>- Employ good hygiene practices.</li> </ul>
<p>Tertiary use- installation and removal (industrial or professional).</p> <p>Large scale removal and installation of RCF/ASW from Industrial processes.</p> <p>Large scale removal and installation by professionals.</p> <p>Reference ES 4</p>	<ul style="list-style-type: none"> <li>- Where practically possible enclose or segregate the work area.</li> <li>- Allow only authorised personnel.</li> <li>- Pre-wet insulation prior to removal where practically possible.</li> <li>- Where practically possible use a water lance for removal or vacuum-truck.</li> <li>- Use down draft bench for hand cutting products.</li> <li>- Cover pre-cut section during transport and storage to prevent secondary exposure.</li> <li>- Where practically possible provide multiple vacuum hoses for convenient cleanup of spillage or use portable HEPA filtered vacuums.</li> <li>- Bag waste materials immediately at source</li> <li>- Prohibit use of dry brushing and or compressed air cleaning.</li> <li>- Experienced personnel only</li> <li>- Use appropriate PPE and RPE appropriate to expected concentrations</li> </ul>



## Safety Data Sheet

based on Regulation (EC) No 1907/2006

### Kerform, Kerasetter, Kerheat

Print date: 16.06.2015

Page 7 of 12

## SECTION 9: Physical and chemical properties

### Information on basic physical and chemical properties

Physical state:	solid	
Colour:	white	
Odour:	odourless	
pH-Value:		not applicable
Melting point:		> 1650 °C
Boiling point:		not applicable
Flash point:		not applicable
<b>Flammability</b>		
Solid:		not applicable
<b>Explosive properties</b>		
		not applicable
<b>Auto-ignition temperature</b>		
Solid:		not applicable
Vapour pressure:		not applicable
Density:		not applicable
Water solubility:		< 0.001 g/L
Partition coefficient:		not applicable

### Other information

Length weighted geometric mean diameter of fibres contained in the product: 1.3 - 4 µm

These fibres are dense materials and so will settle rapidly from both air and liquid.

## SECTION 10: Stability and reactivity

### Possibility of hazardous reactions

Contact with acids liberates very toxic gas. Formation of: Chlorine (Cl<sub>2</sub>).

### Conditions to avoid

Avoid generation of dust.

### Incompatible materials

No risks worthy of mention.

### Hazardous decomposition products

Upon heating above 900°C for sustained periods, this amorphous material can begin to transform to mixtures of crystalline phases. For further information please refer to Section 16.

## SECTION 11: Toxicological information

### Information on toxicological effects

#### **Toxicokinetics, metabolism and distribution**

Exposure is predominantly by inhalation or ingestion. Man made vitreous fibres of a similar size to RCF/ASW have not been shown to migrate from the lung and/or gut and do not become located in other parts of the body. When compared to many naturally occurring minerals, RCF/ASW has a low ability to persist and accumulate in the body (half-life of long fibres (> 20 µm) in 3 week rat inhalation test is approx. 60 days). Human Toxicological data: In order to determine possible human health effects following RCF exposure, the University of Cincinnati has been conducting medical surveillance studies on RCF workers in the U.S. The Institute of Occupational Medicine (IOM) has conducted



## Safety Data Sheet

based on Regulation (EC) No 1907/2006

### Kerform, Kerasetter, Kerheat

Print date: 16.06.2015

Page 8 of 12

medical surveillance studies on RCF workers in European manufacturing facilities.

Pulmonary morbidity studies among production workers in Europe and USA have demonstrated an absence of interstitial fibrosis and no decrement in lung function associated with current exposures, but have indicated a reduction of lung capacity among smokers. A statistically significant correlation between pleural plaques and cumulative RCF exposure was evidenced in the USA longitudinal study. The USA mortality study did not show evidence of increased lung tumour development either in the lung parenchyma or in the pleura.

#### Acute toxicity

Short term inhalation: No data available. Short term tests have been undertaken to determine fibre (bio) solubility rather than toxicity; repeat dose inhalation tests have been undertaken to determine chronic toxicity and carcinogenicity. - Oral: No data available. Repeated dose studies have been carried out using gavage. No effect was found.

#### Specific effects in experiment on an animal

Germ cell mutagenicity: Method: In vitro micronucleus test; Species: Hamster (CHO); Dose: 1-35 mg/ml; Routes of administration: In suspension; Results: Negative.

Carcinogenicity: Method: Inhalation. Multi-dose; Species: Rat; Dose: 3 mg/m<sup>3</sup>, 9 mg/m<sup>3</sup> and 16 mg/m<sup>3</sup>; Routes of administration: Nose only inhalation; Results: Fibrosis just reached significant levels at 16 and 9 mg/m<sup>3</sup> but not at 3 mg/m<sup>3</sup>. None of the parenchymal tumour incidences were higher than the historical control values for this strain of animal.

Method: Inhalation. Single dose; Species: Rat; Dose: 30 mg/m<sup>3</sup>; Routes of administration: Nose only inhalation; Results: Rats were exposed to a single concentration of 200 WHO fibres/ml specially prepared RCF for 24 months. High incidence of exposure-related pulmonary neoplasms (bronchoalveolar adenomas and carcinomas) were observed. A small number of mesotheliomas were observed in each of the fibre exposure groups (Mast et al 1995a).

Method: Inhalation. Single dose; Species: Hamster; Dose: 30 mg/m<sup>3</sup>; Routes of administration: Nose only inhalation; Results: Hamsters were exposed to a single concentration of 260 WHO fibres/ml specially prepared RCF for 18 months and developed lung fibrosis, a significant number of pleural mesotheliomas (42/102) but no primary lung tumours (McConnell et al 1995).

Method: Inhalation. Single dose; Species: Rat; Dose: RCF1: 130 F/ml and 50 mg/m<sup>3</sup> (25% of non fibrous particles) RCF1a: 125 F/ml and 26 mg/m<sup>3</sup> (2% of non fibrous particles); Routes of administration: Nose only inhalation Results: Rats were exposed to RCF1 and RCF1a for 3 weeks. The objective of the study was to compare lung retention and biological effects of the original RCF 1 compared to RCF1a. The main difference of these 2 samples was the non fibrous particle content of respectively 25% versus 2%. The post treatment observation was 12 months. Alveolar clearance was barely retarded after RCF1A exposure. After RCF1 exposure, however, a severe retardation of clearance was observed. (Bellmann et al 2001)

After intraperitoneal injection of ceramic fibres into rats in three experiments (Smith et al 1987, Pott et al 1987, Davis et al 1984), mesotheliomas were found in the abdominal cavity 6 in two studies, while the third report (Pott et al 1987) had incomplete histopathology. Only a few mesotheliomas were found in the abdominal cavity of hamsters after intraperitoneal injection in one experiment (Smith et al 1987). However, the ceramic fibres tested were of relatively large diameter. When rats and hamsters were exposed via intraperitoneal injection, tumour incidence was related to fibre length and dose (Smith et al 1987, Pott et al 1987, Miller et al 1999, Pott et al 1989). (From SCOEL publication (EU Scientific Committee on Occupational Exposure Limits) publication SCOEL/SUM/165, October 2010)

Reproductive toxicity: Method: Gavage; Species: Rat; Dose: 250mg/kg/day; Routes of administration: Oral; Results: No effects were seen in an OECD 421 screening study. There are no reports of any reproductive toxic effects of mineral fibres. Exposure to these fibres is via inhalation and effects seen



## Safety Data Sheet

based on Regulation (EC) No 1907/2006

### Kerform, Kerasetter, Kerheat

Print date: 16.06.2015

Page 9 of 12

are in the lung. Clearance of fibres is via the gut and the faeces, so exposure of the reproductive organs is extremely unlikely.

#### Irritation and corrosivity

Irritation and etching: Not an irritant. Evaluation: OECD 404

Irritant effect on the eye: Not an irritant.

#### Sensitising effects

After skin contact: no danger of sensitization.

#### Carcinogenic/mutagenic/toxic effects for reproduction

Specific symptoms in laboratory animals

#### Additional information on tests

STOT-Single exposure: Not applicable; STOT-Repeated exposure: Not applicable; Aspiration hazard: Not applicable.

#### Further information

IRRITANT PROPERTIES: Negative results have been obtained in animal studies (EU method B 4) for skin irritation. Inhalation exposures using the nose only route produce simultaneous heavy exposures to the eyes, but no reports of excess eye irritation exist. Animals exposed by inhalation similarly show no evidence of respiratory tract irritation. Human data confirm that only mechanical irritation, resulting in itching, occurs in humans. Screening at manufacturers' plants in the UK has failed to show any human cases of skin conditions related to fibre exposure.

### SECTION 12: Ecological information

#### Toxicity

Experience so far shows this product to be inert and not degradable. These products are insoluble in the natural environment and are chemically identical to inorganic compounds found in the soil and sediment.

#### Persistence and degradability

Inorganic product which is not eliminable from water through biological cleaning processes.

#### Bioaccumulative potential

Elimination from water is possible through precipitation or flocculation.

### SECTION 13: Disposal considerations

#### Waste treatment methods

##### **Advice on disposal**

Waste containing > 0.1% RCF/ASW is categorised as a stable non-reactive hazardous waste, which can generally be disposed of at landfill sites licensed for this purpose. Unless wetted, such a waste is normally dusty and so should be properly sealed in clearly labelled containers for disposal. At some authorised disposal sites, dusty wastes may be treated differently in order to ensure they are dealt with promptly to avoid them being wind blown. Please refer to the European list (Decision no 2000/532/CE as modified) to identify your appropriate European Waste Code (EWC) and ensure national and or regional regulation are complied with. When disposing of waste and assigning European Waste Code (EWC) any possible contamination during use will need to be considered and expert guidance sought as necessary.

When disposing of waste and assigning European Waste Code (EWC) any possible contamination during use will need to be considered and expert guidance sought as necessary.

##### **Contaminated packaging**

Cleaned containers may be recycled. Handle contaminated packaging in the same way as the substance itself.



## Safety Data Sheet

based on Regulation (EC) No 1907/2006

### Kerform, Kerasetter, Kerheat

Print date: 16.06.2015

Page 10 of 12

#### SECTION 14: Transport information

##### Land transport (ADR/RID)

**UN proper shipping name:** Not a hazardous material with respect to these transportation regulations.

##### Inland waterways transport

**UN proper shipping name:** Not a hazardous material with respect to these transportation regulations.

##### Marine transport

**UN proper shipping name:** Not a hazardous material with respect to these transportation regulations.

##### Air transport

**UN proper shipping name:** Not a hazardous material with respect to these transportation regulations.

##### Environmental hazards

Dangerous for the environment: no

##### Other applicable information

Ensure that dust is not windblown during transportation.

#### SECTION 15: Regulatory information

##### Safety, health and environmental regulations/legislation specific for the substance or mixture

##### EU regulatory information

##### Additional information

Product is classified and labelled in accordance with EC regulations or the corresponding national laws.

- Council Directive 67/548/EEC "on the approximation of the laws, regulations and administrative provisions relating to the classification, packaging and labelling of dangerous substances as modified and adapted to the technical progress" (OJEC L 196 of 16 August 1967, p.1 and its modifications and adaptations to technical progress).
- Council Directive 1999/45/EC of 31 May 1999 concerning the approximation of the laws, regulations and administrative provisions of the Member States relating to the classification, packaging and labelling of dangerous preparations.
- Regulation (EC) No 1907/2006 dated 18th December 2006 on Registration, Evaluation, Authorisation and Restriction of Chemicals (REACH).
- Regulation (EC) No 1272/2008 dated 16th December 2008 on classification, labeling and packaging of substances and mixtures (OJ L 353).
- Commission Directive 97/69/EC of 5 December 1997 adapting to technical progress for the 23rd time Council Directive 67/548/EEC (OJEC of 13 December 1997, L 343).
- Commission regulation (EC) No 790/2009 of 10 August 2009 amending, for the purposes of its adaptation to technical and scientific progress, Regulation (EC) No 1272/2008 of the European Parliament and of the Council on classification, labeling and packaging of substances and mixtures.
- The 1st Adaptation to Technical Progress (ATP) to Regulation (EC) No 1272/2008 enters into force on 25 September 2009. It transfers the 30th and 31st ATPs of Directive 67/548/EEC to the Regulation (EC) No 1272/2008.

INTEGRATION OF RCF/ASW IN TO ANNEXE XV OF THE REACH REGULATION: RCF are classified as a carcinogenic substance CLP 1B (See section 15 above). On the 13th of January 2010 ECHA updated the candidate list for authorisation (Annexe XV of the REACH regulation) and added 14 new substances in this list including aluminosilicate refractory ceramic fibres and zirconia aluminosilicate refractory ceramic fibres. As a consequence, EU (European Union) or EEA (European Economic Area) suppliers of articles which contain aluminosilicate refractory ceramic fibres and zirconia aluminosilicate refractory ceramic fibres in a concentration above 0.1% (w/w) have to provide sufficient





## Safety Data Sheet

based on Regulation (EC) No 1907/2006

### Kerform, Kerasetter, Kerheat

Print date: 16.06.2015

Page 11 of 12

information, available to them, to their customers or upon requests to a consumer within 45 days of the receipt of the request. This information must ensure safe use of the article and as minimum contains the name of the substance.

**RESTRICTION ON MARKETING OF RCF/ASW:** Marketing and use of RCF/ASW is controlled by Directive 76/769/EEC relating to restrictions on the marketing and use of certain dangerous substances and preparations as modified (21st amending, Directive 2001/41/EC, 19 June 2001) and is restricted to professional use only.

**PROTECTION OF WORKERS:** Shall be in accordance with several European Directives as amended and their implementations by the Member States:

- Council Directive 89/391/EEC dated 12 June 1989 "on the introduction of measures to encourage improvement in the safety and health of workers at work (OJEC (Official Journal of the European Community) L 183 of 29 June 1989, p.1).
- Council Directive 98/24/EC dated 7 April 1997 "on the protection of workers from the risks related to chemical agents at work" (OJEC L 131 of 5 May 1998, p.11).
- Council Directive 2004/37/EC of 29 April 2004 on the protection of workers from risks related to exposure to carcinogens mutagens and reprotoxics at work (OJEC L 158 of 30 April 2004).

**OTHER EU REGULATIONS:** Member states are in charge of implementing European directives into their own national regulation within a period of time normally given in the directive. Member States may impose more stringent requirements. Please always refer to national regulations.

**SOURCE OF REFERENCE FOR OELs:** UK: HSE EH40 Workplace Exposure Limit.

#### National regulatory information

Employment restrictions: Observe employment restrictions for young people. Observe employment restrictions for child bearing mothers and nursing.

Water contaminating class (D): -- not water contaminating

#### Chemical Safety Assessment

For this substance a chemical safety assessment has been carried out.

### SECTION 16: Other information

#### Changes

Notice the directions for use on the label.

The above information describes exclusively the safety requirements of the product and is based on our present-day knowledge. The information is intended to give you advice about the safe handling of the product named in this safety data sheet, for storage, processing, transport and disposal. The information cannot be transferred to other products. In the case of mixing the product with other products or in the case of processing, the information on this safety data sheet is not necessarily valid for the new made-up material.

#### Abbreviations and acronyms

European Industry Association Representing HTIW (ECFIA): 3, Rue du Colonel Moll, 75017 Paris - Tel. +33 (0) 31 48 74 26 - www.ecfia.eu

#### Full text of R-phrases referred to under sections 2 and 3

31	Contact with acids liberates toxic gas.
34	Causes burns.
49	May cause cancer by inhalation.
50	Very toxic to aquatic organisms.

#### Full text of H-Statements referred to under sections 2 and 3

H314	Causes severe skin burns and eye damage.
H350i	May cause cancer by inhalation.



## Safety Data Sheet

based on Regulation (EC) No 1907/2006

### Kerform, Kerasetter, Kerheat

Print date: 16.06.2015

Page 12 of 12

H400 Very toxic to aquatic life.

#### Further Information

USEFUL REFERENCES (the directives which are cited must be considered in their amended version):

- Hazards from the use of Refractory Ceramic Fibre. Health and Safety Executive: Information document, HSE 267 (1998).
- Working with Refractory Ceramic Fibres 2006
- ECFIA; Code of Practice.
- Maxim LD et al (1998). CARE – A European programme for monitoring and reducing Refractory Ceramic Fibre dust at the workplace initial results; Gefahrstoffe – Reinhaltung der Luft, 58:3,97-103.
- Recognition and control of exposure to RCF, ECFIA, April 2009

#### ADDITIONAL INFORMATION AND PRECAUTIONS TO BE CONSIDERED UPON REMOVAL OF AFTER SERVICE MATERIAL:

As produced, all Refractory Ceramic Fibres are vitreous (glassy) materials which, upon continued exposure to elevated temperatures (above 900°C), may devitrify. The occurrence and extent of crystalline phase formation is dependent on the duration and temperature of exposure, fibre chemistry and/or the presence of fluxing agents. The presence of crystalline phases can be confirmed only through laboratory analysis of the "hot-face" fibre. IARC's evaluation of crystalline silica states "Crystalline silica inhaled in the form of quartz or cristobalite from occupational sources is carcinogenic to humans (Group 1)" and additionally mentioned "in making the overall evaluation, the Working Group noted that carcinogenicity in humans was not detected in all industrial circumstances studied...".

As only a thin layer of the insulation (hot face side) is exposed to high temperatures, respirable dust generated during removal operations does not contain detectable levels of crystalline silica (CS). In applications where the material is heat soaked, duration of heat exposure is normally short and a significant devitrification allowing CS to build up does not occur. This is the case for waste mould casting for instance. Toxicological evaluation of the effect of the presence of CS in artificially heated RCF/ASW material has not shown any increased toxicity in vitro.

The lack of toxicological effects may be explained by the following factors ; Increased brittleness of fibres after service life, favours fast fibre translocation through macrophage. Microcrystals, including crystalline silica, are embedded in the glass structure of the fibre and are therefore not biologically available.

High concentrations of fibres and other dusts may be generated when after-service products are mechanically disturbed during operations such as wrecking. Therefore ECFIA recommends: a) control measures are taken to reduce dust emissions and b) all personnel directly involved wear an appropriate respirator to minimise exposure.

CARE PROGRAMME: ECFIA, representing the high temperature insulation wool (HTIW) industry, has undertaken an extensive industrial hygiene programme to provide assistance to the users of all products containing HTIW. The objectives are twofold: To monitor workplace dust concentrations at both manufacturers' and customers' premises and to document manufacturing and use of RCF products from an industrial hygiene perspective in order to establish appropriate recommendations to reduce exposures. If you wish to participate in the CARE programme, contact ECFIA or your supplier.

SPRAYING: ECFIA recommends that this fibre should not be used for spraying.

*(The data for the hazardous ingredients were taken respectively from the last version of the sub-contractor's safety data sheet.)*



## 9.3. "Isolrath" (Super-Isol) safety data sheet



## Safety data sheet

### Super-Isol, Super-1100 E, Super-1100 E (WR)

#### 1. Identification of the substance/preparation and of the company/undertaking

Prepared on: 28-11-2007/ ZBH  
Replaces: 13-11-2006

**Product use:** Porous board insulation.

Supplier:

**Skamol A/S**  
Østergade 58-60  
DK-7900 Nykøbing M  
Tel: +45 97721533 Fax: +45 97724975  
Emergency telephone number: +45 97721533  
Email: insulation@skamol.dk

#### 2. Hazards identification

The product shall not be classified as hazardous according to the national classification and labelling rules.

**Additional information**

May cause slight irritation to the skin and eyes.

#### 3. Composition/information on ingredients

Einecs no.	CAS No.	Substances	Classification	w/w%
215-710-8	1344-95-2	Calcium silicate	-	-
<i>Please see section 16 for the full text of the R-phrases</i>				

#### 4. First aid measures

**Inhalation**

Exposure to dust: Seek fresh air, wash out mouth with water and blow nose thoroughly. Seek medical advice in case of persistent discomfort.

**Ingestion**

Exposure to dust: Wash out mouth thoroughly and drink 1-2 glasses of water in small sips. Seek medical advice in case of persistent discomfort.

**Skin**

Exposure to dust: Remove contaminated clothing. Wash the skin thoroughly with water and continue washing for a long time. Seek medical advice in case of persistent discomfort.

**Eyes**

Exposure to dust: Flush with water (preferably using eye wash equipment) until irritation subsides. Seek medical advice if symptoms persist.

**Other information**

Symptoms: See section 11. When obtaining medical advice, show the safety data sheet or label.

#### 5. Fire-fighting measures

The product is not directly flammable. Avoid inhalation of vapour and flue gases – seek fresh air.

#### 6. Accidental release measures

Use the same personal protective equipment as stated in section 8. Sweep up/collect spills for possible reuse or transfer to suitable waste containers. See section 13 for instructions on disposal. Do not sweep – use vacuum cleaner to collect spillage.

Chemtox A/S, Birkemosevej 7, DK-6000 Kolding Tlf.: +45 75508811, Fax: +45 75508810, E-mail: chemtox@chemtox.com, Web: www.chemtox.com

Prepared on: 28-11-2007/ZBH  
Replaces: 13-11-2006

## Super-Isol, Super-1100 E, Super-1100 E (WR)

### 7. Handling and storage

**Handling**

See section 8 for information about precautions for use and personal protective equipment.

**Storage**

No special storage requirements.

### 8. Exposure controls/ personal protection

**Precautions for use**

Work processes where generation of dust may occur must be performed under effective process ventilation (e.g. local exhaust ventilation).  
Running water and eye wash equipment must be available. Wash hands before breaks, before using restroom facilities, and at the end of work.

**Respiratory protection**

In case of insufficient ventilation, wear respiratory protective equipment with P2 filter.

**Gloves and protective clothing**

Not required.

**Eye protection**

Wear safety goggles if there is a risk of dust contact with eyes.

**Occupational exposure limits**

Contains no substances subject to reporting requirements.

### 9. Physical and chemical properties

State: Solid substance, Porous board

Solubility in water: Insoluble

Odour: None

pH: 8

Melting point: 1345 °C

Density: 230 - 290 kg/m<sup>3</sup>

### 10. Stability and reactivity

The product is stable when used in accordance with the supplier's directions.

### 11. Toxicological information

**Acute****Inhalation**

Inhalation of dust may cause irritation to the upper airways.

**Ingestion**

Exposure to dust: Irritates mucous membranes in mouth and gastrointestinal tract.

**Skin contact**

Exposure to dust: May cause slight irritation.

**Eye contact**

Exposure to dust: Temporary irritation.

**Long-term effects**

None known.

### 12. Ecological information

Do not discharge large quantities of concentrated spills and residue into drains.

Chemtox A/S, Birkemosevej 7, DK-6000 Kolding Tlf.: +45 75508811, Fax: +45 75508810, E-mail: chemtox@chemtox.com, Web: www.chemtox.com

Prepared on: 28-11-2007/ZBH  
Replaces: 13-11-2006

## Super-Isol, Super-1100 E, Super-1100 E (WR)

### 13. Disposal considerations

Contact the local authorities.

EWC code: Depends on line of business and use, for instance 17 06 04 insulation materials other than those mentioned in 17 06 01 and 17 06 03

### 14. Transport information

The product is not covered by the rules for transport of dangerous goods by road and sea according to ADR and IMDG.

### 15. Regulatory information

**Hazard designation:** It has been assessed that the product shall not be classified as hazardous according to the national classification and labelling rules.

**Other labelling**  
None.

**Chemical safety assessment**  
Chemical safety assessment has not been performed.

**Restrictions on use**  
None.

**Training requirement**  
No special training is required, but a thorough knowledge of this safety data sheet should be a prerequisite condition.

### 16. Other information

#### Sources used

Commission Directive 2004/73/EC of 29 April 2004 adapting to technical progress for the twenty-ninth time Council Directive 67/548/EEC on the approximation of the laws, regulations and administrative provisions relating to the classification, packaging and labelling of dangerous substances.

Commission Directive 2000/39/EC of 8 June 2000 establishing a first list of indicative occupational exposure limit values in implementation of Council Directive 98/24/EC on the protection of the health and safety of workers from the risks related to chemical agents at work 2001/118/EC: Commission Decision of 16 January 2001 amending Decision 2000/532/EC as regards the list of wastes (Text with EEA relevance) (notified under document number

Commission Directive 2001/58/EC of 27 July 2001 amending for the second time Directive 91/155/EEC defining and laying down the detailed arrangements for the system of specific information relating to dangerous preparations in implementation of Article 14 of European Parliament and Council Directive 1999/45/EC and relating to dangerous substances in implementation of Article 27 of Council Directive 67/548/EEC (safety data sheets)

Directive 1999/45/EC of the European Parliament and of the Council of 31 May 1999 concerning the approximation of the laws, regulations and administrative provisions of the Member States relating to the classification, packaging and labelling of dangerous preparations + Directive 2006/8/EC.

ADR 2007 edition and IMDG 2006 edition.

#### Other information

This safety data sheet was prepared from information provided by the supplier about the product at the time of preparation (e.g. data sheets and the like).

**Full text of the R-phrases that are stated in section 3.**  
No R-phrases.

**Amendments have been made in the following sections**  
1,2,3,4,11,13,15,16

Chemtox A/S, Birkemosevej 7, DK-6000 Kolding Tlf.: +45 75508811, Fax: +45 75508810, E-mail: chemtox@chemtox.com, Web: www.chemtox.com (Made in Toxido®) EU\_UK

# 10. Index

Access levels .....	20	Environmental protection requirements .....	120
Acoustic signal .....	76	ERP system .....	109
Altraform .....	123	Error messages .....	116
Ambient conditions .....	12	Ethernet .....	24, 30
Ambient temperature .....	12	Fire .....	51
Backup .....	86	Fire hazard .....	18, 26
Bookmark .....	33, 36	Firing parameter .....	47
Browser .....	33, 36, 96	Firing parameters .....	37, 101
Button .....	38	Firing program .....	37
Calibrating the screen .....	71	Firing tray .....	101
Calibration .....	71	Fix .....	74
Calibration set .....	112	FTP access .....	106
Care .....	111	FTP address .....	106
CCF .....	114	FTP connection .....	106
CCF value .....	81	FTP Server .....	91
Ceramic dust .....	19	Function bar .....	42
Chairside program .....	51	Function keys .....	86
Change IP address .....	72	Furnace ID .....	75
Change the heating element .....	117	Fuse holders .....	24
Check program .....	116	General code .....	73
Circle .....	89	GMT .....	70
Circle Login .....	89	GOTO .....	48
Classic programs .....	49	Graphic representation .....	47
Clean .....	111	Handle .....	51
Command line .....	50	Heating element wear .....	79
Condensation .....	100	Heavy firing furnace .....	19
Consumable part .....	100	Hot surfaces .....	18
Contrast .....	71	HTML access .....	85
Copy .....	44	Humidity .....	12
Create .....	44	Idle .....	51
Create program .....	62	Information bar .....	42
Creating a folder .....	44	Information line .....	46, 49, 51
Creating a set .....	44	Installation assistant .....	29
Crossed network cable .....	24	Interfaces .....	24
Cut .....	45	IP address .....	30
CVTL commands .....	60	Isolath .....	141
Data backup .....	102	Kerform .....	129
Data security .....	102	Safety data sheet .....	129
Date .....	69	Keyboard window	
Date format .....	69	alphanumeric .....	40
DEKEMA Academy .....	27	Classic .....	41
Delete .....	45	numeric .....	39
Diagnostic data .....	84	Kiln furniture .....	101
Dimensions .....	11	Language .....	68
Display area .....	42	Lift noise .....	100
Disposal .....	120	Lock set .....	74
Drying .....	56, 78	Log printout .....	108
Drying the firing object .....	101	Login data .....	85
Edit .....	47, 50, 52	Main switch .....	24
Electrical shock .....	17	Maintenance and service tasks .....	111
Entering text .....	40	Malfunctions .....	79
Entering the value .....	39	Manufacturer address .....	118

Mark program .....	44	Screen setting .....	70
Mounting the firing object .....	94	Screensaver .....	70
MSDS .....	See Safety data sheets	Scroll bar .....	43
Name plate .....	10	SDS .....	See Safety data sheets
Network .....	71	Sealing ring .....	111
NTP .....	69	Select program .....	44
NTP Update Time .....	69	Self-check program .....	79
Online Update .....	86	Sequence .....	47
OPC program .....	109	Service partners .....	118
Open lift .....	77	Set .....	37
Operating instructions .....	14	Set list .....	43
Operating layout .....	98	Setup .....	64, 74
Oxidation .....	80	Setup site .....	26
Packaging symbols .....	25	Software program .....	117
Password .....	85	Software update .....	117
Paste .....	45	Software Update .....	86
Pictures .....	47, 50, 53	Spare parts .....	118
Power consumption .....	12	Start .....	47, 50, 51
Power failure .....	110	Start the program .....	96
Printer .....	82	Start/stop function .....	85
Professional program .....	46	Start-up .....	28
Program .....	37	Stop .....	47, 50, 51
Program display .....	46	Storage .....	119
Program editor .....	58	Super-Isol .....	141
Program end .....	99	Supply voltage .....	12
Program list .....	43	Switching off .....	93
Program Manager .....	43	Switching on .....	93
Program parameters .....	37	TCP/IP settings .....	82
Program sequence .....	55	Temperature 1 .....	56
Program steps .....	56	Temperature 2 .....	56
Program stop .....	47, 50, 51	Temperature 3 .....	56
Programmschritte .....	57	Temperature calibration .....	81, 100, 112
Proper use .....	9	Test firings .....	101
Protect firing programs .....	73	Time .....	69
Quality assurance .....	108	Touchscreen .....	22
Quality Management .....	83	Transport .....	118
Range .....	59, 61	Units .....	67
Recovery .....	86	USB Backup .....	86
Removing the firing object .....	95	USB Recovery .....	86
Repairs .....	111	USB stick .....	102
Retrofitting .....	16	Use .....	9
Safety data sheet .....	123	Valid values .....	39
Safety data sheets .....	19, 122	VNC .....	31
Isolrath .....	141	VNC program .....	31, 97
Safety information .....	13	Warning .....	77
Save .....	47, 50, 52	Web interface .....	33, 36, 96
Save energy .....	100	Weight .....	11
Scope of delivery .....	9	Workplace .....	15
Screen contrast .....	71	X-DREAM .....	109

