

# ***TOTEM***

## **User Manual**

**E-Bike**

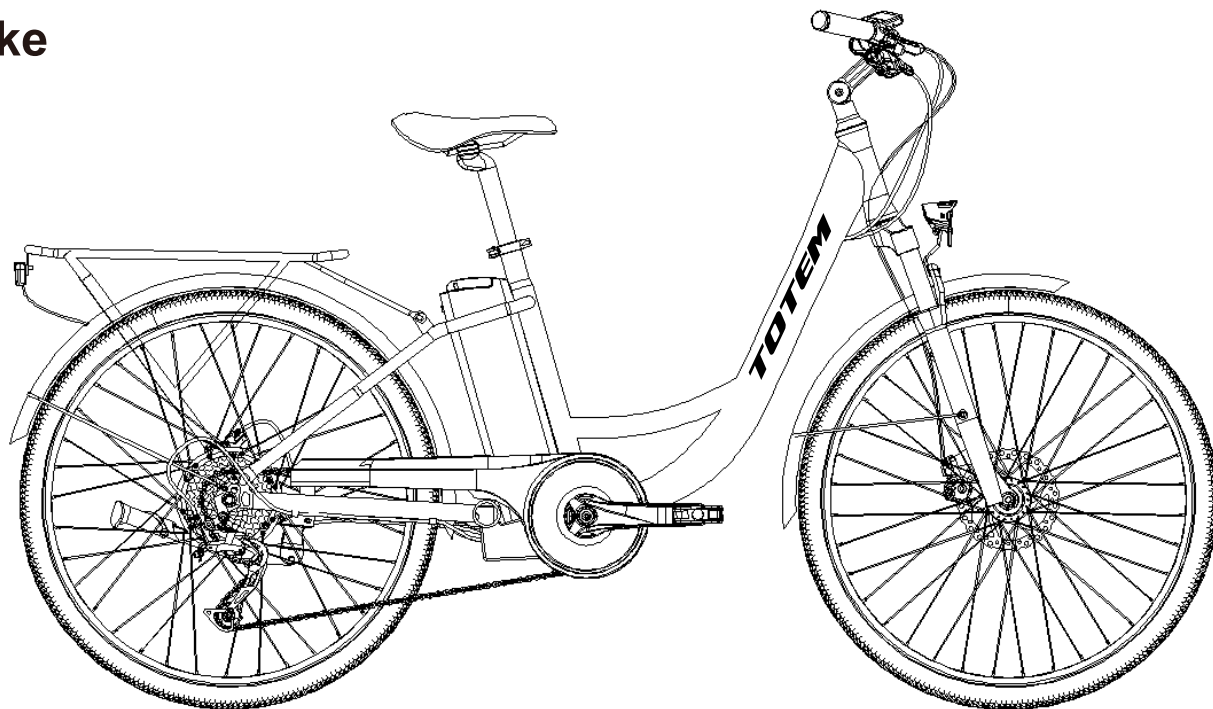

## **Thank you and congratulations on your Totem E-Bike purchase!**

Totem electric bikes are the perfect fusion of elegance and engineering. Your city will feel smaller by combining the intuitive feel of a traditional pedal bike with smooth electric power. Hills become flatter and tough commutes become joyrides. Charge up your Totem and recharge your love for riding.

To ensure your safety and the safety of others, please read and follow the guidelines in this user manual carefully and thoroughly before and during riding.

TotemUSA is committed to your satisfaction with our products. If something isn't right, please reach out to us right away. We are always happy to help.

Happy Riding!

The TOTEM Team

Support@totemusa.com

# TABLE OF CONTENTS

<b>Section 1. General Information</b> .....	3	<b>Section 5. Safe Riding Techniques &amp; Tips</b> .....	16
1.1 What’s In the Box? .....	3	5.1 Before Your First Ride .....	17
1.2 Product Overview .....	4	5.2 Routine Bike Inspections .....	17
<b>Section 2. Installation Steps</b> .....	5	5.3 Semi-Annual Bike Mechanic Inspections .....	17
<b>Section 3. Charging the Battery</b> .....	12	<b>Section 6. Maintenance</b> .....	18
3.1 Charging Instructions.....	12	6.1 Battery maintenance .....	18
3.2 Battery Security Lock/Removal.....	14	6.2 Cleaning .....	18
<b>Section 4. Riding Your E-Bike</b> .....	14	6.3 Storage .....	19
4.1 Adjusting the Seat Height .....	14	6.4 Disposal at End-of-Life .....	19
4.2 How to Ride .....	15	<b>Section 7. Specifications</b> .....	20
4.3 Buttons Information.....	16	<b>One-Year Limited Hardware Warranty</b> .....	21
4.4 Display Information .....	16		

## Section 1. General Information

### 1.1 What's In the Box?

- 1×Bike frame with the rear wheel
- 1×Wheel
- 1×Saddle
- 2×Pedal
- 1×Disc brake
- 1×Quick release
- 2×Reflector
- 1×Rear derailleur protecting rack
- 1×Charger
- 1×Battery
- 6×ScrewM5\*8.5
- 4×Tool
- 1×User's Manual
- 1xHeadlight

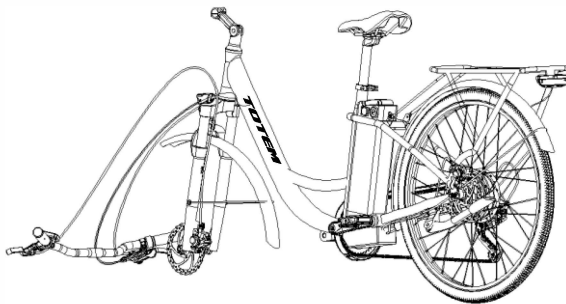

1× Bike frame with the rear wheel

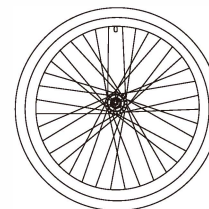

1× Wheel

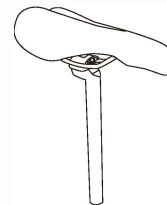

1× Saddle



1xHeadlight

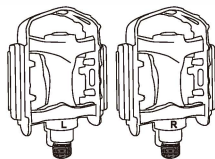

2× Pedal

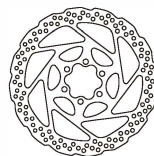

1× Disc brake



1× Quick release

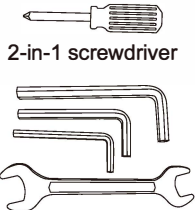

2-in-1 screwdriver

4× Tool

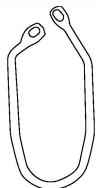

1× Rear Derailleur Guard

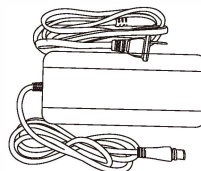

1× Charger



1× Battery

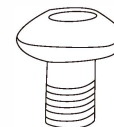

6× ScrewM5\*8.5



1× Manual



## 1.2 Product Overview

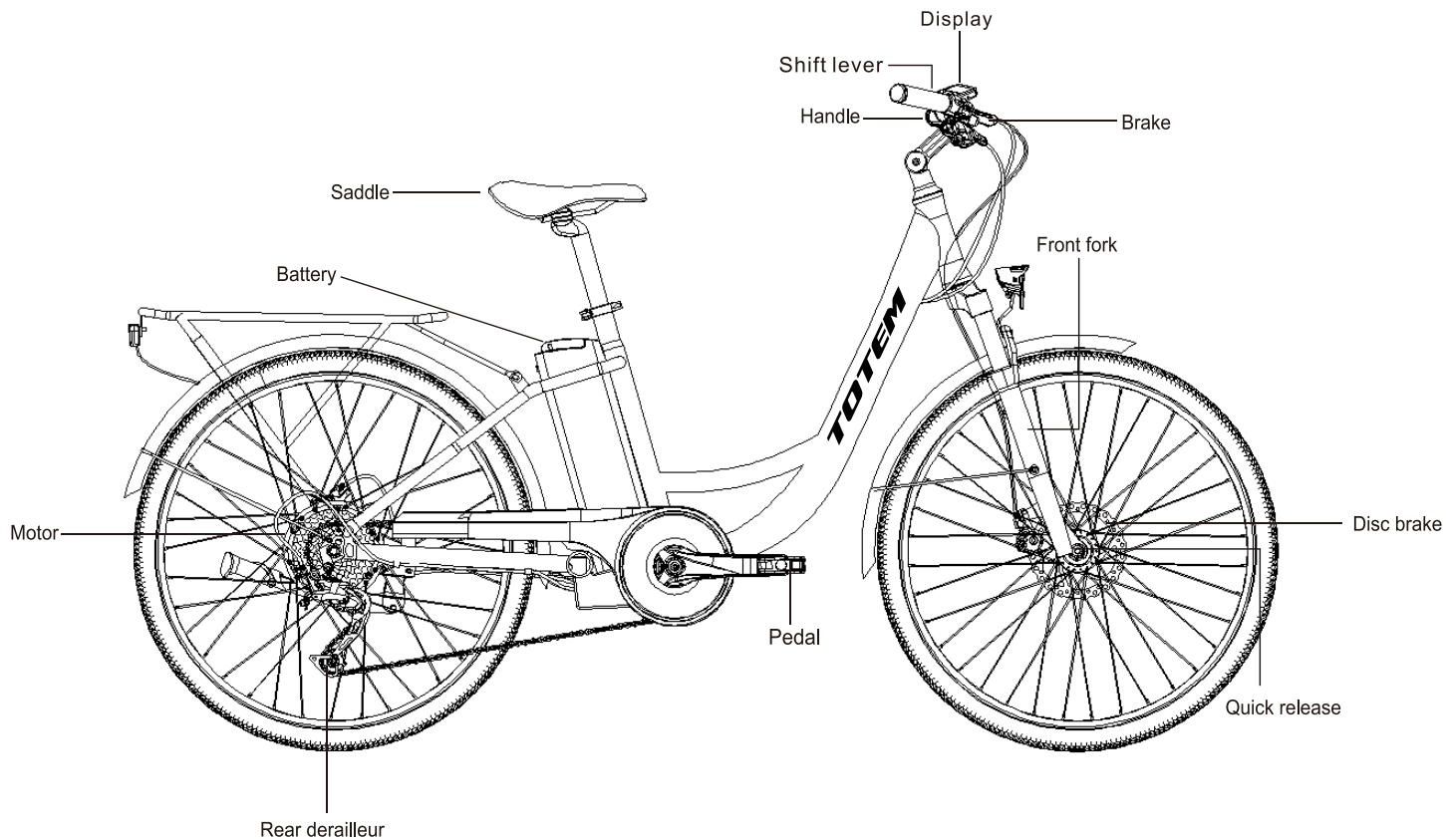

## Section 2. Installation Steps

 **ATTENTION:** Do not install the battery and start the display before it is fully assembled.

 **NOTE:**

- Before operating your E-Bike, please read all instructions in the manual and follow the steps and descriptions carefully. This manual will guide you through the installation, functions, operation, and proper maintenance of your TOTEM E-Bike.
- Before assembling, check that all parts are complete and in good condition. If you have any questions or cannot find the information you need in the manual, please contact [support@totemusa.com](mailto:support@totemusa.com). Before contacting customer service, please have your original purchase information handy before contacting Customer Service.

### Step 1. Adjust the stem

- Turn the stem of the handlebar 180 degrees so that it's facing forward.
- Fasten the 2 bolts that are already on the stem to secure the handlebar in position.

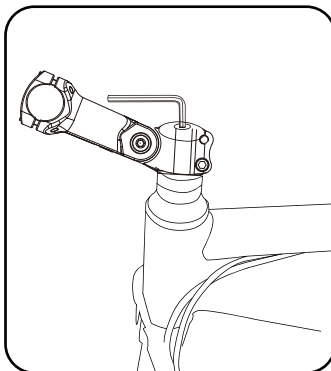
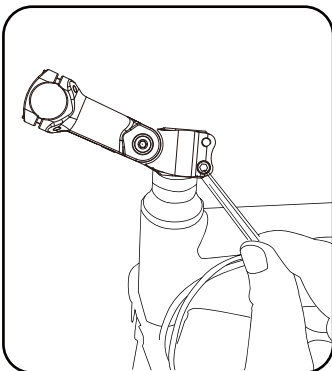
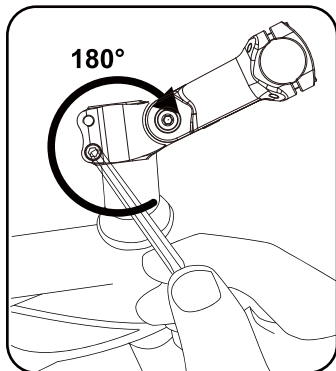

## Step 2. Install the handlebar

- Loosen the 4 bolts on the stem to remove the stem cover
- Rotate the handlebar so that it's 90 degrees from the wheel and frame
- Put on the stem cover and tighten the 4 screws in order

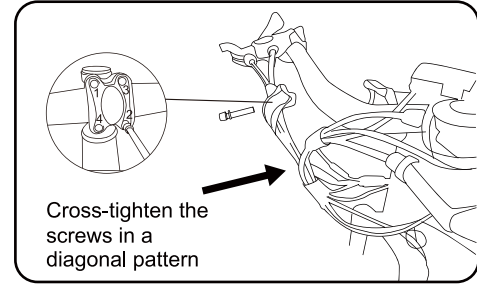
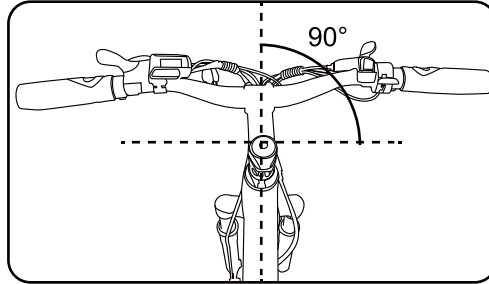
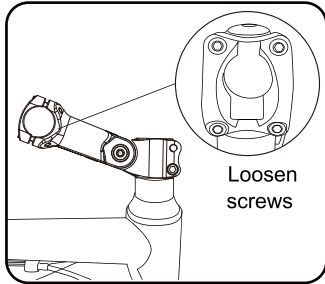

## Step 3. Install disc brakes for the front wheel

- Align the disc brake with the wheel
- Make sure all of the 6× Bolts M5\*8,5 are inserted and the disc brake is tightened with the included allen wrench

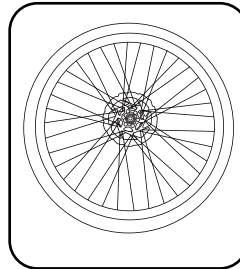
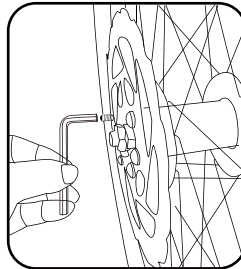
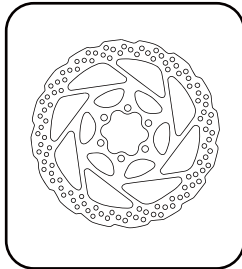
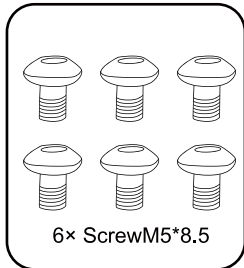

## Step 4. Assemble and install the front wheel

- Take out the wheel and the quick-release skewer. Note that there are two cone springs on the quick-release skewer.
- Open the lever and unscrew the thumb nut from the quick release.
- Insert quick-release skewer with each cone spring on both sides into the wheel and pre-fasten thumb nut.

**⚠ Quick-release thumb nut is installed on the same side as the brake rotor.**

**Both cone springs should point toward the wheel hub.**

**Keep the lever open and thread on the thumb nut a couple of turns leaving enough room for the fork dropouts.**

- Lower the front fork onto the front wheel. The brake rotor should go into the brake caliper in between the brake pads and the axle should enter the fork dropouts fully.

**⚠ Check to confirm the wheel is fully seated in the dropouts.**

- Hold the quick release lever in line with the axle and tighten the thumb nut until the lever can stay in parallel to the floor without being held. Use the palm of your hand to close the lever fully without touching the brake rotor.

**⚠ The quick-release lever secures the front wheel to the bike so the thumb nut must be tight enough so the closed lever has adequate clamping force and keeps the axle and wheel firmly in place.**

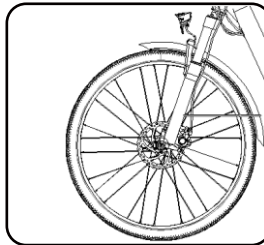
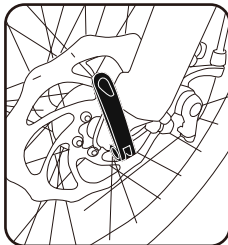
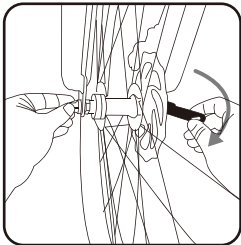
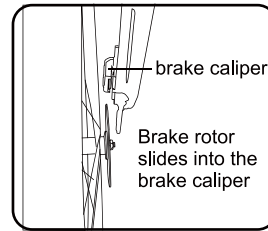
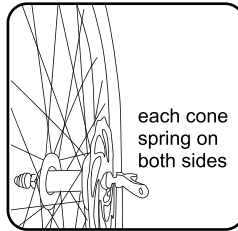
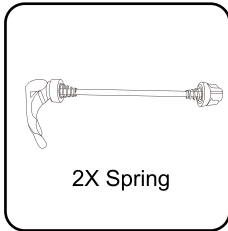
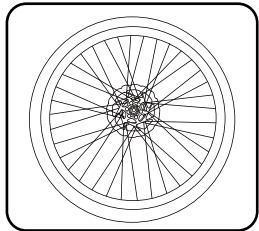

## Step 5. Install Rear Derailleur Guard

- Unscrew the 2 Bolts M5\*10 from the rear hanger of the frame
- Align the rear derailleur protecting rack to the screw holes ① ② of the rear wheel, and then fasten the 2 Bolts

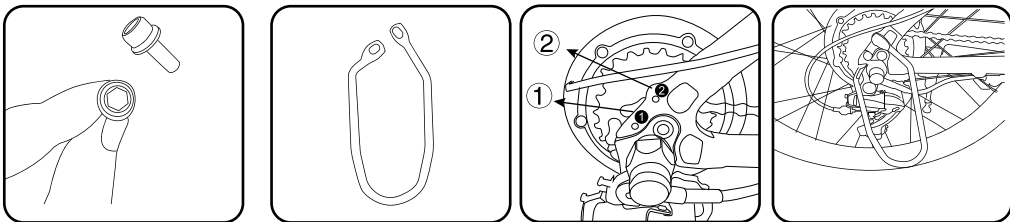

## Step 6. Install pedal

- Look for the 'R' or 'L' labeled at the threaded end of the pedals to identify the correct side
- Hand tighten at first. The right pedal tightens **CLOCKWISE**. The left pedal tightens **COUNTERCLOCKWISE**
- Completely tighten the pedals with a pedal wrench or an open-end wrench

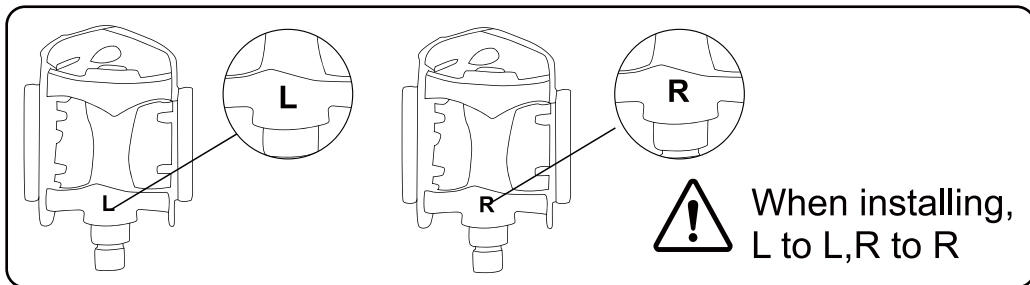

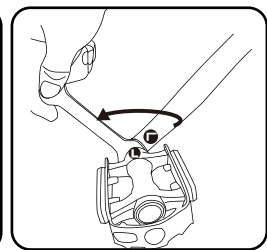
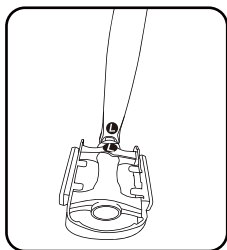

L

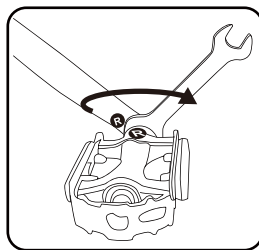
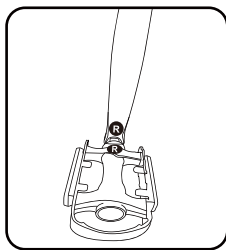

R

### Step 7. Install the saddle

- Open the clamp under the seat post. Pull the seat up or push it down to adjust the height
- Close the clamp to secure the seat in place. Do not raise the saddle higher than the safety line

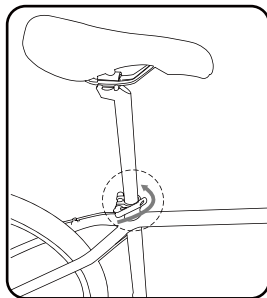
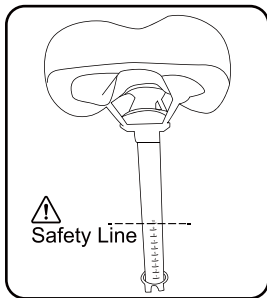
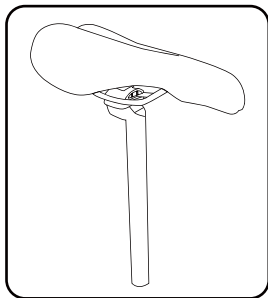

## Step 8. Install the battery

- Insert the battery into the middle frame. Turn the key to the locked position
- To unlock the battery, insert the key, and turn it to the unlock position to pull the battery out



**Check whether the battery switch is turned on every time you ride**

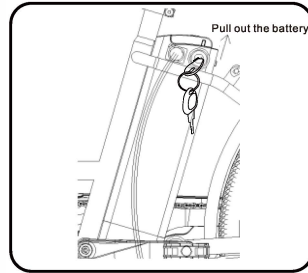
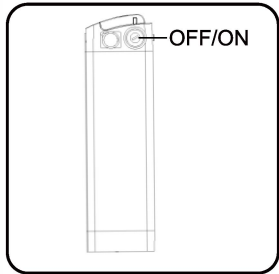

## Step 9. Install Front Reflector and Headlight

- Take out the white reflector and 1× screw M6\*20
- Install the reflector on the headlight brackets
- Tighten the screws with suitable tools and complete front reflector installation
- Pre-installed wire for headlight can be found between the fork, plug the wire into the back slot of the headlight to connect headlight with battery.  
(Keep the wire in between two fork legs)

Pass the bolt through headlight bracket and fender mounting point, tighten the bolt to install the headlight.

**Note:** The screwdriver included in the package is 2-in-1. You can remove and change the screw head and use a Phillips screwdriver to complete the installation.

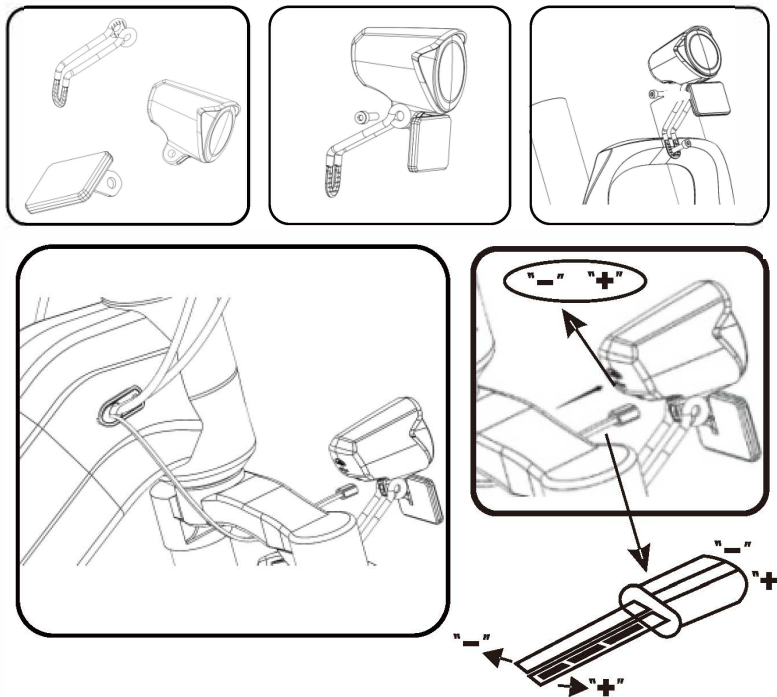



## Section 3. Charging the Battery

### 3.1 Charging Instructions

Charge the E - Bike before operating it. It typically takes about 3 hours to fully charge the battery.



#### **ATTENTION:**

- DO NOT use the bike while it is charging or connected to the charger under any circumstances.
- The charging time is 3 hours. Charging longer than that may affect battery life and/or performance. If the charging adapter's light doesn't turn on, it may not be fully connected. Check that it is securely connected to the wall and to the bike.
- Use only the charger provided with your TOTEM E-Bike. If you have lost or misplaced your charger, contact customer support to obtain a replacement.

**Step 1.** Make sure the bike is turned off and check the connection of the charging cable and power adapter.

**Step 2.** Plug the charger into a wall outlet (100V-240V) then plug the other end into the charging port on the E-Bike. Remove the cap as needed.

**Step 3.** Allow about 3 hours for charging. The power adapter's light will turn red during charging and then turn green once charging is complete. Disconnect all cables once charging is completed.

For your convenience, the battery can be removed and charged separately.

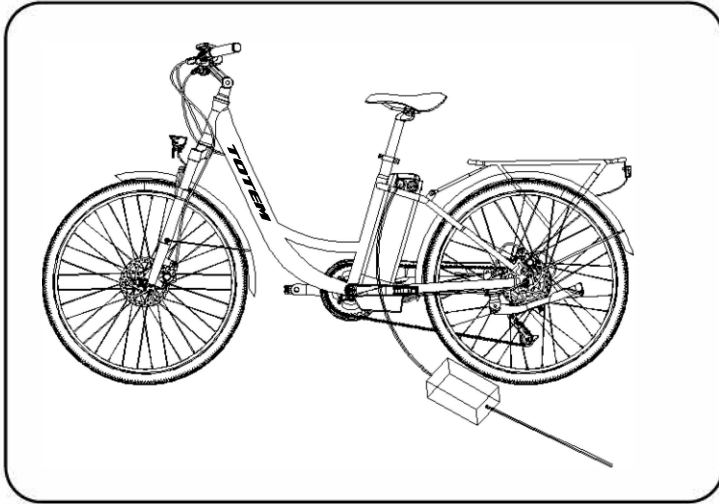

**NOTE:**

- Fully charge the battery before your first use, this may take up to 3 hours.
- Perform periodic visual inspections on the battery ports and charging cables.
- Keep your charging environment clean and dry at all times.
- If the charging port is damp or has any liquid on it, do not charge your E-Bike.
- For the battery to operate at its maximum efficiency, avoid charging your E-Bike in extremely hot or extremely cold environments.

### 3.2 Battery Security Lock/Removal

For your convenience and security, the TOTEM E-Bike's battery is removable and locked to the frame as needed

**Step 1.** To unlock the battery, insert the key, and turn it to the unlock position to pull the battery out.

**Step 2.** To reinstall the battery, reinsert it into the frame. Turn the key to the locked position.

 **Remember to lock the battery and remove the key before riding the bike.**

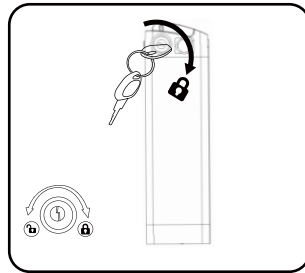
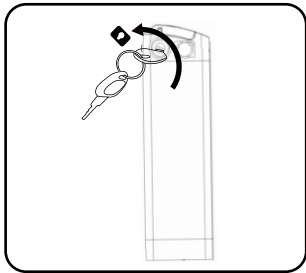

## Section 4. Riding Your E-Bike

### 4.1 Adjusting the Seat Height

Positioning the seat to the right height is key for better pedaling, safety, and overall comfort. The rider's leg length is used to determine the seat's position. When pedaling, your hips should remain level and your legs shouldn't over-extend. To determine the right seat height, sit on the E-Bike with one pedal at its lowest point and place the ball of your foot on the pedal. If your knee bends slightly at this position, the seat is at the right height. Additionally, when placing your heel on the pedal, your leg should be nearly straight.

Open the clamp under the seat post. Pull the seat up or push it down to adjust the height. Check to make sure the seat post is fully inserted into the frame and the head of the seat is parallel with the frame. Lastly, close the clamp to secure the seat in place.

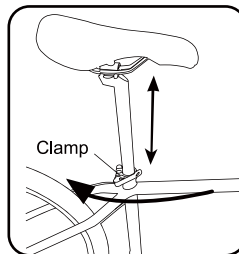

## 4.2 How to Ride

### Riding Modes

Pure E-Bike - Turn on LCD smart display, speed modes (1-5), speed controlled by turning the throttle

Assisted Bike -Turn on LCD smart display, speed modes (1-5), and pedal at the same time

Normal Bike -Turn off LCD smart display and pedal like a normal bike

Speed Modes	Pure E-Bike	Assisted Bike
0	×	×
1-5	√	√
Display OFF	×	×

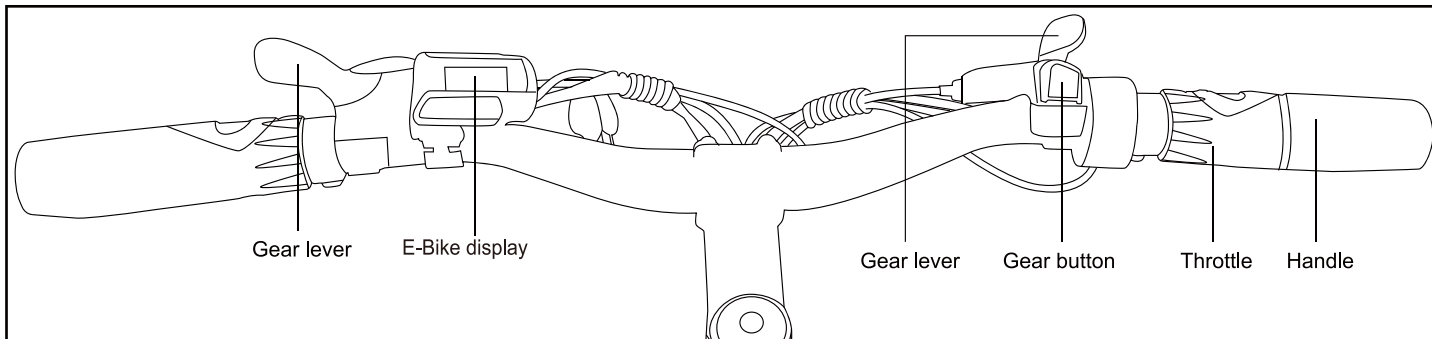

- Fully charge the battery and check that the battery switch is on before riding.
- Start your E-Bike by pressing and holding the power button ~2s. The assisted mode will be on whenever power is on and speed modes 1-5.
- The rider must move forward by pedaling first, then twist the throttle to engage automatic riding without pedaling. Max assisted speed is 20 mph/32 km/h.
- To change from smaller chainring to larger chainring, push and hold the left shifter lever. To change from larger chainring to smaller chainring, pull the left shifter lever. Push the right shifter lever to shift from smaller sprocket to larger sprocket, or push the button to shift from larger sprocket to small sprocket.
- To stop, release the throttle, safely apply the brakes, then squeeze the brakes lever to slow the front and rear wheels down.

### 4.3 Buttons Information

TOTEM E-Bike's display features several different elements.

— : Quick-press to switch modes from high to low speed.  
Press and hold to activate walk-assist.

⏻ : Press and hold for ~2 seconds to turn the E-Bike on/off.

⊕ : Quick-press to switch between speed modes from 0 to 5 speed.  
Press and hold to turn on the front headlight.

### 4.4 Display Information

Battery level: This icon indicates how much battery life you have left.

Speed display: This icon indicates current speed, as measured in mph.

Speed mode: This icon indicates the level of electric bicycle assistance.

 Battery needs to be charged



"H" flashing, motor overheat protection

 Don't go uphill using the throttle only for extended periods of time. This can cause the motor to overheat.

## Section 5. Safe Riding Techniques & Tips

Consider the following techniques and info to help ensure you have a safe, fun riding experience. Before riding, always check to make sure your brakes are working properly.

 **ATTENTION:**

Wearing properly fitting safety helmets, elbow pads, and knee pads greatly reduces the risk of injury.

Helmets can reduce 85% of critical head injuries.

Elbow pads can reduce 82% of elbow injuries.

Knee pads can reduce 32% of knee injuries.

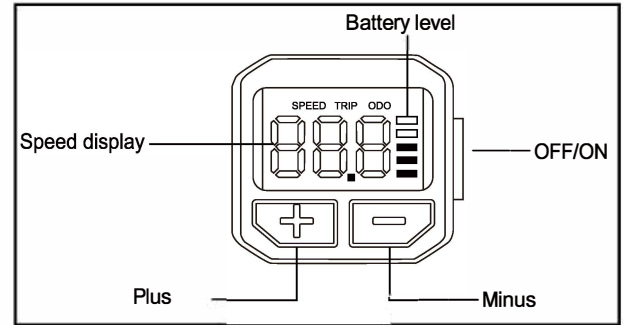



## **NOTE:**

- Make sure your feet are always on the pedals. Make sure both hands are on the bike handle at all times when riding. Taking your feet off the pedals while riding is dangerous.
- Do not use the E-Bike to perform dangerous maneuvers. Failure to exercise good judgment and heed the above warnings increases the risk of serious injury or, in very rare cases, death. Use with appropriate caution and serious attention to safe operation.
- Make sure the battery is fully charged, especially if you plan to travel long distances.
- For your safety and the safety of others, follow the speed limit and ride only at speeds you are comfortable with, and be ready to stop at any time.
- Keep a safe distance from fellow riders to avoid collisions.
- Pay attention to your surroundings. Your eyes are your best tools for safely avoiding obstacles and unsafe surfaces.
- Ride in open spaces and flat areas. Avoid slopes or high traffic areas until you're familiar with riding.
- Do not ride at high speeds, on uneven terrain, in inclement weather, or otherwise unsafe conditions.
- Never use the E-Bike to do anything that may cause personal injury or property damage.
- Do not attempt to carry passengers or heavy items. The bike can only support the weight of one person at a time. Do not exceed the weight limit.
- Only ride the E-Bike where permitted. You MUST comply with local laws and yield to pedestrians.

## **USE CAUTION AT TRAFFIC STOPS**

### **ADJUST THE ASSIST SPEED TO 0 OR HOLD THE BRAKE TO PREVENT UNWANTED ACCELERATION**

## **5.1 Before Your First Ride**

Before each ride, check whether the quick-release screws and saddle are loose and whether the brakes are effective. Inspect gears, examine brakes and check tire pressure. Proper tire inflation can reduce flats and improve performance, including travel distance per charge.

Check if the battery is fully charged before a long journey.

## **5.2 Routine Bike Inspections**

Routine inspections before and after every ride will help you maintain optimal bike performance and catch potential problems before they turn into safety concerns. Regularly check brakes, seat, and tire pressure.

## **5.3 Semi-Annual Bike Mechanic Inspections**

Bikes require regular maintenance. Take your bike to your local bike shop for a tune-up twice yearly. Complex components should always be inspected, serviced and adjusted by experienced mechanics.

## Section 6. Maintenance

Do not perform any kind of maintenance while the E-Bike is powered on or charging.

Before each ride, check whether the quick-release screws are loose and whether the brakes are effective.

Check the handlebars and screws once a week, and charge at least once in three months.

### 6.1 Battery Maintenance

- Do not store or recharge the battery exceed the specified temperature range 20°C-25°C / 68°F-77°F. Do not pierce the battery. Refer to local laws and regulations on battery recycling and/or disposal.
- A well-maintained battery can perform well even after riding for high mileage. Recharge the battery after each ride to prevent the battery from draining completely. When used at room temperature (70°F [22°C]), the battery range and performance are at its best; however, using it at temperatures below 32°F (0°C) will reduce the range and performance. Generally, the range of -4°F (-20°C) can be as low as half of the same battery at 70°F (22°C). When the temperature rises, the battery life will be restored.



#### NOTE:

Generally, a fully charged battery can maintain power for 90 days in standby mode. The low-power battery can maintain power for 30-60 days in standby mode. Remember to charge the battery after each use. Draining the battery may cause permanent damage to the battery. The electronics inside the battery record the charge and discharge of the battery; damage caused by over-discharge or under-discharge is not within the limited warranty.



#### ATTENTION:

- Do not attempt to disassemble the battery. Risk of fire hazard.
- When the ambient temperature exceeds the machine operating temperature (see specifications), do not ride, because low/high temperature will limit the maximum power/torque. Doing so may cause personal injury or property loss due to slips or falls.

### 6.2 Cleaning

Proper cleaning of your E-Bike can guarantee a longer lifespan and a smooth-riding experience.

Before cleaning, make sure that the power has been turned off and the charging cable has been unplugged, otherwise, you may damage the electronic components.

- Wipe the outer body of your E-Bike with a soft, dry microfiber cloth.
- Check around the wheels and ensure there is no blockage. The E-Bike's design allows for easy wheel maintenance.

- The E-Bike meets IPX4 water resistance, meaning it can withstand splashes; however, do not submerge the E-Bike in water.
- Do not let water and liquids get into the E-Bike's electric parts or battery.

 **NOTE:**

Do not use alcohol, gasoline, acetone, or other corrosive/volatile solvents to clean the bicycle. These substances may damage the appearance and internal structure of your bicycle.

### 6.3 Storage

Below are some tips to consider when storing your TOTEM E-Bike.

- Before storing, fully charge the E-Bike to prevent battery over-discharge due to non-use.
- If storing the E-Bike for more than one month, discharge and recharge the battery at least once a month.
- Cover the E-Bike to keep dust out. Do not store in a dusty environment as this may cause damage over time.

 **NOTE:**

Store your bicycle in a cool and dry place. Do not store it outdoors for too long. Exposure to sunlight and extreme temperatures (whether hot or cold) will accelerate the aging process of plastic parts and may reduce battery life.

### 6.4 Disposal at End-of-Life

This product must not be disposed of by incineration, landfilling, or mixing with household trash. Improper disposal of the battery contained within this product may result in the battery heating up, rupturing, or igniting which may cause serious injury.

The substances contained inside the battery present chemical risks to the environment. The recommended disposal for any TOTEM product at its end-of-life is to dispose of the entire unit at or through an e-waste recycling center, program, or facility.

Local regulations and laws about the recycling and disposal of lithium-ion batteries and/or products containing them will vary according to country, state, and local governments. You must check laws and regulations corresponding to where you live to properly dispose of the battery and/or unit. It is the user's responsibility to dispose of their waste equipment properly in accordance with local regulations and laws.

For additional information about where you should drop off your batteries and electrical or electronic waste, please contact your local or regional waste-management office, your household waste disposal service.



## Section 7. Specifications

ITEM	Parameters
Net Weight	55.1 lb. / 25kg
Product Dimensions	73x17x44 in. / 1860x430x1130mm
Package Dimensions	67*11*33 in/ 1700*290*850mm
Max Gradient	15 % (Percent)
Max. Capacity	250lb. / 113 kg
Max. Speed	20 mph / 32 km/h
Range	20-40miles/30-60km
Motor	350W
Battery Voltage	36V 10.4 AH
Charge Voltage	90-264V
Wheel Size	26 in.
Charge Time	3 hours
Water Resistance	IPX4
Storage temperature	20°C-25°C / 68°F-77°F
Operating temperature	-4°F-140°F / -20°C~60°C
Charging temperature	32°F-104°F / 0°C-40°C
Warranty	1 Year Limited

## One-Year Limited Hardware Warranty

Your TOTEM E-bike includes a One-Year Limited Hardware Warranty. The Warranty covers the manufacturer' s defects with either replacement parts or refunds issued by TOTEM. (User error: Damage caused by user error will not be covered by TOTEM. Damage caused to components through accident, negligence, or misunderstanding of local traffic regulations are examples of user error.)

TOTEM offers a warranty of Frame for lifetime ; Each Totem bike is rigorously tested and tuned by our knowledgeable technicians and engineers before it arrives to your door. If you believe that your Totem electric bike has a manufacturer' s defect, we ask that you reach out to us describing the issue. Documenting photos or videos of suspected defects will greatly improve the process for both of us. Distinguishing between damage sustained during shipping versus manufacturer' s defect is important. TotemUSA distinguishes between major and minor defects and their appropriate resolution on a case-by-case basis.

TOTEM offers 12 months Battery and Motor Warranty. But this warranty does not cover the faulty operation or failure to properly follow the manufacturer's instructions. All other parts except consumable parts are guaranteed for 12 months for problems caused by the manufacturing process or material defects. For instance: brake blocks, brake pads, brake handles, tires, and brake tubes are consumable parts. All other parts except consumable parts are guaranteed for 12 months for problems caused by the manufacturing process or material defects. For instance: brake blocks, brake pads, brake handles, tires, and brake tubes are consumable parts.

### Note:

Appearance accessories and wearable parts are not eligible for Warranty. Wearable parts including inner tubes, tires, and brake pads are not covered under the warranty.

1. Failure caused by not following the instruction manual.
2. Normal wear and tear, accident, abuse, neglect of care, improper assembly, or incorrect parts maintenance, and incorrect use of accessories by any user.
3. It is a part that will naturally wear out under normal use, and it does not apply to those who are free of charge during the aforementioned warranty period.
4. Failure to perform proper replacement and maintenance due to wear and tear of consumables, causing other parts to malfunction and damage.
5. The warranty card does not match or alter the model of the bike.
6. Damage caused by overloading, riding over obstacles (including but not limited to descending steps, falling, etc.), performing extreme sports, etc.
7. Damage caused by force majeure (such as fire, earthquake, lightning, water damage, etc.).
8. Those who exceed the warranty date.

## **TOTEM USA**

Customer service

119S Tennessee Street ,Mckinney, TX 75069

Tel: +1-812-807-1570

Website: [www.totemusa.com](http://www.totemusa.com)

January 2024 By TOTEMUSA version3

