

NARITA®

Instruction Manual



NRC-604SD
NRC-606SD

**Please read this manual thoroughly before operating this unit.
This unit must only be serviced by the authorized center.**

IMPORTANT SAFEGUARDS

When using electrical appliances, basic safety precautions should always be followed including the following:

1. Read all instructions.
2. Do not touch hot surfaces. Use handles or knobs.
3. To protect against electrical hazards, do not immerse cord, plugs, or the appliance in water or other liquids.
4. Close supervision is necessary when any appliance is used by or near children.
5. Unplug from outlet when not in use and before cleaning. Allow to cool before putting on or taking off parts, and before cleaning the appliance.
6. Do not operate any appliance with a damaged cord or plug or after the appliance malfunctions or has been damaged in any manner. Return appliance to Narita USA for examination repair or adjustment. See Warranty.
7. The use of accessories or attachments not recommended by Narita USA may cause hazards.
8. Do not use outdoors.
9. Do not let cord hang over edge of table or counter, or touch hot surfaces.
10. Do not place on or near a hot gas or electric burner, or in a heated oven.
11. Extreme caution must be used when moving an appliance containing hot liquids.
12. Always attach plug to appliance first, then plug cord into the wall outlet. To disconnect, turn any control to "OFF", then remove plug from wall outlet.
13. CAUTION: This appliance generates heat and escaping steam during use. Proper precautions must be taken to prevent the risk of burns, fires or other damages to persons or property.
14. This appliance generates steam. Do not operate uncovered.
15. Do not leave unit unattended while in use.
16. This appliance is for Household Use Only. Do not use appliance for other than intended use.
17. Do not place the Inner Pot on other heat sources (e.g. cooking stove). It may become deformed.
18. Do not block steam vent holes.
19. During or immediately after cooking, the area near the Steam Vent Hole is kept at high temperature. To avoid burns, do not touch this area.
20. To reduce the risk of electric shock, cook only in the removable container.

SAVE THESE INSTRUCTIONS / HOUSEHOLD USE ONLY

SAVE THESE INSTRUCTIONS THIS APPLIANCE IS FOR HOUSEHOLD USE ONLY

ADDITIONAL IMPORTANT SAFEGUARDS

WARNING: This appliance generates heat and releases steam during use. Use proper precaution to prevent risk of burns, fires, other injuries, or damage to property.

1. Take extreme caution when opening the Lid after cooking. Severe burns can result from steam inside.
2. Never open the Lid while the unit is in operation.
3. Do not use without the Inner Pot in operation.
4. Do not cover the steam vent with anything as an explosion may occur.
5. Do not touch the Inner Pot nor any heating parts, immediately after use.

Allow the unit to cool down completely first.

This appliance is intended to be used in household and similar applications such as:

- staff kitchen areas in shops, offices and other working environments
- farm houses
- by clients in hotels, motels and other residential type environments
- bed and breakfast type environments

BRIEF INTRODUCTIONS:

Thank you for purchasing the Narita Rice Cooker. Please follow these simple tips to get the maximum performance and satisfaction from this appliance. Use according to our instructions and it will give you years of trouble-free enjoyment.

SPECIFICATION

MODEL	RATED VOLTAGE	POWER CONSUMPTION	CAPACITY
NRC-604SD	120V/60Hz	350W	4cups / 0.8L
NRC-606SD	120V/60Hz	500W	6cups / 1.2L

PARTS IDENTIFICATION

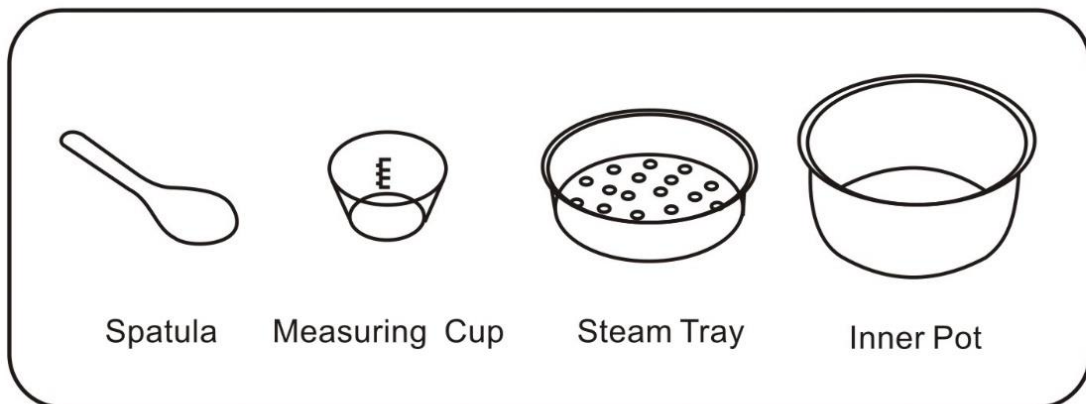
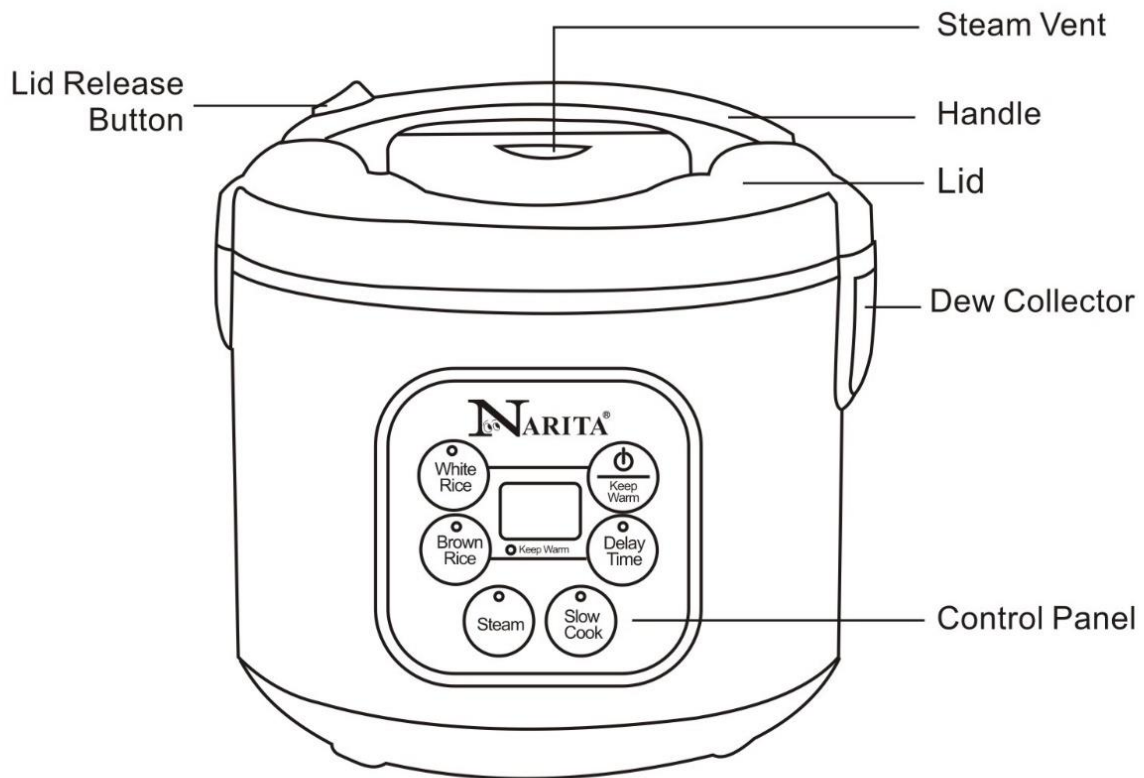

Control Panel

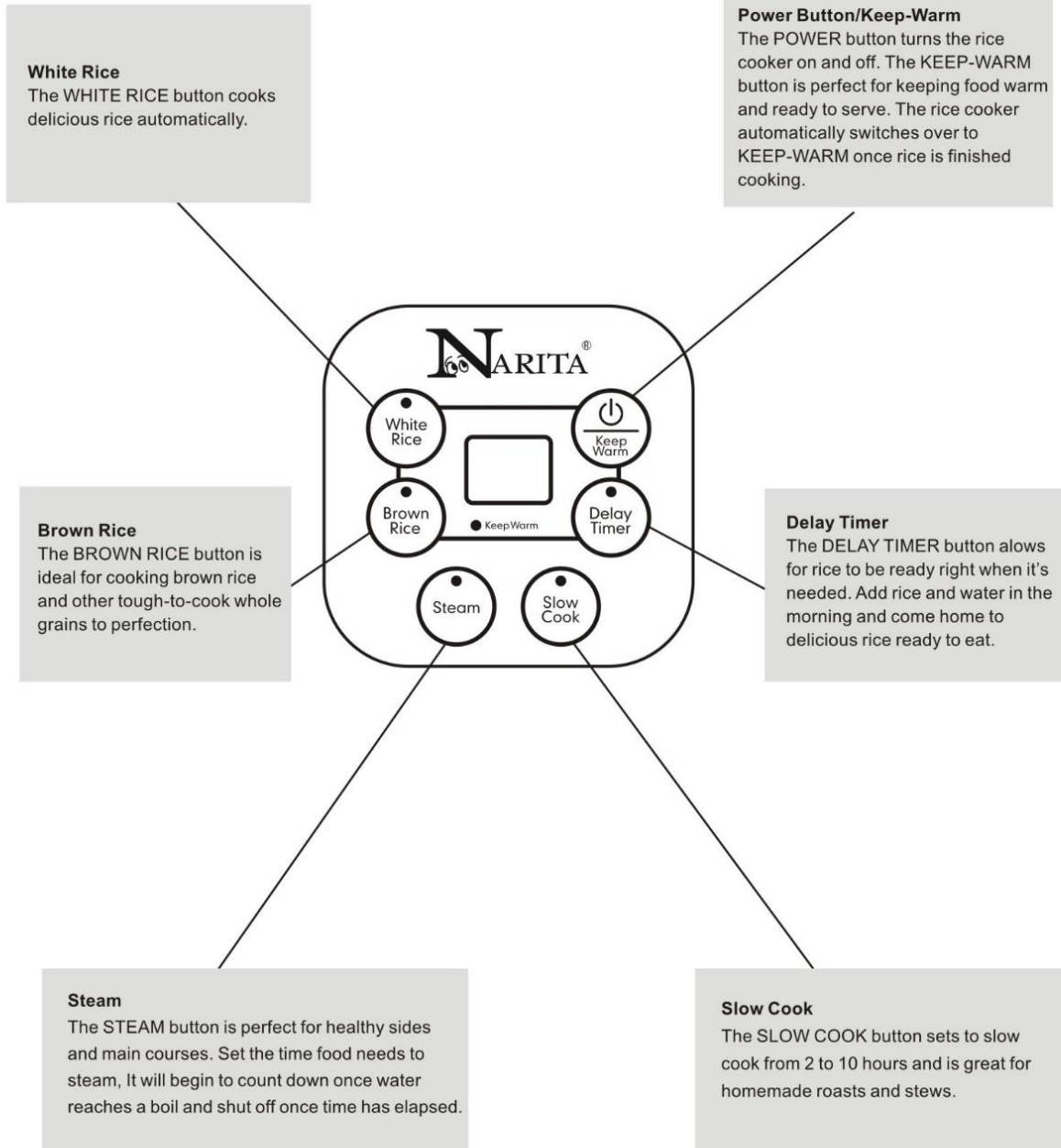

BEFORE COOKING RICE

1



Use a dry cloth to clean inner pot.

- Use a soft scrubber to wash the inner pot.
- Do not use rough or metallic scrubbers. Otherwise, coating will pilled off.
- Do not put anything that is metallic and sharp into the inner pot while cleaning. (Fork, spoon, chopsticks, knife, and etc.)

2



Measure the rice

- Always use the measuring cup supplied with the rice cooker (for rinse-free rice as well).
- A leveled filling of rice in the supplied measuring cup equals about 0.18 L.

3



Wash the rice

- Use another container to wash the rice.
- Stir the rice around with your hand in a generous amount of water, pour out the water, and repeat until the water remains clear.

4



Adjust water level

- Place inner pot on a flat surface to adjust water level.
- The marked lines in the inner pot indicate water level.
- The added water should not exceed the max line.

5

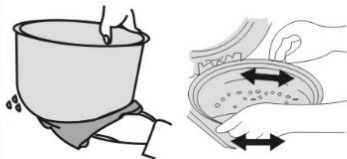

Wipe off any water and rice

<Outer surface and brim of the inner pot>
<Inside the rice cooker>

Place the inner pot in the rice cooker.

- (1) Turn the inner pot slightly left and right so it is positioned correctly without any tilt.
- (2) Close the lid. Then press the lid until you hear "click".

6







Connect each end of the power cord to the specified locations. (120V/60HZ)

Press the  key to select the desired menu.

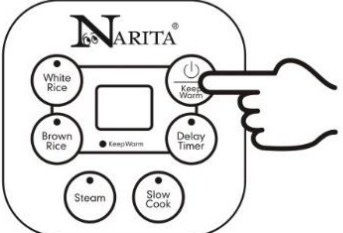
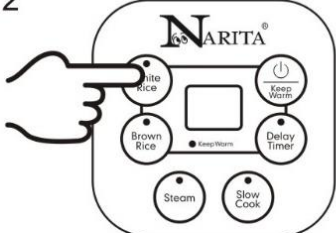
HOW TO USE





Rice

<p>1</p>  <p>Press the POWER button to turn on the rice cooker.</p>	<p>2</p>  <p>Press the WHITE RICE or BROWN RICE button, depending upon the type of rice being cooked.</p>
<p>3</p>  <p>The rice cooker will begin cooking. The digital display will show a "chasing" pattern.</p>	<p>4</p>  <p>Once rice is finished, the rice cooker will beep and ·Automatically switch to Keep-Warm. ·The digital display will show the number of hours the rice cooker has been on Keep-Warm, beginning with "0-12" hours.</p>
	<p>When finished serving rice, turn the rice cooker off by pressing the POWER/KEEP-WARM button and unplug the power cord.</p>

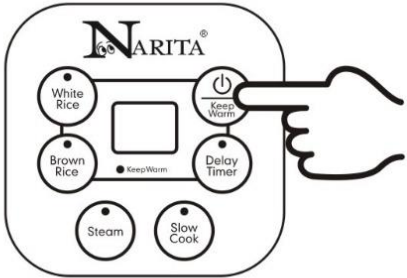
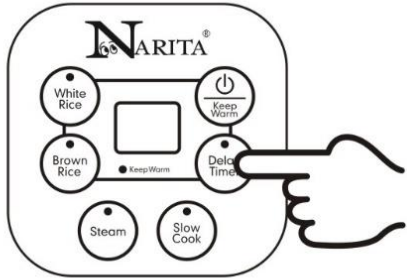
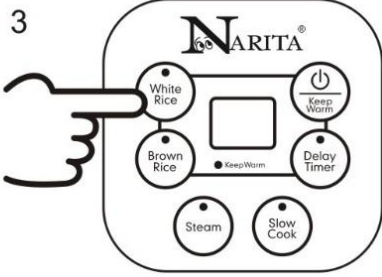

RICE/WATER MEASUREMENT TABLE

UNCOOKED RICE	RICE WATER LINE INSIDE POT	APPROX. COOKED RICE YIELD	COOKING TIMES
2 Rice Cooker Cup	Line 2	4 Rice Cooker Cup	WHITE RICE: 29-34 Min. BROWN RICE: 63-68 Min.
3 Rice Cooker Cup	Line 3	6 Rice Cooker Cup	WHITE RICE: 33-38 Min. BROWN RICE: 70-75 Min.
4 Rice Cooker Cup	Line 4	8 Rice Cooker Cup	WHITE RICE: 37-42 Min. BROWN RICE: 78-83 Min.
5 Rice Cooker Cup	Line 5	10 Rice Cooker Cup	WHITE RICE: 40-45 Min. BROWN RICE: 82-87 Min.
6 Rice Cooker Cup	Line 6	12 Rice Cooker Cup	WHITE RICE: 42-47 Min. BROWN RICE: 86-91 Min.

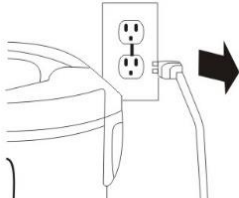



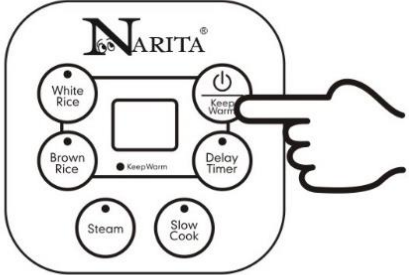
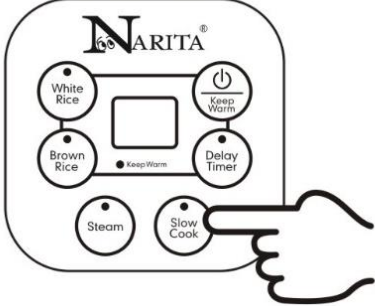

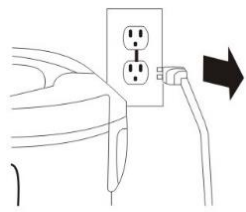
Setting the Delay Timer

<p>1</p>  <p>Press the POWER button to turn on the rice cooker.</p>	<p>2</p>  <p>Press the DELAY TIMER button. Each press increases in one hour increments. The time may be set to have rice ready in 1 to 15 hours for white rice and 2 to 15 hours for brown rice.</p>
<p>3</p>  <p>Once the needed time is selected, press the WHITE RICE or BROWN RICE button, depending on the type of rice being cooked.</p>	<p>4</p>  <p>The digital display will countdown from the time selected.</p>
<p>5</p>  <p>The rice cooker will begin cooking. The digital display will show a "chasing" pattern.</p>	<p>6</p>  <p>Once rice is finished, the rice cooker will beep and</p> <ul style="list-style-type: none"> Automatically switch to Keep-Warm. The digital display will show the number of hours the rice cooker has been on Keep-Warm, beginning with "0-12" hours.
<p>7</p> 	<p>When finished serving rice, turn the rice cooker off by pressing the POWER/KEEP-WARM button and unplug the power cord.</p>

Slow Cooking

<p>1</p>  <p>Press the POWER button to turn on the rice cooker.</p>	<p>2</p>  <ul style="list-style-type: none"> •Select the Slow Cook function. The digital display will show a flashing 2 to represent two hours of slow cook time. •Press the SLOW COOK button to increase the cook time by 1 hour increments.
<p>3</p>  <p>The rice cooker will begin to slow cook. The digital display will count down from the selected time.</p>	<p>4</p>  <ul style="list-style-type: none"> •Once rice is finished, the rice cooker will beep and automatically switch to Keep-Warm. •The digital display will show the number of hours the rice cooker has been on Keep-Warm, beginning with "0-12" hours.
<p>5</p> 	<p>When finished serving, turn the rice cooker off by pressing the POWER/KEEP-WARM button and unplug the power cord.</p>

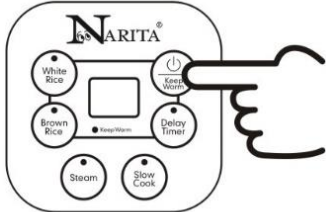
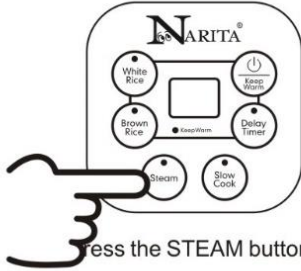
Steaming Food

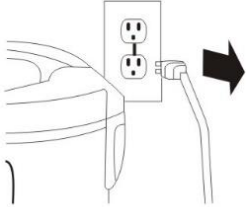
<p>1</p>  <p>Using the provided measuring cup, add 2 cups water to the inner pot.</p>	<p>2</p>  <p>Place the inner pot into the rice cooker.</p>
<p>3</p>  <p>Place food to be steamed onto the steam tray.</p>	<p>4</p>  <p>Place the steam tray into the rice cooker.</p>
<p>5</p>  <p>Close the lid securely.</p>	<p>6</p>  <p>Press the POWER button to turn on the rice cooker.</p>
<p>7</p>  <p>Press the STEAM button.</p>	<p>8</p>  <p>Each press of the STEAM button will increase steaming time by one minute, up to 30 minutes. After 30 minutes, it will cycle back to five minutes.</p>
<p>9</p>  <p>Once rice is finished, the rice cooker will beep and</p> <ul style="list-style-type: none"> Automatically switch to Keep-Warm. The digital display will show the number of hours the rice cooker has been on Keep-Warm, beginning with "0-12" hours. 	<p>10</p>  <p>When finished serving, turn the rice cooker off by pressing the POWER/KEEP-WARM button and unplug the power cord.</p>

CLEANING AND MAINTENANCE

How To Clean

Removing and attaching the inner lid:
Pull the inner lid towards you to remove it.
To reattach, align the inner lid gasket with the shaft on the main lid.

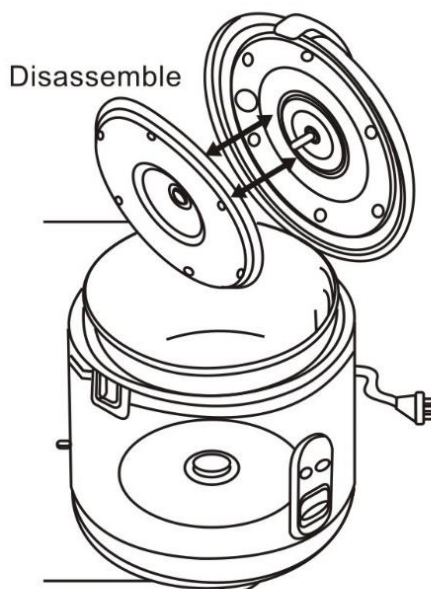

How to Clean Dew Collector

Dew Collector

- Hold the two sides of the collector, pull it up or down according to direction of the arrow in the picture.
- Clean the Dew Collector after using.

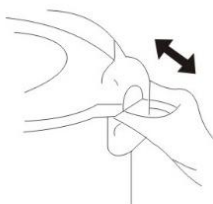

** Cleaning:

Before cleaning, please take the plug out of the power socket and unplug the cord.

Clean everything carefully including the stainless steel inner pot. Use neutral detergents to clean if necessary. Never immerse the motor base into water. Wipe the motor base with a slightly moist and soft towel or cloth.

LIMITED WARRANTY

This unit is warranted against defective materials or workmanship for one year from the date of purchase (warranty is only valid with a dated proof of purchase).

The warranty is valid for any manufacturing defects only. This warranty covers operational defects incurred in normal use and does not apply in the case of damage, abuse, mishandling, accident, or failure to follow operation instructions.

During the one year warranty period, a product with a defect will be either repaired or replaced with a reconditioned comparable model (at our option).

Any return of defective merchandise to the manufacturer must be processed accordingly by contacting customer service first to obtain the Return

Merchandise Authorization Number and freight prepaid with proof of purchase.

(Please pack your product well; we will not be responsible for damages incurred as a result of improper packing.) We will not accept any returns of merchandise without an applicable RMA#.

Narita will pay the shipping charges to ship the repaired or replacement product back to you.

**Check our website for more detail,
www.naritausa.com**