



HIGH ALTITUDES CAUTION(5,000 ft and higher)
This appliance may not shut-off properly or from boiled to keep
warm position when used at high altitudes; Use EXTREME caution!
If unit does not shut off after 10 seconds of boiling.

Electric Hot Water Dispenser

NP-2350S

NP-3850S

INSTRUCTION MANUAL

www.naritausa.com

SAFETY PRECAUTIONS

1. Read all instructions before operating
2. Use a single outlet that matches the rated power. Unplug the power cord from the outlet when the unit is not being used.
3. Be sure that the unit plug is properly inserted into the outlet. Be careful not to damage the power cord and plug.
4. Never disassemble, repair or modify the unit by yourself.
5. Never wash the unit with the water directly.
6. Allow the unit to cool down before cleaning.
7. Do not boil anything other than water.
8. Do not connect or disconnected the power plug or the unit with wet hands.
9. Close supervision is necessary when unit is used near children.
10. Do not allow the children to use the unit and do not leave the unit within the reach of infants or children.
11. Do not cover the steam vent with cloth.
12. Do not fill water exceeding the full water indicator level or below the refill level.
13. Do not try to empty leftover hot water while the lid is attached.
14. Do not open the lid or dispense hot water while it is boiling.
15. Do not use the power operated dispensing and touch dispensing when water is boiling.
16. Do not use the unit on an unstable surface.
17. Do not rotate the main unit while dispensing hot water.
18. This unit is for household use only, do not use outdoor.

This unit is warranted for defective materials or workmanship for one year from the date of purchase. The warranty is valid for any manufacturing defects only. This warranty covers operational defects incurred in normal use and does not apply in the case of damage, abuse, mishandling, accident, or failure to follow operation instructions. Narita shall have no responsibility for any damages incidental to equipment and its sole responsibility shall be for the repair or replacement as indicated, except for shipping and handling costs. There are no implied or expressed warranties of fitness or merchantability which extend beyond the above warranty.

Note: Any unit for reimbursement or repairing should be sent back with original complete box to the authorized service representative.

If the supply cord is damaged, it must be replaced immediately by the manufacturer or their service agent.

MODEL	HEATING POWER	KEEP WARM POWER	CAPACITY	VOLTAGE
NP-2350S	750W	35W	2.3L	120V/60Hz
NP-3850S	750W	35W	3.8L	120V/60Hz

Name of Components

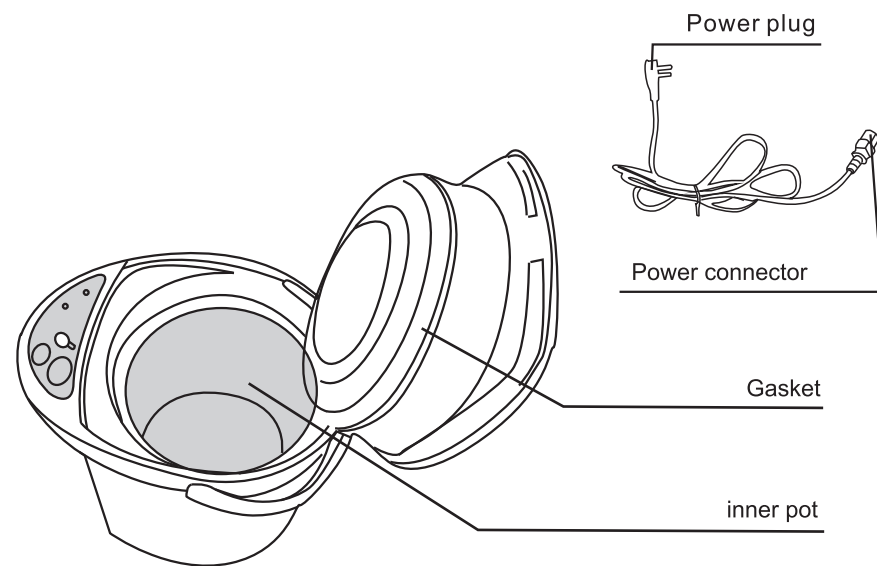
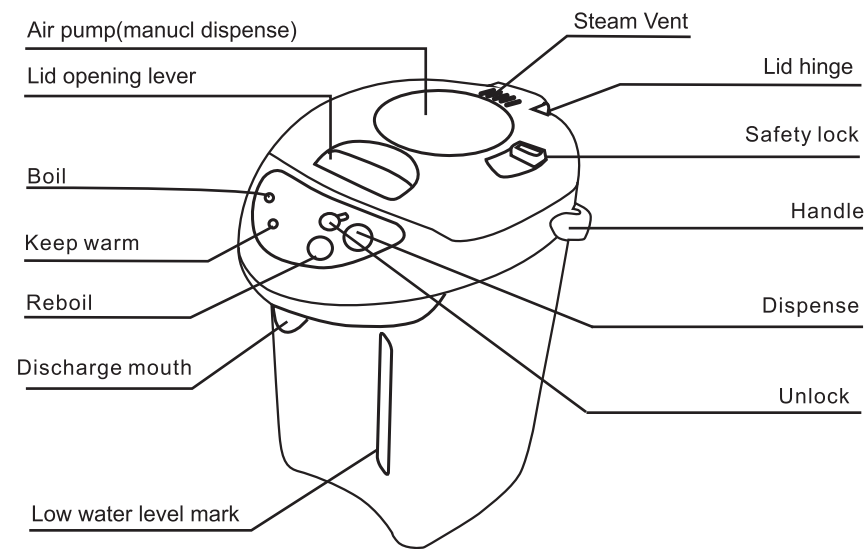

Operating Instruction

1、Uncap

Raise up the top lid to open the top lid.



2、Filling water

Filling water anywhere between the "full" mark and the "REFILL" mark.

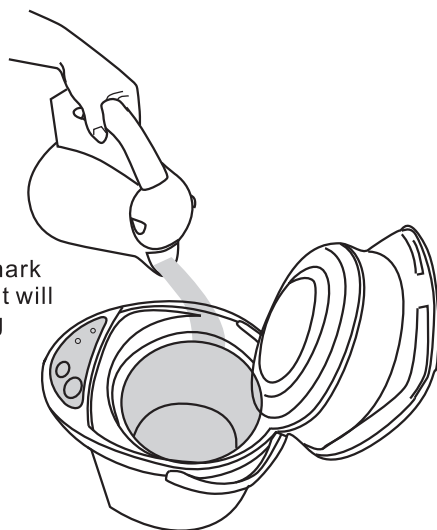

NOTICE

Never allow water to fill over the "full" mark or below the "REFILL" mark, otherwise it will spill over or water will dry up during boiling process.

Special notice

Special electric component

Do not use any other type of cord. Use only the original power cord provided.

To prevent scalding

Be careful of steam from the steam Vent, hot steam can cause scalding steam burns and are very dangerous.

Ensure the cover is closed well

It is very dangerous when the cover is not closed well, hot steam may escape and it may cause the lid to deform.

No dry-boiling(Boiling without water)

Dry-boiling will cause the container to deform.

Do not pour in any liquid except water

Do not pour milk, tea, etc into dispenser

Suitable environment

Do not use it near fire keep it away from wall and furniture.

Insert plug completely into jack socket.

Cleaning and maintenance

First disconnect the plug from electrical outlet drain the hot water completely and clean out after the body cools down.

Lid and main unit

With dirt off with soft dry cloth.

Inner pot

wash/wipe with sponge

Inner pot shows signs of being covered with scale

While you are using this unit, minerals dissolved in the water can get stuck on the inner pot.

This is call scaling, and it is not harmful

To maintain the pot's performance, clean the pot once every three months by using citric acid

How to clean the pot with citric acid

Due to the impurity in water, there may be some discolouring of steel surface. Remove discolouring through procedures below.

1. Fill lemon water to the "full water" mark.
2. Boil it and keep it in the pot for about an hour, then empty jar and clean it with a soft cloth.
3. To remove taste, boil water again and pour it out. Repeat procedure until taste is gone.

Notice

Do not wipe off dirt with soap powder, scrubbing-brush, solvent grind powder, etc.
Do not splash or immerse the body or electric component with water to avoid getting an electric shock.

3. Electric outlet

Insert plug into the electric outlet. the boil light will light up when boiling begins.

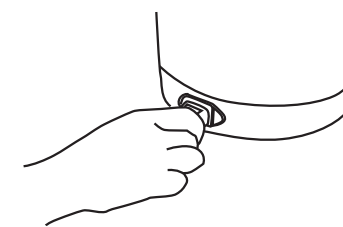

NOTICE

Please ensure the plug and electric outlet are dry before inserting the plug.

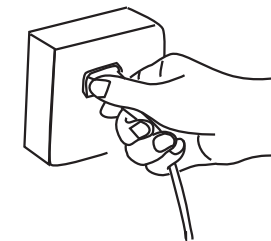

4. Boiling, keep warm

When the water is boiled, the dispenser will automatically switch to keep-warm function. The boil light will turn off and the keep-warm light will light up.

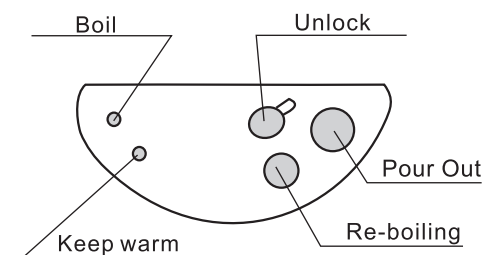

NOTICE

Do not open the top lid when water is boiling to avoid steam burn by hot steam.

5. Getting boiling water

Press water-out button. Water will come out. the spout. If you release, water will stop coming.



Three modes of water dispensing

- (1) Air pressure water dispense
Turn on the safety lock, press the Pneumatic pressure button, water will come out.
- (2) Electric pump water dispense
Press the Dispense button, water will come out.
- (3) Easy touch water dispense
Press the discharge mouth switch with cup and water will come out.

6. Refill

Refill water before the water falls below the mark "REFILL" in order to avoid dry-boiling.

REFILL



NOTICE

Do not open top lid while water is heating

Store

Disconnect the power cable, move top lid, pour out water, and then wipe with dry cloth.

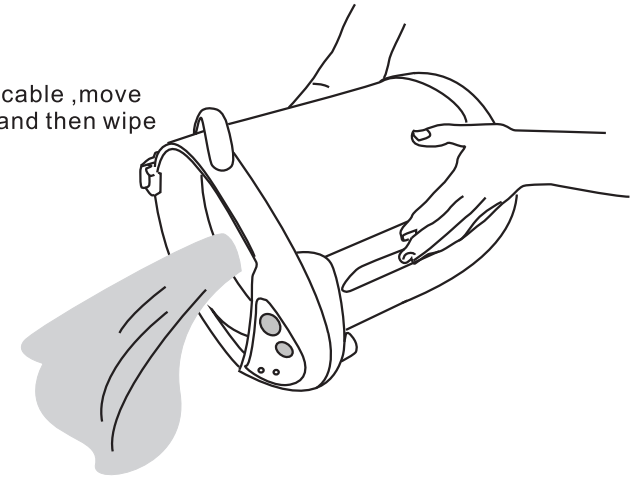

NOTICE

Be sure not to pour out water in the front of the "water flowing" button or in the back of it.

Remove top lid

- (1) Opening top lid.
- (2) Press the Lid hinge. lift lightly, then it can be taken off.

