

# CRUSADER AV

*Classroom aids to make life easier*

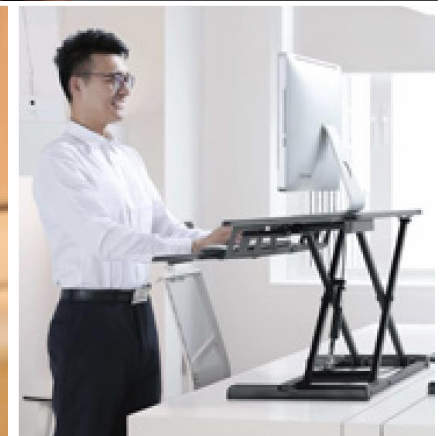



In addition to providing a growing range of reliable robust classroom computer accessories, Crusader has always supplied and installed a carefully selected range of technology-based solutions.

Every year we carefully investigate new products and reject any that we feel are not value for money, where the supplier does not match our grand expectations or where the solution offered simply does not work as documented.

As a result of our careful supplier qualification, we have built a strong relationship with the leading brands of Interactive Screens and several of the market leading software-based solutions.

We have also searched to find quality products from manufacturers that have perhaps come to the market later than the leading brands. These less well-known manufacturers have lower overheads and therefore offer their products at more competitive rates than the big-name brands.

All our products are offered on a "Try before you buy" basis so that you can establish for

yourself that although the brand name may not be familiar to you the product is of the highest quality and offers exceptional "value for money" and is not just a cheap price with less functionality and support.

We can only show a small selection of the products we offer within this catalogue.

If you have a specific requirement, please call and we will offer our expert advice on what we consider to be the most effective solution at the best possible price. Before you decide, we will demonstrate our solution working and if practical, let you try it in your own environment.

Over the last 35 years we have established an enviable reputation by ensuring we offer our customers the absolute best products at the most competitive rates.

**EASY2USE®**



**ViewSonic®**  
*See the difference.®*



**VESTEL**

**SAMSUNG**

**MAXHUB**



Steel Tensioned Headband

Washable Soft Ear Cups replacements in spares pack

Discrete Volume Control

In Built Microphone

Choice of 3 Detachable Braided Cables

1 x 4 Pole 3.5mm jacks or 2 x 3.5mm jacks or USB2 connection

Cotton bag included FREE with each pair of headphones

# EASY2USE®

## Unbreakable Headphones<sup>(well almost)</sup>

Robust, flexible, headphones specifically designed for use within the school environment.

Product	Code	Ex Vat	Inc VAT
Headphone, drawstring bag and braided Cable with 4 pole 3.5mm jack	S9255	£11.00	£13.20
Headphone, drawstring bag and braided cable with 2 x 3.5mm audio jacks	S9615	£11.00	£13.20
Headphone, drawstring bag and braided cable with USB 2 Connection	S8967	£12.00	£14.40
Spares	Code	Ex VAT	Inc VAT
Braided cable with 4 pole 3.5mm jack	S9087	£1.99	£2.39
Braided cable with 2 x 3.5mm audio jacks	S9471	£1.99	£2.39
Braided cable with USB 2 connection	S9351	£2.49	£2.99
Spares Pack	S9183	£2.49	£2.99

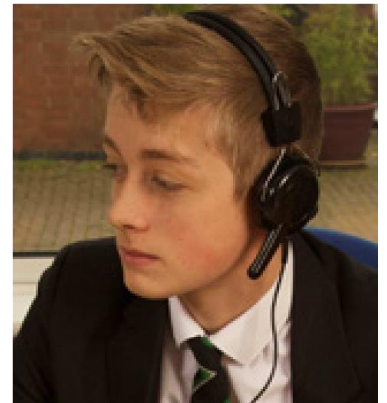

### Spares Pack

Product Code: S9183

Contains:

- 2 washable soft ear cups
- 2 foam pads
- 2 plastic fixing rings

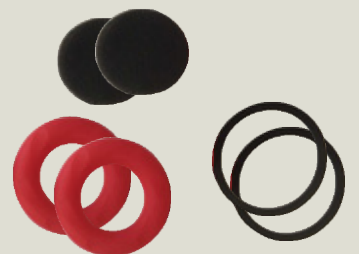



# EASY2USE®

## Quality Headphone with microphone, braided cable with a 4 pole jack - Purple

The Easy2Use S113 headphone is a mid-sized headphone for all students which has become the popular choice with schools across the country.

Its classic design is both attractive and durable. It has unchallenged sound quality for its price point.

Designed and built for a classroom environment. Crusader's Easy2Use headphones are known for quality, durability, and economical price.

Product	Code	Ex Vat	Inc VAT
Purple Headphone with 4 Pole connector	S113	£8.75	£10.50



## Heavy Duty Robust Headphones, Microphone with a 4 pole jack

The NEW Easy2Use S114 robust heavy-duty full-size headphones has been designed to survive heavy use yet be extremely comfortable during extended use. With an anatomical and comfortable design, the headset also has a robust boom microphone that rotates in 90 degrees perfectly adapting to the choice of the user. In addition, the sound quality and precise audio are impeccable ensuring the highest concentration during use.

Product	Code	Ex Vat	Inc VAT
Heavy Duty Robust Headphones	S114	£12.00	£14.40



## Foldable, Lightweight yet Rugged Black/Blue headphone Braided cable Mic with a 4 pole jack

This Easy2Use S902 children's headphone offers enough durability to be used daily in our busy education system.

Your classroom will delight in the crisp sound put out by the dual Sound Stage drivers in these stereo headphones. Soft, hypoallergenic ear cushions so they can listen for hours in complete comfort.

Product	Code	Ex Vat	Inc VAT
Foldable, Lightweight Black/Blue headphone - 4pole	S902	£9.50	£11.40



# EASY2USE®

## Lightweight Black/Blue Headphone braided cable microphone with a 4 pole Jack

This stereo lightweight headphone is perfect for today's busy classroom. These headphones offer a fully adjustable lightweight headband with comfortable ambient noise reducing ear cups and a 1.8M durable braided cable featuring an in-line microphone and volume control.

Product	Code	Ex Vat	Inc VAT
Lightweight Black/Blue Headphone – 4 pole Jack	S112	£7.50	£9.00



## Mk1 Robust Headphone & Microphone for Tablet, Fixed Cable with a 4 Pole Jack

Designed for KS 2 – 5 pupils to be the most long-lasting headphones, ideal for school use in IT suites, computer and foreign language labs, classroom, or offices. This version is suitable for use with tablets, chrome books and some smartphones.

Product	Code	Ex Vat	Inc VAT
Mk1 Robust Headphone - 4 Pole Jack	S10016	£10.25	£12.30



## Lightweight Black/Blue Headphone braided cable microphone with a 2 x 3.5mm audio Cable

This stereo lightweight headphone is perfect for today's busy classroom. These headphones offer a fully adjustable lightweight headband with comfortable ambient noise reducing ear cups and a 1.2M durable braided cable featuring an in-line microphone and volume control.

Product	Code	Ex Vat	Inc VAT
Lightweight Black/Blue Headphone - 2 x 3.5 connectors	S111	£7.50	£9.00



## Mk1 Robust Headphone and Microphone with a fixed 2 x 3.5mm audio cable

The ultra durable design includes a steel tensioned headband that can be twisted and bent right back on itself.

With a short, fixed microphone that cannot be removed so is not a distraction.

Product	Code	Ex Vat	Inc VAT
Mk1 Robust Headphone - 2 x 3.5mm audio cable	S10015	£10.25	£12.30



# Almost Unbreakable Headphones

## 85dB Limited, Flexible

The World Health Organisation (WHO) and most auditory health bodies have stated that 85dB is a recommended maximum noise level for young children's hearing, as noise levels above this can permanently damage their hearing. Headphones rather than ear plugs, or earbuds are also recommended as ear plugs/buds are not limited and the noise vibrations are closer to the child's delicate working of the inner ear, and therefore loud sound can do more damage. It is also recommended that even with volume limited headphones that children are limited to two hours listening with headphones per day.

Product	Code	Ex VAT	Inc VAT
Purple headphone	S16703	£10.50	£12.60

### Cotton Drawstring Bag for Headphones



Perfect for storing and protecting your headphones and accessories, also preventing a tangle of cables. Dimensions: 19cm x 23cm (7.5" x 9") approx.

Product	Code	Ex VAT	Inc VAT
Cotton Bag	S12552	£1.66	£1.99

Robust, flexible made from safe, non-toxic soft EVA bendable foam



Perfect for early years children



These headphones grow with your children. When the headphones start to get tight, simply remove the adjuster pad. The perfect fit every year.





# EASY2USE<sup>®</sup>

## Flexible Children's Headphones

- Sound limited to 85Db
- Children's hearing protected
- Soft ear Panels
- Adjustable design
- Detachable cable with microphone (choice of either 1 x 4 pole or 2.35 mm jacks)
- Sharing port – no need for a splitter (headphones can be connected together to share audio)

*Made from safe, flexible, strong, lightweight, food grade special EVA*



85dB  
Volume limited to 85db

Colour





Product code 4 pole cable

EX vat

INC Vat

**ONLY**  
**£12.00**  
Ex VAT

Choice of 5 colours

	Black	S16712	£12.00	£14.40
	Blue	S16711	£12.00	£14.40
	Orange	S11948	£12.00	£14.40
	Red	S11947	£12.00	£14.40
	Green	S597	£12.00	£14.40

Call us  
today for  
a quote

If you would like to define the contents of your own classroom set, for example with keyboards, mice or even a visualiser, please give us a call and we will be pleased to prepare a quotation for you.

## EASY2USE®

### Classroom Headphone sets

Crusader will be pleased to provide you with a competitive Classroom Headphone Set. We can supply a classroom set of headphones of your choice, each individually packed in a cotton drawstring bag (so that cables do not get tangled or lost), and all are held in a durable plastic box for ease of storage. Please call us to discuss your needs and we will be pleased to provide a competitive quote.

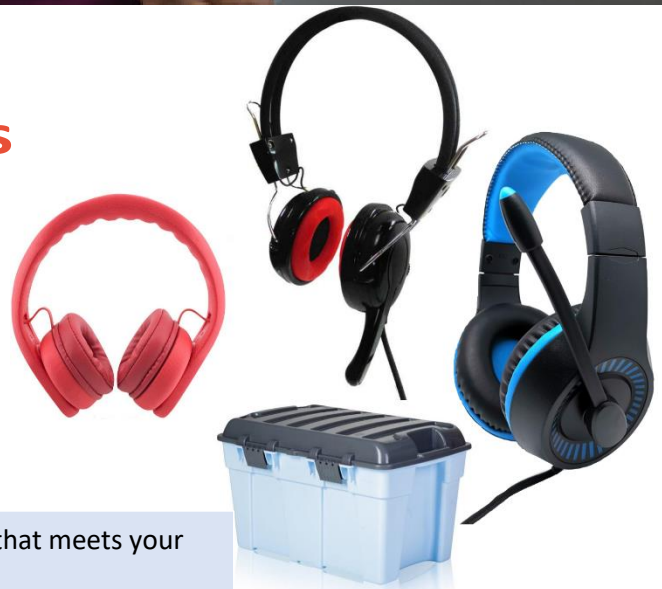

Your choice of size that meets your classroom needs:

- 24 classroom headphone set
- 32 classroom headphone set

### A7 TWS True Wireless Stereo Earbuds

V5.0 + EDR earbud with microphone



Handsfree  
in-ear quality  
headset

Our wireless stereo earbuds A7 utilize the latest TWS (True Wireless Stereo) wireless technology, the audio frequency range is similar to a WIFI signal. With many years of wireless experience and a unique expertise in sound quality, the wireless earbuds guarantee superior sound and call quality. Experience up to 9 hours of music or talk time, whether you are listening to songs or answering calls, relish in the freedom of true wireless and easy connectivity. You will enjoy the ultimate comfort and secure fit that comes with being truly wireless.

Product	Code	Ex Vat	Inc VAT
Wireless earphones	S9234	£19.99	£23.99



# Headphone Splitter / Adapter



## 2 x 3.5 mm (F) to USB (M) Headphone Adapter

Adapter lead to convert headphones from 2 x 3.5 mm plugs (headphone and microphone) to USB for plugging into PC.

Code	Ex Vat	Inc VAT
S16531	£4.12	£4.94



## 6.35 mm (M) to 2 x 6.5 mm (F) Adapter

6.35 mm Male to 2 Female.

Code	Ex Vat	Inc VAT
S10010	£2.08	£2.50



## 3.5 mm (M) to 2 x 3.5 m (F) Adapter

This 3.5 mm adapter splits the audio signal from you iPod, MP3 Player, Portable CD players, Computer, or any audio device with the 3.5 mm stereo jack to headphones or multiple speakers.

Code	Ex Vat	Inc VAT
S10009	£1.66	£1.99



## Headphone Audio Signal Splitter 1x8

Connect up to 8 headphones to one audio source.

Volume of each output channel separately controlled.

Powered by the USB port and no external power is needed.

Code	Ex Vat	Inc VAT
S180	£30.00	£36.00



## 3 port USB hub with in built multi-card reader

Our combined unit provides a 3 port USB 2.0 hub as well as a reader for SD/MMC/M2/MS and MP cards.

Powered by the USB port and no external power is needed.

Code	Ex Vat	Inc VAT
S9231	£5.99	£7.19



# Children's Keyboard



## Large Lower Case Print Children's Keyboard

This plug and play USB Easy2Use keyboard has been printed with large sharp contrast lower case letters on extra-large key tops.

The key tops are approximately the size of a 50 pence coin and are produced in different colours to easily identify:

- Consonants
- Vowels
- Numbers
- Punctuation
- Function keys
- Control keys

**ONLY**  
**£14.99**  
 Ex VAT



Standard Size

typeface

Product	Code	Ex VAT	Inc VAT
Children's Keyboard	S12004	£14.99	£17.99



# EASY2USE®

## Adult Keyboard

Large keys, large sharp contrast print keyboard which has responsive touch for speed and comfort



### Adult Keyboard for those with Poor Sight

This plug and play USB Easy2Use keyboard has been printed with large sharp contrast black letters on extra-large easy to read square white key tops.

The key tops are approximately the size of a 50 pence coin and are easy to see for users with poor eyesight or special needs.

**ONLY**  
**£14.99**  
Ex VAT



Standard Size  
Typeface

Product	Code	Ex VAT	Inc VAT
Adult Keyboard	S12005	£14.99	£17.99





# EASY2USE®

## Large Font High Contrast Standard Keyboards

ONLY  
£10.99  
Ex VAT

If your eyes have ever become tired after a long session at the keyboard, or you sometimes find it difficult to focus on the small print on industry standard keyboards, then this keyboard may be the answer for you.

Our Easy2Use plug and play USB 104 key large front keyboards have been produced with standard sized keys but printed with a large bold sharp contrast font, making them easy to use when your eyes are tired, and it is more difficult to focus on the small printing on the usual keyboards. There are three alternatives available currently.



Standard Size  
Typeface

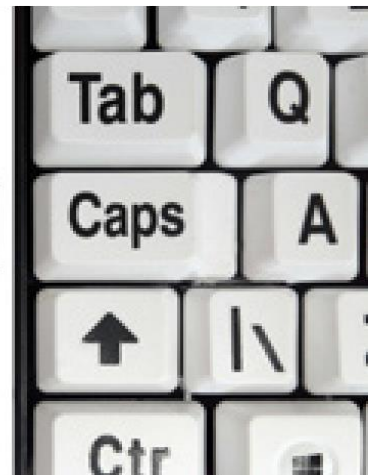

Easy2Use  
sharp contrast  
key top and font

Product	Code	Ex VAT	Inc VAT
Black Printing on White Key Tops	S12006	£10.99	£13.19



Standard Size  
Typeface



Easy2Use  
sharp contrast  
key top and font

Product	Code	Ex VAT	Inc VAT
White Printing on Black Key Tops	S16514	£10.99	£13.19



Standard Size  
Typeface



Easy2Use  
sharp contrast  
key top and font

Product	Code	Ex VAT	Inc VAT
Black Printing on Yellow Key Tops	S12007	£10.99	£13.19

For details of our wi-fi and value for money standard keyboards please give us a call or look on our website

### USB Optical Mouse

This mouse is easy to control and a joy to use compared to many, it is a great “all-rounder” matching up to expectations in the office, retail, education, and home environments.

- Black case and buttons
- Optical tracking technology with 800 dpi resolution
- Contoured and shaped to fit comfortably in your hand
- Ideal for left- or right-hand usage
- Full size mouse comfortable and ideal for everyday use
- Integrated scroll wheel
- 3 buttons with 1 million life cycle switches
- Easy glide Teflon feet
- Cable length 1.8 metres

Product	Code	Ex VAT	Inc VAT
USB Optical Mouse	S11244	£4.99	£5.99



**ONLY**  
**£4.99**  
**Ex VAT**

### Easy2Use USB Mini Optical Mouse with 1.8m Lead

This mouse is easy to control and a joy to use compared to many, it is a great “all-rounder” matching up to expectations in the office, retail, education, and home environments.

- Black case and buttons
- Contoured and shaped to fit comfortably in your hand
- Ideal for left- or right-hand usage
- Cable length 1.8 metres

Product	Code	Ex VAT	Inc VAT
USB Mini Optical Mouse	S16753	£4.12	£4.94

**ONLY**  
**£4.12**  
**Ex VAT**



### Easy2Use Blue Wireless Mouse

The wireless mouse for laptop / desktop PC, plug and play. Wireless convenience, freedom-fast data transmission and virtually no delays or dropouts

Powerful, reliable 2.4GHz optical mouse wireless connection with high anti-interference performance and 10M transmission distance, comes with a Nano receiver.

Product	Code	Ex VAT	Inc VAT
Easy2Use Blue Wireless Mouse	S515	£6.50	£7.80

**ONLY**  
**£6.50**  
**Ex VAT**



### Robust Long Lasting Educational Optical Mouse with braided cable

3D optical scroll mouse built with a braided cable to prevent damage from chair wheels etc or (even being chewed).

The mouse can be configured for left hand users through the control panel of the computer the mouse is being used with.

The buttons have been designed so they are almost impossible to prise off. USB cabled connection.

Product	Code	Ex VAT	Inc VAT
Black Optical Mouse	S16564	£5.50	£6.60

**ONLY**  
**£5.50**  
**Ex VAT**



# EASY2USE®

## Left-Handed Ergonomic Wireless Mouse

The ergonomic design of this mouse encourages healthy neutral “handshake” wrist and arm positions for smoother movement and less overall strain. This mouse can help alleviate existing wrist, hand, and arm pain by correcting improper mousing techniques. It can also help prevent any problems in the future by promoting a neutral mousing position and relaxed grip.

# EASY2USE®

**SALE!**  
**£16.25**  
**Ex VAT**



Product	Code	Ex Vat	Inc VAT
Left hand ergonomic mouse	S526	<b>£16.25</b>	£19.50

## Right-Handed Ergonomic Wireless Mouse

The ergonomic design of this mouse encourages healthy neutral “handshake” wrist and arm positions for smoother movement and less overall strain. This mouse can help alleviate existing wrist, hand, and arm pain by correcting improper mousing techniques. It can also help prevent any problems in the future by promoting a neutral mousing position and relaxed grip.

# EASY2USE®

**SALE!**  
**£16.25**  
**Ex VAT**



Product	Code	Ex Vat	Inc VAT
Right hand ergonomic mouse	S520	<b>£16.25</b>	£19.50





# EASY2USE®

## Children's USB Starta Mice

Specifically designed for a child's small hand, features either a brightly coloured yellow body with bright **blue left and red right** click buttons and plastic scroll wheel, to teach young children the differences when learning to use the computer in the class room or at home. Alternatively you can have an all-black rugged small mouse with smooth cursor control. Both are supplied with a braided cable.

The mouse can be configured for left hand users through the control panel of the computer the mouse is being used with.



Colour	Product Code	Ex VAT	Inc VAT
 Yellow Body	S16538	£4.99	£5.98
 Black Body	S16563	£4.16	£4.99

## Childrens Computer Starta Mouse USB - Orange

Specifically designed for a child's small hand

Features brightly coloured ORANGE body with bright Blue Left and Red Right click buttons and clear plastic scroll wheel, to teach young children the differences when learning to use the computer in the classroom or at home.

The mouse can be configured for Left Hand users through the control panel of the computer the mouse is being used with.

# EASY2USE®



Product	Code	Ex Vat	Inc VAT
Childrens Starta Mouse - Orange	S16562	<b>£4.16</b>	£4.99

# EASY2USE®



## Megapixel Goose Neck Visualiser U600L

This low cost EASY2USE visualiser / document scanner is supported by powerful enhanced software to make this a very versatile and portable product.

This 5 mega pixel excellent quality auto focus facility visualiser that includes a slot so that you can use a Kensington style anti-theft cable and lock, making it ideal for use in public areas.

Maximum resolution of 2560 x 1920 the camera is precise, and the video response is extremely fast at lower resolutions.

Product	Code	Ex Vat	Inc VAT
Megapixel Goose Neck Visualiser	S600	<b>£99.99</b>	£119.99

# EASY2USE®

## A3 8Mp HD Auto-Focus 100x Digital Zoom Document Scanner / Visualiser

Code	Ex Vat	Inc VAT
S955	<b>£165.00</b>	£198.00



*One touch on the button and the automatic focus feature produces a clear picture*

**SALE**  
**£165.00**  
Ex VAT

# EASY2USE®

Code	Ex Vat	Inc VAT
S950	<b>£110.00</b>	£132.00

## A3 8Mp Document Scanner / Visualiser



*No mains power needed*

S950 S955

8.0 mega pixel camera produces bright and clear HD images (max 1080p resolution)	✓	✓
Image capture, audio, and video recording	✓	✓
Supports HDMI, VGA and DVI video outputs	✓	✓
Auto focus	✓	✓
Digital zoom	5x	100x
Includes 11 high brightness LED lights to provide vivid colour presentation even in low-light conditions	✓	✓
Can be directly connected to monitors, projectors, interactive boards, and screens	✗	✓
Large A3 (420mm x 297mm) image capture area	✓	✓
Easily adjusted arm and rotating camera head	✓	✓
This visualiser does not need software running on an attached PC to operate, everything is built into the scanner itself	✗	✓
Remote controller included	✗	✓
Max 30fps frame rate delivers smooth and vivid live videos	✓	✓
Audio and video recordings can be saved and played from inbuilt SD card	✗	✓
Powered by the DC 12v adaptor supplied	✗	✓
Powered via USB cable	✓	✗

## Desktop Monitor Stands

We are pleased to introduce you to a beautifully designed range of elegant White Birch monitor risers.

They are stunning from every angle and will raise your monitor to a height which will assist to reduce eye strain and discomfort at your desk.

They will fit screen sizes from 17" to 32" and support a maximum weight of 20kg (44lbs).



**FROM  
£14.95  
Ex VAT**

3 options to choose from



S12034



S16549



S16897

### Product

White Birch Monitor Risers

554mm (21.8") wide x 215mm (8.5") deep

Code Ex VAT Inc VAT

100 mm (4") Height S16549 £14.95 £17.94

100 mm (4") Height and Drawer S12034 £20.79 £24.95

80 mm (3.1") Height With 3 USB Ports S16897 £24.96 £29.95



# Sit Stand Workstations

## Scissor Lift Sit Stand Desk with Keyboard Tray

Ergonomic, easily adjustable, sit-stand desk, scissor lift, sturdy. Sit or stand at your desk and lessen the effects of sitting for extended periods. Reduce eye, neck, back and joint pain.

By squeezing the handle, the user can adjust the height of the desk effortlessly. The mechanism is gas-sprung to create a smooth and quick transition. The height adjusts between 4 inches (11 cm) from the surface of the table to 19.9 inches (50.5 cm) giving you options to alternate between sitting and standing.

There is a dual tier 32-inch (81cm) work surface, and the keyboard tray has extra storage built in for a phone, tablet, and other accessories. It can easily accommodate a dual screen set up. The stand is black metal and will hold up to 15 kgs in weight. The keyboard tray can take weights up to 2 kgs.



Code	Ex Vat	Inc VAT
S16699	£129.58	£155.50

## Ultra Slim Gas Sprung Smooth Action Sit-Stand Laptop workstation (795mm x 540mm)

Encourages a healthier lifestyle by allowing you to stand or sit while using a laptop or tablet.

- Simply lift or lower the desktop to your desired height.
- Ultra Slim profile for space saving & easy storage
- Weight limit 15Kg/33lbs
- Steel Construction: provides a solid, and long-lasting performance
- Non-skid Silicone Pads: protect work surface from scratches or scuffs

**SALE!**  
**£80.00**  
Ex VAT



*Easy to lift to desired height*

Code	Ex Vat	Inc VAT
S16700	£80.00	£96.00

## Desk top Swivel Clamp-on Holder for Mains Extension Lead

**ONLY**  
**£10.50**  
Ex VAT



Code	Ex Vat	Inc VAT
S1555	£10.50	£12.26

# Memory Foam Lumbar Support / Seat Cushion

Product	Code	Ex Vat	Inc VAT
Memory Foam Lumbar Support Seat Cushion	S12008	£12.46	£14.95
Memory Foam Lumbar Cushion	S12009	£12.46	£14.95
Memory Foam Seat Cushion	S12023	£12.46	£14.95

- Healthy Posture
- Proper Spine Alignment
- Reduced Back Pain
- Increased blood flow to the lower extremities
- Superior comfort



## Memory Foam Lumbar Support Seat Cushion

385 x 320 x 120mm / 15.2" x 12.6" x 4.7"

580g / 1.3lbs

Material: Memory Foam, Velboa, Mesh Fabric

Colour: Black

Removeable cover – easy to wash.

Elastic band – easy to fix onto chair.



## Memory Foam Lumbar Cushion

455 x 385 x 75mm

670g

Material: Memory Foam, Velboa, Mesh Fabric

Colour: Black / Grey

Zippered removeable cover is easily washable.

Anti-slip bottom: Keeps the cushion fixed on your chair.

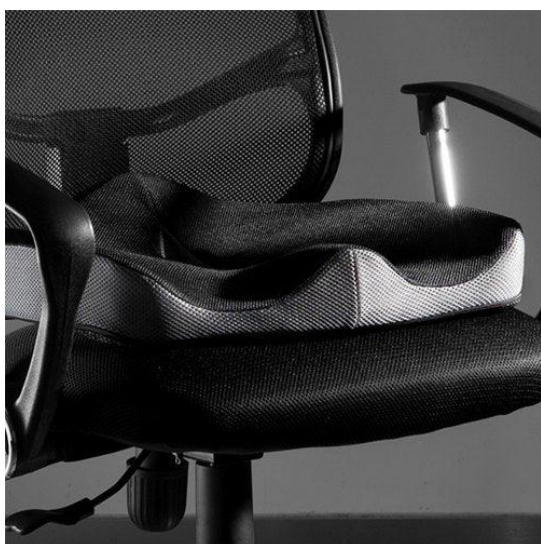

## Memory Foam Seat Cushion

460 x 390 x 80 mm / 18.1" x 15.4" x 3.2"

920g

Material: Memory Foam, Velboa, Mesh Fabric

Colour: Black / Grey

Perfectly moulding to the contours of your legs and bottom, gives you support and relief from pains during long time driving and sitting.

Perfect gift for drivers, teachers, students, wheelchair users, pregnant women, office workers etc.

# Desktop Tablet/ Phone Stands

**ONLY  
£24.96 Ex  
VAT**

Compatible with most 4"-11" display tablets (iPad Air / Mini / 10.5-inch iPad / Galaxy Tab) and Smartphones (iPhone 14, 13, 12, X, 8, 8+, 7, 6, 5, 4 / Samsung Galaxy).

However, phone and tablet plus case should be less than 1.4 cm (0.5") thick and weigh no more than 1kg.

An optional additional large size mount is available to support 6" – 13" devices including the iPad Pro.

An adapter is also available to connect a camera or projector.



# Aluminium Laptop Stands

This stylish, height adjustable premium grade aluminium alloy laptop stand is ideal for schools, Offices, Home Workers, and Gamers alike.



Size: 249 x 220 x 27 mm

Suitable for any 11" to 17.3" laptop and tablet

Connection Type: USB type C

Max Load: 20kg

Height Adjustment: 30mm to 270mm



Size: 249 x 220 x 27 mm

Suitable for any 11" to 17.3" laptop and tablet

Connection Type: USB type C

Max Load: 20kg

Height Adjustment: 30mm to 365mm

360 Rotation



Size: 249 x 220 x 27 mm

Suitable for any 11" to 17.3" laptop and tablet

Connection Type: USB type C

Max Load: 20kg

Height Adjustment: 30mm to 270mm

Dual Fans (23 DBA). Provide optimal airflow to aid perfect ventilation.

Product	Code	Ex Vat	Inc VAT
Foldable Sturdy Black Aluminium Laptop Stand	S143P	£20.79	£24.95
Premium Aluminium 360 degree rotating Ergonomic Laptop Stand	S102	£33.29	£39.95
Quality Aluminium Laptop Stand with USB powered Cooling Fans	S143F	£24.96	£29.95



## Reading Book / Music Stand

### Folding Wooden Stand



Perfect for the home or office.

- Offers an adjustable bar, so you can raise the stand to a comfortable and natural height for best ergonomics
- Environmentally friendly metal and eco plywood
- 340 x 240 x 60 mm (Folded size)



**These stands are all environmentally friendly!**



### 360 Rotatable Stand Aluminium & Plywood

Perfect addition for home or office.

- 360 rotation
- Suitable for books of different thickness
- Double pole support offers super load-bearing
- Premium environmentally friendly aluminium and eco plywood
- 340 x 240 x 58 mm (Folded size)

### 360 Rotatable Stand Aluminium & Acrylic

Perfect addition for home or office.

- 360 rotation
- Suitable for books of different thickness
- Double pole support offers super load bearing
- Premium environmentally friendly aluminium and transparent clear acrylic
- 340 x 240 x 58 mm (Folded size)
- Height adjustable from 0~185 mm



Product	Code	Ex Vat	Inc VAT
Folding Wooden Stand	S120	£16.63	£19.96
360 Rotatable Stand Aluminium & Plywood	S117	£20.79	£24.95
360 Rotatable Stand Aluminium & Acrylic	S115	£24.96	£29.95

## Height-Adjustable Wall Mount

### Height-Adjustable Wall Mount for Displays 50" - 65" & up to 60kg.

Screen size  
50" to 65"  
Max Weight  
60kg / 132lbs  
Max VESA:  
800 x 600 mm

With a light hand, this Counter Balance Mount is our manually operated height adjustable mount based on spring tension technology.

Allows the display to be raised and lowered to any position with finger touch positioning and a compact design allows it to fit nicely behind the screen.

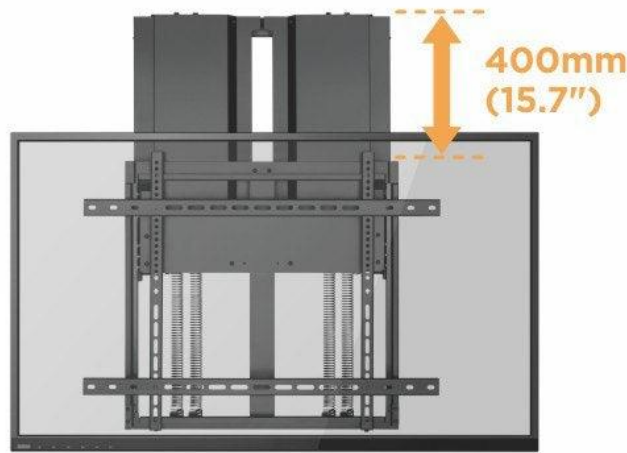

### Height-Adjustable Wall Mount for Displays 70" - 90" & up to 90kg.

Screen size  
70" to 90"  
60kg to 90kg /  
132lbs to 198lbs  
Max VESA:  
800 x 600 mm

**This height adjustable wall mount leaves no carbon footprint!**

Product	Code	Ex Vat	Inc VAT
Height-Adjustable Wall Mount 50"-65"	S14550	<b>£299.00</b>	£358.80
Height-Adjustable Wall Mount 70"-90"	S14555	<b>£330.00</b>	£396.00

## Heavy Duty Mobile Interactive Screen / TV Trolley



Screen size: 50" to 86"  
Max Weight: 120kg / 265lbs  
Dimensions: 1067 x 801 x 1725 mm

This trolley is manually adjustable in 2 preset height positions.

The trolley features four solid 75mm locking caster wheels that allow you to move and use the floor stand wherever, whenever, with ease.

This trolley is supplied with a shelf, with a maximum weight capacity of 10kg.

Code	Ex Vat	Inc VAT
S14560	<b>£195.00</b>	£234.00

**Anti-theft tablet Security Station for: iPad Air Air2 Pro 9.7 mini, mini2, Samsung Galaxy Tab**

- Designed to provide a secure mount in public areas.
- Ideal for use in commercial and trade show locations.
- Suits most tablets with a minimum size of W135 x H195 mm to a maximum size of W190 x H265mm.
- Enclosure freely rotates 360 degrees and tilts 180 degrees stable weighted base swivels 360 degrees for multiple viewing angles iPad Air enclosure uses a security slot with a strong 180cm long cable key lock with 2 keys included.
- Tilts for view angle adjustment and typing angle.
- Power and data cables can be run along the tube for a neat installation.
- Solid steel stable base

*Tilts for view angle adjustment and typing angle*



**ONLY  
£39.50  
Ex VAT**

Product	Code	Ex Vat	Inc VAT
Desktop tablet security station	S16750	<b>£39.50</b>	£47.40
Spare Lock for above	S12036	<b>£8.33</b>	£9.99

**ONLY  
£34.95  
Ex VAT**

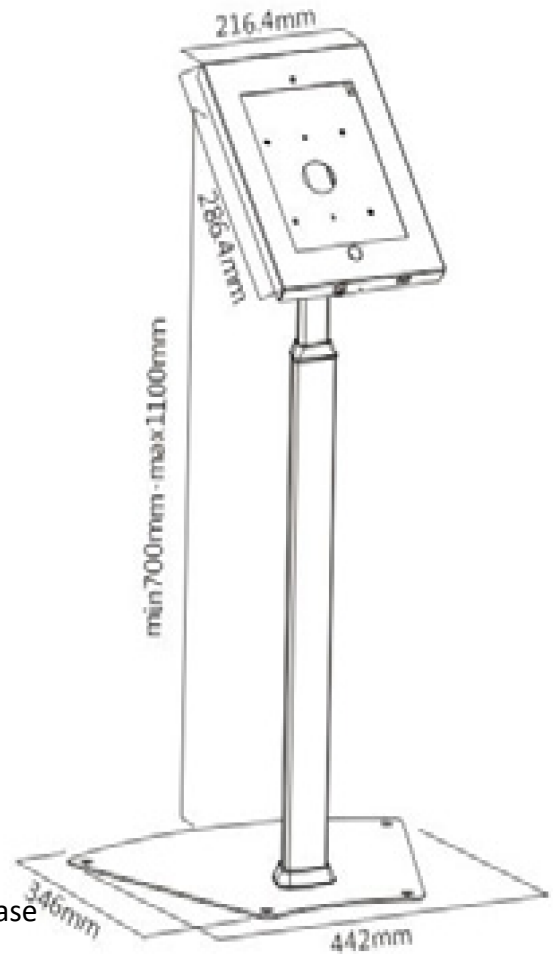

**Height adjustable iPad Air Tilting Floor Stand with Lock**

Designed for the 9.7" iPad and iPad Air, mounted on a solid stable base

Product	Code	Ex Vat	Inc VAT
iPad air Tilting Floor Stand	S12010	<b>£34.95</b>	£41.94



## Heavy Duty Monitor/TV Wall Mounts

### Heavy Duty Fixed Wall Mount 42" to 75" screen, 75Kg max load

Screen size  
42" to 75"  
75KG/165lbs  
Max Vesa:  
600 x 510mm



Code	Ex VAT	Inc VAT
<b>S275</b>	<b>£20.83</b>	<b>£25.00</b>

### Heavy Duty Fixed Wall Mount

Screen size  
50" to 120"  
Max Weight of 120kg  
Max Vesa: 900 x 600mm



Code	Ex VAT	Inc VAT
<b>S92</b>	<b>£35.00</b>	<b>£42.00</b>

### Tilt TV Wall Mount

Screen size 32" to 55" LED, LCD Flat Panel Screen/TV

Max weight of 40kg/88lbs

Max Vesa: 400 x 400mm



Code	Ex VAT	Inc VAT
<b>S12029</b>	<b>£16.66</b>	<b>£19.99</b>

### Tilt TV Wall Mount

Screen size 37" to 70" LED, LCD Flat Panel Screen/TV

Max weight of 40kg/88lbs

Max Vesa: 600 x 400mm

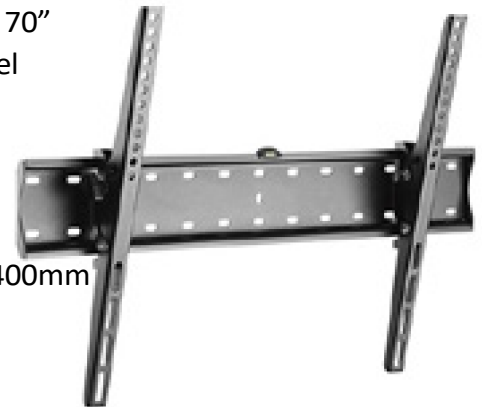

Code	Ex VAT	Inc VAT
<b>S12030</b>	<b>£10.42</b>	<b>£12.50</b>

## Desktop/Sit Stand Clamp on Monitor Mounts

### Single Monitor Arm Double Joint Articulated (Desk top Clamp)

Screen size 13" to 32"  
Max weight 8kg/17.6lbs  
Max Vesa: 100 x 100mm



Code	Ex VAT	Inc VAT
<b>S16780</b>	<b>£12.50</b>	<b>£15.00</b>

### Dual Monitor Arm Double Joint Articulated (Desk top Clamp)

Screen size 13" to 32"  
Max weight 8kg/17.6

Max Vesa: 100 x 100mm



Code	Ex VAT	Inc VAT
<b>S16779</b>	<b>£17.50</b>	<b>£21.00</b>



ViewBoard® IFP52-2F Series

# Tap Into Limitless Learning

Android™ EDLA Certified



**ViewSonic®**  
*See the difference.®*

With over 30 years as an award-winning visual display leader, ViewSonic has one of the most comprehensive interactive flat panel ranges in the industry.

The easy-to-install, and easy-to-maintain ViewBoard® series is available in 55", 65", 75", 86" and 98" with blue light, anti-glare, anti-scratch 7H toughened glass.

Whether you need to create dynamic lesson plans with ease, or promote a collaborative and engaging classroom environment, ViewSonic has the perfect solution to change the way you enhance education through technology.

*Create an Interactive & Engaging Classroom*

The interactive flat panels have user-friendly interfaces, connectivity options, integrated computing, content sharing capability and the ability to upload agnostic school materials across multiple platforms.

ViewSonic has proven its dedication to improving the learning process within schools by offering two complimentary software packages, myViewBoard and ViewBoard® Cast, with every panel.



**Contact us on 0115 940 5550 for a demonstration and further information.**

# SAMSUNG

## Digital Flipchart

Let's Flip! Teamwork simplified



### Imagine a new era of learning.

Samsung Flip 3 transforms the classroom through interactive learning experiences, giving educators the resources needed to create effective and modern lessons. With more software and connectivity options, and intuitive interaction features, Flip 3 creates engaging learning environments.

**Contact us on 0115 940 5550 for a demonstration and further information.**



# 65" and 75" Interactive E-Board from Samsung



## Unlimited learning possibilities

Samsung interactive display WAC series offers a dynamic, engaging experience designed for the classroom of the future. Its enhanced usability and compatibility make it easier for teachers to leverage education apps and features that optimize lessons and help students discover the joy of learning.

## Create more engaging lessons with intelligent apps

### Intelligent App for class

Important apps and tools can be conveniently added to the home screen bar for easy access. Intelligent apps, such as timers and stopwatches, help teachers get creative with their lessons to foster a learning environment that students love.

**Contact us on 0115 940 5550 for a demonstration and further information.**

# VESTEL

## Digital Signage Displays

Vestel answers the needs and expectation of the market by offering different options and strong display performance with its new generation digital signage displays.

Ideal for; Retail, Hospitality, QSR, Entertainment, Corporate, Education, Control Rooms, Transportation

E Series	1920 x 1080 350 / 450 cd/m2 32"	Affordable solution that will help improve professional image. Eco designed.
V Series	3840 x 2160 350 / 500 cd/m2 43" / 55"	Minimum cost creates the best environment for many purposes.
UHM Series	3840 x 2160 400 cd/m2 43" / 55" / 65" / 75"	Eye catching images can be shown in clarity on UHM Series with high resolution & high dynamic range of colours.
PDU Series	3840 x 2160 500 cd/m2 43" / 49" / 55" / 65" / 75"	The various display sizes with professional grade screens will fit the highest demands
PDX Series	3840 x 2160 1000 cd/m2 75"	The highest brightness levels with many scheduling functions.
PR / PN / PF Series	3840 x 2160 500 / 700 cd/m2 43" / 50" / 55" / 65"	Prime Series provides different brightness levels based on customer needs.
QF / QN Series	3840 x 2160 400 / 500 cd/m2 55" / 65"	Slim and sleeky design, Q Series creates a high visual impact.
XD / XN Series	3840 x 2160 400 / 500 cd/m2 86" / 98"	The highest display size will fit the highest demands.

### Accessories

#### Plugin OPS Module

Vestel's pluggable processors (OPS) are designed to give extra computational power to our displays.

#### Touch Overlay

Signage displays can be equipped with touch functionality with Touch Overlay accessory. With the help of SoC and touch overlay you can also use displays as PCless Touch Monitor by installing HTML based programs.

#### Motorized Stand

**Features** You will be able to make use of our adjustable motorized stands together with our signage products.

- Auto Launch
- USB Autoplay
- HDMI Wake Up
- OSD Orientation
- Wireless Display
- Display Control over RS232 & LAN
- Scheduler
- Embedded CMS
- HDR10 & 4K HDMI @60Hz
- IP Streaming Support
- Signal Failover
- Creston Connected



<https://www.vestelvisualsolutions.com/eu-en/digital-signage-displays>

For further information about products specifications  
**please scan the QR code.**

**Contact us on 0115 940 5550 for a demonstration and further information.**

For as low as  
£879 + VAT



# Promethean

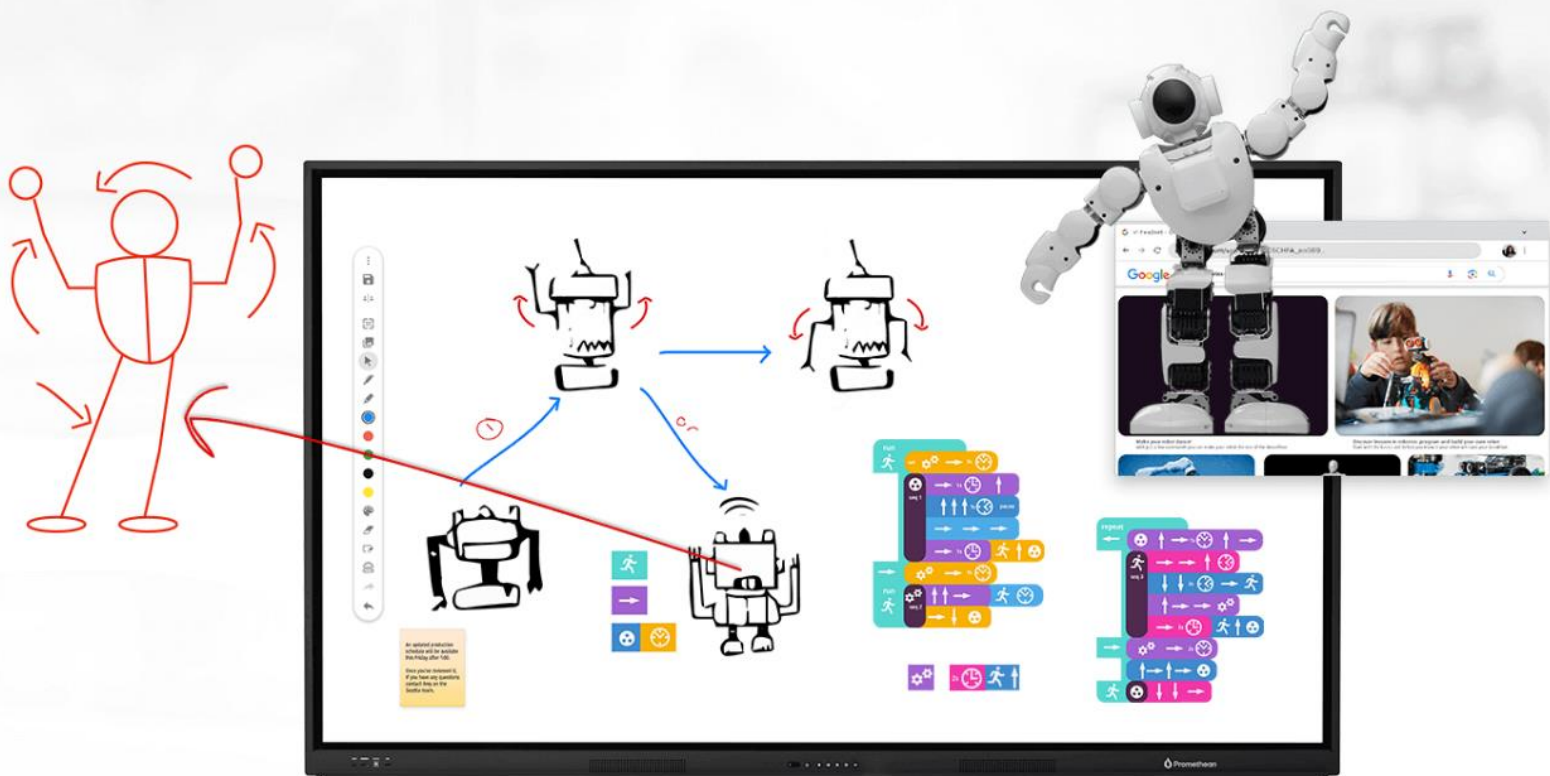

## Three great sizes, Three great prices

**65" for as low as £879 + Android OPS + VAT**

**75" for as low as £1,179 + Android OPS + VAT**

**86" for as low as £2,059 + Android OPS + VAT**

- A crystal clear 4K display that leverages HDMI 2.0 technology
- Gigabit ethernet ports for uncompromised network speeds to a connected OPS device
- LCD bonded glass offering excellent writing and viewing experiences
- Advanced touch technology providing pen and touch differentiation, palm erase, and 20 points of touch
- Dual front-facing speakers, an integrated full-length pen tray, and a wall mount

The ActivPanel LX can be plugged into a laptop with a single USB-C cable, instantly turning your computer into a large-format interactive display. It can also be paired with a computing module that fits your preferred ecosystem – whether it be Google, Windows, or Android – giving you maximum flexibility. And as your edtech evolves and your needs change, your ActivPanel LX will always be able to adapt.

Promethean makes interactive displays and teaching software that drive breakthroughs for teachers, students, and colleagues around the world.

Teachers created promethean, for people with a passion for empowering everyone to shine their brightest. It's a legacy that has fuelled us from our early startup days in Blackburn, England, to the international company we are today.

**Contact us on 0115 940 5550 for a demonstration and further information.**



# An Important Update on Lamp Projectors

In the next few years, a law banning the sale of mercury-based projector lamps is going to come into force. This will undoubtedly have an impact in many schools.

Consequently, if you are looking to purchase any new projectors you should now be looking at either laser or LED based units. We would be happy to help you with that process.

In addition, you might want to look at the number of lamp-based projectors you have, particularly if you have multiples of the same unit and think about putting some lamps into stock.

We have found that the lead times for many of the older projectors are running into months not weeks.

With the above in-mind Crusader AV Offers a wide selection of LED and laser projectors.

With a range of brands to choose from, we have a projector for every space and budget.

Please contact us to find out more.

# MAXHUB

## MAXHUB XT SERIES FOR MICROSOFT TEAMS ROOMS

MAXHUB |  Microsoft Teams

## Why Choose MAXHUB

As an innovation-driven team, MAXHUB focuses on developing collaboration solutions that enable immersive communications. Since established in 2017, we have enhanced team creativity and productivity worldwide by providing advanced audio-visual technologies and one-step solutions.

MAXHUB Ecosystem focuses on a total solution for complete scenarios. From **smart Interactive Displays**, to **high-quality UC products**, to **ground-breaking all-in-one LED and eye-catching Digital Signage**, to **Mobile Stands for flexible work**, we've got you covered.

### MAXHUB Screen Sharing Box WB05



- One-click easy for 4K Ultra HD output.
- 60Hz high frame rate display.
- Convenient screen sharing for maximized meeting experiences, cost-effective and energy-saving, efficient presentation, clean wiring.
- Scheduled Power On/Off.
- Content Broadcasting.
- POE Power Supply.

### MAXHUB Wireless Screen Sharing Dongle WT13



- NFC.
- Multi-device connectivity.
- Touch Back Control.
- 5 second rapid pair.
- No installation or Driver required.
- Type-C Interface and Type-A Adapter.
- Multi-screen sharing.
- Uninterrupted Connection.
- Flexible sharing.
- 4K screen mirroring, delivering 77% more pixel details than traditional 1080P encoding.

**Contact us on 0115 940 5550 for a demonstration and further information.**

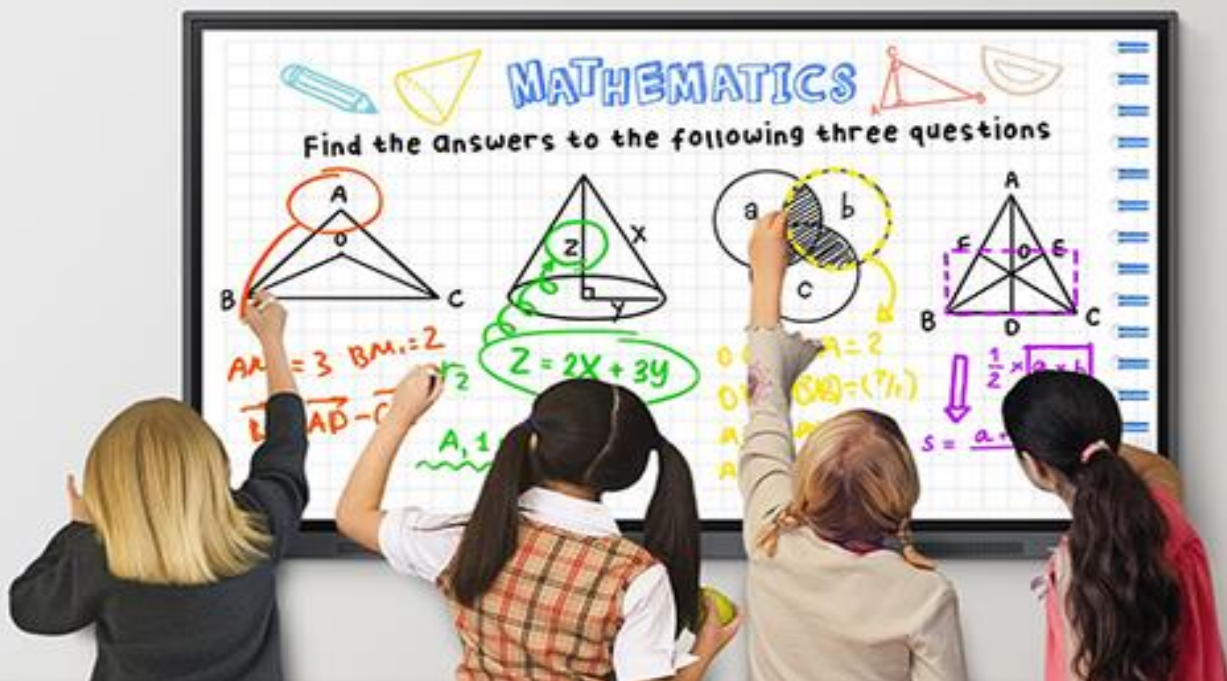

**Another CrusaderAV Exclusive Offer for you! The All-New Samsung Interactive Panel supplied & installed from only £1,300 + VAT.**

**Your offer includes:**

- Samsung Interactive Panel
- Education software
- Heavy duty wall mount bracket
- Wall mounted connection box with PC fly leads
- 5-year onsite warranty
- Installation and commissioning
- De-installation, and recycling of your old equipment and package
- A free demonstration on how to use your new interactive board.



Don't wait contact us today on **0115 940 5550** and book your trial unit now.

What's more, we're offering your School a FREE loan unit, so you can try before you buy!  
Interested?

Visit [www.CrusaderAV.co.uk](http://www.CrusaderAV.co.uk) or call us on **0115 940 5550**

Crusader Ltd, Unit 24 Nottingham South & Wilford Industrial Estate, West Bridgford, NG11 7EP.