

# DABBSSON

## Dabbsson DBS2300Plus User Manual

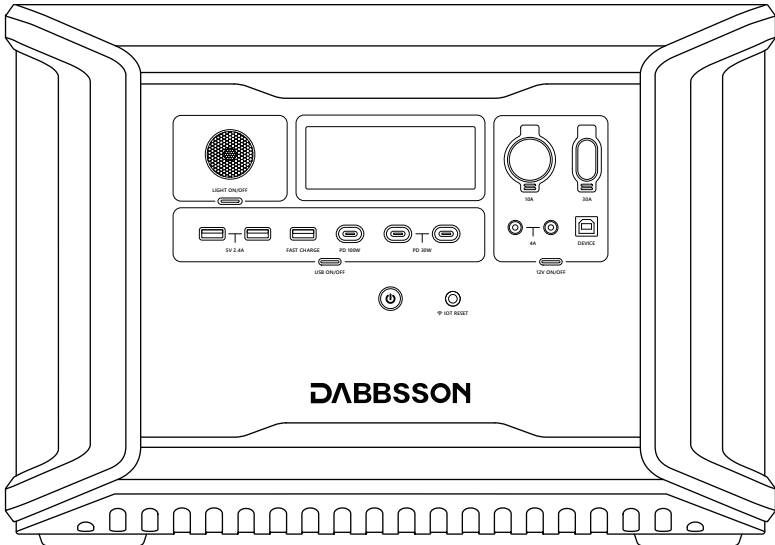

# DISCLAIMER



Read all safety tips, warning messages, terms of use, and disclaimers carefully. Refer to the terms of use and disclaimer at <https://www.dabbsson.com> and stickers on the product before use. Users take full responsibility for all usage and operations. Familiarize yourself with the related regulations in your area. You are solely responsible for being aware of all relevant regulations and using Dabbsson products in a way that is compliant.

# CONTENTS



<b>1. Specifications</b>	<b>1</b>
<b>2. Safety Instructions</b>	<b>2</b>
2.1 Usage	2
2.2 Disposal Guide	3
<b>3. Product Details</b>	<b>4</b>
3.1 Over View	4
3.2 LCD Screen	5
<b>4. General Product Usage</b>	<b>6</b>
4.1 Charging DBS2300Plus	6
AC Charging	Car Charging
Solar Charging	Using Smart Extra Battery
4.2 Control the product	13
Power On/Off	
4.3 Charging Your Devices	14
AC outlets	P-Boost and EPS
DC outlets	
4.4 Parallel Connection Function	15
<b>5. App Control</b>	<b>17</b>
<b>6. FAQs</b>	<b>26</b>
<b>7. Troubleshooting</b>	<b>27</b>
<b>8. What's in the Box</b>	<b>28</b>
<b>9. Storage &amp; Maintenance</b>	<b>28</b>
<b>10. Fcc Statement</b>	<b>29</b>

# 1. Specifications



## General Info

Net Weight	Approximately 26.2kg (57.8lbs)
Dimensions	432x254.5x303.5mm (17x10x12in)
Capacity	2330Wh (44.8V $\approx$ 52Ah)
Wi-Fi	Supports 2.4G: 2412-2472MHz with a maximum of 14.9 dBm
BT	Supports BDR+EDR: 2402-2480MHz with a maximum of 2.5 dBm
Certification	ETL FCC PSE WEEE ROHS TELEC

## Output Ports

AC (x4)	Pure Sine Wave, 2200W total (surge 4400W), 100-120V~ (50/60Hz)
USB-A (x2)	5V $\approx$ 2.4A, 12W Max Per Port, Total 12W
USB-A Fast Charge (x1)	5V $\approx$ 3.0A 9V $\approx$ 2A 12V $\approx$ 1.5A, 18W Max
USB-C (x1)	5/9/12/15V $\approx$ 3A, 20V $\approx$ 5A 100W Max
USB-C (x2)	5/9/12/15/20V $\approx$ 1.5A, 30W Max Per Port, Total 60W
Car Charger	12.6V $\approx$ 10A, 126W Max
DC5521 Output (x2)	12.6V $\approx$ 4A, 50.4W Max Per Port
Anderson Output	12.6V $\approx$ 30A, 378W Max
LED	2W

\* The car charger shares power with the DC5521 output port, offering a maximum output of 126W.

## Input Ports

AC Charge	1800W Max
AC Input Voltage	100-120V~ 15A, 50/60Hz
Solar Charger	12-60V(75V Max) $\approx$ 25A Max, 800W Max
Car Charger	Supports 12V/24V $\approx$ Battery, Default 8A
Add-on	Extra Battery DBS3000B*2, Total 8330Wh

## Battery Info

Cell Chemistry	LiFePO4
Cycle Life	4000 Cycles to 80%+Capacity

## Protection

Over Voltage Protection	Overload Protection
Over Temperature Protection	Short Circuit Protection
Low Temperature Protection	Low Voltage Protection
Overcurrent Protection	Battery Failure Protection

## Environmental Operating Temperature

Optimal Operating Temperature	20°C~30°C(68°F ~86°F)
Discharge Temperature	-10°C~45°C(14°F ~113°F)
Charging Temperature	0°C~45°C(32°F ~113°F)
Storage Temperature	-10°C~45°C(14°F ~113°F)

\* Whether the product can be charged or discharged depends on the actual temperature of the battery pack.

# 2. Safety Instructions



## 2.1 Usage

1. Do not use the product near a heat source, such as a fire source or a heating furnace.
2. Avoid contact with any liquid. Do not immerse the product in water or get it wet. Do not use the product in rain or humid environments.
3. Do not use the product in an environment with strong static electricity or magnetic fields.
4. Do not disassemble the product in any way or pierce the product with sharp objects.
5. Avoid using wires or other metal objects that may result in a short circuit.
6. Do not use unofficial components or accessories. If you need to replace any components or accessories, visit official Dabbsson channels to check for relevant information.

7. It is highly recommended that third-party accessories are purchased from reliable distributors and that they match your product's specifications. Dabbsson is not liable for abnormality, inconvenience, losses or expenses resulting from defective third-party accessories.
8. When using the product, please strictly follow the operating environment temperature specified in this user manual. If the temperature is too high, it may result in a fire or explosion; if the temperature is too low, the product performance may be severely reduced, or the product may cease to work.
9. Do not forcibly lock the fan during use or place the product in an unventilated or dusty area.
10. Avoid impact, falls, or severe vibrations when using the product. In case of a severe external impact, turn off the power supply immediately and stop using the product. Ensure the product is well fastened during transportation to avoid vibrations and impacts.
11. If you accidentally drop the product into water during use, place it in a safe open area, and stay away from it until it is completely dry. The dried product should not be used again, and should be properly disposed of according to Section 2.2 below. If the product catches fire, we recommend that you use the fire extinguishers in the following order: water or water mist, sand, fire blanket, dry powder, and finally a carbon dioxide fire extinguisher.
12. Use a dry cloth to clean off dirt on the product ports.
13. Rest the product on a flat surface to avoid damage caused by the product falling over. If the product is overturned and severely damaged, turn it off immediately, place the battery in an open area, keep it away from combustible matter and people, and dispose of it in accordance with local laws and regulations.
14. Ensure that the product is kept out of reach of children and pets.
15. The smart extra battery can only be connected to the host, and the smart extra battery cannot be connected to each other.

## 2.2 Disposal Guide

1. If conditions permit, make sure that the battery is fully discharged before disposing of it in a designated battery recycling bin. The product contains batteries with potentially dangerous chemicals, so it is strictly prohibited to dispose of it in ordinary trash cans. For more details, please follow the local laws and regulations on battery recycling and disposal.
2. If the battery cannot be fully discharged due to a product failure, do not dispose of the battery directly in the battery recycling box. In such cases, contact a professional battery recycling company for further processing.
3. Please dispose of over-discharged batteries that cannot be recharged.

# 3. Product Details



## 3.1 Over View

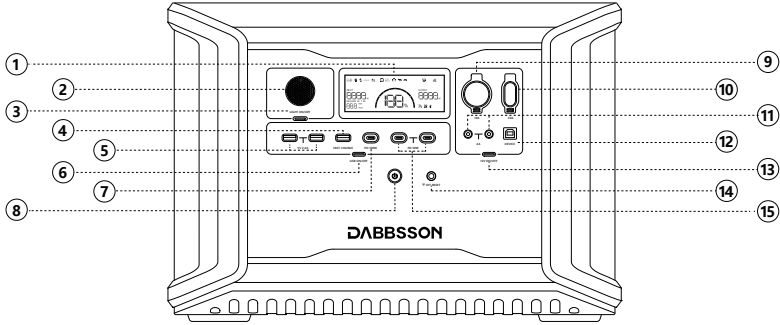

- ① LCD Screen
- ② LED
- ③ LIGHT ON/OFF
- ④ USB-A Fast Charge Output Port
- ⑤ USB-A Output Port (x2)
- ⑥ USB ON/OFF
- ⑦ USB-C 100W Output Port
- ⑧ Main Power Button
- ⑨ Car Output Port
- ⑩ Anderson Port (12V/30A)
- ⑪ DC5521 Output Port
- ⑫ Product Upgrade Port\*
- ⑬ 12V DC Power Button
- ⑭ IOT Reset Button
- ⑮ USB-C 30W Output Port (x2)

\* "Product Upgrade Port" is only used by the manufacturer for upgrading.

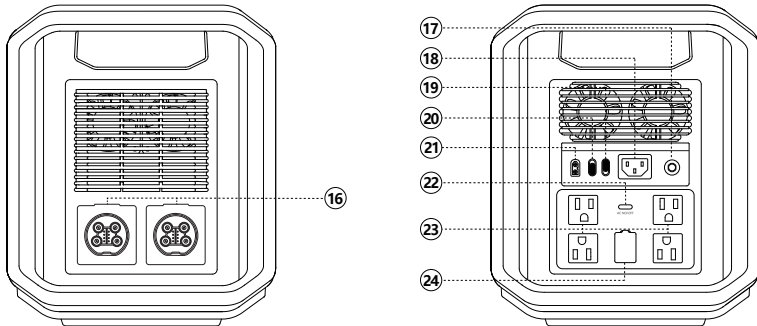

- ⑯ Extra Battery Port
- ⑰ Overload Protection
- ⑱ AC Charging Input Port
- ⑲ Standby/ECO Mode Switch
- ⑳ AC Charge Speed Switch
- ㉑ Solar/Car Charging Input Port
- ㉒ AC Power Button
- ㉓ AC Output Port (x4)\*
- ㉔ Parallel Connection Port

\* "AC Output Port" Output port styles vary by country or region.

### 3.2 LCD Screen

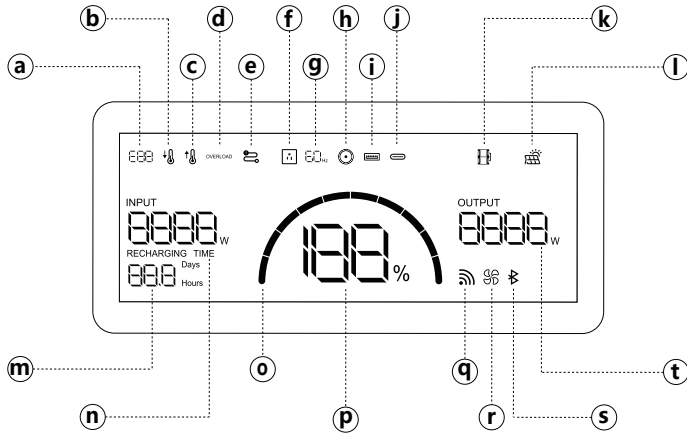

- a Error Code
- b Low Temperature Warning
- c High Temperature Warning
- d Overload Warning
- e Connection Failed
- f AC Output
- g AC Output Frequency
- h DC Output
- i USB-A Output
- j USB-C Output
- k Extra Battery Indicator
- l Solar Panel Indicator
- m Remaining Charge/Discharge Time
- n Input Power
- o Battery Level Indicator
- p Remaining Battery Percentage
- q Wi-Fi Status
- r Fan Indicator
- s Pairing Indicator
- t Output Power

#### Battery Level Indicator

When charging, the icon rotates clockwise. When the battery level of this product at 0%, AC and DC output will turn off and this icon will start flashing; When the battery level is 100%, this icon is the full grid state.

#### Wi-Fi Status

Press and hold the IOT button for 3 seconds, and the Wi-Fi icon will flash, indicating that the product is ready for pairing. If the product pairing is completed, the Wi-Fi icon will stay on.



## 4. General Product Usage



### 4.1 Charging DBS2300Plus

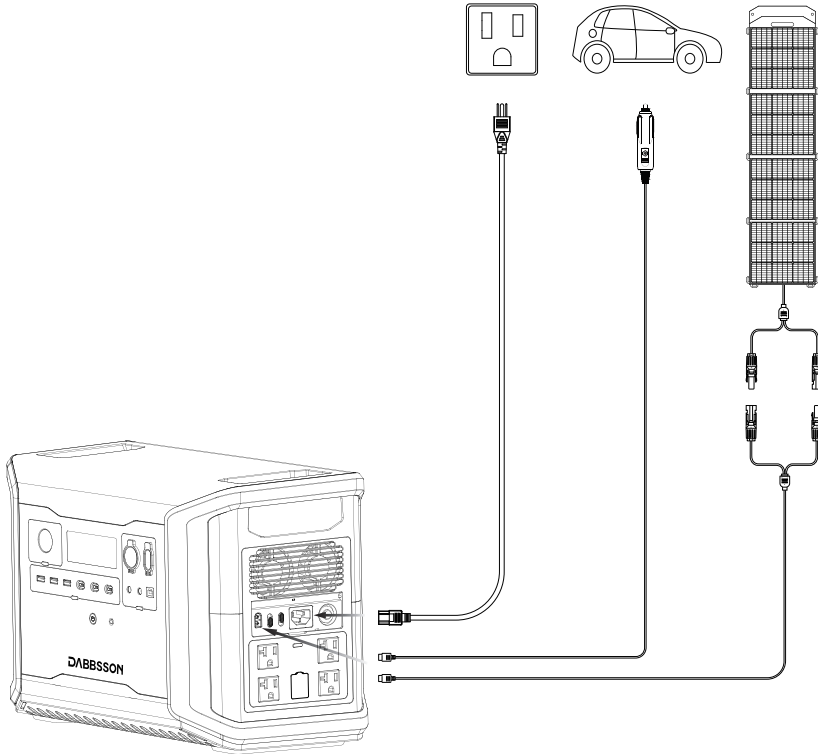

### AC Charging

Dabbsson fast charge technology is specifically for AC charging, offering 1800W of max input power. You can control the charging power through the AC Charge Speed Switch. The default max input power for the AC charging speed is 600W, which can be modified in the Dabbsson app.

In case of unusual situations where the AC input current remains higher than 20A, the charging input port will initiate a self-protection function, and the Overload Protection Switch on the product will automatically pop up. After confirming that there is no product failure, you can press the Overload Protection Switch to resume charging.

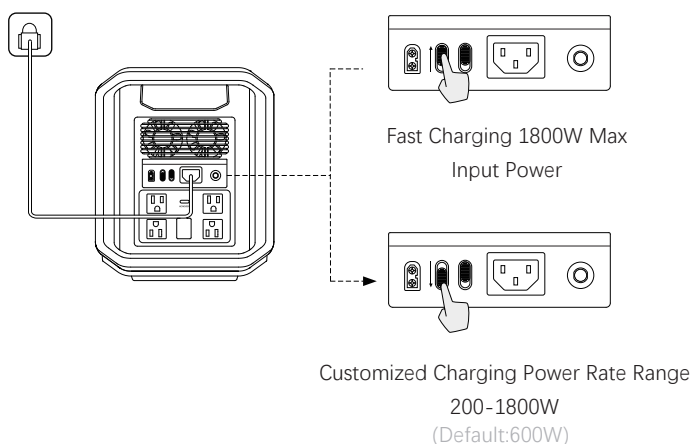
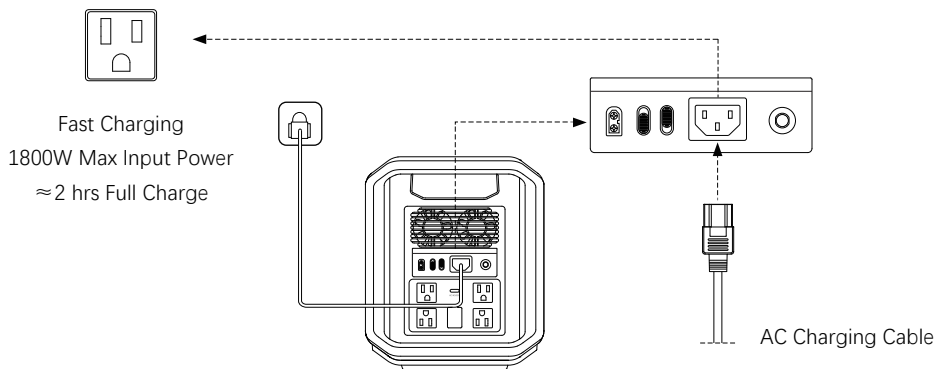

The charging power can be adjusted through the AC Charge Speed Switch on the side of the product. You can set the charging power range in the Dabbsson App.

Please use the AC Charging Cable included in the package for fast charging. Do not use other cables to charge. Plug directly into an AC wall outlet and make sure that the wall output current is more than 15A. Otherwise, reduce the unit charging speed with the AC Charge Speed Switch. Dabbsson takes no responsibilities for any consequences caused by failures to follow instructions, including but not limited to charging with other AC charging cables.

## Solar Charging

Users can connect solar panels in series as shown in the figure to recharge the product. The product supports 12-60V(75V Max) DC input, 25A max current, and 800W max charging power.

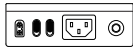

Connect XT60 Port

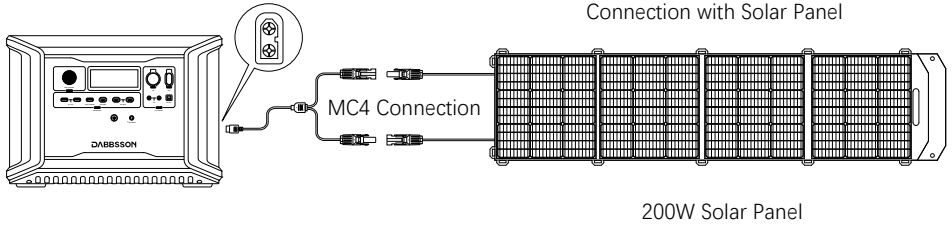

Connect XT60 Port

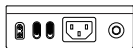
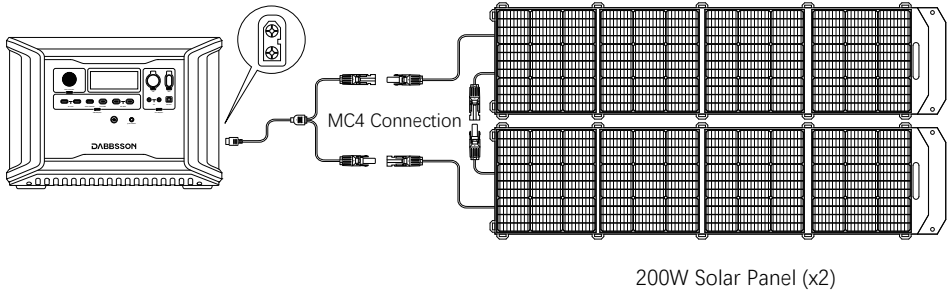

Connect XT60 Port

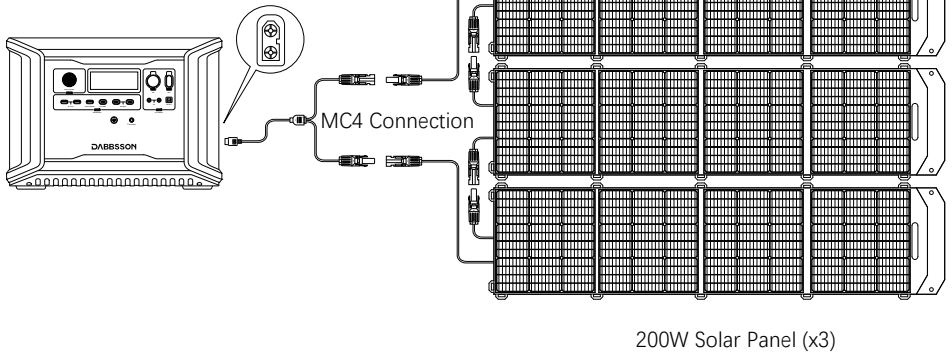

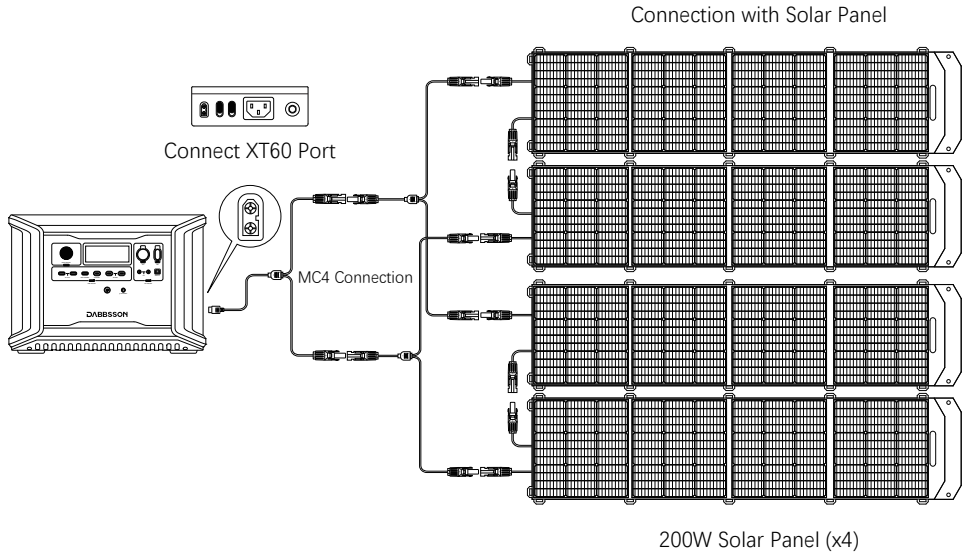

When charging the product with a Dabbsson solar panel, follow the instructions of this user manual to avoid damage to the product.

## Car Charging

Users can recharge the product through the Car Outlet. It supports 12V/24V car chargers and an 8A default charging current.

Only charge using the car charger after you've started the car. This prevents the car from failing to start due to insufficient battery power. In addition, please make sure that the cigarette lighter of the Car Outlet and the Car Charger Input Cable are in good condition. Dabbsson takes no responsibilities for any losses or damage caused by failures to follow instructions.

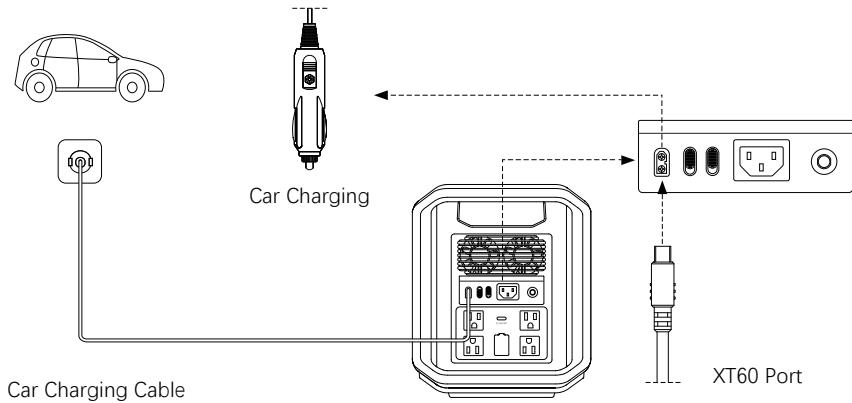

## Using Extra Battery

A single DBS2300Plus can be connected to two DBS3000B extra batteries for added capacity. Refer to the Extra Battery DBS3000B user manual for detailed instructions.

- DBS2300Plus can expand the capacity by 1 DBS3000 battery pack to 5330Wh.
  - DBS2300Plus can expand the capacity by 2 DBS3000 battery pack to 8330Wh.
- Please refer to Dabbsson support youtube channel for detailed installation instructions.

### Precautions

1. Turn off both the Extra Battery DBS3000B and DBS2300Plus before plug or unplug the extra battery.
2. Before using, make sure both DBS2300Plus and Extra Battery DBS3000B display the extra battery icon on their LCD screens.
3. Do not touch the metal terminals of the Extra Battery DBS3000B connector. If the metal terminals need to be cleaned, gently wipe them with a dry cloth.

4. When the DBS2300Plus power station and DBS3000B expandable battery are not in use, please remove the connecting cable.
5. To protect the battery from over-discharging, please unplug the cable when the unit is fully charged or not in use.
6. When the device is running, inserting or unplugging the parallel cable will turn off the output of the host. You need to press the host button again to unlock it, and then press the output switch.

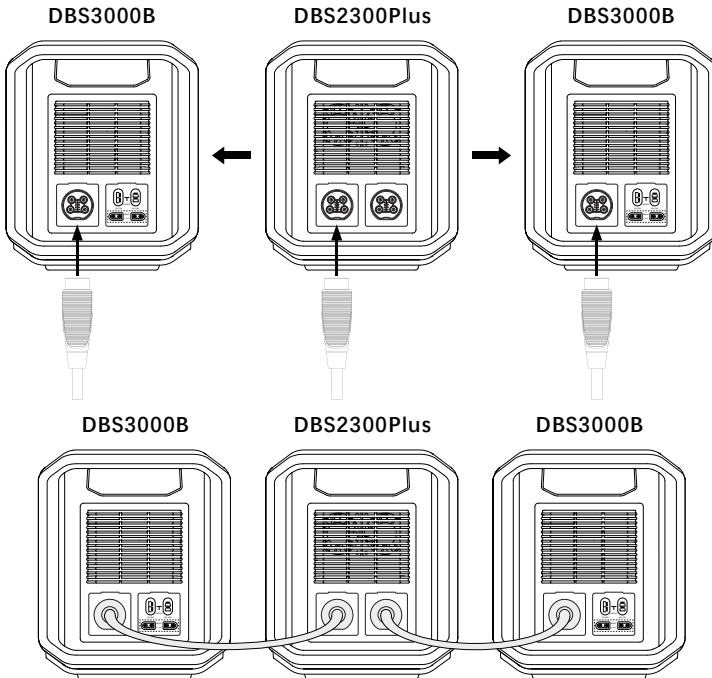
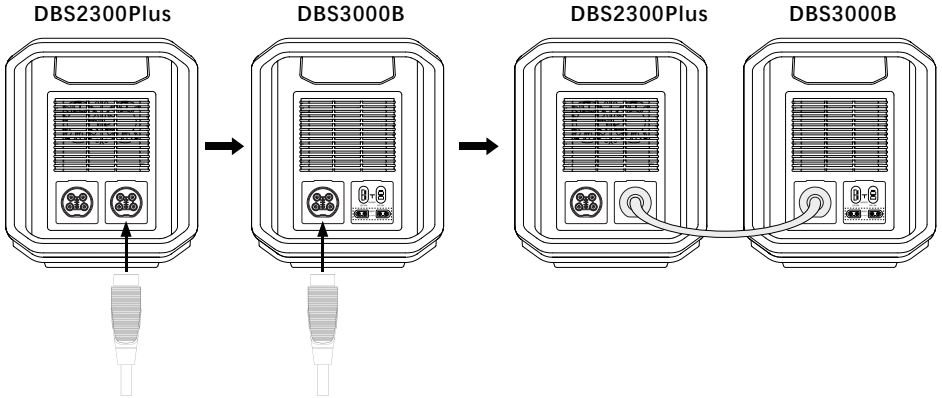

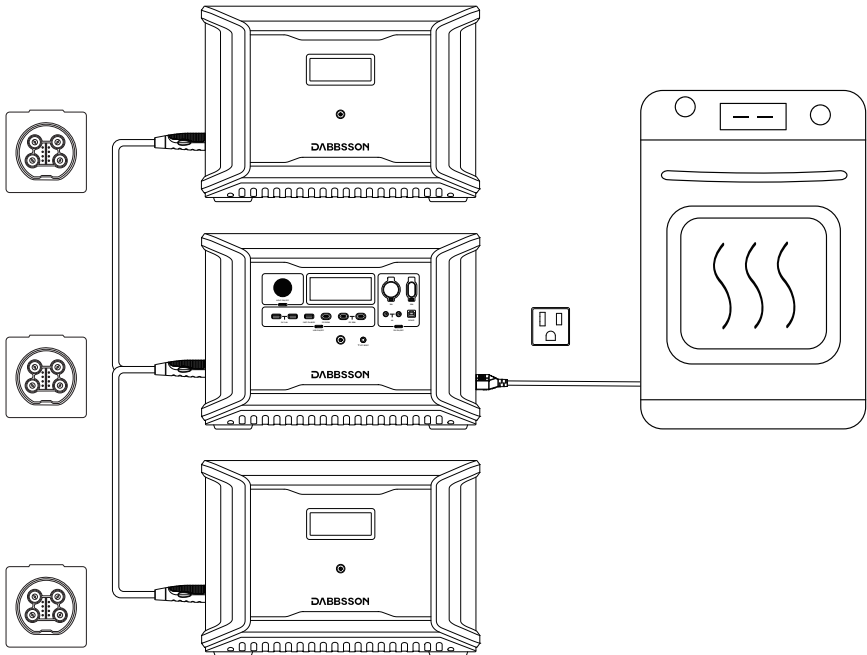
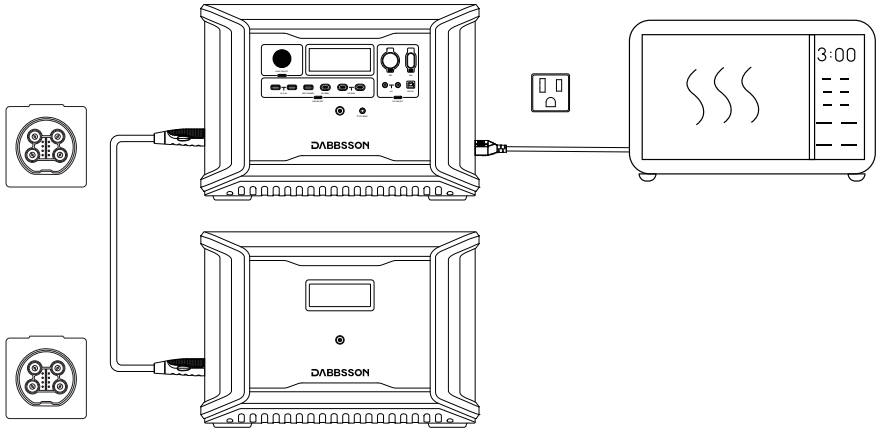

## 4.2 Control the product

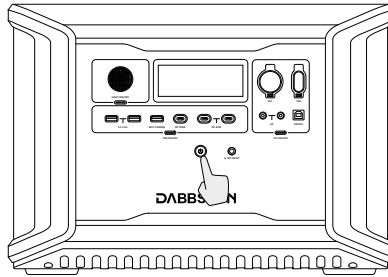

Short Press to Turn On/Long Press to Turn Off

### Product On, Product Off, LCD Screen On

Short press the Main Power Button to start the product, the LCD screen lights up and displays an icon. It will automatically turn off after the product is idle for 5 Minutes. When the device senses any load change or operation, the display screen will automatically light up. To turn the display on or off, briefly press the Main Power Button. To turn off the device, long press the Main Power Button. The default standby time is 2 hours. The device will automatically shut down when other power buttons are turned off and no other power source is detected within 2 hours. Standby time of AC and DC can be set via the Dabbsson APP.

### STANDBY MODE/ECO MODE

Default ECO MODE will be on.

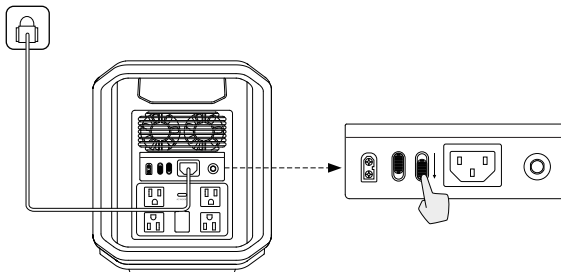



## 4.3 Charging Your Devices

### AC Output Port

After turning on the main power button, short press the AC power button to use the AC output port. Press the button again will turn it off.

When there is no load on the AC output port of this product, the power will be automatically turned off after 2 hours. In ECO mode, the AC output load is less than 5W, the AC switch will be automatically turned off after 12 hours, and the power will be turned off after 2 hours. In STANDBY mode, you can set the current output time. When you don't need it, please turn it off in time to save power.

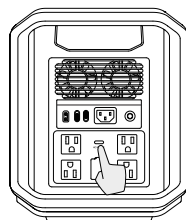

Short Press  
AC Power Button

### 12V DC Output Port

After the main power supply is turned on, short press the DC power switch to use the DC output port. Short press the DC power switch again to turn off the DC output port.

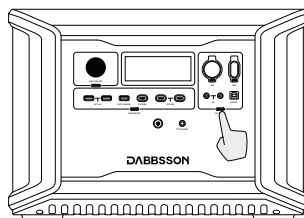

Short Press  
12V DC Power Button

### P-Boost

This product adopts P-Boost technology, which can supply power for electrical appliances with a maximum of 3000W, while keeping the output power within 2200W, so as to avoid operation failure caused by the activation of overload protection. The P-Boost function needs to be controlled by the Dabbsson APP.

#### P-Boost Tips

1. The P-Boost function is not available when the product turns on the AC output while in the charging state, parallel state or when the P-Boost mode is turned off in the Dabbsson APP.
2. P-Boost is not applicable for all electrical appliances; it's incompatible with appliances with strict voltage requirements and a rated power over 2200W. Appliances with voltage protection (such as precise instruments) are not supported. P-Boost mode is more suitable for heating devices. Please conduct your own tests with your devices with P-Boost enabled.

## Emergency Power Supply (EPS)

The product supports EPS. When you connect the grid power to the AC Input Port of the product through an AC cable, you can power electrical devices through the AC Output Port (AC power will come from the grid and not the power station in this situation). In case of a sudden blackout, the product can automatically switch to the battery powered supply mode within 15ms. As a basic UPS function, this function does not support 0ms switching. Please do not connect the product to any device that requires 0ms UPS, such as data servers and workstations. Please test and confirm the compatibility before using the product. We recommend that you only charge one device at a time and avoid using multiple devices at the same time to avoid overload protection. Dabbsson takes no responsibilities for any device failures or data losses caused by failures to follow instructions.(When the AC output load is greater than the input load, only the battery can be used for power supply. Only when the AC output load is less than the input load, can it be charged while discharging.)

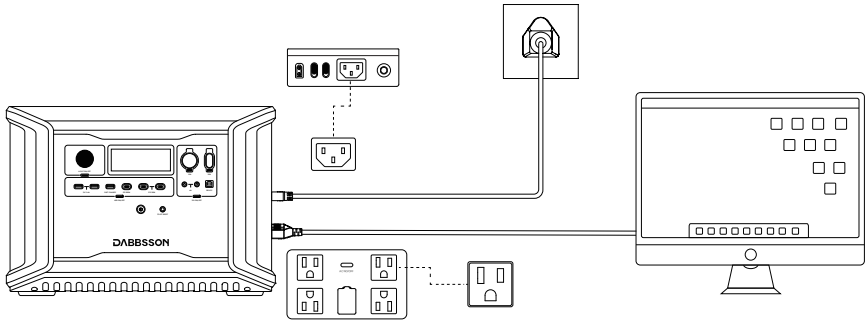

## 4.4 Parallel Connection Function

DBS2300 supports the parallel function, which can increase the output power and expand the battery capacity. Using our special junction box and connecting wires, two products can be connected, and the output power will be increased to 4000W, and the battery capacity will be expanded to 4660Wh. At the same time, this product also supports parallel operation, two products are respectively connected to two DBS3000B and powered on (2\*DBS2300Plus+4\*DBS3000B), at this time the battery can be expanded to 16660Wh. You can use this product as a home backup power station in case of a power outage.

**Reminder:** The parallel junction box and connecting wires need to be purchased separately; for detailed parameters, please refer to the manual of the parallel box.

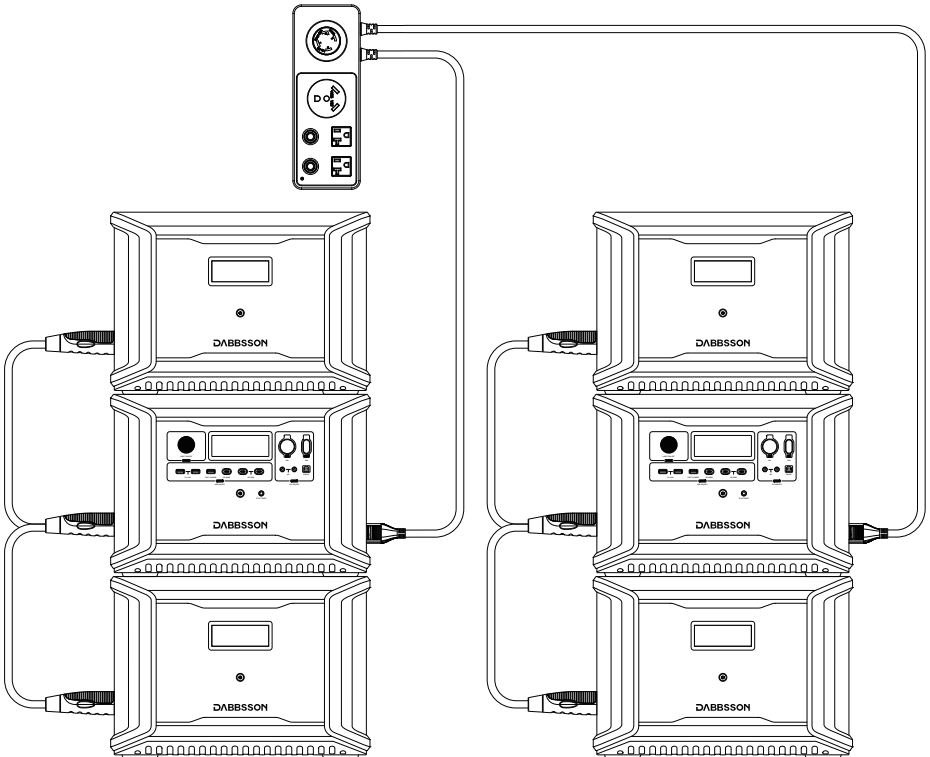
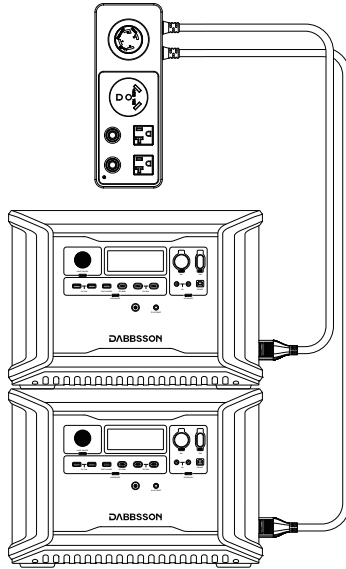

# 5. App Control



## Download Dabbsson APP

- 1 Search for "Dabbsson" in the APP Store (for iOS devices) or Google Play (for Android devices) to download the Dabbsson App.
- 2 You can download the app on the App Store and Google Play by scanning the QR codes below.



Android



iOS

- 3. Download the Dabbsson APP on the official website: [www.dabbsson.com](http://www.dabbsson.com)

## Connecting the APP to the product

### Method 1: Bluetooth Connection Mode

- 1 Connect the mobile phone to home 2.4G Wi-Fi network, open the DABBSSON APP, select "+Add Device" or the "+" symbol on the upper right corner of the home page.



2 Tap to open BT authorization dialog box and select allow to turn on BT Service. Allow New Connections.

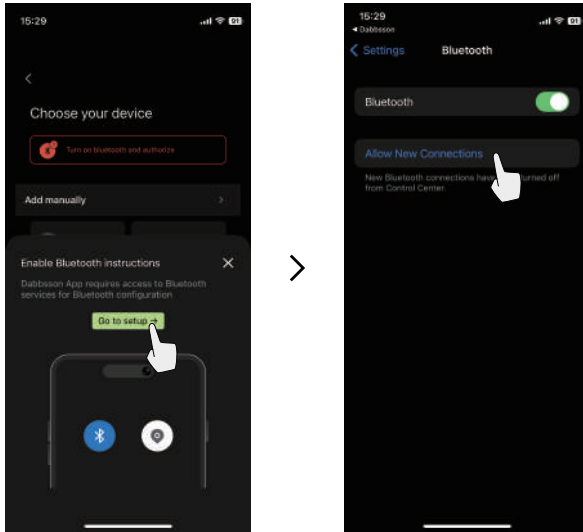

3 Wait for the unit to search nearby device.

4 After the device is found, select Add.

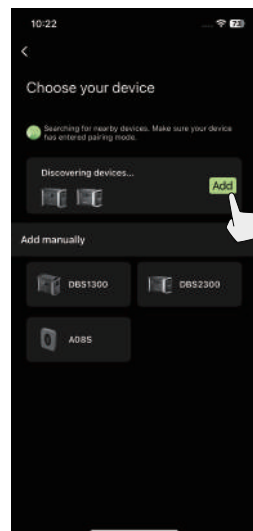
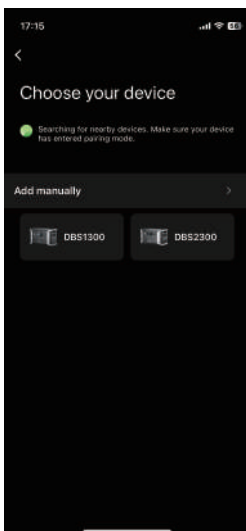

- 5 Enter home Wi-Fi name and passwords and select Next.

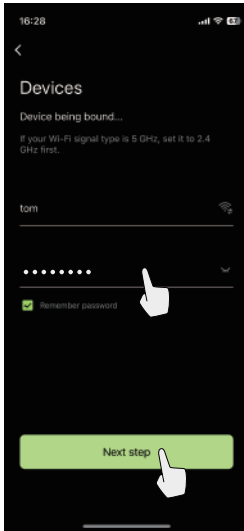

- 6 Add the power station and wait for it to connect.

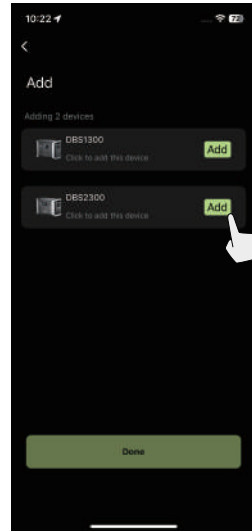

- 7 Select COMPLETE after the device is add successfully.

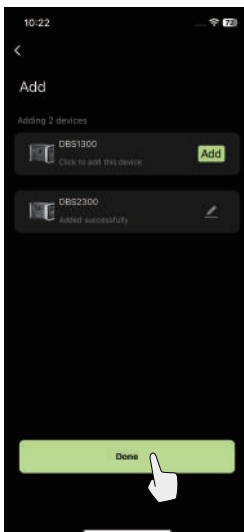

If the adding failed and shows following interface, please select reconnect until the complete interface appears.

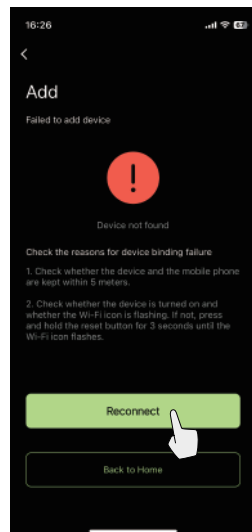

- After complete adding the device, select a UI style and select "Set to current style" and enter the APP control interface.

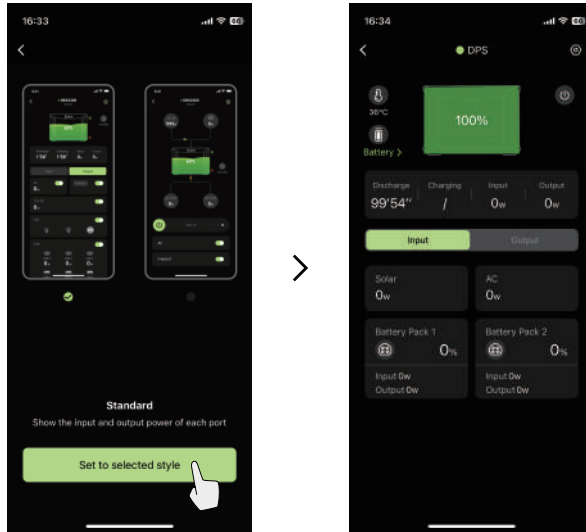

## Method 2: Wi-Fi Connection Mode

- Connect the mobile phone to home 2.4G Wi-Fi network, open the DABBSSON APP, select "+Add Device" or the "+" symbol on the upper right corner of the home page.

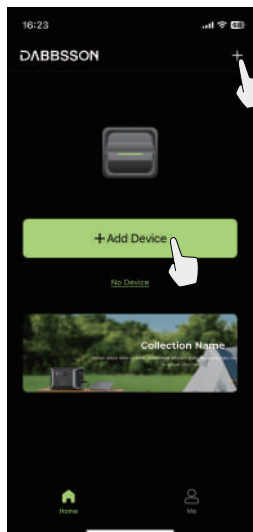

2 Select device model.

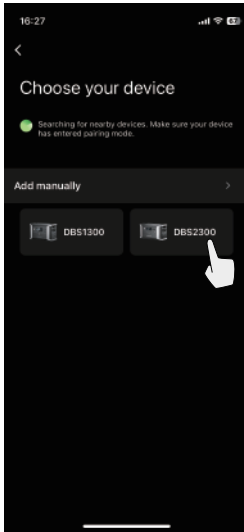

3 Long press the "IOT RESET" button on the device until you hear a "beep" and let go. Then select next.



4 Enter home Wi-Fi name and passwords and select Next.

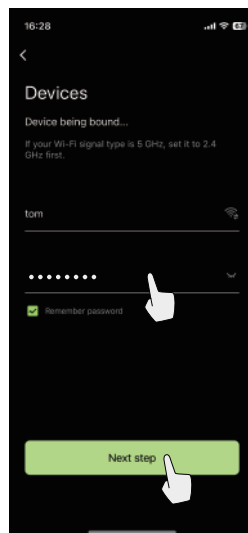



- 5 Tap go to connect and enter the phone's Wi-Fi setting. Select the Power station hotspot and connect to that hotspot.

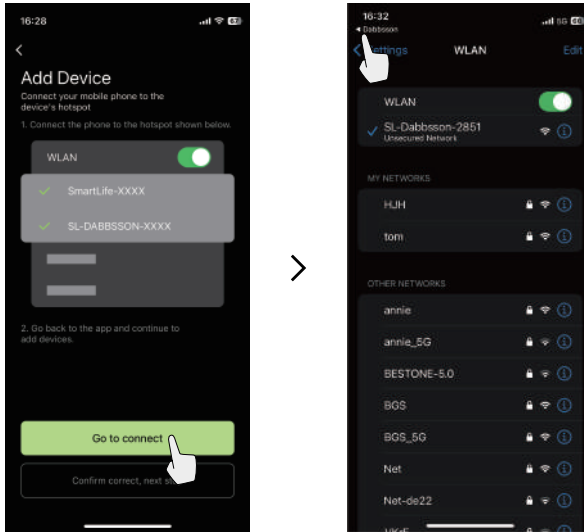

- 6 Go back to the APP interface, confirm the connection and wait for the device to connect.

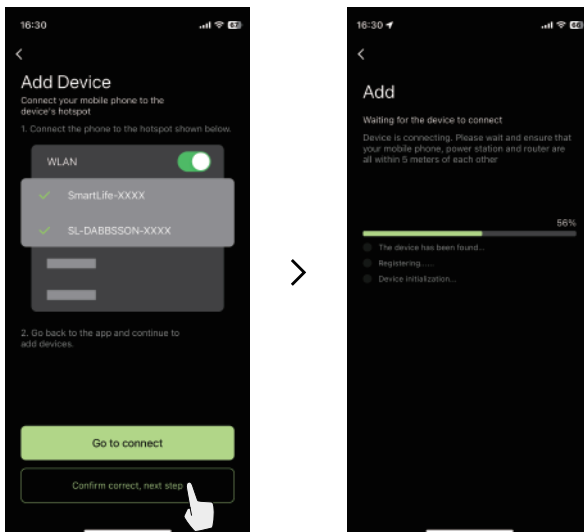

- 7 After the device is added successfully, select "Start using".

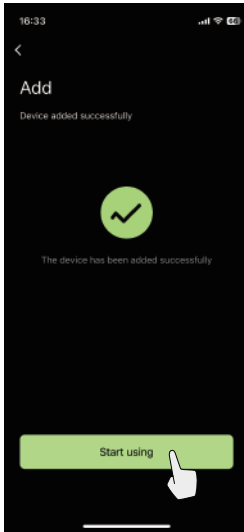

If the adding failed and shows following interface, please select reconnect until the complete interface appears.

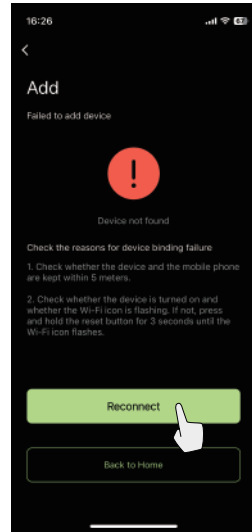

- 8 After complete adding the device, select a UI style and select "Set to current style" and enter the APP control interface. After successfully connecting and adding the power station through Wi-Fi for the first time, the APP can still operate the power station through BT offline after leaving the Wi-Fi network environment, but it must be within 10 meters.

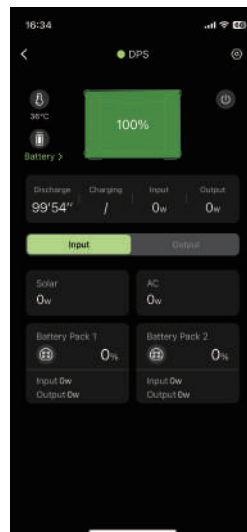

## Power station firmware update

- 1 Tap the device you want to upgrade, enter the device interface, tap the icon in the upper right corner to enter the setting page, find and click the firmware update option, enter the device update page, click "Update" at the bottom of the page, click "Confirm" on the pop-up window, wait for the firmware update, update After success, click Confirm to complete the update.

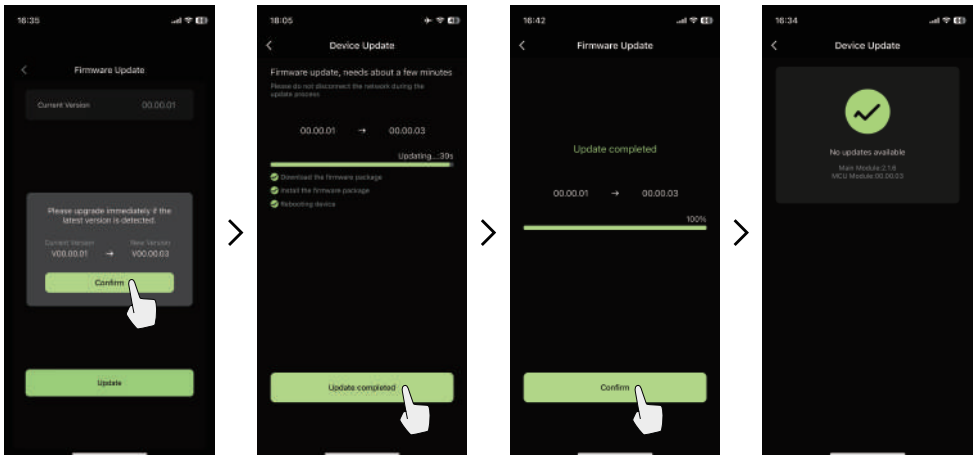
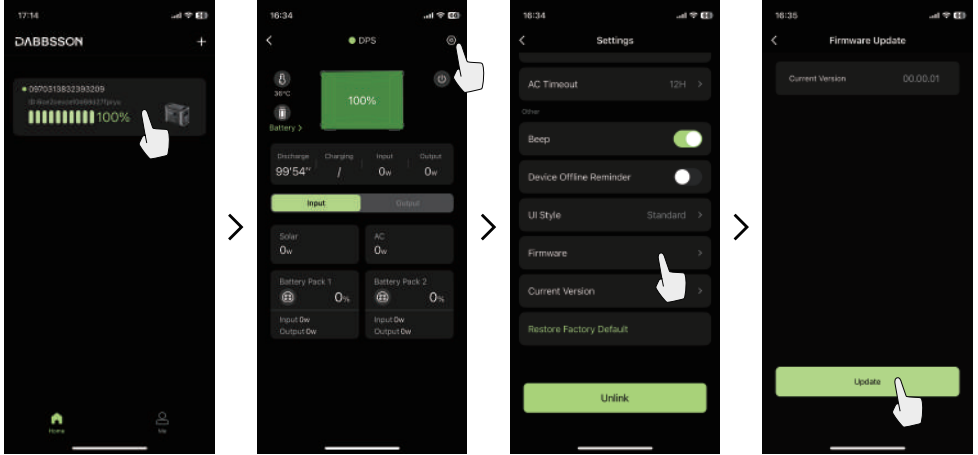

- 2 If the power station's firmware update failed, please try again.

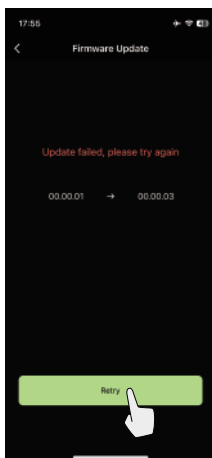

### Privacy Policy

By using Dabbsson Products, Applications and Services, you consent to the Dabbsson Term of Use and Privacy Policy, which you can access via the "support" section on the Dabbsson App or on the official Dabbsson website at <https://www.dabbsson.com>



## 6. FAQs



### 1. What type of batteries does the product use?

This product uses high-quality LiFePO4 battery.

### 2. What devices can use the product's AC output port power?

With 2200W rated power and 4400W peak power, the product's AC output port can power most household appliances. Before using we recommend you check the power of the appliances first and ensure the power sum of all loaded appliances is lower than the rated power.

### 3. How long does it take for the product to charge my devices?

The charging time is shown on the product's LCD Screen, which can be used to estimate the charging time of most appliances with stable power usage.

### 4. How can I tell if the product is charging?

The remaining charging time will be shown on the LCD Screen. The charging indicator will display remaining battery percentage, while current input power is shown to the right of the charging indicator.

### 5. How do I clean the product?

Please gently wipe it with a dry, soft, clean cloth or paper towel.

### 6. How should I store the product?

Before storing, turn off the product first, and then store it in a dry, ventilated area at room temperature. Do not place it near water sources. For long-term storage, discharge the battery to 30% and recharge it to 60% every three months to extend its battery life.

### 7. Can I bring the product on a plane?















No

### 8. What is the minimum wattage of solar input you recommend?

Due to the large capacity and high output power of this product, it is recommended that the solar input power should be at least 30-50W.

# 7. Troubleshooting



Indicator	Problem	Solution
<b>OVERLOAD</b>  (Flashing)	USB-A Overload Protection	Resume normal operation by removing the electrical device connected to the USB-A port.
 RECHARGING TIME	High Temperature Charge Protection	Charging will automatically resume after the battery cools down.
	High Temperature Discharge Protection	Power supply will automatically resume after the battery cools down.
 RECHARGING TIME	Low Temperature Charge Protection	Charging will automatically resume after battery temperature rises above -10°C(14°F).
	Low Temperature Discharge Protection	Power supply will automatically resume after the battery temperature rises above -20°C(-4°F).
<b>OVERLOAD</b>   (Flashing)	AC Output Overload Protection	Normal operation will automatically resume after you remove the overloaded device and restart the product.
   (Flashing)	AC High Temperature Protection	Check whether the fan inlet and/or outlet are blocked. If not, normal operation will automatically resume after the product cools down.
 (Flashing)	Fan Blockage	Please check if the fan is blocked.
<b>OVERLOAD</b>  (Flashing)	DC Output Overload Protection	The product will automatically resume normal operation after you remove the device connected to the DC outlet.
  (Flashing)	DC Output High Temperature Protection	The product will automatically resume normal operation after it cools down.
	Others	Contact Dabbsson Customer Service

## 8. What's in the Box

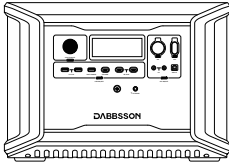

DBS2300Plus



Solar Charging Cable



Car Charging Cable



AC Charging Cable



User Manual



Warranty Card



Warning Card

## 9. Storage & Maintenance



1. Ideally, you should use and store the product at an ambient temperature between 20°C-30°C (68°F -86°F), and always keep it away from water, intense heat, and sharp objects. Do not store in temperatures above 45°C (113°F) or below -10°C (14°F) for an extended period.
2. Storing a battery with a low charge for a long period shortens its lifespan. DBS2300Plus mitigates the damage by putting the battery into hibernation mode. To get the most out of the battery, make sure it is at about 60% before putting DBS2300Plus into long-term storage. While in storage, it is recommended to discharge the battery to 30% and recharge it back to 60% every three months.

## 10. Fcc Statement



**This device complies with Part 15 of the FCC Rules. Operation is subject to the following two conditions:**

- (1) This device may not cause harmful interference.
- (2) This device must accept any interference received, including interference that may cause undesired operation.

### **Warning:**

Changes or modifications not expressly approved by the party responsible for compliance could void the user's authority to operate the equipment.

### **NOTE:**

This equipment has been tested and found to comply with the limits for a Class B digital device, pursuant to Part 15 of the FCC Rules. These limits are designed to provide reasonable protection against harmful interference when the equipment is operated in a commercial environment. This equipment generates, uses, and can radiate radio frequency energy and, if not installed and used in accordance with the instruction manual, may cause harmful interference to radio communications. Operation of this equipment in a residential area is likely to cause harmful interference in which case the user will be required to correct the interference at his own expense.

### **FCC Radiation Exposure Statement:**

This equipment complies with FCC radiation exposure limits set forth for an uncontrolled environment. This equipment should be installed and operated with minimum distance of 20cm between the radiator & your body.