



3500 Series

Electric Mortise Lock Collection



An ASSA ABLOY Group brand

ASSA ABLOY

3500 Series

General Information

Locking/Unlocking

Solenoid locking/unlocking of lever handles is multi voltage between 12V to 24V for 3570 Electric Mortice Locks.

For the 3580 Short Backset Electric Mortice Lock the voltage is 12V or 24V available.

The lock assembly has full capability for the on site selection of the following without the lock being dismantled:

- Handing of the lock to left or right hand doors.
- Setting of either the outside or both inside & outside handles being locked by the solenoid.
- Setting the locking function to either Fail Safe (Power to Lock) or Fail Secure (Power to Open), for 3570 only.

Note: Any attempt to dismantle the locks will void warranty.

Protection diode is included for back EMF suppression.

Fail Safe

- UNLOCKED with power OFF
- LOCKED with power ON

Fail Safe is not a performance warranty, but merely a descriptive term used to characterise a design feature of this device.

Fail Secure

- LOCKED with power OFF
- UNLOCKED with power ON

Fail Secure is not a performance warranty, but merely a descriptive term used to characterise a design feature of this device.

Monitoring

Monitored locks are equipped with sensors to provide status information on:

1. Door furniture handle operation (3570 & 3580)

Monitored by independent microswitches on each of the two lock hubs. Left or Right Hub is selected via the 4 way DIL switch located on the lock case. The hub microswitches are generally used for monitoring the inside lever to provide Request to Exit (REX) function. The switch will always activate prior to the deadlatch microswitch activation when retracting the bolt.

2. Key override monitoring (3570 & 3580)

This microswitch detects if a mechanical key has been used to retract the latch. The microswitch can be set to 'Normally Open' or 'Normally Closed' by using the settings on the lock case.

The switch will always activate prior to the deadlatch microswitch activation when retracting the bolt.

3. Bolt deadlatched and door locked status (3570 only)

Two switches wired in series achieve the above function which indicates door closed and secure. A microswitch within the lock assembly is activated when the latchbolt is deadlatched, and a microswitch is activated when the solenoid locking mechanism moves to the locked state. Thus retraction of the deadlatch or unlocking of the mechanism will break the deadlatched and door locked circuit.

4. Bolt deadlatched and door closed status (3580 only)

Two switches wired in series achieve the above function which indicates door closed and deadlatched. A microswitch within the lock assembly is activated when the latchbolt is deadlatched, and a reed switch is activated when in close proximity to the reed magnet mounted in the door jamb. Thus retraction of the deadlatch or partial opening of the door will break the deadlatched and door closed circuit.

5. Door Status (3570 only)

An Isolated Door Closed Reed Switch is activated when in close proximity to the reed magnet mounted in the door jamb to indicate the door is closed.

Drilling, Installation, Wiring

Please read the installation instructions before attempting to install the lock.

Use ASSA ABLOY Australia accessories.

Use power supplies which meet electrical specifications.

Mortice for lock must be wide enough. (Lockcase must be able to push in easily).

Allow spare cable behind lock for ease of servicing.

The lockcase must not be exposed to humidity, dust or filings.

Bolt must retract and engage easily with striker plate.

Check operation of the lock after installation.

Specification Service

For all Architectural hardware specification assistance refer to your local ASSA ABLOY Australia Sales Office.

A fully comprehensive, obligation free, Architectural Door Hardware specification can be prepared by ASSA ABLOY Australia Architectural Hardware Consultants.

ASSA ABLOY Australia Pty Limited reserve the right to alter product specifications and embody improvements at any time as part of its continuing research and development programme of design, manufacture and materials.

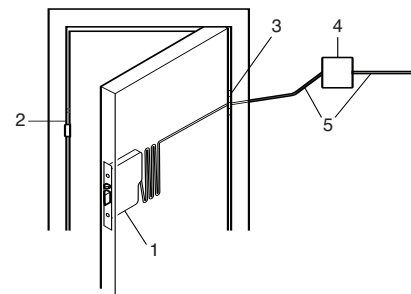

LEGEND

- 1 Electromechanical lock
- 2 Reed magnet and Striker plate
- 3 Power transfer device
- 4 Connection unit
- 5 Connection cable

3500 Series Electric Mortice Lock

Contents

Description	Page
3500 Series General Information	2
3570 Series Function Chart	4
3570 Series Electrical Specifications	5
3570 Series Standard Backset Features	6
3570 Series Standard Backset Specifications	7
3570 Series Standard Backset Ordering Procedure	8
3570 Series Standard Backset Accessories	9
3580 Series Short Backset Function Chart	10
3580 Series Short Backset Electrical Specifications	11
3580 Series Short Backset Features	12
3580 Series Short Backset Specifications	13
3580 Series Short Backset Ordering Procedure	14
3580 Series Short Backset Accessories	15

3570 Series

Function Chart

The 3500 Series electric lock allows doors to be electrically locked and unlocked. They can be operated by pushbuttons, intercom systems and key switches or higher security devices such as keypads and card readers.

The feature list includes the following:

- Field reversible Fail Safe, Fail Secure configuration.
- Field changeable monitoring contacts between normally closed (N/C) and normally open (N/O) for key override monitoring and hub monitoring.
- Field reversible mechanical handing to suit left hand (LH) and right hand (RH) swinging doors.
- Field changeable selection of free lever or locked lever on both sides of the door.
- Multi-voltage - will work on 12 - 24 VDC systems.
- Reduced stock levels due to field changeable options.

3572 Series Vestibule Locks

Deadlatching functions with single action escape feature, the inside handle remaining free at all times.

Lock Operation

- Outside:** Open by handle except when handle is locked by solenoid.
Open by key where applicable at all times.
- Inside:** Open by handle at all times.

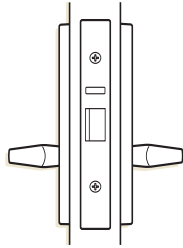

Non-Monitored Lock (Reversible)
3572ELNO Series
Monitored Lock (Reversible)
3572ELMO Series

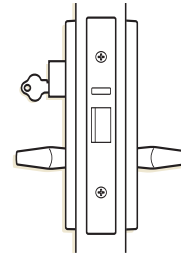

Non-Monitored Lock with Key Override (Reversible)
3572ELN1 Series
Monitored Lock with Key Override (Reversible)
3572ELM1 Series

3574 Series Combination Locks

Deadlatching functions with latchbolts operated by exterior or interior handles except when both handles have been locked.

Lock Operation

- Outside:** Open by handle except when handle is locked by solenoid.
Open by key where applicable at all times.
- Inside:** Open by handle except when handle is locked by solenoid.
Open by key where applicable at all times.

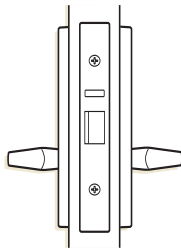

Non-Monitored Lock (Reversible)
3574ELNO Series
Monitored Lock (Reversible)
3574ELMO Series

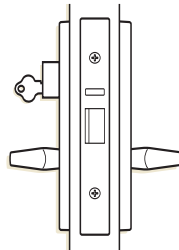

Non-Monitored Lock with Key Override (Reversible)
3574ELN1 Series
Monitored Lock with Key Override (Reversible)
3574ELM1 Series

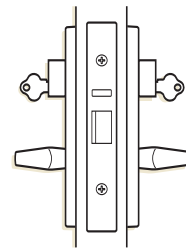

Non-Monitored Lock with Key Override Both Sides (Reversible)
3574ELN2 Series
Monitored Lock with Key Override Both Sides (Reversible)
3574ELM2 Series

3500 Series Electric Mortise Lock

3570 Series (continued)

Electrical Specifications

Circuit Diagram

Note: Diagram depicts fail safe RH opened door, with handle and key in rest state.

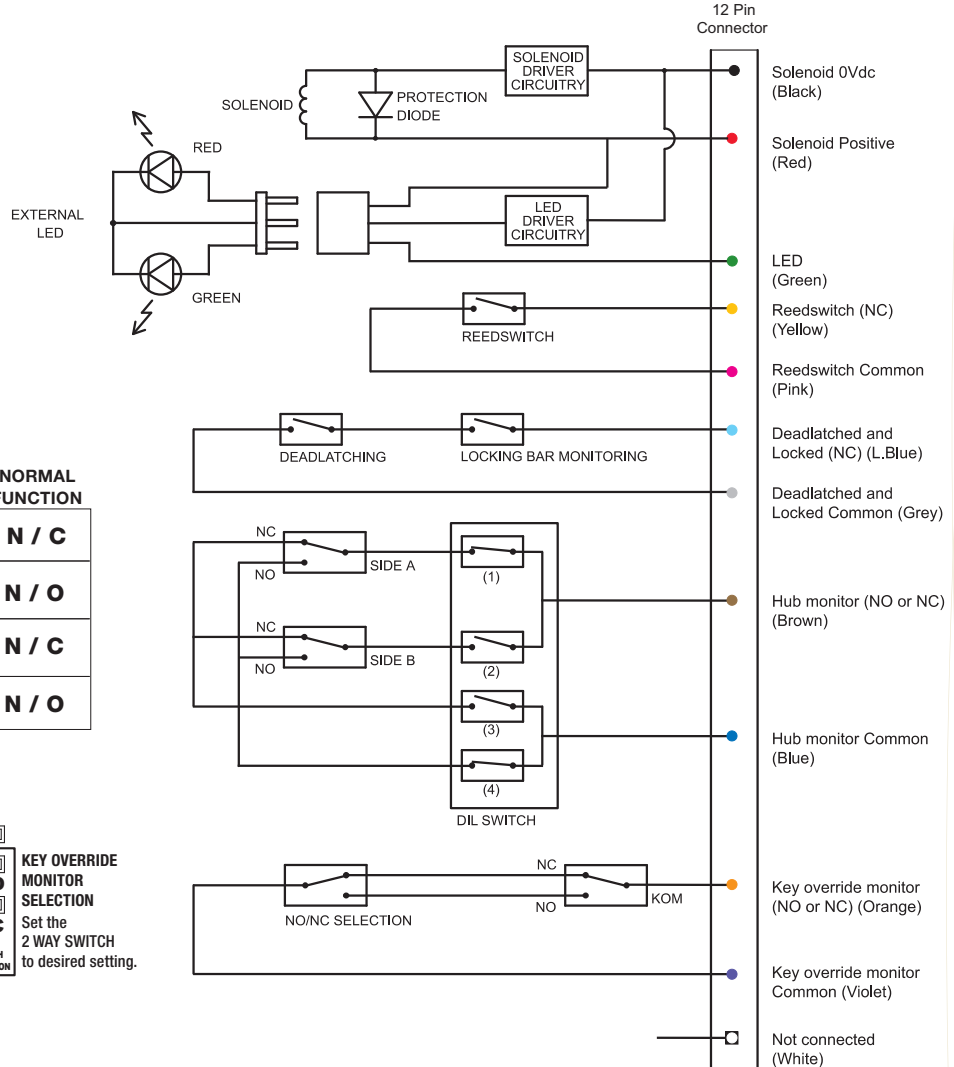
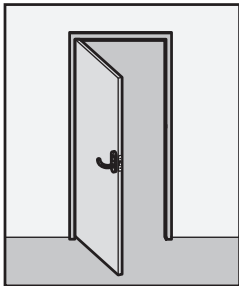

DIL Switch Settings

HUB MONITOR

	SWITCH No.				LOCK SIDE	NORMAL FUNCTION
	1	2	3	4		
ON	OFF	ON	OFF	ON	A	N / C
ON	OFF	ON	OFF	OFF	A	N / O
ON	OFF	OFF	ON	ON	B	N / C
ON	OFF	OFF	ON	OFF	B	N / O

KEY OVERRIDE MONITOR SELECTION

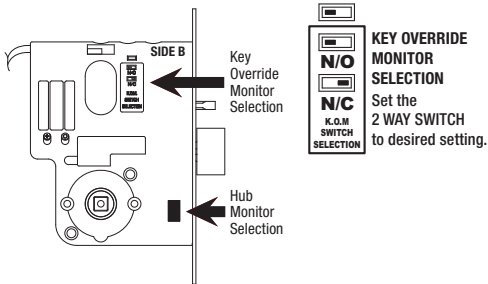

Electrical Specifications

Solenoid Activation

Operating Voltage:
12 - 24V dc

Operating Current:
500mA (max) 80mA holding @ 12V dc
275mA (max) 50mA holding @ 24V dc

For confirmation of the above mentioned operating current, please see installation manual.

LED Current

Where LEDs are fitted, add 20mA (max) to total operating current.

Monitoring Circuits

Microswitches: 500mA (max) @ 30V dc each circuit
Reedschwitche: 100mA (max) @ 30V dc

Colour

Black	Solenoid (0V dc)
Red	Solenoid Positive (12V dc - 24V dc)
Green	LED (12V dc - 24V dc)
Yellow	Door closed. Reedschwitche (NC)
Pink	Reedschwitche (common)
Light Blue	Deadlatched and Locked (NC)
Grey	Deadlatched and Locked (common)
Brown	Hub monitor (NO or NC)
Blue	Hub monitor (common)
Orange	Key override monitor (NO or NC)
Violet	Key override monitor (common)
White	Not connected

3570 Series Standard Backset

Features

Patent Protection

The following features are protected by patents in Australia and overseas.

- Hub selection.
- Cylinder fixing.
- Hub monitoring.
- Deadlocking monitoring.

Hub Selection

Cam operated adjustment of locking members attached to the snib and accessible through the lock body from the outside to set hubs as required.

Latch Bolt

Reversible for both left and right hand doors opening in or opening out without disassembly.

Standard deadlatch configuration.

Separate auxiliary bolt moves into lock case simultaneously with latch bolt.

Bolt – standard stainless steel fire rated up to 4 hours.

Strike

Universal stainless steel strike suitable for up to 4 hour fire rating applications.

Door Thickness

Standard applications 32 to 50 mm.

Backsets

60 mm standard, 89 and 127 mm available on application.

Cylinder/Adaptor Retention

Patented “Slip Pin” Cylinder/Adaptor fixing method, which allows attachment to the case by inserting a non threaded cylindrical pin through the front of the lock case.

Multi-Function Lock

Lock is designed to significantly reduce stock line items.

Standard cylinder mortice lock can be converted from escape function to combination function by simple manipulation of hub snibs without lock case disassembly. Field selectable Fail Safe or Fail Secure Function.

Case Assembly

High purity zinc alloy case and back plate.

Cylinder Assembly

Existing cylinder assemblies ie, same “X” cams as the ASSA ABLOY Australia Lockwood 570 Oval Cylinder Assemblies.

LED Connection

Right or left hand connection points for status LED's.

Hub Monitor Selection Switch

Select normally open, normally closed, right hand or left hand hub monitoring combinations.

Key Override Monitor Selection Switch

Select normally open or normally closed configuration.

Door Position Switch

Reed switch located within lock housing.

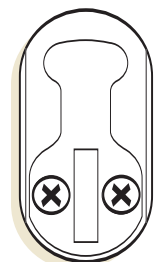

3500 Series Electric Mortice Lock

3570 Series Standard Backset (continued)

Specifications

Case & Cover

High purity zinc alloy material cases and stainless steel cover plates. Brass plates provided for plated finishes.

Backset

60 mm standard backset. Extended backsets 89 and 127 mm are available on application.

Latchbolts & Deadlatching

Latchbolts are 15 mm stainless steel. Deadlatching is achieved by an auxiliary stainless steel latchbolt. This auxiliary bolt retracts when the main latchbolt is withdrawn and is depressed when the door is closed.

Door Clearance

To ensure correct functioning of the deadlatching mechanism and security for all locks, the clearance between the door and frame should be 3 mm. However the deadlatching will operate up to 6.5 mm door clearance.

Door Thickness

32 to 50 mm. Doors greater than 50 mm will require accessories with extended lengths. Refer to Lockwood Spare Parts Price List for details.

Extended Cylinders

Extended cylinders are available where door thickness exceeds 50 mm. Refer to ASSA ABLOY Australia Keying & Restricted Profiles Price List for further information.

Security

All 3570 Series Electric Mortice Locks conform with Level S3 (Physical Security) Australian Lock Standard (AS 4145.2: 1993).*

* When used with a high security keying system such as ABLOY Protec or Lockwood TWIN Keying Systems. Level S2 applies with lower security keying systems.

Durability

All 3570 Series Electric Mortice Locks conform with level D3 (Durability) Australian Lock Standard (AS 4145.2: 1993).

Lock/Cable Connection

Unless otherwise ordered, 1.6 meters length of cable with a 12 pin socket will be supplied with each lock. All locks will be supplied with a positive latching 12 pin plug, emanating from the top of the lock on a short length of cable.

Door Furniture

All Lockwood and Efco Series door furniture can be used with the 3570 range of Electric Mortice Locks. Refer to the ASSA ABLOY Australia Commercial Security Price Book for further information.

Door Furniture with Visual Indication

All monitored locks are equipped to visually indicate the lock's status. If this feature is required, door furniture plates incorporating Light Emitting Diodes are available in Lockwood furniture.

Fire Doors



Lockwood 3570 Series Electric Mortice Locks have been successfully fire tested up to 4 hours on fire door assemblies in accordance with Australian Standard AS 1905.1 - 2005, Part 1: Fire-resistant doorsets.

Rebate

Rebate kits to suit 13 mm standard rebate are available.

Keying

Cylinder

Standard ASSA ABLOY Australia oval shaped cylinders and plugs.

Standard Keying

Supplied individually keyed 5 pin cylinder with 2 keys per lock. 78,000 key combinations. Key blank KB2015P.

Special Keying

Lockwood Electric Mortice Locks are available specially keyed. Refer to the ASSA ABLOY Australia Keying & Restricted Profiles Price List for further information.

Standard Finishes

Satin Chrome	SC
Bright Chrome	CP
Polished Brass	PB
Florentine Bronze	FB

Limiting Dimensions

Dimension	Backset		
A	60	89	127
B	100	129	167

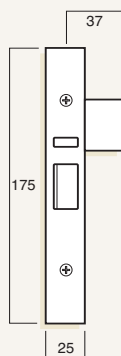
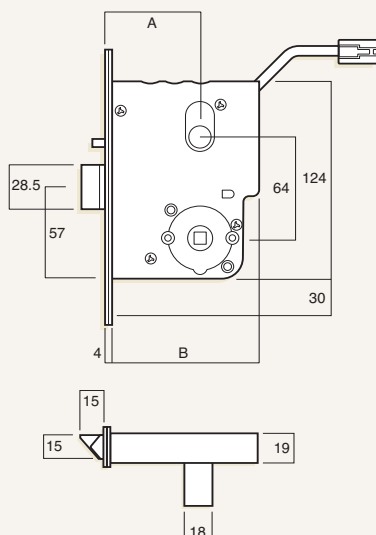

Reed Magnet

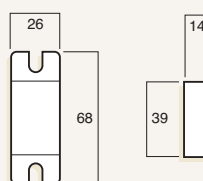
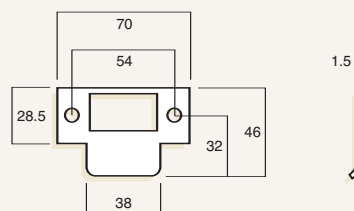
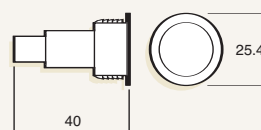

3570 Series Standard Backset (continued)

Ordering Procedure

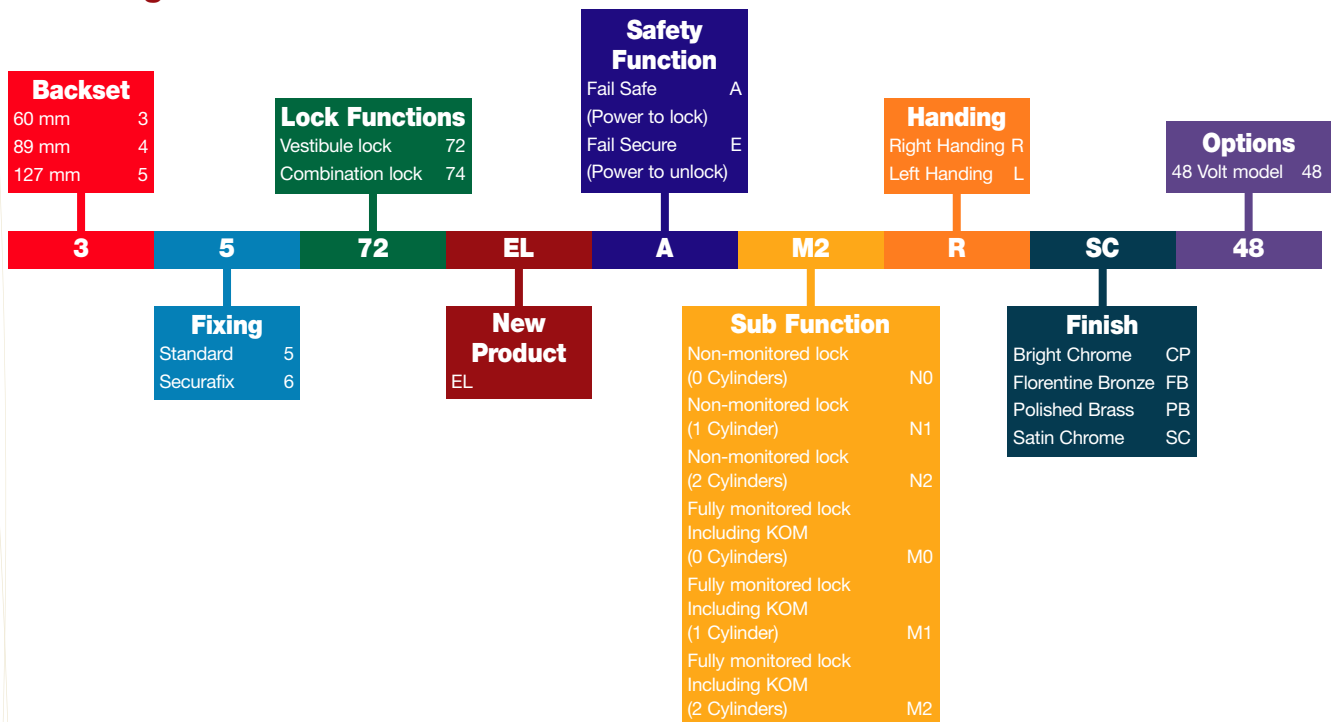

Rebated Doors

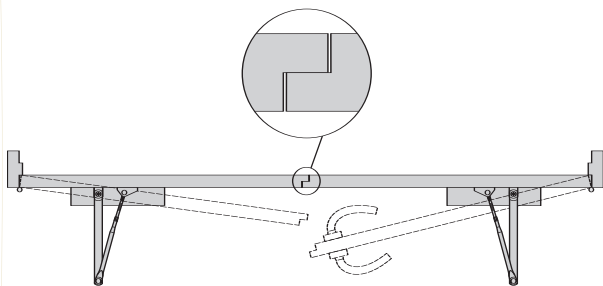

Handing Chart

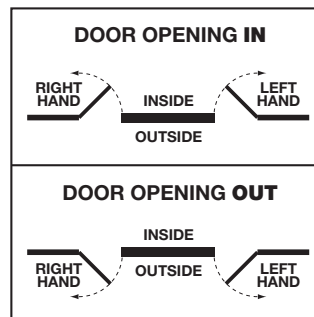

Backset

Nominate backset as required, eg 60mm

3

Fixing

Select the desired fixing method, eg Standard Fixing

35

Lock Functions

Select function, eg Vestibule Lock

3572

Electrical Variant

Indicate that this is an Electric Lock - New Model

3572EL

Safety Function

Select whether lock should Fail Secure or Fail Safe, eg Fail Safe

3572ELA

Monitoring and Key Override Options

Select monitoring and cylinders to be supplied, eg Fully Monitored Lock Including KOM with 2 cylinders

3572ELAM2

Handing

Determine left or right handing, eg Right Handing

3572ELAM2R

Finish

Select appropriate finish, eg Satin Chrome

3572ELAM2RSC

Options

Select 48VDC coil when required, otherwise leave blank (Lock is multivoltage by default, eg 12-24V)

3572ELAM2RSC48

3500 Series Electric Mortice Lock

3570 Series Standard Backset (continued)

Accessories

Long Lipped Strikes

Finish	"A"	Part No
Bright Chrome	43.5	3570 – 5353 CP
	47.5	3570 – 5653 CP
Florentine Bronze	43.5	3570 – 5353 FB
	47.5	3570 – 5653 FB
Polished Brass	43.5	3570 – 5353 PB
	47.5	3570 – 5653 PB
Satin Stainless Steel	43.5	3570 – 5253 SSS
	47.5	3570 – 5453 SSS

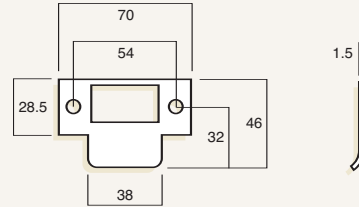

Rebate Kits

Finish	"A"	Part No
Bright Chrome	32	3570 – 2902 CP
	46	3570 – 3902 CP
Florentine Bronze	32	3570 – 2902 FB
	46	3570 – 3902 FB
Polished Brass	32	3570 – 2902 PB
	46	3570 – 3902 PB
Satin Chrome	32	3570 – 2902 SC
	46	3570 – 3902 SC
Satin Stainless Steel	32	3570 – 2902 SSS
	46	3570 – 3902 SSS

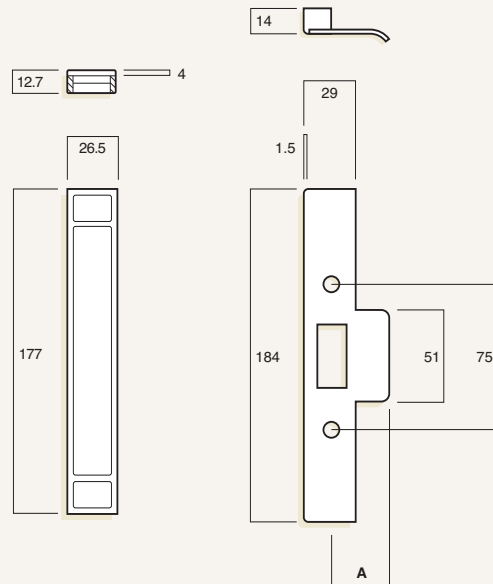

Extended Cylinders

Extended cylinders should be considered when door thickness exceeds 50 mm or when the lock is mounted off centre in the door edge. A range of cylinders is available to suit various door thicknesses.

Refer to ASSA ABLOY Australia Keying and Restricted Price List for further information.

"A" Cylinder Projection	Cylinder Length	Recommended Door Thickness (lock central)
41	37	50 to 60
52	48	60 to 84
64	60	84 to 108
80	76	108 to 132
88	84	132 to 156

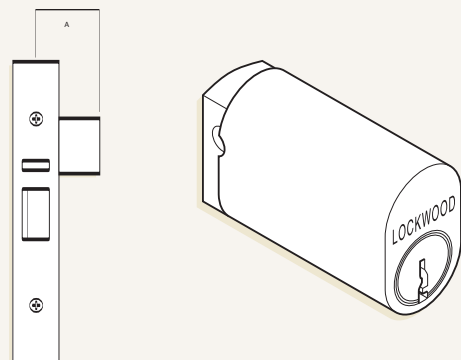

3580 Series

Function Chart

The 3580 Series electric lock allows doors to be electrically locked and unlocked. They can be operated by pushbuttons, intercom systems and key switches or higher security devices such as keypads and card readers.

The feature list includes the following:

- Field changeable handing to suit left hand (LH) and right hand (RH) doors.
- Field changeable selection of free lever or locked lever on both sides of the door.
- Key override with monitoring of key operation.
- Lever is locked and unlocked electrically.
- Door closed and deadlatched monitoring (door sealed indication).
- Lever rotation monitoring (request to exit).
- Field changeable contacts - normally closed (N/C), normally open (N/O) for key override monitoring and hub monitoring.
- Reduced stock levels due to field changeable options.

3582 Series Vestibule Locks

Deadlatching functions with single action escape feature, the inside handle remaining free at all times.

Lock Operation

- Outside:** Open by handle except when handle is locked by solenoid.
Open by key where applicable at all times.
- Inside:** Open by handle at all times.

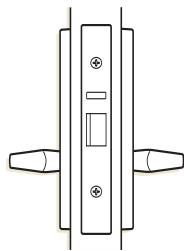

Non-Monitored Lock (Reversible)
3582ELNO Series
Monitored Lock (Reversible)
3582ELMO Series

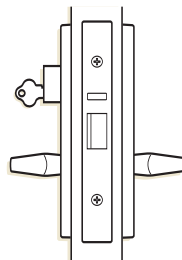

Non-Monitored Lock with Key Override (Reversible)
3582ELN1 Series
Monitored Lock with Key Override (Reversible)
3582ELM1 Series

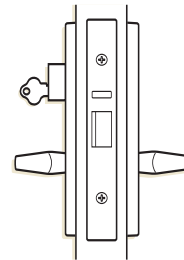

Monitored Lock with Monitored Key Override (Handed)
3582ELM4 Series (no cylinder supplied)
3582ELM5 Series (with cylinder)

3584 Series Combination Locks

Deadlatching functions with latchbolts operated by exterior or interior handles except when both handles have been locked.

Lock Operation

- Outside:** Open by handle except when handle is locked by solenoid.
Open by key where applicable at all times.
- Inside:** Open by handle except when handle is locked by solenoid.
Open by key where applicable at all times.

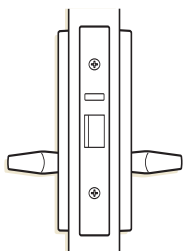

Non-Monitored Lock (Reversible)
3584ELNO Series
Monitored Lock (Reversible)
3584ELMO Series

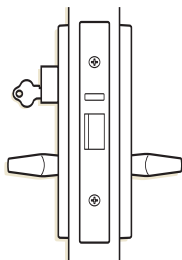

Non-Monitored Lock with Key Override (Reversible)
3584ELN1 Series
Monitored Lock with Key Override (Reversible)
3584ELM1 Series

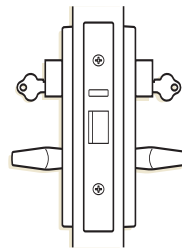

Non-Monitored Lock with Key Override Both Sides (Reversible)
3584ELN2 Series
Monitored Lock with Key Override Both Sides (Reversible)
3584ELM2 Series

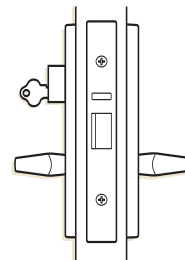

Monitored Lock with Monitored Key Override (Handed)
3584ELM4 Series (no cylinder supplied)
3584ELM5 Series (with cylinder)

3500 Series Electric Mortice Lock

3580 Series (continued)

Electrical Specifications

Circuit Diagram

Note: Diagram depicts fail safe 12V RH opened door, with handle and key in rest state.

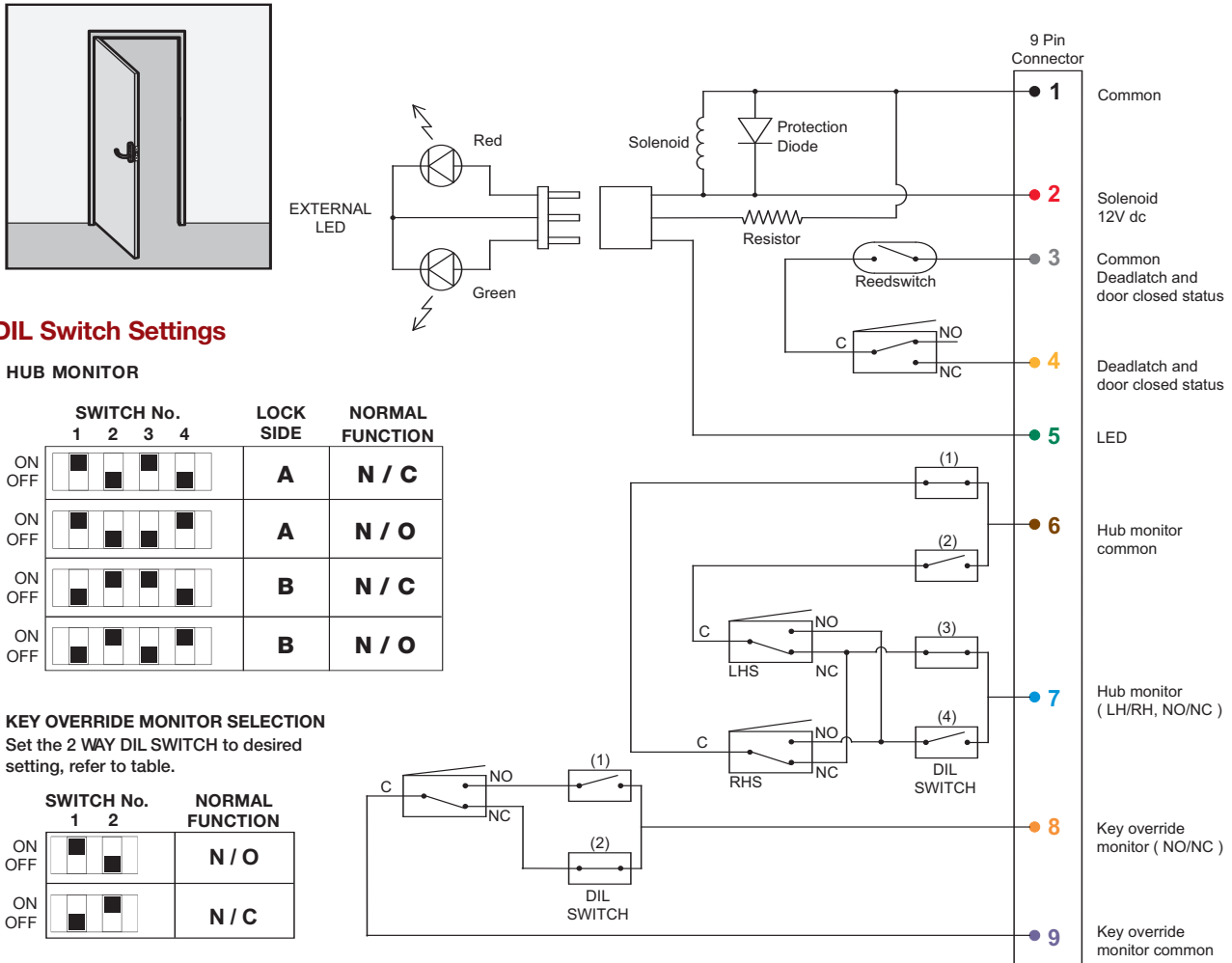

DIL Switch Settings

HUB MONITOR

	SWITCH No.				LOCK SIDE	NORMAL FUNCTION
	1	2	3	4		
ON	■	■	■	■	A	N / C
OFF	□	□	□	□		
ON	■	■	□	■	A	N / O
OFF	□	□	■	□		
ON	■	□	■	■	B	N / C
OFF	□	■	□	□		
ON	■	□	■	□	B	N / O
OFF	□	■	□	■		

KEY OVERRIDE MONITOR SELECTION

Set the 2 WAY DIL SWITCH to desired setting, refer to table.

	SWITCH No.		NORMAL FUNCTION
	1	2	
ON	■	■	N / O
OFF	□	□	
ON	■	□	N / C
OFF	□	■	

Electrical Specifications

Hub Snib Activation (Solenoid Activated)

12V dc ± 5% 250mA (max)

24V dc ± 5% 125mA (max)

Hub/Deadlatch/Key override monitor

Miniature lever microswitch
max ratings 500mA @ 30V dc

Door Status Monitor

Miniature magnetic reed switch
max ratings 3W, 250mA (max) @ 12V dc
125mA (max) @ 24V dc

LED Current

Where LEDs are fitted, add 15mA (max) to total operating current.

Plug Arrangements

3580 - 9 pin plug supplied with 3.6 m of cable.

Pin	Colour	Function
1	Black	Common (0V dc)
2	Red	Solenoid (12V dc or 24V dc)
3	Grey	Deadlatch and door closed status (common)
4	Yellow	Deadlatch and door closed status
5	Green	LED
6	Brown	Hub monitor (common)
7	Blue	Hub monitor (RH/LH, NO/NC)
8	Orange	Key override monitor (NO/NC)
9	Violet	Key override monitor (common)

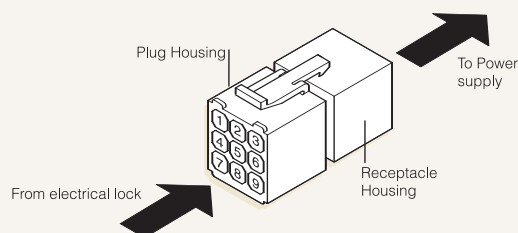

3580 Series Short Backset

Features

Patent Protection

The following features are protected by patents in Australia and overseas.

- Hub selection.
- Cylinder fixing.
- Hub monitoring.
- Deadlocking monitoring.
- Key override monitoring.

Hub Selection

Sliding adjustable locking members attached to the snib, screw fixed in either the operative or inoperative positions, accessible from the outside of the lock body to set hubs as required.

Latch Bolt

Reversible for both left and right hand doors, opening in or opening out without disassembly.

Standard deadlatch configuration only, 15 mm stainless steel material.

Separate auxiliary bolt moves into lock case simultaneously with latch bolt.

Strike

Brass material to suit inward/outward opening doors to conform to Australian Lock Standard universal strike.

Door Thickness

Timber doors: 32 to 50 mm.

Metal doors: 35 to 50 mm.

Backsets

Standard Backset – 23 mm.

Other backsets available on application 25.4 mm, 30 mm and 38 mm.

Cylinder/Adaptor Retention

Patented "Slip Pin" Cylinder/Adaptor fixing method, which allows attachment to the lock case by inserting a non threaded cylindrical pin through the front of the lock case.

Multi-Function Lock

Lock is designed to significantly reduce stock line items.

Standard cylinder mortice lock can be converted from escape function to combination function by simple manipulation of hub snibs without lock case disassembly.

Rebate Kits

Rebate kits suitable for timber doors with a minimum backset of 30 mm.

Case Assembly

High purity zinc alloy case and back plate.

Cylinder Assembly

Existing cylinder assemblies ie, same "X" cams as Lockwood 570 oval cylinder assemblies.

Lock Fixing

Fabricator pack fixing.

LED Connection

Right or left hand connection points for status LED's.

Hub Monitor Selection Switch

Select normally open, normally closed, right hand or left hand hub monitoring combinations.

Key Override Monitor Selection

Select normally open or normally closed configuration.

Door Position Switch

Reed switch located within lock housing.

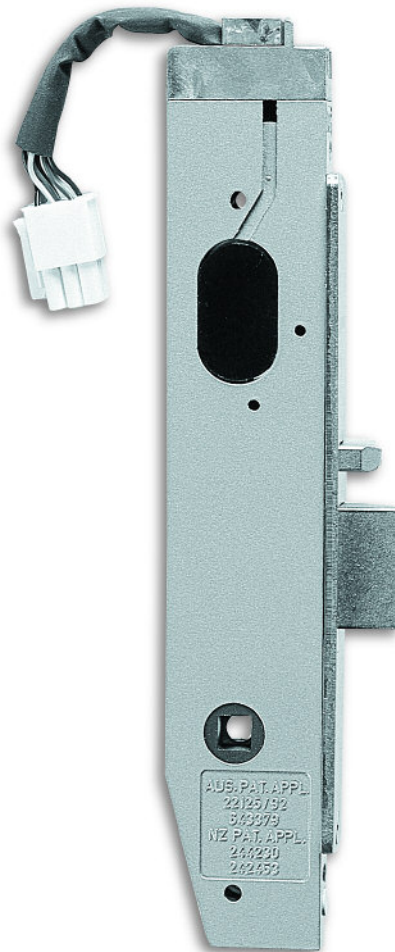
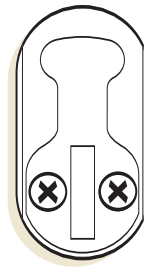

3500 Series Electric Mortice Lock

3580 Series Short Backset (continued)

Specifications

Case & Cover

High purity zinc alloy material cases and stainless steel cover plates. Brass plates provided for plated finishes.

Backset

23 mm standard backset. Extended backsets 25.4, 30 and 38 mm are available on application.

Latchbolts & Deadlatching

Latchbolts are 15 mm stainless steel. Deadlatching is achieved by an auxiliary stainless steel latchbolt. This auxiliary bolt retracts when the main latchbolt is withdrawn when the door is closed.

Door Clearance

To ensure correct functioning of the deadlatching mechanism and security for all locks, the clearance between the door and frame should be 3 mm. However the deadlatching will operate up to 6.5 mm door clearance.

Door Thickness

32 to 50 mm. Doors greater than 50 mm will require accessories with extended lengths. Refer to the Lockwood Spare Parts Price List for details.

Extended Cylinders

Extended cylinders are available where door thickness exceeds 50 mm. Refer to the ASSA ABLOY Australia Keying & Restricted Profiles Price List for further information.

Security

All 3580 Series Electric Mortice Locks conform with Level S2 (Physical Security) Australian Lock Standard (AS 4145.2: 1993).*

* When used with a high security keying system such as Lockwood V7. Level S2 applies with lower security keying systems.

Durability

All 3580 Series Electric Mortice Locks conform with level D3 (Durability) Australian Lock Standard (AS 4145.2: 1993).

Lock/Cable Connection

Unless otherwise ordered, 3.6 meters length of cable with a 9 pin socket will be supplied with each lock. All locks will be supplied with a positive latching 9 pin plug, emanating from the top of the lock on a short length of cable.

Door Furniture

Lockwood and EfcO Series door furniture can be used with the 3580 range of Electric Mortice Locks. Refer to the Lockwood Commercial Security Price Book for further information.

Door Furniture with Visual Indication

All monitored locks are equipped to visually indicate the lock's status. If this feature is required, door furniture plates incorporating Light Emitting Diodes are available in Lockwood furniture.

Rebate

Rebate kits to suit 13 mm standard rebate are available.

Keying

Cylinder

Standard Lockwood oval shaped, brass cylinders and brass plugs.

Standard Finishes

Supplied individually keyed 5 pin cylinder with 2 keys per lock. 78,000 key combinations. Key blank KB2015P.

Special Finishes

Lockwood Electric Mortice Locks are available specially keyed. Refer to the ASSA ABLOY Australia Keying & Restricted Profiles Price List for further information.

Standard Finishes

Bright Chrome	CP
Florentine Bronze	FB
Polished Brass	PB
Satin Chrome	SC

Limiting Dimensions

Dimension	Backset			
	23	25.4	30	38
X	23	25.4	30	38
Y	36.4	39	43.6	51.7
	40	43	48	57

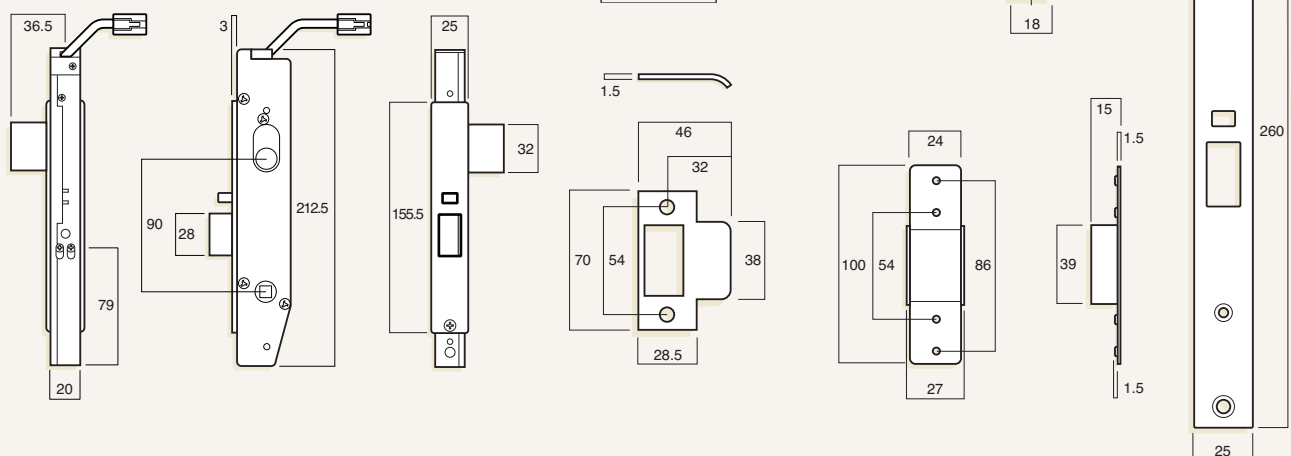

3580 Series Short Backset (continued)

Ordering Procedure

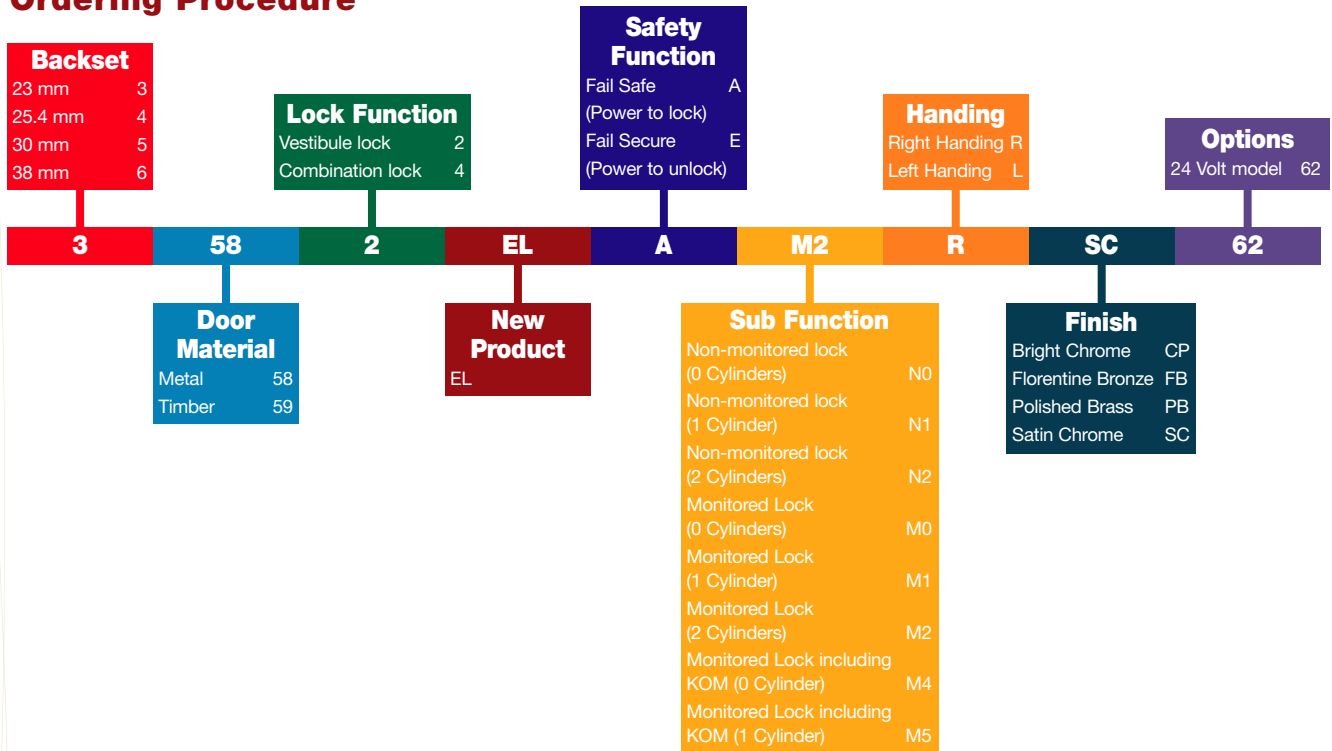

Rebated Doors

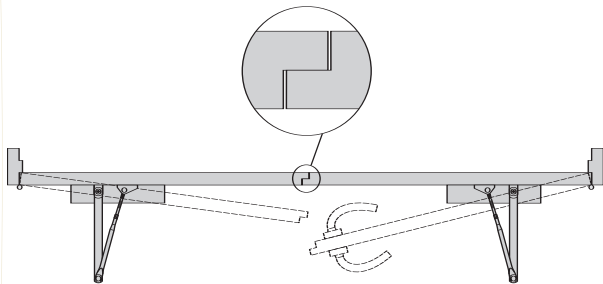

Handing Chart

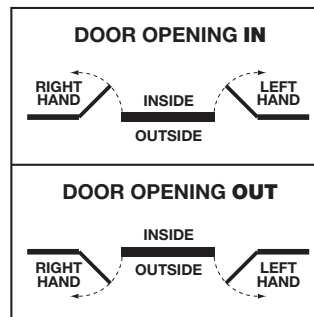

Backset

Nominate backset as required, eg 23 mm

3

Door Material

Nominate door material, eg Metal

358

Lock Function

Select function, eg Vestibule Lock

3582

Electrical Variant

Indicate that this is an Electric Lock - New Model

3582EL

Safety Function

Select whether lock should Fail Secure or Fail Safe, eg Fail Safe

3582ELA

Monitoring and Key Override Options

Select monitoring and cylinders to be supplied, eg Monitored Lock with Key Override

3582ELAM2

Handing

Determine left or right handing, eg Right Handed

3582ELAM2R

Finish

Specify appropriate finish, eg Satin Chrome

3582ELAM2RSC

Options

Specify 24VDC option when required

3582ELAM2RSC62

3500 Series Electric Mortice Lock

3580 Series Short Backset (continued)

Accessories

Rebate Kits

Rebate kits to suit 13 mm rebated timber doors with a minimum backset of 30 mm includes an adaptor to mount the lock and a special strike plate. Handing of the rebate kits is determined by the opening movement of the door on which the lock is fitted.

Part no.

Finish	Anti-clockwise	Clockwise
Satin Chrome	3580-2902ACWSC	3580-2902CWSC
Bright Chrome	3580-2902ACWCP	3580-2902CWCP
Polished Brass	3580-2902ACWPB	3580-2902CWPB
Florentine Bronze	3580-2902ACWFB	3580-2902CWFB

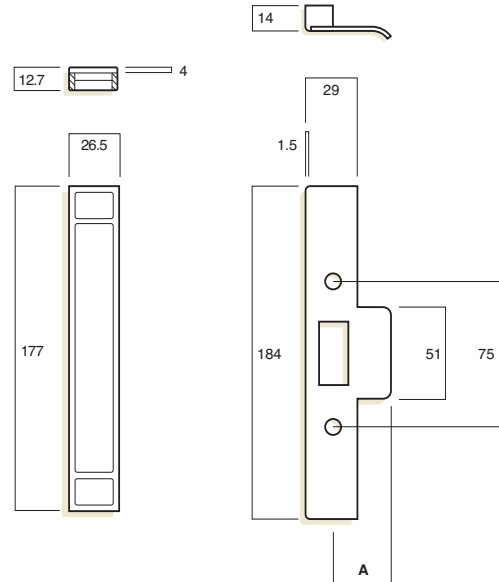

Extended Cylinders

Extended cylinders should be considered when door thickness exceeds 50 mm or when the lock is mounted off centre in the door edge. A range of cylinders is available to suit various door thicknesses.

Refer to ASSA ABLOY Australia Keying and Restricted Price List for further information.

"A" Cylinder Projection	Cylinder Length	Recommended Door Thickness (Lock Central)
41	37	50 to 60
52	48	60 to 84
64	60	84 to 108
80	76	108 to 132
88	84	132 to 156

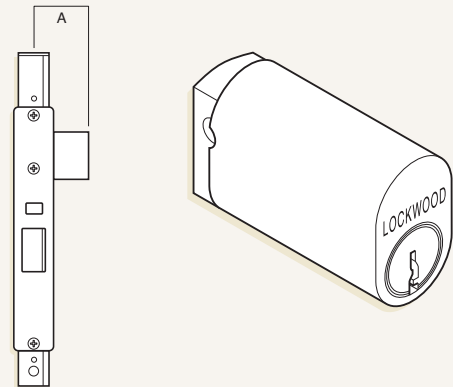

Visit us at: www.assaabloyasiapacific.com

ASSA ABLOY Sales Offices & Authorised Agents in Asia Pacific

Sales Offices - Australia

Victoria – Head Office

Corner of Edward Street & Huntingdale Road
Oakleigh VIC 3166

Telephone (03) 8574 3888
Facsimile (03) 8574 3788

Queensland South

450 Sherwood Road
Sherwood QLD 4075

Telephone (07) 3373 5200
Facsimile (07) 3373 5256

Queensland North

Ralph Buck Agencies
15 Mackley Street
Garbutt QLD 4814

Telephone (07) 4779 0177
Facsimile (07) 4775 1480

New South Wales – Commercial

Unit 1/16 Atkinson Road
Taren Point NSW 2229

Telephone (02) 8543 3700
Facsimile (02) 9531 7944

New South Wales – Residential

Unit 8/20-22 Foundry Road
Seven Hills NSW 2147

Telephone (02) 9624 2666
Facsimile (02) 9620 9340

New South Wales – Abloy

5/372 Eastern Valley Way
Chatswood NSW 2067

Telephone (02) 9882 6066

South Australia

182 Magill Road
Norwood SA 5067

Telephone (08) 8139 0403
Facsimile (08) 8364 1975

Western Australia

45 Gladstone Street
East Perth WA 6004

Telephone (08) 9227 9588
Facsimile (08) 9227 8913

Tasmania

23 Antill Street
South Hobart TAS 7000

Telephone (03) 6223 5404
Facsimile (03) 6224 0435

Sales Offices - New Zealand

Auckland – Residential

6 Armstrong Road
North Harbour Industrial Estate
Albany, Auckland, New Zealand

Telephone +64 (0)9 415 7111
Facsimile +64 (0)9 415 7222

Auckland – Sales Office

10 Haultain Street
Eden Terrace
Auckland, New Zealand

Telephone +64 (0)9 634 5590
Facsimile +64 (0)9 634 5589

Christchurch – Sales Office

112 Wordsworth Street
Sydenham
Christchurch, New Zealand

Telephone +64 (0)3 348 2294
Facsimile +64 (0)3 379 4819

Wellington

Display Centre, Level 3,
10 Hutt Road, Petone
Wellington, New Zealand

Telephone +64 (0)4 913 4214
Facsimile +64 (0)4 913 4213

Manufacturing Plants

Victoria

Corner of Edward Street & Huntingdale Road
Oakleigh VIC 3166

Telephone (03) 8574 3888
Facsimile (03) 8574 3788

Queensland

450 Sherwood Road
Sherwood QLD 4075

Telephone (07) 3373 5200
Facsimile (07) 3373 5256

New Zealand

6 Armstrong Road
North Harbour Industrial Estate
Albany, Auckland, New Zealand

Telephone +64 (0)9 415 7111
Facsimile +64 (0)9 415 7222

Security Merchants Australia

Unit 144/45 Gilby Road
Axxess Business Park
Mount Waverley, Victoria 3149

Telephone +61 (0)3 9558 8455
Facsimile +61 (0)3 9558 8466

Security Merchants New Zealand

8-10 Haultain Street
Eden Terrace

Auckland, New Zealand
Telephone +64 (0)9 355 9240
Facsimile +64 (0)9 307 1752

Export Department

Corner of Edward Street & Huntingdale Road
Oakleigh VIC 3166 Australia

Telephone +61 (0)3 8574 3888
Facsimile +61 (0)3 8574 3789

Asian Offices

ASSA ABLOY – Malaysia

ASSA ABLOY – Singapore

ASSA ABLOY – Thailand

ASSA ABLOY – Hong Kong

ASSA ABLOY – Shanghai

ASSA ABLOY – Beijing

ASSA ABLOY – Korea

ASSA ABLOY – India

Contact the Export Department,
Australia for details.

Worldwide Distributors

Contact the Export Department,
Australia for details.



ASSA ABLOY

Lockwood Warranty

ASSA ABLOY Australia Pty Limited ("ASSA ABLOY") warrants its Lockwood products against defects in workmanship and materials, subject to the limitations and exclusions set out in this Warranty. If, within the normal working life of a product, it is found to be defective, and none of the limitations and exclusions set out in this Warranty apply, ASSA ABLOY will supply the same or equivalent product free of charge. This is the only remedy granted by ASSA ABLOY under this Warranty.

Limitations

All electrical and electronic components used in ASSA ABLOY's Lockwood range of products (excluding batteries) are guaranteed for a period of 12 months from the date of proof of purchase, unless stated otherwise.

Exclusions

This Warranty does not cover:

- Damage to or malfunction or failure of the Lockwood product caused or contributed to by:
 - improper installation or failure to follow fitting instructions;
 - improper maintenance;
 - fair wear and tear;
 - any modification or repair which has not been authorized by ASSA ABLOY;
 - use of substitute or replacement parts or cylinders other than genuine ASSA ABLOY parts or cylinders; or
 - use of batteries other than those specified by ASSA ABLOY.

- The cost of:
 - removal and/or replacement of the Lockwood product;
 - freight and/or travelling time;
 - replacement batteries; or
 - any modification or repairs to a Lockwood product, unless authorised by ASSA ABLOY.
 - Damage to or deterioration of the plated finishes Florentine Bronze, Architectural Bronze, Polished Brass, Gold and Satin Brass, which are classified as soft finishes, and are subject to deterioration under some environmental conditions.
 - Personal injury, property damage or economic loss, however caused.
- Symmetry™ 5 Year Finish Warranty**
ASSA ABLOY Australia Pty Limited will replace five-year branded Symmetry product if within five years from the proven date of purchase it tarnishes, discolours or corrodes when properly installed and subject to no more than fair wear and tear.
- Symmetry™ Everbrass® Warranty**
Everbrass® product is coated both on the exterior and interior surfaces with a lifetime anti-tarnish finish. ASSA ABLOY Australia Pty Limited will replace Everbrass® branded product if it corrodes, tarnishes or discolours when properly installed and subject to no more than fair wear and tear.
- This Warranty is in addition to and not in substitution for any rights of the purchaser under the Trade Practices Act and state or territory legislation.