

THERMELL

REFRIGERATION & WARMER SHOWCASE





Thermell Refrigeration was founded in 2010 by Mark Thurman and Chris Elliott. The two shared a common vision to build a company that would provide innovative merchandising solutions to the supermarket industry. Their vision was to create refrigerated and frozen food merchandising solutions that would drive incremental sales volume on refrigerated and frozen food brands.

Within four years, sales volume has quadrupled and the company moved to a larger facility to accommodate this growth. Thermell also expanded its product offering to include tortilla warmer cases to merchandise hot fresh tortillas and a refrigerated beverage merchandiser to promote bottled water, energy drinks and carbonated beverages.

*“Fresh” is not a goal,
It’s our commitment*

In 2014, Thermell Refrigeration entered into a joint venture with The Marco Company, which is also a Fort Worth based family-owned company. This partnership has dramatically increased resources for both entities - Thermell has the resources to bring new products to the supermarket industry and Marco has expanded its product mix to include refrigerated display cases.

Made in the USA

Made in the USA is something to be proud of! With over 40 years of combined experience, Thermell's team of engineers, and certified refrigeration technicians ensure that our customers receive the highest quality product everytime. Each unit is designed for ease of use, with a “Plug & Play” set up. Engineering expertise, high-quality components and unrivaled craftsmanship are the foundation of every fixture that is built.

THERMELL REFRIGERATION



THERMELL MANUFACTURING FACILITY

MISSION STATEMENT

Through teamwork, leadership and service, we create value for our customers by manufacturing the finest and most innovative display products.

REFRIGERATED ORCHARD BIN

Refrigerated Orchard Bin	04-08
Refrigerated Orchard Bin Overview	09-13

COLD WALL MERCHANDISER

Cold Wall Merchandiser	14-16
Cold Wall Merchandisers Overview	17

WARMING MERCHANDISER

Warming Merchandiser	18
Warming Merchandiser Overview	19

SPECIALTY MERCHANDISER

Specialty Merchandiser	20
Specialty Merchandisers Overview	21
Standard Materials and Finishes	22
Warranty	23



REFRIGERATED ORCHARD BIN



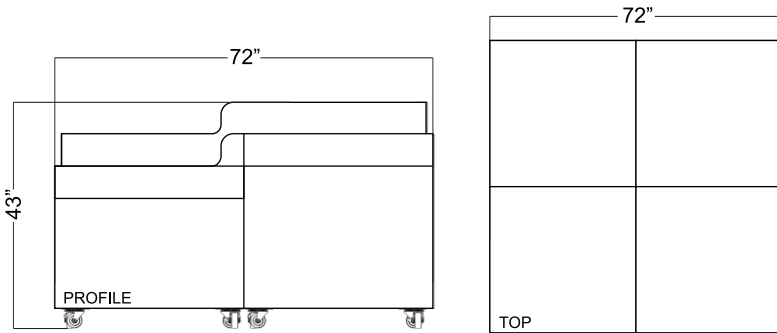



TM ROB 6X6 SPLIT

DWG# 35393 DIM: 72" X 72" X 43"

- Self contained & choice of color
- Multi-tiered merchandiser
 - Extends shelf life
- Auto defrost & HD casters

DIMENSIONS & SPECS

Dimensions	Capacity	Holding Temp	BTU/hr @ 90°F	Refrigerant
72" X 72" X 43"	24 CFT	38 - 50°F	6161	R448a
Volts	Amps	Fuse Size	Warranty	 
230	12	20	1 YEAR	

THERMELL: REFRIGERATED ORCHARD BIN



TM ROB 6X3-SPLIT
DWG# 34943 DIM: 72 1/2" X 37 3/4" X 43 3/8"
 • 115V | 15 A | 12 CFT
 • Plug & Play, locking casters, auto-defrost



TM ROB 9X3 SPLIT
DWG# 41977 DIM: 107" X 37 3/4" X 43 3/8"
 • 230V | 21 A | 11 CFT
 • Plug & Play, locking casters, auto-defrost



TM ROB 35993 6X6 SPLIT 2
DWG# 35993 DIM: 72 1/2" X 72 1/2" X 43 3/8"
 • 230V | 14 A | 24 CFT
 • Plug & Play, locking casters, auto-defrost



TM ROB 3X6X6 CORNER
DWG# 36627 DIM: 72 3/16" X 72 3/16" X 46 9/16"
 • 230V | 21 A | 11 CFT
 • Plug & Play, locking casters, auto-defrost



TM ROB 2X3-SLT
DWG# 39110 DIM: 29" X 36" X 36"
 • 120V | 10 A | 3.5 CFT
 • Plug & Play, auto-defrost



TM ROB 3X3-SLT PLY
DWG# 40540 DIM: 36" X 36" X 50 7/8"
 • 120V | 15 A | 2.6 CFT
 • Plug & Play, locking casters, auto-defrost
 • Optional shelves & risers



TM ROB 4X3-SLT
DWG# 35845 DIM: 53 7/8" X 35 9/16" X 50 13/16"
 • 115V | 20 A | 6.5 CFT
 • Plug & Play, locking casters, auto-defrost
 • Optional shelves & risers



TM ROB 4X4-SLT
DWG# 35973 DIM: 53 7/8" X 48 5/8" X 50 7/8"
 • 115V | 4.17 A | 19.1 CFT
 • Plug & Play, locking casters, auto-defrost
 • Optional shelves & risers



TM ROB 6X3 EURO SLT
DWG# 41208 DIM: 78" X 36 1/2" X 60 7/8"
 • 230V | 4.8 A | 21 CFT
 • Plug & Play, locking casters, auto-defrost
 • Optional shelves & risers

THERMELL: REFRIGERATED ORCHARD BIN



TM ROB 4X6LB-SLT 34998
DWG# 34998 DIM: 77 7/8" X 38 1/2" X 41 7/8"

- 230V | 4.8 A | 18 CFT
- Plug & Play, locking casters, auto-defrost
- Optional shelves & risers



TM ROB 6X4-SLT
DWG# 34924 DIM: 77 7/8" X 48 9/16" X 50 13/16"

- 230V | 12 A | 14.3 CFT
- Plug & Play, locking casters, auto-defrost
- Optional shelves & risers



TM ROB 8X4-SLT
DWG# 38821 DIM: 101 7/8" X 48 9/16" X 50 13/16"

- 230V | 14 A | 19 CFT
- Plug & Play, locking casters, auto-defrost
- Optional shelves & risers



TM ROB 8X4-SLT 40898
DWG# 40898 DIM: 101 7/8" X 48 5/8" X 42 1/16"

- 230V | 4.8 A | 22 CFT
- Plug & Play, locking casters, auto-defrost
- Optional shelves & risers

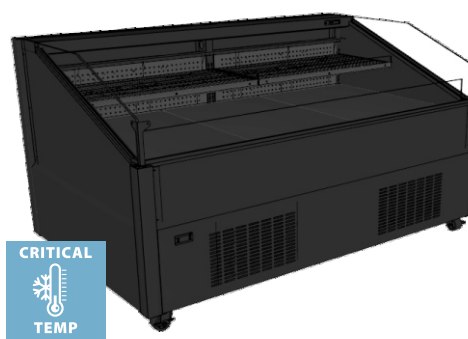

ROB-36483 LGY
DWG# 36483 DIM: 76 7/8" X 48 5/32" X 42 1/8"

- 230V | 12 A | 12.3 CFT
- Plug & Play, locking casters, auto-defrost
- Optional shelves & risers

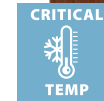

TM ROB 6X4-SLP 39079
DWG# 39079 DIM: 74 1/16" X 48 3/8" X 49 1/2"

- 230V | 12 A | 16.1 CFT
- Plug & Play, locking casters, auto-defrost
- Optional shelves & risers



TM ROB 3X3
DWG# 38669 DIM: 36 1/4" X 36 1/4" X 42"

- 115V | 13 A | 3.7 CFT
- Plug & Play, locking casters, auto-defrost



TM ROB 3X3-FLT 41207
DWG# 41207 DIM: 36 1/4" X 36 1/4" X 37"

- 115V | 4.17 A | 2.8 CFT
- Plug & Play, locking casters, auto-defrost
- Optional shelves & risers



TM ROB 4X4
DWG# 38668 DIM: 48 1/4" X 48 1/4" X 43"

- 115V | 15 A | 6.9 CFT
- Plug & Play, locking casters, auto-defrost

THERMELL: REFRIGERATED ORCHARD BIN



TM ROB 6X3-FLT

DWG# 37986 DIM: 72 9/16" X 37 3/4" X 36"

- 230V | 12 A | 8.3 CFT
- Plug & Play, locking casters, auto-defrost



TM ROB 7X4 HEX B

DWG# 41304 DIM: 84" X 39 1/4" X 51"

- 230V | 4.8 A | 10 CFT
- Plug & Play, locking casters, auto-defrost
- Optional shelves & risers



TM ROB 6X4 HEX

DWG# 40490 DIM: 75" X 44 1/8" X 35 1/2"

- 230V | 4.8 A | 9 CFT
- Plug & Play, locking casters, auto-defrost
- Optional shelves & risers



TM ROB 6X4 HEX B

DWG# 40997 DIM: 75" X 43 1/2" X 51"

- 230V | 4.8 A | 9 CFT
- Plug & Play, locking casters, auto-defrost
- Optional shelves & risers



TM ROB 8X4 HEX B

DWG# 41050 DIM: 97" X 39 1/2" X 51"

- 230V | 4.8 A | 11.1 CFT
- Plug & Play, locking casters, auto-defrost
- Optional shelves & risers

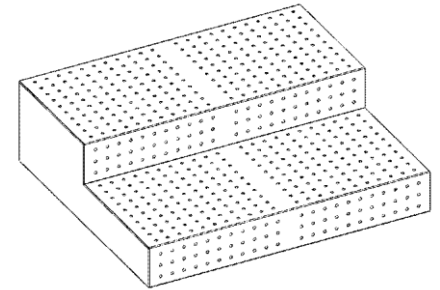

MTLRSR-40044

DWG# 40044 DIM: 24" X 21" X 7"

- 20 G galvanized steel
- Fits any Thermell ROB
- Perforated w/ two steps

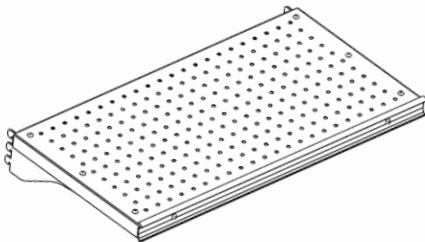

ROB-SHF 01 GAL

DWG# 29318 DIM: 23 3/8" X 12" X 3 3/4"

- 20 G galvanized steel
- Fits any Thermell ROB w/ 2' wide standards
- Perforated w/ product stop

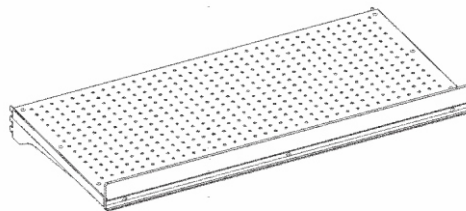

ROBC-34997 SHLF

DWG# 34997 DIM: 35 1/16" X 17" X 3 3/16"

- 20 G galvanized steel
- Fits any Thermell ROB w/ 3' wide standards
- Perforated w/ product stop





SPLIT & SLANT TOP

 TM ROB 6X6 SPLIT	Holding Temps 38 - 50°F	Dims 72" X 72" X 43"	Capacity 24 CFT	Volts/Amps 230 V 12 A	Fuse Size 20	BTU/hr @90°F 6,161
 TM ROB 6X3-SPLIT	Holding Temps 38 - 50°F	Dims 72 1/2" X 37 3/4" X 43 3/8"	Capacity 12 CFT	Volts/Amps 115 V 15 A	Fuse Size 20	BTU/hr @90°F 4,925
 TM ROB 9X3 SPLIT	Holding Temps 35 - 41°F Critical Temp	Dims 107" X 37 3/4" X 43 3/8"	Capacity 24 CFT	Volts/Amps 230 V 14 A	Fuse Size 20	BTU/hr @90°F 7,914
 TM ROB 3X3X6 CORNER	Holding Temps 38 - 50°F	Dims 72 3/8" X 72 3/8" X 46 3/8"	Capacity 11 CFT	Volts/Amps 230 V 21 A	Fuse Size 30	BTU/hr @90°F 7,914
 TM ROB 6X6 SPLIT 2	Holding Temps 35 - 41°F Critical Temp	Dims 72 1/2" X 72 1/2" X 43 3/8"	Capacity 24 CFT	Volts/Amps 230 V 14 A	Fuse Size 20	BTU/hr @90°F 7,914
 TM ROB 2X3-SLT	Holding Temps 35 - 41°F Critical Temp	Dims 29" X 36" X 36"	Capacity 3.5 CFT	Volts/Amps 120 V 10 A	Fuse Size 20	BTU/hr @90°F 3,613
 TM ROB 3X3-SLT PLY	Holding Temps 35 - 41°F Critical Temp	Dims 36" X 36" X 50 7/8"	Capacity 2.6 CFT	Volts/Amps 120 V 15 A	Fuse Size 20	BTU/hr @90°F 4,925

THERMELL: REFRIGERATED ORCHARD BIN OVERVIEW

SLANT TOP

	Holding Temps	Dims	Capacity	Volts/Amps	Fuse Size	BTU/hr @90°F
TM ROB 4X3-SLT	35 - 41°F Critical Temp	53 7/8" X 35 5/8" X 50 13/16"	6.5 CFT	115 V 20 A	20	4,925
	Holding Temps	Dims	Capacity	Volts/Amps	Fuse Size	BTU/hr @90°F
TM ROB 4X4-SLT	35 - 41°F Critical Temp	53 7/8" X 48 5/8" X 50 7/8"	19.1 CFT	115 V 4.17A	20	4,925
	Holding Temps	Dims	Capacity	Volts/Amps	Fuse Size	BTU/hr @90°F
TM ROB 6X3 EURO SLT	35 - 41°F Critical Temp	78" X 36 1/2" X 60 7/8"	21 CFT	230 V 4.8 A	20	6,161
	Holding Temps	Dims	Capacity	Volts/Amps	Fuse Size	BTU/hr @90°F
TM ROB 4X6LB-SLT 34998	35 - 41°F Critical Temp	77 7/8" X 38 1/2" X 41 7/8"	18 CFT	230 V 4.8 A	20	7,914
	Holding Temps	Dims	Capacity	Volts/Amps	Fuse Size	BTU/hr @90°F
TM ROB 6X4-SLT	35 - 41°F Critical Temp	77 7/8" X 48 5/8" X 50 13/16"	14.3 CFT	230 V 12 A	20	6,161
	Holding Temps	Dims	Capacity	Volts/Amps	Fuse Size	BTU/hr @90°F
TM ROB 8X4-SLT	35 - 41°F Critical Temp	101 7/8" X 48 5/8" X 50 13/16"	19 CFT	230 V 14 A	20	7,914
	Holding Temps	Dims	Capacity	Volts/Amps	Fuse Size	BTU/hr @90°F
TM ROB 8X4-SLT 40898	35 - 41°F Critical Temp	101 7/8" X 48 5/8" X 42 1/4"	22 CFT	230 V 4.8 A	20	7,914



SLANT TOP & SLOPE FRONT

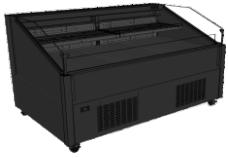

ROB-36483 LGY

Holding Temps

35 - 41°F
Critical Temp

Dims

76 7/8" X 48 5/32" X 42 1/8"

Capacity

12.3 CFT

Volts/Amps

230 V | 12 A

Fuse Size

20

BTU/hr @90°F

6,161



TM ROB 6X4-SLP 39079

Holding Temps

35 - 41°F
Critical Temp

Dims

74 1/16" X 48 3/8" X 49 1/2"

Capacity

16.1

Volts/Amps

230 V | 12 A

Fuse Size

20

BTU/hr @90°F

6,161

FLAT TOP



TM ROB 3X3

Holding Temps

35 - 41°F
Critical Temp

Dims

36 1/4" X 36 1/4" X 42"

Capacity

3.7 CFT

Volts/Amps

115 V | 13 A

Fuse Size

15

BTU/hr @90°F

2,433



TM ROB 3X3-FLT 41207

Holding Temps

35 - 41°F
Critical Temp

Dims

36 1/4" X 36 1/4" X 37"

Capacity

2.8 CFT

Volts/Amps

115 V | 4.17 A

Fuse Size

15

BTU/hr @90°F

2,433



TM ROB 4X4

Holding Temps

35 - 41°F
Critical Temp

Dims

48 1/4" X 48 1/4" X 43"

Capacity

6.9 CFT

Volts/Amps

115 V | 15 A

Fuse Size

20

BTU/hr @90°F

4,626



TM ROB 6X3-FLT

Holding Temps

35 - 41°F
Critical Temp

Dims

72 9/16" X 37 3/4" X 36"

Capacity

8.3 CFT

Volts/Amps

230 V | 5.94 A

Fuse Size

20

BTU/hr @90°F

6,161

THERMELL: REFRIGERATED ORCHARD BIN OVERVIEW

HEX



TM ROB 6X4 HEX

Holding Temps

38 - 50°F
Critical Temp

Dims

75" X 44 1/8" X 35 1/2"

Capacity

9 CFT

Volts/Amps

230 V | 4.8 A

Fuse Size

20

BTU/hr @90°F

6,161



TM ROB 6X4 HEX B

Holding Temps

38 - 50°F
Critical Temp

Dims

75" X 44 1/8" X 35 1/2"

Capacity

9 CFT

Volts/Amps

230 V | 4.8 A

Fuse Size

20

BTU/hr @90°F

6,161



TM ROB 7X4 HEX B

Holding Temps

38 - 50°F
Critical Temp

Dims

84" X 39 1/4" X 51"

Capacity

10 CFT

Volts/Amps

230 V | 4.8 A

Fuse Size

20

BTU/hr @90°F

6,161



TM ROB 8X4 HEX B

Holding Temps

38 - 50°F
Critical Temp

Dims

97" X 39 1/2" X 51"

Capacity

11.1 CFT

Volts/Amps

230 V | 4.8 A

Fuse Size

20

BTU/hr @90°F

7,914



COLD WALL MERCHANDISER



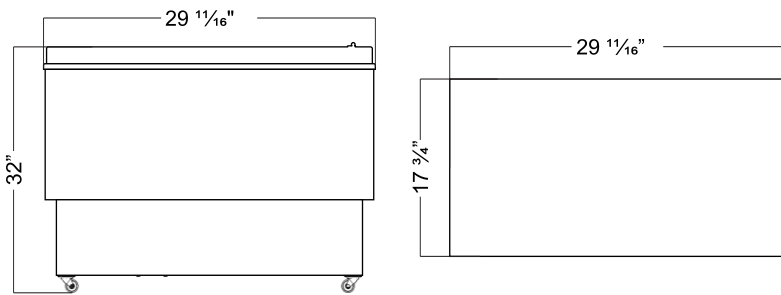

TM DUAL S2

DWG# 36663 DIM: 29 1/2" X 17 3/4" X 32"

- Plug & Play, custom graphics
- Extends shelf life
- Dual temp & HD casters

DIMENSIONS & SPECS

Dimensions	Capacity	Holding Temp	BTU/hr @ 90°F	Refrigerant
29 1/2" X 17 3/4" X 32"	2.8 CFT	-10 - 40°F	890	R290a
Volts	Amps	Ph	Fuse Size	Warranty
115	2.5	1	15	1 YEAR



TM FREEZE 100

DWG# 38202

DIM: 42 9/16" X 30 9/16" X 38 15/16"

- 115V | 4.5 A | 11.4 CFT
- Plug & Play, dual temp, swivel casters
- Custom graphics
- Lids sold separately: Item# 117-169



TM DUAL 30

TM# 100-8 DIM: 32" X 20" X 32"

- 115V | 2.5 A | 3.5 CFT
- Plug & Play, dual temp, custom graphics



TM DUAL 60

DWG# 26215 DIM: 33 3/4" X 25 1/8" X 32 1/8"

- 115V | 3.7 A | 5 CFT
- Plug & Play, dual temp, custom graphics
- Lid sold separately: Item# 117-173



TM DUAL 70

DWG# 34053 DIM: 35 1/16" X 27" X 36"

- 115V | 3.7 A | 7.6 CFT
- Plug & Play, dual temp, custom graphics
- Lid sold separately: Item# 117-297



TM DUAL 80

DWG# 36661 DIM: 48 5/8" X 25 1/2" X 36"

- 115V | 4.5 A | 11.4 CFT
- Plug & Play, dual temp, custom graphics
- Lid sold separately: Item# 117-171



TM DUAL 100

DWG# 36662 DIM: 42 1/2" X 30 1/2" X 36"

- 115V | 4.5 A | 11.4 CFT
- Plug & Play, dual temp, custom graphics
- Lid sold separately: Item# 117-169



COLD WALL MERCHANDISER



TM DUAL S2

Holding Temps

-10 - 40°F

Dims

29 1/2" X 17 3/4" X 32"

Capacity

2.8 CFT

Volts/Amps

115 V | 2.5 A

Fuse Size

15

BTU/hr @90°F

890



TM FREEZ 100

Holding Temps

-10 - 0°F

Dims

42 5/8" X 30 5/8" X 38 5/8"

Capacity

11.4 CFT

Volts/Amps

115 V | 4.5 A

Fuse Size

20

BTU/hr @90°F

1,318



TM DUAL 30

Holding Temps

-10 - 40°F

Dims

32" X 20" X 32"

Capacity

3.5 CFT

Volts/Amps

115 V | 2.5 A

Fuse Size

15

BTU/hr @90°F

890



TM DUAL 60

Holding Temps

-10 - 40°F

Dims

33 3/4" X 25 1/8" X 32 1/8"

Capacity

5 CFT

Volts/Amps

115 V | 3.7 A

Fuse Size

20

BTU/hr @90°F

1,037



TM DUAL 70

Holding Temps

-10 - 40°F

Dims

35 1/2" X 27" X 36"

Capacity

7.6 CFT

Volts/Amps

115 V | 3.7 A

Fuse Size

20

BTU/hr @90°F

1,037



TM DUAL 80

Holding Temps

-10 - 40°F

Dims

48 5/8" X 25 1/2" X 36"

Capacity

11.4 CFT

Volts/Amps

115 V | 4.5 A

Fuse Size

20

BTU/hr @90°F

1,318



TM DUAL 100

Holding Temps

-10 - 40°F

Dims

42 1/2" X 30 1/2" X 36"

Capacity

11.4 CFT

Volts/Amps

115 V | 4.5 A

Fuse Size

20

BTU/hr @90°F

1,318



TM TT H80

TM# 100-4

DIM: 49" X 26" X 18"

- 120V | 4.8 A | 5.9 CFT
- Plug & Play, insulated, custom graphics
- Optional display table: DWG# 25608



TM WARM S2

TM# 100-1 DIM: 29" X 17" X 33"

- 120V | 3.7 A | 2.8 CFT
- Plug & Play, insulated, controlled temp
- Swivel casters, custom graphics

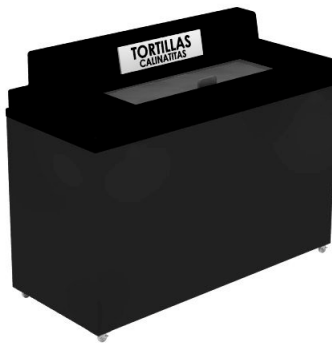

TM WARM S3

TM# 100-2 DIM: 41" X 17" X 33"

- 120V | 4.8 A | 4.2 CFT
- Plug & Play, insulated, controlled temp
- Swivel casters, custom graphics



BAK-1375 OBV 169

DWG# 33305 DIM: 36" X 36" X 39 3/4"

- 120V | 5.4 A | 5 CFT
- Plug & Play, insulated, controlled temp
- Swivel casters, custom graphics



WARMING MERCHANDISER



TM TT H80

Holding Temps

90 - 125°F

Dims

49" X 26" X 18"

Capacity

5.9 CFT

Volts/Amps

120 V | 4.8 A

Fuse Size

15



TM WARM S2

Holding Temps

90 - 125°F

Dims

29 1/2" X 17 3/4" X 32"

Capacity

2.8 CFT

Volts/Amps

120 V | 3.7 A

Fuse Size

15



TM WARM S3

Holding Temps

90 - 125°F

Dims

41" X 17" X 33"

Capacity

4.2 CFT

Volts/Amps

120 V | 4.8 A

Fuse Size

15



BAK-1375

Holding Temps

90 - 125°F

Dims

36" X 36" X 39 3/4"

Capacity

5 CFT

Volts/Amps

120 V | 5.4 A

Fuse Size

15



INSPIRATION 2LV

TM# 200-3V

DIM: 36" X 29 7/8" X 66"

- 208V | 5 A | 11.4 CFT
- Self contained, auto defrost, energy efficient
- Optional shelves & risers DWG# 22210



TM ROB 2X2X42 SS

DWG# 38817 DIM: 26 1/8" X 22 13/16" X 43 11/16"

- 120V | 4.17 A | 1.9 CFT
- Plug & Play, insulated, swivel casters



TM DUAL 100 SMD

DWG# 33297 DIM: 51" X 33 1/4" X 78"

- 120V | 20 A | 11.4 CFT
- Self contained, auto defrost, energy efficient
- Optional shelves & risers DWG #22210



TM DUAL 70

DWG# 35970 DIM: 50" X 20 3/8" X 76"

- 120V | 2.5 A | 2.8 CFT
- Plug & Play, insulated, swivel casters
- Custom graphics, adjustable shelving



4' TM UPRIGHT DISPLAY CASE

TM# 200-4V DIM: 50 1/4" X 38 1/2" X 83"

- 208V | 4.9 A | 30.59 CFT
- Self-evaporative, no drains or pipework
- Choice of end panels & doors available



6' TM UPRIGHT DISPLAY CASE

TM# 200-6V DIM: 74 1/4" X 38 1/2" X 83"

- 208V | 8.8 A | 51.60 CFT
- Self-evaporative, no drains or pipework
- Choice of end panels & doors available



8' TM UPRIGHT DISPLAY CASE

TM# 200-8V DIM: 98 1/4" X 38 1/2" X 83"

- 208V | 8.8 A | 69.29 CFT
- Self-evaporative, no drains or pipework
- Choice of end panels & doors available



SPECIALTY MERCHANDISER

 TM DUAL 100 SMD	Holding Temps	Dims	Capacity	Volts/Amps	Fuse Size	BTU/hr @90°F
	0 - 38°F	51" X 33 ¼" X 78"	11.4 CFT	120 V 20 A	20	1,037
 TM ROB 2X2X42 SS	Holding Temps	Dims	Capacity	Volts/Amps	Fuse Size	BTU/hr @90°F
	35 - 41°F Critical Temp	20 ½" X 22 ⅜" X 43 ⅛"	1.9 CFT	120 V 4.17 A	15	890
 HDS-35970	Holding Temps	Dims	Capacity	Volts/Amps	Fuse Size	BTU/hr @90°F
	0 - 38°F	50" X 20 ¾" X 76"	2.8 CFT	120 V 2.5 A	20	1,037
 INSPIRATION 2LV	Holding Temps	Dims	Capacity	Volts/Amps	Fuse Size	BTU/hr @90°F
	35 - 41°F	36" X 29 ⅞" X 66"	11.4 CFT	208 V 5 A	10	6,676
 4' TM UPRIGHT DISPLAY CASE	Holding Temps	Dims	Capacity	Volts/Amps	Fuse Size	BTU/hr @90°F
	35 - 41°F	50 ¼" X 38 ½" X 83"	30.59 CFT	208 V 4.9 A	10	8,345
 6' TM UPRIGHT DISPLAY CASE	Holding Temps	Dims	Capacity	Volts/Amps	Fuse Size	BTU/hr @90°F
	35 - 41°F	74 ¼" X 38 ½" X 83"	51.60 CFT	208 V 6.4 A	10	12,092
 8' TM UPRIGHT DISPLAY CASE	Holding Temps	Dims	Capacity	Volts/Amps	Fuse Size	BTU/hr @90°F
	35 - 41°F	98 ¼" X 38 ½" X 83"	69.29 CFT	208 V 8.8 A	15	16,872

MATERIALS



LACQUER STAINS

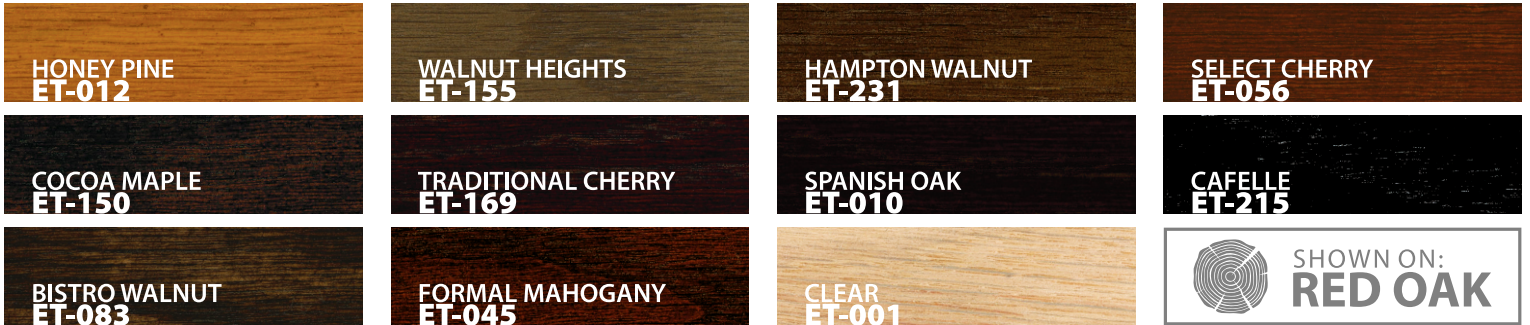

POWDERCOAT



FINISHES

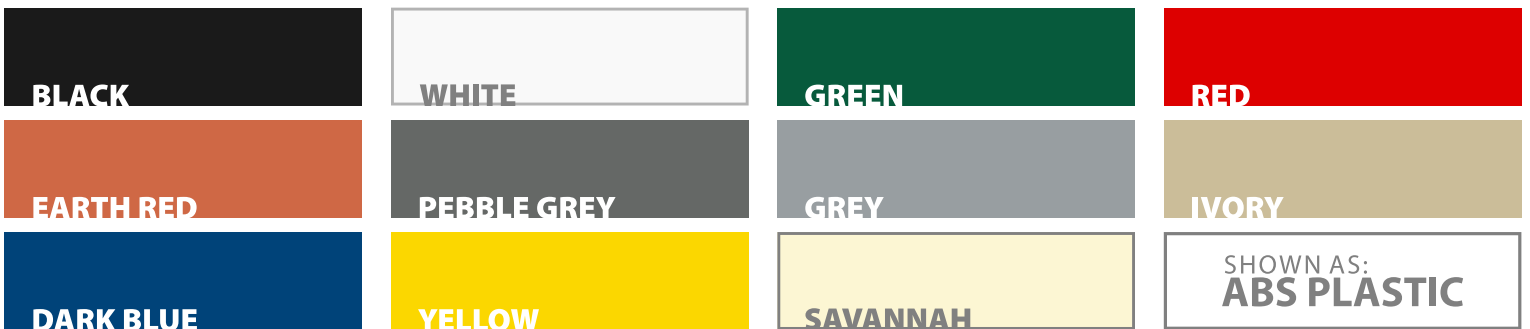

For a full list of finishes, please consult with your area sales representative.



Thermell warrants to the original purchaser the new equipment and all original parts to be free from defects in material and workmanship under normal use and service for a period of 12 months from date of Proper installation and start-up. Warranty does not cover claims caused by freight carrier damage, improper installation, or lack of basic preventative maintenance. In the first 30 days of the warranty period, a replacement may, be provided at no charge to the purchaser. If a unit is provided, the defective unit must be returned to Thermell. If the replacement unit is not returned to Thermell within 30 days the customer assumes responsibility and will be charged for the unit. The replacement unit will assume the unused portion of the warranty remaining. After the initial 30 days, the defective unit will be picked up, repaired, and returned. **If no mechanical failure is found, a service charge of \$250.00, plus materials and freight charges will be billed back to the purchaser.**

THIS WILL BE AT THE DISCRETION OF THERMELL MANUFACTURING AND ONLY APPLIES TO COLD WALL AND WARMER UNITS. THIS DOES NOT APPLY TO ROBO OR OUR UPRIGHT DISPLAY CASES.

This warranty shall not apply to loss of food or contents of the products due to failure for any reason.

This warranty does not cover:

1. Damage to or failure of parts or systems resulting from unauthorized modifications made to this product.
2. For any repair or replacements made without written consent of Thermell, or when the product is installed or operated in a manner contrary to the printed instructions covering installation and service which accompanied such product.
3. For any damages, delays, or losses, direct, consequential, incidental or otherwise, which may arise in connection with such product or part thereof; including loss of profit, additional labor cost, or injury to personnel or property caused by defective material or parts.
4. Expendable items that can wear out from normal use.
5. Damage to or failure of this product if it is not installed, operated or maintained according to all instructions supplied with the product.
6. Damage or failure of this product when the product is operated on low or improper voltages.
7. Damage to or failure of this product resulting from negligence, accident, abuse, misuse or use for other than its intended purpose, or when the serial number of the product has been removed, defaced, or altered.
8. A service technician to instruct the user in correct product installation, operation or maintenance.
9. A service technician to clean or maintain this product.
10. Damage to or failure of this product caused by the use of detergents, cleaners, chemicals, or utensils other than those recommended in the instructions supplied with the product.

After the 12 month warranty period has expired, Thermell will still repair units. There will be a charge for labor, materials, and freight.

For further information about this warranty. Contact Thermell Manufacturing at 1-833-847-6355
8800 S. Freeway FT. Worth TX, 76140 • www.thermell.com

THE MARCO FAMILY



THE MARCO COMPANY
marcocompany.com



REMIS AMERICA
remisamerica.com



THERMELL REFRIGERATION
thermell.com



INFINITI DECOR
infitidecor.com



@THEMARCOCOMPANY