



WINDSOR
WINDOWS & DOORS

Windsor Windows & Doors Product Overview

PRODUCT GUIDE





PINNACLE CASEMENT AND LOW PROFILE DIRECT SET WINDOWS, AND SWINGING PATIO DOORS. Montgomery County, Maryland.

Windsor Provides a Solution for Every Project

Windsor Windows & Doors can help bring your vision to life. Our windows and doors open up a home to the light, air and beauty of the outside world. But it's the inspired designs and lasting performance of Windsor products that open up a world of possibilities for architects and builders.

Windsor has been developing unique home construction solutions for more than 70 years, from EZ Tilt to the first all-cellular PVC exterior window. We're dedicated to bringing you the highest quality products on the market, all for the best value.

Choose from a wide selection of products for new construction, remodeling or light commercial applications. Windsor's windows and doors allow you to get creative with your next project, without sacrificing quality or stretching your budget.

Your Vision. Our Passion.

ON THE COVER // TOP PHOTO: PINNACLE DIRECT SET, CASEMENT AND AWNING WINDOWS AND PATIO DOORS. Little Rock, Arkansas. LEFT: NEXT DIMENSION CLASSIC DOUBLE HUNG AND DIRECT SET WINDOWS. Traverse City, Michigan. CENTER: LEGEND DIRECT SET WINDOWS WITH SEG TOP TRANSOMS AND CASEMENT WINDOWS. Brentwood, Tennessee. RIGHT: PINNACLE CASEMENT WINDOWS AND SWINGING DOORS. Bloomfield Hills, Michigan.

The History of Windsor Windows & Doors.....	4
The Windsor Advantage.....	5
Windsor Product Overview	6
Windsor’s Glazing System	9
Pinnacle & Pinnacle Select Product Overview	10
– Pinnacle Select Casement & Awning	12
– Pinnacle Select French Push-out Casement.....	13
– Pinnacle Select Triple Insulated Glass Glazing Option.....	14
– Pinnacle Select In-swing and Out-swing Patio Doors	16
– Pinnacle Select Bi-fold Patio Doors	17
– Pinnacle Select Multi-slide Patio Doors.....	18
– Pinnacle Casement & Awning.....	19
– Pinnacle Casement & Awning with 3-1/4" Frame	20
– Pinnacle Double Hung with Concealed Jambliner.....	21
– Pinnacle Double Hung & Glide-by	22
– Pinnacle Direct Set & Radius.....	23
– Pinnacle Clad 3-1/4" Frame Direct Set & Radius.....	24
– Clad 90 Degree Corner Window	25
– Pinnacle Swinging Patio Door.....	26
– Pinnacle Sliding Patio Door	27
– Pinnacle Bi-fold Patio Door.....	28
– Pinnacle Multi-slide Patio Door.....	29
– Pinnacle High-Performance PG Rated Products	30
– Pinnacle Select Impact Casement & Awning	31
– Pinnacle Clad Impact Casement & Awning.....	32
– Pinnacle Clad Impact Double Hung.....	33
– Pinnacle Clad Impact Direct Set & Radius	34
– Pinnacle Impact featuring Sea-Storm® Glass.....	35
– Pinnacle Clad French Impact Swinging Patio Door.....	36
– Pinnacle Clad French Impact Sliding Patio Door.....	37
– Pinnacle Options & Accessories	38
Legend & Legend HBR Product Overview	50
– Legend.....	52
– Legend HBR	53
– Legend Options & Accessories	54
Next Dimension Product Overview	64
– Next Dimension Signature Casement & Awning	66
– Next Dimension Signature Direct Set & Radius.....	67
– Next Dimension Classic Double Hung & Single Hung	68
– Next Dimension Classic Sliding Window.....	69
– Next Dimension Classic Direct Set & Radius	70
– Next Dimension Pro Single Hung	71
– Next Dimension Pro Slider.....	72
– Next Dimension Pro Direct Set & Radius	73
– Next Dimension Sliding Patio Door.....	74
– Our Quality is in the Details.....	75
– Next Dimension Options & Accessories.....	76
Revive Replacement Windows Product Overview	82
– Revive Wood Clad Double Hung Pocket Replacement Window	84
– Revive Hybrid Double Hung Pocket Replacement Window	85
– Revive Vinyl Double Hung Pocket Replacement Window	86
– Revive Vinyl Single Hung Pocket Replacement Window	87
– Revive Wood Clad Casement & Awning Pocket Replacement Window.....	88
– Revive Hybrid Casement & Awning Pocket Replacement Window	89
– Revive Vinyl Casement Pocket Replacement Window.....	90
– Revive Sash Replacement Kits	91
– Revive Options & Accessories	92
Windsor Website & PowerTools Overview	Inside Back Cover

The History of Windsor Windows & Doors

Windsor Windows & Doors began as a small operation in Des Moines, Iowa, in 1946. By crafting some of the finest windows and doors available – and asking fair prices – we’ve built our reputation of quality and value among architects, builders, contractors and homeowners. Windsor remained a regional wood window company until being purchased by Woodgrain Millwork, Inc., Fruitland, Idaho, in 1987.

Woodgrain began as Dame Lumber & Moulding in 1954 by founder Bud Dame, who pioneered the manufacturing of wood mouldings. In 1984, Dame Lumber & Mouldings merged with a subsidiary to form Woodgrain Mouldings. In 1988, the name was officially changed to Woodgrain Millwork. Bud’s two sons, Reed and Kelly Dame, are currently the owners of Woodgrain Millwork.

Windsor is proud to be owned by such a large and successful company. Woodgrain has grown into the largest manufacturer of mouldings and interior doors in the United States. Four separate divisions are now part of the Woodgrain family; Millwork, Distribution, Doors and Windows. Woodgrain Millwork currently employs over 3,000 people in 20 different locations, including two in Chile.

We’ve come a long way since we built our first window in 1946. Since joining Woodgrain, Windsor has streamlined its manufacturing processes, invested in state-of-the-art equipment, engineered innovative new designs and expanded the product offering. Windsor’s corporate headquarters is located in West Des Moines, Iowa. The manufacturing plant in that location occupies 340,000 square feet. We also operate a 200,000-square-foot production facility in Monroe, North Carolina as well as a 167,000-square-foot facility in Norwalk, Iowa. We manufacture four distinct product lines: Pinnacle (wood

clad windows and patio doors), Legend (cellular PVC windows), Next Dimension (vinyl windows and patio doors) and Revive™ (wood clad, hybrid and vinyl pocket replacement windows). Windsor enjoys a national presence in the window and patio door marketplace. We ship quality products throughout the United States and to Canada, Mexico and China.

Woodgrain Millwork, Inc., and Windsor Windows & Doors have succeeded as a result of traditional American values. The diligence and hard work of the owners, as well as every employee they have hired throughout the years, has allowed the company to grow into a viable competitor in the

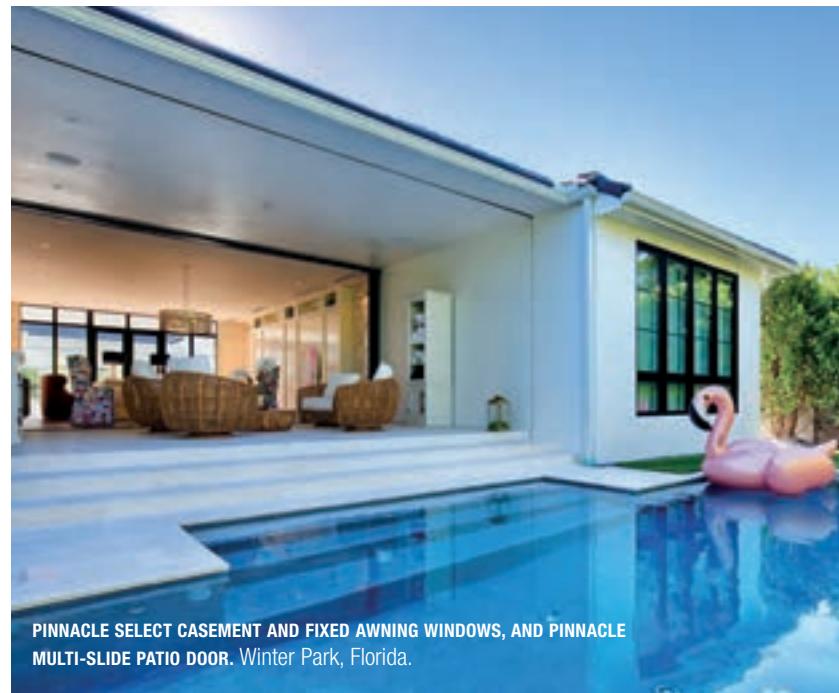

residential and light commercial building market. We strive every day to meet our customers’ needs and exceed their expectations. Our goal is to provide the best value in the window and door industry.



The Windsor Advantage

At Windsor Windows & Doors, we're committed to providing the finest products, engineered to meet the needs of all your projects. We'd like you to experience the Windsor Advantage...a complete set of impactful solutions delivering outstanding service, selection, quality and value.

Whether you're looking for the beauty of wood in our Pinnacle products, the longevity of our Legend cellular PVC, the efficiency of our Next Dimension vinyl or the easy installation of our Revive pocket replacement windows, rest assured Windsor takes pride in producing meticulously crafted windows and doors for each specific order.

We use the highest quality materials, resulting in products that are durable, reliable and weather resistant. Our goal is to exceed your expectations by providing short order lead times, reliable delivery dates and the flexibility to respond to your custom requests.



PINNACLE CASEMENT, AWNING, DIRECT SET AND PICTURE WINDOWS, WITH SWINGING AND SLIDING PATIO DOORS. Cleveland, Ohio.

The Windsor Advantage means you won't pay a premium for superior quality and exceptional service. You'll find with your very first order, Windsor is not just a window and door company. We're a collection of dedicated professionals working every day to solve problems and build lasting relationships.



Make Every Project a Success

Windsor Windows & Doors has distinct product lines for every application. New construction. Room additions. Window replacement. Windsor has the solutions to help meet any home building or home improvement need. Discover all of the products we have to offer.

Pinnacle

Our top-of-the-line Pinnacle wood clad windows and doors offer a large selection of styles and shapes. The exterior comes in either a primed wood, cellular PVC or low-maintenance extruded aluminum cladding in 23 standard colors, 20 feature colors or 7 matte color finishes. Custom color matching is also available.

The wood interiors of our Pinnacle products are made from the finest Clear Select Pine, specially treated for long life. Select our Douglas Fir, which ranges in natural colors from bright white to a rich rose, or an attractive Natural Alder with wood tones spanning from a golden honey to a handsome reddish brown. These exquisite woods will complement any home's décor for years to come.

Pinnacle patio doors are offered in a variety of sizes and styles and are known for their strength, quality and aesthetics. They are easy to operate, and our heavy-duty weatherstripping will ensure your patio doors are ready for the changing seasons.

Whether you choose a swinging or sliding patio door for a traditional look with modern performance, a stunning bi-fold door to let the beauty of nature into your home or a multi-slide door to highlight your outdoor area and expand your interior living space, a Pinnacle patio door is a great way to enhance your view.

Pinnacle Select

Pinnacle Select is an elite product line constructed from enhanced components that provide unsurpassed performance and expansive full-glass views to the surrounding outdoor beauty in any season. DP ratings ranging from 50 up to 70 are some of the most impressive in the industry. Pinnacle Select windows are currently offered in casements (vented and fixed), picture, transom and awning. This line features a unique push-out style casement and awning, as well as a retractable screen option.

Pinnacle Select also offers three styles of grand scale patio doors that are perfect for today's majestic architectural homes. Available in in-swing, out-swing, multi-slide and bi-folding styles, Select patio doors are offered in two construction options. Choose from thermally broken, heavy-duty all aluminum exterior and interior construction or thermally broken, heavy-duty all aluminum exterior and wood interiors in either beautiful Clear Select Pine or Douglas Fir. These high-performance, large-panel doors are specifically designed to blend the splendor of the outdoors with any interior space.



Legend

Our Legend products use state-of-the-art cellular PVC in a solid construction throughout, creating the next innovation in windows. Legend windows combine the traditional look and feel of painted wood with the low maintenance and durability of cellular PVC construction. This product offers the only 25-year warranty in the industry. Get the best of both worlds with Windsor's Legend product line.

Legend HBR

Windsor has developed a unique hybrid product that we call Legend HBR, which combines the strength and durability of our Legend cellular PVC frame with a wood clad sash. The merging of these two product types offers a low-maintenance exterior with a beautiful wooden interior. Choosing both of these materials in white provides a traditional appearance, while producing the sash and frame in contrasting colors creates a two-toned effect that is popular in certain regions of the country. Our Legend HBR products are well suited for both new construction and historical renovation.

Next Dimension Signature

Next Dimension Signature windows and doors are robust, reliable products that offer the resilience of extruded multi-chambered vinyl. Enhanced components and sturdy construction add strength and stability, so homeowners can enjoy exceptional performance and energy efficiency for years to come.

Next Dimension Classic

Next Dimension Classic is available in single and double hung units, sliders, as well as sliding patio doors. What makes Next Dimension Classic unique is its sloped sill, tilt sash, brickmould profile frame and decorative features, such as a profiled inner grille and simulated divided lite.

Next Dimension Pro

Next Dimension Pro vinyl windows and patio doors are designed for light commercial, multi-family and residential applications, all at a highly competitive price. Vinyl extrusions ensure superior weathering, durability and color retention. Construction features are built in to reduce maintenance, add strength and security, and maximize weather resistance.

Revive Pocket Replacement Windows

There's a lot to love about a home – its unique character, timeless details and genuine craftsmanship. Drafty, unsightly windows can easily steal away from the beauty of these features. That's where Revive pocket replacement windows come into the picture.

Each window can be transformed with stunning Windsor quality in about an hour, with fewer worries about disturbing any treasured wood trim or other interior and exterior features. And because they're meticulously built to order with customizable features in three high-quality materials (wood clad, hybrid and vinyl), Windsor Revive pocket replacement windows are a fast, uncomplicated upgrade.

FEATURED ABOVE // PHOTO 1: PINNACLE CASEMENT AND DIRECT SET WINDOWS WITH TRANSOMS. Alpine, Utah. PHOTO 2: PINNACLE CASEMENT AND DIRECT SET WINDOWS. Montgomery County, Maryland. PHOTO 3: PINNACLE 10'0" IN-SWING PATIO DOORS AND STATIONARY DOOR PANELS IN BRONZE. Atlanta, Georgia. PHOTO 4: LEGEND DOUBLE HUNG WINDOWS WITH TRANSOMS. Greenwood, South Carolina. PHOTO 5: LEGEND HBR DOUBLE HUNG WINDOWS. Norfolk, Virginia. PHOTO 6: NEXT DIMENSION SIGNATURE PICTURE WINDOWS. Ankeny, Iowa.



Revive Sash Replacement Kit

Replace old, drafty, inefficient double hung sashes with energy efficient, dual pane sashes. Windsor's Revive Sash Replacement Kit makes updating easy, allowing homeowners to leave existing interior trim and plaster in place. Choose from three different replacement sashes: versatile primed wood, durable aluminum clad or low-maintenance cellular PVC. And, because Revive sashes feature EZ Tilt, cleaning is fast and hassle-free.

Environmentally Responsible

Windsor Windows & Doors and Woodgrain Millwork, Inc. practice a total commitment to the environment. We promise to act as a responsible corporate citizen, optimizing the use of resources and manufacturing products that have a positive impact on the environment as well as the health of people. We seek to realize our Green promise at Windsor and Woodgrain through the following efforts:

- Purchase of materials with recycled components; optimizing the use of resources and recycling generated scrap.
- Careful planning of product distribution from locations in Iowa and North Carolina to reduce carbon emissions from vehicle transportation.
- Enforcement of Green philosophy throughout the company; from integration of environmentally friendly materials in our products to printing of marketing materials on recycled paper, and much more.
- Partnering with those who are like-minded in Green efforts.



Windsor Glazing System



Glass Washer

Fully-automated glass washing station removes impurities with multiple washing stages and final drying zone

Spacer Applicator

Fully-automated Super Spacer applicator ensures accurate positioning and constant depth of seal on all four sides of the window

Grille Station

Fully-automated Inner-Grid Machine forms coil stock into profile and sequentially cuts each segment with appropriate end work and punches; attendant places the assembled grid on glass before sheets are insulated

Fill Chamber and IG Press

Fully-automated assembling/matching press with integrated argon gas flood chamber ensures consistent gas fill rates

Secondary Sealing Robot

Sealing robot for precise application of hot melt butyl secondary seal

Windsor's Glazing System offers builders a well-engineered window that is superior in energy efficiency and competitive in price. The highly-automated glass line is tightly monitored throughout the entire process with rigorous quality controls. Three sophisticated technologies will be brought into our plants: a highly-automated fabrication equipment process from Liseç, high-performance glass from Cardinal® and an advanced Super Spacer® all-foam edge application from Edgetech.

State-of-the-Art Liseç® Glass Fabrication Equipment

Our highly-automated glass line requires no manual manipulation – dramatically reducing seal failures caused by human contact with the glass – while our robotic equipment provides an incredible level of accuracy for a fast and efficient material flow.

Super Spacer® Technology

Super Spacer dual-seal moisture barrier technology provides one of the most thermally efficient spacers in the marketplace, meeting or exceeding ENERGY STAR® guidelines in all zones. All-foam Super Spacer reduces heat and cold conduction, which results in more comfortable living for homeowners and fewer callbacks for builders.

BEST OVERALL U-VALUE IMPROVEMENT

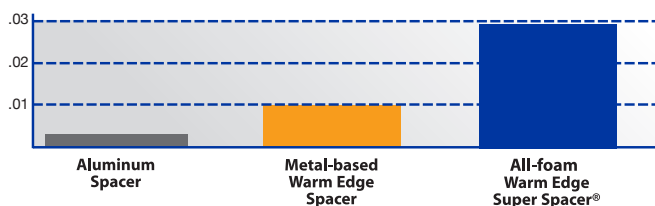

Super Spacer®

Reverse dual-seal technology

Airspace is not filled with argon in products with breathing tubes.

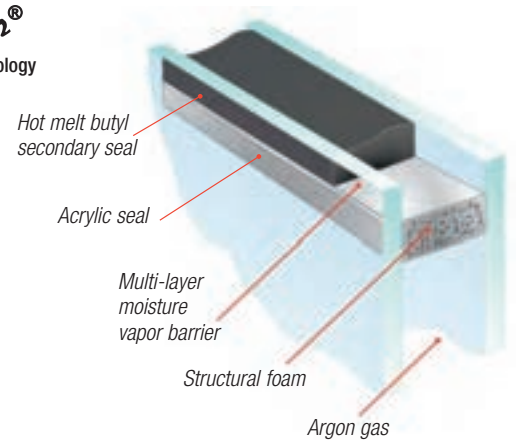

Cardinal® LoE 366 Glass

Windsor products feature LoE 366 glass with a coating that alters the way glass transmits visible and invisible light. LoE 366 decreases heat loss in the winter and heat gain in the summer. Reduced ultraviolet light penetration also helps prevent your furniture, drapes and carpet from fading.

If you're searching for Dual Low-E and tempered insulated glass, look no further than Windsor. Combining Cardinal LoE 366 soft coating with Cardinal i89 LoE, the Dual Low-E glazing option creates clear, insulated glass with superior performance.

ENERGY STAR® Partner

Windsor Windows & Doors is proud to be an ENERGY STAR partner. Look for the ENERGY STAR logo on our products, which means those models meet EPA guidelines for energy efficiency. Performance data is available on our website at www.windsorwindows.com.



**Download the latest
Pinnacle Showcase**
at windsorwindows.com.

Pinnacle and Pinnacle Select

The Finest Wood Materials for the Finest Homes

The wood interiors of our Pinnacle products are made from the finest pine, alder and fir. Choose from Clear Select Pine, specially treated for long life, the beautiful natural colors of Douglas Fir or attractive deep wood tones of Natural Alder. These exquisite woods will complement any home's décor for years to come.

Clad

Our top-of-the-line Pinnacle wood clad windows and doors offer a large selection of styles and shapes. The exterior comes in either a primed wood, cellular PVC or low-maintenance extruded aluminum cladding in 23 standard colors, 20 feature colors or 7 matte color finishes. To meet today's design styles, custom color matching is always available.

Select

Pinnacle Select is an elite line of aluminum clad windows and doors constructed from enhanced components for unsurpassed performance. Select windows are available in casement and awning styles and feature robust profiles for architectural appeal, dimension and strength. Additional options include push-out functionality and innovative retractable screens perfect for a wide variety of homes. Select doors are available in multi-slide, swinging and bi-fold options and are built to grand scale for today's majestic architectural homes.

**See what sets Pinnacle apart at
www.windsorpinnacle.com.**



Pinnacle Select Casement & Awning

Benefits of Pinnacle Select

- Clear Select Pine, Douglas Fir or Natural Alder interior
- Constructed with 2-5/16" wide stiles and rails that add structural stability and provide a more massive architectural appearance
- Robust 2-3/16" thick sash adds dimension and strength; for Select units with 1-1/4" OA triple IG, the sash thickness increases to 2-7/16"
- Double mortise and tenon sash joints fastened with screws for strength and stability
- Select casement and awning available in larger sizes
 - Crank-out: up to 3096, 3684 or 4272
 - Push-out: up to 3678
 - Venting awning: up to 6060
- Select casement and awning available in two styles
 - Operating: standard crank
 - Push-out: lever handle
- Retractable screens available on operating and push-out products; pull bar, cartridge case and frame of screen produced from same wood species as window

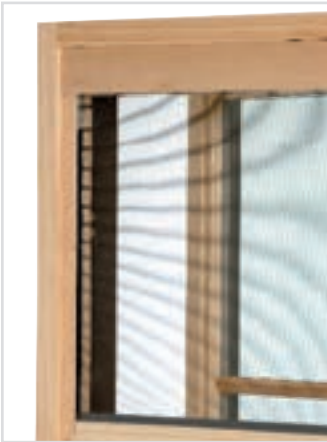

- Windsor Glazing System provides 3/4" double pane insulated glass
 - Cardinal® LoE 366 glass standard
 - Select units with triple IG option feature 1-1/4" OA insulated glass
 - Tinted, tempered, obscure and laminated glass available

Features of Push-out Units

- Push-out hardware consists of an easy-to-operate lever with cam rollers and keepers; this mechanism provides a multi-point locking system that is standard



- Push-outs equipped with adjustable friction hinges and lock rollers in both casement and awning
- Friction device on larger push-out awning maintains sash opening
- Push-out casement provides an impressive DP rating of 50 for all sizes
- DP rating of push-out awning range from 40 up to 70

Features of Operating Units

- Operating casement uses adjustable hinges
- Operating casement provides an amazing DP rating of 70 (*except for the 3678, which has a DP rating of 50*)
- DP rating of operating awning is 50 for all sizes

Finishes

- Interior – Available in Clear Select Pine, Douglas Fir or Natural Alder
 - Primed: white or black
 - Painted: white, black or gray
 - Stained: 9 color options
- Exterior – Select windows feature heavy-duty extruded aluminum cladding on sash and frame

Clad Colors

- All clad colors painted in-house with the highly durable AAMA 2604 standard finish, or upgrade to AAMA 2605 for the most challenging of environments
- 23 Standard Clad Colors available in 2604 and 2605 finish
 - 20 Feature Clad Colors available in 2604 and 2605 finish (Custom color matching is also available)
 - 7 Matte Clad Colors available in the 2604 finish only

Pinnacle Select French Push-out Casement

Benefits of Pinnacle Select

- Clear Select Pine, Douglas Fir or Natural Alder interior
- Constructed with 2-5/16" wide stiles and rails that add structural stability and provide a more massive architectural appearance
- Robust 2-3/16" thick sash adds dimension and strength; for Select units with 1-1/4" OA triple IG, the sash thickness increases to 2-7/16"
- Double mortise and tenon sash joints fastened with screws for strength and stability
- Available in sizes from 3624 up to 6072
- Available in OX and XO handings

- Retractable screens available; pull bar, cartridge case and frame of screen produced from same wood species as window
- Windsor Glazing System provides 3/4" double pane insulated glass
 - Cardinal® LoE 366 glass standard
 - Select units with triple IG option feature 1-1/4" OA insulated glass
 - Tinted, tempered, obscure and laminated glass available
- Hardware consists of easy to open lever with cam roller on primary active sash; secondary active sash incorporates a lever activated head/sill engaged looking system
- All French push-out casements are standard with egress adjustable friction hinges to maximize sash opening
- Seacoast hardware is standard

Finishes

- Interior – Available in Clear Select Pine, Douglas Fir or Natural Alder
 - Primed: white or black
 - Painted: white, black or gray
 - Stained: 9 color options
- Exterior – Select windows feature heavy-duty extruded aluminum cladding on sash and frame

Clad Colors

- All clad colors painted in-house with the highly durable AAMA 2604 standard finish, or upgrade to AAMA 2605 for the most challenging of environments
- 23 Standard Clad Colors available in 2604 and 2605 finish
 - 20 Feature Clad Colors available in 2604 and 2605 finish (Custom color matching is also available)
 - 7 Matte Clad Colors available in the 2604 finish only



Pinnacle Select Triple Insulated Glass Glazing Option

- Select windows are constructed with 2-5/16" wide stiles and rails that add structural stability and provide a more massive architectural appearance
- A robust 2-7/16" thick sash adds dimension and strength and will accommodate a 1-1/4" triple IG unit
- Double mortise and tenon sash joints are fastened with screws for strength and stability
- Each triple IG unit comes standard with Cardinal® LoE 366 glass (surface #2) and LoE 180 (surface #5) for superior thermal performance
- LoE, LoE obscure, LoE reed, LoE rain, LoE glue chip and LoE satin etch glass options are available
- Size limitations on Select windows with triple IG:
 - Casement operating and push-out: up to 3678 frame size
 - Awning: up to 4836 frame size
 - Casement picture: up to 7278 frame size
- Select windows ordered with triple IG are available with the same options and features as standard Select products
- Triple IG is also available in Pinnacle clad direct set and radius products

Product	Glass Type	LoE	Gas Fill	U-Factor	SHGC	VT
Select Casement	1-1/4" Triple	366 / 180	Air	0.26	0.17	0.37
	1-1/4" Triple	366 / 180	Argon	0.24	0.17	0.37
Select Awning	1-1/4" Triple	366 / 180	Air	0.26	0.17	0.37
	1-1/4" Triple	366 / 180	Argon	0.24	0.17	0.37
Select Casement Picture	1-1/4" Triple	366 / 180	Air	0.22	0.20	0.44
	1-1/4" Triple	366 / 180	Argon	0.20	0.19	0.44
Clad Direct Set	1-1/4" Triple	366 / 180	Air	0.22	0.32	0.49
	1-1/4" Triple	366 / 180	Argon	0.19	0.32	0.49
Clad Radius	1-1/4" Triple	366 / 180	Air	0.20	0.33	0.51
	1-1/4" Triple	366 / 180	Argon	0.17	0.33	0.51

LOE 366 (SURFACE #2) →

LOE 180 (SURFACE #5) →



Crank-out

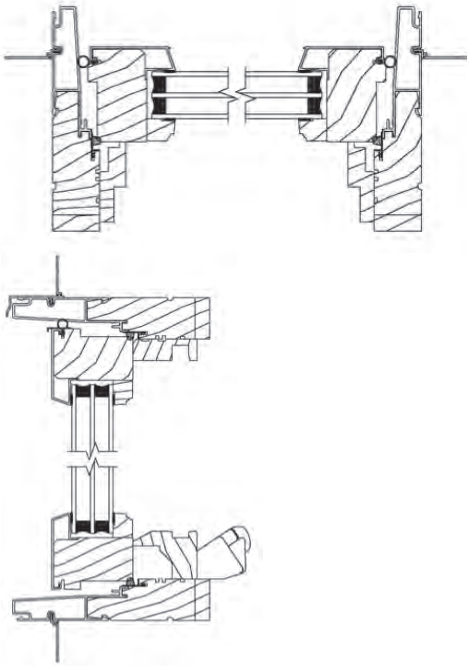

Push-out

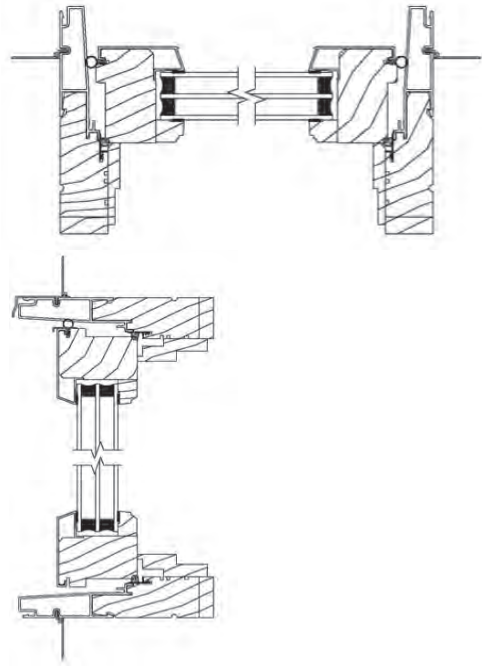

Direct Set

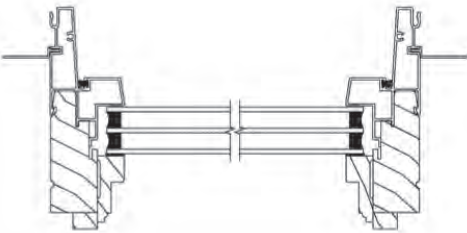

Picture

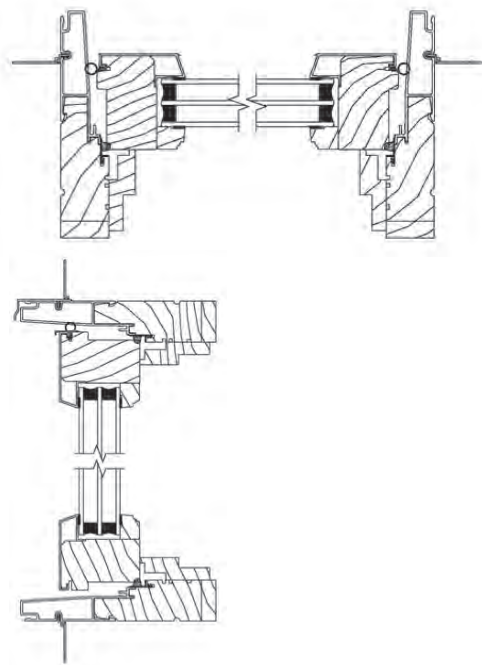

Radius

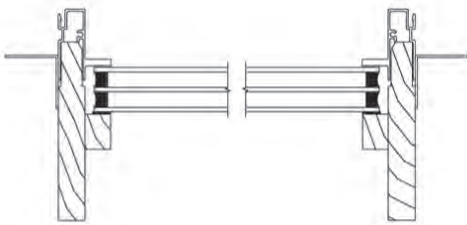

Triple IG Unit with WDL

WDL inner bar in both air spaces

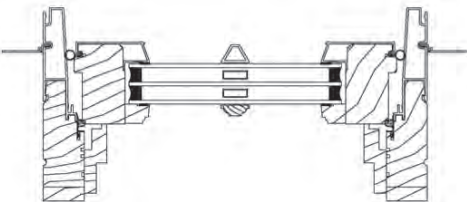

Triple IG Unit with Inner Grille

Inner grille in exterior air space

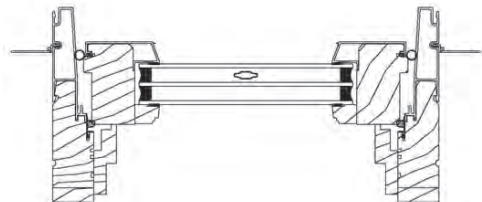

Pinnacle Select In-swing and Out-swing Patio Doors

Features and Benefits

- Available in aluminum exterior / wood interior, or aluminum exterior / aluminum interior
- Thermally broken aluminum panels and frames
- Single-panel and two panel options
- 2-3/8" thick panel construction
- Narrow 3-3/16" wide panels reveal more glass for beautiful views
- Standard and ADA sill options
- Three-point multi-point locking system on 8-0 through 10-0 tall doors; four-point multi-point locking system on doors over 10-0 tall

Sizes

- Standard panel widths: 2-6, 2-8, 3-0, 3-6
- Standard panel heights: 8-0, 9-0, 10-0, 11-0, 12-0
- Maximum panel size: 3-6 x 12-0
- Door sizes up to 3-6 x 12-0 single-panel door and 7-0 x 12-0 two-panel door

Glazing

- 1" overall double pane insulated glass, Cardinal® LoE 366 glass standard, LoE 270 and Dual Low-E optional
- Interior stop glazed

Finishes

- Interior – Wood interior doors available in Clear Select Pine or Douglas Fir; aluminum interior doors available in color matched aluminum
- Exterior – All doors have heavy-duty thermally broken aluminum panels and frames

Clad Colors

All clad colors painted with the highly durability of AAMA 2604 standard finish, or upgrade to AAMA 2605 for the most challenging of environments

- 23 Standard Clad Colors available in 2604 and 2605 finish
- 20 Feature Clad Colors available in 2604 and 2605 finish
- 7 Matte Clad Colors available in 2604 finish only

Hardware

- Multi-point lock on operable panels
 - 3-point on 8-0, 9-0 and 10-0 tall doors
 - 4-point on 11-0 and 12-0 tall doors
- Non-adjustable hinges
- Three handle set styles



In-swing/Out-swing
Alum Ext. Wood Int. Panel



In-swing/Out-swing
Alum Ext. Alum Int. Panel



In-swing 1-1/4" standard sill



Out-swing 1-1/4" standard sill



ADA sill

Pinnacle Select Bi-fold Patio Doors

Features and Benefits

- Available in aluminum exterior / wood interior, or aluminum exterior / aluminum interior
- Thermally broken aluminum panels and frames
- 2-5/8" thick panel construction on wood interior doors; 2-3/8" thick panel construction on aluminum interior doors
- Narrow 2-1/16" wide panels reveal more glass for beautiful views
- Standard and recessed sill options
- Multiple handing options
- Three-point multi-point locking system on 8-0 through 10-0 tall doors; four-point multi-point locking system on doors over 10-0 tall
- Handle activated concealed twin bolt

Sizes

- Standard panel widths: 2-6, 2-8, 3-0, 3-6
- Standard panel heights: 8-0, 9-0, 10-0, 11-0, 12-0
- Maximum panel size: 3-6 x 12-0

Glazing

- 1" overall double pane insulated glass, Cardinal® LoE 366 glass standard, LoE 270 and Dual Low-E optional
- Interior stop glazed

Finishes

- Interior – Wood interior doors available in Clear Select Pine or Douglas Fir; aluminum interior doors available in color matched aluminum
- Exterior – All doors have heavy-duty thermally broken aluminum panels and frames

Clad Colors

All clad colors painted with the highly durability of AAMA 2604 standard finish, or upgrade to AAMA 2605 for the most challenging of environments

- 23 Standard Clad Colors available in 2604 and 2605 finish
- 20 Feature Clad Colors available in 2604 and 2605 finish
- 7 Matte Clad Colors available in 2604 finish only

Hardware

- Multi-point lock on operable panels
 - 3-point on 8-0, 9-0 and 10-0 tall doors
 - 4-point on 11-0 and 12-0 tall doors
- Three handle set styles
- Handle activated concealed twin bolt system



Bi-fold 2-3/16" STD surface track sill



Bi-fold 1-1/2" recessed sill with drainage

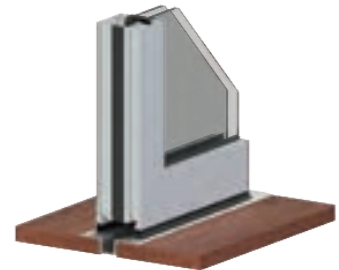

Bi-fold 3/4" recessed sill no drainage



Bi-fold Alum Ext. Wood Int. Panel



Bi-fold Alum Ext. Alum Int. Panel

Pinnacle Select Multi-slide Patio Doors

Features and Benefits

- Available in aluminum exterior / wood interior, or aluminum exterior / aluminum interior
- Thermally broken aluminum panels and frames
- Stacking multi-slide system aligns all panels with the stationary panel when in the fully open position; all panels are visible
- Pocket multi-point system incorporates a pocket into the wall cavity to conceal all panels when they are in the fully open position
- Door jamb widths vary depending on the number of panels in the multi-slide door system and the handing
- Up to five panels in any one direction and 10 panels for a bi-parting multi-slide door
- 2-3/8" thick panel construction
- Narrow 3-3/16" wide panels reveal more glass for beautiful views
- Standard and recessed sill options
- Two-point locking gear with two-way adjustable keeper
- End adjust Delrin® rollers
- Flush mount handle
- Lead panel on pocket doors come with a finger pull

Sizes

- Standard panel widths: 3-0, 4-0, 5-0, 6-0
- Standard panel heights: 8-0, 9-0, 10-0, 11-0, 12-0
- Maximum panel size: 5-0 x 12-0 and 6-0 x 10-0

Glazing

- 1" overall double pane insulated glass, Cardinal® LoE 366 glass standard, LoE 270 and Dual Low-E optional
- Interior stop glazed

Finishes

- Interior – Wood interior doors available in Clear Select Pine or Douglas Fir; aluminum interior doors available in color matched aluminum
- Exterior – All doors have heavy-duty thermally broken aluminum panels and frames

Clad Colors

All clad colors painted with the highly durability of AAMA 2604 standard finish, or upgrade to AAMA 2605 for the most challenging of environments

- 23 Standard Clad Colors available in 2604 and 2605 finish
- 20 Feature Clad Colors available in 2604 and 2605 finish
- 7 Matte Clad Colors available in 2604 finish only

Hardware

- Two-point locking gear with two-way adjustable keeper
- End adjust Delrin® rollers
- Flush mount handle
- Finger pull on pocket door lead panels



Multi-slide 1-1/8" standard sill



Multi-slide 2-1/2" recessed sill with drainage



Multi-slide 2-1/2" recessed sill no drainage



Multi-slide Alum Ext. Wood Int. Panel



Multi-slide Alum Ext. Alum Int. Panel

Pinnacle Casement & Awning

Features and Benefits

- The warmth and beauty of Clear Select Pine, Douglas Fir or Natural Alder; can be painted or stained
- Clad units offer a strong, durable extruded aluminum sash and frame for low maintenance; primed units offer the traditional appearance where the trim and exterior sash are cellular PVC
- Glass is replaceable in case of damage
- 2" thick sash adds beauty and increases insulating value
- Exterior tape glazing slows conduction of heat/cold through edge of glass; two beads of silicone ensure a water tight seal that creates three seals between glass and sash
- Single lever, sequential, multi-point lock for sleek look and easy operation



- Adjustable concealed hinge system ensures smooth operation



- 1-1/4" jamb creates unmatched strength and stability
- Silicone-injected frame corners create a stronger and more attractive joint

Sizes

Available in hundreds of standard and custom sizes

Glazing

- Windsor Glazing System provides 3/4" double pane insulated glass; Cardinal® LoE 366 glass standard; tinted, tempered, obscure and laminated glass available
- Glazed with tape and silicone sealant
- Custom and special glass types available
- Preserve protective film optional

Exterior Trim

- Clad windows available with WM 180 brickmould, Williamsburg, or 3-1/2" flat casing; 3/8", 1-1/4", 2-1/4" subsills
- Primed windows available with WM 180 brickmould, WM 180 brickmould with flange, Williamsburg, 3-1/2" flat, 4-1/2" backband, 5-1/2" flat or plantation casing; 2" bull nose sill nose, casement subsill or 2" casement subsill
- All prime window trims, subsills and sill nose are cellular PVC

Grilles

Windsor Divided Lite (WDL) = simulated divided lite

- 7/8" and 1-1/4" Perimeter Grille (NOT available on radius casements)
- 7/8" and 1-1/4" Stick Grille
- 3/4" and 1" Profiled Inner Grille
- 13/16" Flat Inner Grille
- 7/8" and 1-1/4" Ogee WDL
- 5/8", 7/8", 1-1/4" and 2" Tall and Short Putty WDL
- 5/8", 7/8", 1-1/4" and 2" Tall and Short Contemporary WDL
- 2" Simulated Check Rail
- Standard and custom grille patterns available

Finishes

- Interior – Available in Clear Select Pine, Douglas Fir or Natural Alder
 - Primed: white or black
 - Painted: white, black or gray
 - Stained: 9 color options

- Exterior – Clad windows feature heavy-duty extruded aluminum cladding on sash and frame; primed windows offer an assortment of traditional cellular PVC trim options

Clad Colors

All clad colors painted in-house with the highly durable AAMA 2604 standard finish, or upgrade to AAMA 2605 for the most challenging of environments

- 23 Standard Clad Colors available in 2604 and 2605 finish
- 20 Feature Clad Colors available in 2604 and 2605 finish (Custom color matching is also available)
- 7 Matte Clad Colors available in the 2604 finish only

Hardware

Encore folding nesting crank and cover by Truth® available in champagne, white, bronze and black; optional finishes in faux bronze, oil rubbed bronze, satin nickel and bright brass

Performance Ratings

For current performance ratings, visit our website at windsorwindows.com and click on "Professional Information" in the menu bar



Pinnacle Casement & Awning with 3-1/4" Frame

Features and Benefits

- The warmth and beauty of Clear Select Pine, Douglas Fir or Natural Alder; can be painted or stained
- Clad units offer a strong, durable extruded aluminum sash and frame for low maintenance
- Glass is replaceable in case of damage
- 2" thick sash adds beauty and increases insulating value
- Exterior tape glazing slows conduction of heat/cold through edge of glass; two beads of silicone ensure a water tight seal that creates three seals between glass and sash
- Single lever, sequential, multi-point lock for sleek look and easy operation



- Adjustable concealed hinge system ensures smooth operation



- 1-1/4" jamb creates unmatched strength and stability
- Silicone-injected frame corners create a stronger and more attractive joint
- Side stops held in place with kerf and barb for easy removal and replacement

Sizes

Available in hundreds of standard and custom sizes

Glazing

- Windsor Glazing System provides 3/4" double pane insulated glass; Cardinal® LoE 366 glass standard; tinted, tempered, obscure and laminated glass available
- Glazed with tape and silicone sealant
- Custom and special glass types available
- Preserve protective film optional

Exterior Trim

- 3-1/4" frame windows available with traditional or contemporary flush fin extruded aluminum casing options; flush fin trims are mitered and applied to all four sides

Grilles

Windsor Divided Lite (WDL) = simulated divided lite

- 7/8" and 1-1/4" Perimeter Grille (*NOT available on radius casements*)
- 7/8" and 1-1/4" Stick Grille
- 3/4" and 1" Profiled Inner Grille
- 13/16" Flat Inner Grille
- 7/8" and 1-1/4" Ogee WDL
- 5/8", 7/8", 1-1/4" and 2" Tall and Short Putty WDL
- 5/8", 7/8", 1-1/4" and 2" Tall and Short Contemporary WDL
- 2" Simulated Check Rail
- Standard and custom grille patterns available

Finishes

- Interior – Available in Clear Select Pine, Douglas Fir or Natural Alder
 - Primed: white or black
 - Painted: white, black or gray
 - Stained: 9 color options
- Exterior – Clad windows feature heavy-duty extruded aluminum cladding on sash and frame



Clad Colors

All clad colors painted in-house with the highly durable AAMA 2604 standard finish, or upgrade to AAMA 2605 for the most challenging of environments

- 23 Standard Clad Colors available in 2604 and 2605 finish
- 20 Feature Clad Colors available in 2604 and 2605 finish (Custom color matching is also available)
- 7 Matte Clad Colors available in the 2604 finish only

Hardware

Encore folding nesting crank and cover by Truth® available in champagne, white, bronze and black; optional finishes in faux bronze, oil rubbed bronze, satin nickel and bright brass

Performance Ratings

For current performance ratings, visit our website at windsorwindows.com and click on "Professional Information" in the menu bar

Pinnacle Double Hung with Concealed Jambliner

Improved Performance

- A raised sill stop is incorporated into ALL Pinnacle clad double hung windows, including both the compression jambliner option and the concealed jambliner option; the sill stop will now be flush with the bottom of the finger pull, providing better performance
- On windows ordered with the concealed jambliner option, head frame corners will be secured with corner keys, injected silicone and screws for improved stability; therefore, the corner gaskets are no longer needed
- Structural changes of the concealed jambliner provide improved DP ratings

More Selection

- Half-screens will be available on the concealed jambliner option
- A new, full-size, inverted block and tackle balance provides support for a heavier sash, allowing for future production of larger sizes
- Interior jamb covers are available in all wood species, providing more wood on the interior and less vinyl



Added Convenience

- Jamb jacks provide the ability to make future adjustments after settling
- A trim identification line on the side and head inside stops provides easy alignment during installation



Enhanced Appearance

- A wood head parting stop replaces a vinyl parting stop
- The picture window back-out strip is now color-matched aluminum for a consistent exterior appearance
- The sill bottom rail weatherstrip is now available in two colors: bronze and beige; one complements the lighter clad colors and the other complements the darker clad colors
- Exterior jamb covers are available in finishes that match the aluminum



Double hung window with concealed jambliner



Picture window with jamb cover

Please note:

- *Clad single hung oriel windows will only be available with the concealed jambliner option*
- *The concealed jambliner option is NOT available in Legend HBR or Revive Sash Replacement*

Pinnacle Double Hung & Glide-by

Features and Benefits

- The warmth and beauty of Clear Select Pine, Douglas Fir or Natural Alder; can be painted or stained
- Clad units offer a strong, durable extruded aluminum sash and frame for low maintenance; primed units offer the traditional appearance of decorative cellular PVC trim
- Glass is replaceable in case of damage
- Both tape and silicone glazed, with interior wood stops for superior strength and seal
- EZ Tilt operation available for easy removal and replacement of sash (double hung only)



- Both sashes tilt in with compression or concealed jambliner for easy cleaning
- Recessed lock and keeper for a sleek appearance



- Block and tackle balance system for ease of operation
- Prime double hung units come standard with cellular PVC trim, blind stop and sill
- No-finger pull option for hardware application

Sizes

Available in hundreds of standard and custom sizes

Glazing

- Windsor Glazing System provides 3/4" double pane insulated glass; Cardinal® LoE 366 glass standard; tinted, tempered, obscure and laminated glass available
- Glazed with tape and silicone sealant
- Custom and special glass types available
- Preserve protective film optional

Exterior Trim

- Clad windows available with WM 180 brickmould, Williamsburg, or 3-1/2" flat casing; 3/8", 1-1/4", 2-1/4" subsills
- Primed windows available with WM 180 brickmould, WM 180 brickmould with flange, Williamsburg, 3-1/2" flat, 4-1/2" backband, 5-1/2" flat or plantation casing; double hung sill nose, 2" bull nose sill nose or belly sill nose
- All prime window trims, sill nose and outside stops are cellular PVC

Grilles

Windsor Divided Lite (WDL) = simulated divided lite

- 7/8" and 1-1/4" Perimeter Grille (*NOT available on radius double hung*)
- 7/8" and 1-1/4" Stick Grille
- 3/4" and 1" Profiled Inner Grille
- 13/16" Flat Inner Grille
- 7/8" and 1-1/4" Ogee WDL
- 5/8", 7/8", 1-1/4" and 2" Short Putty WDL
- 5/8", 7/8", 1-1/4" and 2" Short Contemporary WDL
- 2" Simulated Check Rail (*DH picture only*)
- Standard and custom grille patterns available

Finishes

- Interior – Available in Clear Select Pine, Douglas Fir or Natural Alder
 - Primed: white or black
 - Painted: white, black or gray
 - Stained: 9 color options
- Exterior – Clad windows feature heavy-duty extruded aluminum cladding on sash and frame; primed windows (*double hung only*) offer an assortment of traditional cellular PVC trim options

Clad Colors

All clad colors painted in-house with the highly durable AAMA 2604 standard finish, or upgrade to AAMA 2605 for the most challenging of environments

- 23 Standard Clad Colors available in 2604 and 2605 finish
- 20 Feature Clad Colors available in 2604 and 2605 finish (Custom color matching is also available)
- 7 Matte Clad Colors available in the 2604 finish only

Hardware

Double hung lock available in champagne, white, bronze and black; optional finishes in faux bronze, oil rubbed bronze, satin nickel and bright brass

Performance Ratings

For current performance ratings, visit our website at windsorwindows.com and click on "Professional Information" in the menu bar



Pinnacle Direct Set & Radius

Features and Benefits

- The warmth and beauty of Clear Select Pine, Douglas Fir or Natural Alder; can be painted or stained
- Clad units offer a strong, durable extruded aluminum frame for low maintenance; primed units offer the traditional appearance of decorative trim made of cellular PVC
- Glass is replaceable in case of damage
- 1-1/4" frame on direct set and 3/4" frame on radius/low profile direct set creates unmatched strength and stability
- Silicone-injected frame corners create a stronger and more attractive joint

Glazing

- Windsor Glazing System provides 3/4" double pane insulated glass; Cardinal® LoE 366 glass standard; tinted, tempered, obscure and laminated glass available
- Glazed with silicone sealant
- Custom and special glass types available
- Preserve protective film optional

Exterior Trim

- Clad windows available with WM 180 brickmould, clad extruded Williamsburg and 3-1/2" flat casing (*direct set only*)
- Primed windows available with WM 180 brickmould, WM 180 brickmould with flange, Williamsburg, 3-1/2" flat, 4-1/2" backband, 5-1/2" flat or plantation casing; 2" bull nose sill nose, casement subsill or 2" casement subsill
- All prime window trims and subsills are cellular PVC

Grilles

Windsor Divided Lite (WDL) = simulated divided lite

- 7/8" and 1-1/4" Stick Grille
- 3/4" and 1" Profiled Inner Grille
- 13/16" Flat Inner Grille
- 7/8" and 1-1/4" Ogee WDL
- 8", 7/8", 1-1/4" and 2" Tall and Short Putty WDL
- 5/8", 7/8", 1-1/4" and 2" Tall and Short Contemporary WDL
- 2" Simulated Check Rail (Direct set only)
- Standard and custom grille patterns available

Finishes

- Interior – Available in Clear Select Pine, Douglas Fir or Natural Alder
 - Primed: white or black
 - Painted: white, black or gray
 - Stained: 9 color options
- Exterior – Clad windows feature heavy-duty extruded aluminum cladding on frame; primed windows offer an assortment of traditional cellular PVC trim options

Clad Colors

All clad colors painted in-house with the highly durable AAMA 2604 standard finish, or upgrade to AAMA 2605 for the most challenging of environments

- 23 Standard Clad Colors available in 2604 and 2605 finish
- 20 Feature Clad Colors available in 2604 and 2605 finish (Custom color matching is also available)
- 7 Matte Clad Colors available in the 2604 finish only

Performance Ratings

For current performance ratings, visit our website at windsorwindows.com and click on "Professional Information" in the menu bar



Pinnacle Clad 3-1/4" Frame Direct Set & Radius

Features and Benefits

- The warmth and beauty of Clear Select Pine, Douglas Fir or Natural Alder; can be painted or stained
- Clad units offer a strong, durable extruded aluminum frame for low maintenance
- Glass is replaceable in case of damage
- 3/4" frame on radius/direct set creates unmatched strength and stability
- Silicone-injected frame corners create a stronger and more attractive joint

Glazing

- Windsor Glazing System provides 3/4" double pane insulated glass; Cardinal® LoE 366 glass standard; tinted, tempered, obscure and laminated glass available
- Glazed with silicone sealant
- Custom and special glass types available
- Preserve protective film optional

Exterior Trim

- Clad windows available with WM 180 brickmould, clad extruded Williamsburg and 3-1/2" flat casing (*direct set only*)

Grilles

Windsor Divided Lite (WDL) = simulated divided lite

- 7/8" and 1-1/4" Stick Grille
- 3/4" and 1" Profiled Inner Grille
- 13/16" Flat Inner Grille
- 7/8" and 1-1/4" Ogee WDL
- 7/8", 7/8", 1-1/4" and 2" Tall and Short Putty WDL
- 5/8", 7/8", 1-1/4" and 2" Tall and Short Contemporary WDL
- 2" Simulated Check Rail (Direct set only)
- Standard and custom grille patterns available

Finishes

- Interior – Available in Clear Select Pine, Douglas Fir or Natural Alder
 - Primed: white or black
 - Painted: white, black or gray
 - Stained: 9 color options
- Exterior – Heavy-duty extruded aluminum cladding on frame

Clad Colors

All clad colors painted in-house with the highly durable AAMA 2604 standard finish, or upgrade to AAMA 2605 for the most challenging of environments

- 23 Standard Clad Colors available in 2604 and 2605 finish
- 20 Feature Clad Colors available in 2604 and 2605 finish (Custom color matching is also available)
- 7 Matte Clad Colors available in the 2604 finish only

Performance Ratings

For current performance ratings, visit our website at windsorwindows.com and click on "Professional Information" in the menu bar



Clad 3-1/4" Direct Set
& Radius Corner Cut

Clad 90 Degree Corner Window

Features and Benefits

- The warmth and beauty of Clear Select Pine, Douglas Fir or Natural Alder; can be painted or stained
- Units offer a strong, durable extruded aluminum frame for low maintenance;
- Glass is replaceable in case of damage
- 3/4" frame creates unmatched strength and stability
- Silicone-injected frame corners create a stronger and more attractive joint
- Standard and contemporary glass stops available
- Units offered with or without corner post. Units with corner post are glazed with the option of open with no glass. Units without corner post are only offered open without glass.

Glazing

- Windsor Glazing System provides 3/4" double pane insulated glass; Cardinal® LoE 366 glass standard; tinted, tempered, obscure and laminated glass available
- Glazed with silicone sealant
- Custom and special glass types available
- Preserve protective film optional

Grilles

Windsor Divided Lite (WDL) = simulated divided lite

- 7/8" and 1-1/4" Stick Grille
- 3/4" and 1" Profiled Inner Grille
- 13/16" Flat Inner Grille
- 7/8" and 1-1/4" Ogee WDL
- 5/8", 7/8", 1-1/4" and 2" Tall and Short Putty WDL
- 5/8", 7/8", 1-1/4" and 2" Tall and Short Contemporary WDL
- Standard and custom grille patterns available

Finishes

- Interior – Available in Clear Select Pine, Douglas Fir or Natural Alder
 - Primed: white or black
 - Painted: white, black or gray
 - Stained: 9 color options
- Exterior – Windows feature heavy-duty extruded aluminum cladding on frame and corner post

Clad Colors

- All clad colors painted in-house with the highly durable AAMA 2604 standard finish, or upgrade to AAMA 2605 for the most challenging of environments
- 23 Standard Clad Colors available in 2604 and 2605 finish
 - 20 Feature Clad Colors available in 2604 and 2605 finish (Custom color matching is also available)
 - 7 Matte Clad Colors available in the 2604 finish only

Performance Ratings

For current performance ratings, visit our website at windsorwindows.com and click on "Professional Information" in the menu bar

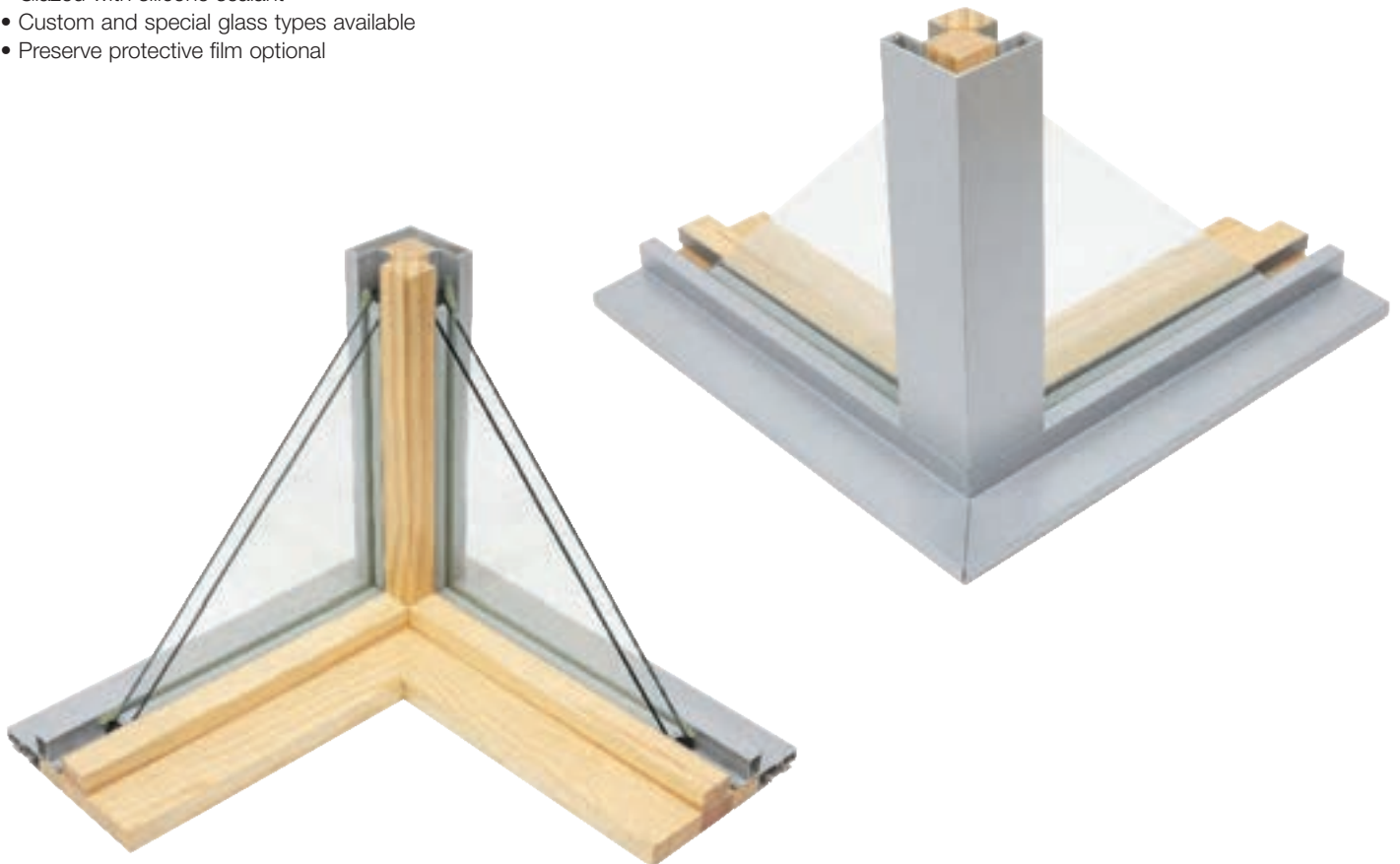

Pinnacle Swinging Patio Door

Features and Benefits

- Stainless steel multi-point locking hardware option for added security
- Integral structural astragal allows for doors up to 12 feet wide to be placed in a single frame, which decreases the potential for air and water infiltration
- "Easy Adjust" hinge system for effortless operation and correction after installation
- Wept sill system to eliminate water infiltration
- Dual-seal frame weatherstripping at panel face and edge improves air and thermal performance
- Taller sill provides excellent water performance and design pressure ratings
- Foam-backed glazing bead prevents paint and stain from bleeding
- Active stiles constructed of an LVL core material for added strength and stability
- Panel exterior matches Pinnacle product line with consistent depth from glass to face of the panel for a clean, complementary appearance
- Panels available in traditional French or contemporary narrow stile
- Low clearance (ADA-approved) sill options
- In-swing and out-swing options available
- 1/2 and 3/4 lite available with flat or split panel option
- Seg-top available

Sizes

- Five standard heights: 6'8", 6'10", 8'0", 9'0" and 10'0" (9'0" and 10'0" doors available in French panels only)
- Custom sizes available

Glazing

- Windsor Glazing System provides 3/4" double pane insulated glass; Cardinal® LoE 366 glass standard; tinted, tempered, obscure and laminated glass available
- Interior stop glazed with silicone sealant
- Custom and special glass types available

Exterior Trim

- Clad doors available with WM 180 brickmould, Williamsburg or 3-1/2" flat casing; primed doors available with WM 180 brickmould, WM 180 brickmould with flange, Williamsburg, 3-1/2" flat, 4-1/2" backband, 5-1/2" flat or plantation casing
- All prime door trims are cellular PVC

Grilles

Windsor Divided Lite (WDL) = simulated divided lite

- 7/8" and 1-1/4" Perimeter Grille (*NOT available on radius doors*)
- 7/8" and 1-1/4" Stick Grille (*Radius swing doors only*)
- 3-4" and 1" Profiled Inner Grille
- 13/16" Flat Inner Grille
- 7/8" and 1-1/4" Ogee WDL
- 5/8", 7/8", 1-1/4" and 2" Short Putty WDL
- 5/8", 7/8", 1-1/4" and 2" Short Contemporary WDL
- 3-3/8" Simulated Mid Rail
- Standard and custom grille patterns available

Weatherstripping

- Rigid, weatherable PVC or urethane foam encased in polyethylene film
- In-swing and out-swing doors feature bottom heavy-duty, self-adjusting sweep

Finishes

- Interior – Available in Clear Select Pine, Douglas Fir or Natural Alder
 - Primed: white or black
 - Painted: white, black or gray
 - Stained: 9 color options
- Exterior – Clad doors available in heavy-duty extruded aluminum cladding; primed doors offer an assortment of traditional cellular PVC trim options

Clad Colors

All clad colors painted in-house with the highly durable AAMA 2604 standard finish, or upgrade to AAMA 2605 for the most challenging of environments

- 23 Standard Clad Colors available in 2604 and 2605 finish
- 20 Feature Clad Colors available in 2604 and 2605 finish (Custom color matching is also available)
- 7 Matte Clad Colors available in the 2604 finish only

Hardware

Classic or contemporary handle available in white, brushed chrome, polished chrome, satin nickel, antique nickel, brass, antique brass, faux bronze, oil rubbed bronze and black; Euro handle available in satin nickel and black

Performance Ratings

For current performance ratings, visit our website at windsorwindows.com and click on "Professional Information" in the menu bar



Pinnacle Sliding Patio Door

Features and Benefits

- Wood parting stops and absence of screws provide a warm, clean look
- Integral nail fin on clad doors
- Heavy-duty interlock improves air and structural performance
- Standard two-point lock for added security
- One-piece, fiberglass pultruded sill minimizes cold conduction
- Aluminum jamb covers at the head and strike jambs hide exposed screws and provide a smoother, more attractive surface
- Doors slide on two tandem, heavy-duty, end-adjustable, ball bearing rollers for years of smooth, trouble-free operation
- Improved breakaway force of panel (10 lbs) and operating force (6 lbs) provide effortless operation
- Taller sill provides excellent water performance and design pressure ratings
- Foam-backed glazing bead prevents paint and stain from bleeding
- All stiles constructed of an LVL core for a stronger, straighter, more durable door
- Panel exterior matches Pinnacle product line with consistent depth from glass to face of the panel for a clean, complementary appearance
- Panels available in traditional French or contemporary narrow stile

Sizes

- Five standard heights: 6'8", 6'10", 8'0", 9'0" and 10'0" (9'0" and 10'0" doors available in clad French slider only)
- Custom sizes available

Glazing

- Windsor Glazing System provides 3/4" double pane insulated glass; Cardinal® LoE 366 glass standard; tinted, tempered, obscure and laminated glass available
- Interior stop glazed with silicone sealant
- Custom and special glass types available

Exterior Trim

- Clad doors available with WM 180 brickmould, Williamsburg or 3-1/2" flat casing; primed doors available with WM 180 brickmould, WM 180 brickmould with flange, Williamsburg, 3-1/2" flat, 4-1/2" backband, 5-1/2" flat or plantation casing
- All prime door trims are cellular PVC

Grilles

Windsor Divided Lite (WDL) = simulated divided lite

- 7/8" and 1-1/4" Perimeter Grille (*NOT available on radius doors*)
- 7/8" and 1-1/4" Stick Grille (*Radius swing doors only*)
- 3-4" and 1" Profiled Inner Grille
- 13/16" Flat Inner Grille
- 7/8" and 1-1/4" Ogee WDL
- 5/8", 7/8", 1-1/4" and 2" Short Putty WDL
- 5/8", 7/8", 1-1/4" and 2" Short Contemporary WDL
- 3-3/8" Simulated Mid Rail
- Standard and custom grille patterns available

Finishes

- Interior – Available in Clear Select Pine, Douglas Fir or Natural Alder
 - Primed: white or black
 - Painted: white, black or gray
 - Stained: 9 color options
- Exterior – Clad doors available in heavy-duty extruded aluminum cladding; primed doors offer an assortment of traditional cellular PVC trim options

Weatherstripping

- Flexible, weatherable PVC and foam seal at the head and jambs with a pile fin-seal weatherstripping at the interlocks; pile weatherstripping also used at the bottom of the operating panel and at the ends of the interlock

Clad Colors

- All clad colors painted in-house with the highly durable AAMA 2604 standard finish, or upgrade to AAMA 2605 for the most challenging of environments
- 23 Standard Clad Colors available in 2604 and 2605 finish
 - 20 Feature Clad Colors available in 2604 and 2605 finish (Custom color matching is also available)
 - 7 Matte Clad Colors available in the 2604 finish only

Hardware

- Contemporary or Euro handle available in white, brushed chrome, polished chrome, satin nickel, antique nickel, brass*, antique brass*, faux bronze, oil rubbed bronze and black
- Flush mount handle available in satin nickel, faux bronze, black matte and oil rubbed bronze

Performance Ratings

For current performance ratings, visit our website at windsorwindows.com and click on "Professional Information" in the menu bar



Pinnacle Bi-fold Patio Door



Bi-fold doors may vary slightly in appearance and features.

Features and Benefits

- Multi-point locking system on passage panels features three-point jamb-engaged tongue system for uncompromised security
- Centor Architectural E3 bi-fold hardware system provides stability and smooth operation
- Lever handle activated head and sill twin bolt system for added security
- Wept sill system to eliminate water infiltration
- Dual weatherstrips at panel edge improve air and thermal performance
- Foam-backed glazing bead minimizes paint and stain bleeding
- Stiles constructed of an LVL core material for added strength and stability
- Panel exterior matches Pinnacle product line with consistent depth from glass to face of the panel for a clean, complementary appearance
- Panels available in traditional French or contemporary narrow stile

Sizes

- Five standard heights: 6'8", 6'10", 8'0", 9'0" and 10'0" (9'0" and 10'0" doors available in French panels only)
- Can be assembled with as few as two panels, and up to eight panels wide
- Custom sizes available

*1" profile inner grille not available on 10'0" tall doors.

Glazing

- Windsor Glazing System provides 3/4" double pane insulated glass; Cardinal® LoE 366 glass standard
- Interior stop glazed with silicone sealant
- Custom and special glass types available

Grilles

Windsor Divided Lite (WDL) = simulated divided lite

- 7/8" and 1-1/4" Perimeter Grille (*NOT available on radius doors*)
- 7/8" and 1-1/4" Stick Grille (*Radius swing doors only*)
- 3-4" and 1" Profiled Inner Grille
- 13/16" Flat Inner Grille
- 7/8" and 1-1/4" Ogee WDL
- 5/8", 7/8", 1-1/4" and 2" Short Putty WDL
- 5/8", 7/8", 1-1/4" and 2" Short Contemporary WDL
- 3-3/8" Simulated Mid Rail
- Standard and custom grille patterns available

Weatherstripping

- Two weatherstrip barriers between each panel and between panels and frame; urethane foam encased in polyethylene film around entire frame; pile weatherstripping along head and sill provide added protection

Finishes

- Interior – Available in Clear Select Pine, Douglas Fir or Natural Alder
 - Primed: white or black
 - Painted: white, black or gray
 - Stained: 9 color options
- Exterior – Heavy-duty extruded aluminum cladding

Clad Colors

- All clad colors painted in-house with the highly durable AAMA 2604 standard finish, or upgrade to AAMA 2605 for the most challenging of environments
- 23 Standard Clad Colors available in 2604 and 2605 finish
 - 20 Feature Clad Colors available in 2604 and 2605 finish (Custom color matching is also available)
 - 7 Matte Clad Colors available in the 2604 finish only

Hardware

Classic or contemporary handle available in satin nickel, brass and oil rubbed bronze

Performance Ratings

For current performance ratings, visit our website at windsorwindows.com and click on "Professional Information" in the menu bar

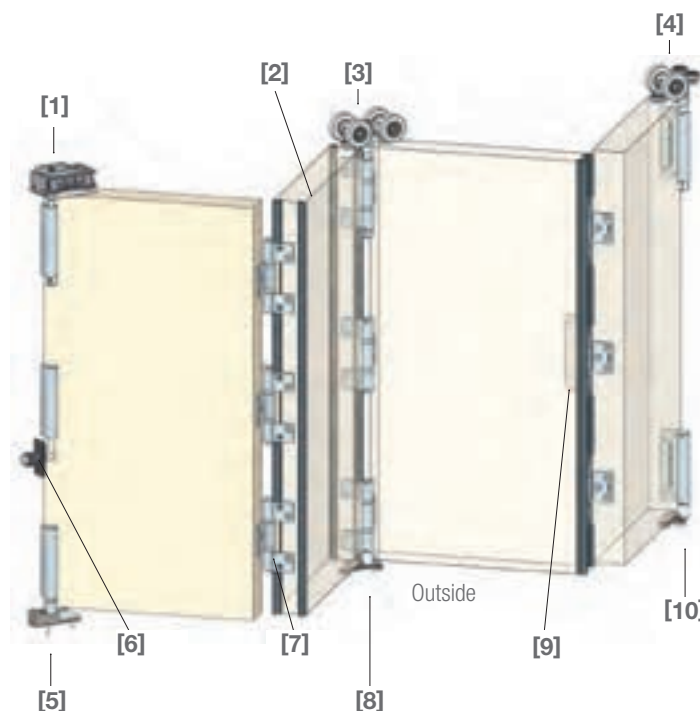

BI-FOLD DOOR TERMINOLOGY

- [1] Top pivot
- [2] Weatherseal
- [3] Intermediate carrier
- [4] End carrier
- [5] Concealed bottom pivot
- [6] Wall pivot
- [7] Hinge
- [8] Concealed intermediate guide
- [9] Hinge with handle
- [10] Concealed end guide

Pinnacle Multi-slide Patio Door

Features and Benefits

- Stacking and pocket configurations
 - Stacking multi-slide door systems stack all panels in line with the stack stationary panel when the panels are in the fully-open position; in the stacking configuration, all panels are still visible
 - Pocketed multi-slide door systems incorporate a pocket in the wall cavity to conceal all panels when they are in the fully-open position; in the pocketed configuration, all panels are hidden in the pocket
- Door jamb widths vary depending on the number of panels in the multi-slide system and handing
- One panel (pocket only) to eight panel configurations with maximum 32'0" frame width
- Main frame head jamb and sill use dark bronze anodized aluminum extrusions with powder paint color-matched frame nosing and pocket covers
- Folding aluminum nailing fins applied
- Pinnacle 1-3/4" thick sliding patio door panels
- Heavy-duty interlock improves air and structural performance
- Panels slide on two tandem, heavy-duty, end-adjustable ball bearing rollers for years of smooth, trouble-free operation
- Standard Pinnacle patio door IG options available
- Standard Pinnacle patio door grille options available

Sizes

- Standard heights
 - French panels: 6'8", 6'10", 8'0", 9'0", 10'0"
 - Narrow panels: 6'8", 6'10", 8'0"
- Panel width callouts: 2'6", 3'0", 4'0"
- Maximum frame width: 32'0"

Glazing

- 3/4" double pane LoE 366 Cardinal® IG standard; tinted, obscure and laminated glass available
- Interior stop glazed with tape and silicone

Grilles

Windsor Divided Lite (WDL) = simulated divided lite

- 7/8" and 1-1/4" Perimeter Grille (*NOT available on radius doors*)
- 7/8" and 1-1/4" Stick Grille (*Radius swing doors only*)
- 3-4" and 1" Profiled Inner Grille
- 13/16" Flat Inner Grille
- 7/8" and 1-1/4" Ogee WDL
- 5/8", 7/8", 1-1/4" and 2" Short Putty WDL
- 5/8", 7/8", 1-1/4" and 2" Short Contemporary WDL
- 3-3/8" Simulated Mid Rail
- Standard and custom grille patterns available

Finishes

- Interior – Available in Clear Select Pine, Douglas Fir or Natural Alder
 - Primed: white or black
 - Painted: white, black or gray
 - Stained: 9 color options
- Exterior – Doors standard with heavy-duty extruded aluminum cladding

Clad Colors

All clad colors painted in-house with the highly durable AAMA 2604 standard finish, or upgrade to AAMA 2605 for the most challenging of environments

- 23 Standard Clad Colors available in 2604 and 2605 finish
- 20 Feature Clad Colors available in 2604 and 2605 finish (Custom color matching is also available)
- 7 Matte Clad Colors available in the 2604 finish only

Hardware

- Pinnacle sliding patio door end-adjustable roller system
- Pinnacle sliding patio door two-point locking gear and keeper
- Flush mount handles standard on pocket and stacking door systems; available in oil rubbed bronze, faux bronze, black and satin nickel (*figure 1*)
- Flush mount handles standard with a keyed lock
- All panels standard with satin nickel finger pull located at the edge of the lead operating panel (*figure 2*)



Fig. 1



Fig. 2



All applications using multi-slide door systems require outdoor overhangs equal to or greater than the height of the multi-slide door.

When using the staggered sill option, a mop zone on the interior of the door is highly recommended, as this application can experience water infiltration under certain conditions.

Pinnacle High-Performance PG Rated Products

Our high-performance double hung windows offer innovative design features such as a deep sill stop, reinforced stress points that guard against water and wind damage and special warm-edge characteristics to reduce condensation.

Features and Benefits

- The warmth and beauty of Clear Select Pine, Douglas Fir or Natural Alder; can be painted or stained
- Clad units offer a strong, durable extruded aluminum sash and frame for low maintenance; primed units offer the traditional appearance of decorative trim
- Glass is replaceable in case of damage
- Both tape and silicone glazed, with interior wood stops for superior strength and seal
- EZ Tilt operation available for easy removal and replacement of sash
- Recessed lock and keeper for a sleek appearance
- Block and tackle balance system for ease of operation
- Both sashes tilt in with compression or concealed jambliner for easy cleaning
- No-finger pull option for hardware application

Sizes

Available in hundreds of standard and custom sizes



EZ Tilt operation available for easy removal and replacement of sash

Recessed lock and keeper for a sleek appearance

Glazing

- Windsor Glazing System provides 3/4" double pane insulated glass; Cardinal® LoE 366 glass standard; tinted, tempered, obscure and laminated glass available
- Glazed with tape and silicone sealant
- Custom and special glass types available
- Preserve protective film optional

Exterior Trim

- Clad windows available with WM 180 brickmould or Williamsburg casing; primed windows available with WM 180 brickmould, WM 180 brickmould with flange, Williamsburg, 3-1/2" flat, 4-1/2" backband, 5-1/2" flat or plantation casing; double hung sill nose, 2" bull nose sill nose or belly sill nose
- All prime window trims, subsills and sill noses are cellular PVC

Grilles

Windsor Divided Lite (WDL) = simulated divided lite

- 7/8" and 1-1/4" perimeter grille
- 7/8" and 1-1/4" stick grille
- 3/4" and 1" profiled inner grille
- 13/16" flat inner grille
- 7/8" and 1-1/4" interior wood WDL
- 7/8" and 1-1/4" exterior clad WDL
- 7/8" and 1-1/4" exterior CPVC WDL (primed)
- 5/8" and 7/8" short putty WDL
- 7/8", 1-1/4" and 2" contemporary WDL (interior only)
- 2" exterior low profile simulated check rail
- 2" CPVC simulated check rail (primed)
- Standard and custom grille patterns available



Finishes

- Interior – Available in Clear Select Pine, Douglas Fir or Natural Alder
 - Primed: white or black
 - Painted: white, black or gray
 - Stained: 9 color options
- Exterior – Clad windows feature heavy-duty extruded aluminum cladding on sash and frame; primed windows offer an assortment of traditional cellular PVC trim options

Clad Colors

All clad colors painted in-house with the highly durable AAMA 2604 standard finish, or upgrade to AAMA 2605 for the most challenging of environments

- 23 Standard Clad Colors available in 2604 and 2605 finish
- 20 Feature Clad Colors available in 2604 and 2605 finish (Custom color matching is also available)
- 7 Matte Clad Colors available in the 2604 finish only

Hardware

Double hung lock available in champagne, white, bronze and black; optional finishes in faux bronze, oil rubbed bronze, satin nickel and bright brass

Performance Ratings and Certification

For current performance ratings, visit our website at windsorwindows.com and click on "Professional Information" in the menu bar

- Performance rated to DP 50 overall; structural rating exceeds DP 50; Florida Building Commission approved; exception Dade-Broward small missile
- Visit floridabuilding.org for more information; including section details and installation

Windsor's High-Performance DP Rated Products

Pinnacle, Legend and Legend HBR:

- Casement and awning
- Casement and awning picture
- Double hung
- Double hung picture

Pinnacle Select Impact Casement & Awning

Features and Benefits

- Clear Select Pine, Douglas Fir or Natural Alder interior
- Constructed with 2-5/16" wide stiles and rails that add structural stability and provide a more massive architectural appearance
- Robust 2-3/16" thick sash adds dimension and strength
- Double mortise and tenon sash joints fastened with screws for strength and stability
- Select casement and awning available in two styles
 - Operating: standard crank
 - Push-out: lever handle
- Retractable screens available on operating and push-out products; pull bar, cartridge case and frame of screen produced from same wood species as window



- Full-width extension jambs standard
- Push-out hardware consists of an easy-to-operate lever with cam rollers and keepers; this mechanism provides a multi-point locking system that is standard*



- Push-outs equipped with adjustable friction hinges and lock rollers in both casement and awning
- Friction device on larger push-out awning maintains sash opening
- Operating casement uses adjustable hinges
- Certified against hurricane blasts: Laminated glass allows unit to crack instead of shatter when under great pressure
- Meets and exceeds building codes for extreme coastal environment conditions
- Laminated glass dampens sounds from traffic, neighbors and the outdoors
- Preserve protective film standard

Sizes

Available in hundreds of standard and custom sizes

Glazing

- Glazed with tape and Dow Corning® 955 silicone sealant – the strongest silicone bonding agent available
- Cardinal Sea-Storm® LoE 366 insulated glass standard, featuring stainless steel spacers; tinted, tempered and laminated glass available
- Custom and special glass types available
- Insulated glass utilizes annealed glass on exterior and laminated glass on interior
- Laminated glass features PVB inner layer on operating units with optional SGP inner layer; fixed units feature SGP inner layer

Exterior Trim

- Clad windows available with WM 180 brickmould, Williamsburg or 3-1/2" flat casing; 3/8", 1-1/4" and 2-1/4" subsill available

Grilles

Windsor Divided Lite (WDL) = simulated divided lite

- 7/8" and 1-1/4" Perimeter Grille (*NOT available on radius casements*)
- 7/8" and 1-1/4" Stick Grille
- 3/4" and 1" Profiled Inner Grille
- 13/16" Flat Inner Grille
- 7/8" and 1-1/4" Ogee WDL

- 5/8", 7/8", 1-1/4" and 2" Tall and Short Putty WDL
- 5/8", 7/8", 1-1/4" and 2" Tall and Short Contemporary WDL
- 2" Simulated Check Rail
- Standard and custom grille patterns available

Finishes

- Interior – Available in Clear Select Pine, Douglas Fir or Natural Alder
 - Primed: white or black
 - Painted: white, black or gray
 - Stained: 9 color options
- Exterior – Clad windows feature heavy-duty extruded aluminum cladding on sash and frame

Clad Colors

All clad colors painted in-house with the highly durable AAMA 2604 standard finish, or upgrade to AAMA 2605 for the most challenging of environments

- 23 Standard Clad Colors available in 2604 and 2605 finish
- 20 Feature Clad Colors available in 2604 and 2605 finish (Custom color matching is also available)
- 7 Matte Clad Colors available in the 2604 finish only

Hardware

- Encore folding nesting crank and cover by Truth® available in champagne, white, bronze and black; optional finishes in faux bronze, oil rubbed bronze, satin nickel and bright brass. Push-out available in white, black, faux bronze, satin nickel or oil rubbed bronze
- Units come standard with Seacoast upgraded hinges and locking hardware

Performance Ratings

For current performance ratings, visit our website at windsorwindows.com and click on "Professional Information" in the menu bar

Pinnacle Clad Impact Casement & Awning

Features and Benefits

- Clear Select Pine interior
- Clad units offer a strong, durable extruded aluminum sash and frame for low maintenance
- Glass is replaceable in case of damage
- 2" thick sash adds beauty and increases insulating value
- Exterior tape glazing slows conduction of heat/cold through edge of glass; two beads of silicone ensure a water tight seal that creates three seals between glass and sash
- Single lever, sequential, multi-point lock for sleek look and easy operation

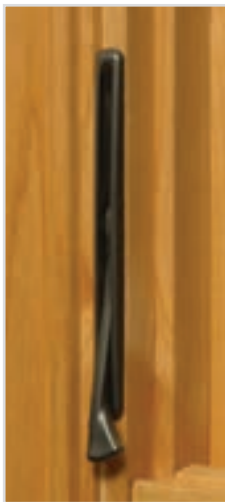

- Adjustable concealed hinge system ensures smooth operation
- 1-1/4" jamb creates unmatched strength and stability
- Silicone-injected frame corners create a stronger and more attractive joint
- Certified against hurricane blasts: Laminated glass allows unit to crack instead of shatter when under great pressure
- Meets and exceeds building codes for extreme coastal environment conditions
- Laminated glass dampens sounds from traffic, neighbors and the outdoors
- Preserve protective film standard

Sizes

Available in hundreds of standard and custom sizes

Glazing

- Glazed with tape and Dow Corning® 955 silicone sealant – the strongest silicone bonding agent available
- Cardinal Sea-Storm® LoE 366 insulated glass standard, featuring stainless steel spacers; tinted, tempered and laminated glass available
- Custom and special glass types available
- Insulated glass utilizes annealed glass on exterior and laminated glass on interior
- Laminated glass features PVB inner layer on operating units and SGP inner layer on fixed units

Exterior Trim

- Clad windows available with WM 180 brickmould, Williamsburg or 3-1/2" flat casing; 3/8", 1-1/4" and 2-1/4" subsill available

Grilles

Windsor Divided Lite (WDL) = simulated divided lite

- 7/8" and 1-1/4" Perimeter Grille (*NOT available on radius casements*)
- 7/8" and 1-1/4" Stick Grille
- 3/4" and 1" Profiled Inner Grille
- 13/16" Flat Inner Grille
- 7/8" and 1-1/4" Ogee WDL
- 5/8", 7/8", 1-1/4" and 2" Tall and Short Putty WDL
- 5/8", 7/8", 1-1/4" and 2" Tall and Short Contemporary WDL
- 2" Simulated Check Rail
- Standard and custom grille patterns available

Finishes

- Interior – Available in Clear Select Pine
 - Primed: white or black
 - Painted: white, black or gray
 - Stained: 9 color options
- Exterior – Clad windows feature heavy-duty extruded aluminum cladding on sash and frame

Clad Colors

All clad colors painted in-house with the highly durable AAMA 2604 standard finish, or upgrade to AAMA 2605 for the most challenging of environments

- 23 Standard Clad Colors available in 2604 and 2605 finish
- 20 Feature Clad Colors available in 2604 and 2605 finish (Custom color matching is also available)
- 7 Matte Clad Colors available in the 2604 finish only

Hardware

- Encore folding nesting crank and cover by Truth® available in champagne, white, bronze and black; optional finishes in faux bronze, oil rubbed bronze, satin nickel and bright brass
- Units come standard with Seacoast upgraded hinges and locking hardware

Performance Ratings

For current performance ratings, visit our website at windsorwindows.com and click on "Professional Information" in the menu bar



Pinnacle Clad Impact Double Hung

Features and Benefits

- Clear Select Pine interior
- Clad units offer a strong, durable extruded aluminum sash and frame for low maintenance
- Glass is replaceable in case of damage
- EZ Tilt operation available for easy removal and replacement of sash (double hung only)



- Recessed lock and keeper for a sleek appearance



- Block and tackle balance system for ease of operation
- No-finger pull option for hardware application
- Certified against hurricane blasts: Laminated glass allows unit to crack instead of shatter when under great pressure
- Meets and exceeds building codes for extreme coastal environment conditions
- Laminated glass dampens sounds from traffic, neighbors and the outdoors
- Preserve protective film standard
- Head frame corners will be secured with corner keys, injected silicone and screws for improved stability
- A new, full-size, inverted block and tackle balance provides support for a heavier sash
- Jamb jacks provide the ability to make future adjustments after settling
- A trim identification line on the side and head inside stops provides easy alignment during installation

- Exterior jamb covers are available in finishes that match the aluminum, while interior species matches jamb covers, providing an all wood interior look



Sizes

Available in hundreds of standard and custom sizes

Glazing

- Glazed with tape and Dow Corning® 955 silicone sealant – the strongest silicone bonding agent available
- Cardinal Sea-Storm® LoE 366 insulated glass standard, featuring stainless steel spacers; tinted, tempered and laminated glass available
- Custom and special glass types available
- Insulated glass utilizes annealed glass on exterior and laminated glass on interior
- Laminated glass features PVB inner layer on operating units and SGP inner layer on picture units

Exterior Trim

- Clad windows available with WM 180 brickmould, Williamsburg or 3-1/2" flat casing; 3/8", 1-1/4" and 2-1/4" subsill available

Grilles

Windsor Divided Lite (WDL) = simulated divided lite

- 7/8" and 1-1/4" Perimeter Grille (*NOT available on radius double hung*)
- 7/8" and 1-1/4" Stick Grille
- 3/4" and 1" Profiled Inner Grille
- 13/16" Flat Inner Grille
- 7/8v and 1-1/4" Ogee WDL
- 5/8", 7/8", 1-1/4" and 2" Short Putty WDL
- 5/8", 7/8", 1-1/4" and 2" Short Contemporary WDL
- 2" Simulated Check Rail (*DH picture only*)
- Standard and custom grille patterns available

Finishes

- Interior – Available in Clear Select Pine
 - Primed: white or black
 - Painted: white, black or gray
 - Stained: 9 color options
- Exterior – Clad windows feature heavy-duty extruded aluminum cladding on sash and frame

Clad Colors

All clad colors painted in-house with the highly durable AAMA 2604 standard finish, or upgrade to AAMA 2605 for the most challenging of environments

- 23 Standard Clad Colors available in 2604 and 2605 finish
- 20 Feature Clad Colors available in 2604 and 2605 finish (Custom color matching is also available)
- 7 Matte Clad Colors available in the 2604 finish only

Hardware

Double hung lock available in champagne, white, bronze and black; optional finishes in faux bronze, oil rubbed bronze, satin nickel and bright brass

Performance Ratings

For current performance ratings, visit our website at windsorwindows.com and click on "Professional Information" in the menu bar



Pinnacle Clad Impact Direct Set & Radius

Features and Benefits

- Clear Select Pine interior
- Clad units offer a strong, durable extruded aluminum frame for low maintenance
- Glass is replaceable in case of damage
- 1-1/4" frame on direct set and 3/4" frame on radius/low profile direct set creates unmatched strength and stability
- Silicone-injected frame corners create a stronger and more attractive joint
- Certified against hurricane blasts: Laminated glass allows unit to crack instead of shatter when under great pressure
- Meets and exceeds building codes for extreme coastal environment conditions
- Laminated glass dampens sounds from traffic, neighbors and the outdoors
- Preserve protective film standard

Glazing

- Glazed with tape and Dow Corning® 955 silicone sealant – the strongest silicone bonding agent available
- Cardinal Sea-Storm® LoE 366 insulated glass standard, featuring stainless steel spacers; tinted, tempered and laminated glass available
- Custom and special glass types available
- Insulated glass utilizes annealed glass on exterior and laminated glass on interior
- Laminated glass features SGP inner layer

Exterior Trim

- Clad windows available with WM 180 brickmould, clad extruded Williamsburg and 3-1/2" flat casing (*direct set only*); 3/8", 1-1/4" and 2-1/4" subsill available

Grilles

Windsor Divided Lite (WDL) = simulated divided lite

- 7/8" and 1-1/4" Stick Grille
- 3/4" and 1" Profiled Inner Grille
- 13/16" Flat Inner Grille
- 7/8" and 1-1/4" Ogee WDL
- 5/8", 7/8", 1-1/4" and 2" Tall and Short Putty WDL
- 5/8", 7/8", 1-1/4" and 2" Tall and Short Contemporary WDL
- 2" Simulated Check Rail (*Direct set only*)
- Standard and custom grille patterns available

Finishes

- Interior – Available in Clear Select Pine
 - Primed: white or black
 - Painted: white, black or gray
 - Stained: 9 color options
- Exterior – Clad windows feature heavy-duty extruded aluminum cladding on frame

Clad Colors

All clad colors painted in-house with the highly durable AAMA 2604 standard finish, or upgrade to AAMA 2605 for the most challenging of environments

- 23 Standard Clad Colors available in 2604 and 2605 finish
- 20 Feature Clad Colors available in 2604 and 2605 finish (Custom color matching is also available)
- 7 Matte Clad Colors available in the 2604 finish only

Performance Ratings

For current performance ratings, visit our website at windsorwindows.com and click on "Professional Information" in the menu bar



Pinnacle Impact Featuring Sea-Storm® Glass

Pinnacle Impact is available in casement, awning, double hung, radius, direct set, French sliding patio doors and swinging patio doors.

Features and Benefits

- Clear Select Pine interior
- Clad units offer a strong, durable extruded aluminum sash and frame for low maintenance; Impact double hung units require higher inside stop
- Glass is replaceable in case of damage
- Specialty windows available in a wide variety of direct set and radius styles
- Certified, proven-safe solution against hurricane blasts; laminated glass allows unit to crack instead of shatter when under great pressure
- Meets and exceeds modern building codes for extreme coastal environment conditions
- Dampens sounds from traffic, neighbors and the outdoors
- Resistant to interior fading from constant sunlight
- Offers security against intruders with shatterproof and cutter-deterring glass
- Preserve protective film standard

Sizes

Available in hundreds of standard and custom sizes

Glazing

- Glazed with tape and Dow Corning® 955 silicone sealant – the strongest silicone bonding agent available
- Cardinal Sea-Storm® LoE 366 insulated glass standard, featuring stainless steel spacers; tinted, tempered and laminated glass available
- Custom and special glass types available
- Insulated glass utilizes annealed glass on exterior and laminated glass on interior
- Laminated glass features PVB inner layer on units up to 26 square feet and SGP inner layer on units over 26 square feet

Grilles

Windsor Divided Lite (WDL) = simulated divided lite

- 7/8" and 1-1/4" perimeter grille
- 7/8" and 1-1/4" stick grille
- 3/4" and 1" profiled inner grille
- 13/16" flat inner grille
- 7/8" and 1-1/4" interior wood WDL
- 7/8" and 1-1/4" exterior clad WDL
- 5/8" and 7/8" tall putty WDL
- 5/8" and 7/8" short putty WDL
- 7/8", 1-1/4" and 2" contemporary WDL (interior only)
- 2" tall putty simulated check rail
- 2" exterior low profile simulated check rail
- Standard and custom grille patterns available

Finishes

- Interior – Available in Clear Select Pine
 - Primed: white or black
 - Painted: white, black or gray
 - Stained: 9 color options
- Exterior – Clad units available in heavy-duty extruded aluminum cladding

Clad Colors

All clad colors painted in-house with the highly durable AAMA 2604 standard finish, or upgrade to AAMA 2605 for the most challenging of environments

- 23 Standard Clad Colors available in 2604 and 2605 finish
- 20 Feature Clad Colors available in 2604 and 2605 finish (Custom color matching is also available)
- 7 Matte Clad Colors available in the 2604 finish only

Hardware

- Casement, awning and double hung hardware available in champagne, white, bronze and black; optional finishes in faux bronze, oil rubbed bronze, satin nickel and bright brass
- Patio door handles available in white, brushed chrome, polished chrome, satin nickel, antique nickel, brass, antique brass, faux bronze, oil rubbed bronze and black

Performance Ratings

For current performance ratings, visit our website at windsorwindows.com and click on "Professional Information" in the menu bar

Certification

Performance rated to DP 50 overall; structural rating exceeds DP 50; Florida Building Commission approved; exception Dade-Broward small missile
Visit floridabuilding.org for more information; including section details and installation

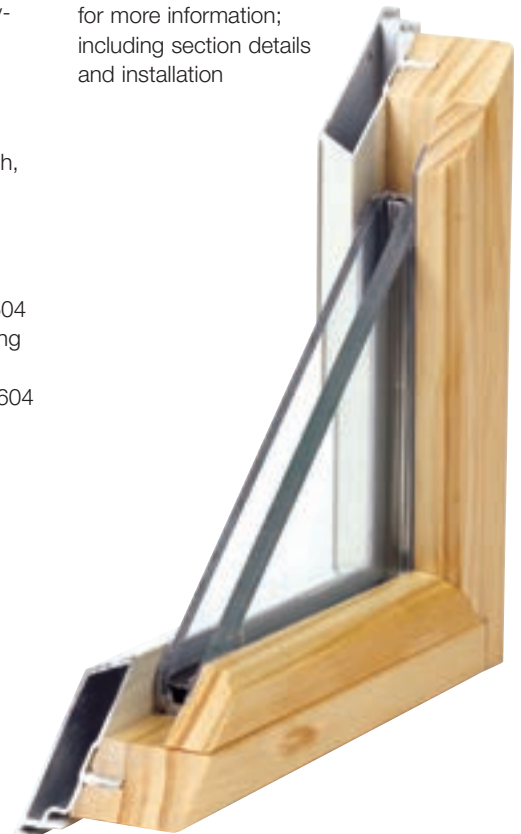

Pinnacle Clad French Impact Swinging Patio Door

Features and Benefits

- Stainless steel multi-point locking hardware option for added security
- “Easy Adjust” hinge system for effortless operation and correction after installation
- Wept sill system to eliminate water infiltration
- Dual-seal frame weatherstripping at panel face and edge improves air and thermal performance
- Taller sill provides excellent water performance and design pressure ratings
- Active stiles constructed of an LVL core material for added strength and stability
- In-swing and out-swing options available
- Seg-top available
- Certified against hurricane blasts: Laminated glass allows unit to crack instead of shatter when under great pressure
- Meets and exceeds building codes for extreme coastal environment conditions
- Laminated glass dampens sounds from traffic, neighbors and the outdoors
- Preserve protective film standard

Sizes

- Five standard heights: 6'8", 6'10", 8'0"
- Custom sizes available

Glazing

- Glazed with tape and Dow Corning® 955 silicone sealant – the strongest silicone bonding agent available

- Cardinal Sea-Storm® LoE366 insulated glass standard, featuring stainless steel spacers; tinted, tempered and laminated glass available
- Custom and special glass types available
- Insulated glass utilizes tempered glass on exterior and laminated glass on interior

Exterior Trim

- Clad doors available with WM 180 brickmould, Williamsburg or 3-1/2" flat casing

Grilles

Windsor Divided Lite (WDL) = simulated divided lite

- 7/8" and 1-1/4" Perimeter Grille (*NOT available on radius doors*)
- 7/8" and 1-1/4" Stick Grille (*Radius swing doors only*)
- 3/4" and 1" Profiled Inner Grille
- 13/16" Flat Inner Grille
- 7/8" and 1-1/4" Ogee WDL
- 5/8", 7/8", 1-1/4" and 2" Short Putty WDL
- 5/8", 7/8", 1-1/4" and 2" Short Contemporary WDL
- 3-3/8" Simulated Mid Rail
- Standard and custom grille patterns available

Weatherstripping

- Rigid, weatherable PVC or urethane foam encased in polyethylene film
- In-swing and out-swing doors feature bottom heavy-duty, self-adjusting sweep

Finishes

- Interior – Available in Clear Select Pine
 - Primed: white or black
 - Painted: white, black or gray
 - Stained: 9 color options
- Exterior – Clad doors available in heavy-duty extruded aluminum cladding

Clad Colors

All clad colors painted in-house with the highly durable AAMA 2604 standard finish, or upgrade to AAMA 2605 for the most challenging of environments

- 23 Standard Clad Colors available in 2604 and 2605 finish
- 20 Feature Clad Colors available in 2604 and 2605 finish (Custom color matching is also available)
- 7 Matte Clad Colors available in the 2604 finish only

Hardware

Classic, contemporary or euro handle available in white, brushed chrome, polished chrome, satin nickel, antique nickel, brass, antique brass, faux bronze, oil rubbed bronze and black; Euro handle available in satin nickel and black

Performance Ratings

For current performance ratings, visit our website at windsorwindows.com and click on "Professional Information" in the menu bar



Pinnacle Clad French Impact Sliding Patio Door

Features and Benefits

- Wood parting stops and absence of screws provide a warm, clean look
- Integral nail fin on clad doors
- Heavy-duty interlock improves air and structural performance
- Standard two-point lock for added security
- One-piece, fiberglass pultruded sill minimizes cold conduction
- Aluminum jamb covers at the head and strike jambs hide exposed screws and provide a smoother, more attractive surface



- Doors slide on two tandem, heavy-duty, end-adjustable, ball bearing rollers for years of smooth, trouble-free operation
- Improved breakaway force of panel (10 lbs) and operating force (6 lbs) provide effortless operation
- Taller sill provides excellent water performance and design pressure ratings
- All stiles constructed of an LVL core for a stronger, straighter, more durable door
- Certified against hurricane blasts: Laminated glass allows unit to crack instead of shatter when under great pressure
- Meets and exceeds building codes for extreme coastal environment conditions
- Laminated glass dampens sounds from traffic, neighbors and the outdoors
- Preserve protective film standard

Sizes

- Five standard heights: 6'8", 6'10" and 8'0"
- Custom sizes available

Glazing

- Glazed with tape and Dow Corning® 955 silicone sealant – the strongest silicone bonding agent available
- Cardinal Sea-Storm® LoE366 insulated glass standard, featuring stainless steel spacers; tinted, tempered and laminated glass available
- Custom and special glass types available
- Insulated glass utilizes tempered glass on exterior and laminated glass on interior

Exterior Trim

- Clad doors available with WM 180 brickmould, Williamsburg or 3-1/2" flat casing

Grilles

Windsor Divided Lite (WDL) = simulated divided lite

- 7/8" and 1-1/4" Perimeter Grille (*NOT available on radius doors*)
- 7/8" and 1-1/4" Stick Grille (*Radius swing doors only*)
- 3/4" and 1" Profiled Inner Grille
- 13/16" Flat Inner Grille
- 7/8" and 1-1/4" Ogee WDL
- 5/8", 7/8", 1-1/4" and 2" Short Putty WDL
- 5/8", 7/8", 1-1/4" and 2" Short Contemporary WDL
- 3-3/8" Simulated Mid Rail
- Standard and custom grille patterns available

Finishes

- Interior – Available in Clear Select Pine
 - Primed: white or black
 - Painted: white, black or gray
 - Stained: 9 color options
- Exterior – Clad doors available in heavy-duty extruded aluminum cladding; primed doors offer an assortment of traditional trim options

Weatherstripping

- Flexible, weatherable PVC and foam seal at the head and jambs with a pile fin-seal weatherstripping at the interlocks; pile weatherstripping also used at the bottom of the operating panel and at the ends of the interlock

Clad Colors

All clad colors painted in-house with the highly durable AAMA 2604 standard finish, or upgrade to AAMA 2605 for the most challenging of environments

- 23 Standard Clad Colors available in 2604 and 2605 finish
- 20 Feature Clad Colors available in 2604 and 2605 finish (Custom color matching is also available)
- 7 Matte Clad Colors available in the 2604 finish only

Hardware

Contemporary or Euro handle available in white, brushed chrome, polished chrome, satin nickel, antique nickel, brass, antique brass, faux bronze, oil rubbed bronze and black

Performance Ratings

For current performance ratings, visit our website at windsorwindows.com and click on "Professional Information" in the menu bar



Options & Accessories

Finishing touches to perfect your vision. Windsor does more than just create durable, high-performance windows and doors. We pay attention to every detail and offer a wide array of options and finishes to match any décor. Flashy and eye-catching or simple and understated, our hardware, finishes, grille options, cladding colors, glass options and trim options complete the perfect window and door package.

Windsor's in-house powder paint application can help you make a statement with your windows and doors. Choose from over 50 shades in our standard and feature color palettes, or make it truly unique with custom color matching or our matte finish colors. All paints are protected with the highly durable 2604¹ finish, or you can upgrade to 2605² for even stronger defense against the elements.³

STANDARD CLAD COLORS Pinnacle Windows | Pinnacle Select Windows | Pinnacle Patio Doors | Pinnacle Select Patio Doors

Available in 2604 and 2605 finish.



FEATURE CLAD COLORS Pinnacle Windows | Pinnacle Select Windows | Pinnacle Patio Doors | Pinnacle Select Patio Doors

Available in 2604 and 2605 finish. (Custom color matching is also available)



MATTE CLAD COLORS

Pinnacle Windows | Pinnacle Select Windows | Pinnacle Patio Doors | Pinnacle Select Patio Doors

Available in 2604 finish only.



Matte Tan Matte Desert Dust Matte Bronze Matte Sable Matte Slate Gray Matte Charcoal Gray Matte Black

¹AAMA 2604 finish backed by a 20-year warranty. ²AAMA 2605 finish backed by a 30-year warranty. ³For applications within one mile of the coast, AAMA 2605 finish will carry a 10-year warranty and AAMA 2604 will carry no warranty. For specific warranty details, please refer to the complete warranty document posted on our website, www.windsorwindows.com.

INTERIOR FINISHES

Pinnacle Windows | Pinnacle Select Windows | Pinnacle Patio Doors

Interior Wood Species

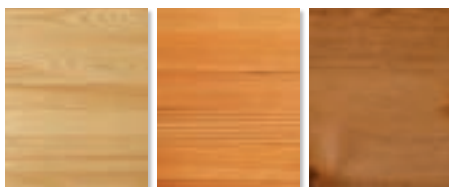

Clear Select Pine Douglas Fir Natural Alder

Interior Primed Finishes

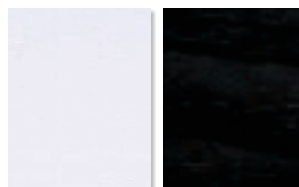

White Primed* Black Primed*
*(*Available in Clear Select Pine only)*

Prefinished Painted Interiors

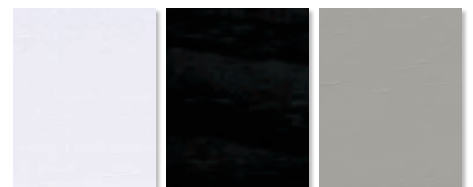

Painted White Painted Black Painted Gray

Prefinished Stained Interiors

CLEAR COAT AND STAIN SAMPLES ARE SHOWN ON CLEAR SELECT PINE AND REPRESENT OPTIONS AVAILABLE. ACTUAL FINISH MAY VARY.

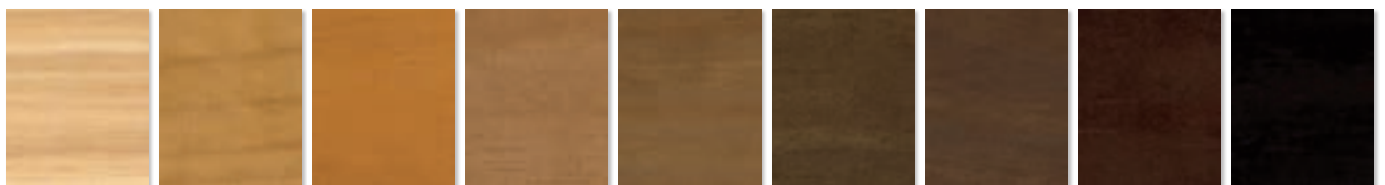

Clear Sunlight Provincial Tea with Milk Antique Barrel Perfect Brown Intensive Chestnut Espresso

WINDOW HARDWARE AND FINISHES Pinnacle Windows



Traditional Casement/Awning Crank



Contemporary Casement/Awning Crank



Double Hung Lock



Champagne

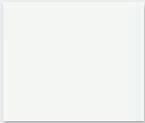

White

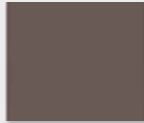

Bronze

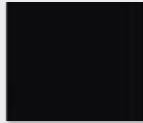

Black

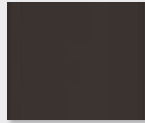

Faux Bronze

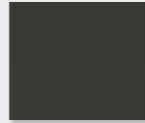

Oil Rubbed
Bronze

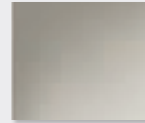

Satin Nickel

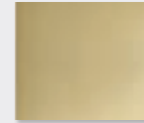

Bright Brass

WINDOW HARDWARE AND FINISHES Pinnacle Select Windows



Traditional Casement/Awning Crank



Champagne

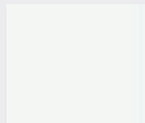

White



Bronze

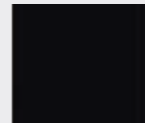

Black



Contemporary Casement/Awning Crank



Faux Bronze



Oil Rubbed
Bronze

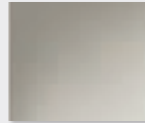

Satin Nickel

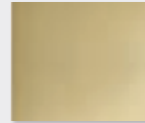

Bright Brass



Push-out (Lever)

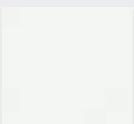

White



Black



Faux Bronze

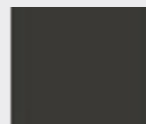

Oil Rubbed
Bronze

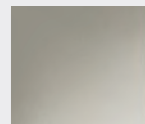

Satin Nickel

INTERIOR TRIM

Pinnacle Windows | Pinnacle Select Windows | Pinnacle Patio Doors

Custom-fitted wood trim is available in Clear Select Pine, Douglas Fir and Natural Alder. (All photos shown in Clear Select Pine.)

Interior Trim



WM 327 • 2-1/4"



WM 356 • 2-1/4"



WM 366 • 2-1/4"



WM 351 • 2-1/2"



WM 361 • 2-1/2"



WM 445 • 3-1/4"



WM 444 • 3-1/2"



RB 03 • 3-1/2"



WM 473 • 2-1/4"



WM 433 • 3-1/4"



WM 412 • 3-1/2"

Stool and Apron

Only Available in double or single hung windows



WM 1021 • 5-1/4"



B 200 • 11/16" x 2-1/2"

Rosettes



Rosette • 2-3/4"



Rosette • 3-3/4"

EXTERIOR WINDOW TRIM

Cellular PVC Exterior Sill Options Pinnacle Windows (For Primed exterior finishes only)



Double Hung
Sill Nose



2" Bull Nose
Sill Nose



Belly
Sill Nose



Casement
Subsill



2" Casement
Subsill



Half Round/Ellipse Sill
Nose (*Radius only*)

Cellular PVC Exterior Casing Options Pinnacle Windows (For Primed exterior finishes only)



WM 180
Brickmould



WM 180 Brickmould
with Flange



Williamsburg



3-1/2" Flat



4-1/2" Backband



5-1/2" Flat



Plantation (3-1/2" Side; 5-1/2" Head)

Clad Exterior Casing Options Pinnacle Windows | Pinnacle Select Windows | Pinnacle Patio Doors



WM 180 Brickmould



WM 180 Solid Back
Brickmould



Williamsburg



3-1/2"
Flat

Pinnacle Windows



3/8" Subsill



1-1/4" Subsill



2-1/4" Subsill



Traditional Flush Fin
(Casement/awning with
3-1/4" frame only)



Contemporary Flush Fin
(Casement/awning with
3-1/4" frame only)

GLASS Pinnacle Windows | Pinnacle Select Windows | Pinnacle Patio Doors

*Special order item. Units with 1-1/4" OA triple IG are only available in LoE 366/180, obscure, satin etch, glue chip, rain and reed glass.

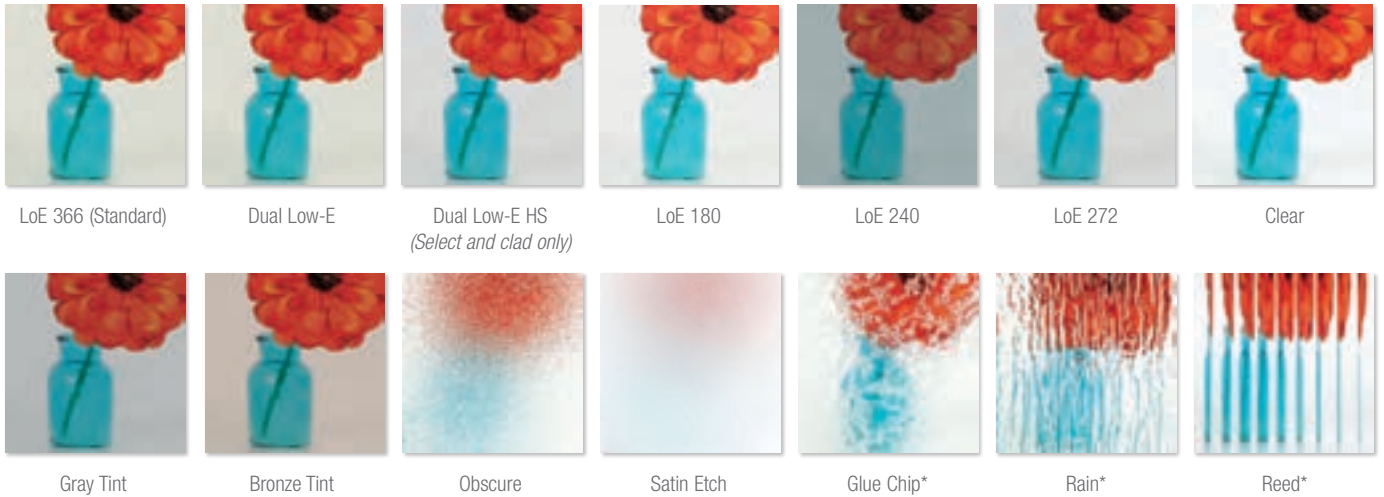

DIRECT SET AND RADIUS OPTIONS Pinnacle Windows

Before selecting a special grille pattern, confirm alignment with units below.

Radius Inner Grille Patterns

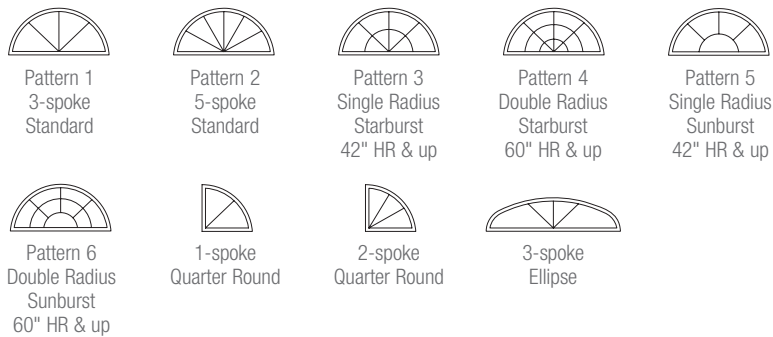

Radius Special Shapes



Direct Set Special Shapes



SCREENS Pinnacle Windows | Pinnacle Patio Doors

All exterior-applied screens for Pinnacle double hung, glide-by and sliding patio doors come with screen frames matching the clad color of the unit. Interior-applied screens for Pinnacle casement and awning windows have screen frames available in champagne, white, bronze, black, wood-veneered pine, wood-veneered alder or wood-veneered fir.

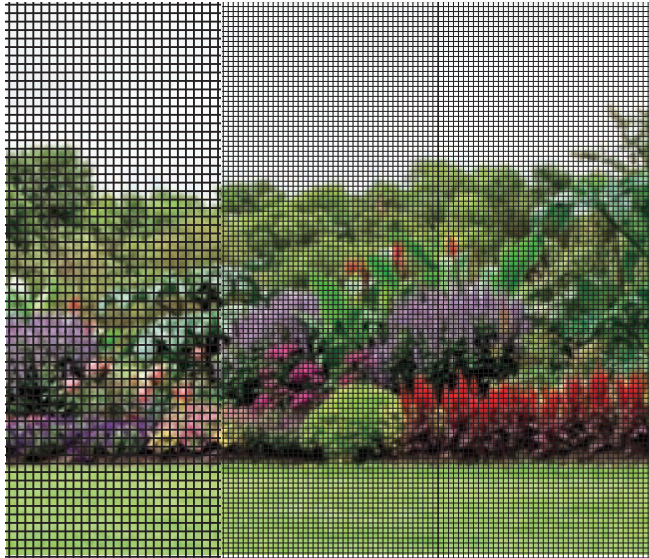

Conventional Screen Mesh

BetterVue® (Standard)

UltraVue®

SCREENS Pinnacle Select Windows

Windsor's standard BetterVue screen material provides improved visibility, airflow and insect resistance. Operating units are available with a standard screen or a retractable screen option. Standard screens are pressure mounted to fit within the frame of the window and are easily installed and removed. Push-out casements and awnings are available with a retractable screen. Retractable screens are available in pine, alder and fir wood species and have a solid wood pull at the bottom of the screen for easy operation. These spring-loaded units pull down from the top and lock into place at the sill. All interior tracks and covers come standard with species matched wood veneer.

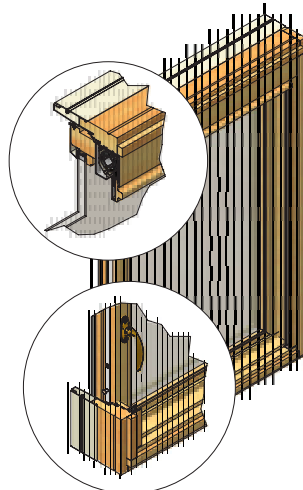

GRILLES Pinnacle Windows | Pinnacle Select Windows

All of our wood and cellular PVC (CPVC) Windsor Divided Lite bars are hand-fitted to ensure a perfect fit.



7/8" & 1-1/4"
Perimeter Grille



7/8" & 1-1/4"
Stick Grille



3/4" & 1"
Profiled Inner Grille



13/16" Flat Inner Grille
(Not available on Select)



7/8" & 1-1/4"
Exterior Clad Ogee
Windsor Divided Lite



7/8" & 1-1/4"
Exterior CPVC Ogee
Windsor Divided Lite
(Primed only)



5/8", 7/8", 1-1/4" & 2"
Tall Putty
Windsor Divided Lite



5/8", 7/8", 1-1/4" & 2"
Short Putty
Windsor Divided Lite



5/8", 7/8", 1-1/4" & 2"
Short Tall and Short
Contemporary Windsor
Divided Lite



5/8", 7/8", 1-1/4" & 2"
Tall Interior Contemporary
Windsor Divided Lite

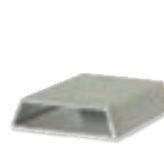

2" Tall Putty
Simulated Check Rail



2" Exterior Low Profile
Simulated Check Rail



2" CPVC Simulated
Check Rail *(Primed Interior
Finish Only)*



3-3/8"
Simulated Mid Rail

GRILLE PROFILES Pinnacle Windows | Pinnacle Select Windows

Interior Grilles – Ogee

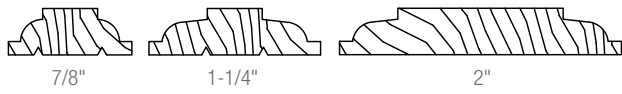

Exterior Grilles – Ogee

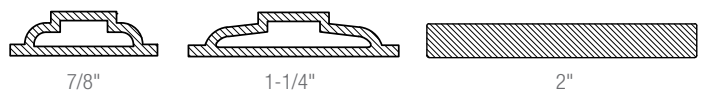

Interior Grilles – Putty



Exterior Grilles – Putty

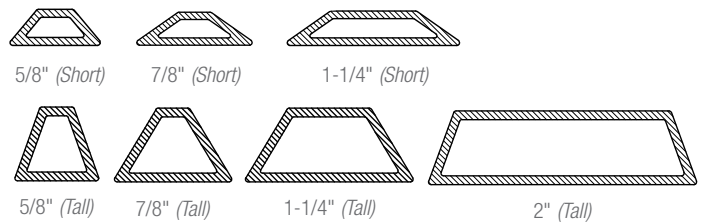

Interior Grilles – Contemporary



Exterior Grilles – Contemporary

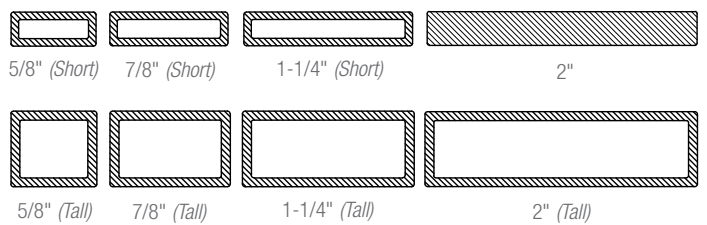

GRILLE SECTIONS

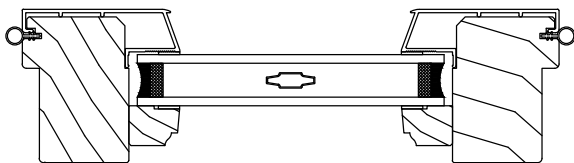

Standard Select IG with Inner Grille

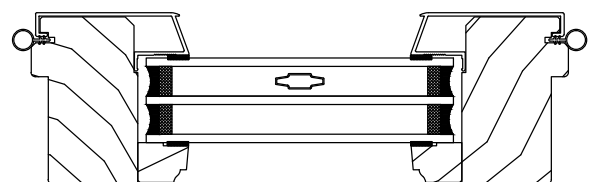

Triple IG with Inner Grille

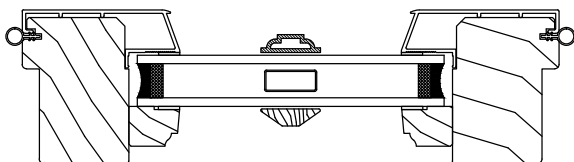

Standard Select IG with WDL and Inner Bar

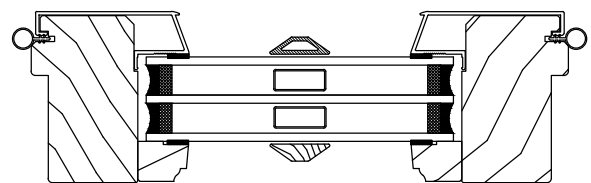

Triple IG with WDL and Inner Bar

GRILLE PATTERNS

Some grille patterns are not available in all configurations and products.

Casement and Awning Grille Patterns Pinnacle Windows | Pinnacle Select Windows

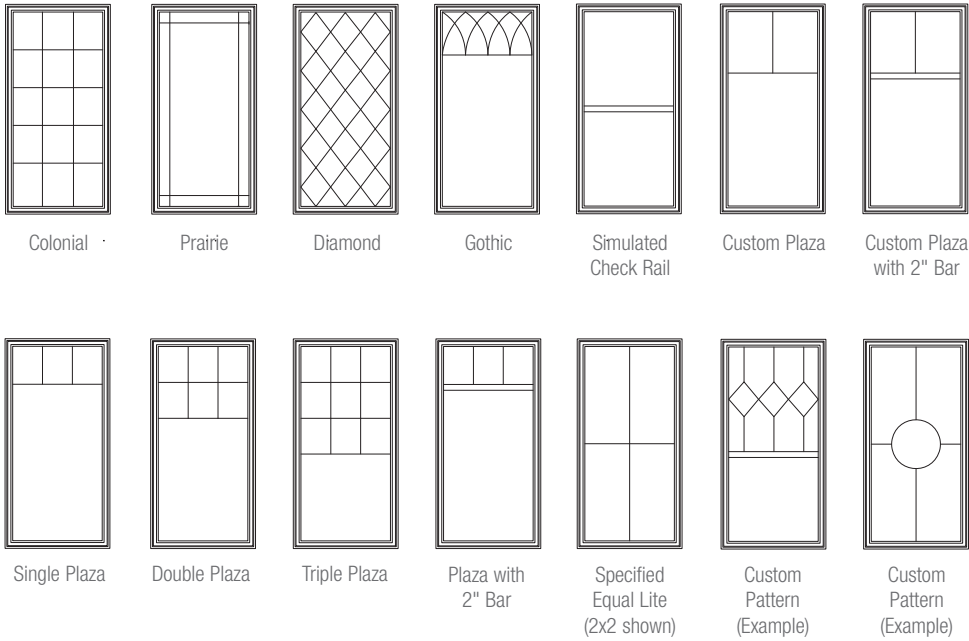

Double Hung Grille Patterns

Pinnacle Windows | Pinnacle Select Windows

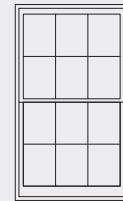

Colonial

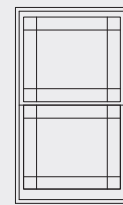

Prairie

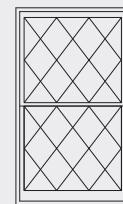

Diamond



Plaza

Patio Door Grille Patterns Pinnacle Patio Doors

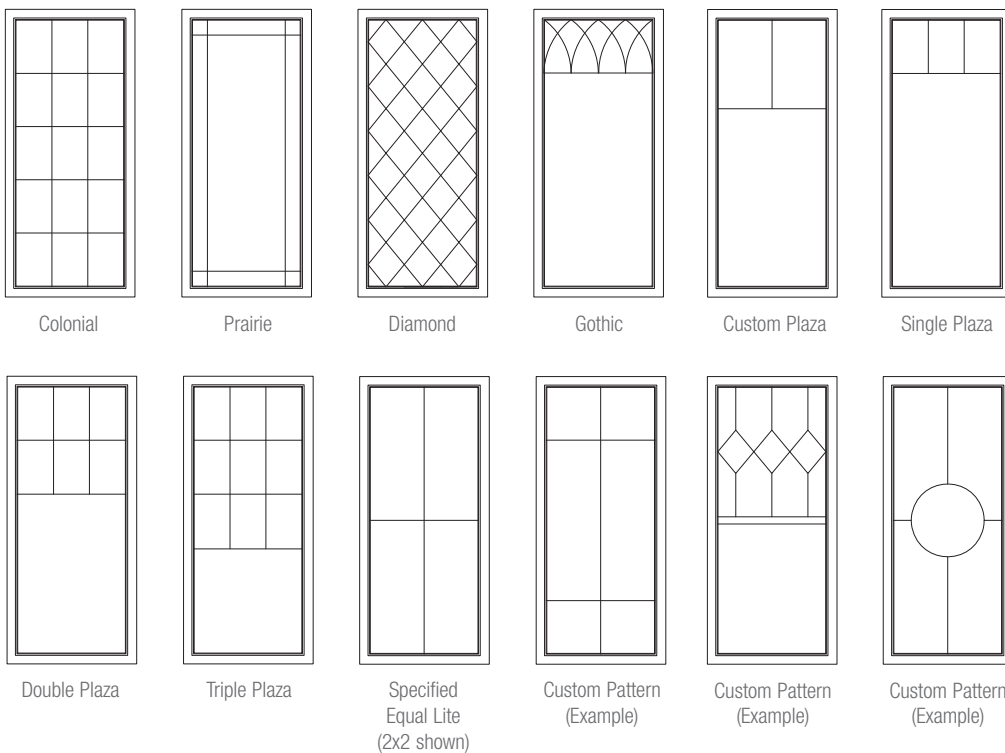

PATIO DOOR HANDLES AND FINISHES Pinnacle Patio Doors

Finishes marked with asterisks* feature a clear coating that protects the finish against tarnish and peeling.

This process extends the rich, bright life of the finish and dramatically delays the aging process.

Bi-fold doors are available with a classic or contemporary swinging handle in Satin Nickel, Brass and Oil Rubbed Bronze.

 <p>Classic Swinging Patio Door Handle</p>	<table border="0"> <tr> <td></td> <td></td> <td></td> </tr> <tr> <td>White</td> <td>Brushed Chrome*</td> <td>Polished Chrome*</td> </tr> <tr> <td></td> <td></td> <td></td> </tr> <tr> <td>Satin Nickel*</td> <td>Antique Nickel*</td> <td>Brass*</td> </tr> <tr> <td></td> <td></td> <td></td> </tr> <tr> <td>Antique Brass</td> <td>Faux Bronze</td> <td>Oil Rubbed Bronze</td> </tr> <tr> <td></td> <td></td> <td></td> </tr> <tr> <td>Black</td> <td></td> <td></td> </tr> </table>				White	Brushed Chrome*	Polished Chrome*				Satin Nickel*	Antique Nickel*	Brass*				Antique Brass	Faux Bronze	Oil Rubbed Bronze				Black			 <p>Euro Swinging Patio Door Handle</p> <table border="0"> <tr> <td></td> <td></td> </tr> <tr> <td>Satin Nickel*</td> <td>Black</td> </tr> </table>			Satin Nickel*	Black								
																																						
White	Brushed Chrome*	Polished Chrome*																																				
																																						
Satin Nickel*	Antique Nickel*	Brass*																																				
																																						
Antique Brass	Faux Bronze	Oil Rubbed Bronze																																				
																																						
Black																																						
																																						
Satin Nickel*	Black																																					
<p>Contemporary Swinging Patio Door Handle</p>																																						
 <p>Contemporary Sliding Patio Door Handle</p>	<table border="0"> <tr> <td></td> <td></td> <td></td> </tr> <tr> <td>White</td> <td>Brushed Chrome*</td> <td>Polished Chrome*</td> </tr> <tr> <td></td> <td></td> <td></td> </tr> <tr> <td>Satin Nickel*</td> <td>Antique Nickel</td> <td>Brass*</td> </tr> <tr> <td></td> <td></td> <td></td> </tr> <tr> <td>Antique Brass</td> <td>Faux Bronze*</td> <td>Oil Rubbed Bronze</td> </tr> <tr> <td></td> <td></td> <td></td> </tr> <tr> <td>Black</td> <td></td> <td></td> </tr> </table>				White	Brushed Chrome*	Polished Chrome*				Satin Nickel*	Antique Nickel	Brass*				Antique Brass	Faux Bronze*	Oil Rubbed Bronze				Black			 <p>Flush mount Multi-slide and Sliding Patio Door Handle</p> <table border="0"> <tr> <td></td> <td></td> <td></td> </tr> <tr> <td>Satin Nickel*</td> <td>Faux Bronze*</td> <td>Oil Rubbed Bronze</td> </tr> <tr> <td></td> <td></td> <td></td> </tr> <tr> <td>Black</td> <td></td> <td></td> </tr> </table>				Satin Nickel*	Faux Bronze*	Oil Rubbed Bronze				Black		
																																						
White	Brushed Chrome*	Polished Chrome*																																				
																																						
Satin Nickel*	Antique Nickel	Brass*																																				
																																						
Antique Brass	Faux Bronze*	Oil Rubbed Bronze																																				
																																						
Black																																						
																																						
Satin Nickel*	Faux Bronze*	Oil Rubbed Bronze																																				
																																						
Black																																						
<p>Euro Sliding Patio Door Handle <i>Not available in Antique Nickel</i></p>																																						

PATIO DOOR HINGES Pinnacle Patio Doors



Adjustable Guide Hinge



Adjustable Set Hinge



Ball Bearing Hinge

PATIO DOOR STILES Pinnacle Patio Doors

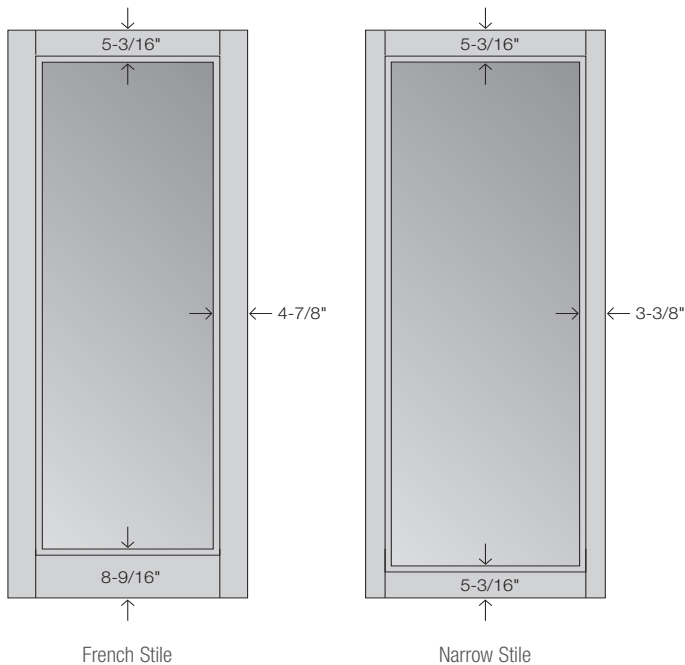

PINNACLE SELECT PATIO DOOR OPTIONS

INTERIOR WOOD SPECIES

Pinnacle Select Patio Doors

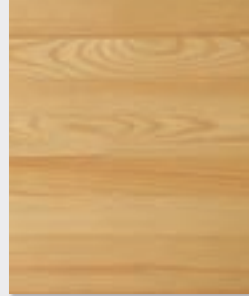

Clear Select Pine

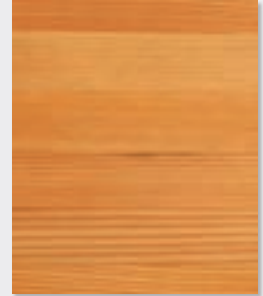

Douglas Fir

GLASS Pinnacle Select Patio Doors



LoE 366 (Standard)



Dual Low-E

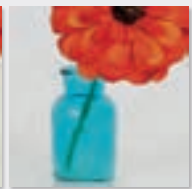

LoE 270

GRILLE PROFILES Pinnacle Select Patio Doors

Interior Grilles – Putty



5/8"



7/8"

Exterior Grilles – Putty

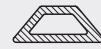

5/8" (Short)



7/8" (Short)

Interior Grilles – Contemporary



5/8"



7/8"

Exterior Grilles – Contemporary



5/8" (Short)



7/8" (Short)

PINNACLE SELECT PATIO DOOR OPTIONS

PATIO DOOR HANDLES AND FINISHES Pinnacle Select Patio Doors



Aria
Handle



Acacia
Handle



Summit
Handle

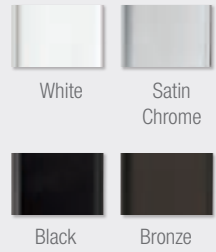

Multi-Slide
Handle

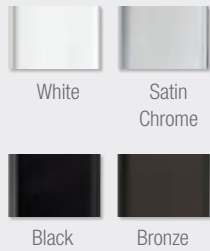

Wood Interior Bi-fold Twin
Bolt Handle
(Black or Bronze)



Aluminum Interior Bi-fold
Twin Bolt Handle
(Black or Bronze)

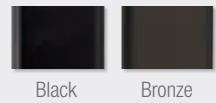



Download the latest
Legend Showcase
at windsorwindows.com.

Legend and Legend HBR

The Look of Real Wood with Unmatched Durability

Highly resilient CPVC construction keeps Legend windows free from rotting, warping, cracking, sticking and swelling, even in the harshest conditions. With fine attention to detail, including a variety of trim and grille options, Legend's traditional beauty and solid wood feel make it suitable for use in many historical renovations.

Available in casement, double hung, direct set and radius windows with hundreds of standard sizes and various custom sizes, along with specialty designs for coastal regions, you're sure to find a Legend window suited to your every need.

Hybrid (HBR)

Blending the strength of the Legend CPVC frame with a wood clad sash, Legend HBR from Windsor represents the next advancement in hybrid window and door technology.

Beautiful wood craftsmanship and the paintable exterior cellular PVC frame make Legend HBR a versatile choice for use in replacement, new construction or historical applications.

Legend HBR windows and doors are packed with features, including:

- Cellular PVC blind stops
- Extruded clad wood sash
- Standard, feature and custom colors

Additionally, you can mix and match styles and colors to complement your design vision by taking advantage of contrasted frame colors and rough openings identical to those of our standard Legend windows.

See what sets Legend apart at
www.windsorlegend.com



Legend

Give your home legendary beauty and quality with Windsor's Legend product line. These finely crafted windows provide your home with the look and feel of painted wood, but provide the outstanding, long-lasting performance of cellular PVC.

Features and Benefits

- Engineered, high-endurance cellular PVC materials will not decay, warp, crack, stick or swell
- UV protectors and impact modifiers incorporated into cellular PVC material enhance durability
- Finely crafted details, like sloped sill with sill nosing, offer traditional beauty and solid density of real wood
- Solid cellular PVC construction carries 25-year guarantee
- High-performance option available
- Energy efficient double hung balance allows top and bottom sashes to tilt for easy cleaning
- Easy installation with nails or screws
- Perfect for new construction or replacement of double hung windows; approved for historic renovation
- Integral finger pulls in double hung top and bottom sash offer easy opening and closing
- No-finger pull option in bottom sash for traditional or historical appearance
- Standard EZ Tilt operation on both the top and bottom sash; both sashes tilt in for easy cleaning
- Block and tackle balance on standard EZ Tilt is quiet, secure and operates smoothly
- Interlocking meeting rails for enhanced air and structural performance
- Dual-seal weatherstrip at bottom end rail
- PVC cap stock sash, sill and exterior stops
- Taller double hung exterior stops fully hide edge of jambliner

Sizes

Available in hundreds of standard and custom sizes

Glazing

- Windsor Glazing System provides 3/4" double pane insulated glass; Cardinal® LoE 366 glass standard; tinted, tempered, obscure and laminated glass available
- Interior stop glazed with silicone
- Custom and special glass types available

Grilles

Casement and Awning

Windsor Divided Lite (WDL) = simulated divided lite

- 3/4" and 1" Profiled Inner Grille
- 13/16" Flat Inner Grille
- 7/8" and 1-1/4" Ogee WDL
- 5/8" and 7/8" Tall and Short Putty WDL
- 2" Simulated Check rail
- Standard and custom grille patterns available

Double Hung

Windsor Divided Lite (WDL) = simulated divided lite

- 3/4" and 1" Profiled Inner Grille
- 13/16" Flat Inner Grille
- 7/8" and 1-1/4" Ogee WDL
- 5/8" and 7/8" Short Putty WDL
- 2" Simulated Check Rail (DH picture only)
- Standard and custom grille patterns available

Direct Set and Radius

Windsor Divided Lite (WDL) = simulated divided lite

- 7/8" and 1-1/4" Stick Grille
- 3/4" and 1" Profiled Inner Grille
- 13/16" Flat Inner Grille
- 7/8" and 1-1/4" Ogee WDL
- 5/8" and 7/8" Tall and Short Putty WDL
- 2" Simulated Check rail (Direct set only)
- Standard and custom grille patterns available

Finishes

- Interior available in primed white
- Interior and exterior trim can be painted; for exterior applications, do not use paint with an LRV rating of 54 or lower (See Windsor's Care and Use Guide for details)

Hardware

- Casement crank available in champagne, white, bronze and black; optional finishes in faux bronze, oil rubbed bronze, satin nickel and bright brass
- Double hung recessed lock, keeper and bottom sash tilt latch offered in champagne, white, bronze, faux bronze and satin nickel

Exterior Trim

- WM 180 brickmould (standard)
- WM 180 brickmould with flange
- Williamsburg
- 3-1/2" flat
- 4-1/2" backband
- 5-1/2" flat
- Plantation
- Double hung sill nose
- 2" bull nose sill nose
- Belly sill nose
- Casement subsill
- 2" casement subsill
- Half round/ellipse sill nose (radius only)

Performance Ratings and Certification

For current performance ratings, visit our website at windsorwindows.com and click on "Professional Information" in the menu bar

For Florida Building Commission approvals, including section and installation details, go to floridabuilding.org



Legend HBR

Windsor's finely crafted windows combine the traditional beauty of our Legend frame and low-maintenance aluminum clad sash with a stain-grade wood interior.

Features and Benefits

- 25-year CPVC warranty against rotting, warping, cracking or swelling
- Cellular PVC exterior with extruded clad sash
- Extruded aluminum in 23 standard colors, 20 feature colors or 7 matte colors. Custom color matching also available
- Architectural trim available in a variety of CPVC casing and sill options, providing a historically accurate appearance
- Factory-applied trim details save significant time and cost
- Rough openings are identical to standard Legend windows, making it easy to mix and match on the same job
- Standard EZ Tilt operation on both the top and bottom sash; both sashes tilt in for easy cleaning
- Block and tackle balance on standard EZ Tilt is quiet, secure and operates smoothly
- High-performance option available

Sizes

Available in hundreds of standard and custom sizes

Glazing

- Windsor Glazing System provides 3/4" double pane insulated glass; Cardinal® LoE 366 glass standard; tinted, tempered, obscure and laminated glass available
- Interior stop glazed with silicone
- Custom and special glass types available

Exterior Trim

- Units available with WM 180 brickmould, WM 180 brickmould with flange, Williamsburg, 3-1/2" flat, 4-1/2" backband, 5-1/2" flat or plantation casing; double hung sill nose, 2" bull nose sill nose, belly sill nose, casement subsill, 2" casement subsill or half round/ellipse sill nose

Grilles

Casement and Awning

Windsor Divided Lite (WDL) = simulated divided lite

- 7/8" and 1-1/4" Perimeter Grille
- 7/8" and 1-1/4" Stick Grille
- 3/4" and 1" Profiled Inner Grille
- 13/16" Flat Inner Grille
- 7/8" and 1-1/4" Ogee WDL
- 5/8", 7/8", 1-1/4" and 2" Tall and Short Putty WDL
- 5/8", 7/8", 1-1/4" and 2" Tall and Short Contemporary WDL
- 2" Simulated Check Rail
- Standard and custom grille patterns available

Double Hung

Windsor Divided Lite (WDL) = simulated divided lite

- 7/8" and 1-1/4" Perimeter Grille
- 7/8" and 1-1/4" Stick Grille
- 3/4" and 1" Profiled Inner Grille
- 13/16" Flat Inner Grille
- 7/8" and 1-1/4" Ogee WDL
- 5/8", 7/8", 1-1/4" and 2" Short Putty WDL
- 5/8", 7/8", 1-1/4" and 2" Short Contemporary WDL
- 2" Simulated Check Rail (DH picture only)
- Standard and custom grille patterns available

Sliding and Swinging Patio Door

Windsor Divided Lite (WDL) = simulated divided lite

- 7/8" and 1-1/4" Perimeter Grille
- 3/4" and 1" Profiled Inner Grille
- 13/16" Flat Inner Grille
- 7/8" and 1-1/4" Ogee WDL
- 5/8", 7/8", 1-1/4" and 2" Short Putty WDL
- 5/8", 7/8", 1-1/4" and 2" Short Contemporary WDL
- 3-3/8" Simulated Mid Rail
- Standard and custom grille patterns available

Finishes

- Interior – Available in Clear Select Pine
 - Primed: white or black
 - Painted: white, black or gray
 - Stained: 9 color options
- Exterior – Clad products feature heavy-duty extruded aluminum cladding on sash and frame; primed products offer an assortment of traditional trim options
- Patio door frames are primed wood

Clad Colors

All clad colors painted in-house with the highly durable AAMA 2604 standard finish, or upgrade to AAMA 2605 for the most challenging of environments

- 23 Standard Clad Colors available in 2604 and 2605 finish
- 20 Feature Clad Colors available in 2604 and 2605 finish (Custom color matching is also available)
- 7 Matte Clad Colors available in the 2604 finish only

Window Hardware

Casement and double hung hardware available in champagne, white, bronze and black; optional finishes in faux bronze, oil rubbed bronze, satin nickel and bright brass

Sliding Patio Door Hardware

Contemporary or Euro handle available in white, brushed chrome, polished chrome, satin nickel, antique nickel, brass, antique brass, faux bronze, oil rubbed bronze and black (Euro not available in antique nickel)

Performance Ratings

For current performance ratings, visit our website at windsorwindows.com and click on "Professional Information" in the menu bar

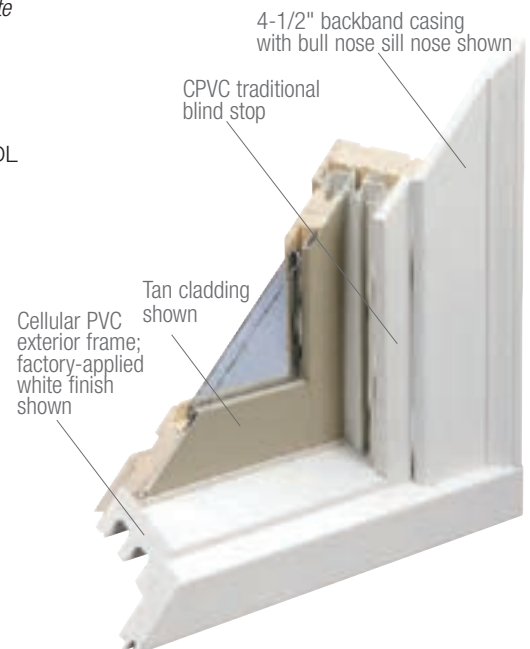

Options & Accessories

Finishing touches to perfect your vision. See the difference paint can make. Windsor's in-house paint application can help you make a statement with your Legend HBR windows and doors. Choose from over 50 shades in our standard and feature color palettes, or make it truly unique with custom color matching or our matte finish colors. All paints are protected with the highly durable 2604¹ finish, or you can upgrade to 2605² for even stronger defense against the elements.³

STANDARD CELLULAR PVC COLOR

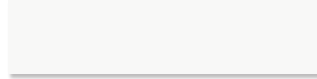

White

STANDARD CLAD COLORS (LEGEND HBR) Available in 2604 and 2605 finish.

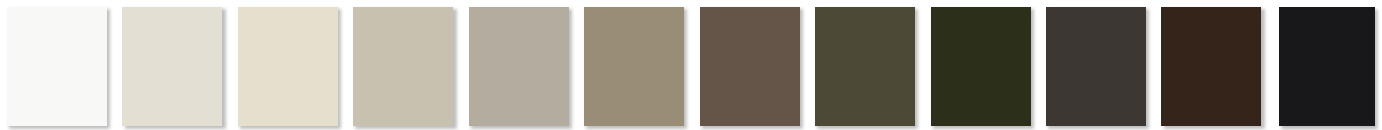

White Linen Ivory Sandstone Clay Tan Sage Brown Walnut Desert Dust Bronze Dark Bronze Appalachian Brown

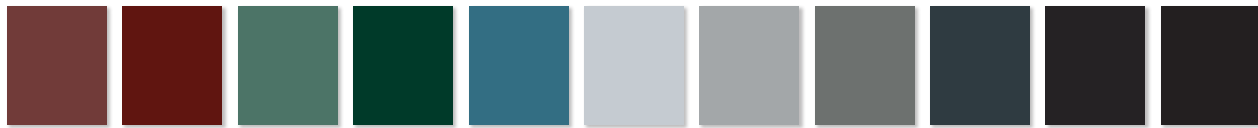

Red River Rouge Cinnamon Sage Green Hunter Green Military Blue Clear Dove Gray Slate Gray Charcoal Gray Sable Black

FEATURE CLAD COLORS (LEGEND HBR) Available in 2604 and 2605 finish. (Custom color matching is also available.)



French Vanilla Burnt Sun Pueblo Tan Dijon Beige Coastal Tan Sierra Tan Putty Antique Bronze Sunflower Burnt Pumpkin Copper



Brick Red Redwood Boysenberry Patina Green Camarillo Green Midnight Blue Stormy Monday Textured Black

MATTE CLAD COLORS (LEGEND HBR) Available in 2604 finish only.



Matte Tan Matte Desert Dust Matte Bronze Matte Sable Matte Slate Gray Matte Charcoal Gray Matte Black

¹AAMA 2604 finish backed by a 20-year warranty.

²AAMA 2605 finish backed by a 30-year warranty.

³For applications within one mile of the coast, AAMA 2605 finish will carry a 10-year warranty and AAMA 2604 will carry no warranty. For specific warranty details, please refer to the complete warranty document posted on our website, www.windsorwindows.com.

INTERIOR WINDOW FINISHES

Interior Wood Species



Clear Select Pine
Legend HBR

Interior Finishes *See warranty for limitations.

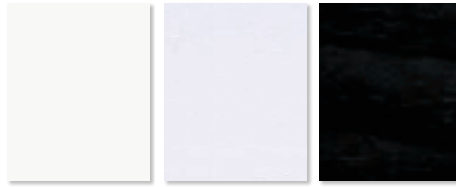

White CPVC
Finish*
Legend

White Primed
Legend & Legend
HBR

Black Primed
Legend HBR

Prefinished Painted Interiors

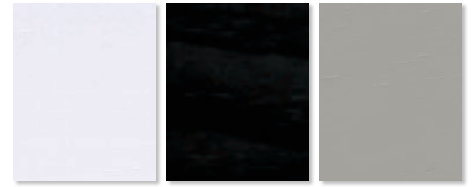

Painted White
Legend HBR

Painted Black
Legend HBR

Painted Gray
Legend HBR

Prefinished Stained Interiors CLEAR COAT AND STAIN SAMPLES ARE SHOWN ON CLEAR SELECT PINE AND REPRESENT OPTIONS AVAILABLE. ACTUAL FINISH MAY VARY.



Clear

Sunlight

Provincial

Tea with Milk

Antique Barrel

Perfect Brown

Intensive

Chestnut

Espresso

Prefinished Stains are available in Legend HBR

CASEMENT/AWNING CRANK AND FINISHES

Available in all eight finishes.



Traditional



Contemporary



Legend HBR



Legend

**Available finishes*



Champagne*

White*

Bronze*

Black

Faux Bronze*

Oil Rubbed Bronze

Satin Nickel*

Bright Brass

DOUBLE HUNG LOCK AND FINISHES

Legend HBR double hung locks are available in all eight finishes.

Legend double hung locks are available in the colors marked with *.

WINDOW TRIMS Custom-fitted wood trim is available in Clear Select Pine.

Interior Trim



WM 327 • 2-1/4"



WM 356 • 2-1/4"



WM 366 • 2-1/4"



WM 351 • 2-1/2"



WM 361 • 2-1/2"



WM 445 • 3-1/4"



WM 444 • 3-1/2"



RB 03 • 3-1/2"



WM 473 • 2-1/4"



WM 433 • 3-1/4"



WM 412 • 3-1/2"

Stool and Apron

Available in double or single hung windows



WM 1021 • 5-1/4"



B 200 • 11/16" x 2-1/2"

Rosettes



Rosette • 2-3/4"



Rosette • 3-3/4"

GLASS *Special order item

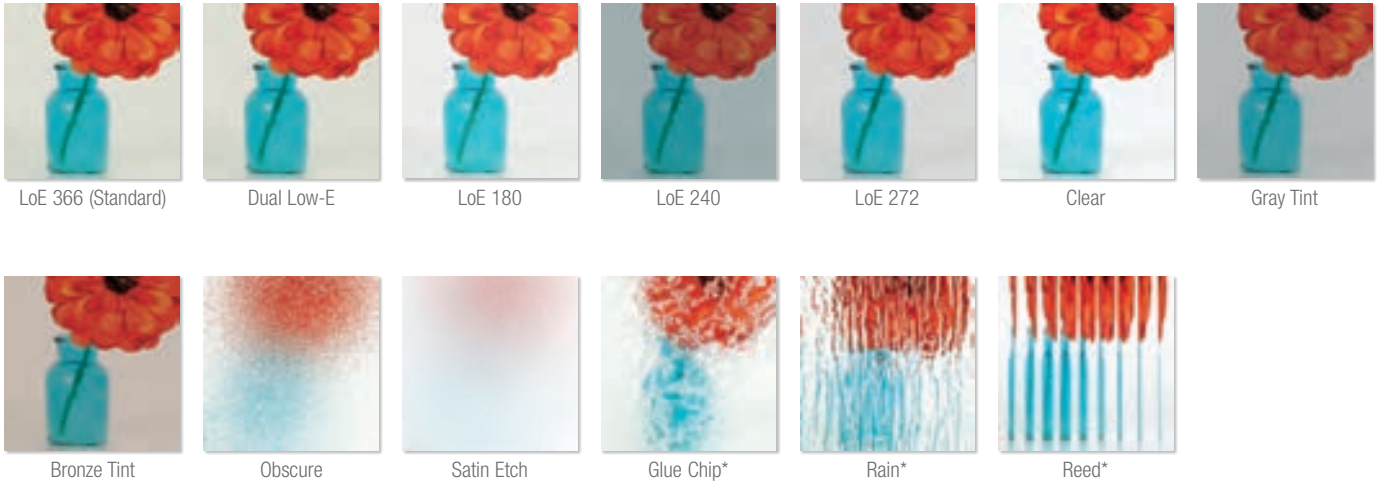

SCREENS

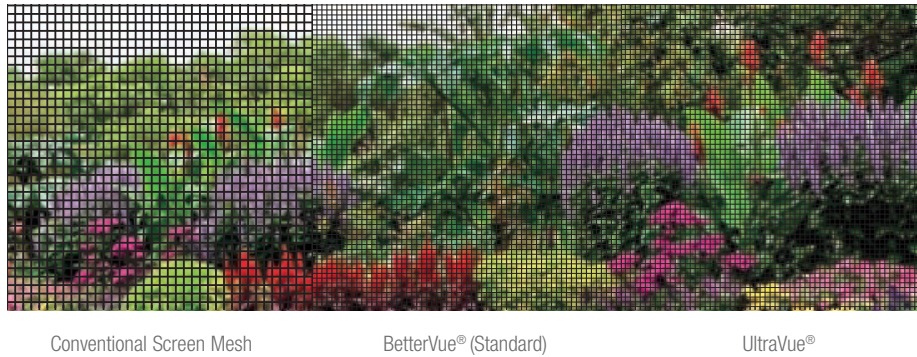

EXTERIOR TRIM

Cellular PVC Exterior Sill Options

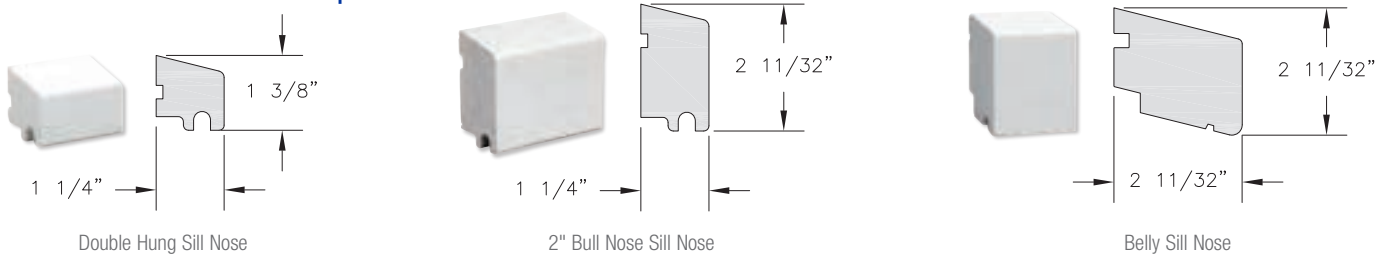

Cellular PVC Exterior Sill Options

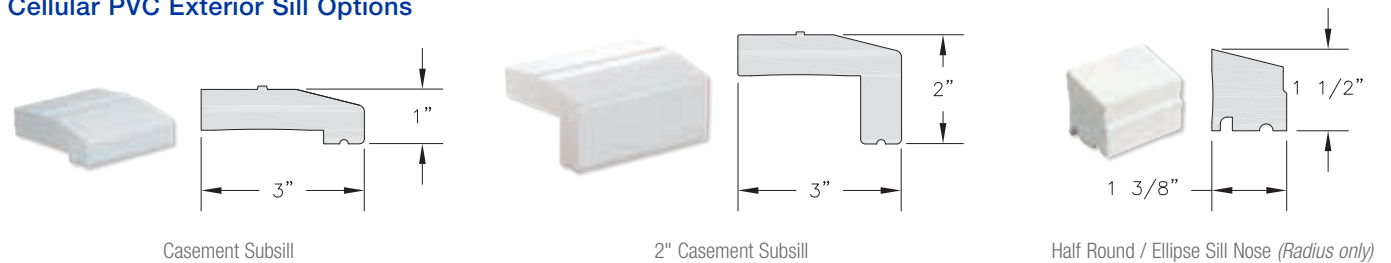

EXTERIOR TRIM

Cellular PVC Exterior Casing Options

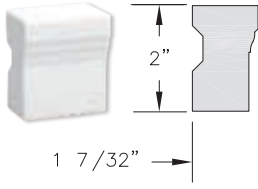

WM 180 Brickmould



Cellular PVC Exterior Casing Options

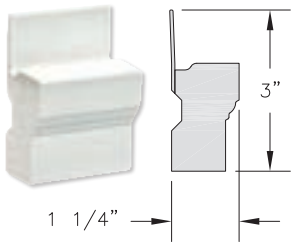

WM 180 Brickmould with Flange

Cellular PVC Exterior Casing Options

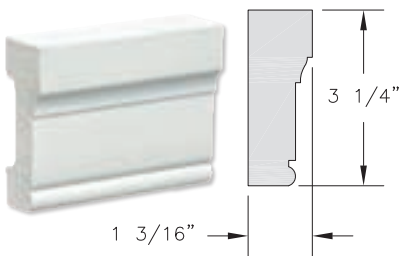

Williamsburg

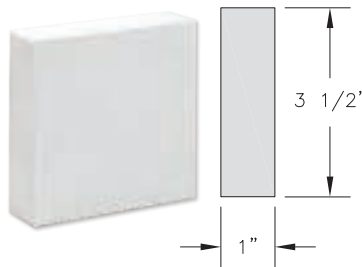

3-1/2" Flat

Cellular PVC Exterior Casing Options

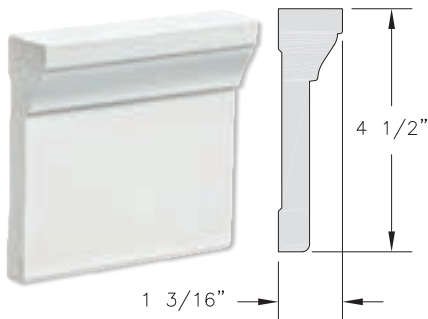

4-1/2" Backband

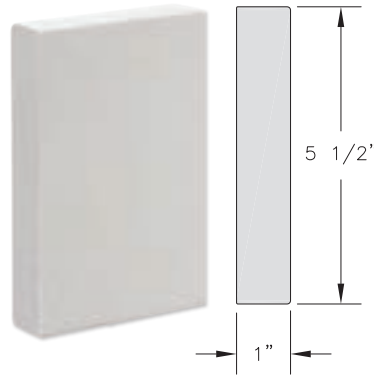

5-1/2" Flat

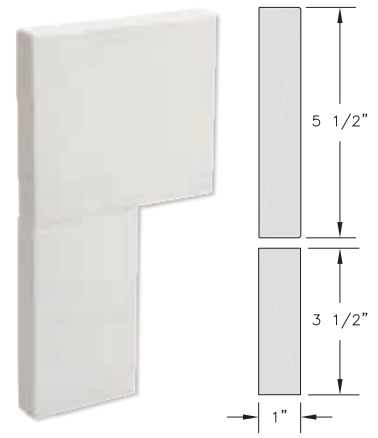

Plantation (3-1/2" Side; 5-1/2" Head)

GRILLES All of our wood and cellular PVC Windsor Divided Lite (WDL) bars are hand-fitted to ensure a perfect fit. Tall and short bars are available on casement, awning and direct set. Short bars are available on double hung and patio doors.



7/8" & 1-1/4"
Perimeter Grille
(Legend HBR)



7/8" & 1-1/4" Stick
Grille
(Legend HBR)



3/4" & 1" Profilled
Inner Grille
(Legend & Legend
HBR)



13/16" Flat Inner Grille
(Legend & Legend
HBR)



7/8" & 1-1/4" Exterior
Clad Windsor
Divided Lite
(Legend HBR)



7/8" & 1-1/4" CPVC
Windsor Ogee
Divided Lite
(Legend)



5/8", 7/8", 1-1/4" & 2"
Tall Putty
Windsor Divided Lite
(Legend & Legend HBR)



5/8", 7/8", 1-1/4" & 2"
Short Putty
Windsor Divided Lite
(Legend & Legend HBR)



2" Tall Putty
Simulated Check Rail
(Legend HBR)



2" Exterior Low Profile
Simulated Check Rail
(Legend HBR)



2" CPVC Simulated
Check Rail
(Legend)



3-3/8"
Simulated Mid Rail
(HBR Swinging Patio
Door only)

GRILLE PROFILES

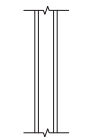

Standard
Insulating Glass

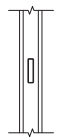

13/16"
Inner Grille

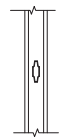

3/4" Profilled
Inner Grille

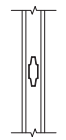

1" Profilled
Inner Grille

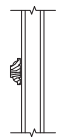

7/8" Stick &
Perimeter Grille

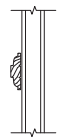

1-1/4" Stick &
Perimeter Grille

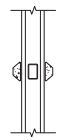

Legend 5/8"
Short Putty WDL
w/ Inner Bar

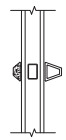

Legend 5/8"
Tall Putty WDL
w/ Inner Bar

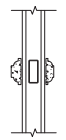

Legend 7/8"
Ogee WDL
w/ Inner Bar

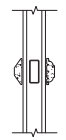

Legend 7/8" Short
Putty & Ogee WDL
w/ Inner Bar

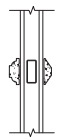

Legend 7/8" Ogee
& Short Putty WDL
w/ Inner Bar

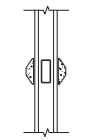

Legend HBR 7/8"
Short Putty WDL
w/ Inner Bar

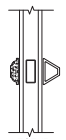

Legend 7/8" Ogee
& Tall Putty WDL
w/ Inner Bar

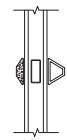

Legend 7/8"
Short & Tall Putty
WDL w/ Inner Bar

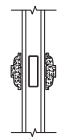

Legend 1-1/4"
Ogee WDL
w/ Inner Bar



Legend 2"
Ogee WDL
w/ Inner Bar

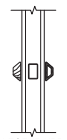

Legend HBR 5/8"
Short Putty WDL
w/ Inner Bar

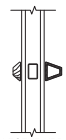

Legend HBR 5/8"
Short & Tall Putty
WDL w/ Inner Bar

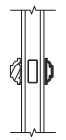

Legend HBR 7/8"
Ogee WDL
w/ Inner Bar



Legend HBR 7/8"
Short Putty & Ogee
WDL w/ Inner Bar

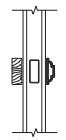

Legend HBR 7/8"
Contemporary
& Ogee WDL
w/ Inner Bar



Legend HBR 7/8"
Ogee & Short Putty
WDL w/ Inner Bar

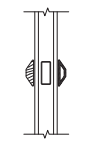

Legend HBR 7/8"
Short Putty WDL
w/ Inner Bar

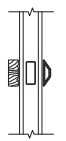

Legend HBR 7/8"
Contemporary
& Short Putty WDL
w/ Inner Bar

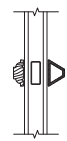

Legend HBR 7/8"
Ogee & Tall Putty
WDL w/ Inner Bar



Legend HBR 7/8"
Tall Putty WDL
w/ Inner Bar

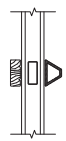

Legend HBR 7/8"
Contemporary
& Tall Putty WDL
w/ Inner Bar

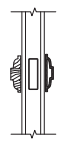

Legend HBR 1-1/4"
Ogee WDL
w/ Inner Bar

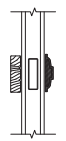

Legend HBR 1-1/4"
Contemporary
& Ogee WDL
w/ Inner Bar



Legend HBR 2"
Ogee WDL
w/ Inner Bar



Legend HBR 2"
Contemporary WDL
w/ Inner Bar



Legend HBR 2"
Ogee & Putty WDL
w/ Inner Bar



Legend HBR 2"
Contemporary &
Putty WDL
w/ Inner Bar

GRILLE PATTERNS

Some grille patterns are not available in all configurations and products.

Casement and Awning Grille Patterns

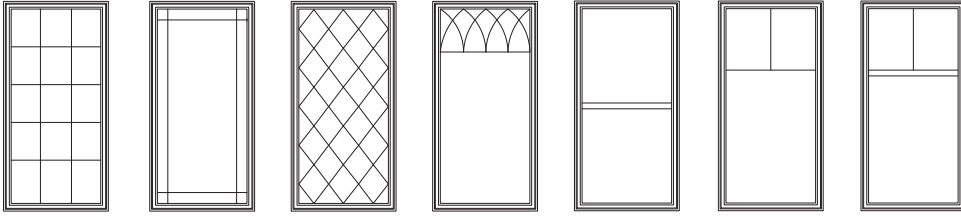

Colonial · Prairie Diamond Gothic Simulated Check Rail Custom Plaza Custom Plaza with 2" Bar

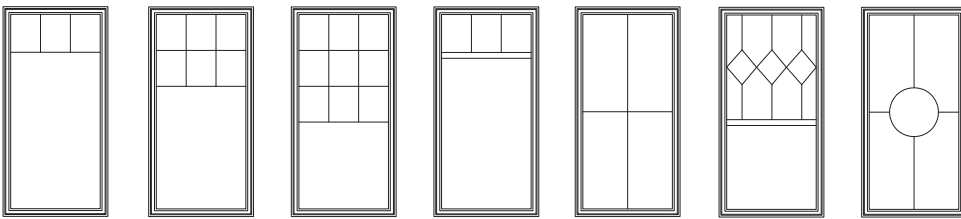

Single Plaza Double Plaza Triple Plaza Plaza with 2" Bar Specified Equal Lite (2x2 shown) Custom Pattern (Example) Custom Pattern (Example)

Patio Door Grille Patterns

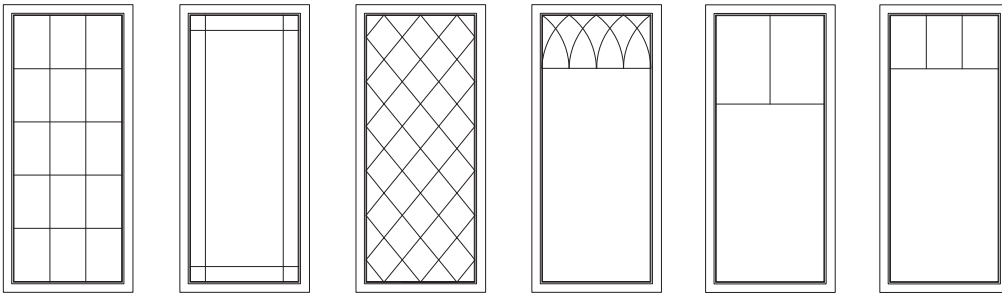

Colonial Prairie Diamond Gothic Custom Plaza Single Plaza

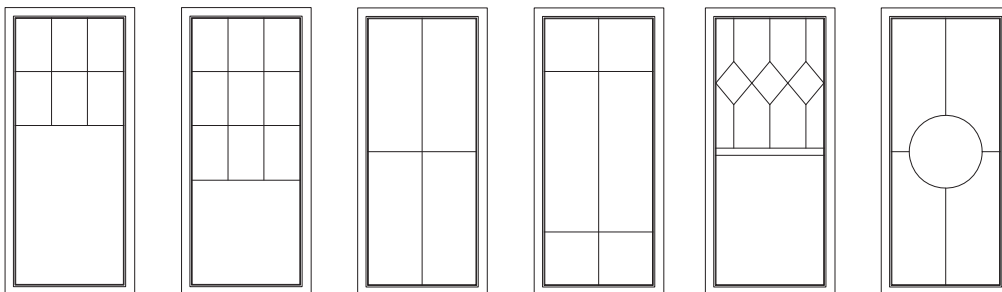

Double Plaza Triple Plaza Specified Equal Lite (2x2 shown) Custom Pattern (Example) Custom Pattern (Example) Custom Pattern (Example)

GRILLE WIDTHS

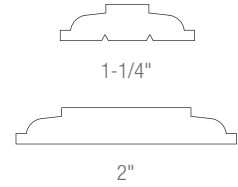
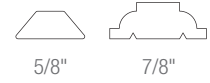

Double Hung Grille Patterns

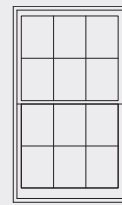

Colonial

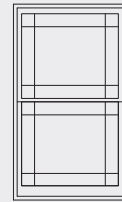

Prairie

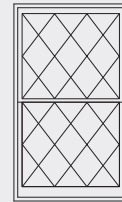

Diamond



Plaza

DIRECT SET AND RADIUS OPTIONS

Radius and Direct Set Special Shapes

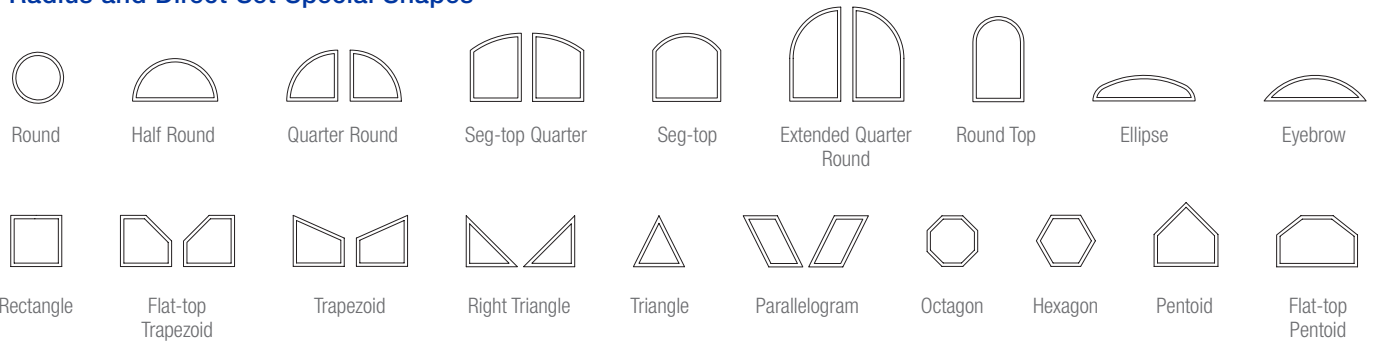

Radius Inner Grille Patterns Note: Before selecting a special grille pattern, confirm alignment with units below.

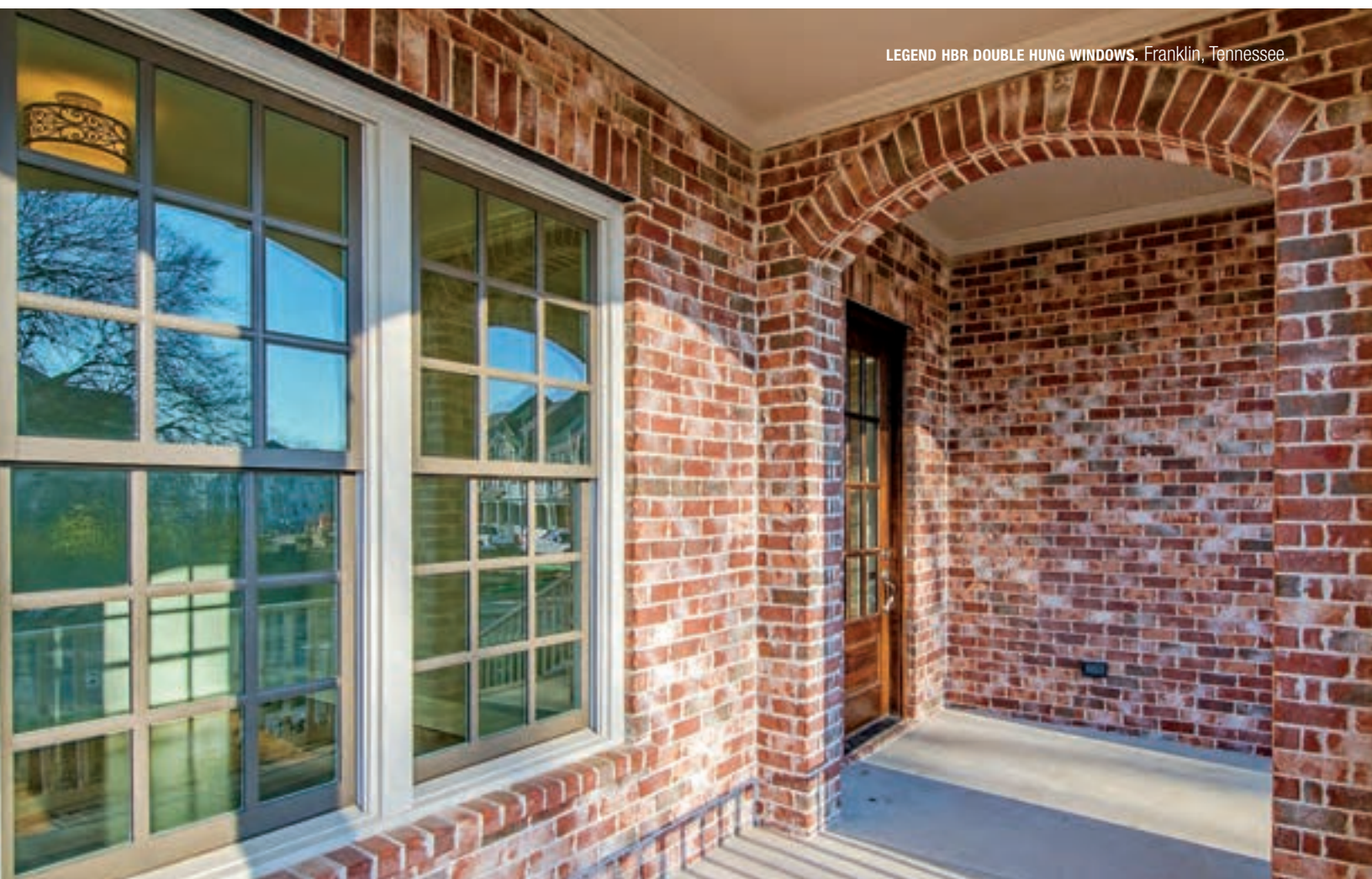
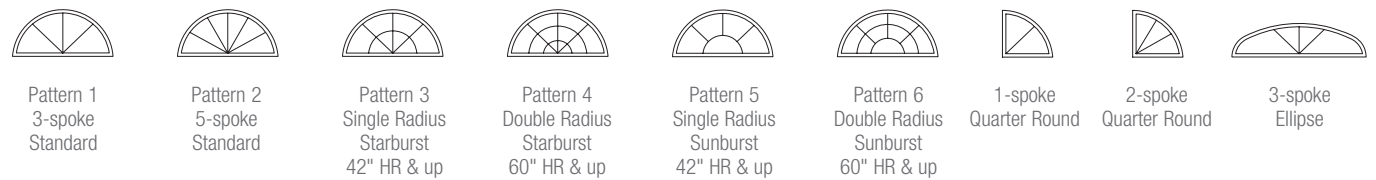

PATIO DOOR HANDLES AND FINISHES (LEGEND HBR)

Finishes marked with asterisks* feature a clear coating that protects the finish against tarnish and peeling.

This process extends the rich, bright life of the finish and dramatically delays the aging process.



Classic Swinging Patio Door Handle

Contemporary Swinging Patio Door Handle

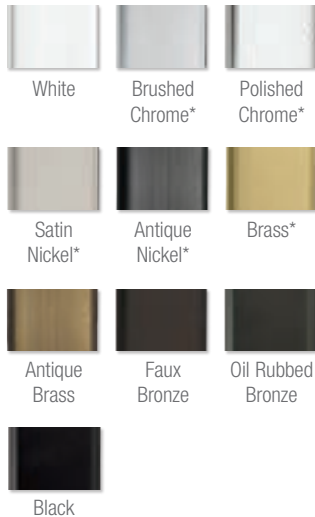

Euro Swinging Patio Door Handle

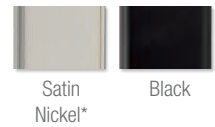

Contemporary Sliding Patio Door Handle



Euro Sliding Patio Door Handle
Not available in Antique Nickel



Flush mount Multi-slide and Sliding Patio Door Handle



PATIO DOOR HINGES (LEGEND HBR)



Adjustable Guide Hinge



Adjustable Set Hinge



Ball Bearing Hinge

LEGEND HBR DOUBLE HUNG WINDOWS. Franklin, Tennessee.





**Download the latest
Next Dimension
Showcase**
at windsorwindows.com.

Next Dimension

The Versatility of Vinyl

Next Dimension's advanced vinyl technology ensures easy operation, superior energy efficiency, low maintenance and high performance. Our products are built with vinyl extrusions that ensure superior weathering, durability and color retention. Next Dimension also uses Windsor's Super Spacer® technology and Cardinal® LoE 366 glass, which provides a glazing system that is top-of-the line in terms of energy efficiency. With several hardware and finish options available – including interior and exterior painted vinyl color options – our Next Dimension line offers a vinyl solution for any application.

Signature

Next Dimension Signature gives you a wide array of looks and hardware styles to mix and match, including products offered in half round, trapezoidal and octagonal configurations. Next Dimension windows and doors are built with quality and low maintenance in mind, using heavy vinyl extrusions to add outstanding strength and stability to our structural performance. Superior construction and lasting good looks ensure your windows and doors perform as well as they look.

Classic

Next Dimension Classic is your ticket to a traditional look for your design but with the same level of quality engineering, construction, durability and performance characteristics of all Next Dimension vinyl products. Classic windows and doors are built to retain their look season after season, ensuring your architectural vision holds true.

Pro

Next Dimension Pro windows offer an ideal balance of appealing style, reliability, energy efficiency and cost. Uniquely suited for use in multi-family, residential and light commercial applications, Next Dimension Pro windows and doors are a great substitute for aluminum. The distinguishing feature of Pro products is our Uniframe construction. Through the use of special frame components and a common T-mull design, Pro products are built with improved strength and performance, while offering greater aesthetic appeal over mullered units.

**See what sets Next Dimension apart at
www.windsornextdimension.com.**



Next Dimension Signature Casement & Awning

Features and Benefits

- Thick, multi-chambered extrusions add strength and decrease air infiltration
- Air spaces in chambers provide for superior energy efficiency
- 3-1/4" frame width; integral, rigid, pre-punched nail fin for easy installation
- Fusion-welded frame and sash for strong, leakproof construction
- Integral weep system for sleek appearance; no flaps, sponges or screens
- Easy-to-remove full screen with unique plunger-type engagement

Sizes

Available in hundreds of standard and custom sizes

Glazing

- Windsor Glazing System provides 3/4" double pane insulated glass; Cardinal® LoE 366 glass standard; tinted, tempered, obscure and laminated glass available
- Custom and special glass types available
- Super Spacer® technology provides excellent thermal performance and sound absorption*
- Hot melt butyl secondary seal creates a moisture and gas barrier for improved durability and longevity

Colors

- Available in standard white or clay, with seven additional painted exterior colors to choose from
- Interior black available on black painted exterior units

Grilles

- 3/4" Profiled Inner Grille
- 5/8" and 7/8" Putty WDL
- 2" Simulated Check Rail

Hardware

Folding nesting crank and cover available in white, clay or black

Warranty

Lifetime Limited Warranty** 10-year warranty on glass

Performance Ratings

For current performance ratings, visit our website at windsorwindows.com and click on "Professional Information" in the menu bar



*Certain sizes, shapes or glazings may be alternate IG system

**See Next Dimension warranty for more details

Next Dimension Signature Direct Set & Radius

Features and Benefits

- Thick, multi-chambered extrusions add strength and decrease air infiltration
- Air spaces in chambers provide for superior energy efficiency
- 3-1/4" frame width; integral, rigid, pre-punched nail fin for easy installation
- Fusion-welded frame for strong, leak proof construction
- Integral weep system for sleek appearance; no flaps, sponges or screens

Sizes

Available in hundreds of custom sizes and shapes

Glazing

- Windsor Glazing System provides 3/4" double pane insulated glass; Cardinal® LoE 366 glass standard; tinted, tempered, obscure and laminated glass available
- Custom and special glass types available
- Super Spacer® technology provides excellent thermal performance and sound absorption*
- Hot melt butyl secondary seal creates a moisture and gas barrier for improved durability and longevity

Colors

- Available in standard white or clay, with seven additional painted exterior colors to choose from
- Interior black available on black painted exterior units

Grilles

- 3/4" Profiled Inner Grille
- 5/8" and 7/8" Putty WDL
- 2" Simulated Check Rail

Warranty

Lifetime Limited Warranty** 10-year warranty on glass

Performance Ratings

For current performance ratings, visit our website at windsorwindows.com and click on "Professional Information" in the menu bar



*Certain sizes, shapes or glazings may be alternate IG system

**See Next Dimension warranty for more details

Next Dimension Classic Double Hung & Single Hung

Features and Benefits

- Thick, multi-chambered vinyl extrusions are optimized for superior weathering, durability and color retention
- 4" frame width on double hungs and 3-7/16" frame width on single hungs with integral extruded nail fin for strength and ease of installation; double hung available in a non-brickmould 3-1/4" standard frame
- Air spaces in chambers provide superior energy efficiency
- Fusion-welded frame and sash for strong, leak-resistant construction
- Locking mechanism and check rail interlock to create a tight seal between vent and fixed sash for improved weather performance
- Block and tackle balances provide years of smooth operation
- Integral lift/pull handle located on bottom rail for easy access and operation
- Integral weep system for sleek appearance; no flaps, sponges or screens
- Tilt sash for easy cleaning
- Sloped sill on single hung and double hung provides a traditional appearance
- Available with simulated divided lite or inner grille
- Multi-level profile for attractive architectural sitelines
- Jamb extensions offered as a kit or applied
- Vent latch option available

Glazing

- Windsor Glazing System provides 3/4" double pane insulated glass; Cardinal® LoE 366 glass standard; tinted, tempered, obscure and laminated glass available
- Custom and special glass types available
- Super Spacer® technology provides excellent thermal performance and sound absorption*
- Hot melt butyl secondary seal creates a moisture and gas barrier for improved durability and longevity

Sizes

Available in hundreds of standard and custom sizes

Colors

- Available in standard white or clay, with seven additional painted exterior colors to choose from
- Interior black available on black painted exterior units

Grilles

- 3/4" Profiled Inner Grille
- 5/8" and 7/8" Putty WDL
- 2" Simulated Check Rail (DH and SH picture only)

Hardware

Available in white, clay or black; color matched to window

Frame

- Brickmould profile with integral J-channel provides an offset that allows for more nail fin exposure and easier installation available on all Classic products
- Non-brickmould standard frame available on double hung

Warranty

Lifetime Limited Warranty**
10-year warranty on glass

Performance Ratings

For current performance ratings, visit our website at windsorwindows.com and click on "Professional Information" in the menu bar

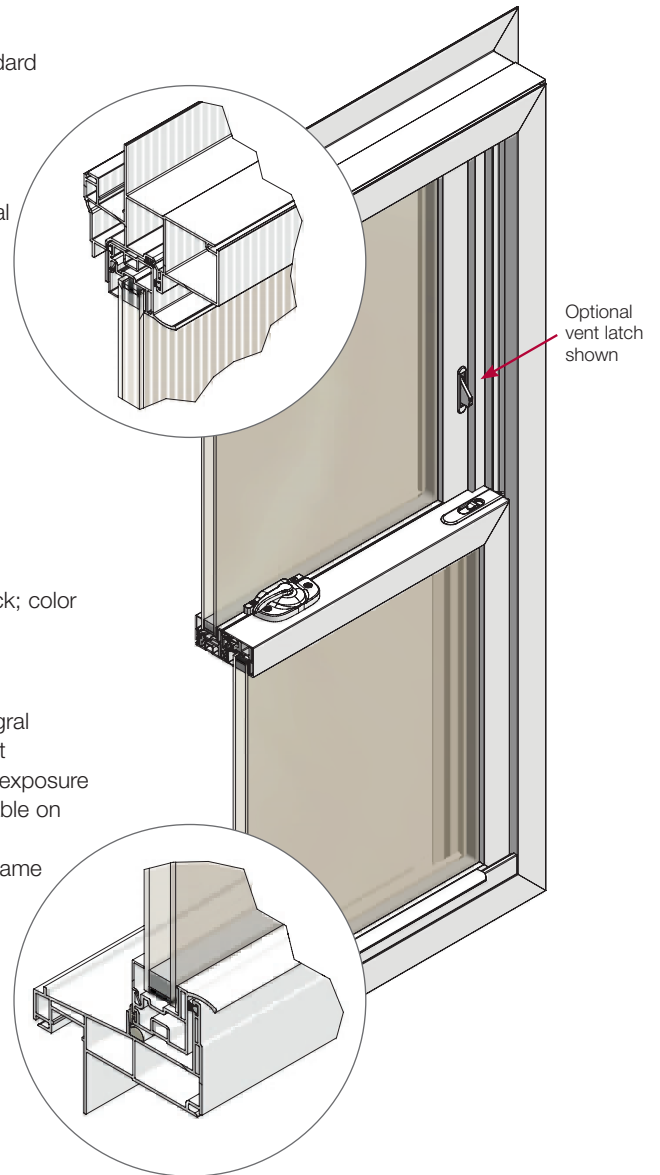

*Certain sizes, shapes or glazings may be alternate IG system

**See Next Dimension warranty for more details

Next Dimension Classic Sliding Window

Features and Benefits

- Thick, multi-chambered vinyl extrusions are optimized for superior weathering, durability and color retention
- 3-7/16" frame width with integral extruded nail fin for strength and ease of installation
- Air spaces in chambers provide superior energy efficiency
- Fusion-welded frame and sash for strong, leak-resistant construction
- Locking mechanism and check rail interlock to create a tight seal between vent and fixed sash for improved weather performance
- Integral lift/pull handle located on end rail for easy access and operation
- Integral weep system for sleek appearance; no flaps, sponges or screens
- Tilt sash for easy cleaning
- Available with simulated divided lite or inner grille
- Multi-level profile for attractive architectural sightlines
- Jamb extensions offered as a kit or applied
- Vent latch option available

Glazing

- Windsor Glazing System provides 3/4" double pane insulated glass; Cardinal® LoE 366 glass standard; tinted, tempered, obscure and laminated glass available
- Custom and special glass types available
- Super Spacer® technology provides excellent thermal performance and sound absorption*
- Hot melt butyl secondary seal creates a moisture and gas barrier for improved durability and longevity

Sizes

Available in hundreds of standard and custom sizes

Colors

- Available in standard white or clay, with seven additional painted exterior colors to choose from
- Interior black available on black painted exterior units

Grilles

- 3/4" Profiled Inner Grille
- 5/8" and 7/8" Putty WDL

Hardware

Available in white, clay or black; color matched to window

Frame

- Brickmould profile with integral J-channel provides an offset that allows for more nail fin exposure and easier installation available on all Classic products
- Non-brickmould standard frame available on double hung

Warranty

Lifetime Limited Warranty** 10-year warranty on glass

Performance Ratings

For current performance ratings, visit our website at windsorwindows.com and click on "Professional Information" in the menu bar

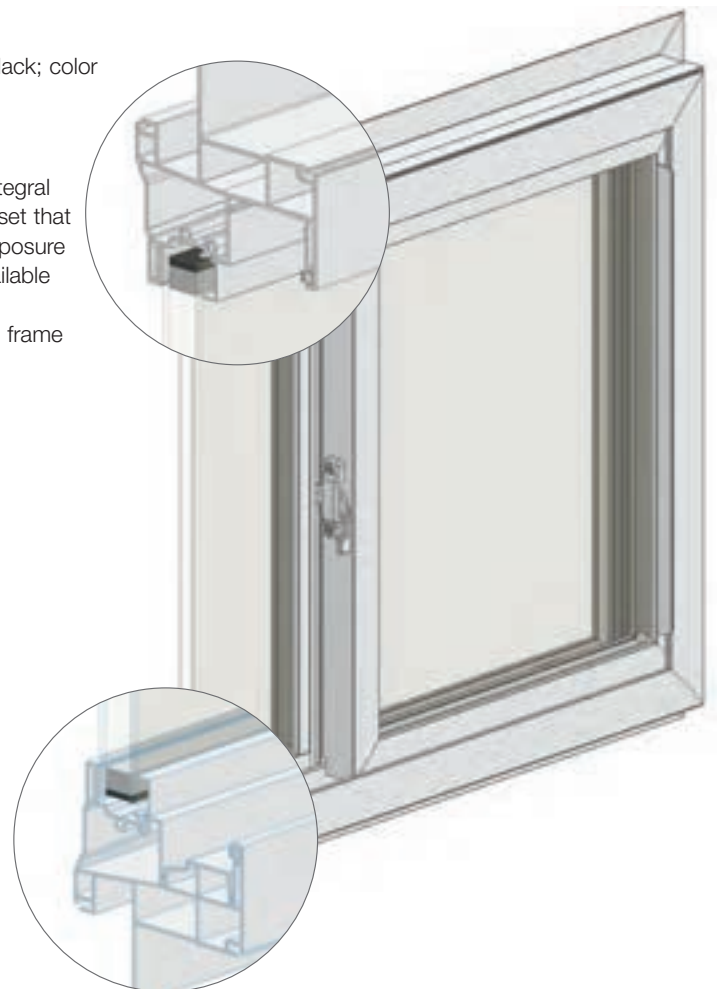

*Certain sizes, shapes or glazings may be alternate IG system

**See Next Dimension warranty for more details

Next Dimension Classic Direct Set & Radius

Features and Benefits

- Thick, multi-chambered vinyl extrusions are optimized for superior weathering, durability and color retention
- 4" frame width on double hungs and 3-7/16" frame width on single hungs with integral extruded nail fin for strength and ease of installation; double hung available in a non-brickmould 3-1/4" standard frame
- Air spaces in chambers provide superior energy efficiency
- Fusion-welded frame for strong, leak-resistant construction
- Integral weep system for sleek appearance; no flaps, sponges or screens
- Available with simulated divided lite or inner grille
- Jamb extensions offered as a kit or applied

Glazing

- Windsor Glazing System provides 3/4" double pane insulated glass; Cardinal® LoE 366 glass standard; tinted, tempered, obscure and laminated glass available
- Custom and special glass types available
- Super Spacer® technology provides excellent thermal performance and sound absorption*
- Hot melt butyl secondary seal creates a moisture and gas barrier for improved durability and longevity

Sizes

Available in hundreds of custom sizes and shapes

Colors

- Available in standard white or clay, with seven additional painted exterior colors to choose from Interior black available on black painted exterior units
- Interior black available on black painted exterior units

Grilles

- 3/4" Profiled Inner Grille
- 5/8" and 7/8" Putty WDL
- 2" Simulated Check Rail

Warranty

Lifetime Limited Warranty** 10-year warranty on glass

Performance Ratings

For current performance ratings, visit our website at windsorwindows.com and click on "Professional Information" in the menu bar



*Certain sizes, shapes or glazings may be alternate IG system

**See Next Dimension warranty for more details



Next Dimension Pro Single Hung

Features and Benefits

- Thick, multi-chambered vinyl extrusions are optimized for superior weathering, durability and color retention
- 2-3/4" frame width with integral extruded nail fin for strength and ease of installation
- Air spaces in chambers provide superior energy efficiency
- Fusion-welded frame and sash for strong, leak-resistant construction
- Lock and keeper creates a tighter seal between the vent and fixed sash for improved weather performance
- Block and tackle balances provide years of smooth operation
- Pocketed sill for unbeatable strength and performance
- Integral lift/pull handle located on bottom rail for easy access and operation
- Integral weep system for sleek appearance; no flaps, no sponges or screens

Glazing

- Windsor Glazing System provides 3/4" double pane insulated glass; Cardinal® LoE 366 glass standard; tinted, tempered, obscure and laminated glass available
- Custom and special glass types available
- Super Spacer® technology provides excellent thermal performance and sound absorption*
- Hot melt butyl secondary seal creates a moisture and gas barrier for improved durability and longevity

Sizes

Available in hundreds of standard and custom sizes

Colors

Available in standard white or clay, with seven additional painted exterior colors to choose from

Grilles

3/4" profiled aluminum grilles are color matched to the unit and installed within the insulated glass air space providing the look of authentic divided lite and allows for easy cleaning

Hardware

Available in white or clay; color matched to window

Warranty

Lifetime Limited Warranty** 10-year warranty on glass

Performance Ratings

For current performance ratings, visit our website at windsorwindows.com and click on "Professional Information" in the menu bar



*Certain sizes, shapes or glazings may be alternate IG system

**See Next Dimension warranty for more details



NEXT DIMENSION PRO SLIDING WINDOWS. Cedar Rapids, Iowa.

Next Dimension Pro Slider

Features and Benefits

- Thick, multi-chambered vinyl extrusions are optimized for superior weathering, durability and color retention
- 2-3/4" frame width with integral extruded nail fin for strength and ease of installation
- Air spaces in chambers provide superior energy efficiency
- Fusion-welded frame and sash for strong, leak-resistant construction
- Lock and keeper creates a tighter seal between the vent and fixed sash for improved weather performance
- Pocketed sill for unbeatable strength and performance
- Integral lift/pull handle located on bottom rail for easy access and operation
- Integral weep system for sleek appearance; no flaps, no sponges or screens
- Vinyl sash rollers for easy operation and durability

Glazing

- Windsor Glazing System provides 3/4" double pane insulated glass; Cardinal® LoE 366 glass standard; tinted, tempered, obscure and laminated glass available
- Custom and special glass types available
- Super Spacer® technology provides excellent thermal performance and sound absorption*
- Hot melt butyl secondary seal creates a moisture and gas barrier for improved durability and longevity

*Certain sizes, shapes or glazings may be alternate IG system

**See Next Dimension warranty for more details

Sizes

Available in hundreds of standard and custom sizes

Colors

- Available in standard white or clay, with seven additional painted exterior colors to choose from
- Interior black available on black painted exterior units

Grilles

3/4" profiled aluminum grilles are color matched to the unit and installed within the insulated glass air space providing the look of authentic divided lite and allows for easy cleaning

Hardware

Available in white, clay or black; color matched to window

Warranty

Lifetime Limited Warranty** 10-year warranty on glass

Performance Ratings

For current performance ratings, visit our website at windsorwindows.com and click on "Professional Information" in the menu bar



Next Dimension Pro Direct Set & Radius

Features and Benefits

- Thick, multi-chambered vinyl extrusions are optimized for superior weathering, durability and color retention
- 2-3/4" frame width with integral extruded nail fin for strength and ease of installation
- Air spaces in chambers provide superior energy efficiency
- Fusion-welded frame for strong, leak-resistant construction
- Integral weep system for sleek appearance; no flaps, no sponges or screens

Glazing

- Windsor Glazing System provides 3/4" double pane insulated glass; Cardinal® LoE 366 glass standard; tinted, tempered, obscure and laminated glass available
- Custom and special glass types available
- Super Spacer® technology provides excellent thermal performance and sound absorption*
- Hot melt butyl secondary seal creates a moisture and gas barrier for improved durability and longevity

Sizes

Available in hundreds of custom sizes and shapes

Colors

- Available in standard white or clay, with seven additional painted exterior colors to choose from
- Interior black available on black painted exterior units

Grilles

3/4" profiled aluminum grilles are color matched to the unit and installed within the insulated glass air space providing the look of authentic divided lite and allows for easy cleaning

Warranty

Lifetime Limited Warranty** 10-year warranty on glass

Performance Ratings

For current performance ratings, visit our website at windsorwindows.com and click on "Professional Information" in the menu bar



*Certain sizes, shapes or glazings may be alternate IG system

**See Next Dimension warranty for more details



Next Dimension Sliding Patio Door

Features and Benefits

- 4-1/2" frame width built from thick vinyl extrusions
- Fusion-welded frame and panel corners increase strength and maximize weather-proof performance
- Aluminum reinforcement in both interlock stiles for added strength and security
- Smooth operation on four adjustable steel ball bearing rollers on a stainless steel track
- Matching standard transom and sidelite additions for beautiful combinations
- Extruded aluminum threshold cover to protect sill and prevent debris build-up
- Panel anti-lift blocks for added security
- Heavy-duty extruded screen
- Blinds between the glass option available

Glazing

- 3/4" double pane insulated glass; Cardinal® LoE 366 glass standard; tinted, tempered, obscure and laminated glass available
- Custom and special glass types available

Colors

- Available in standard white or clay, with seven additional painted exterior colors to choose from
- Interior black available on black painted exterior units

Grilles

3/4" profiled aluminum grilles are color matched to the unit and installed within the insulated glass air space providing the look of authentic divided lite and allows for easy cleaning

Hardware

D-shaped handle offered in white, clay, satin nickel, faux bronze and black available on painted exteriors only

Warranty

Lifetime Limited Warranty** 10-year warranty on glass

Performance Ratings

For current performance ratings, visit our website at windsorwindows.com and click on "Professional Information" in the menu bar

*Certain sizes, shapes or glazings may be alternate IG system

**See Next Dimension warranty for more details

Our Quality is in the Details

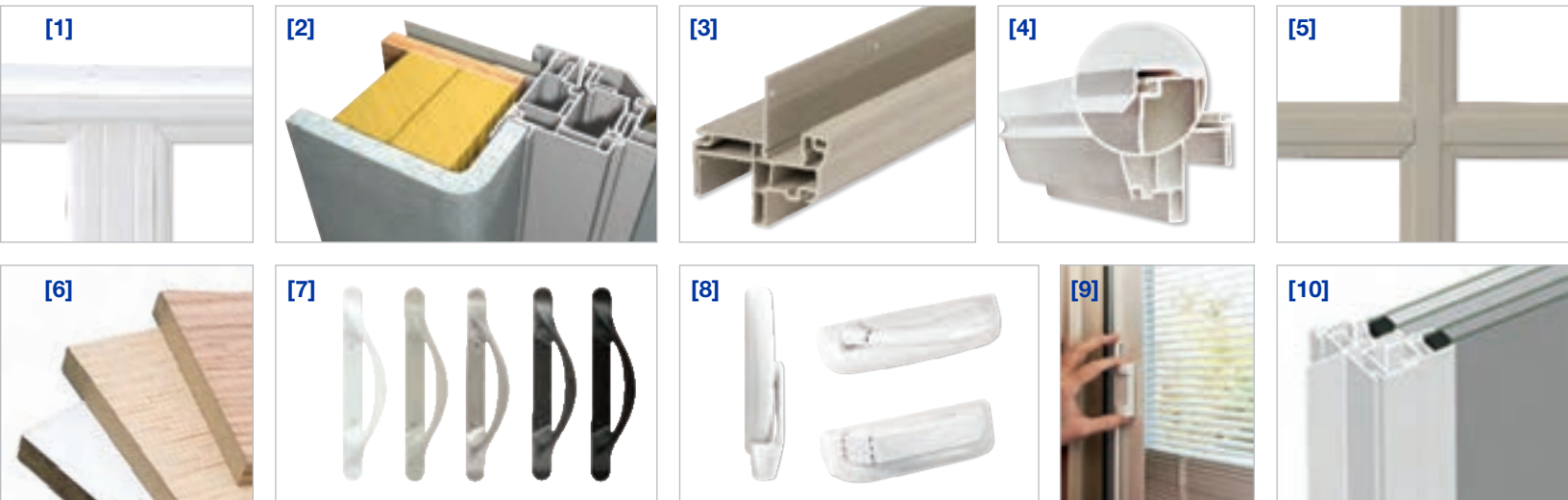

[1] MULLION POST Next Dimension Pro windows utilize an aluminum reinforced T-bar mullion post between two windows to provide an attractive appearance, added strength and to prevent air and water infiltration.

[2] DRYWALL RETURN This accessory provides a groove for drywall to slide into, providing a sleek, finished interior edge.

[3] INTEGRAL J-CHANNEL (*Pro & Classic Only*) Provides a smooth, finished edge for vinyl siding applications. Available on single hung, slider, picture and radius.

[4] DRIP CAP Just another detail we added to the top of the mull to ensure water stays out.

[5] GRILLES 3/4" profiled aluminum grilles are color matched to the unit and installed within the insulated glass airspace. This provides the look of authentic divided lite and allows for easy cleaning. 5/8" and 7/8" putty simulated divided lite grilles are available in Signature and Classic windows.

[6] EXTENSION JAMBS Extension jambs are available in pine and oak for stained interiors or in white for painted interiors. These are available as a separate kit or applied.

[7] SLIDING PATIO DOOR HARDWARE Our patio door handles feature a versatile "D" shape in white, clay, satin nickel, faux bronze or black to coordinate with your door color.

[8] WINDOW HARDWARE The beauty of Next Dimension windows is carried right down to the sleek design of our hardware. They are available in clay, white or black to match the units.

[9] BLINDS BETWEEN THE GLASS (*Patio Door Only*) Control light and privacy with blinds between the glass. This no-cord, easy-to-clean option adds lift and tilt features, simple operation and long-lasting performance.

[10] EASY-OUT™ SASH SYSTEM (*Pro Only*) A feature unique to Next Dimension Pro models, the Easy-Out Sash System is designed for easy removal of the entire lower sash, making installation and replacement easier than ever. And, the Easy-Out Sash System's pocket design creates consistent pressure against the weatherstrip, meaning no loss in air and water performance.

Options & Accessories

Finishing touches to perfect your vision. Windsor does more than just create durable, high-performance windows and doors. We pay attention to every detail and offer a wide array of options and finishes to match any décor. Flashy and eye-catching or simple and understated, our hardware, finishes, grille options, vinyl colors, glass options and grille patterns complete the perfect window and door package.

STANDARD VINYL COLORS

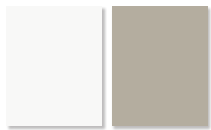

White Clay

PAINTED VINYL EXTERIOR COLORS

White vinyl interior is available with white, ivory, tan, bronze, cinnamon, hunter green or black exterior. Clay vinyl interior is available with bronze or black exterior.

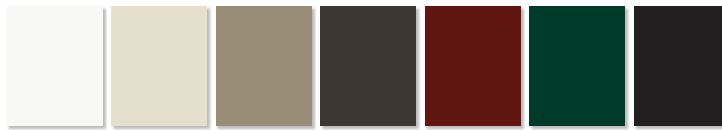

White Ivory Tan Bronze Cinnamon Hunter Green Black

PAINTED VINYL INTERIOR COLORS

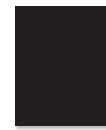

Black*

**Only available with Painted Black Exteriors*

WINDOW HARDWARE

Hardware is available in white, clay or black.



White Clay Black

Classic Single Hung and Slider Lock



Signature Casement and Awning Crank/Cover and Lock



Lock



Traditional Crank/Cover



Contemporary Crank/Cover

Classic Double Hung Lock



Pro Single Hung and Slider Lock



(Black available on Slider only.)

GRILLES All cellular PVC Windsor Divided Lite (WDL)¹ bars are hand-fitted to ensure a perfect fit.

*Not available in Pro.



3/4" Profiled Inner Grille



5/8" & 7/8" Putty Windsor Divided Lite (Exterior only) with Flat Inner Grille*

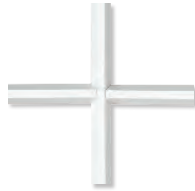

5/8" & 7/8" Putty Windsor Divided Lite*



2" Simulated Check Rail

GLASS *Special order item



LoE 366 (Standard)



Dual Low-E



LoE 180



LoE 240



LoE 272



Clear



Gray Tint



Bronze Tint



Obscure



Satin Etch

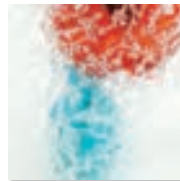

Glue Chip*

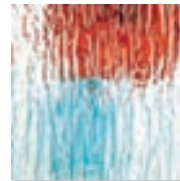

Rain*

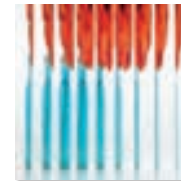

Reed*

SCREENS

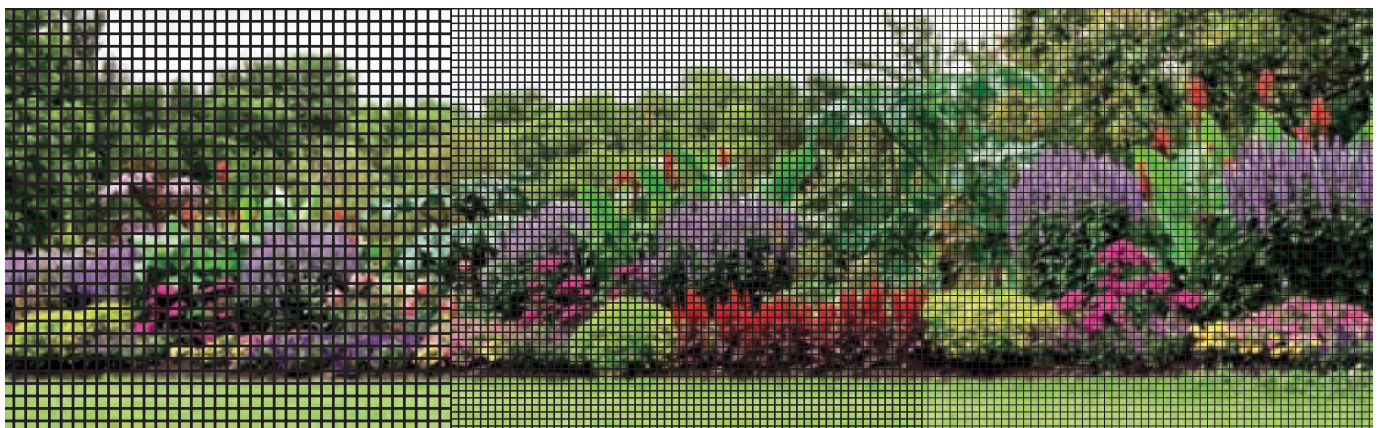

Conventional Screen Mesh

BetterVue® (Standard)

UltraVue®

¹WDL bars are available in Signature casement, awning, direct set and radius windows.

NOTE: Printing limitations prevent exact color/finish representation. See your Windsor distributor for actual samples.



NEXT DIMENSION PRO SINGLE HUNG AND PICTURE WINDOWS. Cedar Rapids, Iowa.

DIRECT SET AND RADIUS OPTIONS

Radius Special Shapes



Round



Half Round

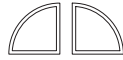

Quarter Round



Seg-top Quarter



Seg-top

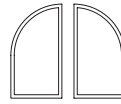

Extended Quarter Round



Round Top



Ellipse



Eyebrow

Direct Set Special Shapes



Rectangle



Flat-top Trapezoid

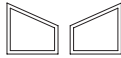

Trapezoid

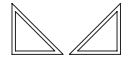

Right Triangle



Triangle



Parallelogram



Octagon



Hexagon



Pentoid



Flat-top Pentoid

Radius Inner Grille Patterns

Note: Before selecting a special grille pattern, confirm alignment with units below.

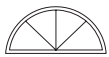

Pattern 1
3-spoke
Standard

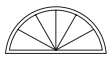

Pattern 2
5-spoke
Standard

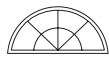

Pattern 3
Single Radius
Starburst
42" HR & up

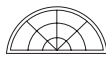

Pattern 4
Double Radius
Starburst
60" HR & up

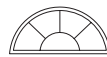

Pattern 5
Single Radius
Sunburst
42" HR & up

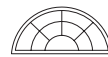

Pattern 6
Double Radius
Sunburst
60" HR & up



1-spoke
Quarter Round



2-spoke
Quarter Round

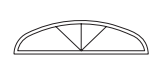

3-spoke
Ellipse

GRILLE PATTERNS Some grille patterns are not available in all configurations and products.

Single and Double Hung Grille Patterns

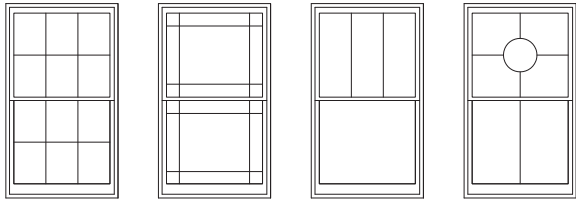

Colonial Prairie Plaza Custom Pattern (Example)

Casement and Awning Grille Patterns

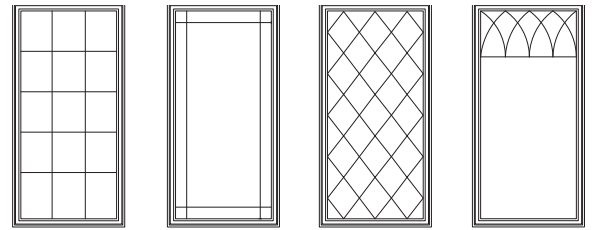

Colonial Prairie Diamond Gothic

Patio Door Grille Patterns

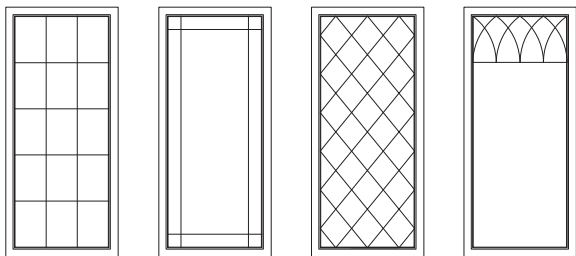

Colonial Prairie Diamond Gothic

Casement and Awning Grille Patterns

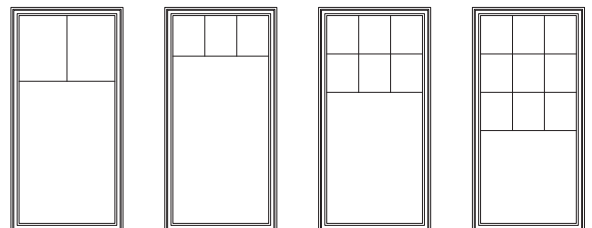

Custom Plaza Single Plaza Double Plaza Triple Plaza

Patio Door Grille Patterns

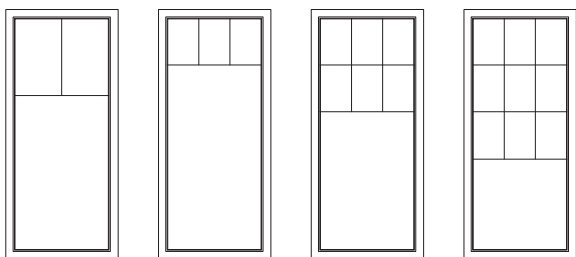

Custom Plaza Single Plaza Double Plaza Triple Plaza

Casement and Awning Grille Patterns

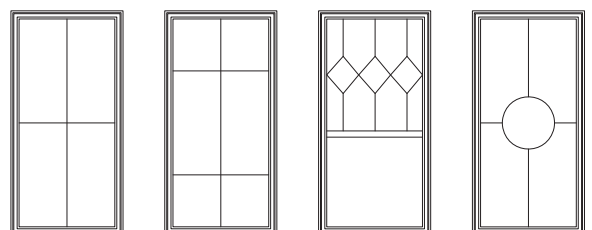

Specified Equal Lite (2x2 shown) Custom Pattern (Example) Custom Pattern (Example) Custom Pattern (Example)

Patio Door Grille Patterns

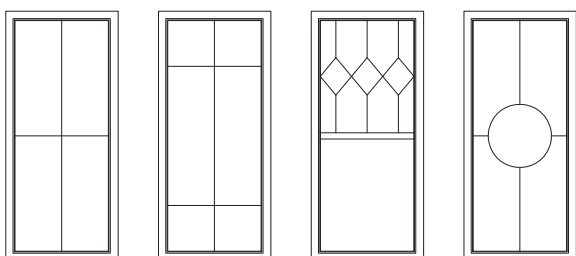

Specified Equal Lite (2x2 shown) Custom Pattern (Example) Custom Pattern (Example) Custom Pattern (Example)



SLIDING PATIO DOOR HANDLE AND FINISHES

Finishes are the same for both interior and exterior handles.



White

Satin Nickel*

Black

Clay

Faux Bronze*

*Only available with Painted Exteriors

SLIDING PATIO DOOR BLINDS BETWEEN THE GLASS

All vinyl sliding patio doors are handed from the exterior. The images shown below are viewed from the interior looking out to show proper location of blind/tilt and raise/lower mechanism.

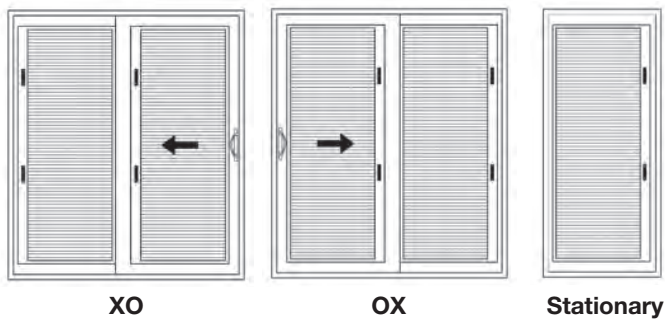

XO

OX

Stationary



WINDOW TRIM Custom-fitted wood trim is available in Clear Select Pine, Douglas Fir and Natural Alder.

(All photos shown in Clear Select Pine.)

Interior Trim



WM 327 • 2-1/4"



WM 356 • 2-1/4"



WM 366 • 2-1/4"



WM 351 • 2-1/2"



WM 361 • 2-1/2"



WM 445 • 3-1/4"



WM 444 • 3-1/2"



RB 03 • 3-1/2"



WM 473 • 2-1/4"



WM 433 • 3-1/4"



WM 412 • 3-1/2"

Stool and Apron

Available in double or single hung windows



WM 1021 • 5-1/4"



B 200 • 11/16" x 2-1/2"

Rosettes



Rosette • 2-3/4"



Rosette • 3-3/4"



Download the latest
Revive Showcase
at windsorwindows.com.

Revive

Breathe New Life into Your Home

No matter the age of your home, you want to preserve its appearance for a lifetime. When it comes to replacing drafty, inefficient windows, our Revive Pocket Replacement line of products offers a perfect solution.

Imagine transforming each window in your home with stunning Windsor quality, installed perfectly without spoiling your home's existing wood trim or exterior features. Our meticulous build to order process means your Revive Pocket replacement windows will provide a fast, uncomplicated upgrade.

Available in aluminum clad, hybrid and vinyl options, each window installation takes about 1 hour. With hundreds of hardware, finish and trim options, Revive is a perfect remodeling choice for the life – and love – of your home.

See what sets Revive apart at
www.windsorrevive.com.



REVIVE™

REPLACEMENT WINDOWS



Revive Wood Clad Double Hung Pocket Replacement Window

Features and Benefits

- **Stainable and paintable natural wood interiors** – Choose from Clear Select Pine, Natural Alder or Douglas Fir
- **Sleek appearance and clean lines** – Recessed lock, keeper and tilt latch won't get in the way of your view
- **Low-maintenance exteriors** – Heavy-duty aluminum cladding protects the sash and pocket frame
- **Easy cleaning** – EZ Tilt sash makes washing the outside glass more convenient
- **Concealed jambliner** – Enhances window's appearance with the warmth of wood on the interior and color-matched aluminum cladding on the exterior
- **Easy sash operation** – Full-sized block and tackle balance system allows sash to smoothly glide open and closed
- **Exceptional structural stability** – Head frame corners are keyed, screwed and silicone-injected
- Full- or half-screen options

Sizes

Available in custom sizes

Glazing

- 3/4" inch double pane insulated glass comes standard with energy efficient Cardinal® LoE 366 coating; tinted, tempered, obscure and laminated glazing options available
- Double glazing and interior wood stops lend superior strength and sealing against moisture and air
- Custom and special glass types available
- Preserve protective film optional

Grilles

Windsor Divided Lite (WDL) = simulated divided lite

- 7/8" and 1-1/4" Perimeter Grille
- 7/8" and 1-1/4" Stick Grille
- 3/4" and 1" Profiled Inner Grille
- 13/16" Flat Inner Grille
- 7/8" and 1-1/4" Ogee WDL
- 5/8", 7/8", 1-1/4" and 2" Short Putty WDL
- 5/8", 7/8", 1-1/4" and 2" Short Contemporary WDL
- 2" Simulated Check Rail (DH picture only)
- Standard and custom grille patterns available

Interior Trim and Accessories

- 11 trim profiles • Stool and apron
- 7 interior stops • Base shoe and cove
- Rosettes

Finishes

- Interior – Available in Clear Select Pine, Douglas Fir or Natural Alder
 - Primed: white or black
 - Painted: white, black or gray
 - Stained: 9 color options
- Exterior – Heavy-duty extruded aluminum cladding

Clad Colors

- All clad colors painted in-house with the highly durable AAMA 2604 standard finish, or upgrade to AAMA 2605 for the most challenging of environments
- 23 Standard Clad Colors available in 2604 and 2605 finish
 - 20 Feature Clad Colors available in 2604 and 2605 finish (Custom color matching is also available)
 - 7 Matte Clad Colors available in the 2604 finish only

Hardware

Double hung lock available in champagne, white, bronze and black; optional finishes in faux bronze, oil rubbed bronze, satin nickel and bright brass

Performance Ratings

For current performance ratings, visit our website at windsorwindows.com and click on "Professional Information" in the menu bar



Type	Sill Angle	Revive Replacement Unit (Frame Size)				Existing Frame (Opening Size)			
		Min Width	Max Width	Min Height	Max Height	Min Width	Max Width	Min Height	Max Height
Wood Clad DH Operating	0-7 Degree	17-3/8"	47-3/8"	31-15/16"	95-7/8"	17-7/8"	47-7/8"	32-5/16"	96-1/4"
	>7 Degree			*31-5/16"	*95-5/16"			31-11/16"	95-11/16"
Wood Clad DH Picture	0-7 Degree	16-3/4"	73-3/8"	19-11/16"	76-7/16"	17-1/4"	73-7/8"	20-1/16"	76-13/16"
	>7 Degree			*19-1/8"	*75-13/16"			19-1/2"	76-3/16"

*For units with a sill angle >7 degrees, add 5/8" to inside frame height to calculate the outside or overall frame dimension height.

Revive Hybrid Double Hung Pocket Replacement Window

Features and Benefits

- **Exceptionally easy to maintain** – Engineered, high-endurance cellular PVC sash will not decay, warp, crack, split or swell
- **Excellent thermal performance** – Cellular PVC sashes help keep the cold and heat outside – and help keep you comfortable inside
- **Sleek appearance and clean lines** – Recessed lock, keeper and tilt latch won't get in the way of your view
- **Low-maintenance exteriors** – Heavy-duty aluminum cladding protects the pocket frame
- **Easy cleaning** – EZ Tilt sash makes washing the outside glass more convenient
- **Easy sash operation** – Fixed-back, one-piece PVC jambliner, combined with a full-sized block and tackle balance system, allows sash to smoothly glide open and closed
- **Exceptional structural stability** – Head frame corners are keyed, screwed and silicone-injected
- Full- or half-screen options

Sizes

Available in custom sizes

Glazing

- 3/4" inch double pane insulated glass comes standard with energy efficient Cardinal® LoE 366 coating; tinted, tempered, obscure and laminated glazing options available
- Custom and special glass types available

Grilles

Windsor Divided Lite (WDL) = simulated divided lite

- 3/4" and 1" Profiled Inner Grille
- 13/16" Flat Inner Grille
- 7/8" and 1-1/4" Ogee WDL
- 5/8" and 7/8" Short Putty WDL
- 2" Simulated Check Rail (DH picture only)
- Standard and custom grille patterns available

Interior Trim and Accessories

- 11 trim profiles
- Stool and apron
- 7 interior stops
- Base shoe and cove
- Rosettes

Finishes

- Interior – Available in Clear Select Pine, primed or painted white (standard)
- Exterior – Heavy-duty extruded aluminum cladding on frame and cellular PVC sashes

Clad Colors

All clad colors painted in-house with the highly durable AAMA 2604 standard finish, or upgrade to AAMA 2605 for the most challenging of environments

- 23 Standard Clad Colors available in 2604 and 2605 finish
- 20 Feature Clad Colors available in 2604 and 2605 finish (Custom color matching is also available)
- 7 Matte Clad Colors available in the 2604 finish only

Hardware

Double hung lock available in champagne, white, bronze, faux bronze and satin nickel

Performance Ratings

For current performance ratings, visit our website at windsorwindows.com and click on "Professional Information" in the menu bar



Type	Sill Angle	Revive Replacement Unit (Frame Size)				Existing Frame (Opening Size)			
		Min Width	Max Width	Min Height	Max Height	Min Width	Max Width	Min Height	Max Height
Hybrid DH Operating	0-7 Degree	17-3/8"	41-3/8"	31-15/16"	79-7/8"	17-7/8"	41-7/8"	32-5/16"	80-1/4"
	>7 Degree			*31-5/16"	*79-5/16"			31-11/16"	79-11/16"
Hybrid DH Picture	0-7 Degree	16-3/4"	61-3/8"	20-3/16"	75-13/16"	17-1/4"	73-7/8"	20-5/8"	75-9/16"
	>7 Degree			*19-5/8"	*75-3/16"			20-0"	76-3/16"

*For units with a sill angle >7 degrees, add 5/8" to inside frame height to calculate the outside or overall frame dimension height.

Revive Vinyl Double Hung Pocket Replacement Window

Features and Benefits

- **Low-maintenance frames** – Vinyl stays looking great year after year – no need to paint or scrape your windows ever again
- **Superior weatherability and thermal performance** – Rugged, multi-chambered vinyl sash and frames optimize your home's energy efficiency year after year
- **Smooth opening and closing** – Block and tackle balance system provides years of effortless operation
- **Superior strength and security** – Aluminum-reinforced meeting rail adds structural strength and wind resistance
- **Quick and convenient glass cleaning** – Both sashes tilt in for easier cleaning

Sizes

Available in custom sizes

Glazing

- 3/4" inch double pane insulated glass comes standard with energy efficient Cardinal® LoE 366 coating; tinted, tempered, obscure and laminated glazing options available
- Custom and special glass types available

Grilles

Windsor Divided Lite (WDL) = simulated divided lite

- 3/4" Profiled Inner Grille
- 5/8" and 7/8" Putty WDL
- Standard and custom grille patterns available

Interior Trim and Accessories

- 11 trim profiles
- Stool and apron
- 7 interior stops
- Base shoe and cove
- Rosettes

Colors

- Available in standard white or clay with seven additional painted exterior colors to choose from
- Interior black available on black painted exterior units

Hardware

Double hung lock available in white, clay or black; color matched to window

Performance Ratings

For current performance ratings, visit our website at windsorwindows.com and click on "Professional Information" in the menu bar



Type	Sill Angle	Revive Replacement Unit (Frame Size)				Existing Frame (Opening Size)			
		Min Width	Max Width	Min Height	Max Height	Min Width	Max Width	Min Height	Max Height
Vinyl DH Operating	0-14 Degree	17-1/2"	47-1/2"	23-1/2"	81-1/2"	18"	48"	23-7/8"	81-7/8"
Vinyl DH Picture	0-14 Degree	11-1/2"	95-1/2"	11-1/2"	95-1/2"	12"	96"	11-7/8"	95-7/8"

Revive Vinyl Single Hung Pocket Replacement Window

Features and Benefits

- **Low-maintenance frames** – Vinyl stays looking great year after year – no need to paint or scrape your windows ever again
- **Superior weatherability and thermal performance** – Rugged, multi-chambered vinyl sash and frames optimize your home's energy efficiency year after year
- **Smooth opening and closing** – Block and tackle balance system provides years of effortless operation
- **Superior strength and security** – Aluminum-reinforced meeting rail adds structural strength and wind resistance
- **A lifetime of dependable service** – A side-load, easy-out sash feature with concealed sash release mechanism provides unparalleled strength and performance

Sizes

Available in custom sizes

Glazing

- 3/4" inch double pane insulated glass comes standard with energy efficient Cardinal® LoE 366 coating; tinted, tempered, obscure and laminated glazing options available
- Custom and special glass types available

Grilles

- 3/4" profiled inner grille
- Standard and custom grille patterns available

Interior Trim and Accessories

- 11 trim profiles
- Stool and apron
- 7 interior stops
- Base shoe and cove
- Rosettes

Colors

- Available in standard white or clay with seven additional painted exterior colors to choose from

Hardware

Single hung lock available in white or clay; color matched to window

Performance Ratings

For current performance ratings, visit our website at windsorwindows.com and click on "Professional Information" in the menu bar



Type	Sill Angle	Revive Replacement Unit (Frame Size)				Existing Frame (Opening Size)			
		Min Width	Max Width	Min Height	Max Height	Min Width	Max Width	Min Height	Max Height
Vinyl SH Operating	0-14 Degree	13-1/2"	47-1/2"	23-1/2"	83-1/2"	14"	48"	23-7/8"	83-7/8"
Vinyl SH Picture	0-14 Degree	13-1/2"	95-1/2"	11-1/2"	95-1/2"	14"	96"	11-7/8"	95-7/8"

Note: Vinyl SH Operating – Height cannot exceed 77-1/2" when frame width is greater than 41-1/2"

Revive Wood Clad Casement & Awning Pocket Replacement Window

Features and Benefits

- **Stainable and paintable natural wood interiors** – Choose from Clear Select Pine, Natural Alder or Douglas Fir
- **Sleek appearance and clean lines** – Single lever, sequential, multi-point lock for sleek look and easy operation
- **Low-maintenance exteriors** – Heavy-duty aluminum cladding protects the sash and pocket frame
- **Excellent thermal performance** – Exterior tape glazing slows conduction of heat/cold through edge of glass; two beads of silicone ensure a water tight seal that creates three seals between glass and sash
- **Easy sash operation** – Adjustable concealed hinge system ensures smooth operation
- **No crank handles to get in your way** – Recessed crank handle nests in the operator cover housing, keeping it out of the way of window treatments
- **Exceptional structural stability** – 2" thick sash adds beauty and increases insulating value; 1-1/4" jamb creates unmatched strength and stability; silicone-injected frame corners keyed and screwed to create a strong, water tight joint
- **Side stop functionality** – Side stops held in place with kerf and barb for easy removal and replacement

Glazing

- 3/4" inch double pane insulated glass comes standard with energy efficient Cardinal® LoE 366 coating; tinted, tempered, obscure and laminated glazing options available
- Double glazing and interior wood stops lend superior strength and sealing against moisture and air
- Custom and special glass types available
- Preserve protective film optional

Sizes

Available in custom sizes

Grilles

Windsor Divided Lite (WDL) = simulated divided lite

- 7/8" and 1-1/4" Perimeter Grille
- 7/8" and 1-1/4" Stick Grille
- 3/4" and 1" Profiled Inner Grille
- 13/16" Flat Inner Grille
- 7/8" and 1-1/4" Ogee WDL
- 5/8", 7/8", 1-1/4" and 2" Tall and Short Putty WDL
- 5/8", 7/8", 1-1/4" and 2" Tall and Short Contemporary WDL
- 2" Simulated Check Rail
- Standard and custom grille patterns available

Interior Trim and Accessories

- 11 trim profiles • Stool and apron
- 7 interior stops • Base shoe and cove
- Rosettes

Finishes

- Interior – Available in Clear Select Pine, Douglas Fir or Natural Alder
 - Primed: white or black
 - Painted: white, black or gray
 - Stained: 9 color options
- Exterior – Heavy-duty extruded aluminum cladding

Clad Colors

All clad colors painted in-house with the highly durable AAMA 2604 standard finish, or upgrade to AAMA 2605 for the most challenging of environments

- 23 Standard Clad Colors available in 2604 and 2605 finish
- 20 Feature Clad Colors available in 2604 and 2605 finish (Custom color matching is also available)
- 7 Matte Clad Colors available in the 2604 finish only

Hardware

Encore folding nesting crank and cover by Truth® available in champagne, white, bronze and black; optional finishes in faux bronze, oil rubbed bronze, satin nickel and bright brass

Performance Ratings

For current performance ratings, visit our website at windsorwindows.com and click on "Professional Information" in the menu bar



Type	Sill Angle	Revive Replacement Unit (Frame Size)				Existing Frame (Opening Size)			
		Min Width	Max Width	Min Height	Max Height	Min Width	Max Width	Min Height	Max Height
Wood Clad DH Operating	Any	16"	42"	18"	84"	16-1/2"	42-1/2"	18-3/8"	84-3/8"
Wood Clad AW Operating	Any	18"	60"	18"	60"	18-1/2"	60-1/2"	18-3/8"	60-3/8"
Wood Clad CS Picture	Any	16"	72"	12"	84"	16-1/2"	72-1/2"	12-3/8"	84-3/8"

Revive Hybrid Casement & Awning Pocket Replacement Window

Features and Benefits

- **Exceptionally easy to maintain** – Engineered, high-endurance cellular PVC sash will not decay, warp, crack, split or swell
- **Excellent thermal performance** – Cellular PVC sashes help keep the cold and heat outside – and help keep you comfortable inside
- **Sleek appearance and clean lines** – Single lever, sequential, multi-point lock for sleek look and easy operation
- **Low-maintenance exteriors** – Heavy-duty aluminum cladding protects the pocket frame
- **Easy sash operation** – Adjustable concealed hinge system ensures smooth operation
- **No crank handles to get in your way** – Recessed crank handle nests in the operator cover housing, keeping it out of the way of window treatments
- **Exceptional structural stability** – 2" thick sash adds beauty and increases insulating value; 1-1/4" jamb creates unmatched strength and stability; silicone-injected frame corners keyed and screwed to create a strong, water tight joint

Glazing

- 3/4" inch double pane insulated glass comes standard with energy efficient Cardinal® LoE 366 coating; tinted, tempered, obscure and laminated glazing options available
- Custom and special glass types available

Sizes

Available in custom sizes

Grilles

Windsor Divided Lite (WDL) = simulated divided lite

- 3/4" and 1" Profiled Inner Grille
- 13/16" Flat Inner Grille
- 7/8" and 1-1/4" Ogee WDL
- 5/8" and 7/8" Tall and Short Putty WDL
- 2" Simulated Check rail
- Standard and custom grille patterns available

Interior Trim and Accessories

- 11 trim profiles
- Stool and apron
- 7 interior stops
- Base shoe and cove
- Rosettes

Finishes

- Interior – Available in Clear Select Pine, primed or painted white interior finishes
- Exterior – Heavy-duty extruded aluminum cladding on frame and cellular PVC sashes

Clad Colors

All clad colors painted in-house with the highly durable AAMA 2604 standard finish, or upgrade to AAMA 2605 for the most challenging of environments

- 23 Standard Clad Colors available in 2604 and 2605 finish
- 20 Feature Clad Colors available in 2604 and 2605 finish (Custom color matching is also available)
- 7 Matte Clad Colors available in the 2604 finish only

Hardware

Encore folding nesting crank and cover by Truth® available in champagne, white, bronze and black; optional finishes in faux bronze, oil rubbed bronze, satin nickel and bright brass

Performance Ratings

For current performance ratings, visit our website at windsorwindows.com and click on "Professional Information" in the menu bar



Type	Sill Angle	Revive Replacement Unit (Frame Size)				Existing Frame (Opening Size)			
		Min Width	Max Width	Min Height	Max Height	Min Width	Max Width	Min Height	Max Height
Hybrid CS Operating	Any	16"	36"	18"	78"	16-1/2"	36-1/2"	18-3/8"	78-3/8"
Hybrid AW Operating	Any	18"	48"	18"	36"	18-1/2"	48-1/2"	18-3/8"	36-3/8"
Hybrid CS Picture	Any	16"	72"	12"	78"	16-1/2"	72-1/2"	12-3/8"	78-3/8"

Revive Vinyl Casement Pocket Replacement Window

Features and Benefits

- **Low-maintenance frames** – Vinyl stays looking great year after year – no need to paint or scrape your windows ever again
- **Superior weatherability and thermal performance** – Rugged, multi-chambered vinyl sash and frames optimize your home's energy efficiency year after year
- **Tight seal against the elements** – Two-sash, one-frame weatherstrip system keeps even extreme weather outside
- **One lever locks multiple points** – One easy-to-reach lever pulls the sash in at multiple locations for an airtight seal
- **No crank handles to get in your way** – Recessed crank handle nests in the operator cover housing, keeping it out of the way of window treatments
- **Easy to open and close** – Adjustable hinge system ensures proper alignment and smooth operation

Sizes

Available in custom sizes

Glazing

- 3/4" inch double pane insulated glass comes standard with energy efficient Cardinal® LoE 366 coating; tinted, tempered, obscure and laminated glazing options available
- Custom and special glass types available

Grilles

Windsor Divided Lite (WDL) = simulated divided lite

- 3/4" profiled inner grille
- 5/8" and 7/8" putty WDL (exterior only) with flat inner grille
- 5/8" and 7/8" putty WDL
- Standard and custom grille patterns available

Interior Trim and Accessories

- 11 trim profiles
- Stool and apron
- 7 interior stops
- Base shoe and cove
- Rosettes

Colors

- Available in standard white or clay, with seven additional painted exterior colors to choose from
- Interior black available on black painted exterior units

Hardware

Folding nesting crank and cover available in white, clay or black; color matched to window

Performance Ratings

For current performance ratings, visit our website at windsorwindows.com and click on "Professional Information" in the menu bar



Type	Sill Angle	Revive Replacement Unit (Frame Size)				Existing Frame (Opening Size)			
		Min Width	Max Width	Min Height	Max Height	Min Width	Max Width	Min Height	Max Height
Vinyl Casement Operating	0-14 Degree	15-1/2"	35-1/2"	17-1/2"	71-1/2"	16"	36"	17-7/8"	71-7/8"
Vinyl Casement Picture	0-14 Degree	15-1/2"	95-1/2"	11-1/2"	95-1/2"	16"	96"	11-7/8"	95-7/8"

Revive Sash Replacement Kits

Three easy steps to install your new windows.

Replace old, drafty, inefficient double hung sashes with energy-efficient, dual pane sashes. Windsor's Revive Sash Replacement Kits make it easy. Each kit allows you to keep your existing interior trim and plaster in place. In addition, you have a choice of three replacement sashes: versatile primed wood; durable aluminum clad or; long-lasting, hassle-free cellular PVC. All sash options feature EZ Tilt for fast access and effortless cleaning. No matter your choice of Revive Sash Replacement Kit, you'll instantly improve the beauty, energy efficiency and upkeep of your home's windows.

STEP ONE: Measure Opening



Quick and minimally invasive installation

Note: Windsor's Revive Sash Replacement Kits are designed to replace wood double hung windows. The wood side jamb pocket depth between the inside stop and the outside stop MUST measure at least 3-3/8" to accommodate the Revive sash replacement jambliner and clip.

STEP TWO: Remove Old Sash



STEP THREE: Install New Sash



Options & Accessories

Windsor's in-house powder paint application can help you make a statement with your windows and doors. Choose from over 50 shades in our standard and feature color palettes, or make it truly unique with custom color matching or our matte finish colors. All paints are protected with the highly durable 2604¹ finish, or you can upgrade to 2605² for even stronger defense against the elements.³

STANDARD CLAD COLORS (REVIVE WOOD CLAD & HYBRID) Available in 2604 and 2605 finish.



FEATURE CLAD COLORS (REVIVE WOOD CLAD & HYBRID)

Available in 2604 and 2605 finish. Custom color matching is also available.



MATTE CLAD COLORS (REVIVE WOOD CLAD & HYBRID)

Available in the 2604 finish only.

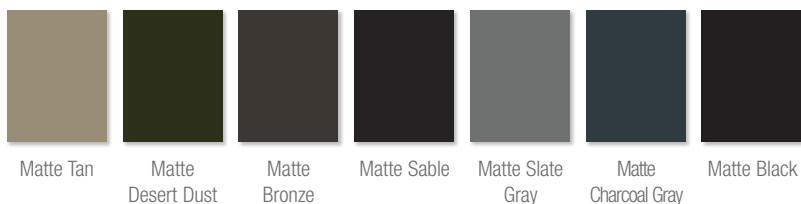

¹AAMA 2604 finish backed by a 20-year warranty. ²AAMA 2605 finish backed by a 30-year warranty. ³For applications within one mile of the coast, AAMA 2605 finish will carry a 10-year warranty and AAMA 2604 will carry no warranty. For specific warranty details, please refer to the complete warranty document posted on our website, www.windsorwindows.com.

INTERIOR FINISHES (REVIVE WOOD CLAD & HYBRID)

Wood Clad: Available in all finishes.

Hybrid: Available in Clear Select Pine, primed white or painted white (standard on double hung).

Interior Wood Species

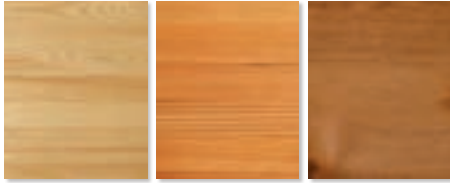

Clear Select Pine* Douglas Fir Natural Alder

Interior Primed Finishes

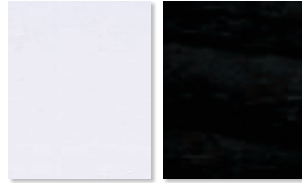

White Primed* Black Primed
(Available in Clear Select Pine only)

Prefinished Painted Interiors

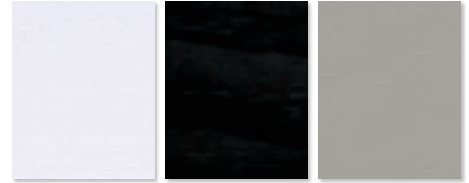

Painted White* Painted Black Painted Gray

* Denotes options available for Hybrid

Prefinished Stained Interiors CLEAR COAT AND STAIN SAMPLES ARE SHOWN ON CLEAR SELECT PINE AND REPRESENT OPTIONS AVAILABLE. ACTUAL FINISH MAY VARY.

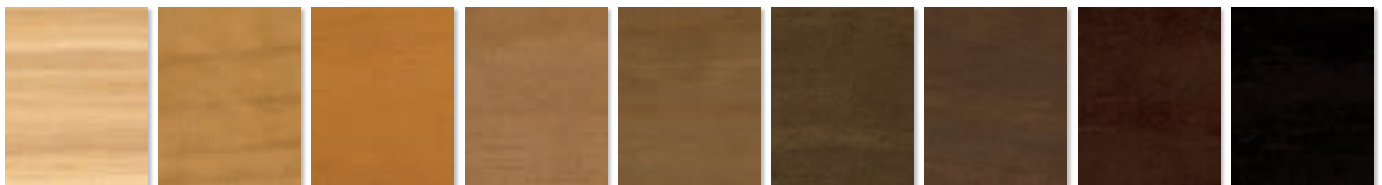

Clear Sunlight Provincial Tea with Milk Antique Barrel Perfect Brown Intensive Chestnut Espresso

STANDARD VINYL COLORS



White Clay

PAINTED VINYL INTERIOR COLORS



Black*

*Only available with Painted Black Exteriors

PAINTED VINYL EXTERIOR COLORS

White vinyl interior is available with white, ivory, tan, bronze, cinnamon, hunter green or black exterior. Clay vinyl interior is available with bronze or black exterior.



White Ivory Tan Bronze Cinnamon Hunter Green Black

INTERIOR TRIM ACCESSORIES

Custom-fitted wood trim is available in Clear Select Pine.



WM 327 • 2-1/4"



WM 356 • 2-1/4"



WM 366 • 2-1/4"



WM 351 • 2-1/2"



WM 361 • 2-1/2"



WM 445 • 3-1/4"



WM 444 • 3-1/2"



RB 03 • 3-1/2"



WM 473 • 2-1/4"



WM 433 • 3-1/4"



WM 412 • 3-1/2"

Stool and Apron

Only Available in Double or Single Hung windows



WM 1021 • 5-1/4"



B 200 • 11/16" x 2-1/2"

Rosettes



Rosette • 2-3/4"



Rosette • 3-3/4"

Base Shoe and Cove



WM 100 • 11/16" x 11/16"



WM 106 • 11/16" x 11/16"



WM 129 • 7/16" x 11/16"

Interior Stops



830 8U • 1/2" x 1/2"



WM 941 • 7/16" x 3/4"



WM 876 • 7/16" x 1-3/8"



WM 254 • 1/2" x 3/4"



WM 937 • 7/16" x 1-1/4"



WM 267 • 1/4" x 1-5/6"



WM 887 • 7/16" x 1-1/4"



DIRECT SET AND RADIUS OPTIONS



Round



Half Round



Quarter Round



Seg-top Quarter



Seg-top



Extended Quarter Round



Round Top



Ellipse



Eyebrow

Direct Set Special Shapes



Rectangle

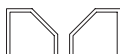

Flat-top Trapezoid

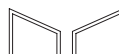

Trapezoid

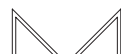

Right Triangle



Triangle



Parallelogram



Octagon



Hexagon



Pentoid



Flat-top Pentoid

Radius Inner Grille Patterns

Note: Before selecting a special grille pattern, confirm alignment with units below.



Pattern 1
3-spoke
Standard



Pattern 2
5-spoke
Standard



Pattern 3
Single Radius
Starburst
42" HR & up



Pattern 4
Double Radius
Starburst
60" HR & up



Pattern 5
Single Radius
Sunburst
42" HR & up



Pattern 6
Double Radius
Sunburst
60" HR & up



1-spoke
Quarter Round



2-spoke
Quarter Round



3-spoke
Ellipse

PATIO DOOR HANDLES, HINGES AND WINDOW HARDWARE (REVIVE WOOD CLAD & HYBRID)

Finishes marked with asterisks* feature a clear coating that protects the finish against tarnish and peeling. This process extends the rich, bright life of the finish and dramatically delays the aging process. (Photos show Satin Nickel finish.) Bi-fold doors are available with the contemporary swinging handle in Satin Nickel, Brass and Oil Rubbed Bronze.

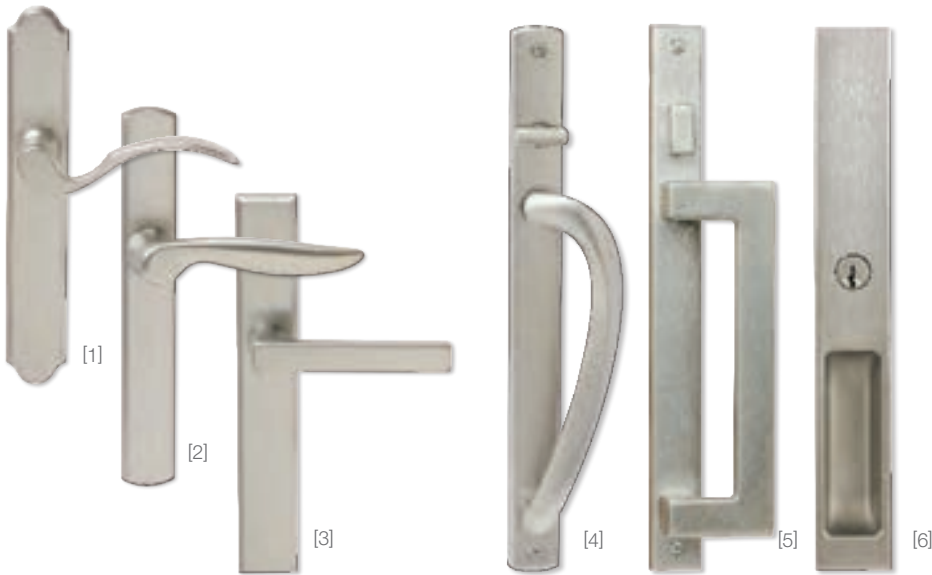

PATIO DOOR HANDLE STYLES

Available in all 10 door handle finishes, unless noted.

- [1] Classic Swinging Door Handle
- [2] Contemporary Swinging Door Handle
- [3] Euro Swinging Door Handle
Only available in Satin Nickel and Black door handle finishes.
- [4] Contemporary Sliding Door Handle
- [5] Euro Sliding Door Handle
Not available in antique nickel.
- [6] Flush Mount Sliding Door Handle
Only available in Satin Nickel, Faux Bronze, Oil Rubbed Bronze and Black door handle finishes.

SWINGING PATIO DOOR HINGES

Available in all 10 door handle finishes.

- [7] Adjustable Guide Hinge
- [8] Adjustable Set Hinge
- [9] Ball Bearing Hinge

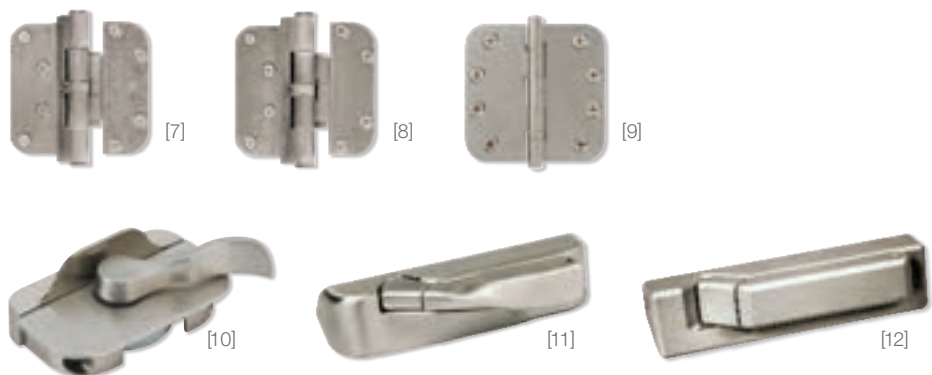

WINDOW HARDWARE STYLES

[10] Double Hung Lock

Available in all eight window hardware finishes.

[11] Traditional Casement/Awning Crank

Available with matching lock in all eight window hardware finishes.

[12] Contemporary Casement/Awning Crank

Available with matching lock in all eight window hardware finishes.

PATIO DOOR HANDLE AND HINGE FINISHES (REVIVE WOOD CLAD & HYBRID)

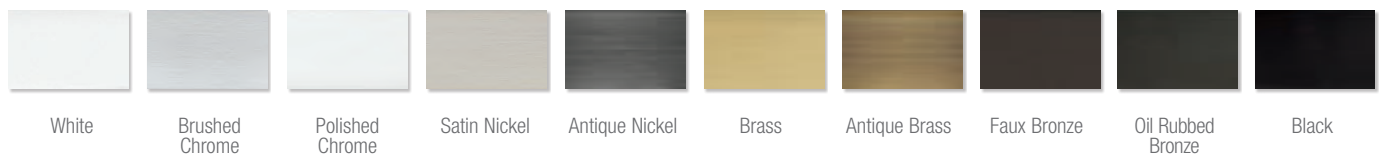

WINDOW HARDWARE FINISHES (REVIVE WOOD CLAD & HYBRID)

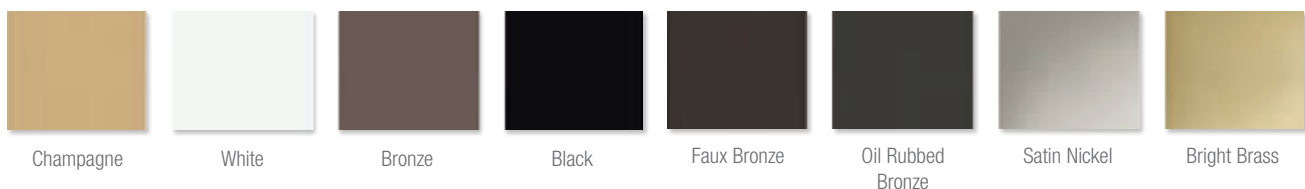

WINDOW HARDWARE (REVIVE VINYL) Hardware is available in white, clay or black.



Classic Single Hung and Slider Lock



Signature Casement and Awning Crank and Lock



Classic Double Hung Lock



Pro Single Hung and Slider Lock



Available in white or clay. Black available on Slider only.

Sliding Patio Door Handle and Finishes Finishes are the same for both interior and exterior handles.



Sliding Patio Door Blinds Between the Glass All vinyl sliding patio doors are handled from the exterior.

The images shown below are viewed from the interior looking out to show proper location of blind/tilt and raise/lower mechanism.

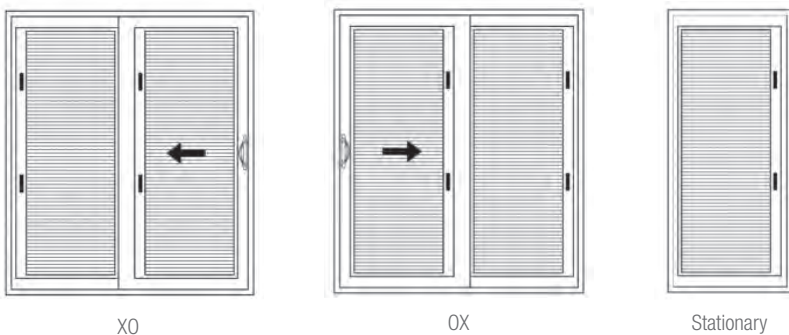

GRILLES (REVIVE WOOD CLAD & HYBRID)

All of our wood and cellular PVC (CPVC) Windsor Divided Lite bars are hand-fitted to ensure a perfect fit.

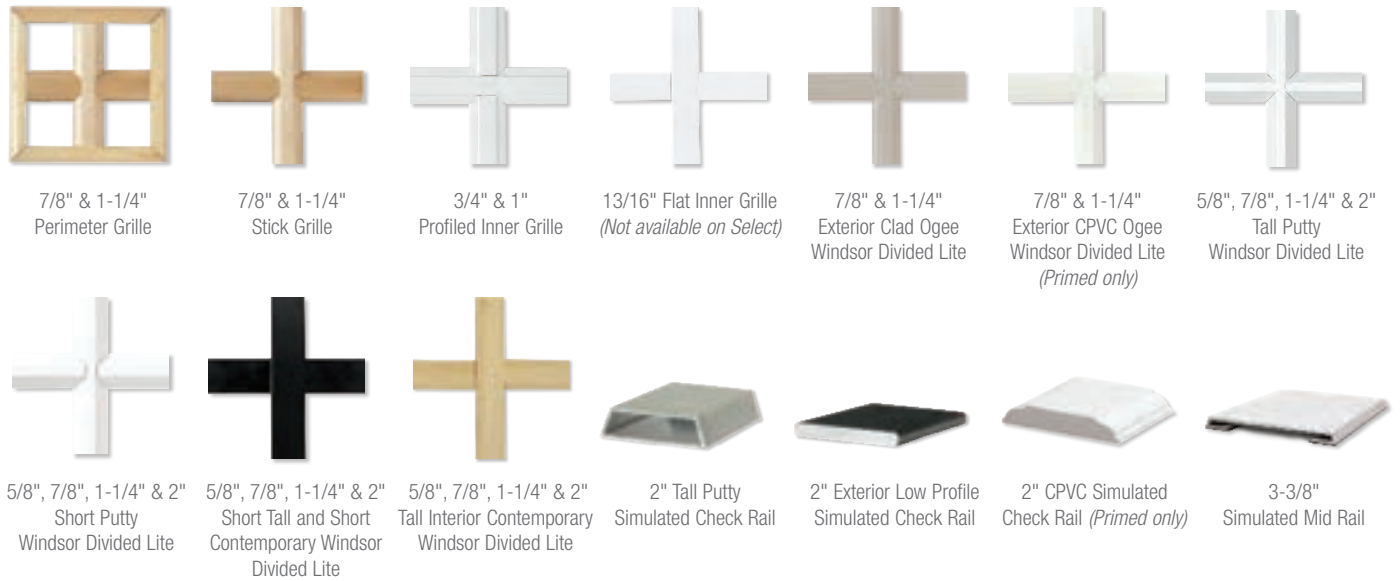

GRILLES (REVIVE VINYL) All cellular PVC Windsor Divided Lite (WDL) bars are hand-fitted to ensure a perfect fit.

WDL bars are available in Classic and Signature casement, awning, direct set and radius windows.

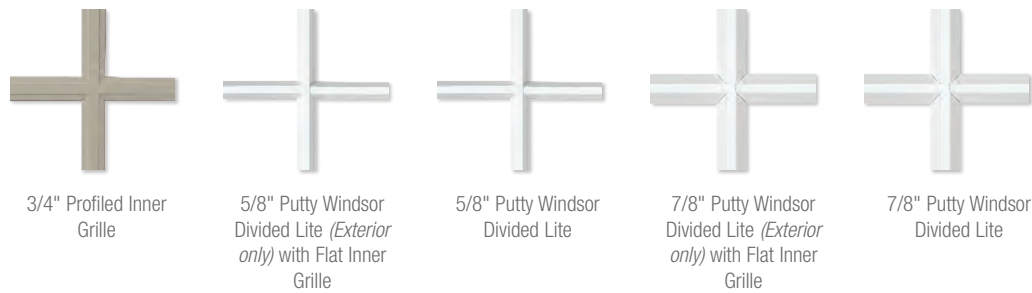

SCREENS

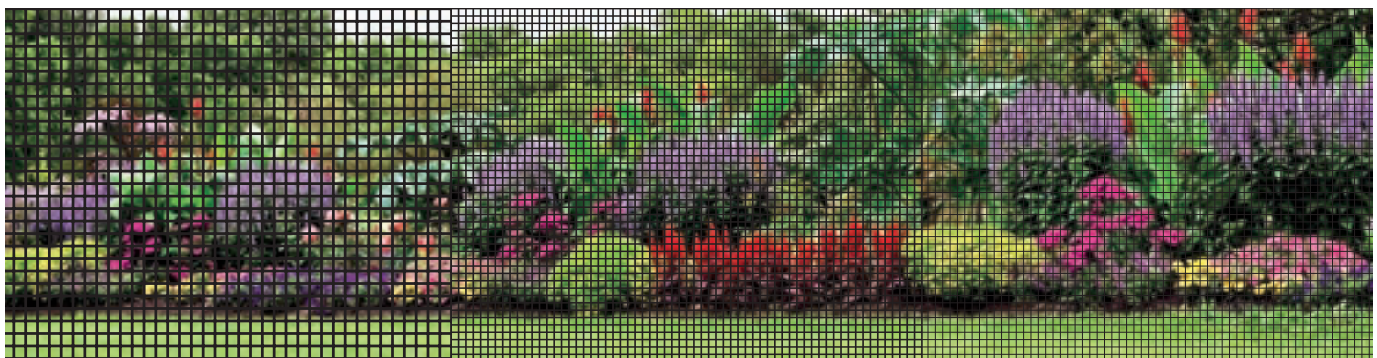

Conventional Screen Mesh

BetterVue® (Standard)

UltraVue®

GRILLE PATTERNS

Some grille patterns are not available in all configurations and products.

Casement and Awning Grille Patterns

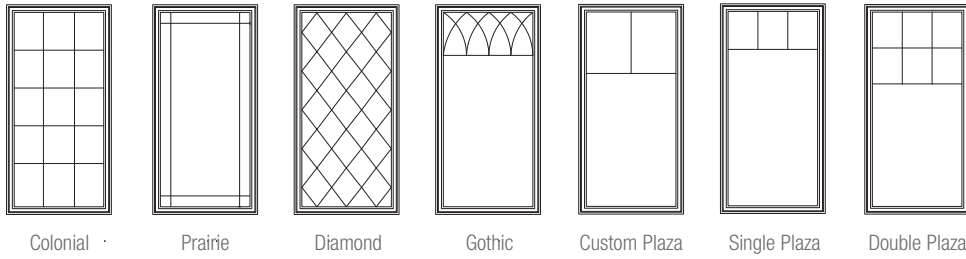

Colonial Prairie Diamond Gothic Custom Plaza Single Plaza Double Plaza

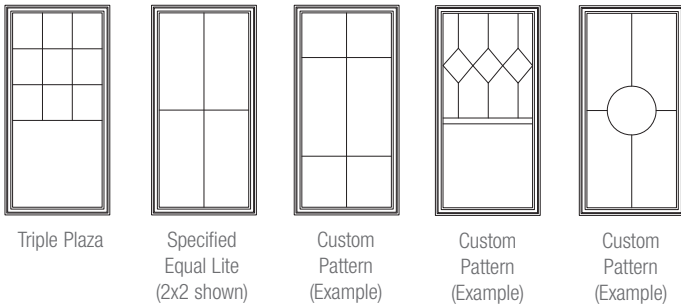

Triple Plaza Specified Equal Lite (2x2 shown) Custom Pattern (Example) Custom Pattern (Example) Custom Pattern (Example)

Patio Door Grille Patterns

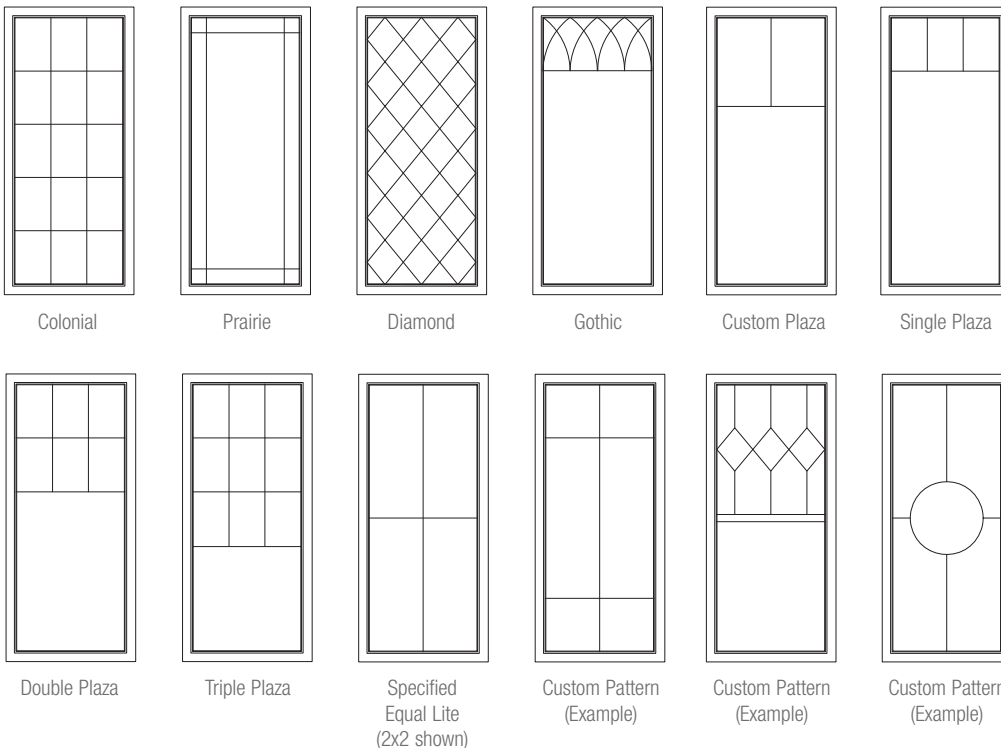

Colonial Prairie Diamond Gothic Custom Plaza Single Plaza

Double Plaza Triple Plaza Specified Equal Lite (2x2 shown) Custom Pattern (Example) Custom Pattern (Example) Custom Pattern (Example)

Single and Double Hung Grille Patterns

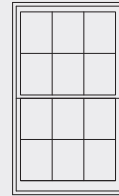

Colonial

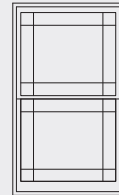

Prairie

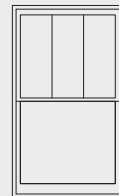

Plaza

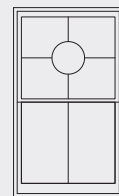

Custom Pattern (Example)

GLASS *Special order item

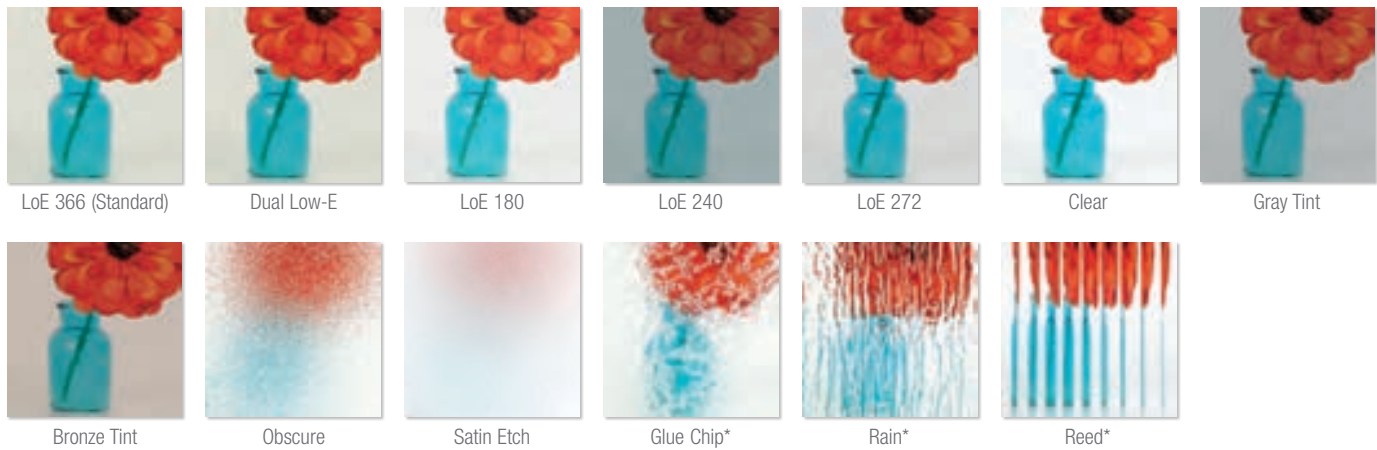

SASH REPLACEMENT FEATURES

Options	Primed Wood	Aluminum Clad	Cellular PVC
3/4" LoE 366 Insulated Glass	Yes	Yes	Yes
Weatherstrip Points	4	4	4
Factory-installed Locks	Champagne, white, bronze, black, faux bronze, oil rubbed bronze, satin nickel or bright brass	Champagne, white, bronze, black, faux bronze, oil rubbed bronze, satin nickel or bright brass	Champagne, white, bronze, faux bronze or satin nickel
Exterior Finish	Primed wood	23 standard colors, 20 feature colors or 7 matte colors	White CPVC
Interior Finish	Clear Select Pine	Clear Select Pine, Douglas Fir, Natural Alder, primed, painted white, painted black, painted gray, 8 stains or clear coat	White CPVC
Adjustable Vinyl Jambliners	White or beige	White or beige	White
Sill Bevel	14°	14°	14°
Standard Sizes	84	84	72
EZ Tilt Feature	Yes	Yes	Yes
Block & Tackle Balance System	Yes	Yes	Yes

Upgrades			
Custom Sizes¹	Yes	Yes	Yes
Primed Interior	Yes	Yes	Standard
Tempered or Tinted Glass²	Yes	Yes	Yes
Heavy-duty Insect Screen³	23 standard colors, 20 feature colors or 7 matte colors		
Custom Sill Bevels (Jambliners Only)⁴	Yes	Yes	Yes

Grilles			
13/16" Flat Inner Grille (GBG, GIA)	White, ivory, tan, bronze, hunter green, cinnamon, black or clay		
3/4" Profiled Inner Grille	White, ivory, tan, bronze, hunter green, cinnamon, black or clay		
1" Profiled Inner Grille	White, ivory, tan, bronze, hunter green, cinnamon, black or clay		
Standard Windsor Divided Lite (Simulated Divided Lite)	Exterior: 7/8" or 1-1/4" CPVC; Interior: Clear Select Pine	Exterior: 7/8" or 1-1/4" extruded aluminum; Interior: Clear Select Pine, Douglas Fir or Natural Alder	Exterior: 7/8" or 1-1/4" CPVC; Interior: CPVC
Putty Windsor Divided Lite (Simulated Divided Lite)	Exterior: 5/8" or 7/8" CPVC; Interior: Clear Select Pine	Exterior: 5/8" or 7/8" extruded aluminum; Interior: Clear Select Pine, Douglas Fir or Natural Alder	Exterior: 5/8" or 7/8" CPVC; Interior: CPVC
Removable Wood Perimeter	7/8" or 1-1/4" Clear Select Pine	7/8" or 1-1/4" Clear Select Pine	No

1. Custom sizes in 1/4" increments. Kit may be adjusted to fit sash opening width 1/4" (max.) wider than standard size, via jambliner adjustment. The sash opening height cannot vary from standard. Openings larger than standard must be shimmed to standard size; smaller heights must be ordered as custom size.
2. Other glass options available; contact your Windsor distributor/dealer.
3. The insect screen is constructed of painted aluminum. Screen size ordered separate of the sash. The screen utilizes plungers, which need to engage grommets/holes in the exterior trim to hold the screen in place. These grommets/holes need to be installed on site and are not included.
4. Must specify bevel: 10° minimum/20° maximum.

Visit Us Online

PRODUCT DIMENSIONS

Click "Professional Information" in the menu bar, then select "Cad Drawings, Sizes, Performance & Specifications" from the drop down.

DEALER LOCATOR

Click "Dealer Locator" in the menu bar, then enter your city and state and/or your ZIP code to find an authorized Windsor distributor in your area.

IDEAS AND INSPIRATIONS

Click "Products" in the menu bar, then select "Ideas & Inspiration" from the drop down.

WARRANTY, INSTALLATION AND CARE & USE GUIDES

Click "Professional Information" in the menu bar, then select "Warranty, Care & Installation" from the drop down.

ADDITIONAL LITERATURE

Click "Professional Information" in the menu bar, then select "Product Literature" from the drop down.

Windsor products are sold by select dealers across the United States, Mexico and Canada. Visit a dealer for a personalized demonstration of windows and doors and see for yourself how Windsor can be your answer for quality products and passionate service.



Corporate Site
www.windsorwindows.com



Pinnacle microsite
www.windsorpinnacle.com



Legend microsite
www.windsorlegend.com



Next Dimension microsite
www.windsornextdimension.com



Revive microsite
www.windsorrevive.com



Grab your PowerTools and let's get to work!

PowerTools, Windsor's quoting software (commonly referred to as PTQ), is a suite of applications that provide all of the necessary information for supplying accurate quotes, submitting orders and tracking shipments. You will have access to additional assets that will assist you in marketing your business and promoting Windsor products...all within one convenient and powerful tool.



CONNECT WITH US



900 South 19th Street, West Des Moines, IA 50265 • 515.223.6660 • 800.218.6186
2210 Stafford Street Extension, Monroe, NC 28110 • 704.283.7459 • 800.205.5665

www.windsorwindows.com

A WOODGRAIN COMPANY

© 2022 Woodgrain Millwork Inc. Woodgrain Millwork, Windsor, the Windsor Lion logo, Next Dimension and Legend are registered trademarks of Woodgrain Millwork Inc. Windsor Windows & Doors, Pinnacle, Revive and Redstone are trademarks of Woodgrain Millwork Inc.

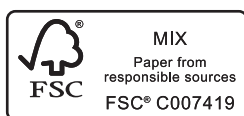

Windsor Windows & Doors is an ENERGY STAR® partner and an NFRC and WDMA member. Windsor products are certified and labeled according to the guidelines established by the National Fenestration Rating Council (NFRC).