

DIAMOND
SCIENTIFIC

MRU LABS

OPTIMAX

USER MANUAL



Producer:



**MRU · Messgeräte für Rauchgase
und Umweltschutz GmbH**

Fuchshalde 8 + 12

74172 Neckarsulm-Obereisesheim

Fon 07132 99620 · Fax 07132 996220

info@mru.de · www.mru.eu

Legal notices / Intellectual property rights comments

Original user manual

© 2022 by MRU

No part of this manual may be published in any form (print, fotocopy, electronic media or any other publication form) without a written approval by the publisher.

All user trade marks and name mark descriptions, even those which are not marked as such, are properties of the respective owners.

Edition: 2022-11-02,V.1.11.US

Table of contents

1	Information for product and safety	7
1.1.	Safety manual	7
1.2.	Safety precautions.....	7
1.3.	Ensure safety	8
1.4.	Important general information (EN 50379 and VDI 4206)	8
1.5.	User guideline for rechargeable batteries.....	10
2	Introduction	11
2.1.	Intended use	11
2.2.	About us.....	13
2.3.	Packaging.....	14
2.4.	Return of hazardous materials	14
2.5.	Return of electronic equipment	14
3	Description	15
3.1.	Gas flow diagram	15
3.2.	Analyser	16
3.3.	Condensate separator (water trap)	17
3.4.	Extraction probes.....	20
4	Operating	21
4.1.	Display.....	21
4.2.	Keypad.....	22
4.3.	Menu structure	23
5	First usage	24
5.1.	Preparatory steps.....	24
5.2.	Customize settings.....	24
5.3.	Export and import settings.....	25
	Export user settings	25
	Import user settings.....	26
5.4.	Set measurement	26
5.5.	Set Bluetooth parameters.....	27
5.6.	Setting date and time.....	28
5.7.	Configure measurement program.....	28
5.8.	Set CO-Limit.....	29
5.9.	Change measurement program name.....	29
5.10.	Select fuel types and O ₂ reference	30
	Add fuels to fuel type selection	30
	Set O ₂ -reference	31
5.11.	Define user fuel type	31
5.12.	Define measurement window.....	33
5.13.	Configure zoom window	34
6	Prepare measurement.....	35
6.1.	Perform overall visual inspection.....	35
6.2.	Ensure power supply	35
6.3.	Automatic Auto-off function	35

6.4.	Measuring with grid power supply / Battery charging.....	35
6.5.	Measurements in battery mode (battery monitoring).....	35
6.6.	Operating temperature	36
6.7.	Control Condensate separator	36
6.8.	Connections and tightness	36
6.9.	Automatic zero point	37
	Repeat zeroing.....	37
7	Performing measurement.....	38
7.1.	Select measurement menu	38
7.2.	Perform Biogas measurement.....	39
7.3.	Perform Exhaust Gas measurement.....	40
	Measurement window	41
	CO purging.....	41
7.4.	Perform Ambient air check.....	42
7.5.	Temporary buffer.....	43
	Store values into temporary buffer.....	43
	Overwrite measured values in temporary buffer	45
7.6.	Perform Annular-gap test.....	46
7.7.	Perform Test program.....	47
7.8.	CO/H ₂ and CO high (optional)	47
7.9.	Non-continuous draft measurement.....	47
7.10.	Perform pressure measurement.....	48
7.11.	Perform Differential temperature measurement.....	49
7.12.	Store measurement values.....	50
	Enter T-boiler, Soot and Derivative	51
7.13.	Print measurement values.....	52
	Open menu print-out.....	52
	Print measurement results with Speedprinter	53
	Print measurement results with Highspeed-Bluetooth-Thermoprinter	55
7.14.	Stop measurement	56
7.15.	Last measured values	56
8	Data storage	57
8.1.	Organize data storage.....	57
8.2.	Call up information about Memory info	57
8.3.	Sites administration.....	58
	Create new site	58
	View sites	59
	Change sites	59
	Delete sites.....	60
8.4.	Transfer data via using SD card.....	61
	Import sites	62

Export sites.....	63
Export measurements	64
8.5. Measurements in Data storage.....	65
View measurements	65
Delete measurements	66
9 Extras / Adjustment	68
9.1. Service menu.....	68
9.2. Default settings	69
9.3. Service values.....	70
9.4. Performing leak test.....	71
9.5. Contents SD card	72
9.6. Device info	73
Options list	73
Service history.....	74
10 Maintenance and care	75
10.1. Cleaning and care.....	75
10.2. Maintenance.....	75
10.3. Service messages.....	75
11 Option Gas flow measurement	76
11.1. Connect Prandtl (Pitot) tube to analyser	76
11.2. Open menu Gas flow measurement	77
11.3. Define settings and parameters	78
11.4. Enter Cross section area	79
11.5. Perform measurement.....	79
12 Option: Monitoring flow rate	81
13 Option: Auto-measurement	82
14 Appendix	84
14.1. Technical data.....	84
General Data.....	84
Measured values	84
Analysis and calculations	87
14.2. Reset analyser	88
14.3. Troubleshooting	89
Troubleshooting on the analyser	89
Troubleshooting condensate separator	90
14.4. Update firmware.....	91
Check current firmware version.....	91
Prepare SD card.....	91
Perform firmware update.....	91
Check new firmware version.....	93
14.5. Display your own logo.....	94

Create your own logo.....	94
Import logo into analyser.....	96
Delete logo.....	96
15 Declaration of conformity.....	97

1 Information for product and safety

1.1. Safety manual





All general information and safety precautions of MRU products are listed in the supplied separate safety manual.

Therefore, this manual must be read and observed before the first use of the instrument.

Instrument-specific safety and warning requirements in this manual are prefixed before dangerous actions.

1.2. Safety precautions

The used categories of safety precautions are here explained once more.

	<p style="text-align: center;">⚠ DANGER</p> <p>Identifies an immediate, impending hazard that, if ignored, will result in severe bodily injuries or death.</p>
	<p style="text-align: center;">⚠ WARNING</p> <p>Identifies an immediate, impending hazard that, if ignored, may result in severe bodily injuries, material damage or death.</p>
	<p style="text-align: center;">⚠ CAUTION</p> <p>Identifies a possibly dangerous situation that, if ignored, may result in minor injuries.</p>
	<p style="text-align: center;">ATTENTION</p> <p>Identifies a possibly harmful situation that, if ignored, may result in damages to the device or its surroundings.</p>
	<p style="text-align: center;">NOTE</p> <p>Identifies user tips and other especially important information.</p>

The explanation of safety notices:

	<p style="text-align: center;">⚠ CAUTION</p> <p>HOT – danger of burns and fire hazards from gas extraction probe.</p> <p>Physical harm and property damage can be caused.</p> <p>▶ Cool down the probe tube.</p>
---	--

1.3. Ensure safety

- ▶ Please read the user manual completely before the first use.
- ▶ Only use the analyser for the intended use and within the parameters specified in the technical data.
- ▶ Do not use any violence.
- ▶ Avoid falls
- ▶ Do not put the analyser into use, if the housing, power supply unit or supply leads are damaged.
- ▶ Do not store the analyser together with solvents. Do not use desiccants.
- ▶ Only carry out maintenance and service work on this analyser as described in the User Manual. Observe the prescribed action steps.
- ▶ Operate the analyser only in closed, dry rooms and protect it from rain and moisture.
- ▶ When operating the analyser on mains power, operate it only with the mains adapter supplied.
- ▶ Do not use the metal tube of the gas sampling probe or other metallic parts / accessories as electrical conductors.
- ▶ The analyser must not be located in the immediate vicinity of open fire or great heat.
- ▶ The specified temperature range of the gas sampling probe must not be exceeded, otherwise the probe tube and temperature sensor will be destroyed.

1.4. Important general information (EN 50379 and VDI 4206)

- This analyser is not designed to be used for continuous measurements.
 - Before using the analyser verify the condition of the various parts of the analyser, such as the probe, the ambient air conditions, the condensate separator, star filter and the connectors for damage and/or blockages.
 - When starting up the analyser it will take between 1 – 3 minutes to set to zero depending on the condition of the sensors and of ambient. The minimum zeroing time of the analyser to achieve correct measurement values can be expected by 1.5 minutes. Exposure to acids; aggressive gases such as sulphur; vapours such as thinners, gasoline, alcohol and paint, etc. can damage, reduce the life of, or destroy the sensors.
 - The life of the sensors depends on how they are used, maintained and treated. Typical average life expectations are: O₂ - 3 years; CO - 2 - 3 years, H₂S 2 years and NO - 3 years.
 - The use of the analyser for regulatory purposes is subject to special regulations (for example a periodical examination of the analyser). Please obtain the appropriate regulations from your local responsible authority.
- Biogas or other similar gases (landfill gas, bio-methane, coal seam gas etc) is containing flammable component CH₄ and toxic component as well (H₂S and CO₂).

Analysers sample a certain volume of the biogas and vent it to the ambient air.

For this reason, there are two aspects which must be considered:

- 1) toxicity danger of sample gas
- 2) flammable (explosion) danger of sample gas

1) Inhaling toxic gases is harmful to health and can even cause death in some cases.

- It is the responsibility of analyser user to ensure that person is skilled and trained in safety aspects of gases being analysed and procedures to follow while using this instrument.
- Local regulations for possible exposition to toxic gases have to be known by the user and obeyed by the user of the analyser
- Using a personal gas detector inside the biogas plant is highly recommended since H₂S in higher (very dangerous concentration) cannot be detected by human nose. Only small concentrations around few ppm can be detected by human nose
- CO₂ gas is heavier than air and therefore operator shall avoid using portable biogas analyser at underground levels. Beside of that CO₂ is also odourless.
- It is not allowed using the portable biogas analyser in confined space or rooms without sufficient ventilation.
- Sample gas exiting the analyser will flow in the ambient air and only outdoor use or forced ventilation rooms are suitable for using the portable biogas analyser

2) Regarding flammable gases (e.g. CH₄ methane) and hazardous area of operating the instruments, user must also be able to recognize the area classification and be aware of using the instrument there. This area classification is country specific, please observe and notice it.

- Instruments may be operated in hazardous areas zone 2 by skilled users obeying local guidelines e.g. by using LEL gas detectors

1.5. User guideline for rechargeable batteries



NOTE

The rechargeable batterie is installed inside the analyser and is not accessible to the end customer. However, the following instructions must generally be observed when handling lithium-ion rechargeable batteries.

- ▶ The rechargeable battery can only be used in this analyser.
- ▶ Do not throw the rechargeable battery into a fire, charge it at high temperatures and store it in a hot environment.
- ▶ Do not deform, short-circuit or modify the rechargeable battery.
- ▶ The rechargeable battery must not be used in or under water.
- ▶ Do not expose the rechargeable battery to strong mechanical forces and do not throw it.
- ▶ Do not cut or squeeze the connecting cables of the rechargeable battery.
- ▶ Do not carry or store the battery together with sharp-edged objects.
- ▶ Do not connect the (+) contact to the (-) contact or metal.
- ▶ Non-observance of the above guidelines can cause heat, fire and explosions

2 Introduction

- This manual enables you to understand and safely operate this MRU Analyser.
- Please read this manual with great vigilance and get familiar with the product before using it.
- This Analyser may only be operated by competent personnel and for its intended use.
- Please pay special attention to all safety directions and warnings to prevent personal injuries and damaging of the product.
- We can't be held responsible for any injuries and/or damages that occur by not following the instructions in this manual.
- Always keep the manual near you when working with the analyser, to be able to read instructions as needed
- Please ensure to hand over all documents to when handing the analyser over to others.

2.1. Intended use

The Analyser is used:

- for BIOGAS simultaneous measurements of O₂, CH₄, CO₂, H₂S and optional the BIOGAS pressure
- optional for combustion measurements of the engine: O₂, CO, NO, NO₂ and CO₂ (NDIR) including the calculation of mg/m³, NO_x as mg/m³ NO₂, true NO_x-measurement NO_x = NO + NO₂, referencing (normalisation) to user settable value

It can also be used (when options are activated or external equipment is used) for a number of measurement tasks, such as:

- Flow velocity measurement
- Differential measurement of pressure and temperature
- Combustibles detection with external HC sensor
- Automatic measurement with data logging

You will find a list of all options for this analyser on our web page or you can contact MRU or our local representative. The BIOGAS Analyzer is available in different versions. This manual will describe all versions indicating options and features not always available on all versions.

Diagram **BIOGAS** site

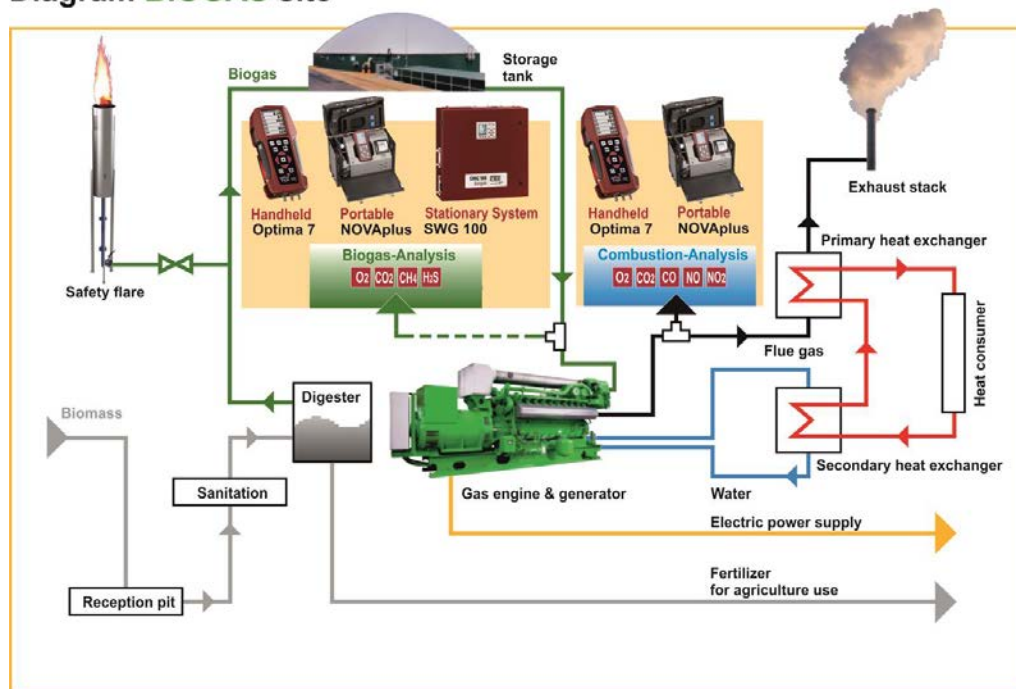

⚠ WARNING



Risk from manipulations to the measuring device

Operational safety hazard

- ▶ Modifications or changes to the measuring device are not allowed.

Our analysers are checked according to the following regulations: **VDE 0411 (EN61010)** and **DIN VDE 0701** before they leave the MRU GmbH factory.

MRU technical products are designed and manufactured according to **DIN 31000/ VDE 1000** and **UVV = VBG 4** of the professional guilds for fine mechanics and electrical engineering.

We assures that the analyser complies to the essential requirements of the legal regulations of the member states of the electro-magnetic compatibility **(2014/30/EU)** and to the low-voltage regulations **(2014/35/EU)**.

2.2. About us

The analyser is produced by the MRU GmbH in Neckarsulm, Germany (Founded in 1984), a medium sized company that specializes in developing, producing and marketing high quality emission monitoring analysers.

MRU GmbH produces a wide range of instruments, from standard analysers up to tailor made industrial analysers.



Plant 1: Sales, Service, R&D



Werk 2: Production

MRU GmbH
Fuchshalde 8 + 12
74172 Neckarsulm - Obereisesheim
GERMANY

Fon +49 71 32 99 62 0 (Zentrale)
Fon +49 71 32 99 62 61 (Kundendienst)
Fax +49 71 32 99 62 20
Email: info@mru.de
Internet: www.mru.eu

2.3. Packaging

Save the original carton and packing materials to prevent damage in transit in case you need to return the unit to the factory.

2.4. Return of hazardous materials

Waste Disposal/Returns/Warranty - MRU is required to accept the return of hazardous waste such as electro-chemical sensors that cannot be disposed of locally.

Hazardous waste must be returned to MRU prepaid.

2.5. Return of electronic equipment

MRU is required to accept the return, for proper disposal, of all analysers delivered after 13th of August 2005. Analysers must be returned to MRU prepaid.

3 Description

3.1. Gas flow diagram

The analyser extracts a partial volume of the biogas and analyses it for its components using NDIR and electrochemical sensors.

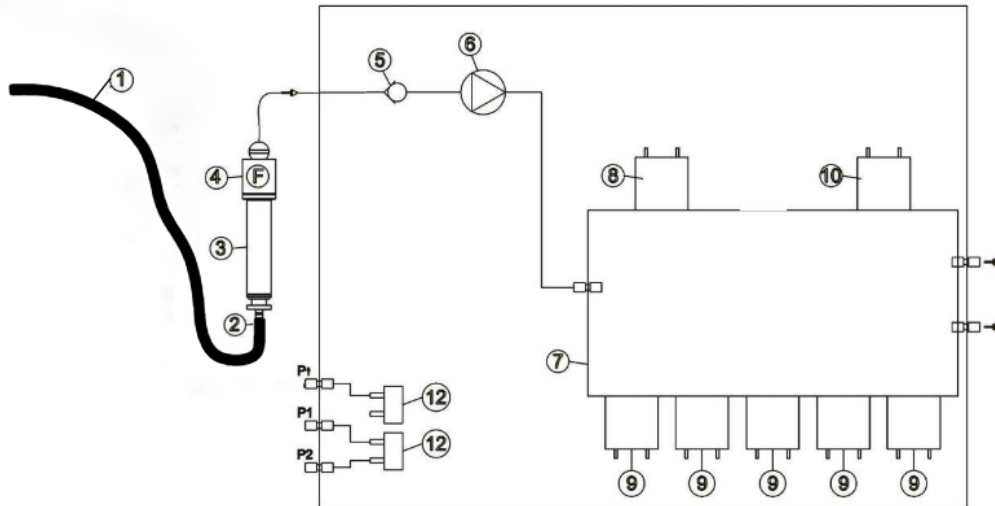

Position	Description
1	Biogas sampling hose
2	Connection to gas outlet
3	Condensate separator
4	Star filter
5	Non return valve
6	Gas pump
7	Sensor chamber
8	O2-Sensor
9	Further electrochemical sensors * (CO, NO ₂ , H ₂ S)
10	NDIR
11	not used
12	Pressure sensor *

*optional

3.2. Analyser

The analyser consists of a compact and robust glass-fiber reinforced plastic housing. All connections relevant for the measurement are located on the bottom of the analyser.

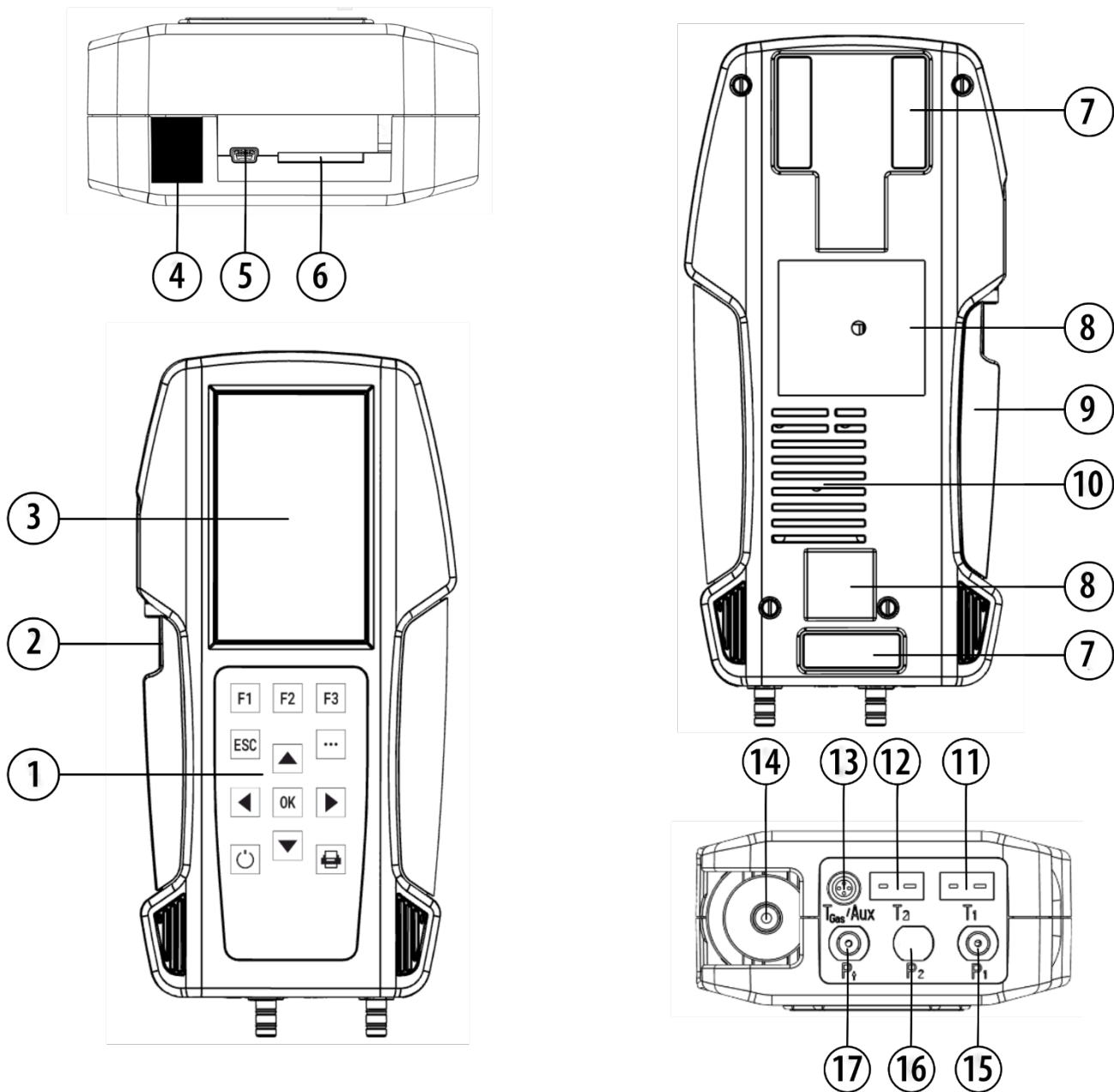

Position	Description	Position	Description
1	Keypad	10	Gas outlet
2	Condensate separator	11	Temperature connection T1 / T-Ambient air
3	Display	12	Temperature connection T2 / T-gas
4	IR-Interface	13	Connector AUX
5	USB-Port / Charging port	14	Sampling probe connection Condensate separator
6	SD-card reader (Only by using an MRU-SD card we can assure the compatibility of all analyser functions)	15	Pressure connection 1 (Differential Pressure)
7	Analyser feet	16	Pressure connection 2 (optional)
8	Fixing magnets	17	Pressure connection Draft
9	Handle strip		

NOTE

This note applies exclusively to optimal motor exhaust measurements.



If during zeroing T air (5) is disconnected, then value of T gas at the end of zeroing will be used. In this case, the measuring value will be displayed green coloured.

If T air (5) will be connected during the measurement, then true T air measurement will occur and the display color changes from green to black



ATTENTION

Gas outlet:

During measurement the gas outlet must not be covered

3.3. Condensate separator (water trap)

CAUTION



Condensate is acidic

The condensate from the container can be slight acidic and can cause chemical burn.

- ▶ Immediately clean with plenty of water once you have encountered acid

Condensate accumulating during the measurement is collected in the condensate separator.

Note that there are two variants of the condensate separator.

- Without water stop filter
- With water stop filter

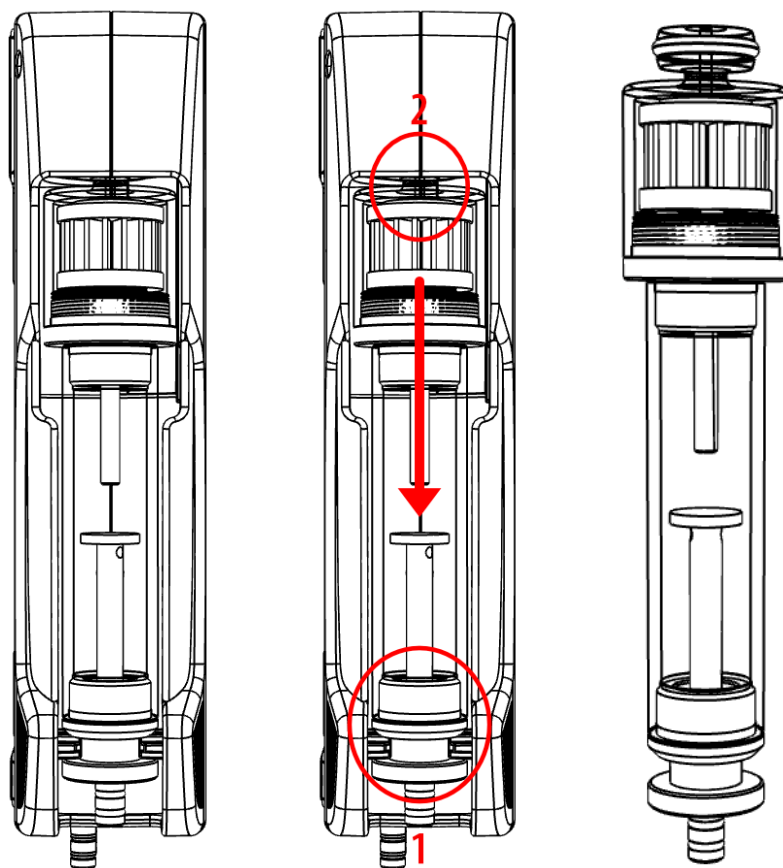
Condensate separator with-
out water stop filter

Remove the condensate separator by lifting it out from the groove (1) of the analyser. Then pull out the condensate separator downwards (2). Liquid discharged from the condensate separator may be slightly acidic. Condensate vessel and plug are screwed into each other. To change the pocket star filter and dry and clean the condensate separator, it can be easily disassembled and screwed back together.

After cleaning, a leak test must be performed.

☞ See also chapter 9.4 Performing leak test, Page 71.

An exhaust gas filter is installed in the condensate separator of the analyser. This filter out the first coarse dirt. This pocket star filter is washable and can be used approx. 4-5 times. Frequent measurement results in a high degree of contamination, which requires regular replacement of the pocket star filter.

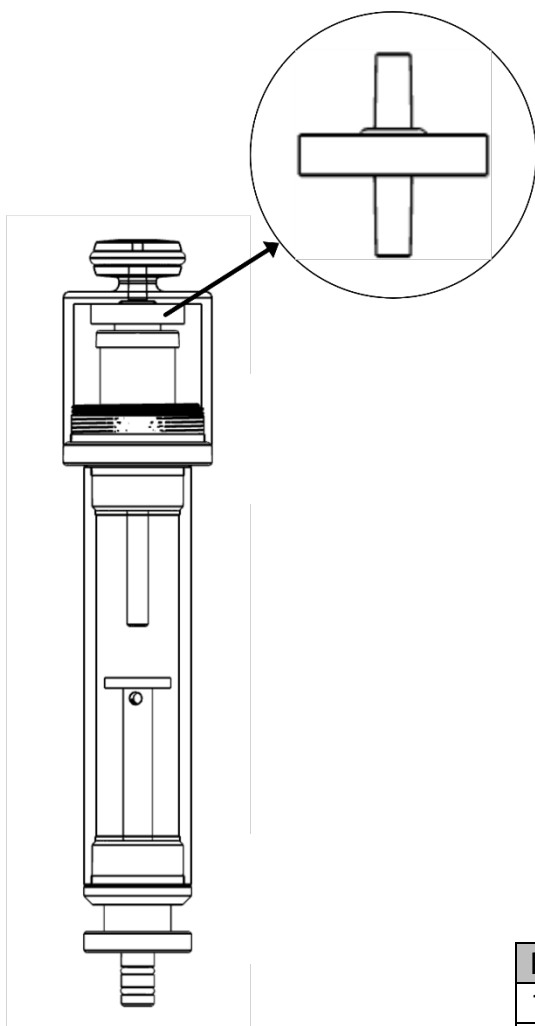

Condensate separator with-
out water stop filter



Position	Description
1	Waters top filter
2	Sealing ring

The water stop filter protects the analyser from moisture.
The water stop filter closes as soon as there is a risk that condensate is sucked into the analyser.
A closed water stop filter can be indicated, for example, by the fact that the flow rate is too low.

☞ See also chapter 12 Option: Monitoring flow rate, Page 81. If the flow monitoring option is installed in your analyser, the corresponding message could indicate a closed water stop filter.

- ▶ Check in the water stop filter
- ▶ Replace the water stop filter if necessary.
- ▶ Remove the condensate separator with water stop from the analyser as described above.
- ▶ Unscrew the condensate separator.
- ▶ Replace the water stop filter.

Observe the direction when installing the water stop filter

The side with the sealing ring must point upwards.

Due to the arrangement of the membrane in the filter, the water stop filter will quickly become defective if inserted in the wrong direction due to excessive pressure.

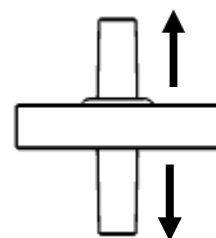

The water stop filter should be replaced annually.

3.4. Extraction probes

In combination with the analyser, gas sampling probes are offered in different versions with fixed probe tube or with exchangeable probe tube. For a complete overview of accessories, see the company's current price list.

Here two variants are shown as examples:

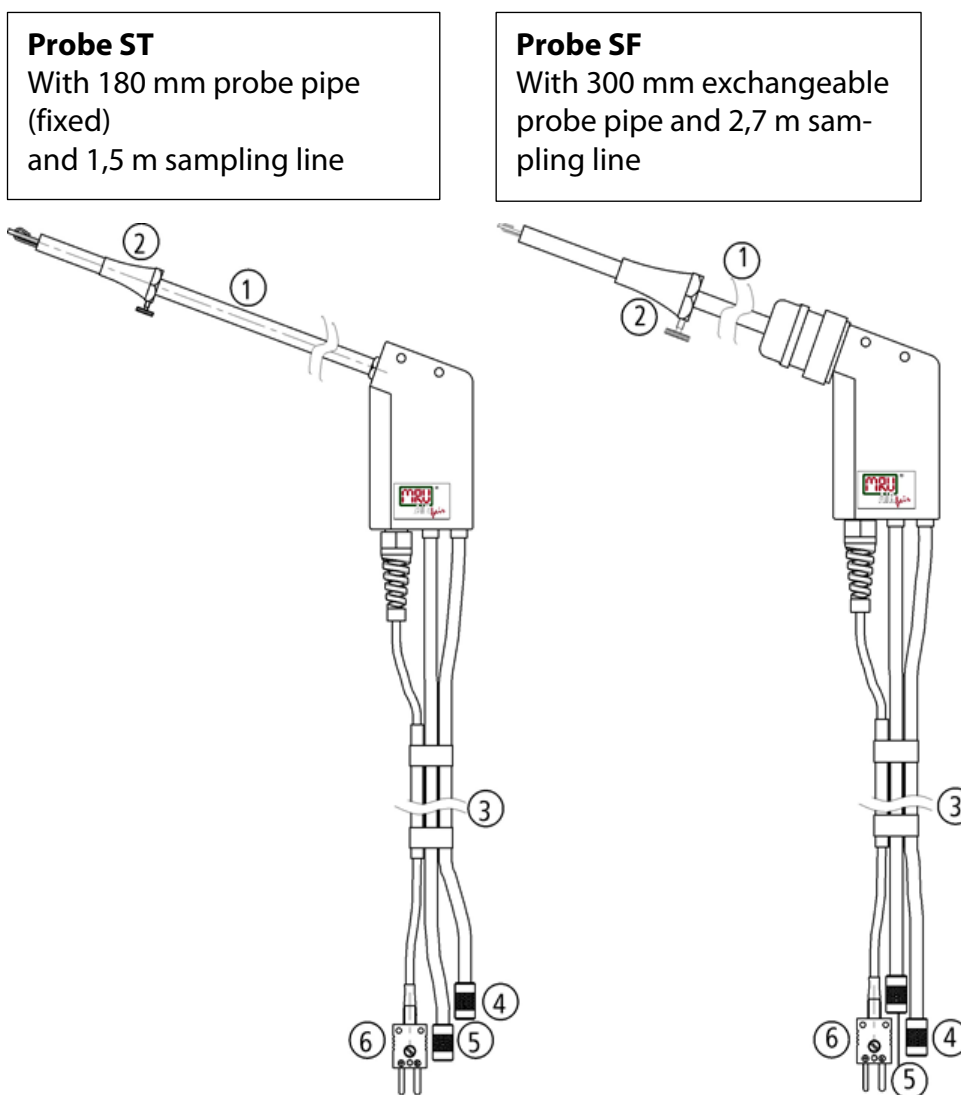

1	Probe tube	4	Connector for sample gas measurement
2	Probe cone (high grade steel)	5	Connector for draft measurement
3	Hose and cable routing	6	Connector for temperature measurement

4 Operating

4.1. Display



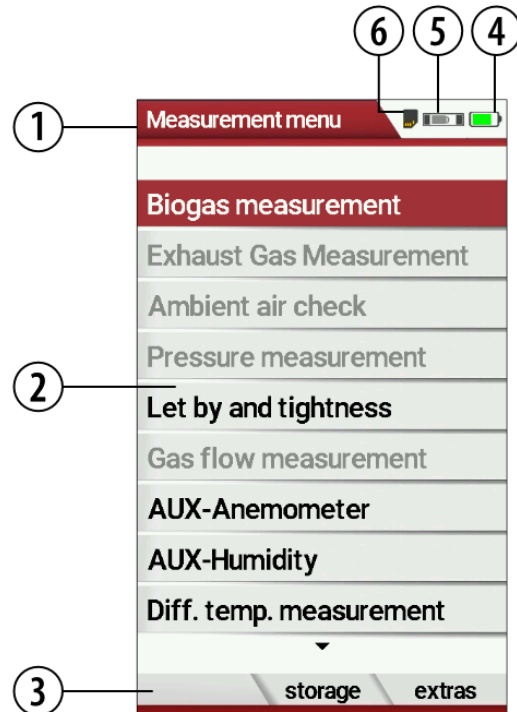



All the information needed for the operation of the analyser can be obtained from the analyser's display, which contains the following information.

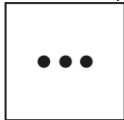

Position	Description
1	Menu bar
2	Display panel <ul style="list-style-type: none"> - Menu - Measurement values
3	Function key bar
4	Battery charge condition
5	SD-Card in the slot Display yellow → write-protected → read-only access
6	Zeroing active

4.2. Keypad

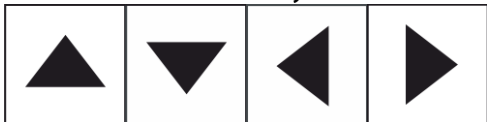
Description of the keys and their functions:

Key	Function
<p>ON/OFF</p> 	<p>A short press switches the analyser on without delay. Switching off the device is delayed protecting the sensor when no ambient air is present. Then purging is recommended before switching off.</p>
<p>Function keys</p> 	<p>Activates the function that is shown in the function key bar on the display.</p>
<p>Menu Key</p> 	<p>Will show all available functions in the window that is currently in use – also those which have an individual key on the keypad like the printer and the three function keys.</p>
<p>ESC</p> 	<p>Abort or return to the menu above</p>
<p>Arrow keys</p> 	<p>Move cursor, change values</p>
<p>OK</p> 	<p>Confirmation key, selection of the marked menu item</p>
<p>Printer</p> 	<p>Activates the printer function in the measurement and service window. .</p>

4.3. Menu structure

The analyser organizes all available actions into three main menus:

- Menu Measurement**
 Here you will find all actions for the measuring tasks of the analyser. All installed measuring tasks are listed here and can be selected.
- Menu Storage**
 All available storage options will be displayed and can be selected here.
- Menu Extra**
 All other actions are available here to manage and customize the analyser.

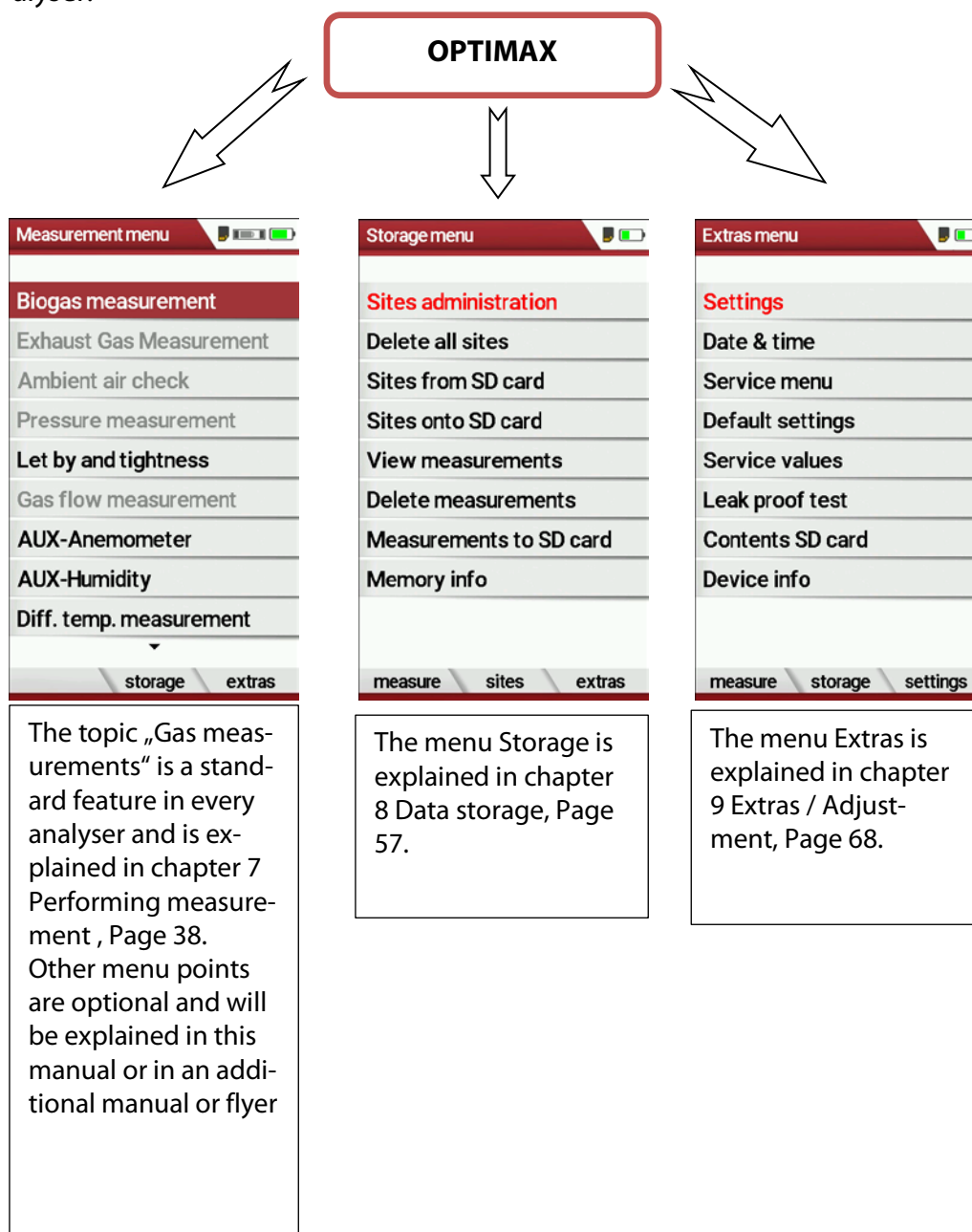

You can jump in between the 3 main menus with the 3 function keys (according to the displayed name on the screen).

5 First usage

After ensuring that the analyser is ready for operation, you can make some customer-specific adjustments during the initial startup. All settings can be changed at any time later.

5.1. Preparatory steps

- ▶ Unpack the analyser.
- ▶ Read the User Manual completely.
- ▶ The analyser leaves the factory assembled and ready for use. Nevertheless, check the device for completeness and integrity.
- ▶ Charge the battery of the analyser for about 8 hours.
- ▶ Check date and time. Modify if needed.

5.2. Customize settings

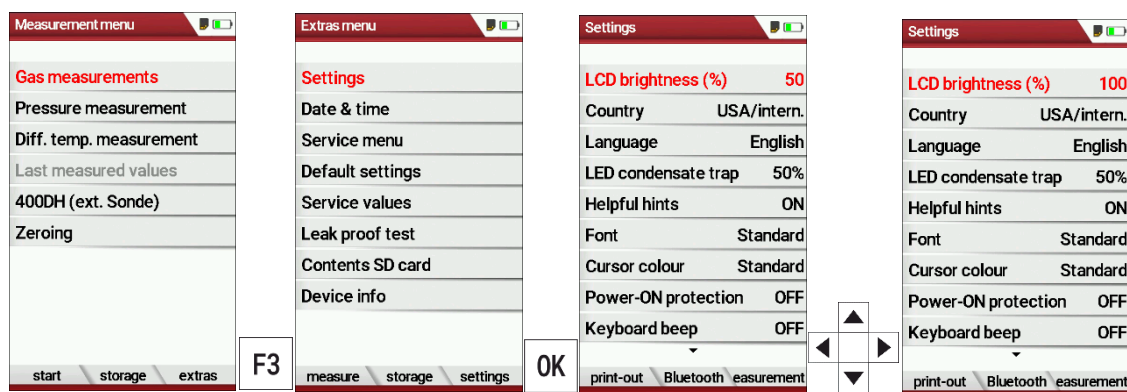

Press F3.

- ⇒ The Extras menu appears.
- ▶ Select Settings.
- ▶ Press OK.
 - ⇒ The menu Settings appears.
- ▶ Select the desired setting.
- ▶ Change the desired setting.
- ▶ Press ESC.
 - ⇒ The change is saved.
 - ⇒ The Extras menu appears.

5.3. Export and import settings

You have the possibility to export saved settings to an SD card and import these settings to another analyser.

Export user settings

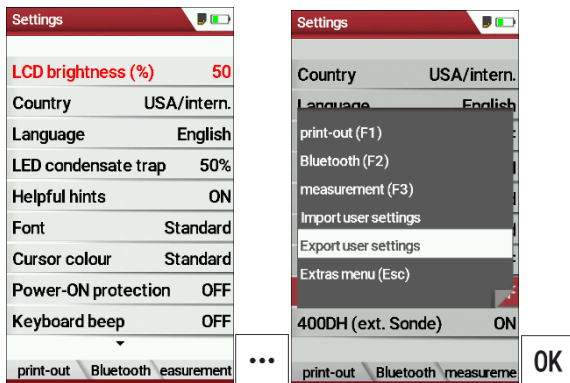

- ▶ Make sure that there is an SD card in the analyser.
- ▶ Go to the menu Settings.
 - ☞ See also chapter 5.2 Customize settings, Page 24.
- ▶ Press the menu key.
 - ⇒ A selection list appears.
- ▶ Select Export user settings.
- ▶ Press OK.
 - ⇒ The settings are exported to the SD card.
 - ⇒ The settings are saved on the SD card as SETTINGS.USR

Import user settings

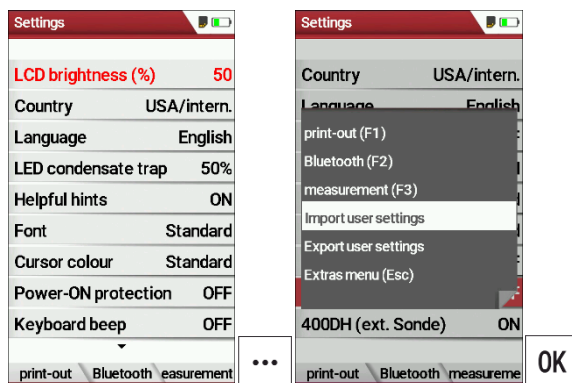

- ▶ Insert the SD card with the exported settings into the desired analyser.
- ▶ Go to the menu Settings.
 - ☞ See also chapter 5.2 Customize settings, Page 24.
- ▶ Press the menu key.
 - ⇒ A selection list appears.
- ▶ Select Import user settings.
- ▶ Press OK.
 - ⇒ The settings are imported.

5.4. Set measurement

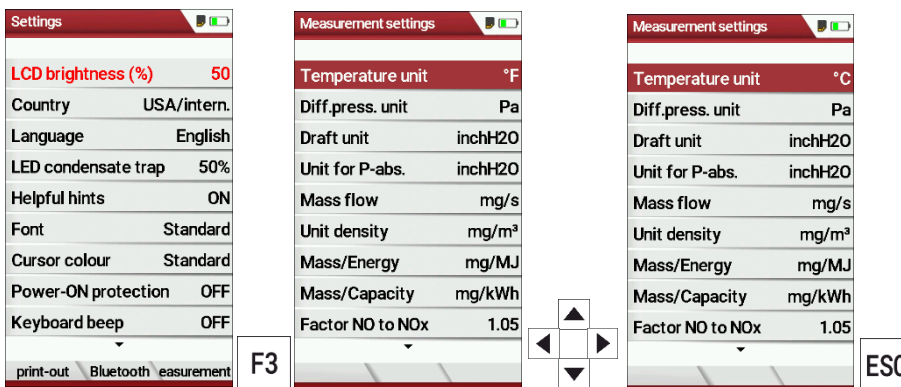

- ▶ Go to the menu Settings.
 - ☞ See also chapter 5.2 Customize settings, Page 24.
- ▶ Press F3.
 - ⇒ The menu Measurement settings appears.
- ▶ Select the desired setting.
- ▶ Change the desired setting.
- ▶ Press ESC.
 - ⇒ The change is saved.
 - ⇒ The menu Settings appears.

5.5. Set Bluetooth parameters

Depending on the features, the analyser can be used to exchange measurement data wirelessly with external devices:

- With MRU4U (App for Android and iOS Smartphones)
- With MRU4Win
- With MRU Bluetooth-Printer

Depending on the software version of the analyser and the technical realization of the Bluetooth interface, settings for data transfer may be required.

► Please check in the following menu:

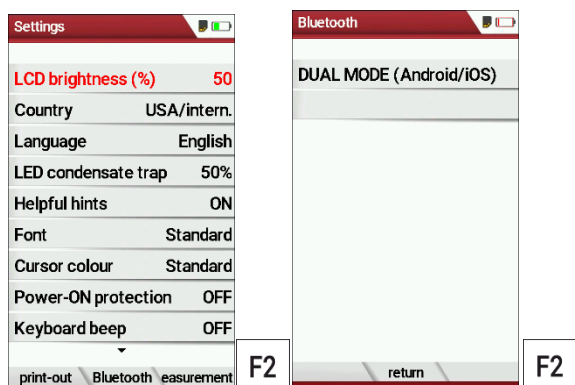

► Go to the menu Settings.

☞ See also chapter 5.2 Customize settings, Page 24.

► Press F2.

⇒ The menu Bluetooth appears.

If "DUAL MODE (ANDROID/IOS)" appears in the settings window, the Bluetooth module supports all applications without any further settings.

If "DUAL MODE (ANDROID/IOS)" appears in the settings window instead of "ANDROID/IOS", a settings window appears in which you can select between the ANDROID/IOS modes, select whether you want to connect the analyser to an Android or iOS smartphone.

A connection to the Bluetooth printer or to MRU4Win is realized with the "ANDROID" setting.

5.6. Setting date and time

If the built-in rechargeable battery is completely discharged, a new setting of these values is required

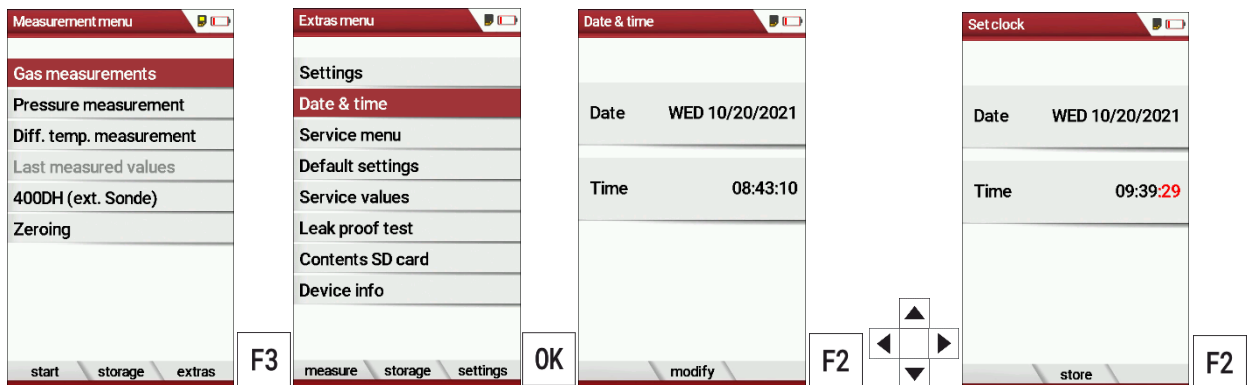

- ▶ Press F3.
 - ⇒ The Extra menu appears.
- ▶ Select Date / Time.
- ▶ Press OK.
 - ⇒ The menu Date/Time appears.
- ▶ Press F2.
 - ⇒ The menu Set clock appears.
- ▶ Set the desired Date
- ▶ Set the desired Time.
- ▶ Press F2.
 - ⇒ The change is saved.

5.7. Configure measurement program

For each of the programs the following parameters can be configured:

1. CO ppm limit: adjustable value for the CO sensor protection. If the CO value in the flue gas is higher than the adjusted value in the analyser, the purge pump will be activated, and the sensor will be protected against high CO concentrations. (Optional)
2. Selectable fuel types: choose and select from the available fuel type list
3. Measurement windows: configuration of what and where will be displayed in the 3 measurement value windows.
4. Zoom – window: select what will be displayed in the zoom - window
5. Program name

The following program is pre-configured:

“Test Program” indented for use at instrument maintenance and calibration.

5.8. Set CO-Limit

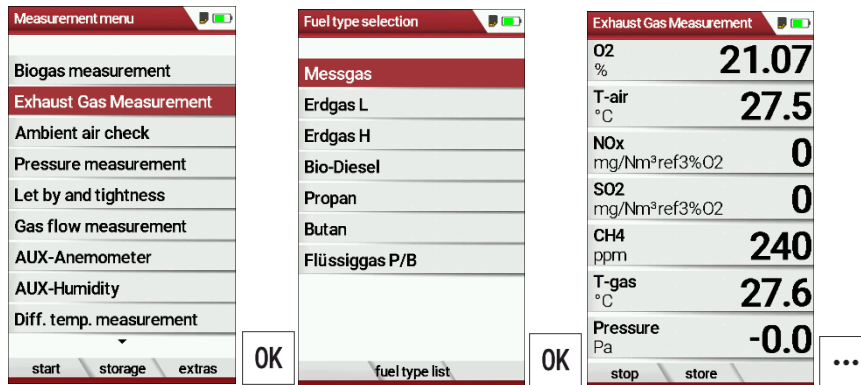

- ▶ Select Exhaust Gas measurements.
- ▶ Press OK.
 - ⇒ The menu Fuel type selection appears.
- ▶ Select the desired fuel.
- ▶ Press OK.
 - ⇒ The menu Exhaust Gas Measurement appears.
- ▶ Press the menu key
 - ⇒ A selection list appears.
- ▶ Select CO-Limit.
 - ⇒ The menu CO-Limit appears.
- ▶ Enter the desired CO-Limit.

5.9. Change measurement program name

You have the possibility to change the name of the measurement program.



- ▶ Select Gas measurements
- ▶ Press OK.
 - ⇒ The menu Selection meas. program appears.
- ▶ Press F3.
- ▶ Change the name of the measurement program to your needs.
- ▶ Press OK.
 - ⇒ The changed name is displayed in the menu Selection meas. program.

5.10. Select fuel types and O₂ reference

NOTE



Note that you can only select the Fuel type selection if the combustion calculation has been switched on.

☞ See also chapter 5.4 Set measurement, Page 26

Each time a measuring program for flue gas measurement is called up, a fuel can be selected from a list. Which fuel is available for selection can be selected from a fuel type list.

Add fuels to fuel type selection

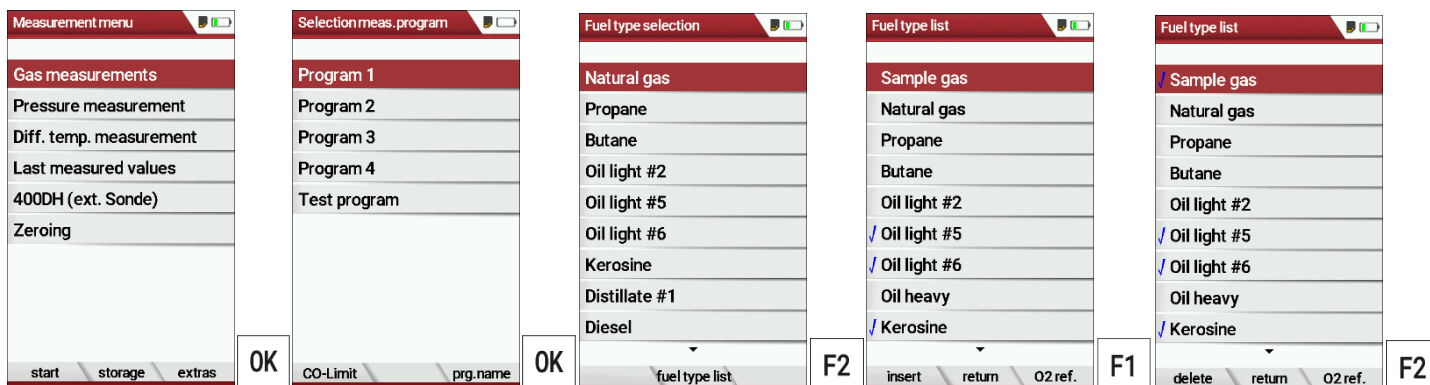

- ▶ Select Gas measurements.
- ▶ Press OK.
 - ⇒ The menu Selection meas. Program appears.
- ▶ Select the desired measurement program.
- ▶ Press OK.
 - ⇒ The menu fuel type selection appears.
- ▶ Press F2.
 - ⇒ The menu Fuel type list appears.
- ▶ Wählen Sie den Brennstoff aus, der dem Menü Brennstoffauswahl hinzugefügt werden soll.
- ▶ Select the fuel which should be added to the menu Fuel type selection.
- ▶ Press F1.
 - ⇒ The selected fuel is marked with a check mark.
- ▶ Select other fuels if necessary.
- ▶ Press OK.
 - ⇒ The selected fuels are displayed in the menu Fuel type selection.

Set O2-reference

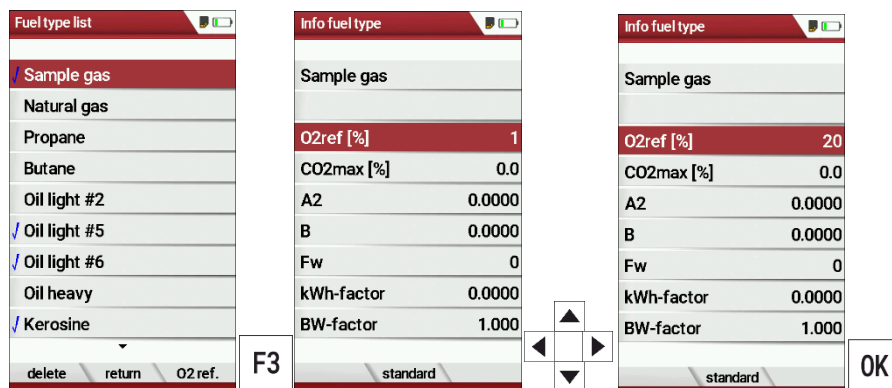

- ▶ Go to the menu Fuel type list.
 - ☞ See also chapter Add fuels to fuel type selection, Page 30.
- ▶ Select the desired fuel.
- ▶ Press F3.
 - ⇒ The menu Info fuel type appears.
- ▶ Set the desired O2-reference
- ▶ Press OK.
 - ⇒ The set O2 reference is saved.

5.11. Define user fuel type



NOTE

Note that you can only select the Fuel type selection if the combustion calculation has been switched on.

☞ See also chapter 5.4 Set measurement, Page 26

You can define four fuels to your individual needs.
 You can define the name and the fuel parameters.
 Like the other fuels, you can add user fuels to the menu Fuel type selection.

NOTE



The last 4 fuels in the menu Fuel type list are the user fuels. The user fuels are indicated in the menu Fuel Type list in green colour.

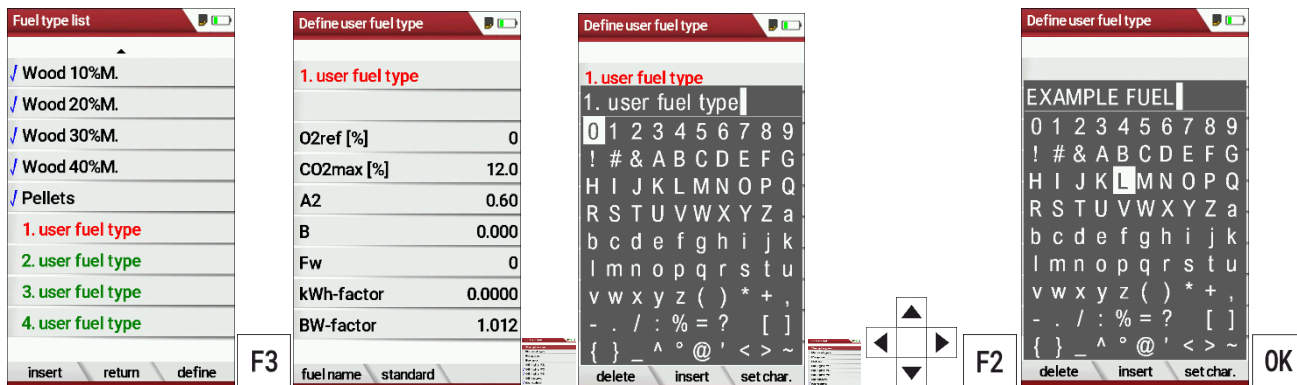

- ▶ Go the menu Fuel type list.
 - ☞ See also chapter Add fuels to fuel type selection, Page 30.
- ▶ Select the user fuel type you want to define.
- ▶ Press F3.
 - ⇒ The menu Define user fuel type appears.
- ▶ Press F1.
 - ⇒ A window appears.
- ▶ Change the name of the user fuel type to your needs.
- ▶ Press OK.
 - ⇒ The changed name is displayed in the menu Define user fuel type.
 - ⇒ After you have changed the name of the user fuel, you can define the fuel parameters.

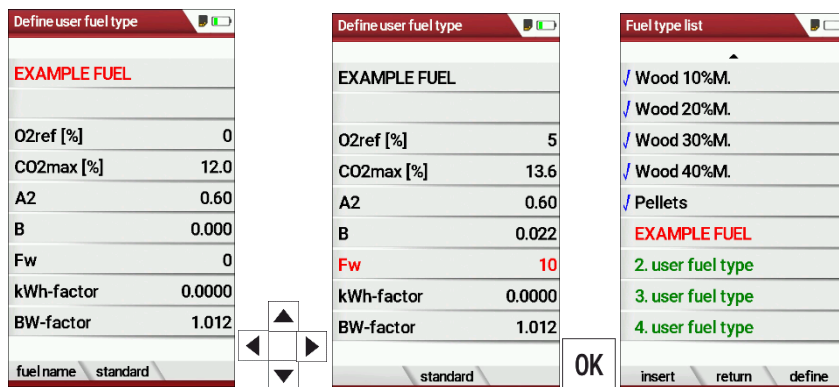

- ▶ Select the desired fuel parameter.
- ▶ Change the desired fuel parameter.
- ▶ Press OK.
 - ⇒ The defined user fuel appears in the menu Fuel type list.
 - ⇒ You can add the defined user fuel to the menu Fuel type selection.
 - ☞ See also chapter Add fuels to fuel type selection, Page 30.

5.12. Define measurement window.

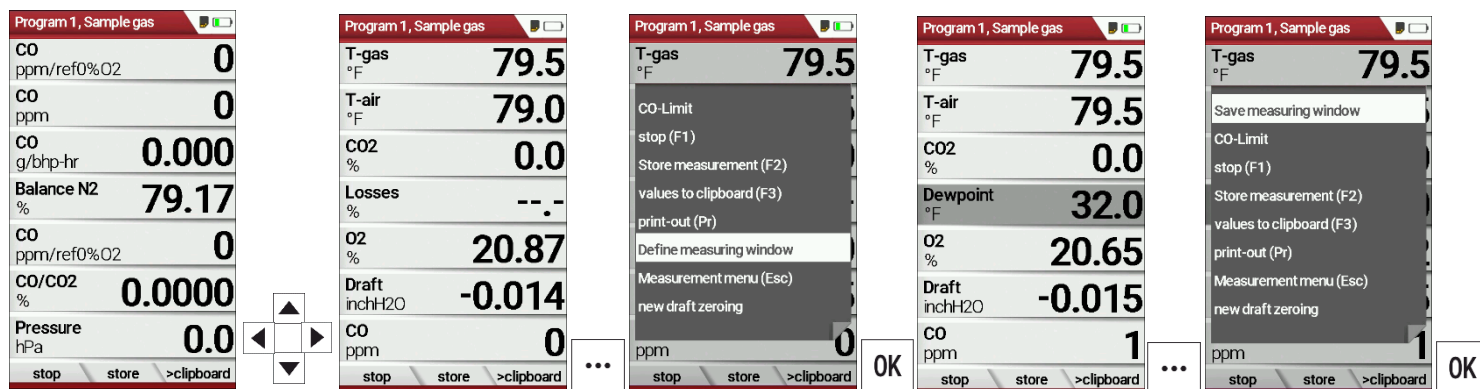

- ▶ Start a measuring program.
In this example Program 1, Sample gas.
- ▶ Select one of three measurement windows.
- ▶ Press the menu key
 - ⇒ A selection list appears.
- ▶ Select Define measuring window.
- ▶ Press OK.
 - ⇒ The measurement window appears
- ▶ Select the desired measured value that you want to change.
- ▶ Press the menu key.
 - ⇒ A selection list appears.
- ▶ Select Save measuring window.
- ▶ Press OK.
 - ⇒ The change is saved.

5.13. Configure zoom window

In each measuring program, a zoom window is available for the enlarged display of measured values.

You can choose between two zoom views.

- ▶ Press the arrow key at the top to display four measured values with the respective curve. The scaling is automatic. The x-axis firmly shows the last 150 seconds.
- ▶ Press the down arrow key to display two measured values without a curve.

The following example shows the configuration of the zoom window with four measured values. The configuration of the zoom window with two measured values is done in the same way.

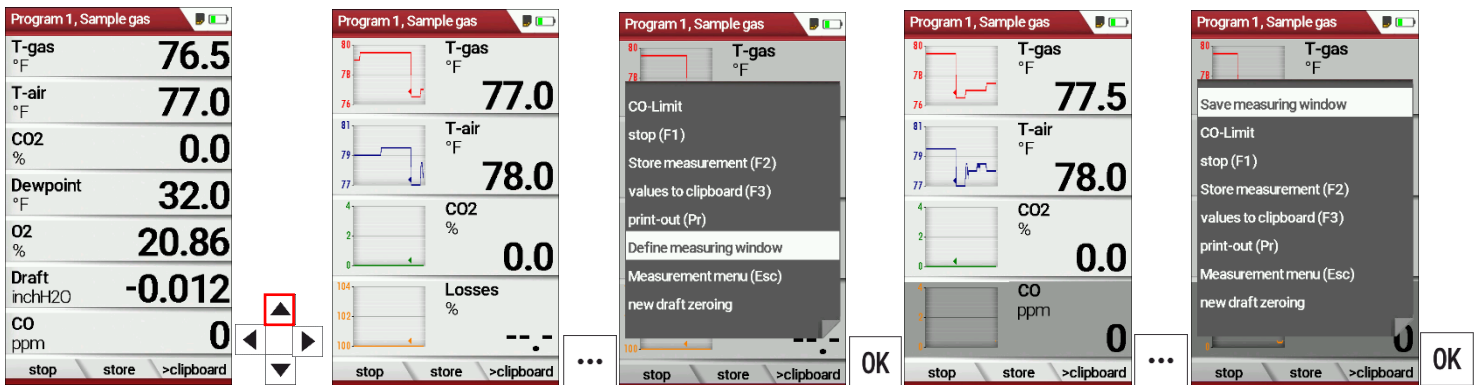

- ▶ Start a measuring program.
In this example Program 1, Sample gas.
- ▶ Press the arrow key up.
 - ⇒ The zoom window appears.
- ▶ Press the menu key.
 - ⇒ A selection list appears.
- ▶ Select define measuring window.
- ▶ Press OK.
- ▶ Select the desired measured value that you want to change.
- ▶ Press the menu key.
 - ⇒ A selection list appears.
- ▶ Select Save measuring window.
- ▶ Press OK.
 - ⇒ The change is saved.

6 Prepare measurement

6.1. Perform overall visual inspection

Before using the analyser, perform an overall visual inspection to ensure that the analyser is operating correctly.

6.2. Ensure power supply

The analyser can be used with:

- with the internal MRU battery (provided)
- with the MRU battery charger (provided)

External equipment may only be connected while the analyser is switched off!

6.3. Automatic Auto-off function

The auto-off function switches the analyser off after 60 minutes without any key operation.

The auto-off function is deactivated during a measurement or the charger/USB connection, the auto-off function is deactivated.

6.4. Measuring with grid power supply / Battery charging

Whenever you connect the analyser with external battery charger (90...260 V / 50/ 60Hz) the battery will be charged

Once the battery is fully charged the analyser will switch to trickle charge mode.

At the moment, if the battery is fully charged and the trickle charge mode begins, acoustic feedback will be played.

6.5. Measurements in battery mode (battery monitoring)

The battery symbol in the top right corner displays the current battery charge condition.

Approximately 15 minutes (depending on the analyser configuration) before the battery is drained, the battery symbol will start to blink red (about once per second).

When the battery is almost drained and the analyser is not connected to the battery charger within one minute, then the analyser will switch off automatically to prevent deep discharge of the battery.

6.6. Operating temperature

If the analyser has been stored at low temperatures, it will require some time to equilibrate to the ambient temperature before being switched on. If it does not equilibrate, condensation will occur inside the analyser!

If the temperature is out of its operation range you will see messages on the display:



ATTENTION

Once one of these messages appears you will not be able to use the analyser, it will give an acoustic signal until it has reached the specified operation temperature between +5°C and +45°C

6.7. Control Condensate separator



CAUTION

Acid from the condensate

Acid burns may result from weakly acidic liquids from the condensate.

- ▶ If you come into contact with acid, wash the area immediately using a lot of water.

- ▶ Control the condensate separator before and after each measurement
- ▶ Check that the condensate separator is empty.
- ▶ Check the star filter.
 - ⇒ Star filter white = ready for use
 - ⇒ Star filter dark = renew

When switching off, a warning message is displayed:

6.8. Connections and tightness

Check all plug connections for correct fitting.

Check all hoses, hose connections, condensate containers (from the probe tip to the gas connection on the analyser) for tightness.

The analyser has a built-in automatic test to check the tightness of the gas paths.

☞ See also chapter 9.4 Performing leak test, Page 71

6.9. Automatic zero point

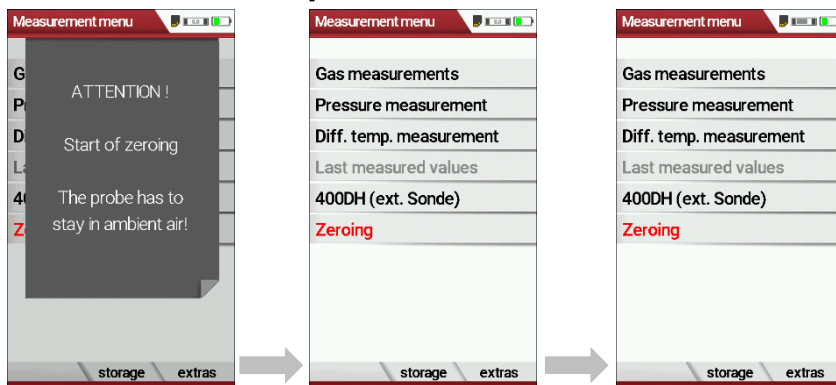

NOTE

The probe must not be in the exhaust gas during the zeroing.

- ▶ Switch on the analyser.
 - ⇒ The analyser autonomously carries out a zero-point measurement.
 - ⇒ During zeroing, the $\rightarrow 0.0 \leftarrow$ symbol flashes in the upper right corner of the display.
 - ⇒ After zeroing is complete, the analyser is ready for measurement.
 - ⇒ If sensors are faulty, the error is identified during zeroing and an error message is displayed.

Repeat zeroing

The zeroing can be repeated at any time as long as the probe is not inside the stack

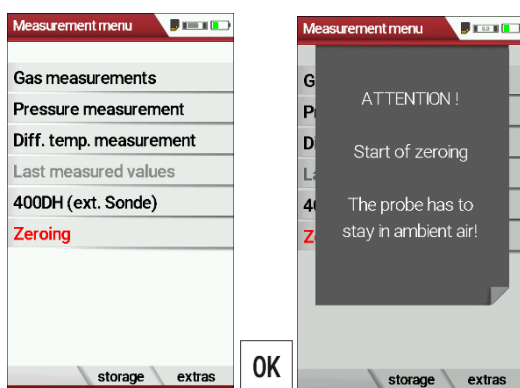

- ▶ Go to the Measurement menu
- ▶ Select Zeroing
- ▶ Press OK.
 - ⇒ Zeroing is started.

7 Performing measurement

In the basic configuration, each analyser has the complete functionality you need for gas measurement.

The process of gas measurement is described below.

The description of other optionally available measuring programs can be found in the appendix or on separate supplementary sheets.

7.1. Select measurement menu

⚠ DANGER



Rick due to toxic gases

There is a risk of poisoning.

Noxious gases are sucked in by the measuring device and released into the ambient air.

- ▶ Only use the measuring device in well ventilated spaces.

NOTE



Wrong measuring results

The extracted flue gas must be able to evacuate the analyser without obstruction.

- ▶ The exhaust outlet at the rear of the analyser may never be covered during a measurement, never operate the analyser in a transport case.

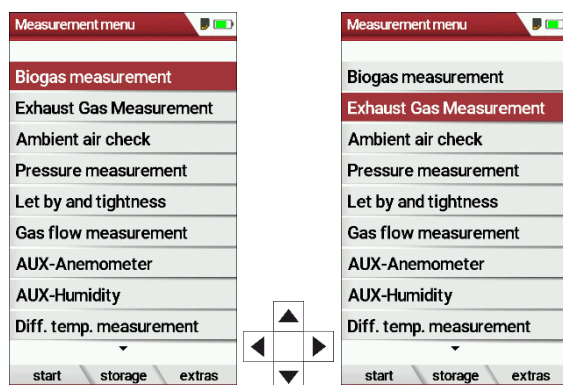

- ▶ Go to the measurement menu.
- ▶ Select the desired measurement program.
- ▶ Press OK.

7.2. Perform Biogas measurement

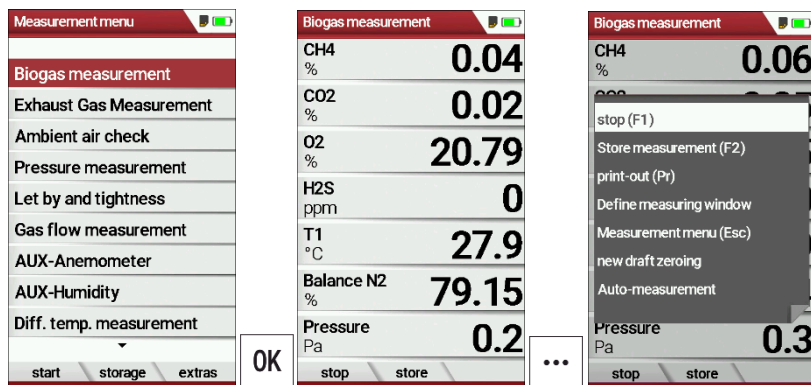

- ▶ Select Biogas measurement.
- ▶ Press OK.
 - ⇒ The menu Biogas measurement appears.

NOTE

If necessary, a message appears that a new zero point must be taken.

- ▶ Confirm the message with OK.
 - ⇒ The menu Biogas measurement appears.
 - ⇒ The icon for zeroing appears in yellow/red.
- ▶ Exit the menu Biogas measurement.
- ▶ Perform a zeroing.
 - ☞ See also chapter Repeat zeroing, Page 37.
- ⇒ After zeroing, you can open the Biogas measurement menu and perform the biogas measurement.



7.3. Perform Exhaust Gas measurement

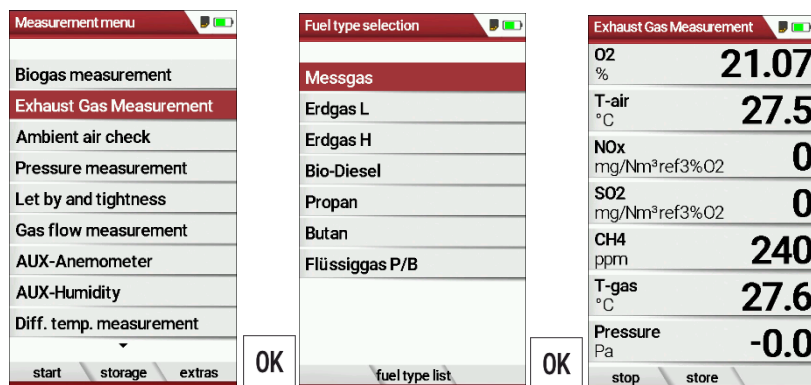

- ▶ Select Exhaust Gas Measurement.
- ▶ Press OK.
 - ⇒ The menu Fuel type selection appears.
- ▶ Select the desired fuel type.

NOTE



Note that the menu Fuel type selection differs depending on whether the combustion calculation is activated or deactivated in the menu Measurement settings.

☞ See also chapter 5.4 Set measurement, Page 26.

- ▶ Add fuels to the menu Fuel type selection from the fuel type list if necessary.
 - ☞ See also chapter Add fuels to fuel type selection, Page 30.
- ▶ Press OK.
 - ⇒ The measuring window appears.
 - ⇒ The measurement is started.
- ▶ If necessary, set the desired CO limit.
 - ☞ See also chapter 5.8 Set CO-Limit, Page 29

NOTE

You can start a measurement with the previously set measurement parameters directly from the Measurement menu.

► Press F1.

⇒ The measurement is started.

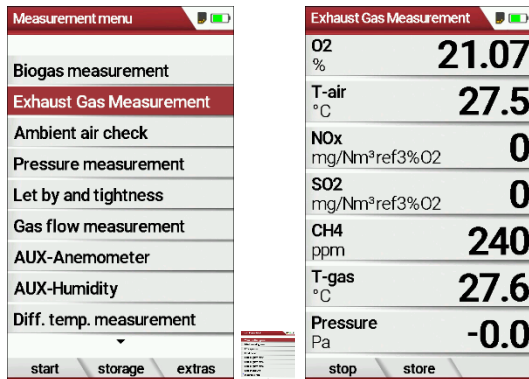

Measurement window

The measured values are organised in three windows of 7 measured values each.

Which measured value is displayed at which position in the window is configurable.

☞ See also Chapter 5.12, Page 33 and chapter 5.13 Configure zoom window, Page 34.

Direct measured variables such as oxygen content or temperature are available as measured values, as are calculated values such as dew point, CO2 content, etc. The same measured value is also available in different conversions, such as CO as ppm or mg/kWh.

Measured values that are not available are shown as dashes. Reasons for unavailability can be:

- Electrochemical sensor was detected as faulty during zeroing.
- External temperature sensors are not plugged in.

The measured value T-gas is primarily derived from the connection "T-gas / AUX" (depending on the equipment) or, if not available, from the connection "T1".

CO purging

If the configured CO threshold is exceeded during the gas measurement, the analyser activates the purge function. This protects the CO sensor from excessive CO values without falsifying other measured values.

During the purging, the CO measured value has no meaning and is therefore replaced by dashes. These are red as long as the CO measured value is still above the set CO threshold and then turn black when purging is successful.

Purging does not end automatically, but must be switched off by the user.

To do this, select the menu key and the subitem "purge pump OFF"

7.4. Perform Ambient air check



NOTE

Please note that the Ambient air check depends on the country selected. If the Ambient air check is not displayed, the ambient air check is not available in your country.



NOTE

Analysers are not personal protective equipment and the measurement of ambient air quality is indicative only. For enclosed spaces or hazardous areas, persons must be equipped with a certified safety detector.

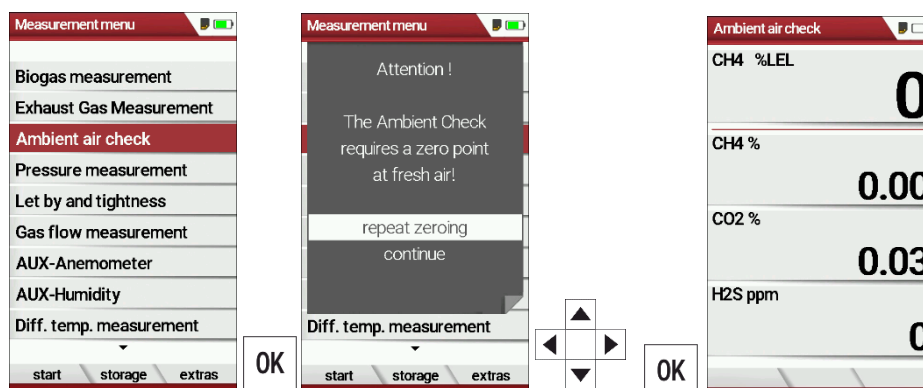

- ▶ Go to the Measurement menu.
- ▶ Select Ambient air check.
 - ⇒ A message appears that the Ambient air check requires a zero point.



NOTE

- ▶ Perform zeroing in fresh air.
- ▶ Do not take the zero point in the area to be measured.

7.5. Temporary buffer

The analyser offers you the possibility to store all momentary measured values in a temporary buffer while the measurement is running and to continue the measurement.

- ▶ Later on, the values can be brought back from the temporary buffer to the measuring window in order to print them out or / and to save them.

Store values into temporary buffer

During a running measurement you can store the current values in the temporary memory.

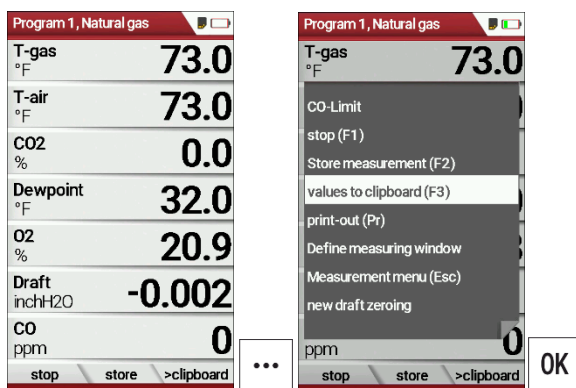

- ▶ Start a Measurement.
- ▶ Press the menu key.
 - ⇒ A selection list appears.
- ▶ Select values to clipboard.
 - ⇒ The measured values are stored in the temporary buffer.

When the measurement is stopped, you can compare the currently displayed measured values with the measured values in the temporary buffer.

Program 1, Natural gas	
T-gas °F	72.5
T-air °F	73.0
CO2 %	0.0
Dewpoint °F	32.0
O2 %	20.9
Draft inchH2O	0.000
CO ppm	1
start / store / v./clipboard	

F3

Program 1, Natural gas	
T-gas °F	72.5
T-air °F	73.0
CO2 %	0.1
Dewpoint °F	32.0
O2 %	20.9
Draft inchH2O	0.020
CO ppm	1
start / store / v./clipboard	

- ▶ Stop the Measurement.
 - ⇒ The measuring window is greyed out.
- ▶ Press F3.
 - ⇒ The measured values stored in the temporary memory are displayed.

If you have stopped a measurement without first storing the measured values in the temporary buffer, you can store the measured values directly in the temporary buffer from the function key bar.

Program 1, Natural gas	
T-gas °F	73.0
T-air °F	73.5
CO2 %	0.1
Dewpoint °F	32.0
O2 %	20.8
Draft inchH2O	-0.001
CO ppm	1
start / store / >clipboard	

F3

Program 1, Natural gas	
T-gas °F	73.0
T-air °F	73.5
CO2 %	0.1
Dewpoint °F	32.0
O2 %	20.8
Draft inchH2O	-0.001
CO ppm	1
start / store / v./clipboard	

- ▶ Stop the measurement.
 - ⇒ The measuring window is greyed out.
- ▶ Press F3.
 - ⇒ The measured values are stored in the temporary buffer.

Overwrite measured values in temporary buffer

You can overwrite the measured values stored in the temporary buffer with the currently displayed measured values

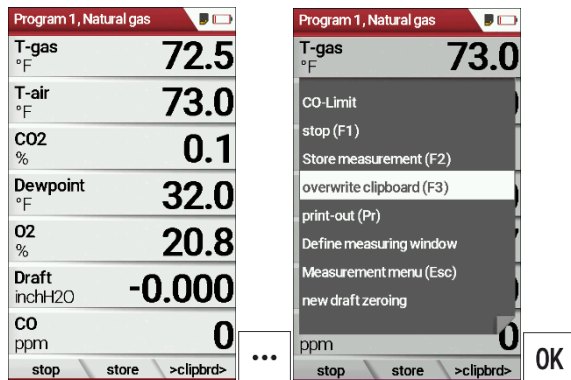

- ▶ Press the menu key.
 - ⇒ A selection list appears.
- ▶ Select overwrite clipboard.
- ▶ Press OK.
 - ⇒ The temporary buffer is overwritten.
- ▶ You can overwrite the temporary buffer with current measured values at any time.

If necessary, you can process the currently displayed measured values further, e.g., print or store them

- ☞ See also chapter 7.12 Store measurement values, Page 50 and 7.13 Print measurement values, Page 52.

7.6. Perform Annular-gap test

The annular gap test checks whether the exhaust system is tight by measuring the O₂ value of the combustion air.

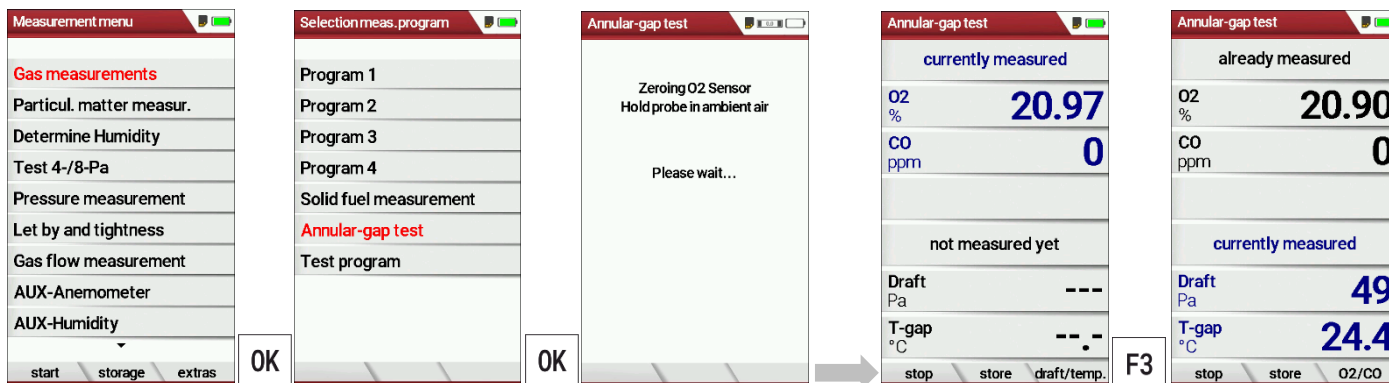

- ▶ Select Gas measurements.
- ▶ Press OK.
 - ⇒ The menu Selection meas. Program appears.
- ▶ Select Annular-gap test.
- ▶ Press OK.
 - ⇒ If necessary, an automatic zero-point measurement is performed.
 - ⇒ The menu Annular-gap test appears.
- ▶ Press F3.
 - ⇒ The currently measured values for Draft and T-gap are displayed.

The MRU annular gap multi-hole probe No. 56352 is suitable for annular gap measurement. The silicone hose is attached to the condensate separator of the analyser.

Optionally, the annular gap multi-hole probe can be attached to the measuring probe of the analyser with the probe coupling MRU No. 11652.

7.7. Perform Test program

The test program is used by test facilities to check the analyser by means of test gas in the measuring program.

No calculations are performed during the test program.

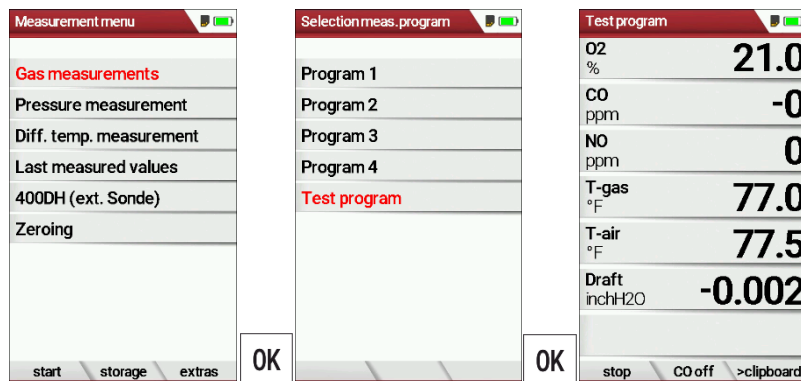

- ▶ Select Gas Measurements.
- ▶ Press OK.
 - ⇒ The menu Selection meas. program appears.
- ▶ Select Test program.
- ▶ Press OK.
 - ⇒ The Test program is started.

7.8. CO/H2 and CO high (optional)

If that exceeds CO the CO threshold, then to CO high, the measured value is red indicated - also the calculated values - is switched.

The CO value exceeds 10.000 ppm to % is in such a way switched (example 1.00%).

If the CO value sinks below the CO threshold, then the red CO value becomes again black

Starting from this moment the purge pump can be switched off over the menu key again.

7.9. Non-continuous draft measurement

The analyser provides for a non-continuous draft measurement. The draft measurement is disabled when a maximum time after zeroing has elapsed or a significant change in temperature has been detected by the instrument. The maximum time is configured to 10 minutes.

If the draft measurement is disabled it is displayed with "--.-". The draft measurement can be enabled again by zeroing the draft: F3 key "zero draft".

To indicate that the draft measurement is not continuously available it is displayed in colour red.

The user can freeze the draft data by means of the F3 key "hold draft". The frozen data is displayed in green.

The unfreeze the measurement one has to exit the menu and enter again All other measurements are processed continuously independent of the draft measurement status.

7.10. Perform pressure measurement

Pressure (4 values) is measured and saved to the selected measurement name. The actual measured value is displayed in the middle of the display. The 4 measurement names can be changed as desired.

The hose on the draft + connector must be connected for draft measurements.

The second hose on the Delta P- connector must be connected for differential measurement.

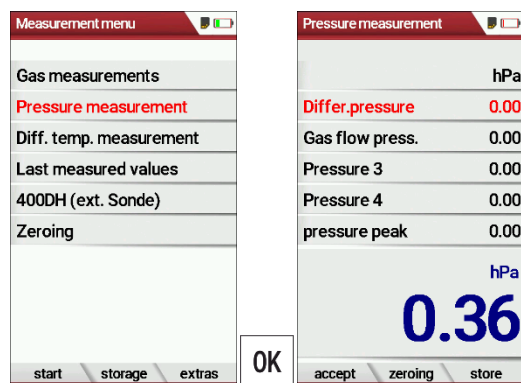

- ▶ Go to the measurement menu.
- ▶ Select Pressure measurement.
- ▶ Press OK.

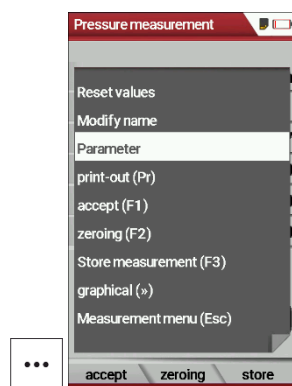

- ▶ Press the menu key.
 - ⇒ A selection list appears.
- ▶ Select the desired item from the selection list.
 - For example, select the Parameter to set the unit as well as the damping (T90/s).

7.11. Perform Differential temperature measurement

In the differential temperature measurement menu two temperatures can be measured simultaneously by using the T1 and T2 connectors. Both measured temperatures and the difference between the temperatures will be displayed.

- ▶ Plug a temperature sensor into the T1 connection.
- ▶ Plug a temperature sensor into the T2 connection.

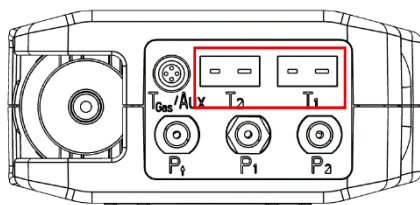

NOTE



The accuracy of the difference temperature measurement is guaranteed only on use of the MRU temperature sensors.

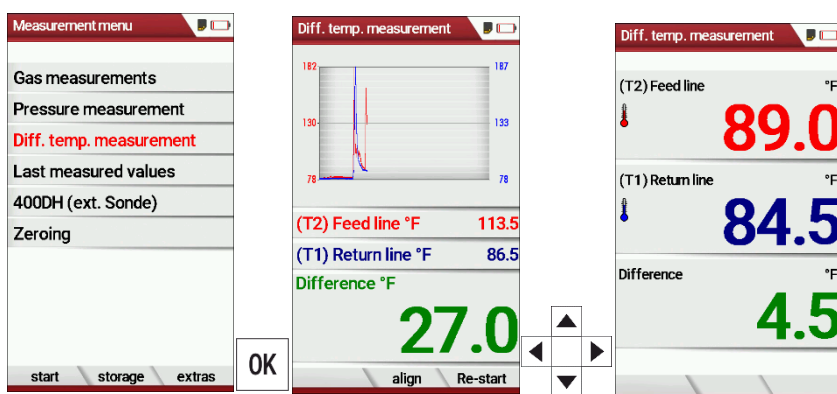

- ▶ Go to the Measurement menu.
- ▶ Select Diff. Temp. measurement.
- ▶ Press OK.
 - ⇒ The menu Diff. temp. measurement appears.
 - ⇒ The temperatures T1, T2 and the difference appears.
- ▶ Press the menu key.
 - ⇒ A selection list appears.
- ▶ Select the desired item from the selection list.
 - For example, select the print-out (Pr) item to print the measurement.

7.12. Store measurement values

If "store" is displayed in the function key bar, you can save measurement results to the data memory using the related function key F2 or F3. The function of the data storage is displayed in chapter 8 Data storage, Page 57.

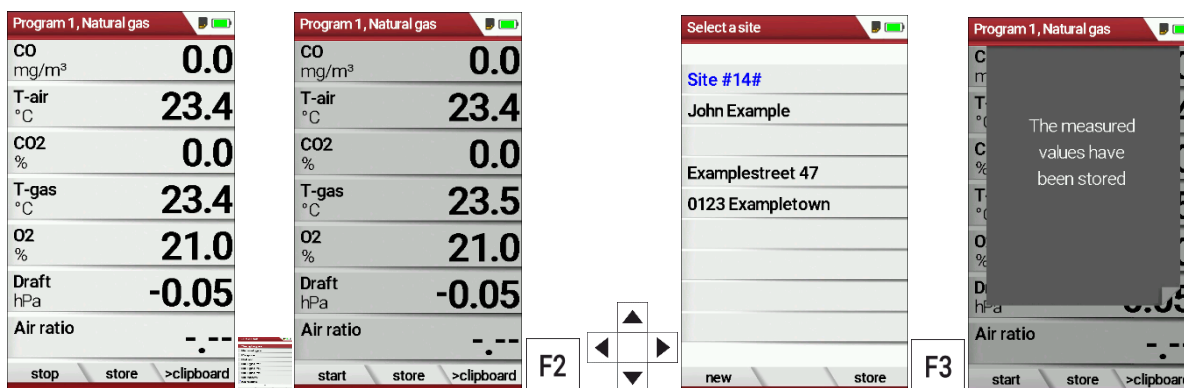

- ▶ Press F1.
 - ⇒ The measurement is stopped.
 - ⇒ The measurement window is greyed out.
- ▶ Press F2.
 - ⇒ The menu Select a site appears.
- ▶ Select the desired site.
- ▶ If necessary, press F1 to select a new site.
 - ☞ See also chapter Create new site, Page 58.
- ▶ Press F3.
 - ⇒ The measured values have been stored.
 - ☞ See also chapter View measurements, Page 65.

Enter T-boiler, Soot and Derivative

The analyser does not have a soot measurement.

- ▶ However, you can enter determined soot data to save or print them together with the measurement data.

NOTE

Before you can enter the soot data, you have to activate the setting "Add soot & T-boiler" in the menu Measurement settings.



☞ See also chapter 5.4 Set measurement, Page 26.

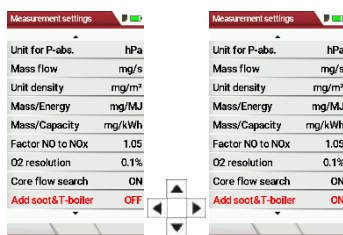

- ▶ After a successful measurement, you can enter the externally determined measured values.

NOTE



The input of soot numbers and derivative is only possible for fuel oil / diesel.

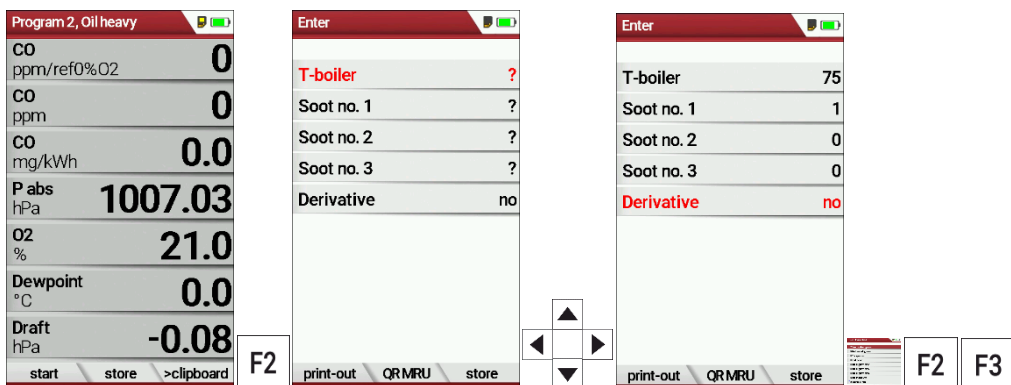

- ▶ Press F2.
 - ⇒ The menu Enter appears.
- ▶ Enter the determined value for the T-boiler and, if available, the determined values for soot number 1, soot number 2, soot number 3 and derivative.
- ▶ Press F1 to create a printout.
- ▶ Press F2 to display an OR code of the measurement.
- ▶ Press F3 to store the measurement.

7.13. Print measurement values

You have the possibility to print measurement results via the following optionally available printers.

- Speed printer (IR desktop printer)
- HSP 580 (Highspeed-Bluetooth-Thermoprinter)



NOTE

Before you can print measurement results, you must select and configure the appropriate printer (printer type) in the menu printout.

Open menu print-out

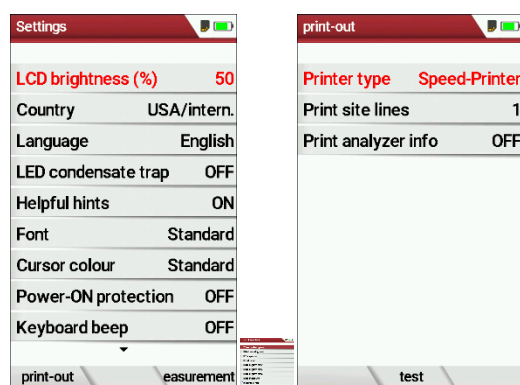

- ▶ Open the menu Settings.
 - ☞ See also chapter 5.2 Customize settings, Page 24.
- ▶ Press F1.
 - ☞ The menu print-out appears.
- ▶ Set the desired settings.

Setting	Description
Printer type	Selection of the printer type
Print site lines	Line 1 (plant number) is required. The other lines (free text lines) can be printed if required.
Print analyser info	Measurement printouts can be made shorter by omitting the analyser. However, in some printouts (calibration, service, etc.) the info is still printed.

Print measurement results with Speedprinter

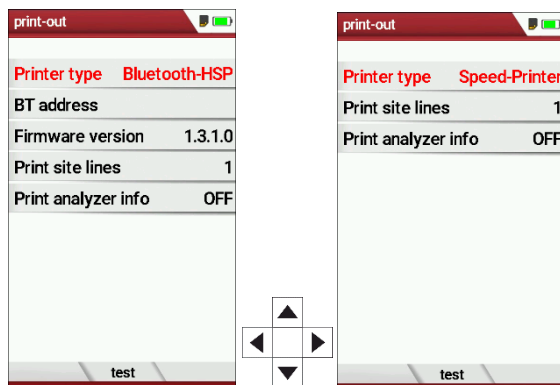

- ▶ Go to the menu print-out.
 - ☞ See also chapter Open menu print-out, Page 52.
- ▶ Select Speed-Printer as Printer type.
- ▶ Align the printer as follows:



- ▶ Press the printer key. Optionally, press the context menu key and select Printout (Pr.)
 - ⇒ A print-out is created.

Further technical specifications as well as battery and paper rolls changes please see separate printer manual.

Print measurement results with Highspeed-Bluetooth-Thermoprinter

► Go to the menu print-out.

☞ See also chapter Open menu print-out, Page 52.

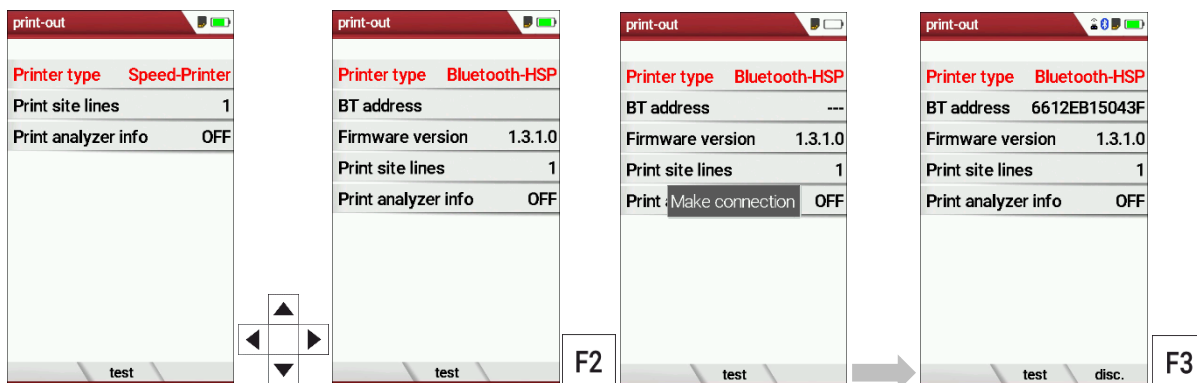

► Select Bluetooth-HSP as Printer type.

► Press F2.

- ⇒ The connection between analyser and the printer is established.
- ⇒ After the connection between the analyser and the printer has been established, the Bluetooth address (BT address) appears in the display. An existing connection to a printer is indicated by a printer icon and a Bluetooth icon.



► Press F3 to disconnect the analyser from the printer.

You can also disconnect an existing connection between Bluetooth and printer in the Measurement menu:

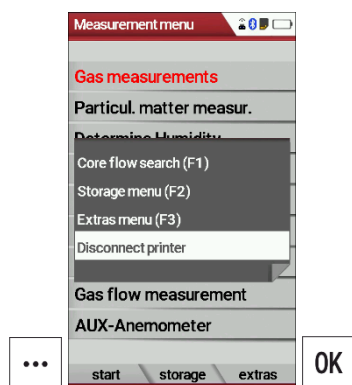

► Go to the Measurement menu.

► Press the menu key.

- ⇒ A selection list appears.

► Select Disconnect printer.

► Press OK

- ⇒ The printer is disconnected.

7.14. Stop measurement

A running measurement can be stopped at any time by pressing the F1 key. The window changes colour and the measured values are frozen. All measured values available at the time of stopping are available in the analyser and can still be displayed. By pressing the ESC key, the analyser returns to Measurement menu.

7.15. Last measured values

The analyser offers the possibility to continue working with the last measured values after the end of a measurement.

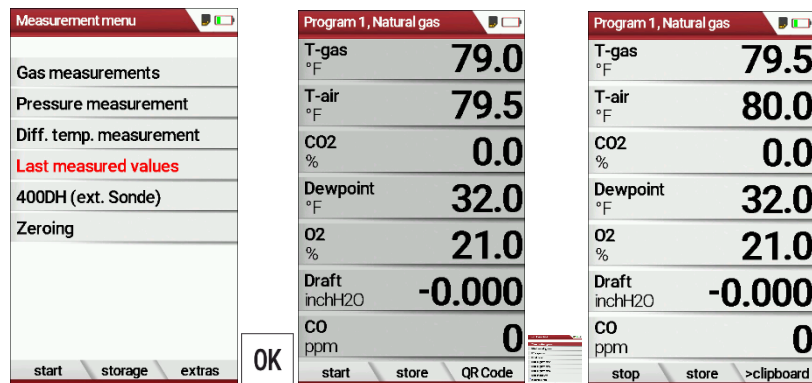

- ▶ Go to the Measurement menu.
- ▶ Select Last measured values
 - ⇒ The measuring window with the last measured values appears.
- ▶ Press F1.
 - ⇒ The measurement is continued.

8 Data storage

8.1. Organize data storage

The basis for the data storage of the analyser is saved sets of sites inside the analyser. Each site has a distinct site number as well as 8 additional free text lines for names and address.

The analyser can store up to 32,000 different sites.

Sites can be newly created and changed in the analyser, or are transferred e.g., via a PC - program by means of ZIV - module.

NOTE



New sites created in the analyser will NOT be transferred back to the computer program. When transferring data from the analyser to the computer only measurement data will be transferred, identified by the site number that has been assigned to the measurement, when the measurement was saved.

Measurements are stored by assigning them to a site. Measurements can be gas measurements or other measuring programs available in the analyser.

8.2. Call up information about Memory info

In the menu item "storage" you select „memory info“ to get information about the actual memory volume. The part of free memory, the total number of the stored sites and the number of the measurements stored all together, split in the kind of the measurement is listed.

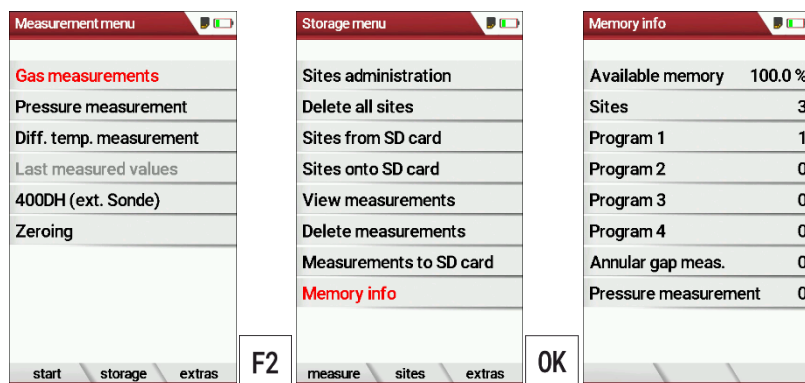

- ▶ Go to the Measurement menu.
- ▶ Press F2.
 - ⇒ The Storage menu appears.
- ▶ Select Memory info.
- ▶ Press OK.
 - ⇒ Das Menü Speicher Info erscheint.
 - ⇒ The menu Memory info appears.
 - ⇒ Information about the data storage is listed.

8.3. Sites administration

In the sub menu Sites administration, you can:

- View all data of the stored sites
- Create new sites
- Change data on existing sites
- Delete sites



NOTE

New sites created in the analyser will NOT be transferred to a PC program

Create new site

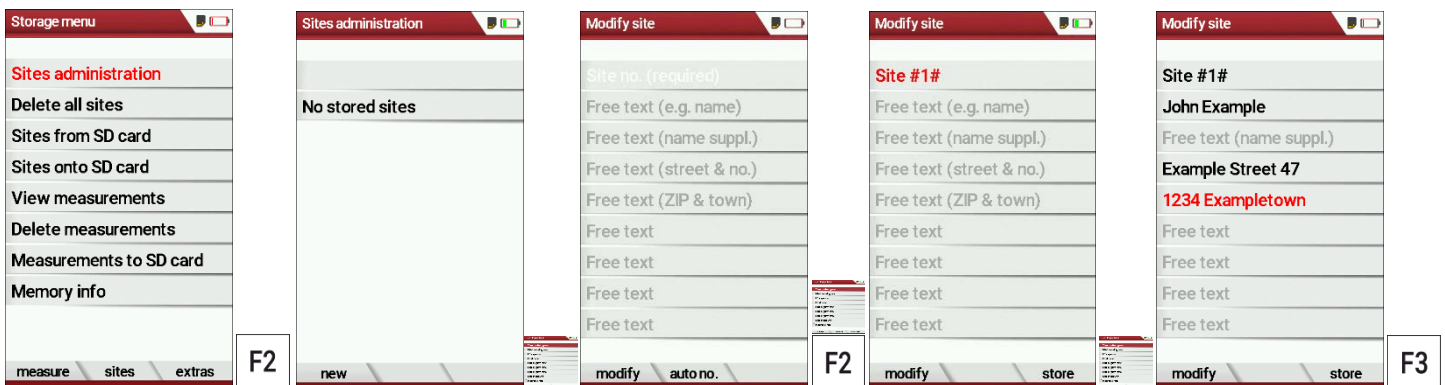

- ▶ Go to the Storage menu.
- ▶ Press F2
 - ⇒ The menu Sites administration appears.
- ▶ Press F1.
 - ⇒ The menu Modify site appears.
- ▶ Press F2 to assign manually a site number to the site.
- ▶ Press F2 to assign automatically a site number to the site.
 - ⇒ The site is assigned a site number.
- ▶ Select the free text lines that you want to edit.
- ▶ Press F1.
 - ⇒ A window appears.
- ▶ Enter the desired content.
- ▶ If necessary, select free text lines and fill them with content.
- ▶ Press F3.
 - ⇒ The site is stored.

View sites

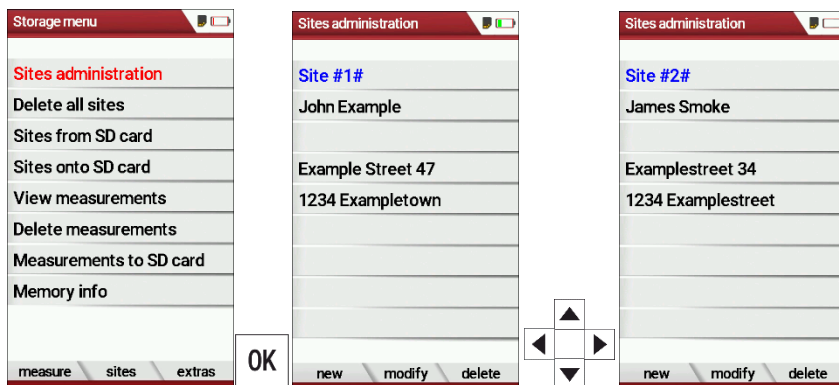

- ▶ Go to the Storage menu.
- ▶ Select Sites administration.
 - ⇒ The menu Sites administration appears.
 - ⇒ Each stored site is displayed on a page with the colored site number and eight additional free text lines.
- ▶ If necessary, scroll through the sites until you have found the desired site.

Change sites

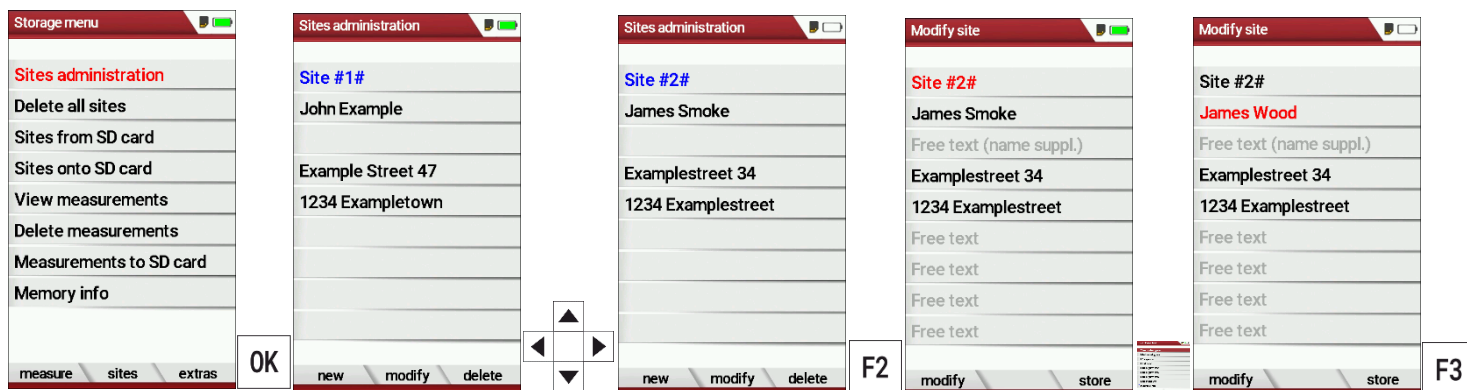

- ▶ Go to the Storage menu.
- ▶ Select Site administration.
- ▶ Press OK.
 - ⇒ The menu Sites administration appears.
- ▶ Select the site that you want to change.
- ▶ Press F2.
 - ⇒ The menu Modify site appears.
- ▶ Select the free text line that you want to change.
- ▶ Press F1.
 - ⇒ A window appears.
- ▶ Enter the desired changes.
- ▶ If necessary, select further free text lines and change the corresponding free text lines.
- ▶ Press F3.
 - ⇒ The changes are stored.

Delete sites

You can delete sites individually or delete all sites simultaneously

Delete sites individually

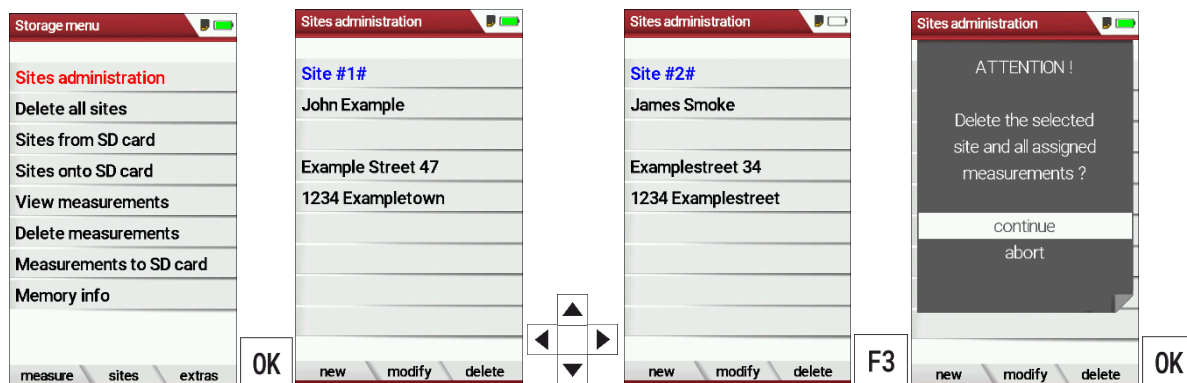

- ▶ Go to the Storage menu.
- ▶ Select Sites administration.
- ▶ Press OK.
 - ⇒ The menu Sites administration appears.
- ▶ Select the site you want to delete.
- ▶ Press F3.
 - ⇒ A message appears.
- ▶ Select continue to delete the site.
- ▶ Select abort to retain the site.
- ▶ Drücken Sie OK.
- ▶ Press OK.
 - ⇒ Depending on the selection, the site is deleted or retained.

Delete all sites

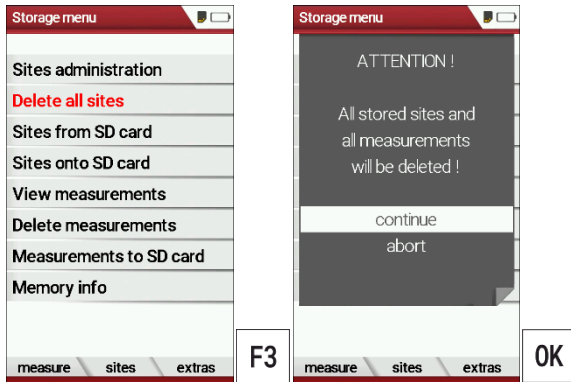

- ▶ Go to the Storage menu.
- ▶ Select Delete all sites.
- ▶ Press OK.
 - ⇒ A message appears.
- ▶ Select continue to delete all sites.
- ▶ Select abort to retain all sites.
- ▶ Press OK.
 - ⇒ Depending on the selection, the sites are deleted or retained.

8.4. Transfer data via using SD card

The data exchange format is CSV. A character-separated values (CSV) file is a simple text format for a database table. Each record in the table is one line of the text file. Each field value of a record is separated from the next by a character. The analyser uses a semi-colon ';' as value separator (other implementations use sometimes a comma). Implementations of CSV can often handle field values with embedded line breaks or separator characters by using quotation marks or escape sequences. CSV is a simple file format that is widely supported, so it is often used to move tabular data between different computer programs, for example Microsoft Excel™ or Access™, that support the format. Also, other computer programs offer this type of interface because it is widely spread and easy to use.

The following functions are available:

- Import sites
- Export sites
- Export measurements

Import sites

With this function you can import Sites which have been created on a computer or another Analyser.

The File name must have the name "anlagen.csv"(anlagen = German for sites). The file has no column heading that means that the first line already has user data. Each line has a minimum of 9 columns (with 8 semi-colons) and the first field in the line will be the site number. All data will be imported as long a site number is available. Per field a maximum of 24 characters will be imported, too long words will be cut off.



NOTE

Before you can import sites via a CSV file, you have to rename the desired CSV file to anlagen.csv. Save the renamed CSV file in the root directory of the SD card.



NOTE

While importing data from the SD Card to the analyser there is no check for double site numbers (Line 1), neither inside of the file that is imported nor between the file and the sites already inside the analyser. The analyser can easily handle double site numbers but you could face problems with double site numbers when exporting them again to a computer program

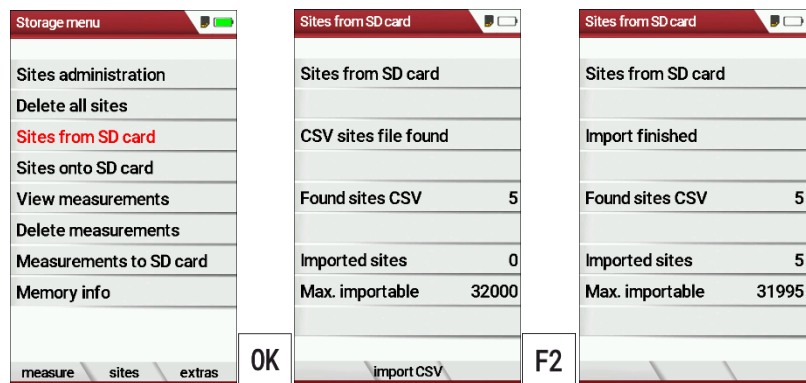

- ▶ Go to the Storage menu.
- ▶ Select Sites from SD card.
 - ⇒ The menu Sites from SD card appears.
- ▶ Press F2.
 - ⇒ The sites are imported.

Export sites

This function can be used for an analyser back up or if you wish to supply the analyser information to a computer program or another analyser. This is very handy if you have made some modifications inside the analyser (site) for example if you have modified the phone number of a customer and this modification needs to be updated in the computer software, or if a second analyser needs to have the same site information.

The File format it's the same as described above „Import sites“.

Only the file name is different, the file name will be ‚ANLxxxx.csv‘, in which the xxxxx are continuing 5-digit numbers with leading zeros.

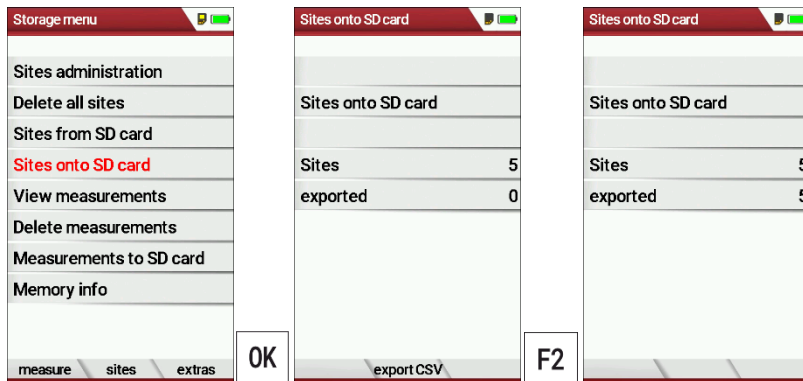

- ▶ Go to the Storage menu.
- ▶ Select Sites onto SD card.
- ▶ Press OK.
 - ⇒ The menu Sites onto SD card appears.
- ▶ Drücken Sie F2.
- ▶ Press F2.
 - ⇒ The sites are exported onto SD card.

If the file must be imported into another analyser, the file must first be re-named into „anlagen.csv“.

Export measurements

With this function, the analyser can make its stored measurements available to a PC.

Attention, this function is not suitable as a backup or for transferring the measurements to other measuring devices, as the measurements cannot be imported again.

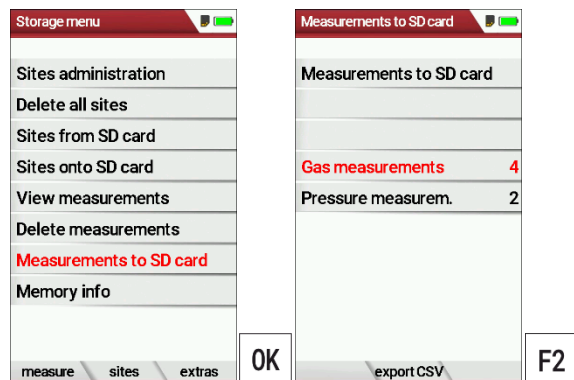

- ▶ Go to the Storage menu.
- ▶ Select Measurements to SD card.
- ▶ Press OK.
 - ⇒ The menu Measurements to Sd card appears.
- ▶ Select the measurement type you want to export. In this example, gas measurements are exported.
- ▶ Press F2.
 - ⇒ The measurements are exported.

8.5. Measurements in Data storage

View measurements

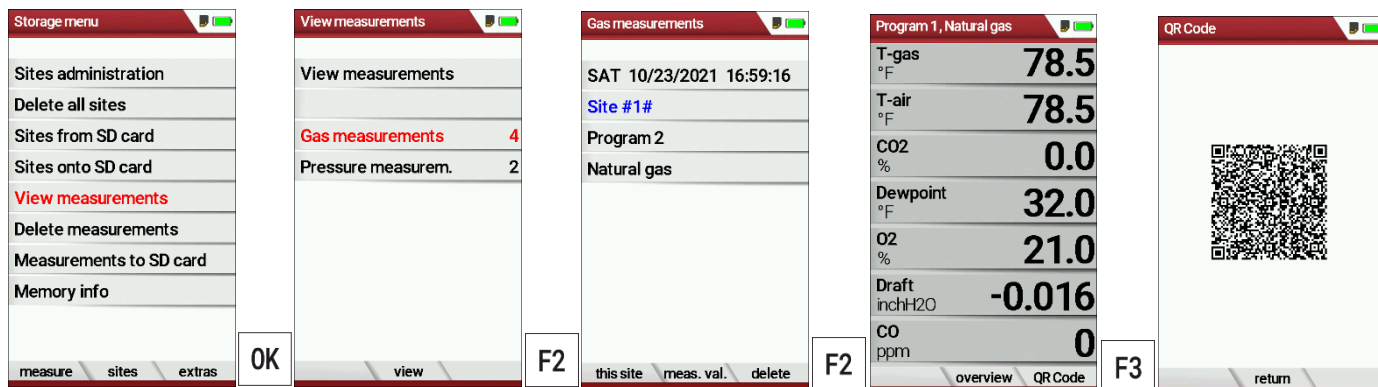

- ▶ Go to the Storage menu.
- ▶ Select View measurements.
 - ⇒ The menu View measurements appears.
 - ⇒ An overview of the number of stored measurements depending on the measurement type appears.
- ▶ Select the desired measurement type. In this example, gas measurements are selected.
- ▶ Press F2.
 - ⇒ Then you first get a page with context information about the saved measurements
- ▶ Select the desired measurement.

NOTE



You have the possibility to select only the measurements that are stored for a site by selecting F1 = "this site" while a measurement of the desired site is displayed. With F1 = "all sites" you cancel this filter again.

- ▶ Press F2.
 - ⇒ The measured values of the stored measurements are displayed in detail.
- ▶ Press F3 to display gas measurements as an OR Code

Delete measurements

You can

- Delete single measurements
- Delete all measurements or delete all measurements of a measurement type

Delete single measurements

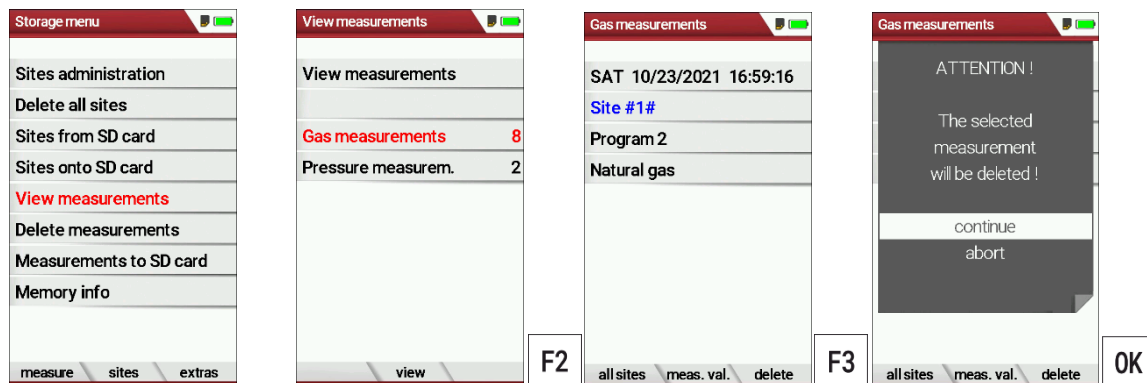

- ▶ Go to the Storage menu.
- ▶ Select View measurements.
- ▶ Drücken Sie OK.
- ▶ Press OK.
 - ⇒ The menu View measurements appears.
 - ⇒ An overview of the number of stored measurements depending on the measurement type appears.
- ▶ Select the desired measurement type.
- ▶ Press F2.
 - ⇒ The stored measurements are displayed.
- ▶ Select the measurement you want to delete.
- ▶ Press F3.
 - ⇒ A message appears.
- ▶ Select continue to delete all sites.
- ▶ Select abort to retain all sites.
- ▶ Press OK.
 - ⇒ Depending on the selection, the measurements are deleted or retained.

Delete all measurements

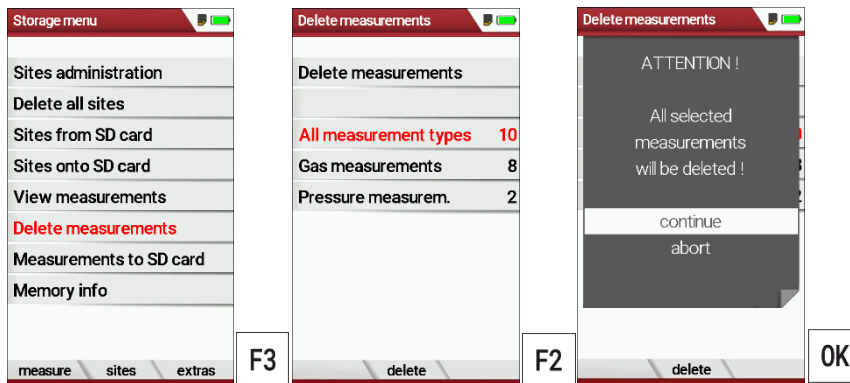

- ▶ Go to the Storage menu.
- ▶ Select Delete measurements.
- ▶ Press OK.
 - ⇒ The menu Delete measurements appears.
- ▶ Select which measurement type you want to delete.
- ▶ Press F2.
 - ⇒ A message appears.
- ▶ Select continue to delete all sites.
- ▶ Select abort to retain all sites.
- ▶ Press OK.
 - ⇒ Depending on the selection, the measurements are deleted or retained.

9 Extras / Adjustment

The analyser is delivered with a standard preset software, which should cover your needs in most cases. However, the settings are highly flexible and customizable.

If you want to change various settings, we recommend that you do so with a little thought. The better you plan the settings, the less often you will have to correct them and the more comfortable you will be working with the analyser.

Use the possibilities of the individually configurable measuring methods, measuring displays, pressure outputs and self-selecting fuels in such a way that all your practical requirements are met as far as possible. Then you will rarely have to make changes to the settings again. After making changes to the settings, you should switch off the analyser once briefly so that the changes are permanently saved and take effect when you restart the analyser.

9.1. Service menu

The Service menu is protected by a PIN code against unauthorized access.

For the PIN code, contact an MRU service center (www.mru.eu).

If you have started the PIN code query by mistake, press the ESC key. You will return to the Extras menu.

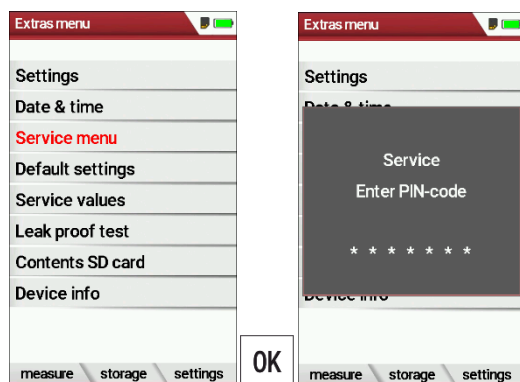

- ▶ Go to the Extras menu.
- ▶ Select Service menu.
- ▶ Press OK.
 - ⇒ A window for entering the PIN-code appears.
- ▶ Enter the PIN-Code.
 - ⇒ If you enter the PIN-code correctly, you will have access to the service menu.
 - ⇒ If the PIN-code is entered incorrectly, you will be returned to the Extras menu.

9.2. Default settings

The analyser is reset to the default settings.



NOTE

With the default settings, all individual settings are lost.

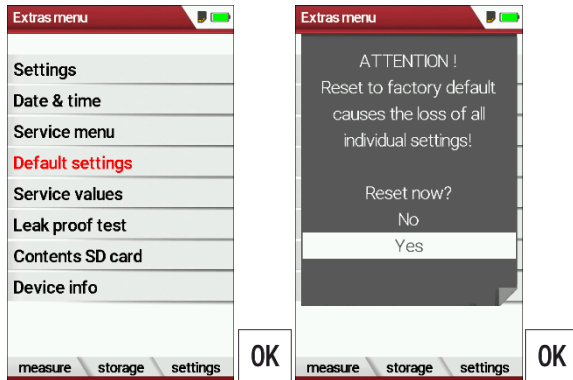

- ▶ Go to the Extras menu.
- ▶ Select Default settings.
- ▶ Press OK.
 - ⇒ A window appears.
- ▶ Select "No" to not reset the default settings.
- ▶ Select "Yes" to reset the analyser to default settings.
- ▶ Press OK.
 - ⇒ Depending on the selection, the analyser is reset to the default settings or not.

9.3. Service values

Should your analyser display an error message after zeroing (for example: „O2-Sensor not OK“), then you can use the Service value menu to get detailed information about possible defects. In this menu you will see all service values of the sensors and also other parameters.

In case of a defect contact the MRU service department. The MRU service technician will ask you about these values or he will ask you to send them by fax or email.

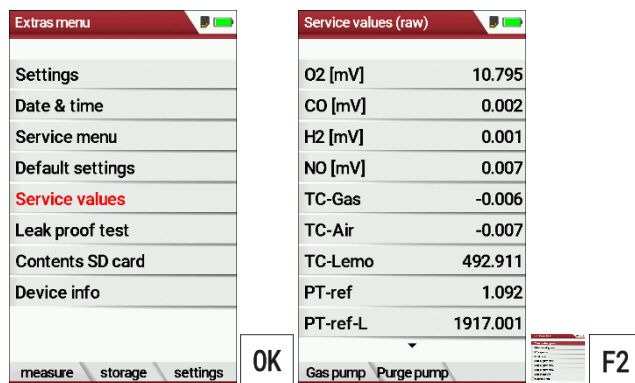

- ▶ Go to the Extras menu.
- ▶ Select Service values.
- ▶ Press OK.
 - ⇒ The Menu Service values appears.
- ▶ If necessary, press F1 to switch on the function test of the Gas pump
- ▶ If necessary, press F2 to switch on the function test of the Purge pump.
- ▶ Press OK.
 - ⇒ A window for entering the Pin-Code appears.



NOTE

For the PIN code, contact an MRU service center (www.mru.eu)

- ▶ Enter the Pin-Code.
 - ⇒ The selected function test is switched on or off.

9.4. Performing leak test

During the leak test, the system (including the condensate separator) is checked for leaks by the analyser.

For this purpose, the internal gas pump generates a vacuum which is measured by the built-in tension sensor and observed over a period of 10 seconds. Based on the size of the observed pressure drop, the leak tightness of the system is determined.

Operation:

- ▶ Put the leak test cap # 61382 (for probe tubes Ø 8 mm) onto the probe tip.



NOTE



With dirt and soot on the probe tube the test cap will not seal properly.

- ▶ Clean the probe tube before starting the leak proof test.

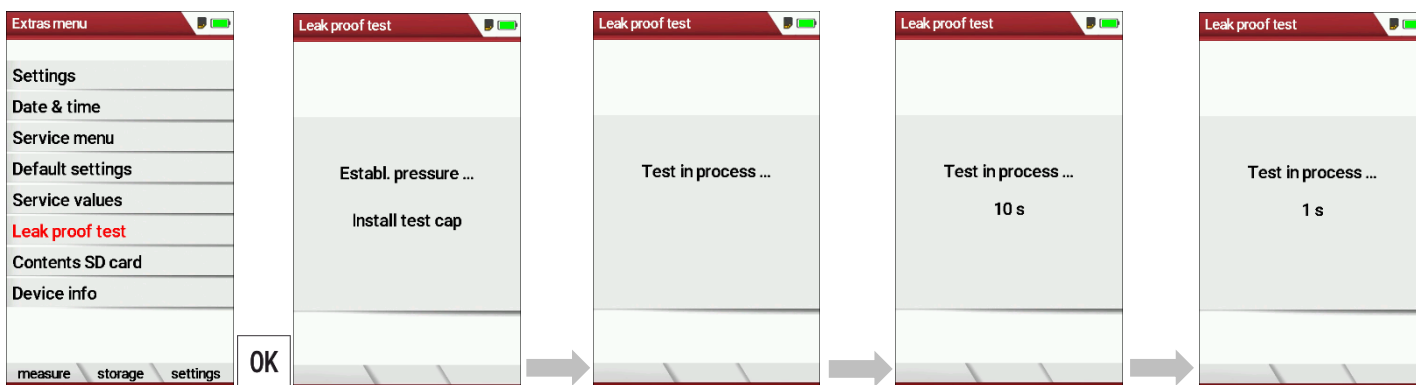

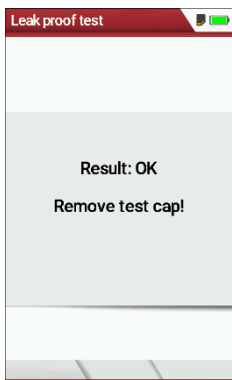

- ▶ Go to the Extras menu.
- ▶ Select Leak proof test.
- ▶ Press OK.
 - ⇒ The menu Leak proof test appears.
- ▶ Ensure that the leak test cap is plugged on.
 - ⇒ Pressure is established.
 - ⇒ A 10-second test is running.
 - ⇒ A message appears whether the leak proof test was passed or not.
- ▶ Remove the proof test cap.

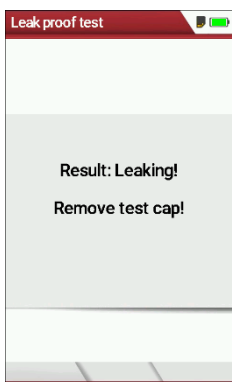

If the leak proof test is not passed, you must check the probe including the tubing and the condensate separator.

If no leakage is detected on these external parts, the analyser has to be check service center (service centers at www.mru.eu).

9.5. Contents SD card

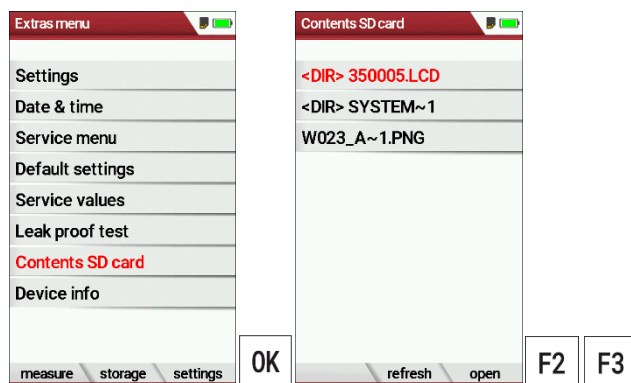

- ▶ Go to the Extras menu.
- ▶ Select Contents SD card.
- ▶ Press OK.
 - ⇒ The menu Contents SD card appears.
 - ⇒ The files stored on the SD card are displayed.
- ▶ If necessary, press F2 to refresh.
- ▶ If necessary, press F3 to open the file.

9.6. Device info

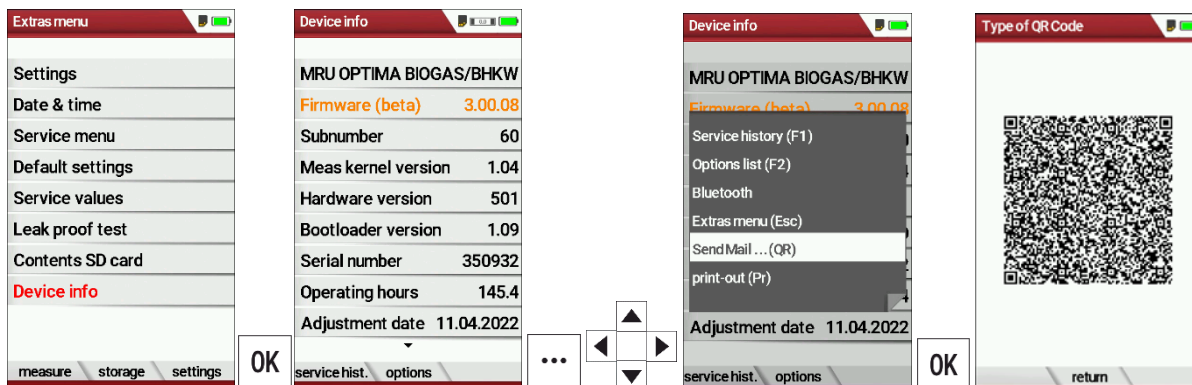

- ▶ Go to the Extras menu.
- ▶ Select Device info.
- ▶ Press OK.
 - ⇒ The menu Device info appears.
 - ⇒ Information about the analyser is displayed, for example serial number and firmware version.



NOTE

You have the option of scanning the device information via QR code and sending it as an E-mail. Use a QR code scanner for this function.

- ▶ If necessary, press the menu key.
 - ⇒ A selection list appears.
- ▶ Select Send Mail... (QR).
- ▶ Press OK.
 - ⇒ The menu QR-Code appears.
- ▶ Scan the QR-Code.
 - ⇒ You can send the device information as E-mail.

Options list

- ▶ Go to the Extras menu.
- ▶ Select Device info.
 - ⇒ The menu Device info appears.
- ▶ Press F2.
 - ⇒ The menu Options list appears.

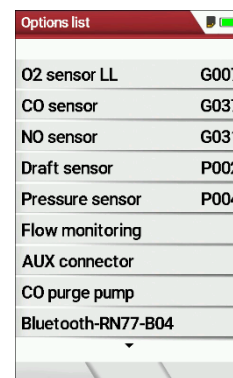

NOTE

You have the option of scanning the Options via QR code and sending it as an E-mail. Use a QR code scanner for this function.

- ▶ If necessary. Press the menu key.
 - ⇒ A selection list appears.
- ▶ Select Send Mail ... (QR).
- ▶ Press OK.
- ▶ The menu Type of QR-Code appears.
- ▶ Scan the QR-Code.
- ▶ You can send the Options list as E-mail

Service Historie	
Service-Zähler [h]	0.0
Service am	07.05.2021
Service am	----
Service am	----
Service am	----
Service am	----
Service am	----
Service am	----
Service am	----

Service history

- ▶ Go to the Extras menu.
- ▶ Select Device info.
 - ⇒ The menu Device info appears.
- ▶ Press F1.
 - ⇒ The menu Service history appears.
 - ⇒ Information about the date of the last seven service operations appears.

10 Maintenance and care

10.1. Cleaning and care

The analyser requires very little maintenance to maintain its value for a long time:

- occasionally: Cleaning the probe and the probe tube
- after each measurement: Pull off the gas sampling hose on the analyser, so that the hose can dry
- If not used for a longer time, charge the battery first.
- Charge the battery approximately every 4 weeks, if the analyser was not used

10.2. Maintenance

An annual inspection and, if necessary, calibration of the sensors by an MRU service centre is recommended.

NOTE



Please note that correct operation of the measuring device can only be operated correctly if the sensors are adjusted/calibrated regularly.

- ▶ Have the sensors adjusted / calibrated 1-2 times a year depending on the frequency of use.

10.3. Service messages

The message "Recommendation Customer Service..." is displayed after 1,000 hours or after 11 months at the latest.

If the analyser has an optional 60-month warranty extension, this is displayed in another window. Confirm these messages with F2= OK. The next time you switch on, you will again be reminded to carry out the annual service.

A complete check at an MRU service centre (MRU service centres can be found at www.mru.eu) includes the function check and calibration or cleaning of the following components: Sensors, pumps, internal / external hose lines, battery, draught, electronics, time and date, temperature inputs, gas sampling probe, condensate separator.

11 Option Gas flow measurement

This option enables the measurement of the flow velocity in flue pipes or flue gas stacks

11.1. Connect Prandtl (Pitot) tube to analyser

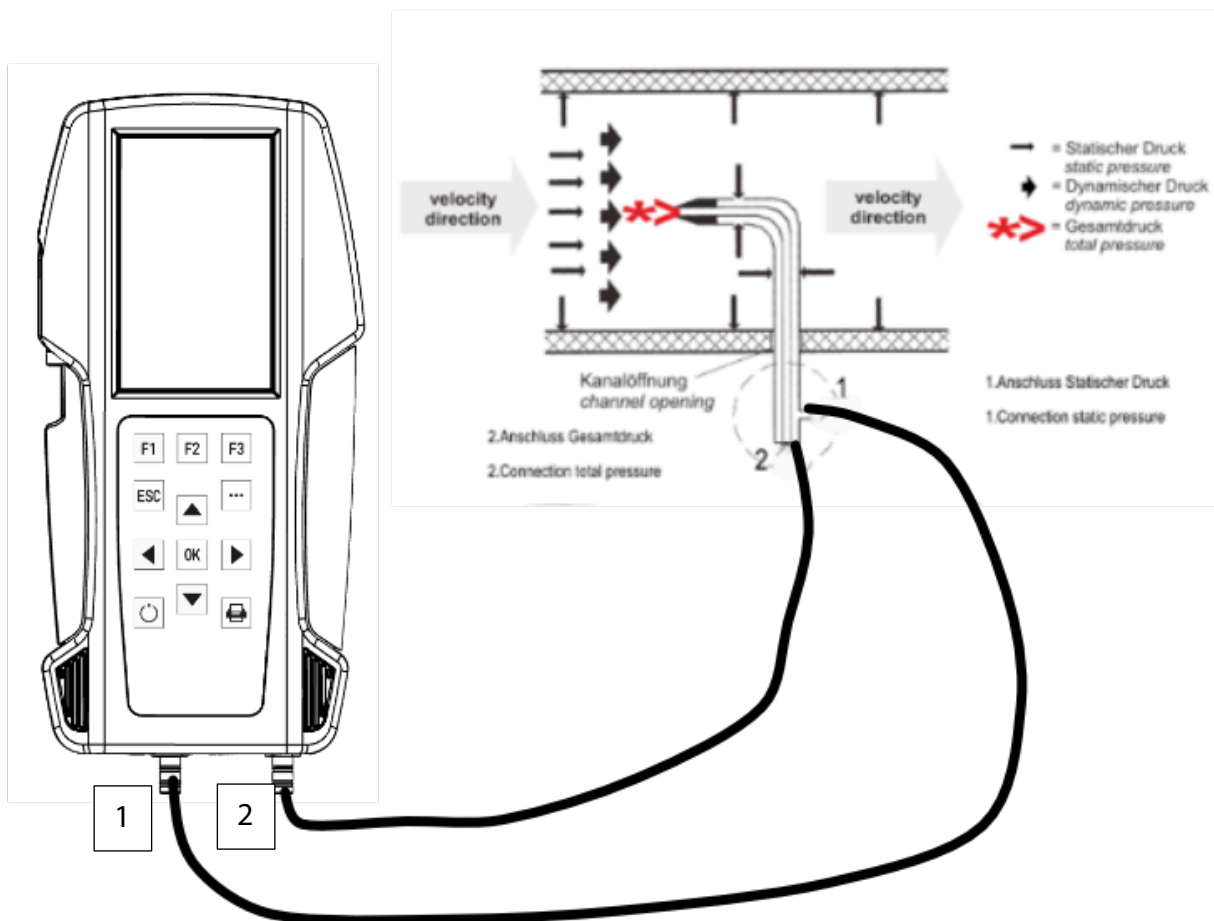

11.2. Open menu Gas flow measurement

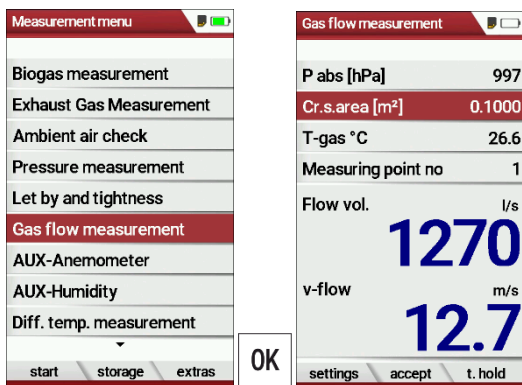

- ▶ Go to the Measurement menu.
- ▶ Select Gas flow measurement.
- ▶ Press OK.
 - ⇒ The menu Gas flow measurement appears.

NOTE

If you have not connected a temperature sensor, the following message appears: ATTENTION! The actual gas temperature must be measured for correct readings!



- ▶ If necessary, connect a temperature sensor via the temperature connection T2 on the analyser to measure the actual temperature.

If you do not connect a temperature sensor, a value for T-gas of 20°C is automatically assumed.



11.3. Define settings and parameters

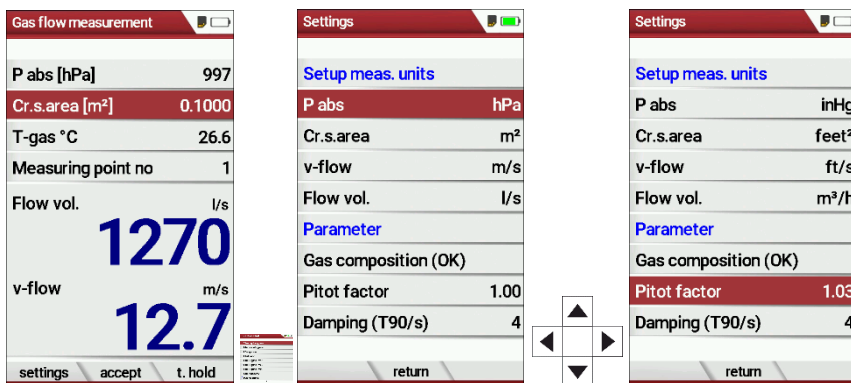

- ▶ Press F1.
 - ⇒ The menu Settings appear.
- ▶ Setup the desired measurement units.
- ▶ Set the desired parameter.

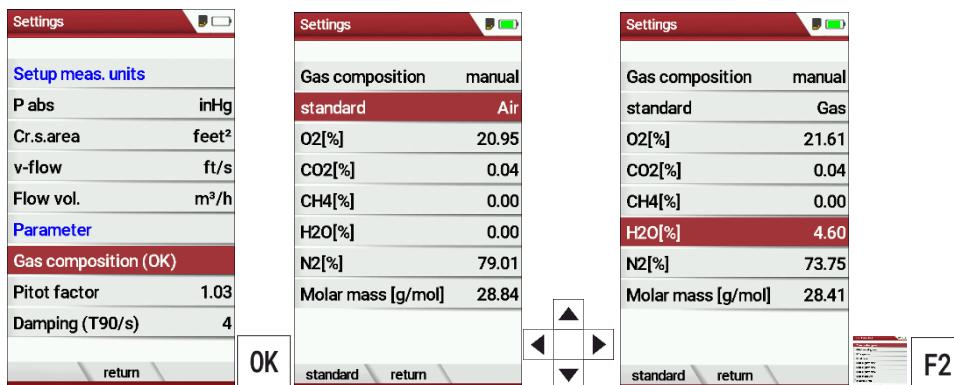

- ▶ Select Gas composition (OK) to adjust the gas composition to your needs.
- ▶ Press OK.
 - ⇒ A list of the gas composition appears.
- ▶ Select standard.
- ▶ Select the desired gas type.
- ▶ Set the desired values for O2, CO2, CH4, H2O.
 - ⇒ The values for N2 and molar mass adjust automatically.
- ▶ If necessary, press F1 to set default values.
- ▶ If necessary, press F1 to set standard values.
- ▶ Press F2 to exit the menu

11.4. Enter Cross section area



NOTE

Before you can perform a flow measurement, you must select the desired cross-section and enter the corresponding side length

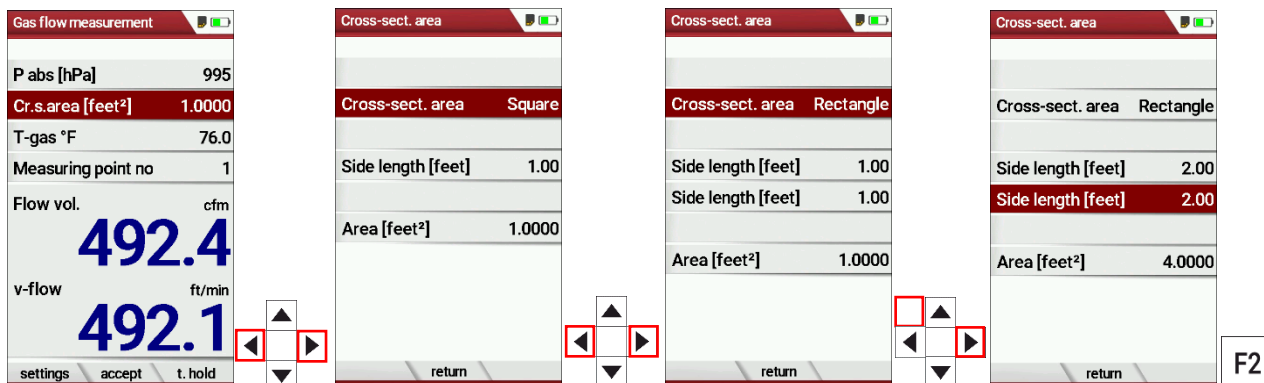

- ▶ Press the arrow keys left/right in the menu Gas flow measurement.
 - ⇒ The menu Cross-sect. area appears.
- ▶ Select the desired Cross-sect. area.
- ▶ Enter the corresponding side lengths.
- ▶ Press F2.
 - ⇒ The menu Gas flow measurement appears.

11.5. Perform measurement

The Prandtl tube is inserted vertically into the canal.
The probe tip is held against the direction of flow

The total pressure is determined at the tip of the Prandtl pipe.
The static pressure is determined at the pressure inlets of the Prandtl pipe.

The dynamic pressure corresponds to the difference between the total pressure and the static pressure.

P dyn. = P tot. - P stat.

The flow velocity is calculated according to the following formula:

$$v = 1,291 \sqrt{\frac{1000}{P_{\text{baro}} + P_{\text{stat}}} \times \frac{273,15 + T}{289} \times P_{\text{dyn}}}$$

Legend:

P stat << P baro

v = flow velocity [m/s]

P baro = Barometric pressure [hPa]

T = gas temperature

P stat = Static pressure [Pa]

P dyn. = Dynamic pressure [Pa]

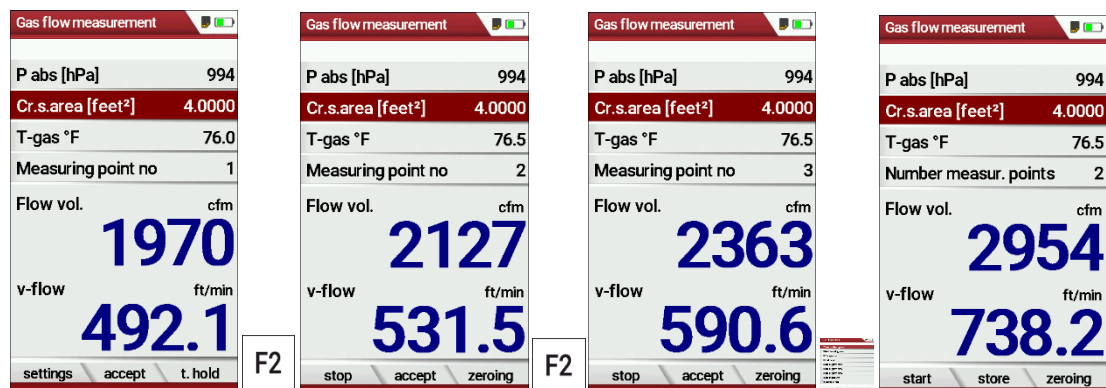

- ▶ Press F2 as soon as the measurement for measuring point no. 1 is finished.
 - ⇒ The measured values for measuring point no. 1 are taken over.
 - ⇒ Measuring point no. 2 appears in the menu.
- ▶ If necessary, carry out measurements for further measuring points and accept the measured values with F2. The measuring point no. is raised accordingly.
- ▶ Press F1.
 - ⇒ The measurement is stopped.
- ▶ Press F2, to store the measurement.

12 Option: Monitoring flow rate

The flow rate is continuously monitored. In the event of an error, the following message appears in the display:

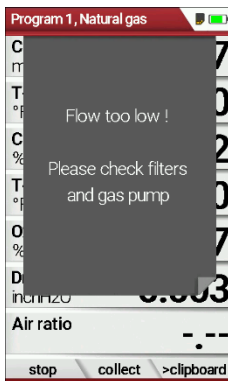

If the flow rate is too low, this message is displayed every 8 seconds.
Folgende Fehler können die Ursache sein:

- Filter clogged
- Hose line kinked
- Pump defective

It is recommended to check the filter elements.
If these filter elements are OK, please contact the customer service.

13 Option: Auto-measurement

With the automatic measurement option, the analyser can log continuous measurements independently. You can largely adapt the properties of the automatic measurement to your individual requirements. The data is stored in the internal data memory and can then be transferred to the SD card.

As the size of the data memory is limited, the ratio between total duration and interval is also subject to certain limits if the automatic measuring system is to store values in the data memory. The analyser displays the required memory.

If the required memory is too high, reduce the measurement duration or increase the interval to minimize the required memory.

If there is not enough free memory available, delete the measuring data memory.

When starting a measurement, the Auto-measurement is switched off in principle. You must consciously activate the Auto-measurement via the menu key.

- ▶ Start a measurement.

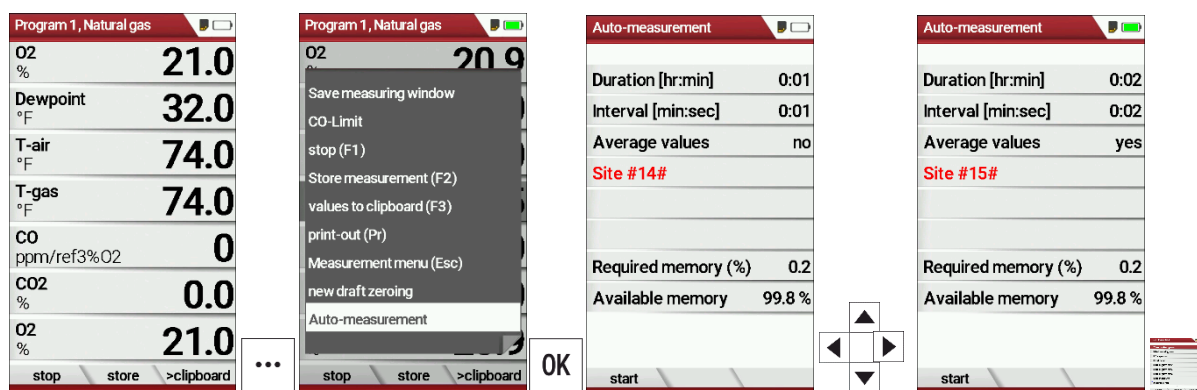

- ▶ Press the menu key.
 - ⇒ A selection list appears.
- ▶ Select Auto-measurement.
- ▶ Press OK.
 - ⇒ The menu Auto-measurement appears.
- ▶ Set the desired values and select the desired site.

NOTE



Setting Average values:

Yes: Analyser calculates the mean during each interval and stores this value.

No: Analyser stores the values being measured at the end of the interval.

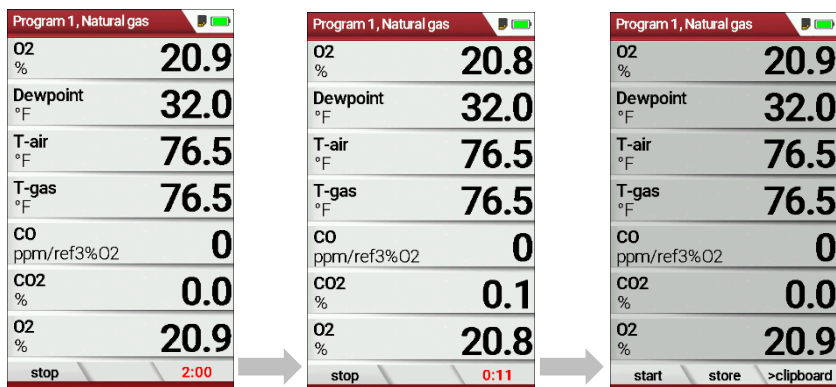

► Press F1.

- ⇒ The measurement starts.
- ⇒ The display shows the remaining time of the measurement.
- ⇒ After the set measuring time has elapsed, the measurement stops automatically.

► Press F2, to store the measurement.

- ☞ See also chapter 7.12 Store measurement values, Page 50.
- ☞ For exporting measurements see also chapter Export measurements, Page 64.

14 Appendix

14.1. Technical data

General Data

Operating temperature	+5°C ... +45 °C / 41 °F ... 113 °F
Rel. Humidity, non-condensing	95%
Storage Temperature	-20°C ... +50°C / -4°F ... 122°F
Data storage	20000
(dynamic, up to [datasets])	
Internal Battery Pack, operating hours (typical)	Li-Ion, 14 h
Power supply	5V DC / 1200 mA
Weight w/ 2 sensors	750g / 1.65 lbs
Size	244x113x54 mm
	4.3x 8.8 x2.04 in
Housing material	PA6
IP protection with protection cap	IP30
Max suction range gas pump	150 hPa
gas flow typ.	60 l/h

Measured values

Electrochemical Sensor	O₂ Long Life
Measuring Range	0 ... 25 Vol%
Abs. Accuracy	± 0,2 Vol%
Response Time T90	< 20s
Years expected lifetime (@air)	3
CO ₂ tolerance up to	100 Vol%
Electrochemical Sensor	CO
H ₂ compensated	
Nom. Measuring Range	0 .. 10.000 ppm
Overload Range	< 20.000 ppm
Resolution	1 ppm
Accuracy abs. / reading	± 10 ppm / 5% (0 .. 4000 ppm)
	10% (> 4000 ppm)
Response Time T90	< 40s
Electrochemical Sensor	NO (Option #63058)
Nom. Measuring Range	0 .. 1000 ppm
Overload Range	< 5000 ppm
Resolution	1 ppm
Accuracy abs./reading	± 5ppm / 5% (0 - 200 ppm) 10%
	(> 200 ppm) 10% (> 1000 ppm)
Response Time T90	< 30s

Electrochemical Sensor	NO₂
Nom. Measuring Range	0 .. 200 ppm
Overload Range	< 1000 ppm
Resolution	1 ppm
Accuracy abs./reading	± 5ppm / 5% (0 - 200 ppm) 10% (> 200 ppm)
Response Time T90	< 60s
Option	NO₂ low
Measuring Range	0 .. 300 ppm
Resolution	0,1 ppm
Accuracy	4 ppm / 5%
Electrochemical Sensor	H₂
Nom. Measuring Range	0 .. 1000 ppm
Overload Range	< 2000 ppm
Resolution	1 ppm
Accuracy abs./reading	± 5 ppm / 5% (0...2000 ppm) 10% (> 500 ppm)
Response Time T90	< 100s
Electrochemical Sensor	H₂S
on additional position	
(depending on configuration)	
Nom. Measuring Range	0 .. 500 ppm
Overload Range	< 2000 ppm
Resolution	1 ppm
Accuracy abs./reading	± 5 ppm / 5% (0...2000 ppm) 10% (> 500 ppm)
Response Time T90	< 40s
Electrochemical Sensor	H₂S
on standard position	
(depending on configuration)	
Nom. Measuring Range	0 .. 2000 ppm
Overload Range	< 5000 ppm
Resolution	1 ppm
Accuracy abs./reading	± 5 ppm / 5% (0...2000 ppm) 10% (> 2000 ppm)
Response Time T90	< 40s
Non-dispersive Infrared Measurement (NDIR)	CO₂
Nom. Measuring Range	0 .. 100 Vol%
Resolution	0,01 Vol%
Accuracy abs./reading	± 0,3 Vol% / 3%
Response Time T90	< 35 s
Non-dispersive Infrared Measurement (NDIR)	CH₄
Nom. Measuring Range	0 .. 100 Vol%
Resolution	0,01 Vol%
Accuracy abs./reading	± 0,3 Vol% / 3%
Response Time T90	< 35 s

Non-dispersive Infrared Measurement (NDIR)	CH₄
low range	
Nom. Measuring Range	100 .. 40000 ppm
Resolution	10 ppm
Accuracy abs./reading	±400 ppm/ 5%
Response Time T90	< 35 s
Temperature measurement	T₁, T₂
Number of thermocouple type K input	2
Measuring Range	-40 °C .. 1200 °C
Accuracy	±2°C / 0,5%
Flue gas temperature	T_A
(using MRU probe)	
Measuring Range with high grade steel probe pipe	0 .. 800°C
Measuring range with Inconel probe pipe	0 .. 1100°C
Accuracy abs. / reading	±2°C / 0,5%
Ambient temperature	T_i
(using MRU sensor)	
Measuring Range with ambient temperature probe	0 ... 100°C
Accuracy	1 °C
Accuracy abs./reading	
Differential Pressure	
Measuring Range	± 300 hPa
Accuracy abs. / reading	0,03 hPa / 1%
Velocity	
Gas Temperature	-20°C ... +800 °C
Total pressure	700 ... 1300 hPa
Dynamic Pressure	4 Pa ... 100 hPa
Measuring Range	1 m/s ... 100 m/s
Accuracy w/o error of pitot tube	± 1m/s (0..2 m/s) ± 0,2 m/s (2... 10 m/s) ± 0,5% (> 10 m/s)
Resolution	0,1
Flow measurement	
Input cross section area	
shape	Kreis (Circle) / Rechteck (Rectangle) / Quadrat (Square) / freie Eingabe (free Input)
Unit	cm, m, cm ² , mm ² , feet ² , inch ²
Range	0...60m ²
Measuring Range	0,1l/s - 6000m ³ /s
Resolution	0,1

Analysis and calculations

Air ratio	
Measuring Range	1-20
Resolution	0,01
Excess Air	
Measuring Range	0 - 999 %
Resolution	1%
Dew point	
Unit	°C
Measuring Range	0-100 °C
Resolution	0,1
Losses qA	
Measuring Range	0 - 99,9%
Resolution	0,1
Efficiency	
Measuring Range	0 - 120%
N2 Background	
Unit	Vol%
Measuring Range	0-100%
Resolution	0,10%
NOx = NO + NO2	
Unit	ppm / mg/m3 NO2
Resolution	1 ppm / 1 mg/m3
Net calorific value	
Unit	MJ/Nm3, MJ/kg
Measuring Range	0-36 MJ/Nm3, 0-50 MJ/kg
Resolution	0,1
Gross calorific value	
Unit	MJ/Nm3, MJ/kg
Measuring Range	0-40 MJ/Nm3, 0-56 MJ/kg
Resolution	0,01
Measurement values available as	mg/Nm ³ , O2 Ref mg/kWh
	NOx: mg/Nm ₃ NO ₂

*The analyser calculates the gross and net calorific value (gcv and ncv) of the measured gas mixture.

The measured values are:

ncv [MJ/m³]

ncv [MJ/kg]

gcv [MJ/m³]

gcv [MJ/kg]

The calculation of the the 2 gcv values is (with presumption, that CH₄ is the significant 87ombustible part of the gas mixture):

$$gcv [MJ/m^3] = 1.109 * ncv [MJ/m^3]$$

$$gcv [MJ/kg] = 1.109 * ncv [MJ/kg]$$

Measured values	Unit
O ₂	[%]
Temp. Ambient air (Thermocouple)	[°C]
Temp. Flue gas (Thermocouple)	[°C]
CO	[ppm]
CO ₂	[%]
Pressure	[hPa]

Available conversions of CO	CO
[ppm] related to. On 0% rest O ₂ (undiluted)	X
[ppm] related to. On fuel type dependent O ₂ reference value	X
[mg/m ³]	X
[mg/kWh]	X
[mg/MJ]	X
[mg/m ³] on fuel type dependent O ₂ reference value	X

Continuously calculated values	Unit
Air ratio	-
Dew point	[°C]
CO/CO ₂ ratio	[%]

14.2. Reset analyser

If the analyser no longer responds, you can perform a reset.

- ▶ Press the ESC button and the ON/OFF button simultaneously.

14.3. Troubleshooting

Troubleshooting on the analyser

Effect	Error indication	Cause	Solution
Analyser does not respond to any key touch		Device does not react on any key.	Press ESC and Power-ON buttons at the simultaneously.
Undercooling inside the analyser, the analyser is not usable.	Display indication: "Device too cold" or audible sound every 5 sec. .	e.g. analyser was stored in a cold place during winter.	Put the device to a warm room and wait .
Measured values are not correct	Error when taking zero point	Sensors are already exposed to gas when taking the zero point.	Vent the analyser with fresh air and restart.
Analyser does not switch on or does not react after switching on.		Battery discharged.	Connect the analyser to the line power in order to charge the battery.
Measurement without exact temperature values.	Temperature indication: ---, -	Thermoelement defective, balancing network interrupted or not connected.	Call our after-sales service. Remove probe from the gas duct and condensate from the probe tube. .
Wrong measuring values	Measuring range exceeded: Value O ₂ too high Values CO and CO ₂ to low .	Connection probe – device not correct. Leakage at probe / tube / condensate separator, pump does not suck correctly	Perform leak proof test. By visual control of probes, tubes condensate separator, leaking parts could be found.
Wrong measuring values	Gas temperature is too hot or alternates	Probe is not plugged in correctly, defective cable in the probe line, formation of condensate at the probe tip.	Check probe plug respectively probe line regarding damages (loose connection), remove condensate from the probe tip.

Troubleshooting condensate separator

1. Effect	2. Cause	3. Solution
Dirt and / or humidity in-side the device No filter effects Sensor failure Pump failure	Fine filters are wet and / or dirty.	Check filters more often Renew them if necessary white = OK Brown-black = renew
Wrong measuring values	Cover, intermediary unit, plexiglass tube and locking pieces are not tightly fixed respectively screwed	Check tightness with every filter change.

14.4. Update firmware

Check current firmware version

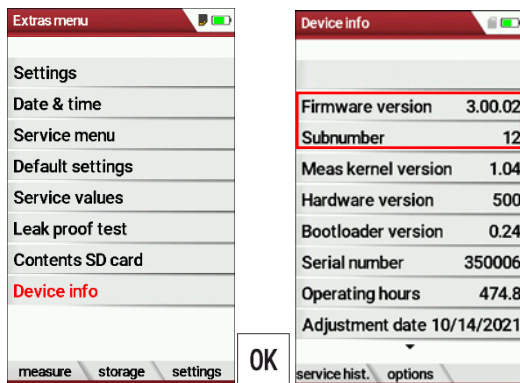

- ▶ Go to the Extras menu.
- ▶ Select Device info.
 - ⇒ The menu Device info appears.
 - ⇒ The current firmware version appears. In this example, the firmware version is 3.00.02.

In case there are any problems with updating the firmware, we need some information from you.

- ▶ Write down the current Firmware version.
- ▶ Write down the Serial number.

Prepare SD card

If you have not received the new firmware on an SD card, but for example by e-mail, you must copy the file "All 1122.fwb" to the root directory (not to a subdirectory) of the SD card. You may have received this file packed in a ZIP file. Unpack the file before you copy the file to the SD card.

Perform firmware update

- ▶ Copy the file "All 1122.fwb." to an SD card into the main directory (not into any subdirectory).
- ▶ Switch on the analyser.
- ▶ Wait until the zero-point measurement is finished.
- ▶ Insert the prepared SD card into the analyser
 - ⇒ A message appears.

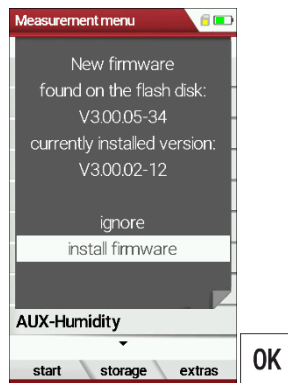

- ▶ Select install firmware.
- ▶ Press OK.
 - ⇒ The update is performed.
 - ⇒ After the update has been performed, a message appears.

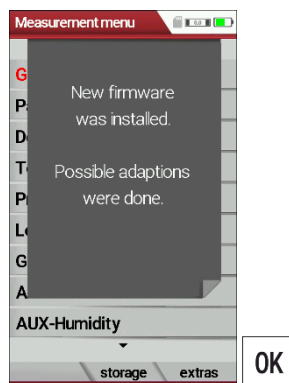

- ▶ Confirm the message with OK.
- ▶ Switch the analyser off again after the successful update.
 - ⇒ All functions are available the next time the analyser is switched on.

Check new firmware version

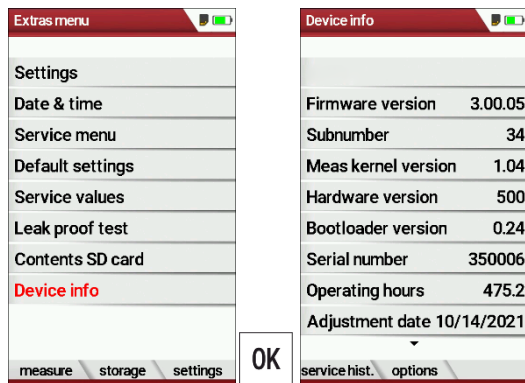

- ▶ Go to the Extras menu.
- ▶ Select Device info.
- ▶ Press OK.
 - ⇒ The menu Device info appears.
 - ⇒ The new Firmware version is displayed.
- ▶ Repeat the update process if the old firmware version is still displayed.

In case of error

What to do if there were problems during the update?

In the event of an error, the red LED of the condensate separator flashes.

The inserted SD card was then not recognized.

(Check whether the SD card is inserted correctly and perform a reset by pressing the ESC and ON keys simultaneously).

Where can I get help if the update was not successful?

Contact your local sales representative or via email:

Email: info@mru.de

14.5. Display your own logo

You have the option of importing your own start logo into the analyser and having it displayed when you switch the analyser on.

Create your own logo

► Create your own logo.

The following is an example of how to create a logo using MS Paint®. You can also create your logo with another graphics program.

► Open the graphics program.

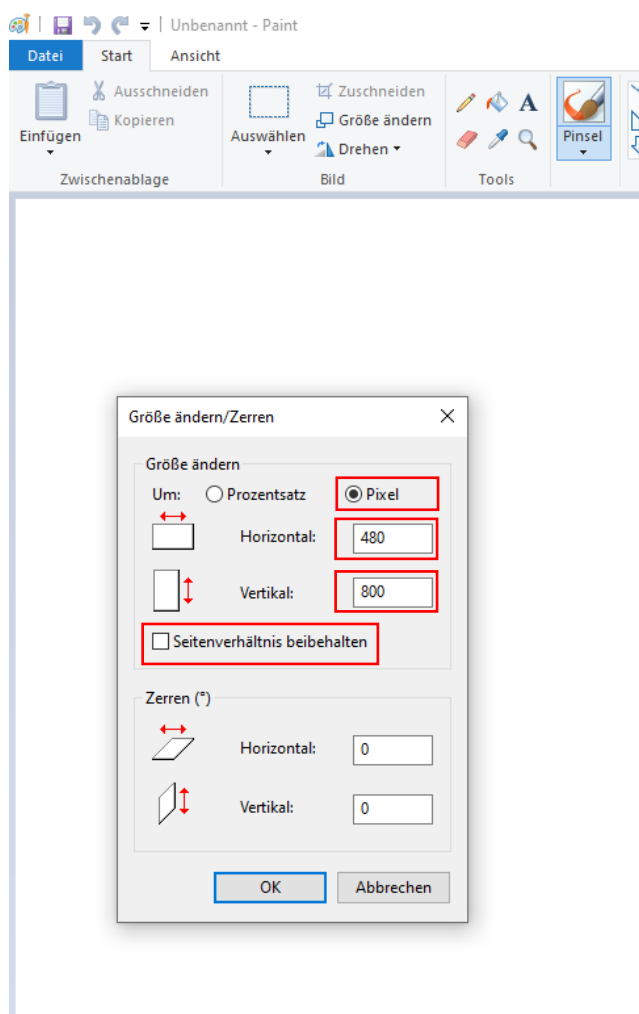

► Adjust the file size.

The file size must be 480 pixels (horizontal) x 800 pixels (vertical).

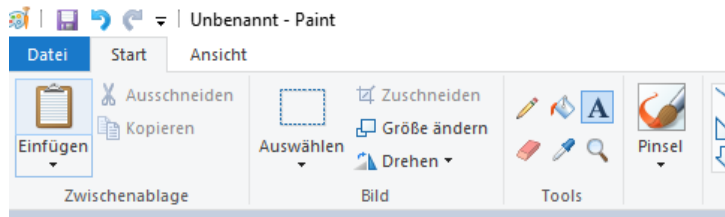

Erstellen Sie Ihr eigenes Logo Create your own Logo

► Save your logo to an SD card with the file name logo4u.jpg.

NOTE

Pay attention to the file format jpg when saving/exporting. If you use a graphics program other than MS Paint, you must disable the following items before exporting.



- Progressive
- Save preview/color profile
- Use arithmetic coding

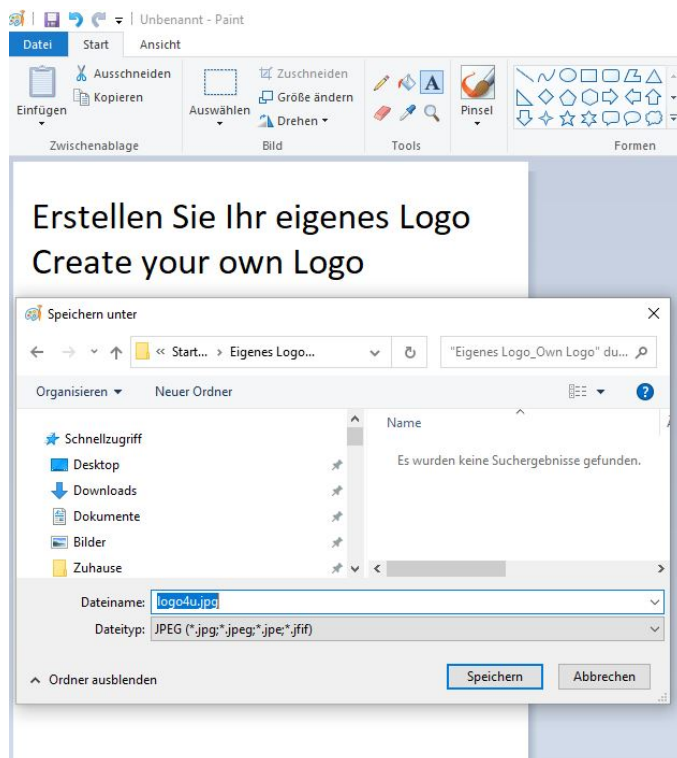

Import logo into analyser

- ▶ Go to the to the menu Settings.
 - ☞ 5.2 Customize settings, Page 24.
- ▶ Insert the SD card with the logo4u.jpg file into the analyser.
 - ⇒ A message appears.
 - ⇒ The logo is saved.
 - ⇒ The next time the analyser is switched on, the logo will be displayed.

Delete logo

You have the possibility to delete your logo.

Note that there are two possibilities to delete your own logo.

1. Possibility

- ▶ Switch on the analyser.
- ▶ Press the ESC key for ten seconds before the start logo appears.
 - ⇒ A beep sounds.
 - ⇒ The imported start logo has been deleted.

2. Possibility

- ▶ Create a file with the name clrlogo.jpg (clrlogo.jpg can be any file)
- ▶ Save the file to an Sd card.
- ▶ Go to the to the menu Settings.
 - ☞ 5.2 Customize settings, Page 24.
- ▶ Insert the SD card with the clrlogo.jpg file into the analyser.
 - ⇒ The imported start logo has been deleted.

15 Declaration of conformity

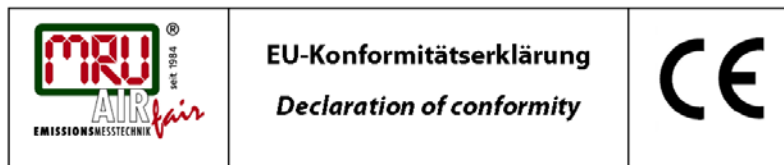

MRU Messgeräte für Rauchgase und Umweltschutz GmbH



Fuchshalde 8 + 12
 74172 Neckarsulm-Obereisesheim
 Deutschland / Germany
 Tel.: +49 (0) 7132 - 99 62 0
 Fax: +49 (0) 7132 - 99 62 20
 E-Mail / mail: info@mru.de
 Internet / site: www.mru.eu



Bevollmächtigte Person, für die Zusammenstellung der technischen Unterlagen
Person authorized to compile the technical documents.

Name / name:	Dierk Ahrends
Funktion / function:	QM-Beauftragter / QM-Representative
Firmenname / company:	Messgeräte für Rauchgase und Umweltschutz GmbH
Straße / street:	Fuchshalde 8 + 12
Ort / city:	74172 Neckarsulm
Land / country:	Deutschland / Germany

Produkt/Product

Bezeichnung / designation:	Gasanalysator Gas analyser
Produktname / name:	OPTIMA
Funktion / function:	Gasanalyse / gas analysis

Hiermit erklären wir, dass das oben beschriebene Produkt allen einschlägigen Bestimmungen entspricht, es erfüllt die Anforderungen der nachfolgend genannten Richtlinien und Normen:

We declare the conformity of the product with the applicable regulations listed below:

- EMV-Richtlinie / *EMV-directive* 2014/30/EU
- Niederspannungsrichtlinie / *low voltage directive* 2014/35/EU
- RoHS-Richtlinie / *RoHS directive* 2011/65/EU (RoHS II)

Neckarsulm, 11.04.2022



Erwin Hintz, Geschäftsführer / *Managing Director*

Distributed by:



DIAMOND
SCIENTIFIC

625 Peachtree Street
Cocoa, FL 32922
Phone: 1-321-223-7500

info@diamondsci.com
www.DiamondSci.com



**MRU · Messgeräte für Rauchgase
und Umweltschutz GmbH**

Fuchshalde 8 + 12

74172 Neckarsulm-Oberesheim

Fon 07132 99620 · Fax 07132 996220

info@mru.de · www.mru.eu