



AMPROplus USER MANUAL



Distributed By:



625 Peachtree Street
Cocoa, FL 32922
Phone: 1-321-223-7500

info@diamondsci.com
www.DiamondSci.com



Producer:



**MRU · Messgeräte für Rauchgase
und Umweltschutz GmbH**

Fuchshalde 8 + 12

74172 Neckarsulm-Oberseesheim

Distributor:



625 Peachtree Street
Cocoa, FL 32922
Phone: 1-321-223-7500

info@diamondsci.com
www.DiamondSci.com



Legal notices / Intellectual property rights comments

Original user manual

© 2021 by MRU

No part of this manual may be published in any form (print, photocopy, electronic media or any other publication form) without a written approval by the publisher.

All user trade marks and name mark descriptions, even those which are not marked as such, are properties of the respective owners.

Edition: 2021-07-19,V3.20.EN

Table of contents

1	Information for product and safety	6
1.1.	Safety manual	6
1.2.	Safety precautions.....	6
1.3.	Ensure safety.....	7
1.4.	User guideline for rechargeable batteries	7
2	Introduction	9
2.1.	Intended use.....	9
2.2.	About us	10
2.3.	Important general information (EN 50379 and VDI 4206)	11
2.4.	Packaging	11
2.5.	Return of hazardous materials.....	11
2.6.	Return of electronic equipment.....	12
3	Description	13
3.1.	Gas flow diagram	13
3.2.	Analyzer	13
3.3.	Condensate separator (water trap).....	15
3.4.	Extraction probes.....	19
4	Operating	20
4.1.	Display	20
4.2.	Keypad	21
4.3.	Menu structure	21
5	First usage	22
5.1.	Preparatory steps.....	23
5.2.	Customize settings.....	23
5.3.	Export and import settings	24
	Export user settings.....	25
	Import user settings	26
5.4.	Set measurement.....	26
5.5.	Set Bluetooth parameters	28
5.6.	Setting date and time	29
5.7.	Configure measurement program.....	29
5.8.	Set CO-Limit.....	30
5.9.	Change measurement program name.....	30
5.10.	Select fuel types and O ₂ reference	30
	Add fuels to fuel type selection	31
	Set O ₂ -reference.....	32
5.11.	Benutzerbrennstoffe definieren.....	32
5.12.	Define measurement window.....	34
5.13.	Configure zoom window	35
6	Prepare measurement.....	36
6.1.	Perform overall visual inspection	36
6.2.	Ensure power supply.....	36
6.3.	Automatic Auto-off function.....	36

6.4.	Measuring with grid power supply / Battery charging.....	36
6.5.	Measurements in battery mode (battery monitoring)	36
6.6.	Operating temperature	37
6.7.	Control Condensate separator	37
6.8.	Connections and tightness	37
6.9.	Automatic zero point	38
	Repeat zeroing	39
7	Performing measurement	40
7.1.	Perform Gas measurement	40
	Core flow search	40
	Select Measurement program.....	41
	Perform Annular-gap test	43
	Perform Test program	44
	CO purging	44
7.2.	Temporary buffer.....	44
	Store values into temporary buffer	45
	Overwrite measured values in temporary buffer	47
7.3.	Perform pressure measurement	48
7.4.	Perform Differential temperature measurement	49
7.5.	Store measurement values.....	50
	Enter T-boiler, Soot and Derivative	51
7.6.	Print measurement values.....	52
	Open menu print-out	52
	Print measurement results with Speedprinter.....	53
	Print measurement results with Highspeed-Bluetooth-Thermoprinter	55
7.7.	Stop measurement.....	56
7.8.	Last measured values	56
8	Data storage	57
8.1.	Organize data storage.....	57
8.2.	Call up information about Memory info	57
8.3.	Sites administration	58
	Create new site.....	58
	View sites	58
	Change sites	59
	Delete sites	59
8.4.	Transfer data via using SD card	61
	Import sites.....	62
	Export sites.....	63
	Export measurements	64
8.5.	Measurements in Data storage.....	65

View measurements.....	65
Delete measurements	66
8.6. Messergebnisse als OR-Code	68
Livemessung als QR-Code	68
Gespeicherte Messung als QR-Code.....	69
9 Extras / Adjustment.....	70
9.1. Service menu.....	70
9.2. Default settings	71
9.3. Service values.....	72
9.4. Performing leak test.....	73
9.5. Contents SD card	74
9.6. Device info.....	75
Options list.....	75
Service history	75
12 Option: Solid fuel measurement.....	76
Perform Solid fuel measurement	76
Filter unit for Solid fuel measurement (# 11153)	77
13 Option: Humidity measurement with hygrometer	80
14 Option: Leak detection (external HC probe).....	81
15 Option: Flow measurement with vane / anemometer	83
15.1. Open menu Aux-Anemometer.....	83
15.2. Set units and cross section area	84
15.3. Perform measurement.....	85
16 Option: Monitoring flow rate	86
18 Option: Auto-measurement	87
20 Appendix	89
20.1. Technical data	89
20.2. Analyse und Berechnung	92
20.3. Brennstofflisten	93
20.4. Messgerät resettet.....	93
20.5. Fehlerbehandlung.....	94
Fehlerdiagnosen am Messgerät	94
Fehlerdiagnosen Kondensatabscheider	95
20.6. Update firmware	96
Check current firmware version	96
Prepare SD card	96
Perform firmware update	96
Check new firmware version	97
21 Konformitätserklärung.....	99

1 Information for product and safety

1.1. Safety manual

All general information and safety precautions of MRU products are listed in the supplied separate safety manual.

Therefore, this manual must be read and observed before the first use of the instrument.

Instrument-specific safety and warning requirements in this manual are prefixed before dangerous actions.

1.2. Safety precautions

The used categories of safety precautions are here explained once more.



DANGER

Identifies an immediate, impending hazard that, if ignored, will result in severe bodily injuries or death.



WARNING

Identifies an immediate, impending hazard that, if ignored, may result in severe bodily injuries, material damage or death.



CAUTION

Identifies a possibly dangerous situation that, if ignored, may result in minor injuries.



ATTENTION

Identifies a possibly harmful situation that, if ignored, may result in damages to the device or its surroundings.



NOTE

Identifies user tips and other especially important information.

The explanation of safety notices:



CAUTION

HOT – danger of burns and fire hazards from gas extraction probe.

Physical harm and property damage can be caused.

► Cool down the probe tube.

1.3. Ensure safety

- ▶ Please read the user manual completely before the first use.
- ▶ Only use the analyser for the intended use and within the parameters specified in the technical data.
- ▶ Do not use any violence.
- ▶ Avoid falls
- ▶ Do not put the analyser into use, if the housing, power supply unit or supply leads are damaged.
- ▶ Do not store the analyser together with solvents. Do not use desiccants.
- ▶ Only carry out maintenance and service work on this analyser as described in the User Manual. Observe the prescribed action steps.
- ▶ Operate the analyser only in closed, dry rooms and protect it from rain and moisture.
- ▶ When operating the analyser on mains power, operate it only with the mains adapter supplied.
- ▶ Do not use the metal tube of the gas sampling probe or other metallic parts / accessories as electrical conductors.
- ▶ The analyser must not be located in the immediate vicinity of open fire or great heat.
- ▶ The specified temperature range of the gas sampling probe must not be exceeded, otherwise the probe tube and temperature sensor will be destroyed.

1.4. User guideline for rechargeable batteries



NOTE

The rechargeable batterie is installed inside the analyser and is not accessible to the end customer. However, the following instructions must generally be observed when handling lithium-ion rechargeable batteries.

- ▶ The rechargeable battery can only be used in this analyser.
- ▶ Do not throw the rechargeable battery into a fire, charge it at high temperatures and store it in a hot environment.
- ▶ Do not deform, short-circuit or modify the rechargeable battery.

- ▶ The rechargeable battery must not be used in or under water.
- ▶ Do not expose the rechargeable battery to strong mechanical forces and do not throw it.
- ▶ Do not cut or squeeze the connecting cables of the rechargeable battery.
- ▶ Do not carry or store the battery together with sharp-edged objects.
- ▶ Do not connect the (+) contact to the (-) contact or metal.
- ▶ Non-observance of the above guidelines can cause heat, fire and explosions

2 Introduction

- This manual enables you to understand and safely operate this MRU Analyser.
- Please read this manual with great vigilance and get familiar with the product before using it.
- This Analyzer may only be operated by competent personnel and for its intended use.
- Please pay special attention to all safety directions and warnings to prevent personal injuries and damaging of the product.
- We can't be held responsible for any injuries and/or damages that occur by not following the instructions in this manual.
- Always keep the manual near you when working with the analyser, to be able to read instructions as needed
- Please ensure to hand over all documents to when handing the analyser over to others.

2.1. Intended use

The Analyzer is intended for short-term measurement in the context of emission control measurements and adjustments at small furnaces. The analyzer measures the measurements provided by VDI4206 and EN50379 metrics and stores them for further processing.

The analyzer is specifically not intended as a safety device or personal protective equipment.

The analyzer should not be used as a warning device to warn people against the presence of harmful gases.

The analyzer must be used according to instructions for the intended use.

Our analysers are checked according to the following regulations:

VDE 0411 (EN61010) and **DIN VDE 0701** before they leave the MRU GmbH factory.

MRU technical products are designed and manufactured according to **DIN 31000/ VDE 1000** and **UVV = VBG 4** of the professional guilds for fine mechanics and electrical engineering.

MRU GmbH assures that the analyzer complies to the essential requirements of the legal regulations of the member states of the electro-magnetic compatibility (**2014/30/EU**) and to the low-voltage regulations (**2014/35/EU**).

**⚠ WARNING****Risk from manipulations to the measuring device**

Operational safety hazard

- ▶ Modifications or changes to the measuring device are not allowed.

2.2. About us

The analyzer is produced by the MRU GmbH in Neckarsulm, Germany (Founded in 1984), a medium sized company that specializes in developing, producing and marketing high quality emission monitoring analyzers.

MRU GmbH produces a wide range of instruments, from standard analyzers up to tailor made industrial analyzers.



Plant 1: Sales, Service, R&D



Werk 2: Production

2.3. Important general information (EN 50379 and VDI 4206)

- The analyzer is not designed to be used for continuous measurements
- Before using the analyser verify the condition of the various parts of the analyser, such as the probe, the ambient air conditions, the condensate separator, star filter and the connectors for damage and/or blockages.
- When starting the analyser up it will take between 1 – 3 minutes to set to zero depending on the condition of the sensors and ambient conditions. (Zeroing).
- The minimum zeroing time of the analyser to achieve correct measurement values can be expected by 1.5 minutes!
- Exposure to acids; aggressive gases such as Sulphur; vapours such as thinners, gasoline, alcohol and paint, etc. can damage, reduce the life of, or destroy the sensors
- Die Lebenserwartung der Sensoren beträgt, abhängig von Nutzung, Wartung und Pflege des Messgerätes bei dem O₂ Sensor ca. 2 Jahre und bei dem CO Sensor ca. 2-3 Jahre.
- The life of the sensors depends on how they are used, maintained and treated. Typical average life expectations are: O₂ - 2 years; CO - 2 - 3 years and NO - 3 years.
- Die Lebensdauer des Akkus beträgt mindestens 500 Lade- Entladezyklen. Mit zunehmender Zyklenzahl reduziert sich die in den technischen Daten angegebene Gerätebetriebsdauer pro Akkuladung.
- The use of the analyzer for regulatory purposes is subject to special regulations (for example a periodical examination of the analyzer). Please obtain the appropriate regulations from your local responsible authority.

2.4. Packaging

Save the original carton and packing materials to prevent damage in transit in case you need to return the unit to the factory.

2.5. Return of hazardous materials

Waste Disposal/Returns/Warranty - MRU is required to accept the return of hazardous waste such as electro-chemical sensors that cannot be disposed of locally.

Hazardous waste must be returned to MRU prepaid.

2.6. Return of electronic equipment

MRU is required to accept the return, for proper disposal, of all analyzers delivered after 13th of August 2005. Analyzers must be returned to MRU pre-paid.

3 Description

The main task of the analyser is to assist with precision control and adjustment measurements of gas, oil and wood fired furnaces.

Available options for this and other analysers can be found on the MRU Homepage or speak to a member of our sales team.

3.1. Gas flow diagram

In combination with the extraction probe (inserted in the stack) the internal gas pump of the analyser extracts a portion of the flue gas and analyses it using electro-chemical sensors.

The thermo-element in the probe tube measures the flue gas temperature and due to the construction of the probe pressure (draft) can be measured as well.

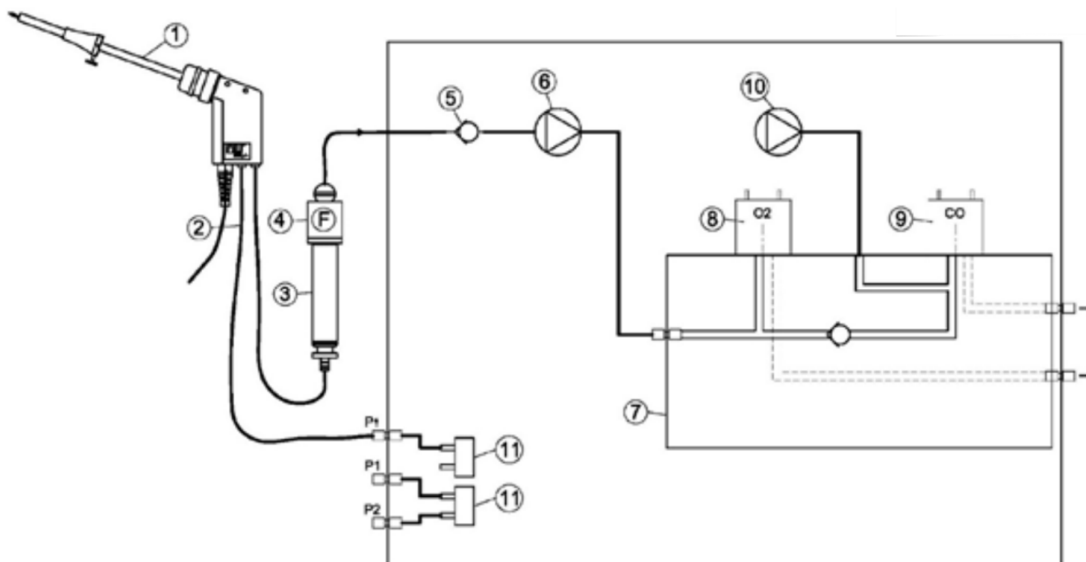

Position	Description
1	Sampling probe
2	Triple hose
3	Condensate separator
4	Star filter
5	Non return valve
6	Gas pump
7	Sensor chamber
8	O ₂ -Sensor
9	CO-Sensor
10	Purge pump
11	Pressure sensor

3.2. Analyzer

The analyzer consists of a compact and robust glass-fiber reinforced plastic housing. All connections relevant for the measurement are located on the bottom of the analyzer.

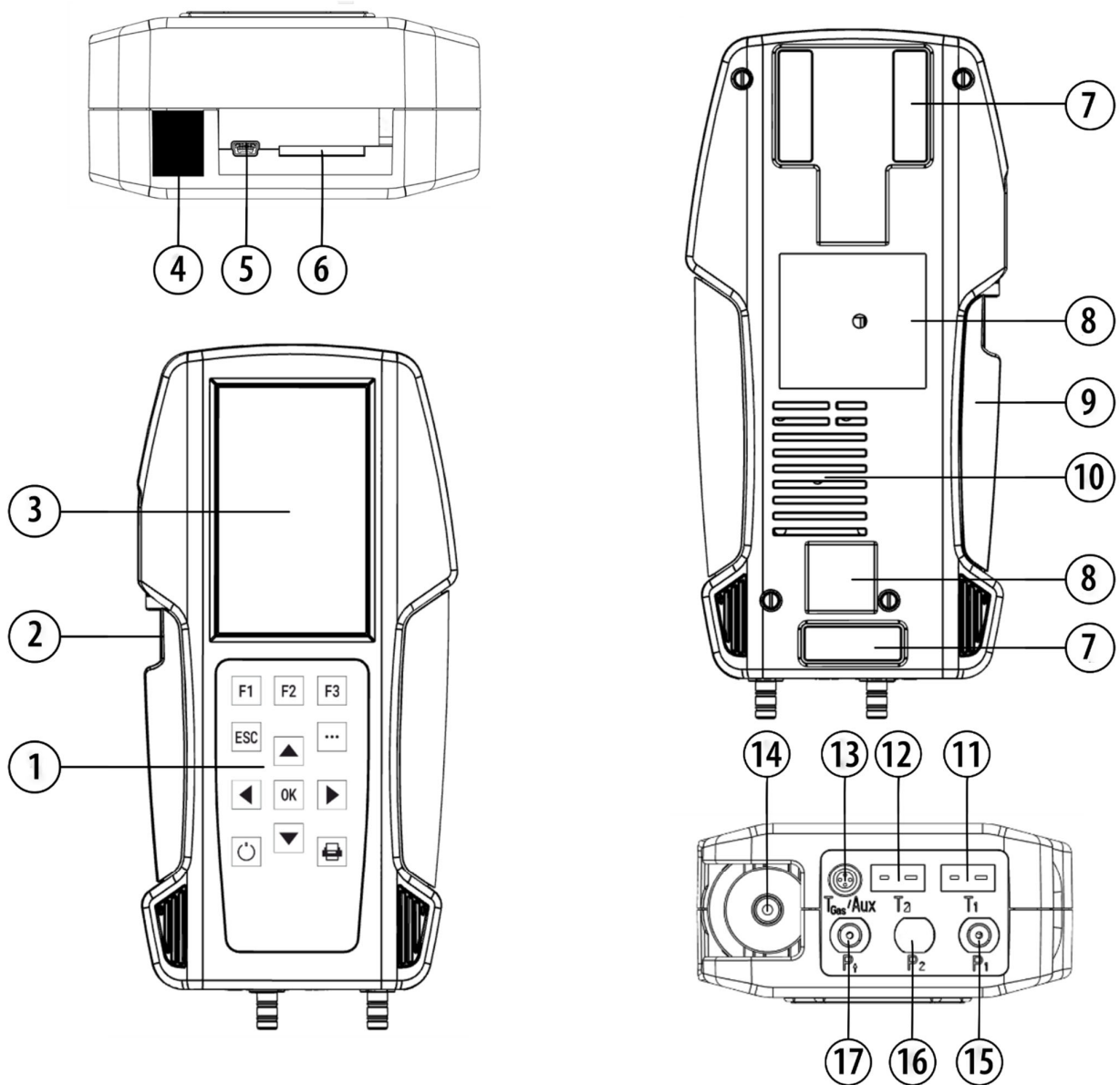

Position	Description	Position	Description
1	Keypad	10	Gas outlet
2	Condensate separator	11	Temperature connection T1 / T-Ambient air
3	Display	12	Temperature connection T2 / T-gas
4	IR-Interface	13	Connector AUX
5	USB-Port / Charging port	14	Sampling probe connection Condensate separator
6	SD-card reader (Only by using an MRU-SD card we can assure the compatibility of all analyzer functions)	15	Pressure connection 1 (Differential Pressure)
7	Analyzer feet	16	Pressure connection 2 (optional)
8	Fixing magnets	17	Pressure connection Draft
9	Handle strip		



ATTENTION

Gas outlet:

During measurement the gas outlet must not be covered

3.3. Condensate separator (water trap)



• CAUTION

Condensate is acidic

The condensate from the container can be slight acidic and can cause chemical burn.

- ▶ Immediately clean with plenty of water once you have encountered acid

Condensate accumulating during the measurement is collected in the condensate separator.

Note that there are two variants of the condensate separator.

- Without water stop filter
- With water stop filter

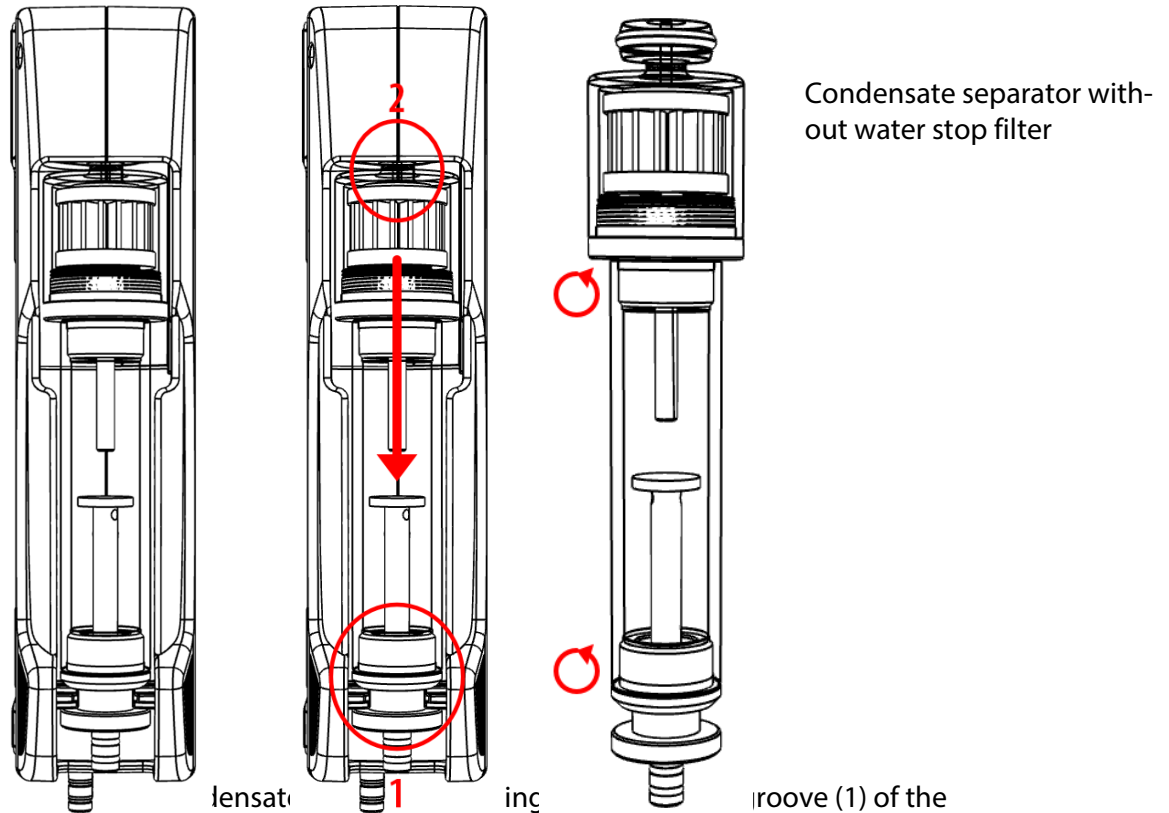

Then pull out the condensate separator downwards (2).
Liquid discharged from the condensate separator may be slightly acidic.

Condensate vessel and plug are screwed into each other. To change the pocket star filter and dry and clean the condensate separator, it can be easily disassembled and screwed back together.

After cleaning, a leak test must be performed.

☞ See also chapter 9.4 Performing leak test, Page 73.

An exhaust gas filter is installed in the condensate separator of the analyzer. This filters out the first coarse dirt.

This pocket star filter is washable and can be used approx. 4-5 times. Frequent measurement results in a high degree of contamination, which requires regular replacement of the pocket star filter.

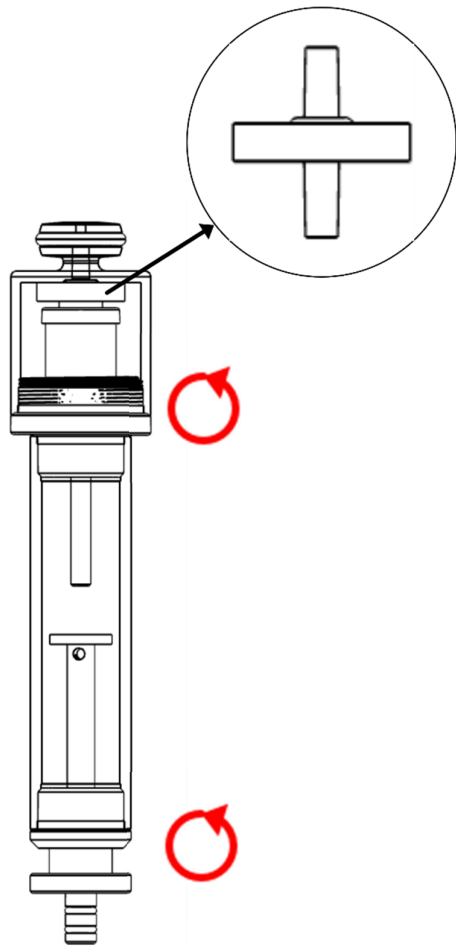

Condensate separator with-
out water stop filter

The water stop filter protects the analyzer from moisture.

The water stop filter closes as soon as there is a risk that condensate is sucked into the analyzer.

A closed water stop filter can be indicated, for example, by the fact that the flow rate is too low.

☞ See also chapter 14 Option: Monitoring flow rate, Page 86. If the flow monitoring option is installed in your analyzer, the corresponding message could indicate a closed water stop filter.

- ▶ Check in the water stop filter
- ▶ Replace the water stop filter if necessary.
- ▶ Remove the condensate separator with water stop from the analyzer as described above.
- ▶ Unscrew the condensate separator.
- ▶ Replace the water stop filter.

Observe the direction when installing the water stop filter

The side with the sealing ring must point upwards.

Due to the arrangement of the membrane in the filter, the water stop filter will quickly become defective if inserted in the wrong direction due to excessive pressure.

The water stop filter should be replaced annually.

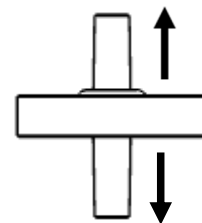

3.4. Extraction probes

In combination with the analyzer, gas sampling probes are offered in different versions with fixed probe tube or with exchangeable probe tube. For a complete overview of accessories, see the company's current price list.

Here two variants are shown as examples:

Probe ST

With 180 mm probe pipe (fixed) and 1,5 m sampling line

Probe SF

With 300 mm exchangeable probe pipe and 2,7 m sampling line

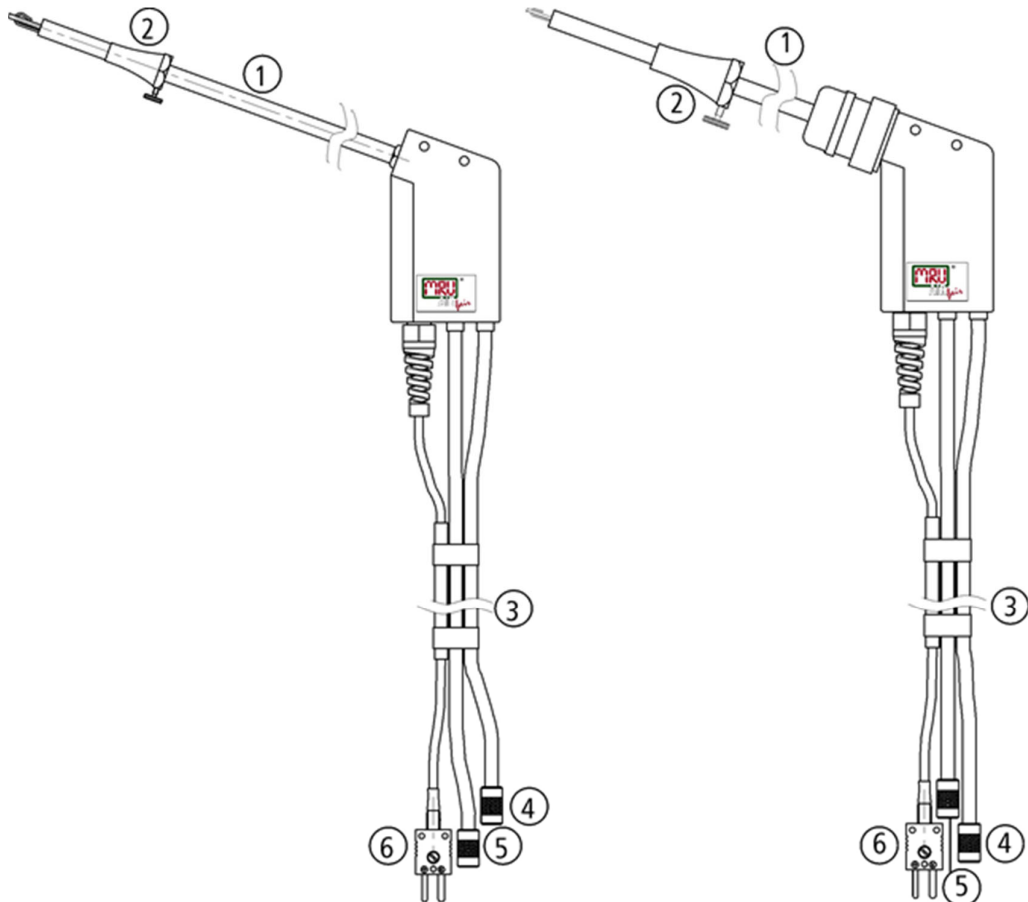

2	Probe cone (high grade steel)	5	Connector for draft measurement
3	Triple hose(NBR or Viton)	6	Connector for temperature measurement

4 Operating

4.1. Display



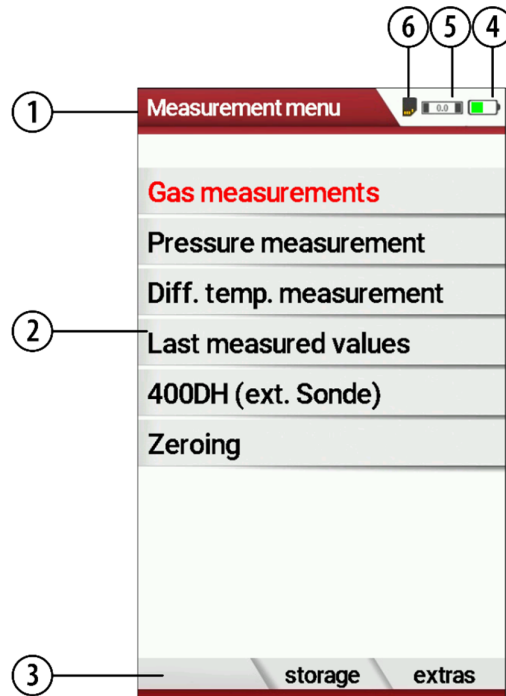



All the information needed for the operation of the analyzer can be obtained from the analyzer's display, which contains the following information.

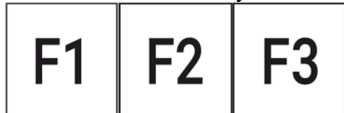

Position	Description
1	Menu bar
2	Display panel - Menu - Measurement values
3	Function key bar
4	Battery charge condition
5	SD-Card in the slot Display yellow → write-protected → read-only access
6	Zeroing active

4.2. Keypad

Description of the keys and their functions:

Key	Function
<p>ON/OFF</p> 	<p>A short press switches the analyzer on without delay. Switching off the device is delayed to protect the sensor when no ambient air is present. Then purging is recommended before switching off.</p>
<p>Function keys</p> 	<p>Activates the function that is shown in the function key bar on the display.</p>
<p>Menu Key</p> 	<p>Will show all available functions in the window that is currently in use – also those which have an individual key on the key pad like the printer and the three function keys.</p>
<p>ESC</p> 	<p>Abort or return to the menu above</p>
<p>Arrow keys</p> 	<p>Move cursor, change values</p>
<p>OK</p> 	<p>Confirmation key, selection of the marked menu item</p>
<p>Printer</p> 	<p>Activates the printer function in the measurement and service window. .</p>

4.3. Menu structure

The analyzer organizes all available actions into three main menus:

- **Menu Measurement**

Here you will find all actions for the measuring tasks of the

analyzer. In particular, all installed measuring tasks are listed here and can be selected.

- **Menu Storage**
All available storage options will be displayed and can be selected here.
- **Menu Extra**
All other actions are available here to manage and customize the analyzer.

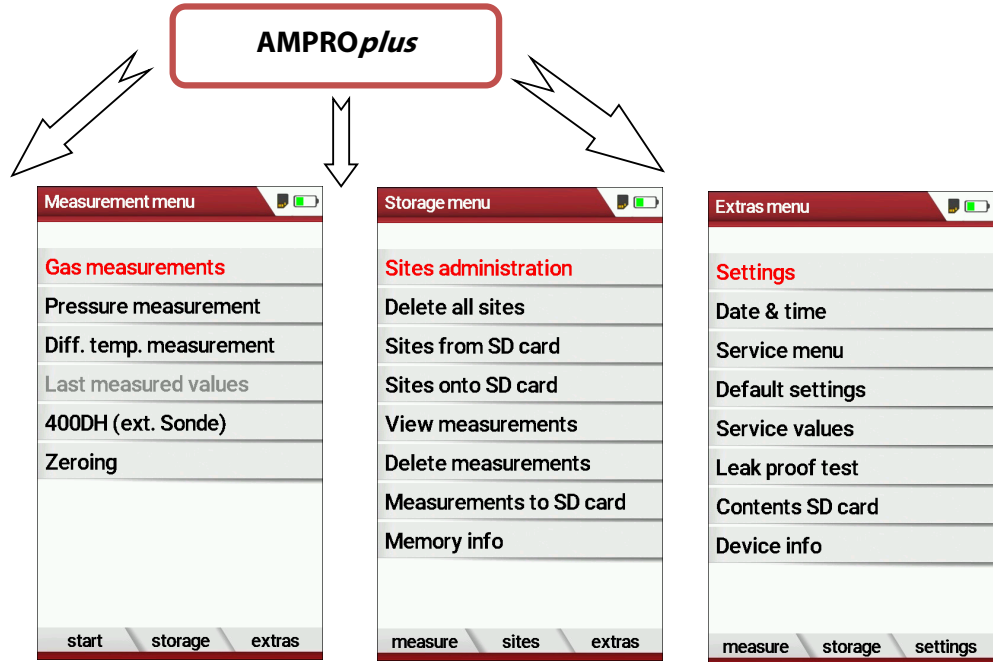

The topic „Gas measurements“ is a standard feature in every analyzer and is explained in chapter 7 Performing measurement , Page 40. Other menu points are optional and will be explained in this manual or in an additional manual or flyer

The menu Storage is explained in chapter 8 Data storage, Page 57.

The menu Extras is explained in chapter 9 Extras / Adjustment, Page 70.

You can jump in between the 3 main menus with the 3 function keys (according to the displayed name on the screen).

5 First usage

After ensuring that the analyzer is ready for operation, you can make some customer-specific adjustments during the initial startup. All settings can be changed at any time later.

5.1. Preparatory steps

- ▶ Unpack the analyser.
- ▶ Read the User Manual completely.
- ▶ The analyser leaves the factory assembled and ready for use. Nevertheless, check the device for completeness and integrity.
- ▶ Charge the battery of the analyser for about 8 hours.
- ▶ Check date and time. Modify if needed.

5.2. Customize settings

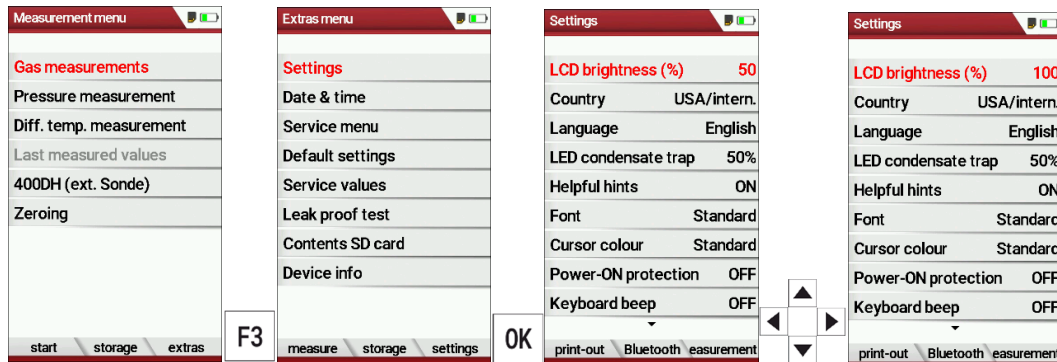

Press F3.

- ⇒ The Extras menu appears.
- ▶ Select Settings.
- ▶ Press OK.
 - ⇒ The menu Settings appears.
- ▶ Select the desired setting.
- ▶ Change the desired setting.
- ▶ Press ESC.
 - ⇒ The change is saved.
 - ⇒ The Extras menu appears.

In the "Settings" menu you can make the following customizations:

Setting	Range	Description
LCD brightness	5 – 100 %	Setting the display contrast
Country	Option	By switching the country, the set O2 reference values are lost. The fuel list is reset. Country-specific default settings and measuring procedures are also set.
Language	Option	Selection of the analyzer language
LED condensate trap	OFF, 50%, 100%	Change the brightness of the condensate trap LED
Helpful hints	ON / OFF	Some helpful hints which are very useful for an inexperienced user but are not needed by experienced users, can be activated or deactivated. The following hints will be affected: "Zeroing finished, Sensors are ready. Analyzer ready for measurement." "Reminder! Charge batteries at regular intervals!" "Measurement stopped/started."
Font		Change font. You can choose between Standard and Extra.
Cursor colour		Change cursor colour. You can choose between Standard, Eye-Catching and Colour filled.
Power-ON protection	ON / OFF	If you have activated the power-on protection and press the ON key, the display will show a 20-second countdown. Press F2 to turn the analyzer on.
Keyboard beep	ON / OFF	Set signal tone when key is pressed
400 DH (ext. Sonde)	ON / OFF	Activation of the external probe 400 DH

5.3. Export and import settings

You have the possibility to export saved settings to an SD card and import these settings to another analyzer.

Export user settings

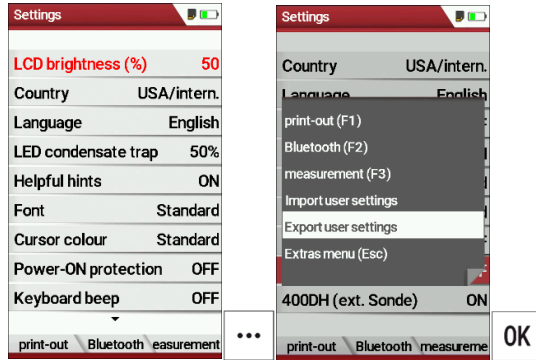

- ▶ Make sure that there is an SD card in the analyzer.
- ▶ Go to the menu Settings.
 - ⇒ See also chapter 5.2 Customize settings, Page 23.
- ▶ Press the menu key.
 - ⇒ A selection list appears.
- ▶ Select Export user settings.
- ▶ Press OK.
 - ⇒ The settings are exported to the SD card.
 - ⇒ The settings are saved on the SD card as SETTINGS.USR

Import user settings

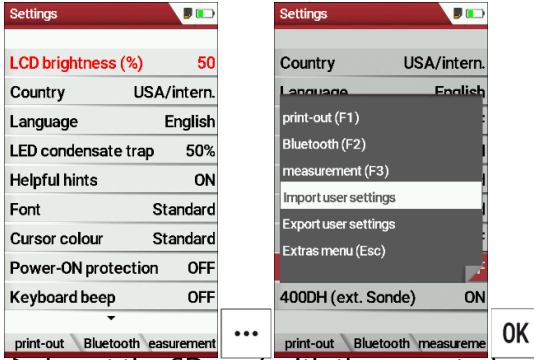

- ▶ Insert the SD card with the exported settings into the desired analyzer.
- ▶ Go to the menu Settings.
 - ☞ See also chapter 5.2 Customize settings, Page 23.
- ▶ Press the menu key.
 - ⇒ A selection list appears.
- ▶ Select Import user settings.
- ▶ Press OK.
 - ⇒ The settings are imported.

5.4. Set measurement

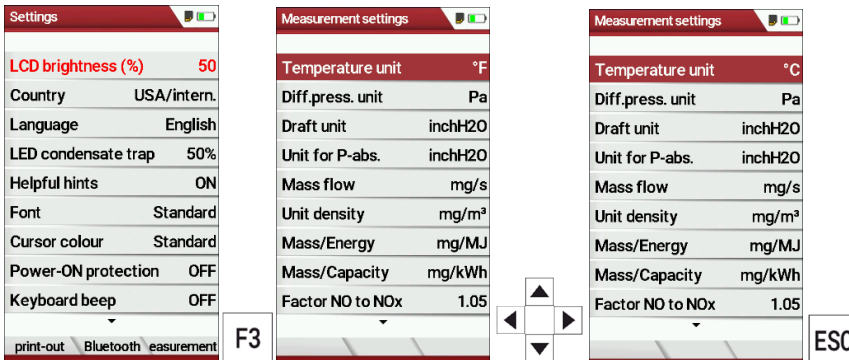

- ▶ Go to the menu Settings.
 - ☞ See also chapter 5.2 Customize settings, Page 23.
- ▶ Press F3.
 - ⇒ The menu Measurement settings appears.
- ▶ Select the desired setting.
- ▶ Change the desired setting.
- ▶ Press ESC.
 - ⇒ The change is saved.
 - ⇒ The menu Settings appears.

In the menu "Measurement settings" menu you can make the following customizations:

Setting	Range	Description
Temperature unit	°C, °F	Select temperature unit
Diff. press. unit	hPa/Pa, hPa, kPa/Pa, kPa, mbar, mmH2O, cmH2O, inchH2O, mmHG, inHg, PSI, bar, MPa, Pa	Select pressure unit
Draft unit	hPa/Pa, hPa, kPa/Pa, kPa, mbar, mmH2O, cmH2O, inchH2O, mmHG, inHG, PSI, bar, MPa, Pa,	Select draft unit
Unit for P-abs.	hPa, kPa/Pa, kPa, mbar, mH2O, cmH2O, inchH2O, mmHG, inHG, PSI, bar,MPa, Pa	Select unit for P-abs.
Mass flow	mg/s,lb/yr,Tpy,	Select unit for Mass flow
Unit density	mg/m ³ , grain/ft ³	Select Unit density
Mass/Energy	mg/MJ, lb/MMBtu	Select unit for Mass/ Energy
Mass/Capacity	mg/kWh, g/bhp-hr	Select unit for Mass/Capacity
Factor NO zu NOx	1.00 – 2.00	Enter factor for conversion from NO to NOx.
O2 resolution	0.1%, 0.01%	Enter value for O2 resolution
Core flow search	ON / OFF	Core flow search before start of each gas measurement: activated or deactivated
Add soot&T-boiler	ON / OFF	Add soot and T-boiler after each gas measurement: activated or deactivated
Annular -gap test	ON / OFF	Annular gap test: activated or deactivated
Combustion calculation	ON / OFF	If the combustion calculation is switched off following items will be changed: - no fuel types, respectively always "Sample Gas" - no measuring values losses, ETA, ETAcond, Dev. point - no measuring value CO2, except it will be measured - no measuring values CO/NO,,,, in [mg/kWh]/[mg/MJ] - no fuel type will be shown on the menu bar and print-out

5.5. Set Bluetooth parameters

Depending on the features, the analyzer can be used to exchange measurement data wirelessly with external devices:

- With MRU4U (App for Android and iOS Smartphones)
- With MRU4Win
- With MRU Bluetooth-Printer

Depending on the software version of the analyzer and the technical realization of the Bluetooth interface, settings for data transfer may be required.

► Please check in the following menu:

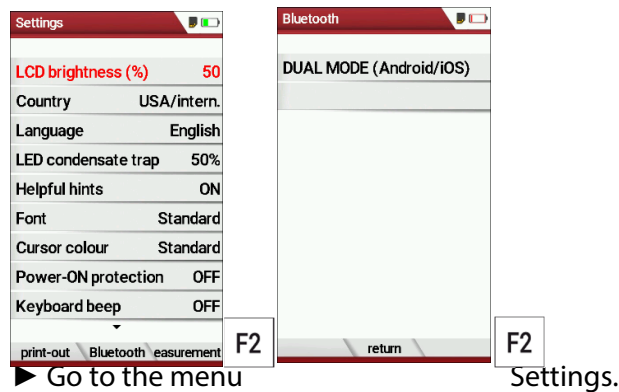

► Go to the menu Settings.

☞ See also chapter 5.2 Customize settings, Page 23.

► Press F2.

⇒ The menu Bluetooth appears.

If "DUAL MODE (ANDROID/IOS)" appears in the settings window, the Bluetooth module supports all applications without any further settings.

If "DUAL MODE (ANDROID/IOS)" appears in the settings window instead of "ANDROID/IOS", a settings window appears in which you can select between the ANDROID/IOS modes, select whether you want to connect the analyzer to an Android or iOS smartphone.

A connection to the Bluetooth printer or to MRU4Win is realized with the "ANDROID" setting.

5.6. Setting date and time

If the built-in rechargeable battery is completely discharged, a new setting of these values is required

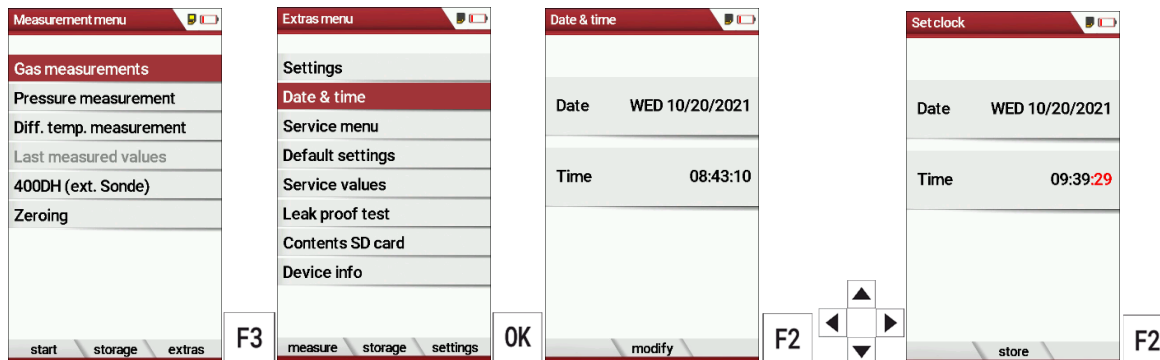

- ▶ Press F3.
 - ⇒ The Extra menu appears.
- ▶ Select Date / Time.
- ▶ Press OK.
 - ⇒ The menu Date/Time appears.
- ▶ Press F2.
 - ⇒ Das Menü Uhr stellen erscheint.
 - ⇒ The menu Set clock appears.
- ▶ Set the desired Date
- ▶ Set the desired Time.
- ▶ Press F2.
 - ⇒ The change is saved.

5.7. Configure measurement program

Select one of the 4 configurable measurement programs.

For each of the programs the following parameters can be configured:

- CO ppm limit: adjustable value for the CO sensor protection. If the CO value in the flue gas is higher than the adjusted value in the analyzer, the purge pump will be activated and the sensor will be protected against high CO concentrations. (Option)
- Selectable fuel types: choose and select from the available fuel type list
- Measurement windows: configuration of what and where will be displayed in the 3 measurement value windows.
- Zoom – window: select what will be displayed in the zoom - window
- Program name

The following programs pre-configured:

- “Test Program” indented for use at instrument maintenance and calibration

5.8. Set CO-Limit

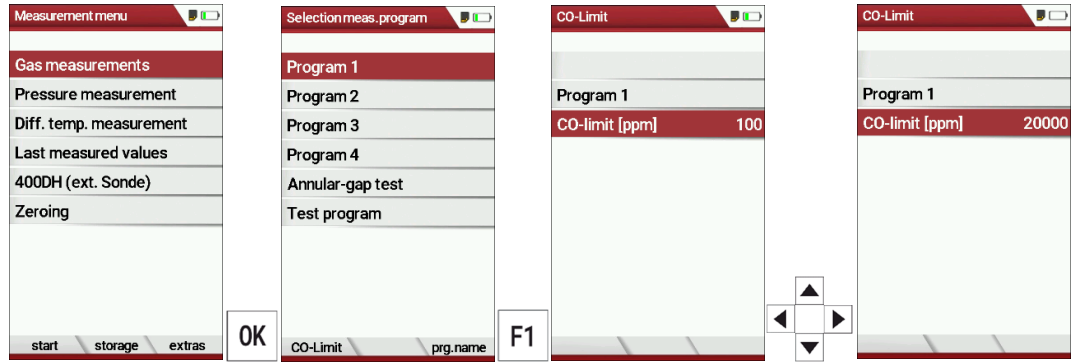

- ▶ Select Gas measurements.
- ▶ Press OK.
 - ⇒ The menu Selection meas. program appears.
- ▶ Select the desired measuring program from which the CO limit value is to be set
- ▶ Press F1.
 - ⇒ The menu Co-Limit appears.
- ▶ Set the desired CO-limit [ppm].
- ▶ Press OK.
 - ⇒ The desired CO-limit [ppm] is stored.

5.9. Change measurement program name

You have the possibility to change the name of the measurement program.



- ▶ Select Gas measurements
- ▶ Press OK.
 - ⇒ The menu Selection meas. program appears.
- ▶ Press F3.
- ▶ Change the name of the measurement program to your needs.
- ▶ Press OK.
 - ⇒ The changed name is displayed in the menu Selection meas. program.

5.10. Select fuel types and O₂ reference

NOTE



Note that you can only select the Fuel type selection if the combustion calculation has been switched on.

Each time a measuring program for

☞ See also chapter 5.4 Set measurement, Page 26

flue gas measurement is called up, a fuel can be selected from a list. Which fuel is available for selection can be selected from a fuel type list.

Add fuels to fuel type selection

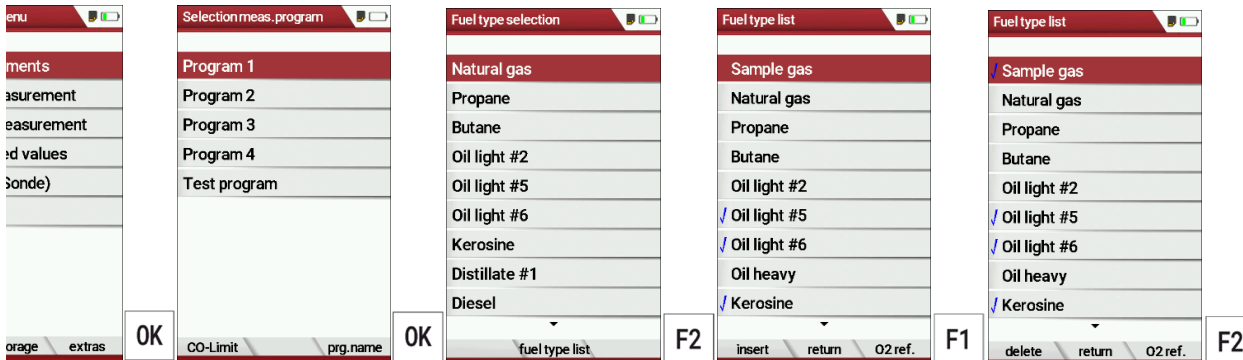

- ▶ Select Gas measurements.
- ▶ Press OK.
 - ⇒ The menu Selection meas. Program appears.
- ▶ Select the desired measurement program.
- ▶ Press OK.
 - ⇒ The menu fuel type selection appears.
- ▶ Press F2.
 - ⇒ The menu Fuel type list appears.
- ▶ Wählen Sie den Brennstoff aus, der dem Menü Brennstoffauswahl hinzugefügt werden soll.
- ▶ Select the fuel which should be added to the menu Fuel type selection.
- ▶ Press F1.
 - ⇒ The selected fuel is marked with a check mark.
- ▶ Select other fuels if necessary.
- ▶ Press OK.
 - ⇒ The selected fuels are displayed in the menu Fuel type selection.

Set O2-reference

- ▶ Gehen Sie in das Menü Brennstoffliste.

☞ Siehe auch Kapitel **Error! Reference source not found.**, S. **Error! Bookmark not defined.**

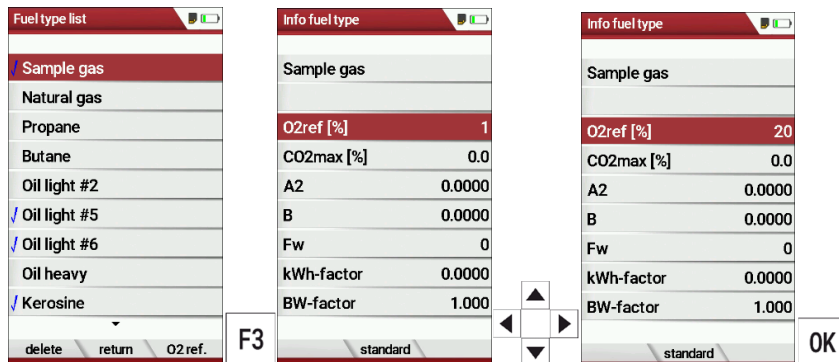

- ▶ Go the menu Fuel type list.

☞ See also chapter Add fuels to fuel type selection, Page 31.

- ▶ Select the desired fuel.
- ▶ Press F3.
 - ⇒ The menu Info fuel type appears.
- ▶ Stellen Sie den gewünschten O2-Bezug ein.
- ▶ Set the desired O2-reference
- ▶ Press OK.
 - ⇒ The set O2 reference is saved.

5.11. Benutzerbrennstoffe definieren

NOTE



Note that you can only select the Fuel type selection if the combustion calculation has been switched on.

☞ See also chapter 5.4 Set measurement, Page 26

You can define four fuels to your individual needs.
 You can define the name and the fuel parameters.
 Like the other fuels, you can add user fuels to the menu Fuel type selection.

NOTE



The last 4 fuels in the menu Fuel type list are the user fuels. The user fuels are indicated in the menu Fuel Type list in green colour.

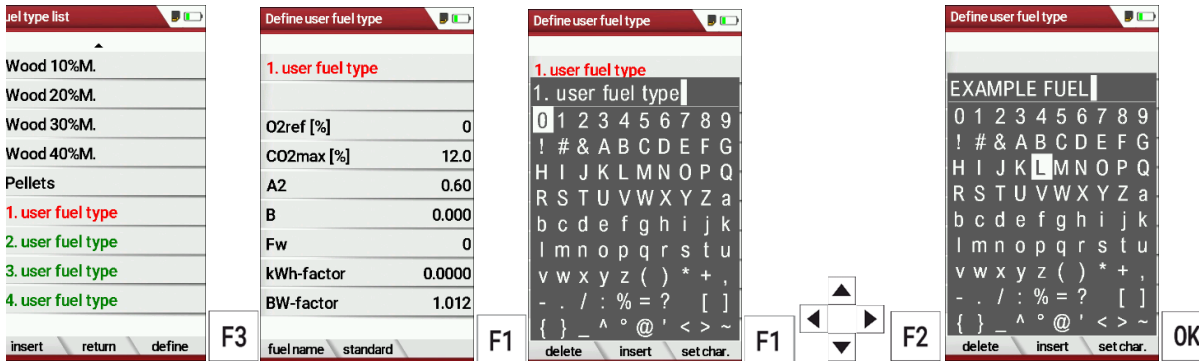

- ▶ Go to the menu Fuel type list.
 - ☞ See also chapter Add fuels to fuel type selection, Page 31.
- ▶ Select the user fuel type you want to define.
- ▶ Press F3.
 - ⇒ The menu Define user fuel type appears.
- ▶ Press F1.
 - ⇒ A window appears.
- ▶ Passen Sie den Namen des Benutzerbrennstoffes an ihre Bedürfnisse an.
- ▶ Change the name of the user fuel type to your needs.
- ▶ Press OK.
 - ⇒ The changed name is displayed in the menu Define user fuel type.
 - ⇒ After you have changed the name of the user fuel, you can define the fuel parameters.

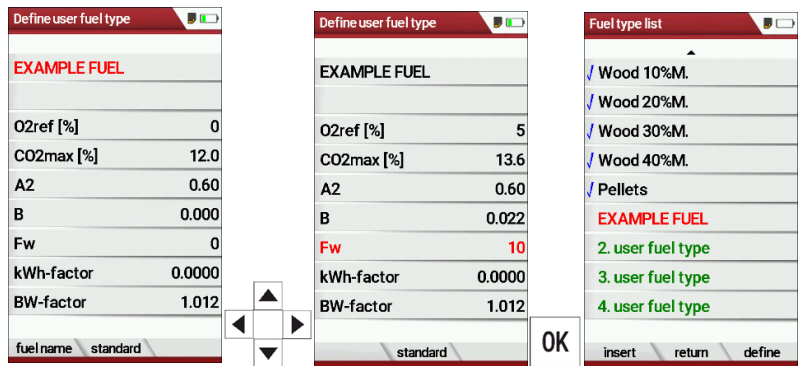

- ▶ Select the desired fuel parameter.
- ▶ Change the desired fuel parameter.
- ▶ Press OK.
 - ⇒ The defined user fuel appears in the menu Fuel type list.
 - ⇒ You can add the defined user fuel to the menu Fuel type selection.
 - ☞ See also chapter Add fuels to fuel type selection, Page 31.

5.12. Define measurement window.

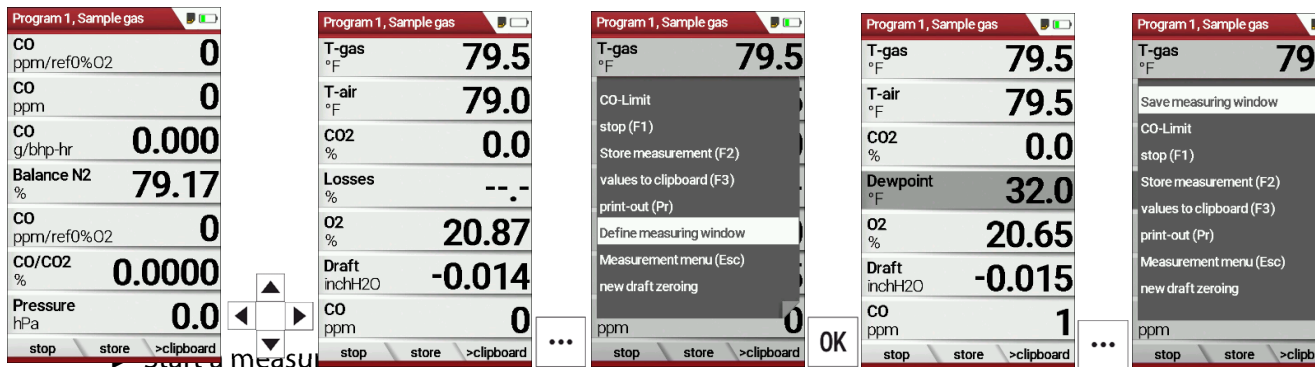

- In this example Program 1, Sample gas.
- ▶ Select one of three measurement windows.
 - ▶ Press the menu key
 - ⇒ A selection list appears.
 - ▶ Select Define measuring window.
 - ▶ Press OK.
 - ⇒ The measurement window appears
 - ▶ Select the desired measured value that you want to change.
 - ▶ Press the menu key.
 - ⇒ A selection list appears.
 - ▶ Select Save measuring window.
 - ▶ Press OK.
 - ⇒ The change is saved.

5.13. Configure zoom window

In each measuring program, a zoom window is available for the enlarged display of measured values.

You can choose between two zoom views.

- ▶ Press the arrow key at the top to display four measured values with the respective curve.
- ▶ Press the down arrow key to display two measured values without a curve.

The following example shows the configuration of the zoom window with four measured values. The configuration of the zoom window with two measured values is done in the same way.

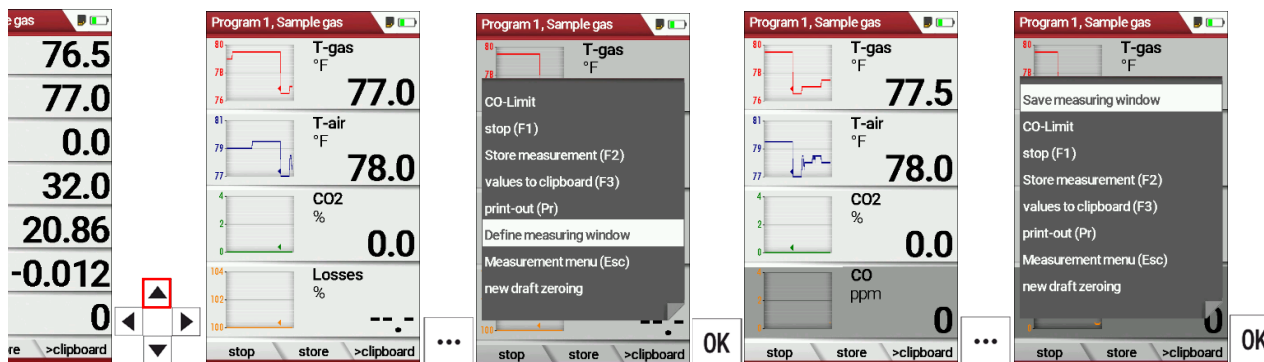

- ▶ Start a measuring program.
In this example Program 1, Sample gas.
- ▶ Press the arrow key up.
⇒ The zoom window appears.
- ▶ Press the menu key.
⇒ A selection list appears.
- ▶ Select define measuring window.
- ▶ Press OK.
- ▶ Select the desired measured value that you want to change.
- ▶ Press the menu key.
⇒ A selection list appears.
- ▶ Select Save measuring window.
- ▶ Press OK.
⇒ The change is saved.

6 Prepare measurement

6.1. Perform overall visual inspection

Before using the analyzer, perform an overall visual inspection to ensure that the analyzer is operating correctly.

6.2. Ensure power supply

The analyser can be used with:

- with the internal MRU battery (provided)
- with the MRU battery charger (provided)

External equipment may only be connected while the analyser is switched off!

6.3. Automatic Auto-off function

The auto-off function switches the analyzer off after 60 minutes without any key operation.

The auto-off function is deactivated during a measurement or the charger/USB connection, the auto-off function is deactivated.

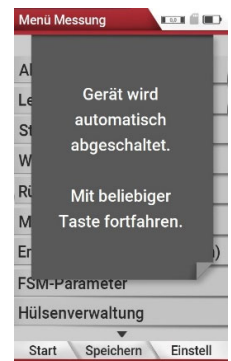

6.4. Measuring with grid power supply / Battery charging

Whenever you connect the analyser with external battery charger (90...260 V / 50/ 60Hz) the battery will be charged

Once the battery is fully charged the analyser will switch to trickle charge mode.

At the moment, if the battery is fully charged and the trickle charge mode begins, acoustic feedback will be played.

6.5. Measurements in battery mode (battery monitoring)

The battery symbol in the top right corner displays the current battery charge condition.

Approximately 15 minutes (depending on the analyser configuration) before the battery is drained, the battery symbol will start to blink red (about once per second).

When the battery is almost drained and the analyser is not connected to the battery charger within one minute, then the analyser will switch off automatically to prevent deep discharge of the battery.

6.6. Operating temperature

If the analyser has been stored at low temperatures, it will require some time to equilibrate to the ambient temperature before being switched on. If it does not equilibrate, condensation will occur inside the analyser!
If the temperature is out of its operation range you will see the following messages on the display:

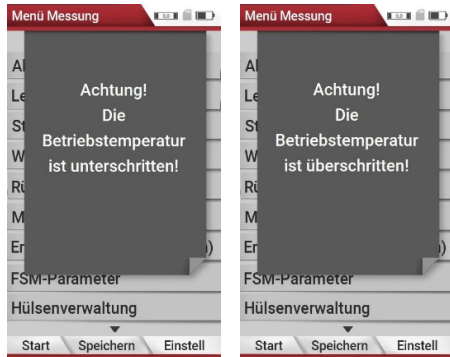

ATTENTION

Once one of these messages appears you will not be able to use the analyser, it will give an acoustic signal until it has reached the specified operation temperature between +5°C and +45°C

6.7. Control Condensate separator

CAUTION



Acid from the condensate

Acid burns may result from weakly acidic liquids from the condensate.

- ▶ If you come into contact with acid, wash the area immediately using a lot of water.

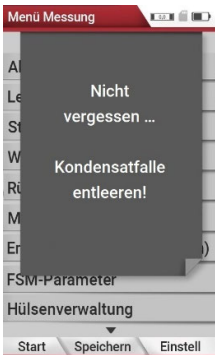

- ▶ Control the condensate separator before and after each measurement
- ▶ Check that the condensate separator is empty.
- ▶ Check the star filter.

⇒ Star filter white = ready for use
⇒ Star filter dark = renew

When switching off, a warning message is displayed:

6.8. Connections and tightness

Check all plug connections for correct fitting.

Check all hoses, hose connections, condensate containers (from the probe tip to the gas connection on the analyser) for tightness.

The analyser has a built-in automatic test to check the tightness of the gas paths.

☞ See also chapter 9.4 Performing leak test, Page 73

6.9. Automatic zero point

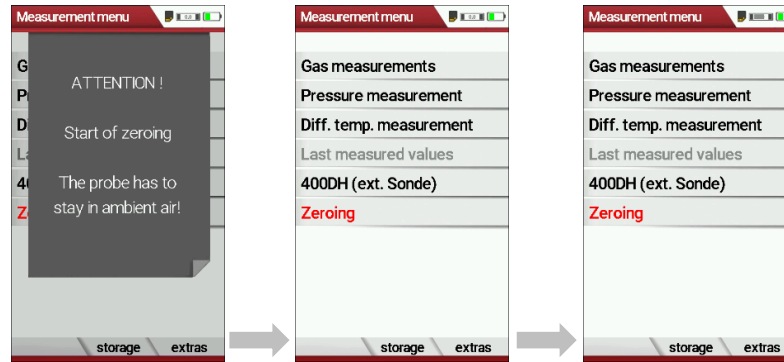

NOTE



The probe must not be in the exhaust gas during the zeroing.

► Switch on the analyser.

- ⇒ The analyser autonomously carries out a zero-point measurement.
- ⇒ During zeroing, the -> 0.0 <- symbol flashes in the upper right corner of the display.
- ⇒ After zeroing is complete, the analyser is ready for measurement.
- ⇒ If sensors are faulty, the error is identified during zeroing and an error message is displayed.

Repeat zeroing

The zeroing can be repeated at any time as long as the probe is not inside the stack

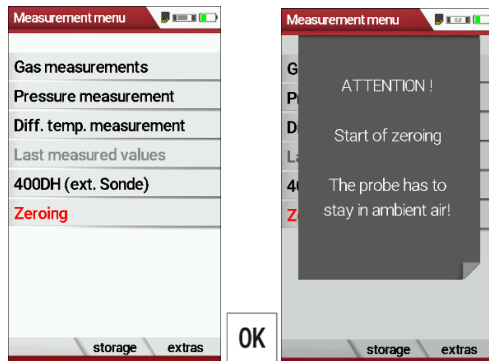

- ▶ Go to the Measurement menu
- ▶ Select Zeroing
- ▶ Press OK.
 - ⇒ Zeroing is started.

7 Performing measurement

In the basic configuration, each analyser has the complete functionality you need for gas measurement.

The process of gas measurement is described below.

The description of other optionally available measuring programs can be found in the appendix or on separate supplementary sheets.

7.1. Perform Gas measurement

Core flow search

NOTE

Note that you have to switch on the core flow search in the menu Measurement settings before starting a gas measurement.

☞ See also chapter 5.4 Set measurement, Page 26

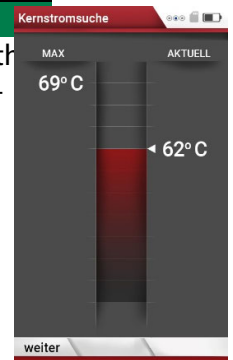
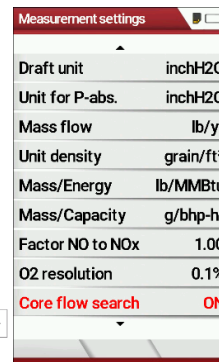
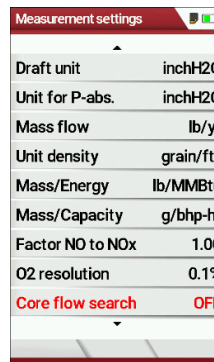

You can preselect whether a core flow search is to be carried out in the measuring programs before the start of the measurements.

The core flow search will help you to find the optimal measurement point in the stack. The core flow can be identified by the maximum flue gas temperature. In high reaction time the analyser displays the trend of the flue gas temperature. Insert the probe pipe slowly into the stack and position your probe tube when you have reached the maximum flue gas temperature that is displayed

Positioning the probe in the core flow:

Insert the probe pipe slowly into the stack and position your probe pipe when you have reached the maximum flue gas temperature that is displayed.

Maximum temperature has been reached when the arrows (left picture) disappear, max. (Right picture) appears in place of the arrow, and the beeper signal stops. Moving away from the max. Temperature will result in the bars moving away from the max. Once the right core flow has been achieved, the probe is fixed with the probe cone screw.

Select Measurement program

DANGER



Rick due to toxic gases

There is a risk of poisoning.

Noxious gases are sucked in by the measuring device and released into the ambient air.

- ▶ Only use the measuring device in well ventilated spaces.

NOTE



Wrong measuring results

The extracted flue gas must be able to evacuate the analyser without obstruction.

- ▶ The exhaust outlet at the rear of the analyser may never be covered during a measurement, never operate the analyser in a transport case.

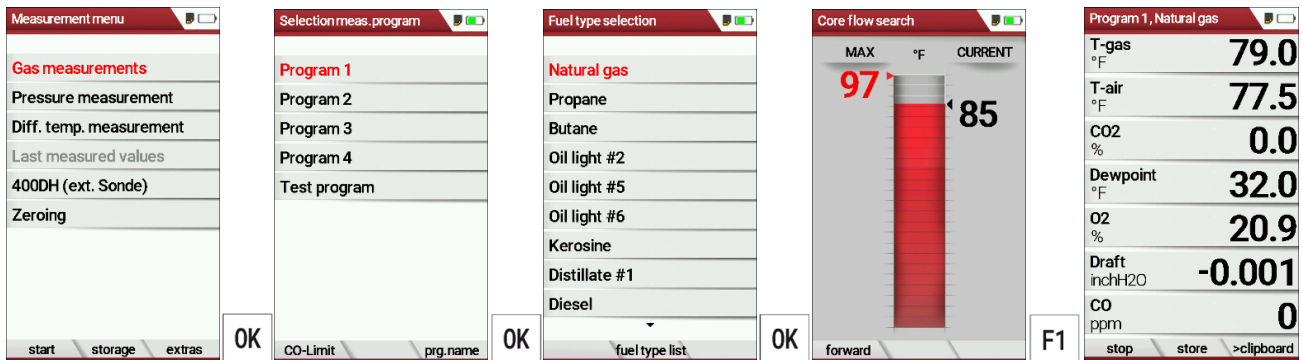

- ▶ Go to the Measurement menu.
- ▶ Select Gas measurements.
- ▶ Press OK.
 - ⇒ The menu Selection meas. program appears.
- ▶ Select the desired measurement program.
- ▶ If necessary, change the CO-Limit.
 - ☞ See also chapter 5.8 Set CO-Limit, Page 30.
- ▶ If necessary, change the measurement program name.
 - ☞ See also chapter 5.9 Change measurement program name, Page 30.
- ▶ Press OK.
 - ⇒ The menu Fuel type selection appears.
- ▶ Select the desired fuel.
- ▶ If necessary, add fuels from the fuel type list to the menu Fuel type selection.
 - ☞ See also chapter Add fuels to fuel type selection, Page 31.
- ▶ Press OK.
 - ⇒ If activated the menu Core flow search appears.
- ▶ Perform the Core flow search and then press F1.
 - ☞ See also chapter Core flow search, Page 40.
- ⇒ The Measurement is started.

NOTE

You can start a measurement with the previously set measurement parameters directly from the Measurement menu.

- ▶ Press F1.

- ⇒ If activated, the menu Core flow search appears.
- ⇒ The Measurement is started.

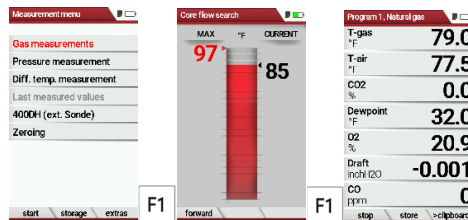

Perform Annular-gap test

The annular gap test checks whether the exhaust system is tight by measuring the O2 value of the combustion air.

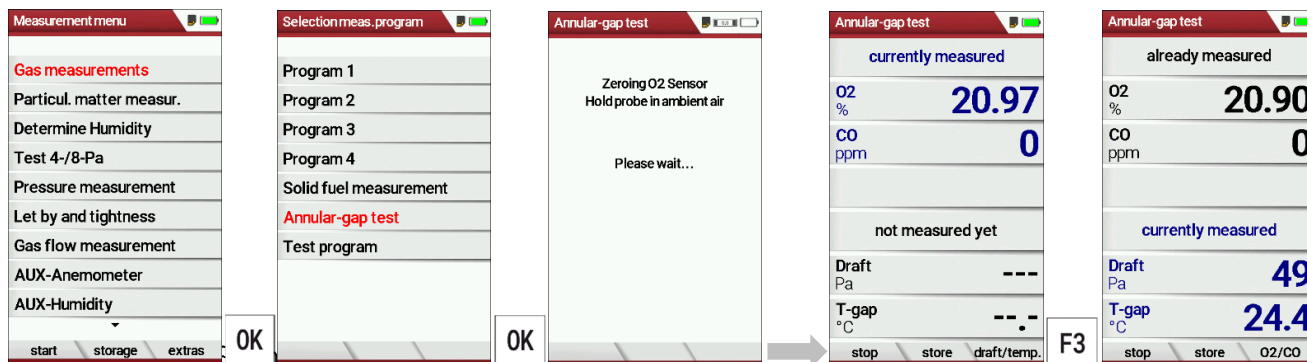

- ▶ Press OK.
 - ⇒ The menu Selection meas. Program appears.
- ▶ Select Annular-gap test.
- ▶ Press OK.
 - ⇒ If necessary, an automatic zero-point measurement is performed.
 - ⇒ The menu Annular-gap test appears.
- ▶ Press F3.
 - ⇒ The currently measured values for Draft and T-gap are displayed.

The MRU annular gap multi-hole probe No. 56352 is suitable for annular gap measurement. The silicone hose is attached to the condensate separator of the analyzer.

Optionally, the annular gap multi-hole probe can be attached to the measuring probe of the analyzer with the probe coupling MRU No. 11652.

Perform Test program

The test program is used by test facilities to check the analyzer by means of test gas in the measuring program.

No calculations are performed during the test program.

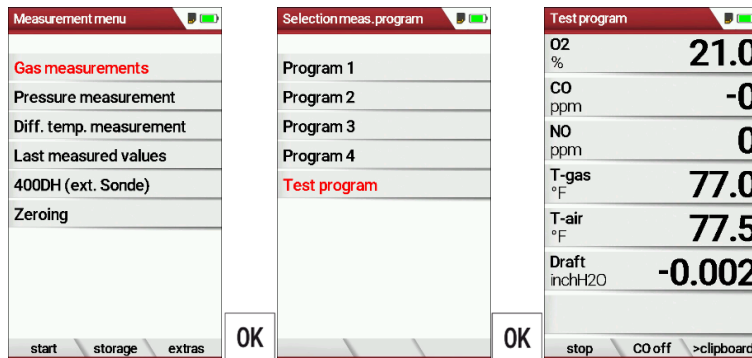

- ▶ Select Gas Measurements.
- ▶ Press OK.
 - ⇒ The menu Selection meas. program appears.
- ▶ Select Test program.
- ▶ Press OK.
 - ⇒ The Test program is started.

CO purging

If the configured CO threshold is exceeded during the gas measurement, the analyzer activates the purge function. This protects the CO sensor from excessive CO values without falsifying other measured values.

During the purging, the CO measured value has no meaning and is therefore replaced by dashes. These are red as long as the CO measured value is still above the set CO threshold and then turn black when purging is successful. Purging does not end automatically, but must be switched off by the user. To do this, select the menu key and the subitem "purge pump OFF"

7.2. Temporary buffer

The analyzer offers you the possibility to store all momentary measured values in a temporary buffer while the measurement is running and to continue the measurement.

- ▶ Later on, the values can be brought back from the temporary buffer to the measuring window in order to print them out or / and to save them.

Store values into temporary buffer

During a running measurement you can store the current values in the temporary memory.

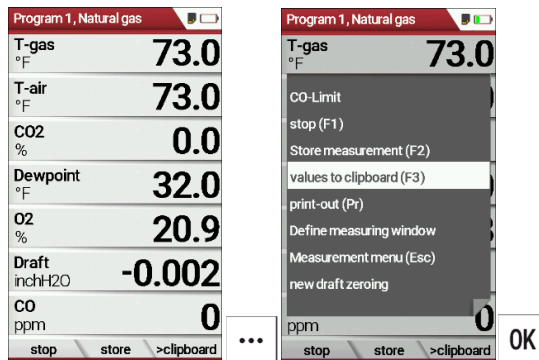

- ▶ Start a Gas measurement.
 - ☞ See also chapter 7.1 Perform Gas measurement, Page 40.
- ▶ Press the menu key.
 - ⇒ A selection list appears.
- ▶ Select values to clipboard.
 - ⇒ The measured values are stored in the temporary buffer.

When the measurement is stopped, you can compare the currently displayed measured values with the measured values in the temporary buffer.

Program 1, Natural gas	
T-gas °F	72.5
T-air °F	73.0
CO2 %	0.0
Dewpoint °F	32.0
O2 %	20.9
Draft inchH2O	0.000
CO ppm	1
start store v./clipboard	

F3

- ▶ Stop the Measurement.
 - ⇒ The measuring window is greyed out.
- ▶ Press F3.
 - ⇒ The measured values stored in the temporary memory are displayed.

If you have stopped a measurement without first storing the measured values in the temporary buffer, you can store the measured values directly in the temporary buffer from the function key bar.

Program 1, Natural gas	
T-gas °F	73.0
T-air °F	73.5
CO2 %	0.1
Dewpoint °F	32.0
O2 %	20.8
Draft inchH2O	-0.001
CO ppm	1
start store >clipboard	

F3

- ▶ Stop the measurement.

- ⇒ The measuring window is greyed out.
- ▶ Press F3.
 - ⇒ The measured values are stored in the temporary buffer.

Overwrite measured values in temporary buffer

You can overwrite the measured values stored in the temporary buffer with the currently displayed measured values

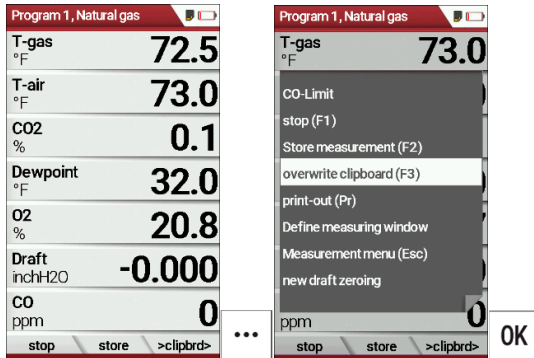

► Press the menu key.

- ⇒ A selection list appears.
- Select overwrite clipboard.
- Press OK.
 - ⇒ The temporary buffer is overwritten.
- You can overwrite the temporary buffer with current measured values at any time.

If necessary, you can process the currently displayed measured values further, e.g., print or store them

☞ See also chapter 7.5 Store measurement values, Page 50 and 7.6 Print measurement values, Page 52.

7.3. Perform pressure measurement

Pressure (4 values) is measured and saved to the selected measurement name. The actual measured value is displayed in the middle of the display. The 4 measurement names can be changed as desired.

The hose on the draft + connector must be connected for draft measurements.

The second hose on the Delta P- connector must be connected for differential measurement.

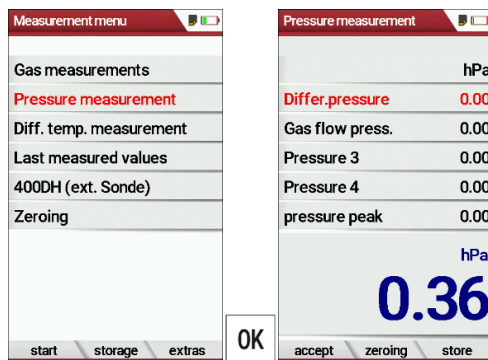

- ▶ Go to the measurement menu.
- ▶ Select Pressure measurement.
- ▶ Press OK.

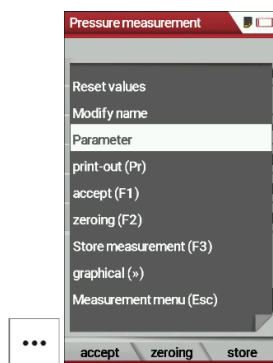

- ▶ Press the menu key.
 - ⇒ A selection list appears.
- ▶ Select the desired item from the selection list.
 - For example, select the Parameter to set the unit as well as the damping (T90/s).

7.4. Perform Differential temperature measurement

In the differential temperature measurement menu two temperatures can be measured simultaneously by using the T1 and T2 connectors. Both measured temperatures and the difference between the temperatures will be displayed.

- ▶ Plug a temperature sensor into the T1 connection.
- ▶ Plug a temperature sensor into the T2 connection.

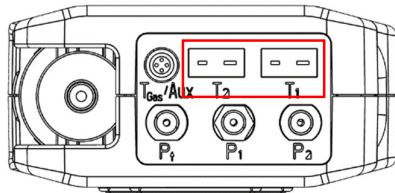

NOTE



The accuracy of the difference temperature measurement is guaranteed only on use of the MRU temperature sensors.

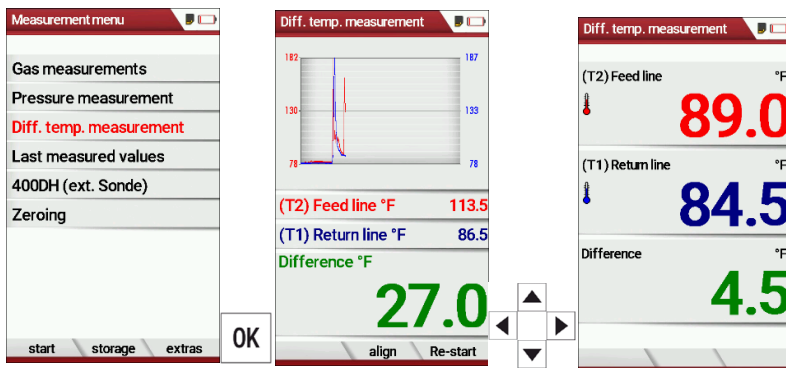

- ▶ Go to the Measurement menu.
- ▶ Select Diff. Temp. measurement.
- ▶ Press OK.
 - ⇒ The menu Diff. temp. measurement appears.
 - ⇒ The temperatures T1, T2 and the difference appears.

- ▶ Press the menu key.
 - ⇒ A selection list appears.
- ▶ Select the desired item from the selection list.
 - For example, select the print-out (Pr) item to print the measurement.

7.5. Store measurement values

If "store" is displayed in the function key bar, you can save measurement results to the data memory using the related function key F2 or F3. The function of the data storage is displayed in chapter 8 Data storage, Page 57.

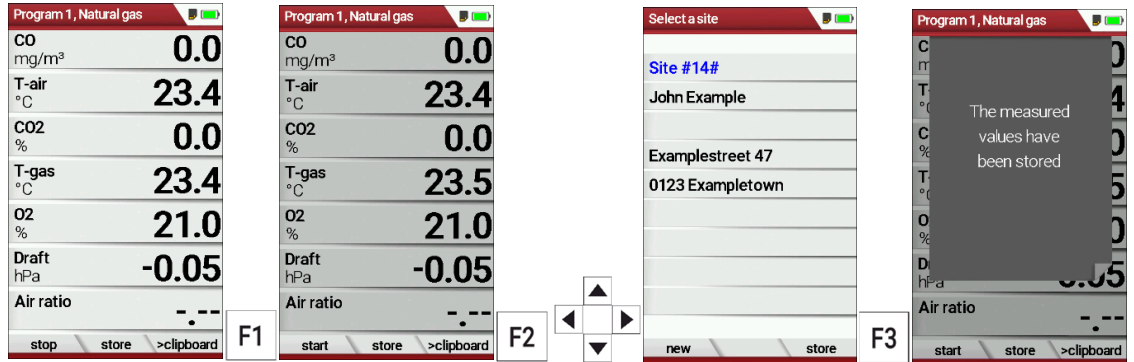

- ▶ Press F1.
 - ⇒ The measurement is stopped.
 - ⇒ The measurement window is greyed out.
- ▶ Press F2.
 - ⇒ The menu Select a site appears.
- ▶ Select the desired site.
- ▶ If necessary, press F1 to select a new site.
 - ☞ Siehe auch Kapitel **Error! Reference source not found., S.Error! Bookmark not defined..**
 - ☞ See also chapter Create new site, Page 58.
- ▶ Press F3.
 - ⇒ The measured values have been stored.
 - ☞ See also chapter View measurements, Page 65.

Enter T-boiler, Soot and Derivative

The analyzer does not have a soot measurement.

- ▶ However, you can enter determined soot data to save or print them together with the measurement data.

NOTE

Before you can enter the soot data, you have to activate the setting "Add soot & T-boiler" in the menu Measurement settings.



☞ See also chapter 5.4 Set measurement, Page 26.

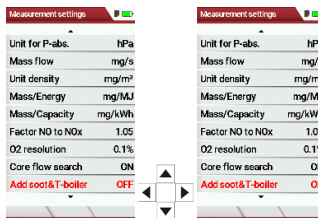

- ▶ After a successful measurement, you can enter the externally determined measured values.

NOTE



The input of soot numbers and derivative is only possible for fuel oil / diesel.

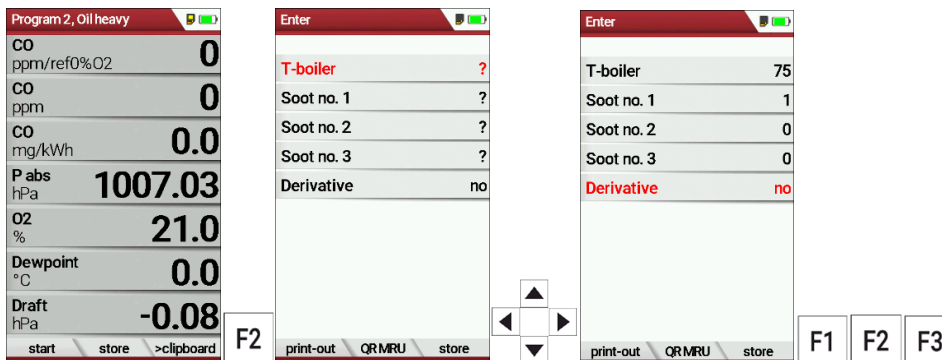

- ▶ Press F2.

⇒ The menu Enter appears.

- ▶ Enter the determined value for the T-boiler and, if available, the determined values for soot number 1, soot number 2, soot number 3 and derivative.
- ▶ Press F1 to create a printout.
- ▶ Press F2 to display an OR code of the measurement.
- ▶ Press F3 to store the measurement.

7.6. Print measurement values

You have the possibility to print measurement results via the following optionally available printers.

- Speed printer (IR desktop printer)
- HSP 580 (Highspeed-Bluetooth-Thermoprinter)



NOTE

Before you can print measurement results, you must select and configure the appropriate printer (printer type) in the menu printout.

Open menu print-out

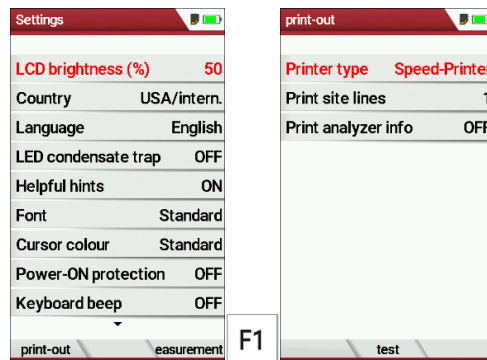

- ▶ Open the menu Settings.

☞ See also chapter 5.2 Customize settings, Page 23.

- ▶ Press F1.
 - ⇒ The menu print-out appears.
- ▶ Set the desired settings.

Setting	Description
Printer type	Selection of the printer type
Print site lines	Line 1 (plant number) is required. The other lines (free text lines) can be printed if required.
Print analyzer info	Measurement printouts can be made shorter by omitting the analyzer. However, in some printouts (calibration, service, etc.) the info is still printed.

Print measurement results with Speedprinter

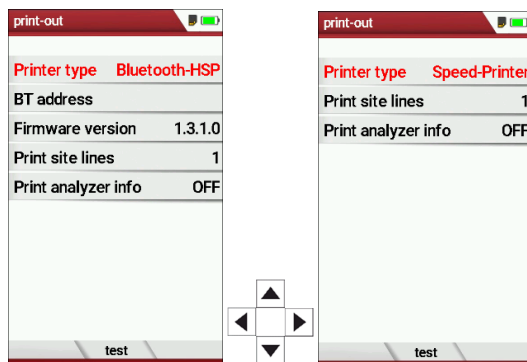

- ▶ Go to the menu print-out.
 - ☞ See also chapter Open menu print-out, Page 52.
- ▶ Select Speed-Printer as Printer type.
- ▶ Align the printer as follows:



► Press the printer key.
Optionally, press the

context menu key and select Printout (Pr.)

⇒ A print-out is created.

Further technical specifications as well as battery and paper rolls changes please see separate printer manual.

Print measurement results with Highspeed-Bluetooth-Thermoprinter

- ▶ Go to the menu print-out.

☞ See also chapter Open menu print-out, Page 52.



- ▶ Select Bluetooth-HSP as Printer type.
- ▶ Press F2.
 - ⇒ The connection between analyzer and the printer is established.
 - ⇒ After the connection between the analyzer and the printer has been established, the Bluetooth address (BT address) appears in the display. An existing connection to a printer is indicated by a printer icon and a Bluetooth icon.



- ▶ Press F3 to disconnect the analyzer from the printer.

You can also disconnect an existing connection between Bluetooth and printer in the Measurement menu:

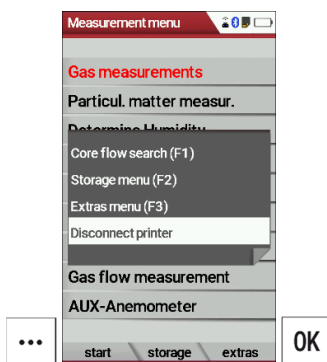

- ▶ Go to the Measurement menu.
- ▶ Press the menu key.
 - ⇒ A selection list appears.
- ▶ Select Disconnect printer.
- ▶ Press OK
 - ⇒ The printer is disconnected.

7.7. Stop measurement

A running measurement can be stopped at any time by pressing the F1 key. The window changes colour and the measured values are frozen. All measured values available at the time of stopping are available in the analyser and can still be displayed. By pressing the ESC key, the analyser returns to Measurement menu.

7.8. Last measured values

The analyser offers the possibility to continue working with the last measured values after the end of a measurement.

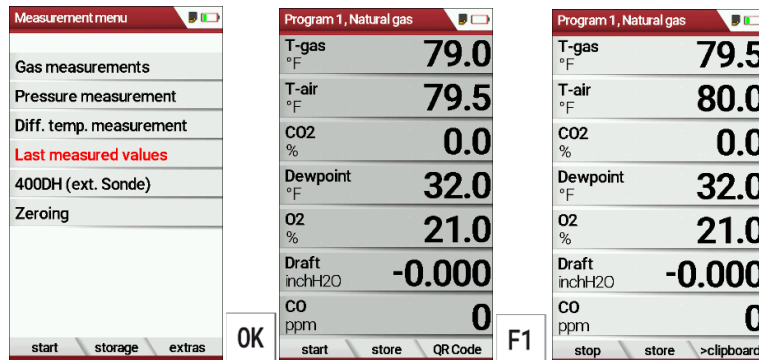

- ▶ Go to the Measurement menu.
- ▶ Select Last measured values
 - ⇒ The measuring window with the last measured values appears.
- ▶ Press F1.
 - ⇒ The measurement is continued.

8 Data storage

8.1. Organize data storage

The basis for the data storage of the analyzer is saved sets of sites inside the analyzer. Each site has a distinct site number as well as 8 additional free text lines for names and address.

The analyzer can store up to 32,000 different sites.

Sites can be newly created and changed in the analyzer, or are transferred e.g., via a PC - program by means of ZIV - module.



NOTE

New sites created in the analyser will NOT be transferred back to the computer program. When transferring data from the analyser to the computer only measurement data will be transferred, identified by the site number that has been assigned to the measurement, when the measurement was saved.

Measurements are stored by assigning them to a site. Measurements can be gas measurements or other measuring programs available in the analyser.

8.2. Call up information about Memory info

In the menu item "storage" you select „memory info“ to get information about the actual memory volume. The part of free memory, the total number of the stored sites and the number of the measurements stored all together, split in the kind of the measurement is listed.

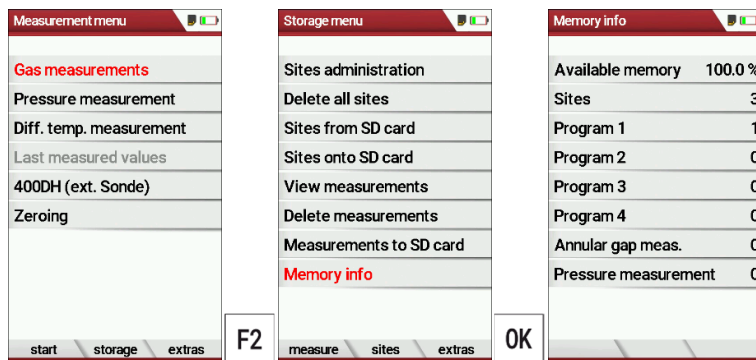

- ▶ Go to the Measurement menu.
- ▶ Press F2.
 - ⇒ The Storage menu appears.
- ▶ Select Memory info.
- ▶ Press OK.
 - ⇒ Das Menü Speicher Info erscheint.
 - ⇒ The menu Memory info appears.
 - ⇒ Information about the data storage is listed.

8.3. Sites administration

In the sub menu Sites administration, you can:

Im Menüpunkt Anlagenstamm können Sie

- View all data of the stored sites
- Create new sites
- Change data on existing sites
- Delete sites



NOTE

New sites created in the analyser will NOT be transferred to a PC program

Create new site

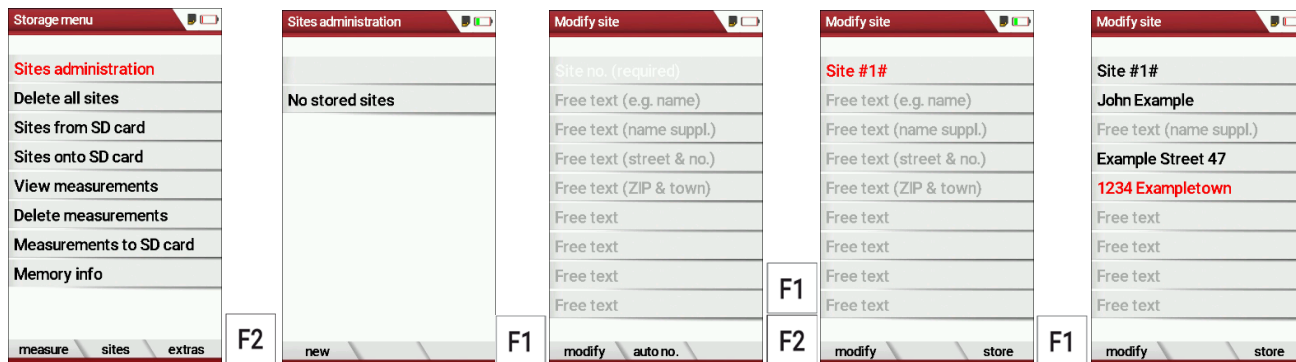

- ▶ Go to the Storage menu.
- ▶ Press F2
 - ⇒ The menu Sites administration appears.
- ▶ Press F1.
 - ⇒ The menu Modify site appears.
- ▶ Press F1 to assign manually a site number to the site.
- ▶ Press F2 to assign automatically a site number to the site.
 - ⇒ The site is assigned a site number.
- ▶ Select the free text lines that you want to edit.
- ▶ Press F1.
 - ⇒ A window appears.
- ▶ Enter the desired content.
- ▶ If necessary, select free text lines and fill them with content.
- ▶ Press F3.
 - ⇒ The site is stored.

View sites

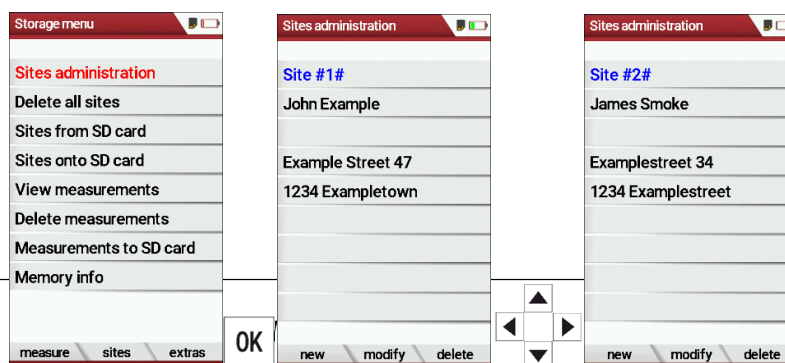

- ▶ Go to the Storage menu.
- ▶ Select Sites administration.
 - ⇒ The menu Sites administration appears.
 - ⇒ Each stored site is displayed on a page with the colored site number and eight additional free text lines.
- ▶ If necessary, scroll through the sites until you have found the desired site.

Change sites

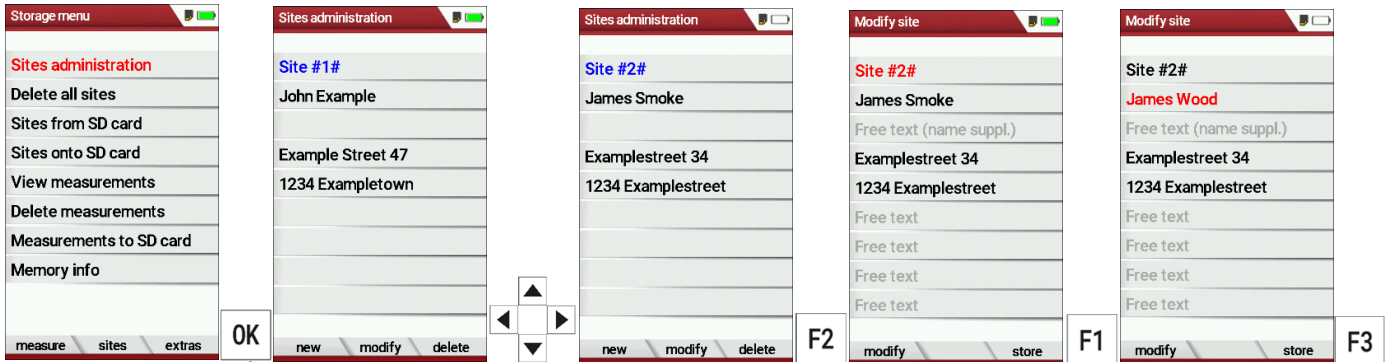

- ▶ Go to the Storage menu.
- ▶ Select Site administration.
- ▶ Press OK.
 - ⇒ The menu Sites administration appears.
- ▶ Select the site that you want to change.
- ▶ Press F2.
 - ⇒ The menu Modify site appears.
- ▶ Select the free text line that you want to change.
- ▶ Press F1.
 - ⇒ A window appears.
- ▶ Enter the desired changes.
- ▶ If necessary, select further free text lines and change the corresponding free text lines.
- ▶ Press F3.
 - ⇒ The changes are stored.

Delete sites

You can delete sites individually or delete all sites simultaneously

Delete sites individually



- ▶ Go to the Storage menu.
- ▶ Select Sites administration.
- ▶ Press OK.
 - ⇒ The menu Sites administration appears.
- ▶ Select the site you want to delete.
- ▶ Press F3.
 - ⇒ A message appears.
- ▶ Select continue to delete the site.
- ▶ Select abort to retain the site.
- ▶ Drücken Sie OK.
- ▶ Press OK.
 - ⇒ Depending on the selection, the site is deleted or retained.

Delete all sites

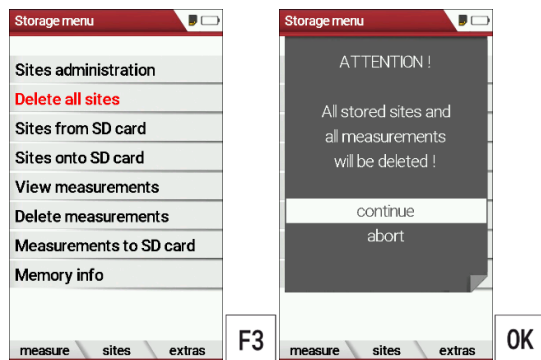

- ▶ Go to the Storage menu.
- ▶ Select Delete all sites.
- ▶ Press OK.
 - ⇒ A message appears.
- ▶ Select continue to delete all sites.
- ▶ Select abort to retain all sites.
- ▶ Press OK.
 - ⇒ Depending on the selection, the sites are deleted or retained.

8.4. Transfer data via using SD card

The data exchange format is CSV. A character-separated values (CSV) file is a simple text format for a database table. Each record in the table is one line of the text file. Each field value of a record is separated from the next by a character. The analyzer uses a semi-colon ';' as value separator (other implementations use sometimes a comma). Implementations of CSV can often handle field values with embedded line breaks or separator characters by using quotation marks or escape sequences. CSV is a simple file format that is widely supported, so it is often used to move tabular data between different computer programs, for example Microsoft Excel™ or Access™, that support the format. Also, other computer programs offer this type of interface because it is widely spread and easy to use.

The following functions are available:

- Import sites
- Export sites
- Export measurements

Import sites

With this function you can import Sites which have been created on a computer or another Analyzer.

The File name must have the name "anlagen.csv"(anlagen = German for sites). The file has no column heading that means that the first line already has user data. Each line has a minimum of 9 columns (with 8 semi-colons) and the first field in the line will be the site number. All data will be imported as long a site number is available. Per field a maximum of 24 characters will be imported, too long words will be cut off.



NOTE

Before you can import sites via a CSV file, you have to rename the desired CSV file to anlagen.csv. Save the renamed CSV file in the root directory of the SD card.



NOTE

While importing data from the SD Card to the analyser there is no check for double site numbers (Line 1), neither inside of the file that is imported nor between the file and the sites already inside the analyser. The analyser can easily handle double site numbers but you could face problems with double site numbers when exporting them again to a computer program

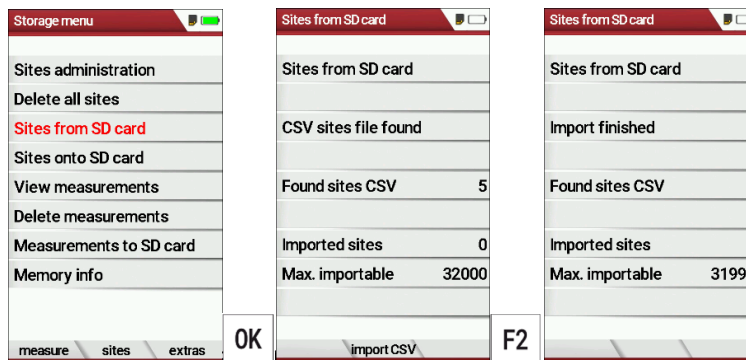

- ▶ Select Sites from SD card.
 - ⇒ The menu Sites from SD card appears.
- ▶ Press F2.
 - ⇒ The sites are imported.

Export sites

This function can be used for an analyser back up or if you wish to supply the analyser information to a computer program or another analyser. This is very handy if you have made some modifications inside the analyser (site) for example if you have modified the phone number of a customer and this modification needs to be updated in the computer software, or if a second analyser needs to have the same site information.

The File format it's the same as described above „Import sites“.

Only the file name is different, the file name will be ‚ANLxxxx.csv‘, in which the xxxxx are continuing 5-digit numbers with leading zeros.

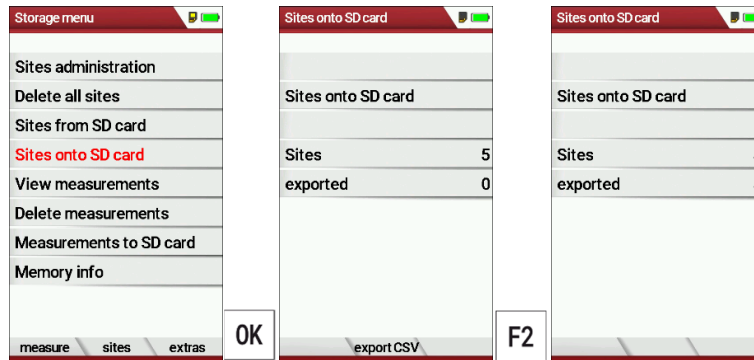

- ▶ Go to the Storage menu.
- ▶ Select Sites onto SD card.
- ▶ Press OK.
 - ⇒ The menu Sites onto SD card appears.
- ▶ Drücken Sie F2.
- ▶ Press F2.
 - ⇒ The sites are exported onto SD card.

If the file must be imported into another analyser, the file must first be renamed into „anlagen.csv“.

Export measurements

With this function, the analyzer can make its stored measurements available to a PC.

Attention, this function is not suitable as a backup or for transferring the measurements to other measuring devices, as the measurements cannot be imported again.

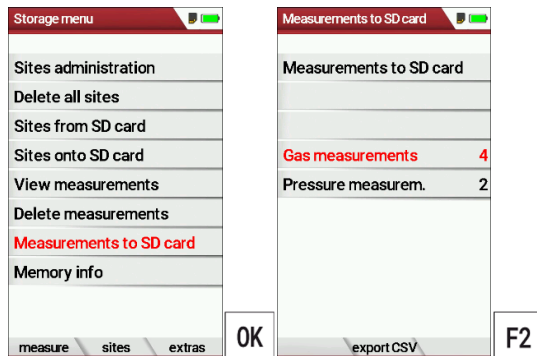

- ▶ Go to the Storage menu.
- ▶ Select Measurements to SD card.
- ▶ Press OK.
 - ⇒ The menu Measurements to Sd card appears.
- ▶ Select the measurement type you want to export. In this example, gas measurements are exported.
- ▶ Press F2.
 - ⇒ The measurements are exported.

8.5. Measurements in Data storage

View measurements

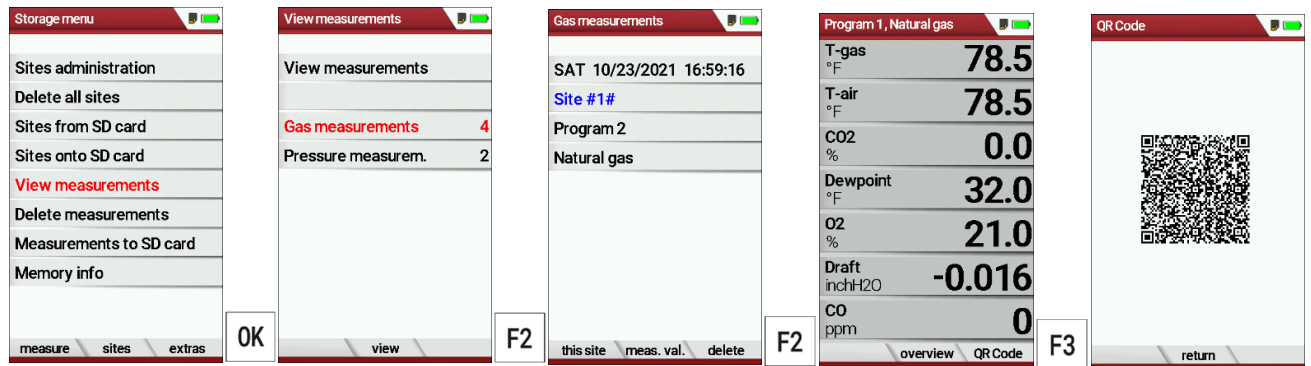

- ▶ Go to the Storage menu.
- ▶ Select View measurements.
 - ⇒ The menu View measurements appears.
 - ⇒ An overview of the number of stored measurements depending on the measurement type appears.
- ▶ Select the desired measurement type.
In this example, gas measurements are selected.
- ▶ Press F2.
 - ⇒ Then you first get a page with context information about the saved measurements
- ▶ Select the desired measurement.

NOTE



You have the possibility to select only the measurements that are stored for a site by selecting F1 = "this site" while a measurement of the desired site is displayed. With F1 = "all sites" you cancel this filter again.

- ▶ Press F2.
 - ⇒ The measured values of the stored measurements are displayed in detail.
- ▶ Press F3 to display gas measurements as an OR Code

Delete measurements

You can

- Delete single measurements
- Delete all measurements or delete all measurements of a measurement type

Delete single measurements

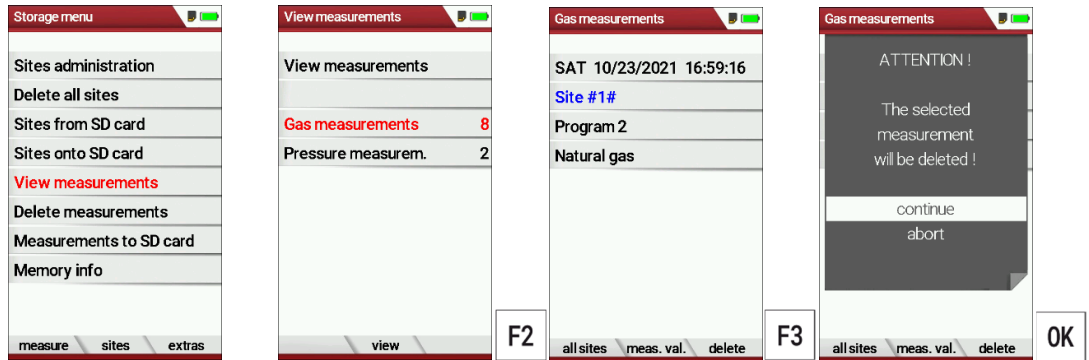

- ▶ Go to the Storage menu.
- ▶ Select View measurements.
- ▶ Drücken Sie OK.
- ▶ Press OK.
 - ⇒ The menu View measurements appears.
 - ⇒ An overview of the number of stored measurements depending on the measurement type appears.
- ▶ Select the desired measurement type.
- ▶ Press F2.
 - ⇒ The stored measurements are displayed.
- ▶ Select the measurement you want to delete.
- ▶ Press F3.
 - ⇒ A message appears.
- ▶ Select continue to delete all sites.
- ▶ Select abort to retain all sites.
- ▶ Press OK.
 - ⇒ Depending on the selection, the measurements are deleted or retained.

Delete all measurements

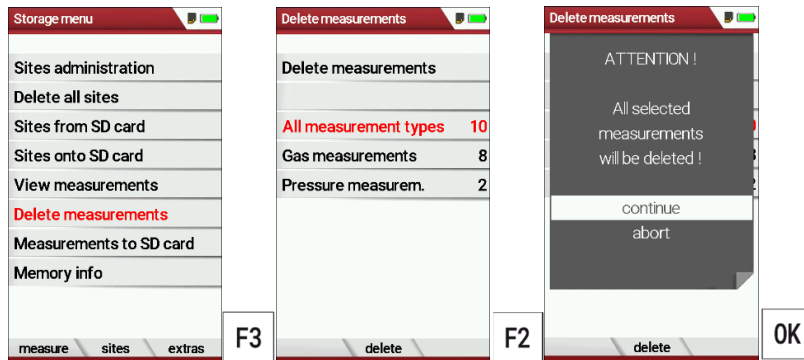

- ▶ Go to the Storage menu.
- ▶ Select Delete measurements.
- ▶ Press OK.
 - ⇒ The menu Delete measurements appears.
- ▶ Select which measurement type you want to delete.
- ▶ Press F2.
 - ⇒ A message appears.
- ▶ Select continue to delete all sites.
- ▶ Select abort to retain all sites.
- ▶ Press OK.
 - ⇒ Depending on the selection, the measurements are deleted or retained.

8.6. Messergebnisse als OR-Code

Die Funktion OR-Code ermöglicht:

- die Übernahme der Messdaten in Fremdsoftware mit geeigneter Importfunktion
- die Übernahme von Messdaten in die MRU4u App.

Die gespeicherten Messungen (Abgasmessung, Ringspaltmessung und CO-Messung) in einer Anlage können als QR-Code im Gerät angezeigt werden. Vor einer Nutzung muss das geeignete Dateiübertragungsprotokoll eingestellt werden - ZIV oder MRU. Das ZIV-Protokoll ist i.d.R. geeignet für den Datenaustausch mit Fremdsoftware, das MRU-Protokoll kommuniziert mit MRU-Software (MRU4u)



► Gehen Sie in das Menü Einstellungen.

☞ Siehe auch Kapitel **Error! Reference source not found.Error! Reference source not found., S.Error! Bookmark not defined..**

► Wählen Sie QR Code.

► Wählen Sie das gewünschte Dateiübertragungsprotokoll aus.

Livemessung als QR-Code

Nach dem Stopp der Messung können die Messergebnisse als QR Code angezeigt werden. Diese Funktion befindet sich im Kontextmenü:

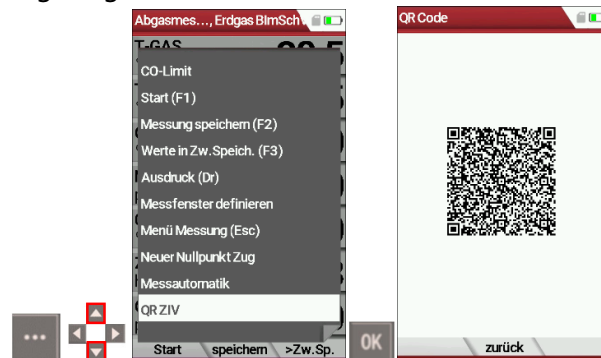

► Stoppen Sie die Messung

☞ Das Messwertfenster wird grau hinterlegt.

► Drücken Sie die Menütaste.

☞ Eine Auswahlliste erscheint.

► Wählen Sie OR-ZIV oder QR-MRU. Beachten Sie, dass die Darstellung abhängig vom zuvor eingestellten Dateiübertragungsprotokoll ist.

► Drücken Sie OK.

⇒ Der OR-Code erscheint.

Gespeicherte Messung als QR-Code



- ▶ Gehen Sie in das Menü Speicher
- ▶ Wählen Sie Messungen ansehen.
- ▶ Drücken Sie OK.
 - ⇒ Das Menü Messungen ansehen erscheint.
- ▶ Wählen Sie Abgasmessungen.
 - ⇒ Das Menü Abgasmessungen erscheint.
- ▶ Wählen Sie eine gespeicherte Messung aus.
- ▶ Drücken Sie die Menütaste.
 - ⇒ Eine Auswahlliste erscheint.
- ▶ Wählen Sie OR-ZIV oder QR-MRU. Beachten Sie, dass die Darstellung abhängig vom zuvor eingestellten Dateiübertragungsprotokoll ist.
- ▶ Drücken Sie OK.
 - ⇒ Der QR-Code erscheint.

9 Extras / Adjustment

The analyzer is delivered with a standard preset software, which should cover your needs in most cases. However, the settings are highly flexible and customizable.

If you want to change various settings, we recommend that you do so with a little thought. The better you plan the settings, the less often you will have to correct them and the more comfortable you will be working with the analyzer.

Use the possibilities of the individually configurable measuring methods, measuring displays, pressure outputs and self-selecting fuels in such a way that all your practical requirements are met as far as possible. Then you will rarely have to make changes to the settings again. After making changes to the settings, you should switch off the analyzer once briefly so that the changes are permanently saved and take effect when you restart the analyzer.

9.1. Service menu

The Service menu is protected by a PIN code against unauthorized access.

For the PIN code, contact an MRU service center (www.mru.eu).

If you have started the PIN code query by mistake, press the ESC key. You will return to the Extras menu.

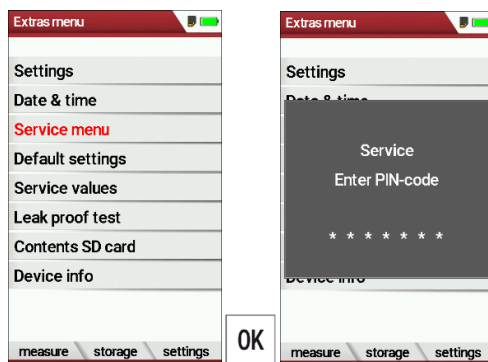

- ▶ Go to the Extras menu.
- ▶ Select Service menu.
- ▶ Press OK.
 - ⇒ A window for entering the PIN-code appears.
- ▶ Enter the PIN-Code.
 - ⇒ If you enter the PIN-code correctly, you will have access to the service menu.
 - ⇒ If the PIN-code is entered incorrectly, you will be returned to the Extras menu.

9.2. Default settings

The analyzer is reset to the default settings.



NOTE

With the default settings, all individual settings are lost.

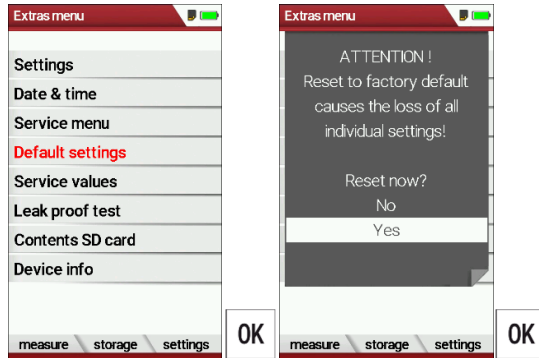

► Go to the Extras menu.

- Select Default settings.
- Press OK.
 - ⇒ A window appears.
- Select "No" to not reset the default settings.
- Select "Yes" to reset the analyser to default settings.
- Drücken Sie OK.
- Press OK.
 - ⇒ Depending on the selection, the analyser is reset to the default settings or not.

9.3. Service values

Should your analyser display an error message after zeroing (for example: „O2-Sensor not OK"), then you can use the Service value menu to get detailed information about possible defects. In this menu you will see all service values of the sensors and also other parameters.

In case of a defect contact the MRU service department. The MRU service technician will ask you about these values or he will ask you to send them by fax or email.

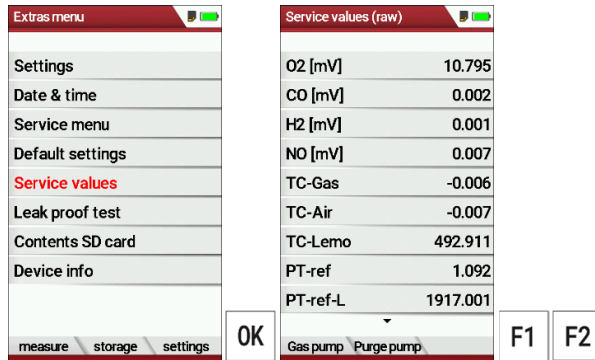

- ▶ Go to the Extras menu.
- ▶ Select Service values.
- ▶ Press OK.
 - ⇒ The Menu Service values appears.
- ▶ If necessary, press F1 to switch on the function test of the Gas pump
- ▶ If necessary, press F2 to switch on the function test of the Purge pump.
- ▶ Press OK.
 - ⇒ A window for entering the Pin-Code appears.



NOTE

For the PIN code, contact an MRU service center (www.mru.eu)

- ▶ Enter the Pin-Code.
 - ⇒ The selected function test is switched on or off.

9.4. Performing leak test

During the leak test, the system (including the condensate separator) is checked for leaks by the analyzer. For this purpose, the internal gas pump generates a vacuum which is measured by the built-in tension sensor and observed over a period of 10 seconds. Based on the size of the observed pressure drop, the leak tightness of the system is determined.

Operation:

- ▶ Put the leak test cap # 61382 (for probe tubes Ø 8 mm) onto the probe tip.



NOTE

With dirt and soot on the probe tube the test cap will not seal properly.

- ▶ Clean the probe tube before starting the leak proof test.

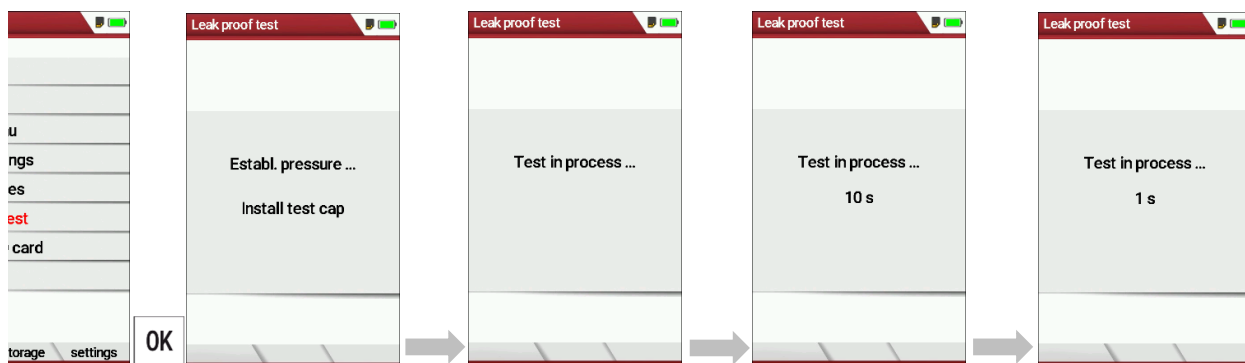

- ▶ Go to the Extras menu.
- ▶ Select Leak proof test.
- ▶ Press OK.
 - ⇒ The menu Leak proof test appears.
- ▶ Ensure that the leak test cap is plugged on.
 - ⇒ Pressure is established.
 - ⇒ A 10-second test is running.
 - ⇒ A message appears whether the leak proof test was passed or not.
- ▶ Remove the proof test cap.

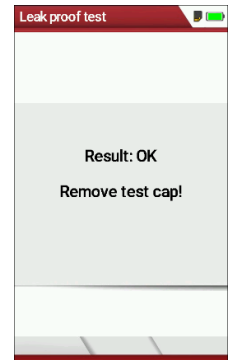

If the leak proof test is not passed, you must check the probe including the tubing and the condensate separator.

If no leakage is detected on these external parts, the analyzer has to be checked service center (service centers at www.mru.eu).

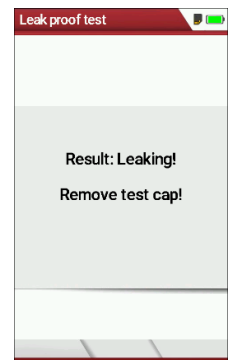

9.5. Contents SD card

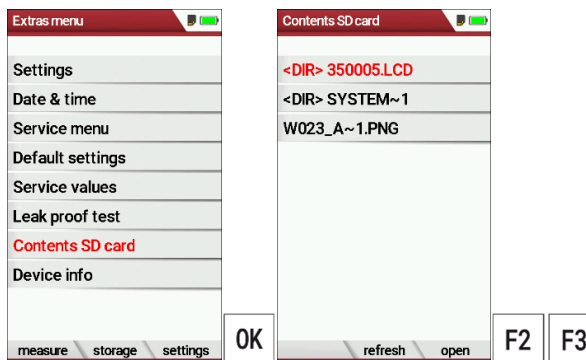

- ▶ Go to the Extras menu.
- ▶ Select Contents SD card.
- ▶ Press OK.
 - ⇒ The menu Contents SD card appears.
 - ⇒ The files stored on the SD card are displayed.
- ▶ If necessary, press F2 to refresh.
- ▶ If necessary, press F3 to open the file.

9.6. Device info

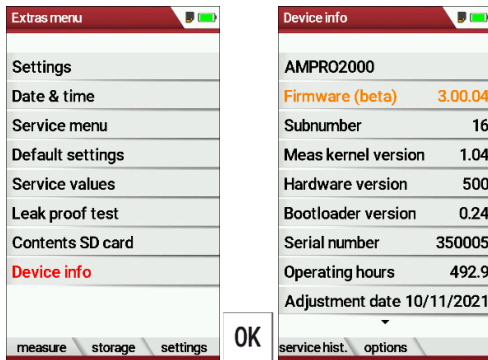

- ▶ Go to the Extras menu.
- ▶ Select Device info.
- ▶ Press OK.
 - ⇒ The menu Device info appears.
 - ⇒ Information about the analyzer is displayed, for example serial number and firmware version.

Options list

- ▶ Go to the Extras menu.
- ▶ Select Device info.
 - ⇒ The menu Device info appears.
- ▶ Press F2.
 - ⇒ The menu Options list appears.

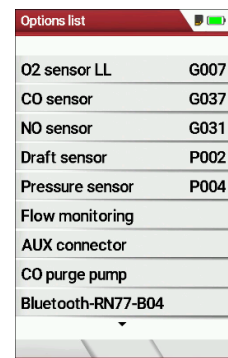

Service history

- ▶ Go to the Extras menu.
- ▶ Select Device info.
 - ⇒ The menu Device info appears.
- ▶ Press F1.
 - ⇒ The menu Service history appears.
 - ⇒ Information about the date of the last seven service operations appears.

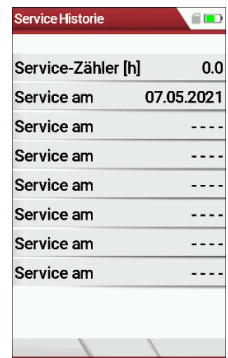

10 Option: Solid fuel measurement

The Solid fuel measurement allows the measurement of solids such as dry wood, coal and pellets.

With this option, a special CO sensor for solids measurement is also installed. During the measurement, the other CO sensor is purged.

The following symbol also appears in the display 

Especially when burning wood or coal, larger amounts of moisture or dust may be present in the exhaust gas.

In order to protect the analyzer from these substances, we strongly recommend the use of the solid filter unit # 11153, in which the sample gas is cleaned via Purafil, activated carbon as well as silica gel before it enters the analyzer.

Perform Solid fuel measurement

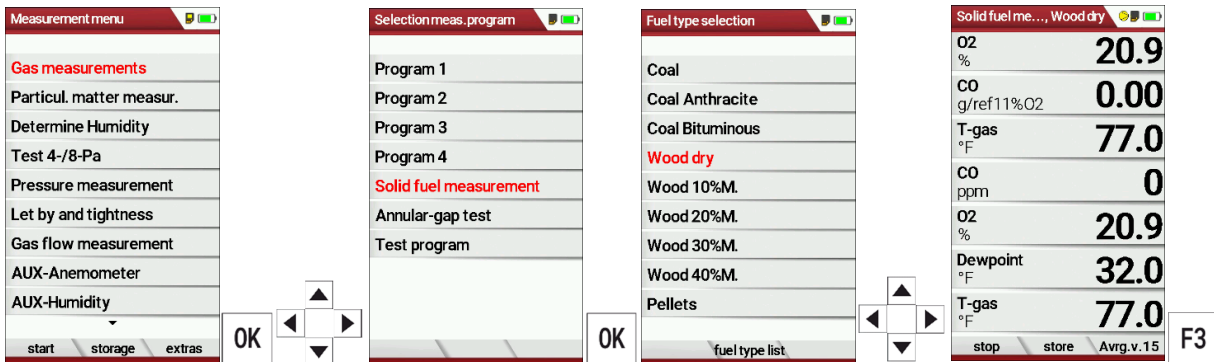

- ▶ Select Gas measurements.
- ▶ Press OK.
 - ⇒ The menu Selection meas. Program appears.
- ▶ Select Solid fuel measurement.
- ▶ Press OK.
 - ⇒ The menu Fuel type selection appears.
- ▶ Select the desired fuel.
- ▶ If necessary, add fuels from the fuel type list to the menu Fuel type selection.
 - ☞ See also chapter Add fuels to fuel type selection, Page 31.
- ▶ Press OK
 - ⇒ The measurement is started.
- ▶ If necessary, press the menu key to configure the measurement window according to your needs.
 - ☞ See also chapter 5.12 Define measurement window., Page 34.

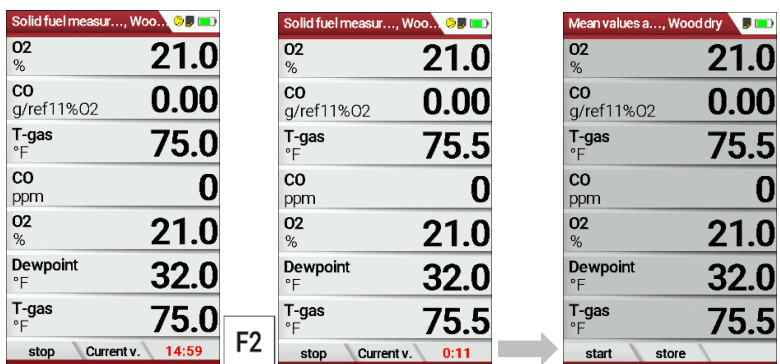

► Press F3.

- ⇒ The 15 minutes averaging starts.
- ⇒ A 15-minute countdown is shown in the display

► If necessary, press F2 to switch between the average values and the current values.

- ⇒ After the 15-minute countdown has elapsed, averaging stops automatically.
- ⇒ The measured value window is grayed out.
- ⇒ The average values are displayed.

► Press F2 to store the measurement.

☞ See also chapter 7.5 Store measurement values, Page 50.

Filter unit for Solid fuel measurement (# 11153)

This filter unit serves as additional protection of the analyzer.

Particularly with the combustion of wood or coal aggressive components can be present in unknown quantities quantity just like larger quantities of humidity or dust in the fuel gas!

This filter unit is switched during the solid measurement before the measuring instrument: That means, the hose of the probe is attached to the inlet of the filter unit. The hose, which is provided with the filter unit serves as connection between the outlet of the filter unit and the inlet of the condensate trap.

There the Purafil, which is in the filter unit, absorbs NOX, this measurement as well as the filter unit is not possible.

Activated charcoal (Part no. 60827 / 1 package = 100 g inclusive. 2 filter tabs.)

The use of activated charcoal is usually for cleaning of water and air of organic pollutants. New activated charcoal is made of hard coal, brown coal, peat or coconut bowls. After the loading ability is exhausted, the activated charcoal is exchanged.

Silica gel (Part no. 60826 / 1 package = 100 g inclusive 2 filter tabs)

Silica gel extracts the moisture from the sucked gas. After the loading capacity is exhausted, the granules are replaced.

Purafil (Part no. 60825 / 1 package = 100 g inclusive 2 filter tabs)

Purafil extracts portion from the sucked in gas the NO. In the course of the time the granulate changes the color to dark brown until black. A light brown to middle brown color of the granulate will not reduce the efficiency of the filter. A worn filter can still be used, but the SO_x and NO_x gases can reach the CO sensor, that can reduce the life span of the CO sensor enormous.

Operation of the solid filter unit:

The solid filter unit must be operated in a standing (hanging) position. There is a bending fold on the back of the unit to be able to hang the unit at the measuring point.

The condensate separator must be discharged after each measurement and opened for drying

Liquid discharged from the condensate separator may be slightly acidic.

In case of skin contact, clean affected areas immediately.

Do not bring any liquid into the eyes.

Carefully clean all parts that come into contact with the condensate.

Maintenance

The star filter (no. 11165) has to be replaced when grey/brown discoloration. With the change is to be paid attention to close seat of the hose.

This filter is washable and approx. 4 - 5 times thereafter applicable.

Since neither with the activated charcoal, nor with the silicagel the loading ability can be optically determined, the granulate at least 1 x are to be renewed annually. Take the filters for the renewal of the granulate out of the clips, which remove hoses and take a plug off. Remove the old granulates inclusive two filter tabs, clean the filter glass and the plugs, use a new filter tab, fill in new granulates, use second filter tab, plugs imprint, in Clammy ones begin and after the following design.

For this work protective clothing carry, granulates can be weakly acid! The old granulates is special refuse!

MRU commits itself to take all special refuse parts back, which cannot to be disposed on the "normal" way, supplied by us.

The return must take place for us free of charge

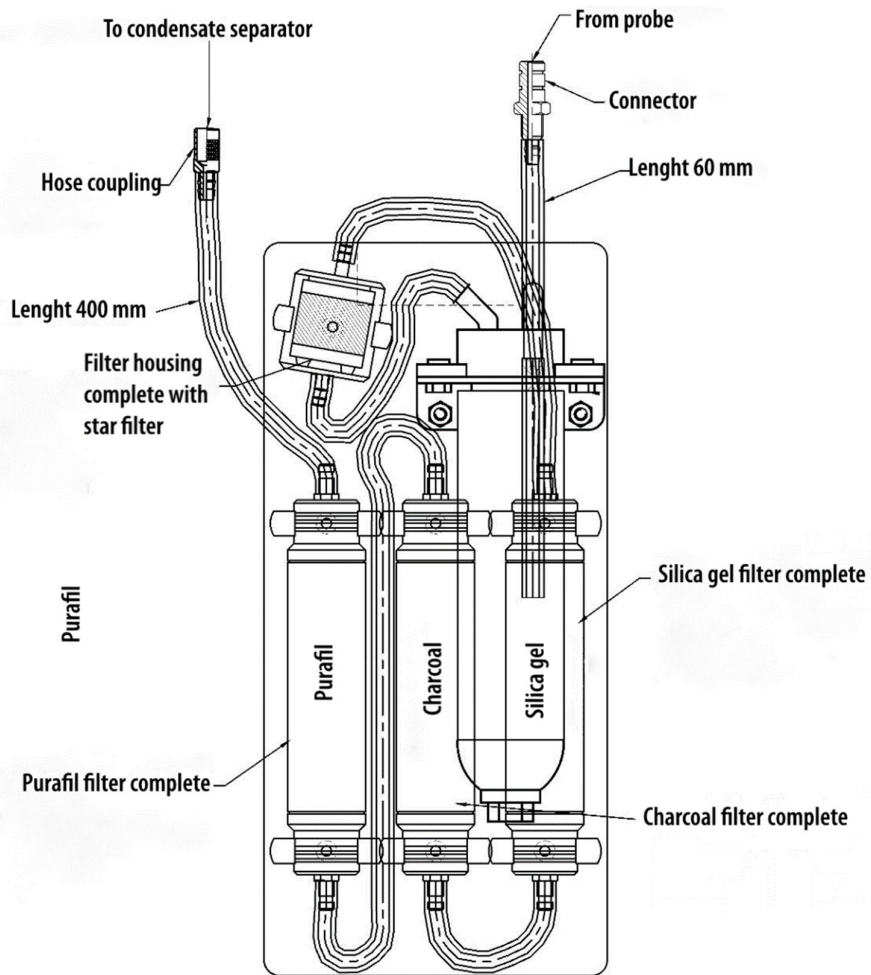

11 Option: Humidity measurement with hygrometer

With the optionally available hygrometer you can determine the relative humidity (%), the dew point and the temperature.

The hygrometer is connected to the AUX-connector of the analyzer via a SMARTplus adapter.

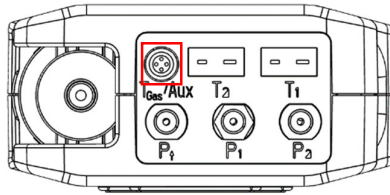

- ▶ Plug the corresponding connector of the SMARTplus adapter into the AUX-connector of the analyzer. Ensure that the red markings on the plug and the AUX-connector match.
- ▶ Insert the connector plug of the hygrometer into the corresponding connector of the SMARTplus adapter.
- ▶ Remove the cover cap from the hygrometer before measuring.

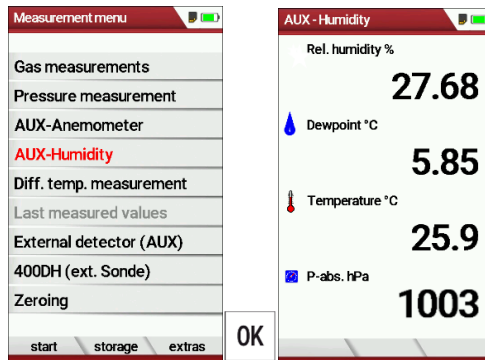

- ▶ Go to the Measurement menu.
- ▶ Select AUX-Humidity.
- ▶ Drücken Sie OK.
- ▶ Press OK.
 - ⇒ Das Menü AUX-Feuchtemessung erscheint.
 - ⇒ The menu AUX-Humidity appears.

12 Option: Leak detection (external HC probe)

The external HC probe is used for leak detection on gas pipelines in non EX environment.

The external HC probe is used to locate CH₄ (methane).

The measuring range of the HC probe is 5-20,000 ppm

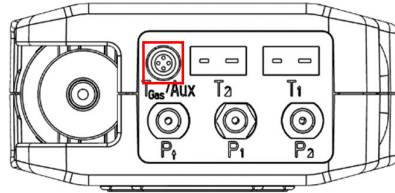

- ▶ Connect the external HC probe to the analyzer via the AUX connector. Ensure that the red markings on the plug and the AUX-connector match.

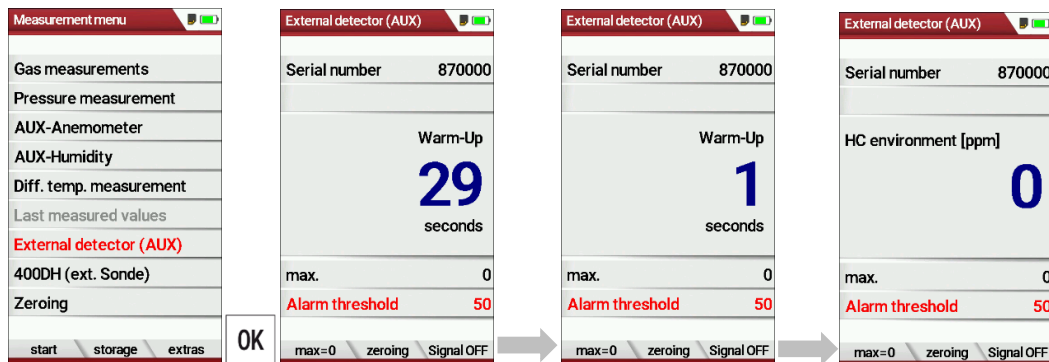

- ▶ Go to the Measurement menu.
- ▶ Select External detector (AUX).
- ▶ Press OK.
 - ⇒ The menu External detector (AUX) appears.
 - ⇒ A Warm-phase starts.
 - ⇒ After the warm-up phase has been completed, you can start the leak detection.

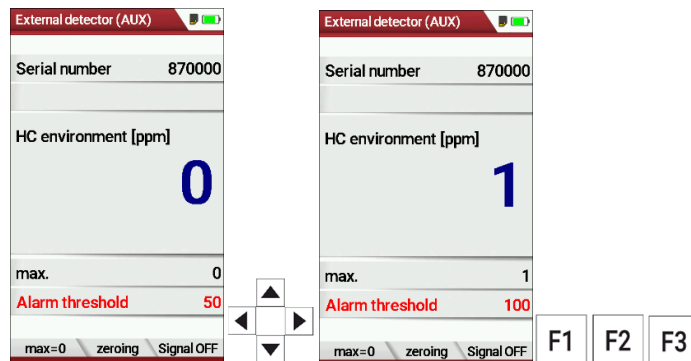

- ▶ Set the desired alarm threshold.
- ▶ If necessary, press F2 to take a zero point.
- ▶ If necessary, press F3 to switch on an acoustic alarm.
 - ⇒ If activated, an acoustic alarm signal sounds as soon as the measured HC environment [ppm] exceeds the value of the set alarm threshold.
- ▶ Guide the tip of the probe slowly along the areas to be tested.
 - ⇒ In the case of a leakage, the value of the HC environment [ppm] changes.
 - ⇒ If activated, an acoustic alarm signal sound.
- ▶ If necessary, press F1.
 - ⇒ The currently measured value is taken over in the line max=0
- ▶ If necessary, press the Printer key to create a printout of the measurement.
 - ☞ See also chapter 7.6 Print measurement values, Page 52.

NOTE**Maintenance**

When using the unit just for leak detection the HC detector can be checked using test gas.

We recommend however to calibrate the HC detector once a year to have lasting accurate results.

13 Option: Flow measurement with vane / anemometer

With the optionally available vane wheel/anemometer you can measure the flow velocity.

The vane / anemometer is connected to the AUX-connector of the analyzer via a SMARTplus adapter.

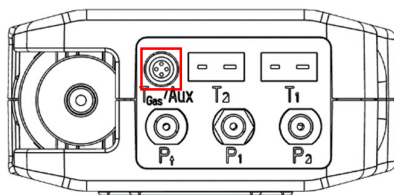

- ▶ Plug the corresponding connector of the SMARTplus adapter into the AUX-connector of the analyzer. Ensure that the red markings on the plug and the AUX-connector match.
- ▶ Insert the connector plug of the hygrometer into the corresponding connector of the SMARTplus adapter.

13.1. Open menu Aux-Anemometer

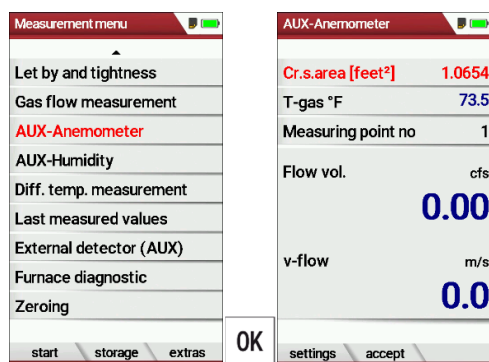

- ▶ Go to the Measurement menu.
- ▶ Select AUX-Anemometer.
- ▶ Drücken Sie Ok.
- ▶ Press OK.
 - ⇒ The menu AUX-Anemometer appears.

13.2. Set units and cross section area

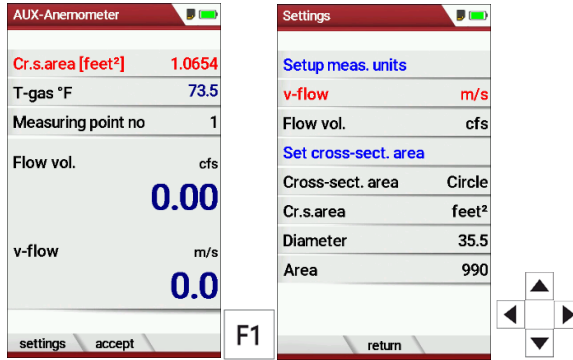

▶ Press F1.

⇒ The menu Settings appears.

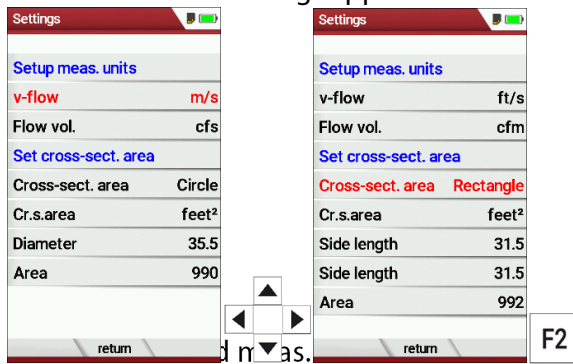

▶ Set the desired cross section area.

▶ Geben Sie die gewünschten Seitenlängen/ Durchmesser ein.

▶ Enter the desired lengths/diameter.

NOTE

Note that there are two ways to perform the measurement

- You enter the cross section of the flow channel by entering the cross-section area (circle, rectangle or square) and its dimension
- You use a volume flow hood. For this purpose, select the section area cone. There is no need to specify dimensions. The vane/anemometer is attached to the hood (observe flow direction) and the hood is placed on the inlet or outlet of the flow channel.



▶ Press F2.

⇒ The menu AUX-Anemometer appears.

13.3. Perform measurement

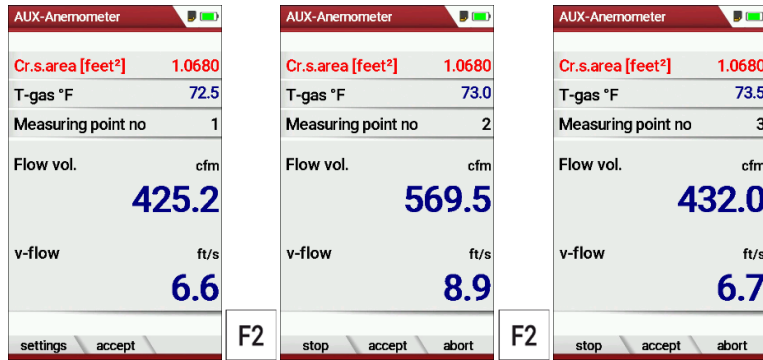

- ▶ Perform the measurement for measuring point no. 1.
- ▶ Press F2 as soon as the measurement for Measuring point no. 1 is finished.
 - ⇒ The measured values for measuring point no. 1 are accepted.
 - ⇒ Measuring point no. 2 appears in the display.
- ▶ If necessary, perform measurements for additional measuring points and accept the measured values with F2. The measuring point no. is correspondingly up-counted.
- ▶ Press F1.
 - ⇒ The measurement is stopped.
- ▶ If necessary, press the Printer key to create a printout of the measurement.
 - ☞ See also chapter 7.6 Print measurement values, Page 52.

14 Option: Monitoring flow rate

The flow rate is continuously monitored. In the event of an error, the following message appears in the display:

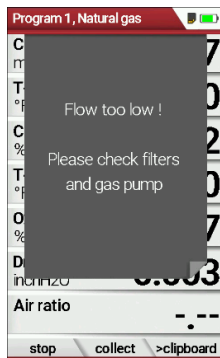

If the flow rate is too low, this message is displayed every 8 seconds.
Folgende Fehler können die Ursache sein:

- Filter clogged
- Hose line kinked
- Pump defective

It is recommended to check the filter elements.
If these filter elements are OK, please contact the customer service.

15 Option: Auto-measurement

With the automatic measurement option, the analyzer can log continuous measurements independently. You can largely adapt the properties of the automatic measurement to your individual requirements. The data is stored in the internal data memory and can then be transferred to the SD card.

As the size of the data memory is limited, the ratio between total duration and interval is also subject to certain limits if the automatic measuring system is to store values in the data memory. The analyzer displays the required memory.

If the required memory is too high, reduce the measurement duration or increase the interval to minimize the required memory.

If there is not enough free memory available, delete the measuring data memory.

When starting a measurement, the Auto-measurement is switched off in principle. You must consciously activate the Auto-measurement via the menu key.

- ▶ Start a gas measurement.

☞ See also chapter 7.1 Perform Gas measurement, Page 40.

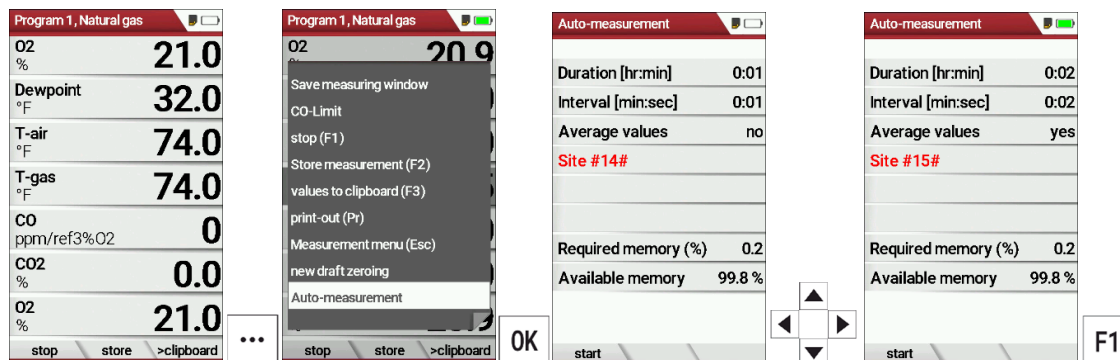

- ▶ Press the menu key.
 - ⇒ A selection list appears.
- ▶ Select Auto-measurement.
- ▶ Press OK.
 - ⇒ The menu Auto-measurement appears.
- ▶ Set the desired values and select the desired site.



NOTE

Setting Average values:

Yes: Analyzer calculates the mean during each interval and stores this value.

No: Analyzer stores the values being measured at the end of the interval.

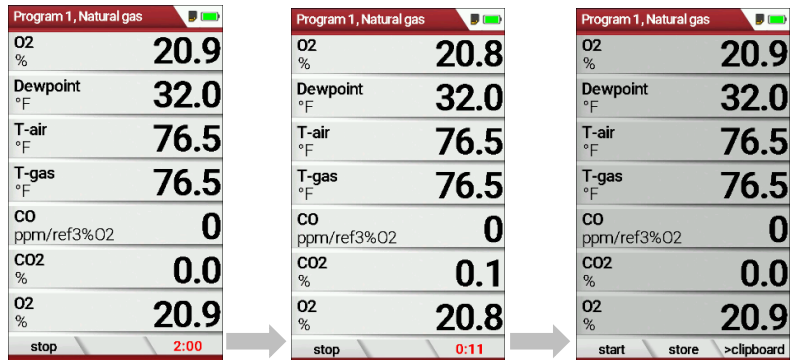

- ⇒ The measurement starts.
- ⇒ The display shows the remaining time of the measurement.
- ⇒ After the set measuring time has elapsed, the measurement stops automatically.
- ▶ Press F2, to store the measurement.
 - ☞ See also chapter 7.5 Store measurement values, Page 50.
 - ☞ For exporting measurements see also chapter Export measurements, Page 64.

16 Appendix

16.1. Technical data

General data	
Operating temperature	+5°C ... +45 °C / +41°F ... +113 °F
Rel. Humidity, non-condensing	95%
Storage Temperature	-20°C - +50°C / -4°F ... 122° F
Internal Battery Pack, operating hours (typical)	Li-Ion, 20h
Power supply	100 - 240 V / 5V DC / 1.200 mA
Weight with 2 sensors	750 g / 1.65 lbs.
Size	244 x 113 x 54 mm / 4.3x 8.8 x2.04 in
Housing material	PA6
IP protection with protection cap	IP30
Max suction range gas pump	150 hPa
jd v i a r z w s l	50 l/h
Measured values	
Electrochemical Sensor	
O₂	
Measuring Range	0..21 %
Resolution	0,1 %
Abs. Accuracy	± 0,2 Vol.%
Response Time T90	< 20s
Years expected lifetime (@air)	2
FR _s tolerance	20 Vol.%
Elektrochemischer Sensor	
O₂ Long Life	
Messbereich	0- 21 Vol.%
Auflösung	0,1 %
Genauigkeit abs.	± 0,2 Vol.%
Ansprechzeit T90	< 20s
Jahre erwartete Lebensdauer an Luft	3
CO ₂ tolerant bis	100 Vol.%
Elektrochemischer Sensor	
O₂ Very Long-Life	
Messbereich	0 – 21 Vol.%
Auflösung	0,1 Vol.%
Genauigkeit abs.	± 0,2 Vol.%
Ansprechzeit T90	< 20s
Jahre erwartete Lebensdauer an Luft	4
CO ₂ tolerant bis (erfordert Erholungszeit von der zweifachen Beaufschlagungszeit für CO ₂ > 20 Vol.%)	100 %
Elektrochemischer Sensor	
CO	
H ₂ - kompensiert	
Nominaler Messbereich	0 - 10000 ppm
Überlastbereich	< 20000 ppm

Auflösung	1 ppm
Genauigkeit absolut / vom Messwert	± 10 ppm
	5% (0 – 4000 ppm)
	10% (> 4000 ppm)
Ansprechzeit T90	< 40s
Elektrochemischer Sensor	
	CO high (Option #63057, # 63295)
Nominaler Messbereich	0 - 4000 ppm
Überlastbereich	< 20000 ppm
Auflösung	1 ppm
Genauigkeit absolut / vom Messwert	± 10 ppm /
	5% (0 - 4000 ppm)
	10 % (> 4000 ppm)
Ansprechzeit T90	< 40s
Elektrochemischer Sensor	
	NO (Option #63058)
Nominaler Messbereich	0 - 1000 ppm
Überlastbereich	< 5000 ppm
Auflösung	1 ppm
Genauigkeit abs. /vom Messwert	± 5ppm
	5% (0 - 1000 ppm)
	10% (> 1000 ppm)
Ansprechzeit T90	< 30s
Temperaturmessung	
	T1, T2
Anzahl der Thermoelement Typ K - Eingänge	2
Messbereich	-40 °C - 1200 °C
Genauigkeit abs. / vom Messwert	±2°C/
	0,5%
Abgastemperatur (mit MRU-Sonde)	
	T_A
Messbereich mit Gasentnahmerohr aus Edelstahl	0 - 800°C
Messbereich mit Gasentnahmerohr aus Inconel	0 - 1100°C
Genauigkeit abs. / vom Messwert	±2°C/
	0,5%
Verbrennungslufttemperatur	
	T_i
(mit MRU Fühler)	
Messbereich mit Verbrennungsluftfühler	0 - 100°C
Genauigkeit abs.	1 °C
Genauigkeit abs. /vom Messwert	±1°C
Kaminzug	
Messbereich	± 100 hPa
Genauigkeit abs. / vom Messwert	0,02 hPa /
	1%

Differenzdruck	
Messbereich	± 100 hPa
Genauigkeit abs. / vom Messwert	0,02 hPa oder 1%

Berechnete Werte	
CO₂	
Messbereich (Brennstoffabhängig)	0 - CO ₂ max
Genauigkeit abs.	± 0,3 Vol. %
Lambda (Luftverhältniszahl)	
Messbereich	1 - 20
Luftüberschuss	
Messbereich	0 - 999%
GI (Giftindex)	
Messbereich	0.0001 - 10.0
Taupunkt	
	°C
Abgasverlust qA	
Messbereich	0 - 99,9%
Wirkungsgrad	
Messbereich	0 - 120%
Messwerte darstellbar als	Mg/Nm ³
	O ₂ Ref
	mg/kWh
	NO _x : mg/Nm ₃ NO ₂

16.2. Analyse und Berechnung

Kontinuierliche Umrechnungen zu CO	CO
[ppm] bez. auf 0% Rest O ₂ (unverdünnt)	X
[ppm] bez. auf brennstoffabhängigen O ₂ Bezugswert	X
[mg/m ³]	X
[mg/kWh]	X
[mg/MJ]	X
[mg/m ³] bez. auf brennstoffabhängigen O ₂ Bezugswert	X

Kontinuierliche Umrechnungen zu NO	NO
[ppm] bez. auf 0% Rest O ₂ (unverdünnt)	X
[ppm] bez. auf brennstoffabhängigen O ₂ Bezugswert	X
[mg/m ³]	X
[mg/kWh]	X
[mg/MJ]	X
[mg/m ³] bez. auf brennstoffabhängigen O ₂ Bezugswert	X

Weitere kontinuierlich berechnete Messgrößen	Einheit
CO ₂	[%]
ETA	[%]
ETA kondensiert	[%]
Verluste	[%]
Verluste kondensiert	[%]
Lambda	-
Taupunkt	[°C]
CO / CO ₂ ratio	[%]

16.3. Brennstofflisten

Deutschland				O2 bez			
Brennstoff (*)	CO2max	A2	B	O2 ref	Fw	CO_kWh	ETAcond fact
Messgas	0,0	0,00	0,000	3	0	0	1000
Erdgas BlmSchV	11,8	0,66	0,009	3	57	8730	1110
Erdgas L	11,8	0,66	0,009	3	57	8730	1110
Erdgas H	12,1	0,64	0,009	3	57	8730	1110
Heizöl EL	15,4	0,68	0,007	3	111	8820	1060
Bio-Diesel	15,7	0,62	0,005	3	0	0	1000
Propan	13,7	0,66	0,007	3	77	8419	1090
Butan	14,1	0,67	0,007	3	77	8269	1080
Flüssiggas P/B	13,7	0,63	0,008	3	77	0	1090
Holz trocken	20,3	0,62	0,009	13	91	0	1000
Pellets	20,3	0,77	0,000	13	0	0	1000
Torf	19,8	0,70	0,010	7	0	0	1000
Steinkohle	19,4	0,65	0,009	13	0	0	1000
Braunkohle	19,1	0,65	0,009	13	0	0	1000
Scheitholz	20,3	0,62	0,009	13	91	0	1000
Holzhackschnitzel	20,3	0,62	0,009	13	91	0	1000

(*) – nicht enthalten, kann bei Bedarf mit den in der Tabelle angegebenen Werten unter Selbstwahlbrennstoff angelegt werden.

Brennstofflisten für weitere Länder erhält man auf Anforderung:
info@mru.de

16.4. Messgerät resettet

Falls das Messgerät nicht mehr reagiert, können Sie einen Reset durchführen.

- ▶ Drücken Sie die ESC-Taste und die EIN/AUS-Taste gleichzeitig.

16.5. Fehlerbehandlung

Fehlerdiagnosen am Messgerät

Auswirkung	Fehler	Ursache	Lösung
Gerät zeigt keine Reaktion		Gerät reagiert auf keine Touchbedienung.	ESC und Power-ON Tasten gleichzeitig betätigen
Unterkühlung im Geräteinnern, das Gerät ist nicht einsetzbar.	Displayanzeige: "Gerät zu kalt" oder Piepston alle 5 Sek.	z.B. Gerät im Winter im Kofferraum.	Bei Unterkühlung das Gerät in einen warmen Raum stellen. Warten.
Messwerte nicht korrekt	Nullpunktnahme-Fehler	Sensoren werden bei der Kalibration bereits mit Gas beaufschlagt.	Gerät bitte mit Frischluft spülen und neu einschalten.
Gerät lässt sich nicht einschalten oder reagiert nach Einschalten nicht mehr.		Akkukapazität erschöpft.	Gerät ans Netz anschließen dabei wird der Akku aufgeladen.
Messung ohne genaue Temperaturwerte.	Temperaturanzeige: ---, - °C	Thermoelement defekt, Ausgleichsleitung unterbrochen o. nicht angeschlossen	Anruf bei unserem Kundendienst. Sonde aus Abgasrohr und Kondensat von Sondenrohr entfernen.
falsche Gasmesswerte	Messbereichsüberschreitung: O ₂ -Wert zu hoch, CO- und CO ₂ -Wert zu nieder.	Verbindung Sonde-Gerät nicht ordnungsgemäß, Undichtheit bei Sonde / Schlauch / Kondensatabscheider, Pumpe saugt nicht richtig.	Dichtheitstest durchführen. Durch Sichtkontrolle von Sonde, Schläuche, Kondensatabscheider evtl. undichte Stelle auffindbar.
falsche Temperatur - Messwerte	Gastemperatur zu hoch oder springt	Sondenstecker nicht richtig gesteckt Kabelbruch in der Sondenleitung, Kondensatbildung an der Sondenspitze.	Sondenstecker bzw. Sondenleitung auf Bruchstellen (Wackelkontakt) überprüfen, Kondensat an der Sondenspitze abschütteln.

Fehlerdiagnosen Kondensatabscheider

1. Auswirkung	2. Ursache	3. Lösung
Schmutz und / oder Feuchtigkeit im Geräteinnern keine Filterwirkung Ausfall der Sensoren Ausfall der Pumpe	Schmutzige und / oder nasse Feinfilter.	Filter öfters überprüfen ggf. austauschen (weiß = O.K. braun-schwarz = erneuern)
falsche Messergebnisse	Deckel, Mittelstück, Plexiglasrohr und Verschlussstopfen sind nicht dicht verschlossen bzw. verschraubt.	Bei jedem Filtertausch auf Dichtigkeit überprüfen.

16.6. Update firmware

Check current firmware version

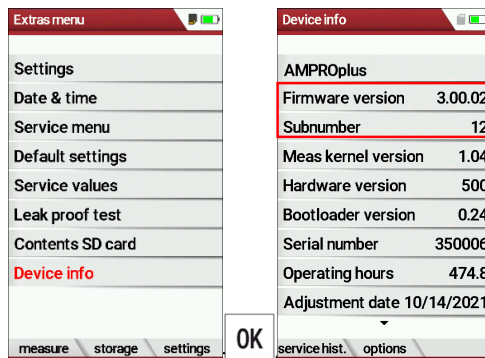

- ▶ Select Device info.
 - ⇒ The menu Device info appears.
 - ⇒ The current firmware version appears. In this example, the firmware version is 3.00.02.

In case there are any problems with updating the firmware, we need some information from you.

- ▶ Write down the current Firmware version.
- ▶ Write down the Serial number.

Prepare SD card

If you have not received the new firmware on an SD card, but for example by e-mail, you must copy the file "All 1122.fwb" to the root directory (not to a subdirectory) of the SD card. You may have received this file packed in a ZIP file. Unpack the file before you copy the file to the SD card.

Perform firmware update

- ▶ Copy the file "All 1122.fwb." to an SD card into the main directory (not into any subdirectory).
- ▶ Switch on the analyzer.
- ▶ Wait until the zero-point measurement is finished.
- ▶ Insert the prepared SD card into the analyzer
 - ⇒ A message appears.

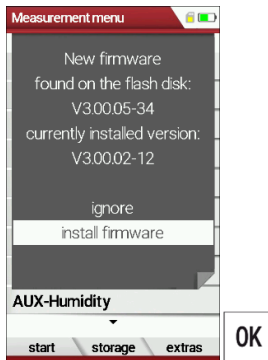

- ▶ Select install firmware.
- ▶ Press OK.
 - ⇒ The update is performed.
 - ⇒ After the update has been performed, a message appears.

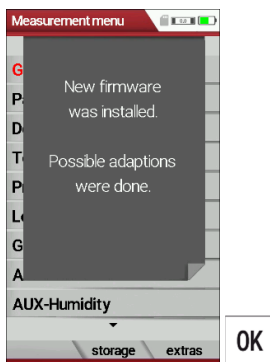

- ▶ Confirm the message with OK.
- ▶ Switch the analyzer off again after the successful update.
 - ⇒ All functions are available the next time the analyzer is switched on.

Check new firmware version

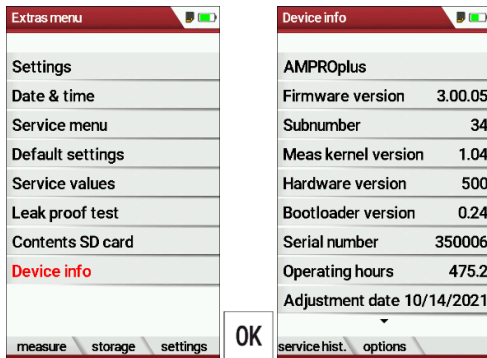

- ▶ Go to the Extras menu.
- ▶ Select Device info.
- ▶ Press OK.
 - ⇒ The menu Device info appears.
 - ⇒ The new Firmware version is displayed.
- ▶ Repeat the update process if the old firmware version is still displayed.

In case of error

What to do if there were problems during the update?

In the event of an error, the red LED of the condensate separator flashes.

The inserted SD card was then not recognized.

(Check whether the SD card is inserted correctly and perform a reset by pressing the ESC and ON keys simultaneously).

Where can I get help if the update was not successful?

Contact your local sales representative or via email:

Email: info@diamondsci.com

17 Konformitätserklärung

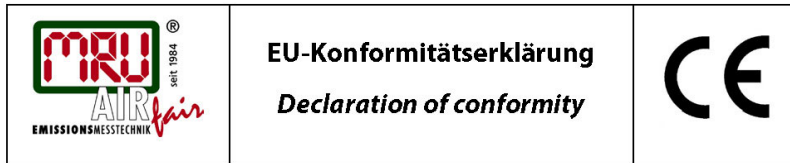

MRU Messgeräte für Rauchgase und Umweltschutz GmbH

Bevollmächtigte Person, für die Zusammenstellung der technischen Unterlagen
Person authorized to compile the technical documents.

Name / name:	Dierk Ahrends
Funktion / function:	QM-Beauftragter / QM-Representative
Firmenname / company:	Messgeräte für Rauchgase und Umweltschutz GmbH
Straße / street:	Fuchshalde 8 + 12
Ort / city:	74172 Neckarsulm
Land / country:	Deutschland / Germany

Produkt/Product

Bezeichnung / designation:	Gasanalysator Gas analyser
Produktname / name:	SPECTRAplus „Modell 1122“
Funktion / function:	Gasanalyse / gas analysis

Hiermit erklären wir, dass das oben beschriebene Produkt allen einschlägigen Bestimmungen entspricht, es erfüllt die Anforderungen der nachfolgend genannten Richtlinien und Normen:

We declare the conformity of the product with the applicable regulations listed below:

- EMV-Richtlinie / *EMV-directive* 2014/30/EU
- Niederspannungsrichtlinie / *low voltage directive* 2014/35/EU
- RoHS-Richtlinie / *RoHS directive* 2011/65/EU (RoHS II)

Neckarsulm, 02.02.2021



Erwin Hintz, Geschäftsführer / *Managing Director*

Distributed by:



625 Peachtree Street
Cocoa, FL 32922
Phone: 1-321-223-7500



info@diamondsci.com
www.DiamondSci.com

