

audioquest®

**EURO RETAIL
PRICE BOOK**

NOVEMBER 1, 2021

TABLE OF CONTENTS

USB Digital-Audio Converters

DragonFly DACs	7
JitterBug FMJ USB Noise Filter	7
USB Extenders and Adaptors	7

AC Power

Power Conditioners	9
Power Cables	11–13
Power Plugs	12
Adaptors	14
Fog Lifters (Cable Risers)	14

Speaker Cables

Q2	18
Type Series	18
Rocket Series	19
Folk Heroes	20–21
Mythical Creatures	22–24
Bi-Wire Jumpers	25
Fog Lifters (Cable Risers)	25

Analog-Audio Interconnect Cables

Bridges & Falls	27
Rivers & Elements	28
Mythical Creatures	29

Subwoofer Cables

30

Tonearm Cables

31

Vinyl Accessories

GroundGoody Tonearm & Ground Wires	33
Record Brushes	33

Headphone Accessories

Headshell Leads	33
NightBird Headphone Cable	33
Headphone Plug Adaptor	33
Headphone Stand	33

HDMI Cables

8K (48Gbps)	36
4K (18Gbps) Long-Distance	37
8K (48Gbps) eARC-Priority	37
Adaptors, Coupler	38

Digital-Audio Interconnect Cables

USB Cables and Adaptors	40–41
Optical Cables and Adaptor	42
Digital Coax Cables and Adaptor	43
AES/EBU Cables	44
Ethernet Cables (RJ/E)	45

Accessories

DBS Pack	46
Q-Feet System	46
Sorbothane Self-Stick Sheet	46
CleanScreen	46
Adaptors, Splitters, Couplers	47
Antenna Cable	47
RCA, XLR, Coax	
Plugs and Connectors	48
Silver Solder	48
Noise-Stopper Caps	49

Analog-Audio Interconnect Accessories

Adaptors, Splitters, Couplers	50
PreAmp Jumpers	50

Instant Tool-less Connectors (ITC)

Cable Stripper	51
Bulk Cables	51
Connectors	51

Bulk Speaker Cables (Spools)

In-Wall Rated Speaker Cables	52
Not-Rated Speaker Cables	53
SureGrip® Speaker Connectors	54
Spade, Pin, and Banana Connectors	55
Termination Pants	55
Bind-Posting Wrench	55

Bulk Analog-Audio Cables (Spools)

In-Wall Rated Analog-Audio Cables and Connectors	56
--	----

Bulk Ethernet Cables (Spools)

CAT6 and CAT7 Cables and Connectors	57
-------------------------------------	----

Installer Packs

Cables, Splitters and Adaptors in Single, Packs of 5 and 10	58-59
---	-------

POP Materials

Wall Signs, Tent Card, Window Sticker	60
Spool Holder	60
In-Store Display Racks	60

Promotional Items

Polo, T-shirt,	61
Baseball Cap, Beanie	61
Pen	61
Water Bottle	61
License Plate Frame	62
Backpacks, Tote Bag	62

Terms and Conditions

- Prices are subject to change without notice.
- All prices are in Euro.
- As used throughout this price book, "Retail" carries the same meaning as Suggested Retail Price (SRP).

Returns

- All returns are subject to approval by AudioQuest.
- Built-to-order products may not be returned.
- All sales are final for custom speaker cables produced at 2m or less.
- A Return Merchandise Authorization (RMA) number must be issued by AudioQuest before any product may be returned.
- The RMA number must appear on the outside of the shipping carton, near or on the address label.

Contact Information

AudioQuest
Hoge Bergen 10
4704 RH Roosendaal
The Netherlands
www.audioquest.com
Tel: +31 165 54 1404

Email orders and related correspondence: orders@audioquest.nl

Email all other correspondence to: info@audioquest.nl

Copyright © 2021 AudioQuest.

All rights reserved.

E & OE. In the interests of continuous product improvement, all specifications are subject to change without notice.

AudioQuest: Doing No Harm Since 1980



William (Bill) Low
Founder / CEO

For 40 years now, AudioQuest, headquartered in Irvine, California, has been a leading developer, manufacturer, and distributor of high-performance audio/video products and custom-install solutions. Although best known for our comprehensive range of analog, digital, and AC power cables, our portfolio has expanded to a diverse assortment of products, including the multi-award-winning DragonFly DACs, and Niagara and PowerQuest power products.

Our ultimate goal is the same today as it was 40 years ago: Do No Harm! By this we mean that all cables and components, to the extent that is technologically feasible, should get out of the music's way by inducing the least amount of noise and distortion.

The Evolution Continues: The Four Elements Today

While minimizing noise and damage to the audio signal remains the North-Star constant, the ways in which we engage these challenges always evolves. While there are still Four Elements that describe our foundational materials and design philosophies, a growing number of technologies cross and even go beyond our original Four Elements. Many have become crucial enough to demand visibility. Noise-Dissipation is an umbrella Element under which many of these meaningful techniques and technologies will reside. While Geometry is no longer identified as one of The Four Elements, it remains inextricably tied to all other Elements of cable design and manufacture.

Solid Conductors: Strand interaction remains the biggest potential source of distortion in cables. Solid Conductors are the aspirational ideal and most complete solution to this problem. However, thoughtfully arranged multi-conductor geometries such as concentric windings are used to create our Semi-Solid Conductor technologies. These avoid many strand-distortion mechanisms and are in their own right ideal in a growing number of applications.

Directionality: All drawn metal conductors have a non-symmetrical, fish-scale-like grain structure. Because the highest Radio Frequencies (RF) are subject to skin effect, traveling on this deformed outer-surface layer of the conductor, there is a resulting increase in RF impedance in one direction versus the other. Since induced RF noise is parasitic (and doesn't travel with the primary signal current), it takes the path of least resistance. At AudioQuest, we test every conductor so it is used in the direction that drains the induced noise away from where it will cause the most harm, optimizing the cable and the system's performance.

Noise-Dissipation: Unwanted Radio-Frequency (RF) noise is and has always been picked up and induced into cable. This contamination ultimately masks and distorts critical portions of the audio/video signal. As this distortion-causing (parasitic) RF signal is more present today than at any previous time in history, we must depend on a wider arsenal of Noise-Dissipation technologies:

- ZERO Tech (No Characteristic Impedance) applies Ultra-Linear Noise-Dissipation across the widest range of frequencies possible. It also enables uncompressed transient current transfer for AC power and loudspeaker/power amplifier applications.
- RF/ND-Tech (Patented Radio-Frequency Ground-Noise Dissipation) minimizes circuit misbehavior by cancelling induced RF noise.
- Tried-and-true DBS (Dielectric-Bias System) has evolved to include RF-Noise Traps that further reduce dielectric distortion and induced noise.

Metal Quality: Higher-purity conductor metals with smoother surfaces and internal crystal structures greatly reduce noise and distortion. Carefully finessed mixes of metals and conductor sizes can be effectively used to define a cable's Sonic Signature—a cost-effective technique for high-value, high-performance models.



Solid Conductors

Directionality

Noise-Dissipation

Metal Quality

DragonFly

Naturally beautiful sound at your fingertips—whenever and wherever you want it

With today's smartphones, tablets, and computers, music and videos are far more accessible than ever before.

Unfortunately, the digital-to-analog converters (DACs) inside these devices are highly compromised, even when the sample-rate numbers (24/192, etc.) look impressive. These built-in DACs may make audible sound, but they don't make beautiful music.

A DragonFly bypasses the compromised audio circuitry within these devices to deliver naturally beautiful sound to earbuds, headphones, desktop speakers, or complete audio systems.

Whether using a free streaming service, premium High-Resolution or MQA-encoded streaming (such as Tidal Masters), or playing MP3 files or videos, all DragonFlies make these experiences much more compelling and immersive.

DragonFly Black delivers great performance and value. Red ups the game with more power, more grip, and deeper sonic immersion. Now, DragonFly Cobalt, with its more advanced processor, microcontroller, and RF noise filtering, provides even greater clarity, dynamics, and finesse than previously possible.



DragonFly DAC + Preamp + Headphone Amp

- Plays all music files: MP3 to High-Res and MQA
- Compatible with Apple® and Windows® PCs
- Compatible with iOS devices (requires Apple Lightning to USB 3 Camera Adaptor)
- Compatible with Android devices (requires DragonTail or other USB Adaptor for Android Devices)
- Bit-perfect variable output drives headphones, powered speakers, or power amp
- Fixed output feeds preamp or receiver



	DragonFly Black	DragonFly Red	DragonFly Cobalt
Output	1,2 volts	2,1 volts	
DAC Chip	ESS ES9010 with minimum-phase fast roll-off filter	ESS ES9016 with minimum-phase fast roll-off filter	ESS ES9038Q2M DAC chip with minimum-phase slow roll-off filter for more natural sound
Volume Control	Analog Volume Control	64-Bit Bit-Perfect Digital Volume Control	
Desktop Compatibility	Windows 7 and later; Apple 10.6.8 and later; Linux (no tech support provided)		
Mobile Compatibility	Apple iOS 5 and later; Android 5.0 and later		
Included Adaptor			DragonTail A to C Adaptor
Accessories	Protective Endcap, Leatherette Pouch		
Dimensions	62mm (l) x 19mm (w) x 12mm (h)	62mm (l) x 19mm (w) x 12mm (h)	57mm (l) x 19mm (w) x 12mm (h)
	Euro Retail: 119,00	Euro Retail: 229,00	Euro Retail: 329,00

USB Extenders and Adaptors

DragonTail USB Extenders feature 5% Silver Solid Conductors and are Direction-Controlled for reduced RF noise.



DragonTail USB A 2.0 Extender

Female USB A to Male A

Euro Retail: 29,95



DragonTail USB A to Micro Adaptor

Female USB A to Male Micro

Euro Retail: 29,95



DragonTail A to C Adaptor

(included with DragonFly Cobalt)

Euro Retail: 29,95

JitterBug FMJ USB 2.0 Noise Filter (Data & Power)

- Enables more spacious and compelling sound
- Dual Discrete Noise-Dissipation Circuits reduce all forms of internal noise in both the sending and receiving electronics
- Full Metal Jacket (FMJ) with hinged Carbon-Loaded Noise-Dissipation input cover protects against external noise
- Reduces jitter and packet errors
- Use one JitterBug in series with almost any USB DAC, including DragonFlies Black and Red; experiment with DragonFly Cobalt
- For an additional improvement, use a second JitterBug in parallel—always desirable with DragonFly Cobalt

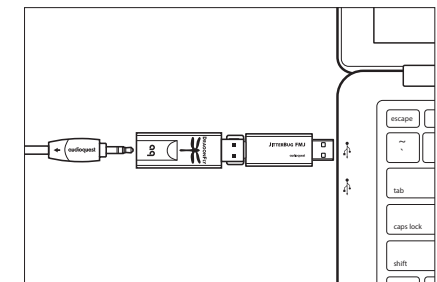

Euro Retail: 69,00

AC Power Conditioners

Niagara and PowerQuest: Low-Z Power | Noise-Dissipation Systems

Redefining the science of AC power conditioning

What is a power conditioner and why is it necessary?

For some, a power conditioner is merely a device that provides enough outlets for the entire audio/video system while also protecting the connected devices from electrical storms and wiring faults. Yet, for the discriminating listener, many power conditioners can make an audio/video system perform far worse.

Yes, a home or building may have dimming lights or an occasional brown-out, and the utilities' AC sine wave is always far from perfect. However, where incoming power is concerned, there are two reasons an audio/video system does not perform up to its full potential: 1) The current transients that supply the power amplifier are compressed, and 2) The ever-increasing levels of radio-frequency noise are masking (covering up) the system's low-level signal content.

When compared to or measured against either Niagara or PowerQuest, a simple power bar or a dedicated AC wall outlet can lose up to a third of the low-level audio information that contain much of a recording's harmonics, imaging, high frequencies, and bottom-end grip—and once that information is gone, it's gone forever.

AudioQuest's Niagara and PowerQuest technologies are unique amongst all power products—whether they're isolation transformers, AC regenerators, battery back-up, re-clocking devices, or other types. Niagara and PowerQuest filters and Ground-Noise Dissipation work evenly, or linearly, across a far wider range of induced noise frequencies. Additionally, Niagaras 3000, 5000, and 7000 feature Transient Power Correction, which supplies a current reservoir to greatly bolster the performance of any power amplifier.





	PowerQuest 2	PowerQuest 3	Niagara 1200	Niagara 3000	Niagara 5000	Niagara 7000
Linear Noise-Dissipation Technology	More than 18 octaves of differential filtering	More than 18 octaves of differential filtering; 14 octaves common-mode filtering	Level-X More than 19 octaves of differential filtering	Level-X More than 21 octaves differential-mode filtering	Level-X More than 23 octaves differential-mode filtering; 16 octaves common-mode filtering	Level-X More than 23 octaves differential-mode filtering; 20 octaves common-mode filtering
Patented Ground-Noise Dissipation	1 outlet	2 outlets	2 banks (all outlets)	3 banks (all outlets)	6 banks (all outlets)	6 banks (all outlets)
Non-Sacrificial Surge Protection	Withstands multiple AC surges and spikes up to 6000V/3000A without sustaining damage		Sonically Non-Invasive; Withstands multiple AC surges and spikes up to 6000V/3000A without sustaining damage			
Transient Power Correction	N/A	N/A	N/A	55 amps peak; Provides a current reservoir for any power amplifier (up to 25mS)	80 amps peak; Provides a current reservoir for any power amplifier (up to 25mS)	80 amps peak; Provides a current reservoir for any power amplifier (up to 25mS)
Patented DBS Symmetrical Power Isolation Transformer	N/A	N/A	N/A	N/A	N/A	2 (source component outlet banks)
Maximum RMS Current	10 Amps (RMS) @ 220-240v	10 Amps (RMS) @ 220-240v	10 Amps (RMS) @ 220-240v	10 Amps (RMS) @ 220-240v	16 Amps (RMS) @ 220-240v	16 Amps (RMS) @ 220-240v
Outlets	6 total: (1) 4K/8K Video, (3) Source, (2) High-Current	8 total: (2) 4K/8K Video, (4) Source, (2) High-Current	7 total: (5) Source (including video), (2) High-Current	7 total: (5) Source (including video), (2) High-Current	12 total: (8) Source (including video), (4) High-Current	12 total: (8) Source, (4) High-Current
USB-A Charging Ports	2 high-speed ports (3.4 amp capacity)	4 high-speed ports (4.8 amp capacity)	N/A	N/A	N/A	N/A
Power Cable	Direction-Controlled Semi-Solid Concentric - 2,1m long		Power cable not included - For optimal results use a cable that features ZERO and GND Technology			
Signal Line Protection	N/A	Network	N/A	N/A	N/A	N/A
Dimensions	393mm L x 80mm W x 153mm H (Includes wall-mounting holes and detachable base)	393mm L x 80mm W x 188mm H (Includes wall-mounting holes and detachable base)	493mm W x 81mm H x 190mm D	445mm W x 88mm H x 386mm D (2-RU rack mount kit included)	445mm W x 133mm H x 437mm D (3-RU rack mount kit on request)	445mm W x 133mm H x 437mm D (3-RU rack mount kit on request)
Weight	2,2 kg	2,5 kg	8,2 kg	11,3 kg	17,2 kg	39 kg
	Euro Retail: 249,00	Euro Retail: 349,00	Euro Retail: 1.299,00	Euro Retail: 3.299,00	Euro Retail: 5.499,00	Euro Retail: 9.799,00

AC Power Cables

Low-Z | Noise-Dissipation NRG, Wind, and Storm Series

The power cords that are supplied with most audio/video components have many admirable features. They're durable, flexible, small, and they will unfailingly supply the required AC voltage from the utilities' service tap for many years to come. They're also inexpensive.

Unfortunately, these "commodity" power cords were never up to the task of supplying sensitive components with the quality power they need. By this, we mean power that is unrestricted when delivering current transients to a power amplifier. The power cord must not add noise to the audio/video signal via RF (radio-frequency) noise that is induced into, or picked up by, the AV component. The ground lead is the worst offender in this regard, as it has no component power supply to help lessen the damage from the induced RF noise. Typically, the ground noise drains directly towards the component's signal path.

Even with an advanced AC power system like Niagara or PowerQuest, the AC cord is a branch of noise-dissipation system. Like plumbing, the RF noise must be drained away from the circuits upon which it could do harm. Many ask, if my wall wiring is so many yards in length, how can a 6-foot cord possibly matter? It matters for the same reason four square inches of mud and debris can back up a plumbing system or a rain gutter. The drainage or distribution of water currents and noise currents work in the exact same manner. They are one system.

With AudioQuest power cords and our unique technologies such as ZERO Tech (No Characteristic Impedance) and our patented RF/ND-Tech, you will experience greater dynamics, bass grip, extended high frequencies, and the blackest background you've ever heard.

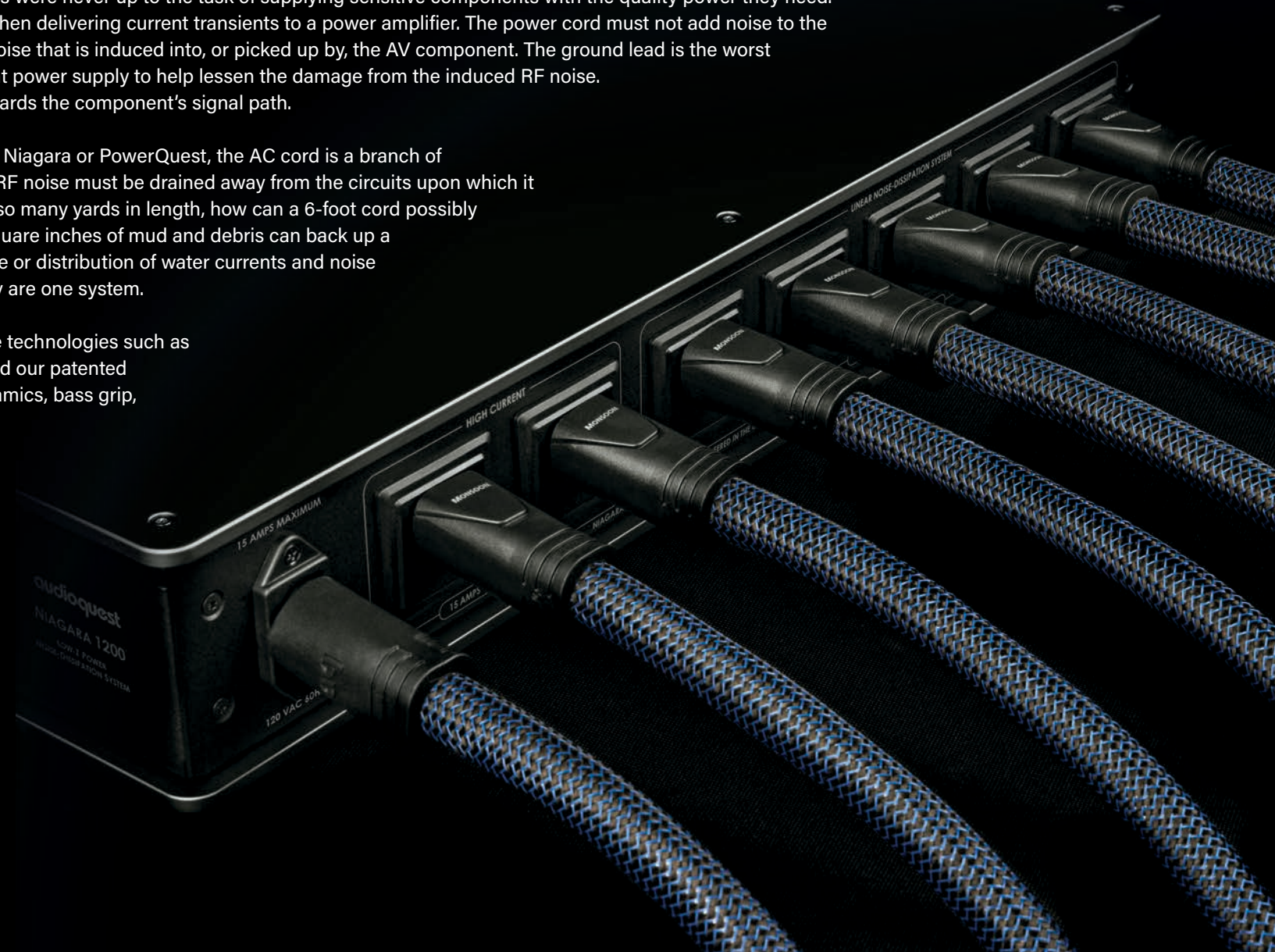

AC Power Cables: NRG Series

C5
2,5A Maximum RMS Capacity @ 230VAC 50Hz

C7
2,5A Maximum RMS Capacity @ 230VAC 50Hz



C13
15A Maximum RMS Capacity @ 230VAC 50Hz



NRG-Y and NRG-Z Series cables with the C7 connector feature a three-pole male plug. Though there is no third ground lead, there are Radio-Frequency shield drain leads that must connect to Earth Ground. This construction is also required for our proprietary ZERO Technology.



Model	NRG-X2	NRG-Y2	NRG-Z2	NRG-X3	NRG-Y3	NRG-Z3
Metal	Semi-Solid Concentric LGC		Semi-Solid Concentric PSC+	Semi-Solid Concentric LGC		Semi-Solid Concentric PSC+
Gauge	1,04mm ² (2,5 Amp @ 220-240V)			1,31mm ² (C13 Plug: 10 Amp @ 220-240v, C5 Plug: 2,5 amps @ 220-240v)		2,08mm ² (10 Amp @ 220-240v)
Technology	-	ZERO Tech (No Characteristic Impedance)			ZERO Tech (No Characteristic Impedance)	ZERO Tech (No Characteristic Impedance); Patented RF/ND-Tech
Jacket	Black PVC with Red Stripes	Dark Gray/Black Braid	Dark Red/Black Braid	Black PVC with Red Stripes	Dark Gray/Black Braid	Dark Red/Black Braid
Terminations	Cold-Welded Connectors					
Length	Euro Retail	Euro Retail	Euro Retail	Euro Retail	Euro Retail	Euro Retail
1m	65,00	99,00	199,00	79,00	149,00	229,00
2m	79,00	129,00	259,00	99,00	189,00	329,00
3m	95,00	159,00	319,00	119,00	229,00	429,00
4,5m	119,00	-	-	149,00	-	-
6m	139,00	-	-	179,00	-	-



C17
For components that use the ungrounded C17 connector, please use AQ cables with a C13 connector. The grounded male plug is necessary to make use of our Noise-Dissipation System.

Note: NRG-X3 with C5 connector is available in 1m, 2m & 3m only

AC Power Cables: Wind Series

Never assume which of these is required for a component or power conditioner. Some manufacturers prefer the performance of one IEC inlet type over another—even when their circuit's current draw is minimal.

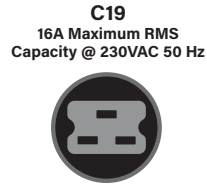
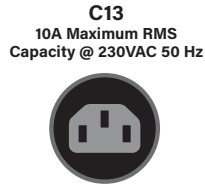



Wind Series Plugs



Mistral Plugs for Wind Series XTRM

XTRM cables have upgraded plugs equivalent in quality to the Storm Series plugs. All Wind models are also available with UK plugs.

Model	Monsoon	Monsoon XTRM	Blizzard 72V DBS	Blizzard XTRM 72V DBS	Silver Cloud 72V DBS	Silver Cloud XTRM 72V DBS
Plug Type	Direct-Gold Plated Molded	Hanging Silver Over Red Copper	Direct-Gold Plated Molded	Hanging Silver Over Red Copper	Direct-Gold Plated Molded	Hanging Silver Over Red Copper
Metal	Semi-Solid True-Concentric PSC+ and LGC		Semi-Solid True-Concentric PSC+		Semi-Solid True-Concentric PSS and PSC+	
Gauge	3,31mm ²					
Technology	ZERO Tech (No Characteristic Impedance) for Uncompressed Current Transfer; RF/ND-Tech					
Jacket	Dark Blue/Black Braid 	Silver/Black Braid 		Black/Black Braid 		
Terminations	Direct-Gold and Silver Plated; Cold-Welded Connectors					
Length	Euro Retail	Euro Retail	Euro Retail	Euro Retail	Euro Retail	Euro Retail
1m	369,00	669,00	599,00	899,00	1.999,00	2.299,00
2m	499,00	799,00	799,00	1.099,00	3.499,00	3.799,00
3m	629,00	929,00	999,00	1.299,00	4.999,00	5.299,00
Other prepared lengths use formula:	-	130,00/m + 539,00	-	200,00/m + 699,00	-	1.500,00/m + 799,00

Mistral AC Power Bulk Cable

Metal: Semi-Solid True-Concentric PSC+ and LGC

Gauge: 3,31mm²

Technology: RF/ND-Tech

Jacket: Dark Gray/Light Gray PVC

Terminations: Mistral AC Power Plugs

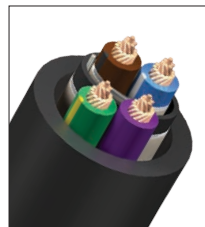

Mistral AC Power Plugs

Sold separately.



Mistral Wall Plug

Euro Retail: 139,00



Mistral IEC C-13 Plug

Euro Retail: 139,00



Mistral IEC C-19 Plug

Euro Retail: 139,00

Per Meter

Euro Retail: 120,00





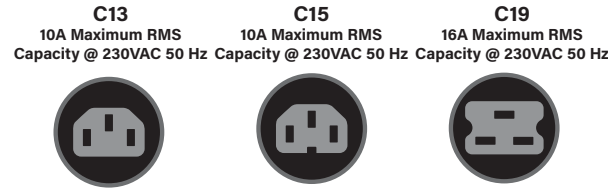





AC Power Cables: Storm Series

Never assume which of these is required for a component or power conditioner. Some manufacturers prefer the performance of one IEC inlet type over another—even when their circuit's current draw is minimal.







Plugs for Storm Series

Variable Current (High-Current) AC Power Cables - Optimized for use with AC power conditioners/regenerators, power amplifiers, and any components that contain a built-in power amplifier, including AV receivers, powered speakers, and powered subwoofers.

Model	 Thunder ● 72V DBS	 Tornado ● 72V DBS	 Hurricane ● 72V DBS	 FireBird ● 72V DBS	 Dragon ● 72V DBS
Metal	Solid LGC and PSC	Solid PSC and Solid PSC+	Solid PSC+	Solid PSS and PSC+	Primarily Solid PSS
Technology	ZERO Tech (No Characteristic Impedance) for Uncompressed Current Transfer; RF/ND-Tech				
Jacket	 Brown/Black Braid	 Silver/Black Braid	 Dark Blue/Black Braid	 Dark Red/Black Braid	 Black/Black Braid
Termination and Gauge	Hanging-Silver over Red and Beryllium Copper - 4,17mm ² Line and Neutral - 3,31mm ² Ground				
Length	Euro Retail	Euro Retail	Euro Retail	Euro Retail	Euro Retail
1m	999,00	1.399,00	1.749,00	3.499,00	5.499,00
2m	1.149,00	1.699,00	2.499,00	5.899,00	9.899,00
3m	1.299,00	1.999,00	3.249,00	8.299,00	14.299,00
Other prepared lengths use formula:	150,00/m + 849,00	300,00/m + 1.099,00	750,00/m + 999,00	2.400,00/m + 1.099,00	4.400,00/m + 1.099,00

Constant-Current (Source) AC Power Cables - Optimized for use with audio/video source components, which have a constant or "fixed" current draw.

Model	-	 Tornado ● 72V DBS	 Hurricane ● 72V DBS	 FireBird ● 72V DBS	 Dragon ● 72V DBS
Termination and Gauge	-	Hanging-Silver over Red and Beryllium Copper - 1,31mm ² Line, Neutral and Ground			
Length	-	Euro Retail	Euro Retail	Euro Retail	Euro Retail
1m	-	1.149,00	1.449,00	2.999,00	4.499,00
2m	-	1.299,00	1.949,00	4.899,00	7.899,00
3m	-	1.449,00	2.449,00	6.799,00	11.299,00
Other prepared lengths use formula:	-	150,00/m + 999,00	500,00/m + 949,00	1.900,00/m + 1.099,00	3.400,00/m + 1.099,00

AC Power Accessories

Female to Male IEC C-13 Adaptors

Premium Single-Piece Metal Conductors from Input to All Outputs Preserve Advantages of Superior AudioQuest NRG Series AC Cables.

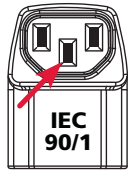

IEC90°/1

Adaptor Bends in Direction of Center Pin

Euro Retail: 19,95

IEC90°/2

Adaptor Bends in Direction of 2 Outer Pins

Euro Retail: 19,95



C7 90° Adaptor Kit

- Provides 90° bends for C7 power connections
- Also connects for double bends
- Non-polarized for maximum flexibility
- Retail package contains 1 x "E" adaptor and 1 x "U" adaptor

Set of 2

Euro Retail: 35,90

AC Power C7 90° Adaptors are also sold in Installer Packs. See page 58.

Fog Lifters

Place Fog Lifters beneath audio and AC power cables to significantly reduce RF noise coupling, whether with the floor, or due to misdirected efforts to isolate cable with stands or clamps that themselves have too much contact mass and are sources of RF noise.



Set of 8

Euro Retail: 149,00

Speaker Cables

Meticulously Designed to Minimize Noise and Distortion

Do No Harm: The Four Elements Today

AudioQuest's Four Elements are always applied in the most thoughtful, effective ways to offer the best performance for the money—at all price points. While our implementation of these techniques has evolved over the years, our guiding principle remains the same: *Do No Harm*.

Solid Conductors

Strand interaction remains the biggest potential source of distortion in cables. Solid Conductors are the aspirational ideal and most complete solution to this problem. However, thoughtfully arranged multi-conductor geometries such as concentric windings are used to create our Semi-Solid Conductor technologies. These avoid many strand-distortion mechanisms and are in their own right ideal in a growing number of applications.

High-Purity Metal

Higher-purity conductor metals with smoother surfaces and internal crystal structures greatly reduce noise and distortion. Carefully finessed mixes of metals and conductor sizes can be effectively used to define a cable's *Sonic Signature*—a cost-effective technique for high-value, high-performance models.

Noise-Dissipation

Unwanted Radio-Frequency (RF) noise is and has always been picked up and induced into cable. This contamination ultimately masks and distorts critical portions of the audio/video signal. As this distortion-causing (parasitic) RF signal is more present today than at any previous time in history, we must depend on a wider arsenal of Noise-Dissipation technologies:

- Directionally Controlled conductors minimize high-frequency noise by "directing" or draining it away from the most vulnerable circuits.
- ZERO Technology (No Characteristic Impedance) applies Ultra-Linear Noise-Dissipation across the widest range of frequencies possible. It also enables uncompressed transient current transfer for AC power and loudspeaker/power amplifier applications.
- RF/ND-Tech (Patented Radio-Frequency Ground-Noise Dissipation) minimizes circuit misbehavior by cancelling induced RF noise.
- Tried-and-true DBS has evolved to include RF-Noise Traps that further reduce dielectric distortion and induced noise.

Dielectric

Insulation is necessary between conductors to minimize signal interaction and electrical shorts. The ideal is virtually no dielectric interaction (such as is achieved with our ZERO Technology). However, by optimizing the dielectric material between signal conductors, this distortion is greatly minimized.



Speaker Cable Applications

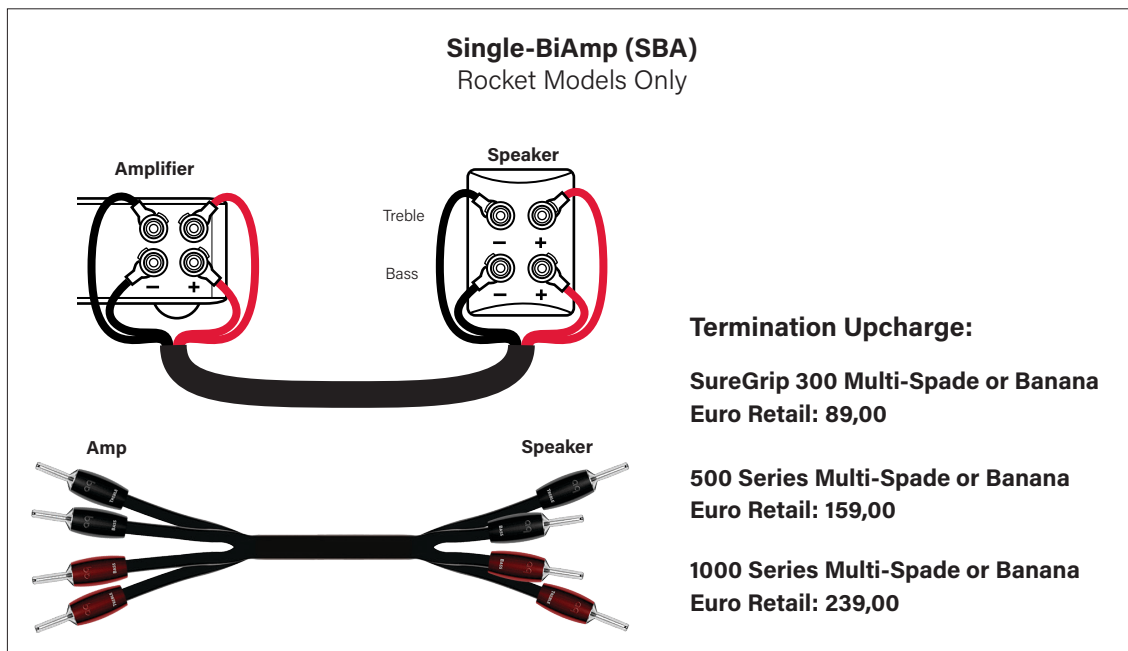
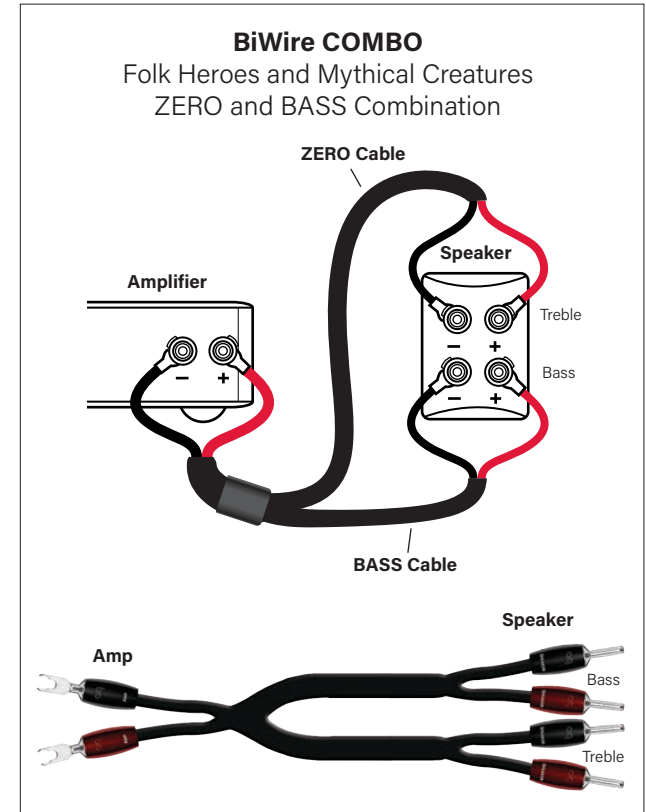
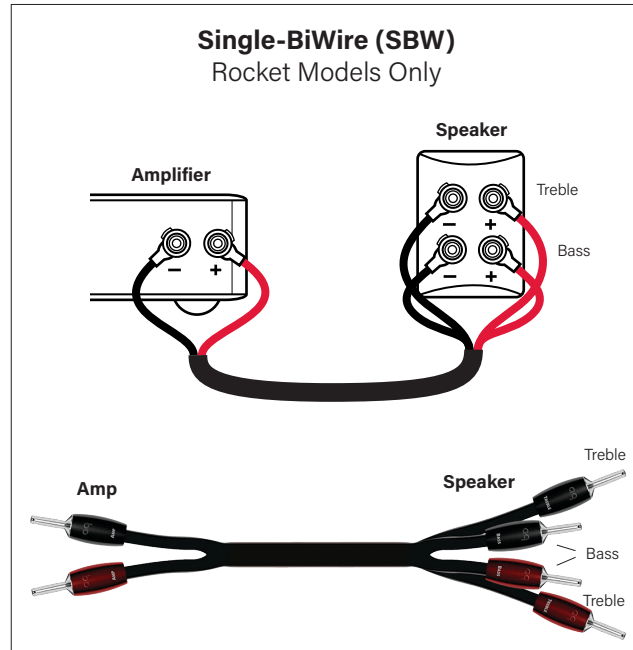
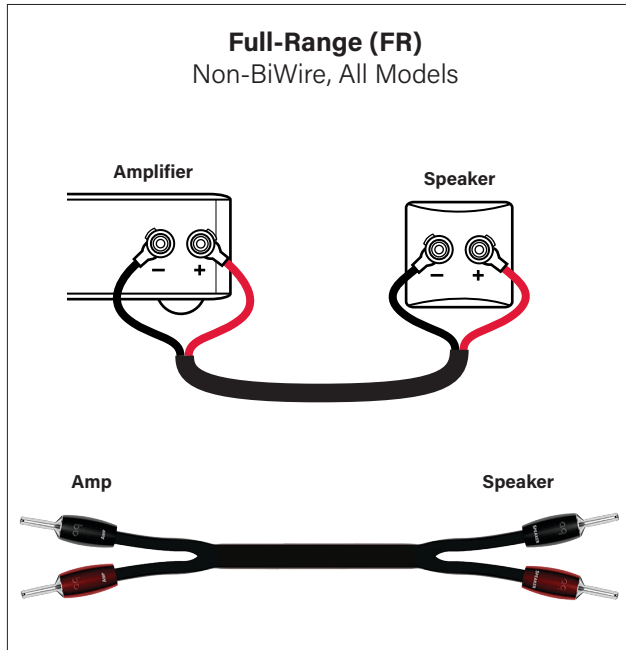

Termination Upcharge:

SureGrip 300 Multi-Spade or Banana
Euro Retail: 89,00

500 Series Multi-Spade or Banana
Euro Retail: 159,00

1000 Series Multi-Spade or Banana
Euro Retail: 239,00



Mythical Creature & Folk Hero Termination Options: Bananas or Spades?

Amplifier-End Connector:

Choice of 1000 Series Multi-Spade, Banana, U-Spade, or V-Spade (Silver only)



Insulated (compliant) binding posts may not allow for 2 sets of connectors.

Often, the choice between terminating speaker cables with spade lugs or banana plugs will come down to personal preference. However, today's EU-compliant isolated binding posts are being used on more power amplifiers than ever before. This sometimes makes it difficult, if not impossible, to use a banana connector. Further, given the girth and weight of our Mythical Creature Series speaker cables, a spade may be better capable of fully supporting the cable. This is particularly a concern with binding posts that do not allow a banana connector to fully seat into the post.

Further, the EU-compliant posts will neither accept our V-Spade nor allow our Multi-Spade to be fully seated. For these applications (or when you're not certain), **we highly recommend the U-Spade**, as it can accommodate any binding post. The V-Spade is a specialty spade connector that works well with large wingnut binding posts (such as the Mundorf), as it allows extra clearance.

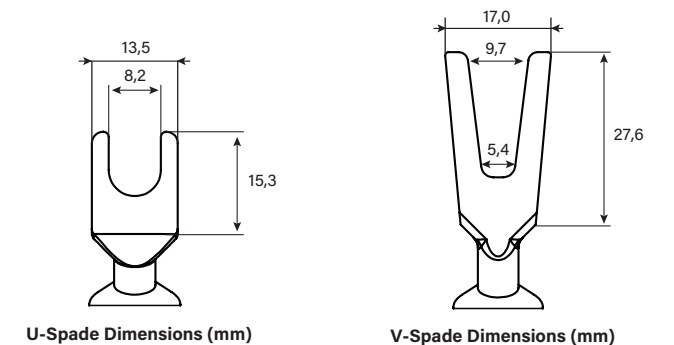
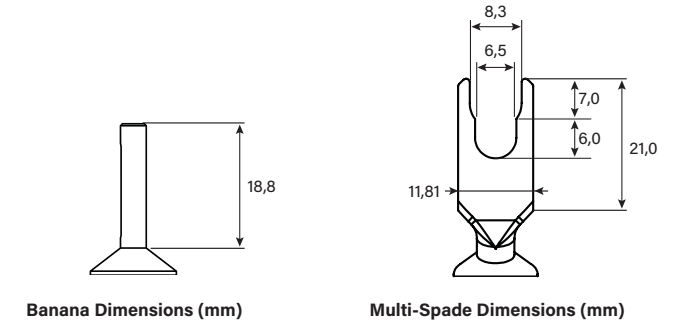

Speaker-End Connector:

Choice of 1000-Series Spade or Banana (Silver only)

Here we typically recommend the **U-Spade** or banana connector. However, even though there is less weight and pressure on this side of the cable (particularly for Bi-Wire sets), it is nevertheless important to note the binding post's design. If a banana connector cannot seat all the way into the binding post, we recommend one of our spade connectors.

How to Order Prepared Speaker Cables

First please specify type of connector (banana or appropriate spade), then the finish of connector (silver*).

(*or gold where applicable)

Pair prices shown. Also available in singles (i.e. for center channel, subwoofer, or mono) at half pair price.

When ordering any factory-terminated speaker cable, please include the required elements shown in the examples below:

Qty.	Pair or Single	Length	Model	FR/BWC/SBW	Amplifier Termination	Speaker Termination	Silver or Gold
1	Pair	3m	Rocket 88	FR	Spade	Banana	Silver
1	Single	2m	William Tell	COMBO	U-Spade	Banana	N/A
1	Single	3m	Rocket 44	SBW	Spade	Banana	Gold

Speaker Cables: Q2 and Type Series (Type 5, Type 9, Type 9+DBS)

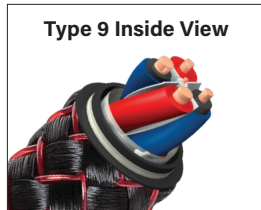
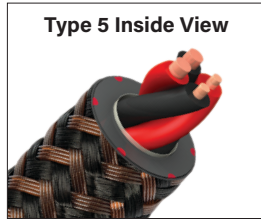
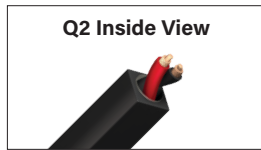

Model	Q2	Type 5	Type 9	Type 9+DBS ● 72V DBS
Metal	Concentric LGC	Solid PSC+ Sonic-Signature Conductors and LGC	Solid PSC+	
Gauge	1,65mm ²	1,65mm ²	1,65mm ²	1,65mm ²
Geometry	Low-Inductance Twisted-Pair		Star-Quad	
Noise-Dissipation	No	Carbon-Based Noise-Dissipation	Multi-Layer Carbon-Based Noise-Dissipation	
Jacket	Prepared: Black PVC Bulk: White or Black PVC	Prepared: Brown/Black Braid Bulk: Black PVC with Red Stripes	Red/Black Braid	
Plugs	Prepared: SureGrip 100 (Silver) Banana	SureGrip 300 (Silver or Gold) Choice of Multi-Spade or Banana	500 Series (Silver or Gold) Choice of Multi-Spade or Banana	1000 Series (Silver) Choice of Multi-Spade or Banana
Prepared Lengths	Euro Retail	Euro Retail	Euro Retail	Euro Retail
2m Pair	-	349,00	599,00	899,00
2,5m Pair	-	374,00	649,00	949,00
3m Pair	229,00	399,00	699,00	999,00
4m Pair	-	449,00	799,00	1.099,00
Other prepared lengths use formula (per pair)	-	50,00/m + 249,00	100,00/m + 399,00	100,00/m + 699,00
Bulk Cables (on spools)	Euro Retail	Euro Retail	Euro Retail	Euro Retail
50m	-	-	50,00/m	-
100m	11,50/m	25,00/m	50,00/m	-

Speaker Cables: Rocket Series

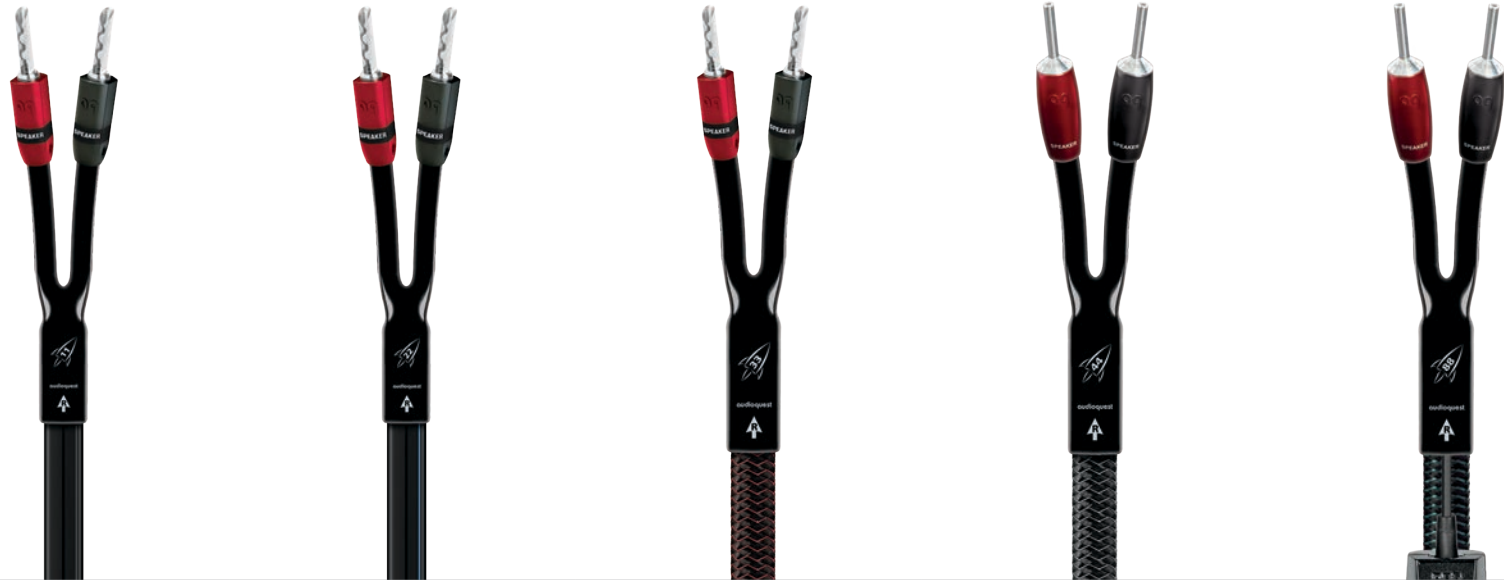
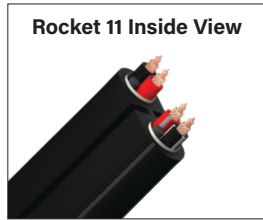

Model	Rocket 11	Rocket 22	Rocket 33	Rocket 44	Rocket 88 72V DBS
Metal	Semi-Solid True-Concentric LGC	Semi-Solid True-Concentric PSC and LGC	Solid PSC and LGC	Solid PSC+ and PSC	Solid PSC+
Gauge	2,08mm ²	3,31mm ²	2,08mm ²	3,31mm ²	
Geometry	Double Spiral-Pair		Double Star-Quad		
Dielectric	PVC		Foamed-Polyethylene (For All Positive Conductors)		
Noise-Dissipation	No	Carbon-Based Noise-Dissipation			
Jacket	Black PVC with Gray Stripes	Black PVC with Blue Stripes	Red/Black Braid or PVC	Silver/Black Braid or PVC	Green/Black Braid or PVC
Application Options	Full-Range, Single-BiWire, Single-BiAmp & REL				
Plugs	SureGrip 300 (Silver or Gold) Choice of Multi-Spade or Banana		SureGrip 300 (Silver or Gold) Choice of Multi-Spade or Banana		500 Series (Silver or Gold) Choice of Multi-Spade or Banana
Prepared Lengths	Euro Retail	Euro Retail	Euro Retail	Euro Retail	Euro Retail
2m Pair	269,00	349,00	399,00	549,00	1.179,00
2,5m Pair	284,00	389,00	449,00	634,00	1.309,00
3m Pair	299,00	429,00	499,00	719,00	1.439,00
4m Pair	329,00	509,00	599,00	889,00	1.699,00
Other prepared lengths use formula (per pair)	30,00/m + 209,00	80,00/m + 189,00	100,00/m + 199,00	170,00/m + 209,00	260,00/m + 659,00
Bulk Cables (on spools)	Euro Retail	Euro Retail	Euro Retail	Euro Retail	Euro Retail
50m	15,00/m	40,00/m	50,00/m	85,00/m	130,00/m
100m	15,00/m	40,00/m	50,00/m	-	-

Note: Longer lengths formula pricing is **per pair**. For bulk cables, retail price is listed per meter.

Speaker Cables: Robin Hood (Folk Heroes)



Model	Robin Hood ZERO ● 72V DBS	Robin Hood BASS ● 72V DBS	Robin Hood BiWire COMBO (ZERO + BASS) ● 72V DBS	Robin Hood SILVER ● 72V DBS	Robin Hood SILVER BiWire COMBO (SILVER + BASS) ● 72V DBS
Metal	Solid PSC+		Refer to Specs for ZERO and BASS	Solid PSS Sonic-Signature Conductors and PSC+	Refer to Specs for SILVER and BASS
Gauge	1,65mm ²			1,65mm ²	
Geometry	ZERO Tech (No Characteristic Impedance)			ZERO Tech (No Characteristic Impedance)	
Noise-Dissipation	Multi-Layer Carbon-Based Noise-Dissipation	RF/ND-Tech		Multi-Layer Carbon-Based Noise-Dissipation	
Jacket	Dark Green/Black Braid	Black Braid		Light Gray/Black Braid	
Application Options	Full-Range or BiWire COMBO (when combined with BASS cable)	BiWire COMBO (when combined with ZERO cable)	Full-Range or BiWire COMBO (when combined with BASS cable)		
Plug Options (1000 Series, Silver)	AMP-Side: Choice of U-Spade (recommended default), Banana, Multi-Spade, or V-Spade / SPEAKER-Side: Choice of U-Spade (recommended default), Banana, or Multi-Spade				
Prepared Lengths	Euro Retail	Euro Retail	Euro Retail	Euro Retail	Euro Retail
2m Pair	1.650,00	1.650,00	3.300,00	4.330,00	5.980,00
2,5m Pair	1.815,00	1.815,00	3.630,00	5.165,00	6.980,00
3m Pair	1.980,00	1.980,00	3.960,00	6.000,00	7.980,00
4m Pair	2.310,00	2.310,00	4.620,00	7.670,00	9.980,00
Other prepared lengths use formula (per pair)	330,00/m + 990,00	330,00/m + 990,00	660,00/m + 1.980,00	1.670,00/m + 990,00	2.000,00/m + 1.980,00

Speaker Cables: William Tell (Folk Heroes)



Model	William Tell ZERO ● 72V DBS	William Tell BASS ● 72V DBS	William Tell BiWire COMBO (ZERO + BASS) ● 72V DBS	William Tell SILVER ● 72V DBS	William Tell SILVER BiWire COMBO (SILVER + BASS) ● 72V DBS
Metal	Solid PSC+	Solid PSC+ Sonic-Signature Conductors and LGC	Refer to Specs for ZERO and BASS	Solid PSS Sonic-Signature Conductors and PSC+	Refer to Specs for SILVER and BASS
Gauge	2,62mm ²			2,62mm ²	
Geometry	ZERO Tech (No Characteristic Impedance)			ZERO Tech (No Characteristic Impedance)	
Noise-Dissipation	Multi-Layer Carbon-Based Noise-Dissipation	RF/ND-Tech		Multi-Layer Carbon-Based Noise-Dissipation	
Jacket	Dark Red/Black Braid	Black Braid		Silver/Black Braid	
Application Options	Full-Range or BiWire COMBO (when combined with BASS cable)	BiWire COMBO (when combined with ZERO cable)		Full-Range or BiWire COMBO (when combined with BASS cable)	
Plug Options (1000 Series, Silver)	AMP-Side: Choice of U-Spade (recommended default), Banana, Multi-Spade, or V-Spade / SPEAKER-Side: Choice of U-Spade (recommended default), Banana, or Multi-Spade				
Prepared Lengths	Euro Retail	Euro Retail	Euro Retail	Euro Retail	Euro Retail
2m Pair	2.720,00	1.860,00	4.580,00	6.060,00	7.920,00
2,5m Pair	3.050,00	2.025,00	5.075,00	7.225,00	9.250,00
3m Pair	3.380,00	2.190,00	5.570,00	8.390,00	10.580,00
4m Pair	4.040,00	2.520,00	6.560,00	10.720,00	13.240,00
Other prepared lengths use formula (per pair)	660,00/m + 1.400,00	330,00/m + 1.200,00	990,00/m + 2.600,00	2.330,00/m + 1.400,00	2.660,00/m + 2.600,00

Speaker Cables: ThunderBird (Mythical Creatures)

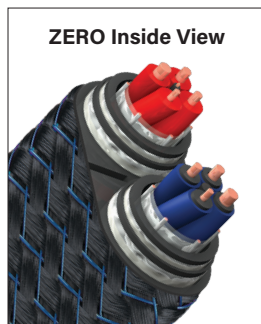

Model	ThunderBird ZERO ● 72V DBS	ThunderBird BASS ● 72V DBS	ThunderBird BiWire COMBO (ZERO + BASS) ● 72V DBS
Metal	Solid PSC+	Solid PSC+ Sonic-Signature Conductors and LGC	
Gauge	5,26mm ²		
Geometry	ZERO Tech (No Characteristic Impedance)		
Noise-Dissipation	Multi-Layer Carbon-Based Noise-Dissipation	RF/ND-Tech	
Jacket	Blue/Black Braid		
Application Options	Full-Range or BiWire COMBO (when combined with BASS cable)	BiWire COMBO (when combined with ZERO cable)	
Plug Options (1000 Series, Silver)	AMP-Side: Choice of U-Spade (recommended default), Banana, Multi-Spade, or V-Spade / SPEAKER-Side: Choice of U-Spade (recommended default), Banana, or Multi-Spade		
Prepared Lengths	Euro Retail	Euro Retail	Euro Retail
2m Pair	4.300,00	3.300,00	7.600,00
2,5m Pair	4.950,00	3.700,00	8.650,00
3m Pair	5.600,00	4.100,00	9.700,00
4m Pair	6.900,00	4.900,00	11.800,00
Other prepared lengths use formula (per pair)	1.300,00/m + 1.700,00	800,00/m + 1.700,00	2.100,00/m + 3.400,00

Speaker Cables: FireBird (Mythical Creatures)



Model	FireBird ZERO ● 72V DBS	FireBird BASS ● 72V DBS	FireBird BiWire COMBO (ZERO + BASS) ● 72V DBS
Metal	Solid PSS Sonic-Signature Conductors and PSC+		
Gauge	5,26mm ²		
Geometry	ZERO Tech (No Characteristic Impedance)		
Noise-Dissipation	Multi-Layer Carbon-Based Noise-Dissipation	RF/ND-Tech	Refer to Specs for ZERO and BASS
Jacket	Dark Red/Black Braid		
Application Options	Full-Range or BiWire COMBO (when combined with BASS cable)	BiWire COMBO (when combined with ZERO cable)	
Plug Options (1000 Series, Silver)	AMP-Side: Choice of U-Spade (recommended default), Banana, Multi-Spade, or V-Spade / SPEAKER-Side: Choice of U-Spade (recommended default), Banana, or Multi-Spade		
Prepared Lengths	Euro Retail	Euro Retail	Euro Retail
2m Pair	13.300,00	10.500,00	23.800,00
2,5m Pair	16.150,00	12.650,00	28.800,00
3m Pair	19.000,00	14.800,00	33.800,00
4m Pair	24.700,00	19.100,00	43.800,00
Other prepared lengths use formula (per pair)	5.700,00/m + 1.900,00	4.300,00/m + 1.900,00	10.000,00/m + 3.800,00

Speaker Cables: Dragon (Mythical Creatures)

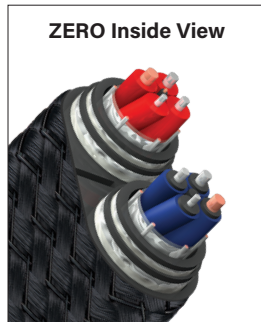

Model	Dragon ZERO ● 72V DBS	Dragon BASS ● 72V DBS	Dragon BiWire COMBO (ZERO + BASS) ● 72V DBS
Metal	Solid PSS Sonic-Signature Conductors and PSC+		Refer to Specs for ZERO and BASS
Gauge	5,26mm ²		
Geometry	ZERO Tech (No Characteristic Impedance)		
Noise-Dissipation	Multi-Layer Carbon-Based Noise-Dissipation	RF/ND-Tech	
Jacket	Black Braid		
Application Options	Full-Range or BiWire COMBO (when combined with BASS cable)	BiWire COMBO (when combined with ZERO cable)	
Plug Options (1000 Series, Silver)	AMP-Side: Choice of U-Spade (recommended default), Banana, Multi-Spade, or V-Spade / SPEAKER-Side: Choice of U-Spade (recommended default), Banana, or Multi-Spade		
Prepared Lengths	Euro Retail	Euro Retail	Euro Retail
2m Pair	23.300,00	17.900,00	41.200,00
2,5m Pair	28.650,00	21.900,00	50.550,00
3m Pair	34.000,00	25.900,00	59.900,00
4m Pair	44.700,00	33.900,00	78.600,00
Other prepared lengths use formula (per pair)	10.700,00/m + 1.900,00	8.000,00/m + 1.900,00	18.700,00/m + 3.800,00

Speaker Cable Accessories

PSC BiWire Jumpers

Solid PSC Copper Jumpers replace stamped jumpers supplied with BiWirable speakers.

Set of (4) 10.16cm Jumpers.



BiWire Jumpers-G (Direct-Gold Plated)
Euro Retail: 29,95



BiWire Jumpers-S (Direct-Silver Plated)
Euro Retail: 29,95

BiWire Jumpers

Easy and affordable upgrades over the common gold-plated, stamped-brass jumpers included with most biwireable loudspeakers. AudioQuest BiWire Jumpers use Direction-Controlled Solid Perfect-Surface Copper+ (PSC+, Saturn) or Perfect-Surface Silver (PSS, Jupiter) conductors.

Choice of Hanging-Silver or Hanging-Gold 500 Series Banana or Multi-Spade connectors. Please specify silver or gold when ordering. Length of jumpers is 20.32cm including connectors.



Saturn (PSC+)
Set of 4
Euro Retail: 229,00



Jupiter (PSS)
Set of 4
Euro Retail: 549,00

Using BiWire Jumpers with full-range cables on biwireable speakers

Connect BiWire Jumpers, (-) Treble to (-) Bass and (+) Treble to (+) Bass

3-Way or Panel/Hybrid: Connect Speaker Cable to (+) and (-) Treble Input

2-Way speakers: Connect (+) Speaker Cable to Treble (+) Input and (-) Speaker Cable to (-) Bass Input

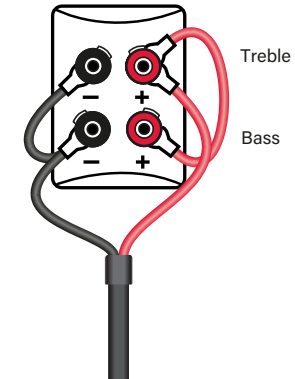
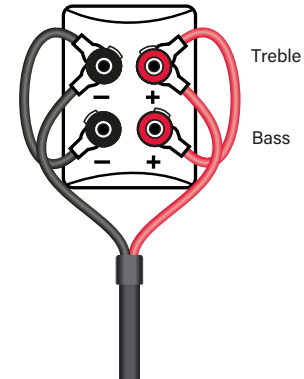

Fog Lifters

Place Fog Lifters beneath audio and AC power cables to significantly reduce RF noise coupling, whether with the floor, or due to misdirected efforts to isolate cable with stands or clamps that themselves have too much contact mass and are sources of RF noise.



Set of 8
Euro Retail: 149.00

Analog-Audio Interconnect Cables

The Higher You Climb, The Less You Hear?

Climbing the ladder of AudioQuest Analog Interconnect Cables leads to better and better performance. This makes immediate sense, but perhaps less intuitive is the fact that moving up the line means you hear less of the cable. The reason is simple: As more of the delicate audio signal is protected from damage along the way, the listener experiences more of the truth and emotional impact of the music. Greater faithfulness to the audio signal is made possible by the use of superior materials and the careful implementation of increasingly sophisticated design and construction techniques.

Music is wonderfully complex, and our ears are very sensitive to its nuances. The remarkably affordable Bridges & Falls Series is an amazing place to start the journey. Yet, every step up the ladder to the Elements Series delivers even more clarity, smoother and more natural sound, greater dynamic slam, and more nuanced expression from the music.

As you climb with your customers, you'll hear progressions in metal, from Solid Long-Grain Copper to Perfect-Surface Copper, Copper+, and Silver; in Geometry, from Double- to Triple-Balanced; in insulation, from Foamed-PE to FEP Air-Tubes; and in Noise-Dissipation techniques, from Metal- to Carbon-Based Multi-Layer Noise-Dissipation and our patented Dielectric-Bias System.

Throughout the line, the AQ performance-driven value system is always 100% evident. Climb until the incremental cost of the higher model is no longer the least expensive way to make the most improvement—but don't be surprised if your customers find themselves at the top of the line before reaching that point!



Angel



Wind



Yosemite



Earth



Sydney



Yukon



Big Sur



Mackenzie



Golden Gate



Red River



Evergreen



Chicago



Analog-Audio Interconnect Cables: Bridges & Falls

3.5mm Male Mini

2-Male RCA

3.5mm Female Mini

5 Pin DIN



Model	Tower	Evergreen	Golden Gate	Big Sur	Sydney	Yosemite ● 72V DBS	Angel ● 72V DBS
Metal	Solid LGC		Solid PSC		Solid PSC+		Solid PSS
Geometry	Asymmetrical Double-Balanced (Lower Impedance on Ground, Same Quality + and - Conductors)						
Dielectric	Foamed-Polyethylene				Polyethylene Air-Tubes	FEP Air-Tubes	
Noise-Dissipation	Metal-Layer Noise-Dissipation				Carbon-Based Noise-Dissipation		
Jacket	Black PVC with White Stripes	Green/Black Braid	Red/Black Braid	Brown/Black Braid	Dark Gray/Black Braid	Green/Black Braid	Silver/Black Braid
Termination	Cold-Welded, Gold-Plated			Cold-Welded, Gold-Plated Pure Purple Copper	Cold-Welded, Direct-Silver Plated Pure Purple Copper	Cold-Welded, Direct-Silver Plated Pure Red Copper	
Application							
3,5mm Male Mini - 2-Male RCA	Yes						
2-Male RCA - 2-Male RCA	Yes						
3,5mm Male Mini - 3,5mm Male Mini	Yes						
3,5mm Male Mini - 3,5mm Female Mini	3m and 5m Only	No	2m and 5m Only	No	No	Yes	
3,5mm Male Mini - 5 Pin DIN	No				Yes		
5 Pin DIN - 5 Pin DIN	No				Yes		
5 Pin DIN - 2-Male RCA	No				Yes		
Length	Euro Retail	Euro Retail	Euro Retail	Euro Retail	Euro Retail	Euro Retail	Euro Retail
0,6m	31,95	45,00	75,00	119,00	169,00	449,00	999,00
1m	33,95	49,00	79,00	129,00	199,00	499,00	1.199,00
1.5m	36,95	55,00	89,00	145,00	239,00	559,00	1.449,00
2m	39,95	59,00	95,00	159,00	269,00	619,00	1.699,00
3m	45,95	69,00	109,00	189,00	339,00	739,00	2.199,00
5m	57,95	89,00	139,00	249,00	479,00*	979,00	3.199,00
8m	75,95	119,00	185,00	339,00	689,00*	1.339,00	4.699,00
12m	99,95	159,00	249,00	459,00	969,00	1.819,00	6.699,00
16m	123,95	199,00	299,00	579,00	1.249,00	2.299,00	8.699,00
20m	147,95	239,00	369,00	699,00	1.529,00	2.779,00	10.699,00
Other prepared lengths use formula:	-	-	-	-	-	120,00/m + 379,00	500,00/m + 699,00

Tower and Golden Gate are also sold in Installer Packs. See page 58

* RCA - RCA not available

Analog-Audio Interconnect Cables: Rivers & Elements



Model	Chicago	Red River	Mackenzie	Yukon		Water ● 72V DBS	Earth ● 72V DBS	Wind ● 72V DBS	Fire ● 72V DBS
				RCA	XLR				
Metal	Solid LGC	Solid PSC	Solid PSC+			Solid PSS			
Geometry	Double-Balanced	Triple-Balanced (Separate Ground-Reference Conductor)		Double-Balanced	Triple-Balanced (Separate Ground-Reference Conductor)				
Dielectric	Hard-Cell Foam			Polyethylene Air-Tubes			FEP Air-Tubes		
Noise-Dissipation	Metal-Layer Noise-Dissipation		Carbon-Based Noise-Dissipation			Carbon-Based Multi-Layer Noise-Dissipation			
Jacket	Green/Black Braid or PVC	Red/Black Braid or PVC	Brown/Black Braid or PVC	Black/Dark Gray Braid		Blue/Black Braid	Green/Black Braid	Silver/Black Braid	Red/Black Braid
Termination	Cold-Welded, Gold-Plated		Cold-Welded, Hanging-Silver directly over pure Purple Copper			Cold-Welded, Hanging-Silver Plating directly over High-Purity Red Copper Plugs			
Application									
Male RCA - Male RCA	Yes			No		Yes			
Female XLR - Male XLR	No	Yes		No	Yes				
Length	Euro Retail	Euro Retail	Euro Retail	Euro Retail		Euro Retail	Euro Retail	Euro Retail	Euro Retail
0,5m	92,95	185,00	269,00	390,00	425,00	649,00	1.099,00	1.899,00	2.749,00
0,75m	96,95	189,00	285,00	420,00	465,00	699,00	1.199,00	2.199,00	3.249,00
1m	99,95	199,00	299,00	450,00	500,00	749,00	1.299,00	2.499,00	3.749,00
1,5m	107,45	215,00	329,00	510,00	575,00	849,00	1.499,00	3.099,00	4.749,00
2m	114,95	229,00	359,00	570,00	650,00	949,00	1.699,00	3.699,00	5.749,00
3m	129,95	259,00	419,00	690,00	800,00	1.149,00	2.099,00	4.899,00	7.749,00
4m	144,95	289,00	479,00	810,00	950,00	1.349,00	2.499,00	6.099,00	9.749,00
5m	159,95	319,00	539,00	930,00	1.100,00	1.549,00	2.899,00	7.299,00	11.749,00
6m	174,95	349,00	599,00	1.050,00	1.250,00	1.749,00	3.299,00	8.499,00	13.749,00
Other prepared lengths use formula (per pair)	15,00/m + 84,95	30,00/m + 169,00	60,00/m + 239,00	120,00/m + 330,00	150,00/m + 350,00	200,00/m + 549,00	400,00/m + 899,00	1.200,00/m + 1.299,00	2.000,00/m + 1.749,00
Bulk Cables (on spools)	Euro Retail	Euro Retail	Euro Retail	Euro Retail		Euro Retail	Euro Retail	Euro Retail	Euro Retail
50m	-	-	30,00/m	-	-	-	-	-	-
100m	7,50/m	15,00/m	-	-	-	-	-	-	-

Audio Interconnect Cables: Mythical Creatures

In order to preserve ZERO-Tech's complete isolation between signal conductors, a Double-DBS pack is included for XLR cables.



Model	ThunderBird		FireBird		Dragon	
	RCA ● 72v DBS	XLR Double ● 72v DBS	RCA ● 72v DBS	XLR Double ● 72v DBS	RCA ● 72v DBS	XLR Double ● 72v DBS
Metal	Solid Perfect-Surface Copper+ (PSC+)		Solid Perfect-Surface Silver (PSS)			
Geometry	ZERO-Tech (No Characteristic Impedance)					
Dielectric	FEP Air Tubes					
Noise-Dissipation	Level 6: ZERO-Tech + 72v DBS + Graphene/Carbon Mesh-Network				Level 7: PSS Drains + ZERO-Tech + 72v DBS + Graphene/Carbon Mesh-Network	
Jacket	Blue/Black Braid		Red/Black Braid		Black/Black Braid	
Plug Barrels	RF-Draining Copper Plated		RF-Draining Silver Plated			
Plug Contacts	Hanging-Silver over Red-Copper					
Length (Pair)	Euro Retail	Euro Retail	Euro Retail	Euro Retail	Euro Retail	Euro Retail
0,5m	2.300,00	3.100,00	4.250,00	5.150,00	7.250,00	8.900,00
0,75m	2.600,00	3.500,00	4.875,00	6.025,00	8.375,00	10.400,00
1m	2.900,00	3.900,00	5.500,00	6.900,00	9.500,00	11.900,00
1,5m	3.500,00	4.700,00	6.750,00	8.650,00	11.750,00	14.900,00
2m	4.100,00	5.500,00	8.000,00	10.400,00	14.000,00	17.900,00
3m	5.300,00	7.100,00	10.500,00	13.900,00	18.500,00	23.900,00
4m	6.500,00	8.700,00	13.000,00	17.400,00	23.000,00	29.900,00
5m	7.700,00	10.300,00	15.500,00	20.900,00	27.500,00	35.900,00
6m	8.900,00	11.900,00	18.000,00	24.400,00	32.000,00	41.900,00
Other prepared lengths, please use formula (pair):	1.200,00/m + 1.700,00	1.600,00/m + 2.300,00	2.500,00/m + 3.000,00	3.500,00/m + 3.400,00	4.500,00/m + 5.000,00	6.000,00/m + 5.900,00

Subwoofer Cables

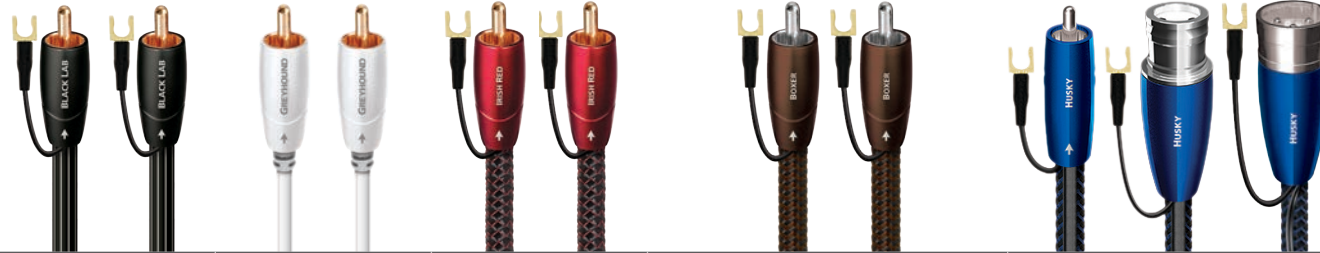

Model	Black Lab	Greyhound	Irish Red	Boxer	Husky 72V DBS
Metal	LGC	0,5% Silver		1,25% Silver	5% Silver
Conductor	Solid Conductors				
Geometry	Symmetrical Coax	HyperLitz Coax	Symmetrical Coax	Double-Balanced	Triple-Balanced
Dielectric	Foamed-Polyethylene			Polyethylene Air-Tubes	
Noise-Dissipation	Metal-Layer Noise-Dissipation			Carbon-Based Noise-Dissipation	Carbon-Based Multi-Layer Noise-Dissipation
Jacket	Black PVC with White Stripes	White PVC with Gray stripes	Up to 5m: Red/Black Braid 8m and Longer Black PVC with Red Stripes	Up to 5m: Brown/Black Braid 8m and Longer Black PVC with Brown Stripes	Blue/Black Braid or Black PVC with Blue Stripes (Any Length)
Termination	Cold-Welded, Gold-Plated			Cold-Welded, Hanging-Silver directly over pure Red Copper	
Application - Attached Chassis-Ground Connector					
RCA - RCA	Yes				
RCA/XLR Mixed	No			Yes	
XLR - XLR	No			Yes	
Length	Euro Retail	Euro Retail	Euro Retail	Euro Retail	Euro Retail
2m	42,50	59,00	89,00	179,00	339,00
3m	49,00	69,00	99,00	199,00	399,00
5m	65,00	85,00	125,00	249,00	519,00
8m	89,00	109,00	165,00	309,00	699,00
12m	119,00	139,00	215,00	399,00	939,00
16m	149,00	169,00	265,00	489,00	1.179,00
20m	179,00	199,00	315,00	569,00	1.419,00
Other prepared lengths use formula:	-	-	-	-	60,00/m + 219,00

Note: Greyhound is optimized for custom-installation projects that require its thin, discreet design. It does not include a chassis-ground connector.

Tonearm Cables



Model	WildCat Tonearm	Yosemite Tonearm ● 72v DBS	Angel Tonearm ● 72v DBS	WEL Signature Limited Edition ● 72v DBS
Metal	Solid PSC	Solid PSC+	Solid PSS	
Dielectric	Foamed-Polyethylene	FEP Air-Tubes		
Noise-Dissipation	Metal-Layer Noise-Dissipation	Carbon-Based Noise-Dissipation		Carbon-Based Multi-Layer Noise-Dissipation
Capacitance	Less than 65pF/1.5m	Less than 90pF/1.5M		
Jacket	White/Gray Braid	Green/Black Braid	Silver/Black Braid	Gray/Black PVC
Length	Euro Retail	Euro Retail	Euro Retail	Euro Retail
1,2m	-	549,00	1.299,00	2.499,00
1,5m	119,00	-	-	-
Other lengths:	-	+/- 120.00/m	+/- 500.00/m	+/- 750.00/m

Turntable Cables



Model	Golden Gate Turntable	Yosemite Turntable ● 72v DBS	Angel Turntable ● 72v DBS
Metal	Solid PSC	Solid PSC+	Solid PSS
Dielectric	Foamed-Polyethylene	FEP Air-Tubes	
Noise-Dissipation	Saturn GroundGoody Included	Carbon-Based Noise-Dissipation + Saturn GroundGoody Included	
Capacitance	Less than 90pF/1.5M		
Jacket	Red/Black Braid	Green/Black Braid	Silver/Black Braid
Length	Euro Retail	Euro Retail	Euro Retail
1,2m	-	549,00	1.299,00
1,5m	119,00	-	-



2158

audioquest
100% goat hair

Vinyl and Headphone Accessories

GroundGoody Tonearm & Ground Wires

AudioQuest GroundGoody's use Direction-Controlled Perfect-Surface Conductors and Direct-Silver Plated (#10 stud) spades to help prevent hum and efficiently drain radio-frequency noise. Partner GroundGoody with any AudioQuest RCA cable to create a low-distortion and low-noise tonearm cable.



GroundGoody Saturn

Perfect-Surface Copper+ (PSC+) Conductors

Length	Euro Retail
0,6m	27,95
1m	29,95
1,5m	31,95
2m	33,95
3m	37,95



GroundGoody Jupiter

Perfect-Surface Silver (PSS) Conductors

Length	Euro Retail
0,6m	129,00
1m	199,00
1,5m	279,00
2m	359,00
3m	519,00

Anti-Static Record Brush

Highly Conductive Carbon Fibers

Single

Euro Retail: 16,95



Super-Conductive Anti-Static Record Brush

1 248.000 Highly Conductive Carbon Fibers with No-Resistance Path to Finger-Grip

Single

Euro Retail: 29,95



HL-5 Headshell Leads

Silk-wrapped Linear-Crystal Copper Litz Conductors

Set of 4

Euro Retail: 59,95

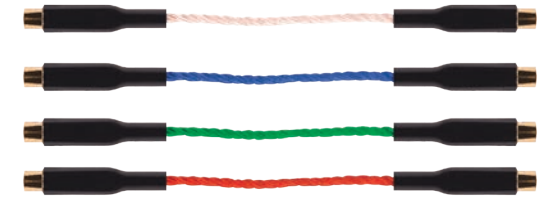

NightBird Model One

- Fits NightHawk and NightOwl Headphones
- 3,5mm Stereo Plug - 2 x 2,5mm Mono Plugs
- PSC+ Conductors
- Noise-Dissipation
- Robust: Tested to 28.000 bends

Length	Euro Retail
2m	99,00
3m	129,00
4m	159,00



Headphone Plug Adaptor

- Stereo 3.5mm Female > Stereo 6.3mm (1/4") Male
- Silver Plating Directly Over Extreme-Purity Brass
- Superior Materials and Firm Contact Pressure Ensure Ideal Signal Transfer

Euro Retail: 29,95



Perch Headphone Stand

- Easily and safely accommodates all headphones
- High-quality materials
- Heavy base provides stability

Euro Retail: 89,00



HDMI Cables

Does AudioQuest offer the right HDMI cables for 4K TVs, 8K TVs, and beyond?

Yes! All of AudioQuest's new 48Gbps HDMI cables can transfer up to professional 10K Ultra-HD video. The impressive 48Gbps data rate is made possible by four balanced audio/video pairs capable of 12Gbps each. And, of course, the latest technology is backwards compatible with 4K displays.

Video Up to 10K

AudioQuest 48Gbps HDMI cables are completely backwards compatible with existing devices and have the bandwidth required for video with resolutions up to 10K and resolutions/refresh rates up to 8K/60 and 4K/120.

HDR (High Dynamic Range)

All AudioQuest HDMI cables support HDR (High Dynamic Range) and Dynamic HDR. HDR content expands the contrast of the image for blacker blacks and brighter whites/highlights as well as greater color saturation and brightness. In addition, 4K Ultra-HD content allows for a wider color range.

This combination of technologies results in more realistic HDR images with greater perceived depth. Dynamic HDR (HDR10+ and Dolby Vision, for example) enables frame-by-frame HDR optimization rather than HDR settings that are fixed for the entire program. The most prominent current HDR formats are HDR10, HDR10+, and Dolby Vision.

AudioQuest 18Gbps and 48Gbps HDMI cables are compatible with all varieties of HDR, which can be found on Ultra-HD Blu-ray, and all major streaming services, including Netflix, Amazon Prime, Disney+, Apple TV+, and others.

ARC (Audio Return Channel) and eARC (enhanced Audio Return Channel)

HDMI's Audio Return Channel (ARC) sends audio from a TV to a soundbar or AV receiver for greater simplicity and flexibility in system setup. Hardware's previous ARC capabilities max out at lossy (compressed) 5.1-channel surround sound.

Today's HDMI 2.1 hardware supports enhanced Audio Return Channel (eARC), which increases the digital bandwidth dramatically to support uncompressed and lossless high-resolution multichannel audio, including Dolby TrueHD and Atmos, and DTS-HD Master Audio and DTS: X.

8K-10K



48G_{bps}

Not only do all current generations of AudioQuest HDMI cables have the conductors and bandwidth required for eARC's enhanced sonic capabilities, but, in order to ensure superior audio performance, the ARC-channel conductor-pair is internally controlled for direction, running in the opposite direction from the 4 pairs that carry information to the TV.

Finally, AudioQuest's eARC-Priority models include 4 Silver-Plated Forest 48-level audio/video data pairs—but with a far superior single data pair for the TV's audio output. By upgrading the ARC data path only, audiophile quality is made possible at a fraction of the cost of upgrading all 5 data pairs.



New Packaging

AudioQuest has turbo-charged all of its HDMI packaging with easy-to-read icons and explanations of the design and material elements that define each cable and its place in the line. Comparing, contrasting and selecting the right cable is easier than ever before.



1.25% SILVER

Solid Conductors

Solid Long-Grain Copper, Silver-Plated Copper, or Perfect-Surface Silver maximize Noise-Dissipation and overall performance.

LEVEL 3 Carbon Mesh-Network

Noise Dissipation

Six Levels of Noise-Dissipation (ND) combat distortion caused by RF Noise contaminating digital and analog circuitry.

eARC

1.25% Silver Level-3 ND

Because sound is where all the emotion and drama comes from, AQ's eARC channel gets 100% the same love as the four AV channels.

Limited

Lifetime Warranty

We've got your back. Performance backed by reliability.

48G bps

4 x 12 = 48 TMDs or FRL

The 48Gbps necessary for all of HDMI's new and future features is made possible by upgrading the 4 AV channels from 6 to 12Gbps.

HDMI A/V Cables

18Gbps 4K-8K and 48Gbps 8K-10K

- All models use Solid Signal and Ground-Reference Conductors.
- All 19 conductors (A/V, eARC, Ground-Reference Drains, Control, Power) are Direction-Controlled.
- AudioQuest "48" HDMI cables have the bandwidth required for video with resolutions up to 10K, resolutions/refresh rates up to 8K/60 and 4K/120.



Model	BlueBerry 18	Pearl 48	Forest 48	Cinnamon 48	Carbon 48	Vodka 48	ThunderBird 48	FireBird 48 ● 72v DBS	Dragon 48 ● 72v DBS
A/V Conductor	Solid Long-Grain Copper (LGC)		0.5% Silver	1.25% Silver	5% Silver	10% Silver		100% PSS Silver	
eARC Conductor	Solid Long-Grain Copper (LGC)		0.5% Silver	1.25% Silver	5% Silver	10% Silver		100% PSS Silver	
Ground Reference	Tinned Copper			0.5% Silver	1.25% Silver	5% Silver	10% Silver	10% Silver	100% PSS Silver
Noise-Dissipation	All 19 Conductors Direction-Controlled			Metal-Layer + Direction	Carbon + Metal + Direction		Graphene + Global Carbon + Direction	72v DBS, Graphene + Global Carbon + Direction	
Jacket 0.6m - 2.0m	PVC			Red Braid	Carbon Braid	Blue Braid	Blue Braid	Red Braid	Black Braid
Jacket 3.0m	PVC			Red Braid or PVC	Carbon Braid	Blue Braid	Blue Braid	Red Braid	Black Braid
Jacket 5.0m	PVC			-	-	-	-	-	-
Length	Euro Retail	Euro Retail	Euro Retail	Euro Retail	Euro Retail	Euro Retail	Euro Retail	Euro Retail	Euro Retail
0,6m	29,95	35,00	69,00	99,00	179,00	349,00	649,00	1.349,00	2.199,00
1,0m	34,95	39,00	79,00	129,00	199,00	399,00	749,00	1.599,00	2.499,00
1,5m	39,95	49,00	89,00	169,00	249,00	479,00	899,00	1.899,00	2.999,00
2,0m	44,95	59,00	99,00	189,00	299,00	559,00	1.049,00	2.199,00	3.499,00
3,0m	59,95	79,00	139,00	249,00	399,00	699,00	1.349,00	2.899,00	4.499,00
5,0m	99,95	179,00	289,00	429,00	-	-	-	-	-

BlueBerry 18, Pearl 48, and Forest 48 are also sold in Installer Packs. See page 59.

For long-length models (Pearl 18, Forest 18, Root Beer 18 and Cherry Cola 18), see page 37.

HDMI A/V Long-Distance Cables

18Gbps 4K-8K

- Pearl 18 and Forest 18 employ active frequency equalization to enable 18Gbps performance for lengths up to 50ft (15m).
- Cherry Cola 18 active optical cable provides 18Gbps performance for lengths up to 100ft (30m).



Model	Pearl 18 Long Distance	Forest 18 Long Distance	Root Beer 18 Optical	Cherry Cola 18 Optical
A/V Conductor	LGC	0,5% Silver	Quartz-Glass	
eARC Conductor	LGC	0,5% Silver	LGC	0,5% Silver
Ground Reference	Tinned Copper			0,5% Silver
Noise-Dissipation	All 19 Conductors Direction-Controlled		Direction + Galvanic Isolation	Carbon + Galvanic Isolation
Jacket	PVC			
Length	Euro Retail	Euro Retail	Euro Retail	Euro Retail
5,0m	-	-	469,00	799,00
7,5m	219,00	339,00	-	-
10,0m	269,00	419,00	499,00	899,00
12,5m	329,00	499,00	-	-
15,0m	429,00	-	559,00	999,00
20,0m	-	-	619,00	1.099,00
25,0m	-	-	679,00	1.199,00
30,0m	-	-	739,00	1.299,00

HDMI A/V eARC-Priority Cables

48Gbps 8K-10K

- For systems that use a TV's eARC/ARC output as the audio source to a soundbar or receiver, AudioQuest's eARC-Priority models offer world-class performance at the friendliest possible prices.



Model	Vodka eARC Priority 48	ThunderBird eARC Priority 48	Dragon eARC Priority 48 72v DBS
A/V Conductor	0,5% Silver		
eARC Conductor	10% Silver		100% PSS Silver
Ground Reference	5% Silver eARC	10% Silver eARC	100% PSS Silver eARC
Noise-Dissipation	Carbon + Metal + Direction	Graphene + Global Carbon + Direction	72v DBS, Graphene + Global Carbon + Direction
Jacket 0.6m - 2.0m	Blue Braid	Blue Braid	Black Braid
Jacket 3.0m	PVC		
Length	Euro Retail	Euro Retail	Euro Retail
0,6m	169,00	349,00	999,00
1,0m	189,00	399,00	1.099,00
1,5m	219,00	449,00	1.249,00
2,0m	249,00	499,00	1.499,00
3,0m	299,00	599,00	1.999,00

For 0.6m - 5.0m length models, see page 36.

HDMI Accessories



HDMI 90°/W Adaptor
Wide Side [W]
Right Angle Bend

Euro Retail: 19,95



HDMI 90°/N Adaptor
Narrow Side [N]
Right Angle Bend

Euro Retail: 19,95



HDMI 90° NU/R Flat Adaptor
Narrow Up [NU]
Bends Right

Euro Retail: 19,95

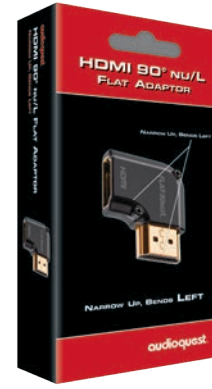

HDMI 90° NU/L Flat Adaptor
Narrow Up [NU]
Bends Left

Euro Retail: 19,95



HDMI A ↔ C Adaptor
Standard [Type A] to
Mini [Type C]

Euro Retail: 19,95



HDMI A ↔ D Adaptor
Standard [Type A] to
Micro [Type D]

Euro Retail: 19,95



HDMI A → C/D Adaptor
Standard [Type A] to Mini [C]
and Micro [D]

Euro Retail: 19,95



HDMI A ↔ A Coupler
Female HDMI to Female
HDMI

Euro Retail: 19,95

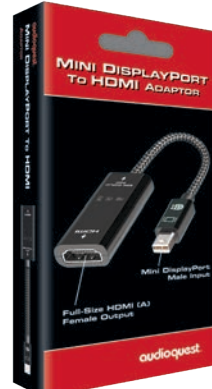

**Mini Display Port to
HDMI 4K Adaptor**

Euro Retail: 36,95



**DVI-IN > HDMI-OUT
Adaptor**

F-DVI to M-HDMI

Euro Retail: 34,95

Certain HDMI Adaptors are also sold in Installer Packs. See page 59.

Digital-Audio Interconnect Cables

Perfect Sound Forever?

That bold statement introduced CD players to the world back in 1983. Those claiming perfection believed ones and zeros to be so beyond reproach that traditional concerns about the integrity of the playback system had become irrelevant overnight. But the CD wasn't close to perfect. Those who listened quickly figured out that the equipment and cables in the audio system mattered every bit as much as they had in the analog era.

However, to this day, stating the truth in public that digital-audio cables can make minor to even staggering differences in an audio system's performance is like yelling, "food fight" in a crowded cafeteria—you'd better get ready to duck because there will be incoming.

Yet, the same kind of music lovers and listeners who heard the CD for what it is also know that soul-satisfying digital-audio playback requires the best digital-audio cables. And the best cables reduce the most noise and distortion.

Today, there are more ways to consume digital audio than ever. Many gave up silver discs for the convenience of inferior-sounding compressed downloads, and now we've seemingly got the best of both convenience and performance: We are able to stream high-res files to our phones and mobile devices and into our homes.

AudioQuest's digital-audio cables employ all of our proven techniques for minimizing noise and distortion: better metals, better geometry, better dielectric, Dielectric-Bias System (DBS), Noise-Dissipation, Direction-Controlled Conductors, and other ingredients needed for optimizing each specific application.

The digital future is brighter and more beautiful sounding than ever...*if* your digital-audio cables are capable of treating fragile audio data as it deserves to be treated—that is, with the love and respect reserved for music.





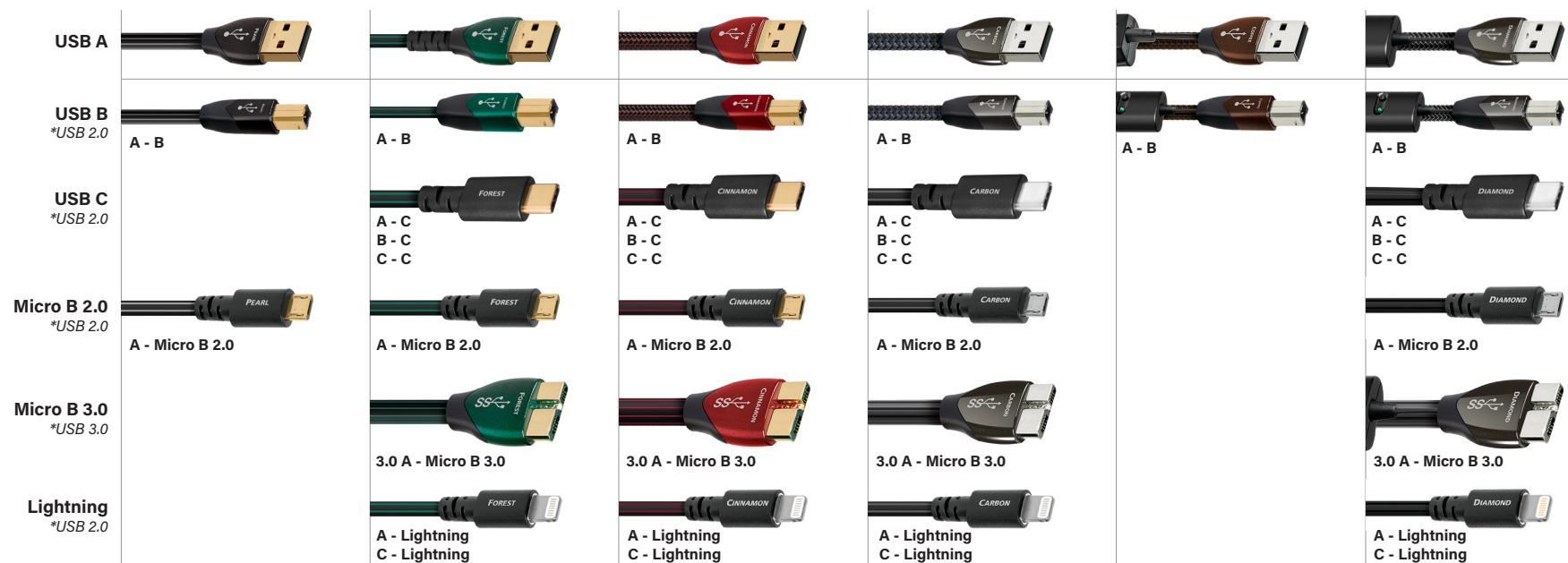











Digital-Audio Interconnects: USB Cables



Model	Pearl	Forest	Cinnamon	Carbon	Coffee ● 72V DBS	Diamond ● 72V DBS
Metal (USB A-B)	Solid LGC	Solid 0,5% Silver	Solid 1,25% Silver	Solid 5% Silver	Solid 10% Silver	Solid 100% PSS
Metal (All Other Versions)	LGC Semi-Solid Concentric	0,5% Silver Semi-Solid Concentric	1,25% Silver Semi-Solid Concentric	5% Silver Semi-Solid Concentric	N/A	Solid 100% PSS
Dielectric	Hard-Cell Foam					
Noise-Dissipation	Metal-Layer Noise-Dissipation			Carbon-Based Noise-Dissipation for USB A - B and USB 3.0 A - 3.0 Micro		
Jacket	Black PVC with White Stripes	Black PVC with Green Stripes	USB A-B: Red/Black Braid All others: Black PVC with Red Stripes	Gray/Black Braid	Brown/Black Braid	USB A-B: Silver/Black Braid All others: Black PVC with Silver Stripes
Available Configurations	USB A - B USB A - Micro B	USB A - B, USB A - C USB A - Micro B 2.0 USB A - Lightning USB 3.0 A - Micro B 3.0 USB B - C, USB C - C USB C - Lightning	USB A - B, USB A - C USB A - Micro B 2.0 USB A - Lightning USB 3.0 A - Micro B 3.0 USB B - C, USB C - C USB C - Lightning	USB A - B, USB A - C USB A - Micro B 2.0 USB A - Lightning USB 3.0 A - Micro B 3.0 USB B - C, USB C - C USB C - Lightning	USB A - B	USB A - B, USB A - C USB A - Micro B 2.0 USB A - Lightning USB 3.0 A - Micro B 3.0 USB B - C, USB C - C USB C - Lightning
Length	Euro Retail	Euro Retail	Euro Retail	Euro Retail	Euro Retail	Euro Retail
0,75m	39,00	65,00	89,00	169,00	369,00	649,00
1,5m	49,00	79,00	109,00	219,00	449,00	799,00
3m	69,00	109,00	149,00	319,00	599,00	1.099,00
5m	99,00	149,00	199,00	449,00	799,00	1.499,00

AudioQuest USB Connector Applications

<p>USB A</p>   <p>For all devices that use the original USB connection. *USB 2.0</p>	<p>USB B</p>   <p>Typically for use with computer peripherals, such as hard drives and network devices, as well as digital-audio components, including DACs and streamers. *USB 2.0</p>	<p>USB C</p>   <p>Typically for use with newer devices, including desktops, laptops, smartphones, tablets, game consoles, hard drives, and more. *USB 2.0</p>	<p>Micro B 2.0</p>   <p>Typically for use with compact and mobile devices, including Android smartphones and computer peripherals. *USB 2.0</p>	<p>USB 3.0 A</p>   <p>SuperSpeed USB for transferring data at up to 5Gbps. *USB 3.0</p>	<p>Micro B 3.0</p>   <p>SuperSpeed USB for transferring data at up to 5Gbps, typically for use with smartphones, tablets, and computer peripherals. *USB 3.0</p>	<p>Lightning</p>   <p>For use with Apple devices, including iPhones and iPads. *USB 2.0</p>
---	--	--	---	--	---	--

USB Accessories



USB A → C Adaptor

*USB 3.0 A to USB 3.1 Type C

Euro Retail: 21,95



USB B ↔ Micro B 2.0 Adaptor

Euro Retail: 16,95



USB Mini B ↔ Micro B 2.0 Adaptor

Euro Retail: 16,95



JitterBug FMJ

USB 2.0 Noise Filter (Data & Power)

Euro Retail: 69,00



Digital-Audio Interconnects: Optical Cables

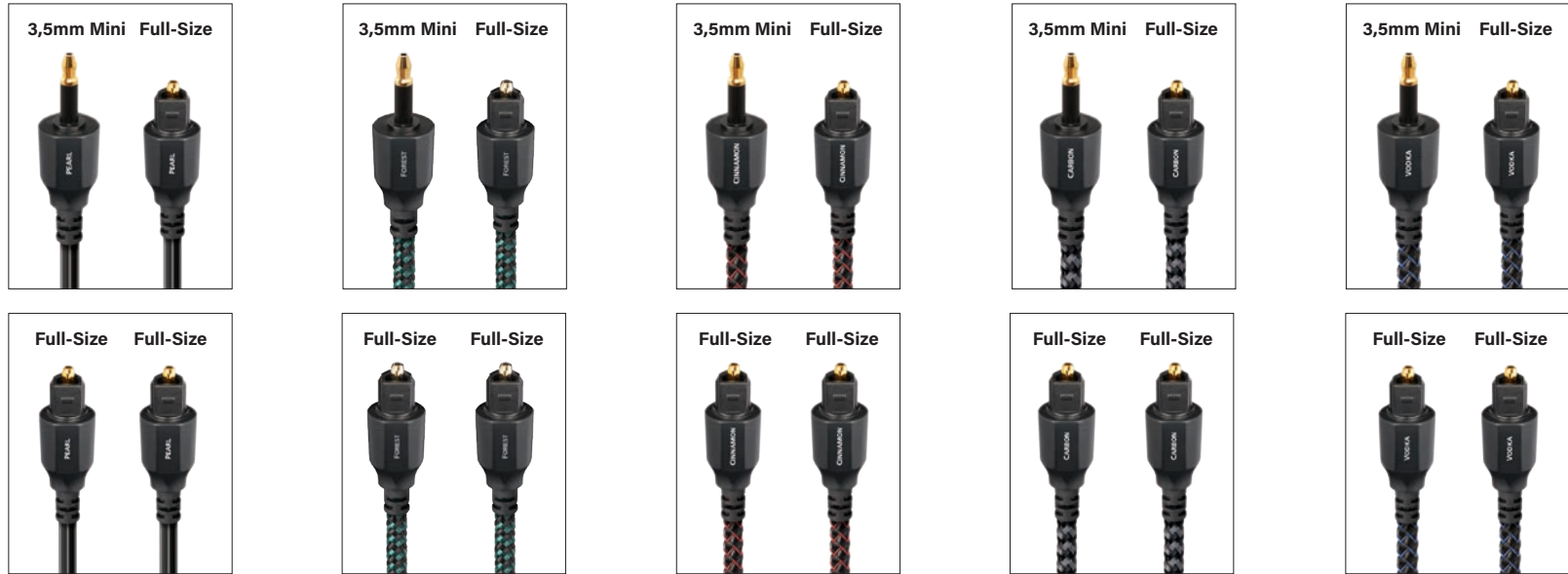

Model	Pearl	Forest	Cinnamon	Carbon	Vodka
Conductors	Low-Dispersion Fiber		Lower-Dispersion Higher-Purity Fiber	19 Narrow-Aperture Synthetic Fibers	217 Narrow-Aperture Synthetic Fibers
Jacket	Black PVC with Gray Stripes	0,75m and 1,5m: Green/Black Braid 3,0m and Longer: PVC	0,75m and 1,5m: Red/Black Braid 3,0m and Longer: PVC	Gray/Black Braid 8,0m and Longer: PVC	Blue/Black Braid 8,0m and Longer: PVC
Length	Euro Retail	Euro Retail	Euro Retail	Euro Retail	Euro Retail
0,75m	29,00	49,00	79,00	129,00	249,00
1,5m	35,00	59,00	99,00	169,00	329,00
3m	49,00	89,00	139,00	229,00	459,00
5m	69,00	129,00	199,00	329,00	689,00
8m	99,00	179,00	289,00	449,00	849,00
12m	139,00	259,00	409,00	629,00	1.099,00
16m	179,00	339,00	529,00	799,00	1.349,00

Optical Pearl, Forest, and Cinnamon are also sold in Installer Packs. See page 58.

Optical Accessory



Optical Mini Adaptor

Euro Retail: 16,95

Digital-Audio Interconnects: Digital Coax Cables



Model	Forest	Cinnamon	Carbon	Coffee ● 72V DBS	Diamond ● 72V DBS	Wild ● 72V DBS	WEL Signature ● 72V DBS
Metal	0,5% Silver	1,25% Silver	5% Silver	10% Silver	100% PSS		
Conductor	Solid Conductors						
Gauge	0,2mm ²			0,41mm ²			
Dielectric	Hard-Cell Foam						
Noise-Dissipation	Metal-Layer Noise-Dissipation		Carbon-Based Multi-Layer Noise-Dissipation			Carbon-Based Multi-Layer Noise-Dissipation, 2 x EMI Absorption	Carbon-Based Multi-Layer Noise-Dissipation, 3 x EMI Absorption
Jacket	Black PVC with Green Stripes	Red/Black Braid	Black/Dark Gray Braid	Brown/Black Braid	Silver/Black Braid	Navy Blue Braid	Black Braid
Terminations	Cold-Welded, Gold-Plated		Cold-Welded, Hanging-Silver Directly Over Pure Purple Copper	Cold-Welded, Hanging-Silver Directly Over Pure Red Copper		Cold-Welded, Hanging-Silver Directly Over Machined Pure Red Copper	
Shield	Foil + Tinned Braid	Foil + Silver-Plated Braid		Silver-Plated Braid		Copper Foil + 100% PSS-Silver Spiral	
Length	Euro Retail	Euro Retail	Euro Retail	Euro Retail	Euro Retail	Euro Retail	Euro Retail
0,75m	35,00	79,00	229,00	549,00	1.079,00	2.255,00	3.740,00
1m	-	-	249,00	599,00	1.199,00	2.475,00	4.125,00
1,5m	39,00	99,00	289,00	699,00	1.449,00	2.915,00	4.895,00
2m	-	-	329,00	799,00	1.699,00	3.355,00	5.665,00
3m	49,00	139,00	409,00	999,00	2.199,00	4.235,00	7.205,00
5m	69,00	199,00	569,00	1.399,00	3.199,00	5.995,00	10.285,00
Other prepared lengths use formula:	-	-	80,00/m + 169,00	200,00/m + 399,00	500,00/m + 699,00	880,00/m + 1.595,00	1.540,00/m + 2.585,00

Digital Coax Forest is also sold in Installer Packs. See page 59.

Digital Coax Accessory



RCA > BNC

Female RCA to Male BNC Adaptor

Euro Retail: 9.95

Digital-Audio Interconnects: AES/EBU Cables



Model	Carbon	Diamond 72V DBS	Wild 72V DBS	WEL Signature 72V DBS
Metal	5% Silver		100% PSS	
Conductor	Solid Conductors			
Gauge	0,2mm ²		0,41mm ²	
Dielectric	Hard-Cell Foam			
Noise-Dissipation	Carbon-Based Multi-Layer Noise-Dissipation		Carbon-Based Multi-Layer Noise-Dissipation, 2 x EMI Absorption	Carbon-Based Multi-Layer Noise-Dissipation, 3 x EMI Absorption
Jacket	Dark Gray/Black Braid	Silver/Black Braid	Navy Blue Braid	Black Braid
Termination	Cold-Welded, Hanging-Silver Directly Over Pure Purple Copper	Cold-Welded, Hanging-Silver Directly Over Pure Red Copper	Cold-Welded, Hanging-Silver Directly Over Machined Pure Red Copper	
Shield	Foil + Tinned Braid		Foil + Silver-Plated Spiral	
Length	Euro Retail	Euro Retail	Euro Retail	Euro Retail
0,75m	229,00	1.079,00	2.255,00	3.740,00
1m	249,00	1.199,00	2.475,00	4.125,00
1,5m	289,00	1.449,00	2.915,00	4.895,00
2m	329,00	1.699,00	3.355,00	5.665,00
3m	409,00	2.199,00	4.235,00	7.205,00
5m	569,00	3.199,00	5.995,00	10.285,00
Other prepared lengths use formula:	80,00/m + 169,00	500,00/m + 699,00	880,00/m + 1.595,00	1.540,00/m + 2.585,00

Digital-Audio Interconnects: Ethernet Cables (RJ/E)



Model	Pearl	Forest	Cinnamon	Vodka	Diamond 72V DBS
Metal	LGC	0,5% Silver	1,25% Silver	10% Silver	100% PSS
Conductor	Solid Conductors				
Dielectric	Geometry Stabilizing Solid High-Density Polyethylene				
Noise-Dissipation	Direction-Controlled Conductors			Carbon-Based Noise-Dissipation	
Jacket	Black PVC with Gray Stripes	Black PVC with Green Stripes	Up to 3.0m: Red/Black Braid 5.0m and Longer: Black PVC with Red Stripes	Up to 3.0m: Blue/Black Braid 5.0m and Longer: Black PVC with Blue Stripes	Silver/Black Braid
Termination	Gold-Plated Nickel Connectors with 100% Shield Coverage			Precision-Made Low-Loss Ultra-Wide Bandwidth Telegärtner Connectors with 100% Shield Coverage and Strain Relief	
Length	Euro Retail	Euro Retail	Euro Retail	Euro Retail	Euro Retail
0.75m	39,00	59,00	99,00	449,00	999,00
1.5m	49,00	79,00	119,00	599,00	1.599,00
3m	69,00	109,00	159,00	849,00	2.899,00
5m	99,00	149,00	209,00	1.199,00	4.699,00
8m	139,00	209,00	289,00	1.699,00	7.399,00
12m	199,00	289,00	389,00	2.349,00	10.999,00

Ethernet (RJ/E) Pearl, Forest and Cinnamon are also sold in Installer Packs. See page 59.

Accessories



Level-X Noise-Dissipation “pulls” RF Noise out of the cable, preventing noise from capacitively coupling to the audio conductors—thereby preventing audio-circuit misbehavior.

72v Dielectric-Bias System (DBS)
AudioQuest’s multi-patented DBS creates a strong, stable electrostatic field which saturates and polarizes (organizes) the molecules of the insulation. This minimizes the nonlinear time delays, resulting in clearer sound emerging from a “blacker” background.

Level-X Noise Dissipation (72V) Dielectric-Bias Pack

Built-In “RF Trap” provides instant sonic improvement

Euro Retail Each: 139,00



CleanScreen Kit

150 ml Bottle + 10 ml Spray + Retractable Brush + 2 x Microfiber Cloth

Euro Retail: 29,95



Sorbothane Self-Stick Sheet

15.24cm x 15.24cm x 0.25cm sheet can be cut to size to damp anything, especially effective on top surface of speaker stands.

Euro Retail: 49,95



SorboGel Q-Foot



Foot Tray

SorboGel Q-Feet System

Set of 4 energy-absorbing feet each with a “tray” which improves performance and protects furniture. Each foot supports up to 4 kg.

Euro Retail: 129,00

Accessories



RCA \leftrightarrow BNC Adaptor
Female RCA to/from Male BNC

Euro Retail: 9,95



F > RCA Male Adaptor
Female RCA to Male RCA

Euro Retail: 12,95



F > BNC Male Adaptor
75 Ω

Euro Retail: 12,95



F > 2F Splitter
3GHz 75 Ω

Euro Retail: 19,95



F > 4F Splitter
3GHz 75 Ω

Euro Retail: 25,95



F \leftrightarrow F
75 Ω Coupler

Euro Retail: 9,95



F-90 $^\circ$
Male \leftrightarrow Female Adaptor

Euro Retail: 12,95

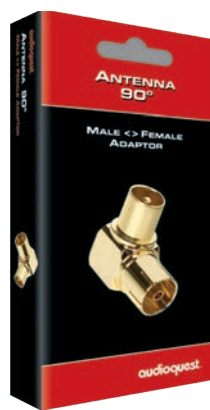

Antenna 90 $^\circ$
Male \leftrightarrow Female Adaptor

Euro Retail: 9,95

Antenna Cable



Model	Antenna Forest
Conductor	Solid 0.5% Silver
Shield	3-Layer Shield: Foil + 90% Braid + Foil
Jacket	Dark Gray with Green Stripes
Application	
Male Coax - Male Coax	Yes
Male Coax - Female Coax	Yes
Female Coax - Female Coax	Yes
F - F	Yes
Length	Euro Retail
1.5m	39,75
3.0m	49,50
4.5m	59,25

Accessories

RCA-300

Fits cables up to 7,0mm O.D.
Male Gold-Plated. Female Silver-Plated
Requires soldering.



#300 Male
Set of 4
Euro Retail: 24,95

#300 Female
Set of 4
Euro Retail: 23,95

RCA-800

Fits cables up to 9,0mm O.D.
Direct-Silver Plated. Requires soldering.



#800 Male
Set of 4
Euro Retail: 69,95

XLR Connectors

Fits cables up to 9,0mm O.D.
Direct-Silver Plated. Requires soldering.



#81 Male
Pair
Euro Retail: 59,95

#80 Female
Pair
Euro Retail: 59,95

Right-Angle F, RCA & BNC Plugs

Fits cables up to 7,5mm O.D.
Requires soldering.



F-90°
Gold-Plated

Euro Retail Per Pair: 24,95

RCA-90°
Gold-Plated

Euro Retail Per Pair: 24,95

AQ Silver Solder

Easy to use.
Clearly sounds better



454g Solder

Euro Retail: 220,00

113.5g Solder

Euro Retail: 60,00

Accessories



RJ45 Noise-Stopper Caps

AQ Noise-Stopper Caps fit over unused RJ45 inputs or outputs, preventing RFI and EMI noise from entering the active circuit. Noise-Stopper Caps also protect against dust and corrosion.

Set of 4
Euro Retail: 29,95



USB-A Noise-Stopper Caps

AQ Noise-Stopper Caps fit over unused USB inputs or outputs, preventing RFI and EMI noise from entering the active circuit. Noise-Stopper Caps also protect against dust and corrosion.

Set of 4
Euro Retail: 29,95



HDMI Noise-Stopper Caps

AQ Noise-Stopper Caps fit over unused HDMI inputs or outputs, preventing RFI and EMI noise from entering the active circuit. Noise-Stopper Caps also protect against dust and corrosion.

Set of 4
Euro Retail: 29,95



XLR Input (Female) Noise-Stopper Caps

Blocks a significant path for incoming high-frequency energy to interfere with circuit performance.

Euro Retail Per Pair: 39,95

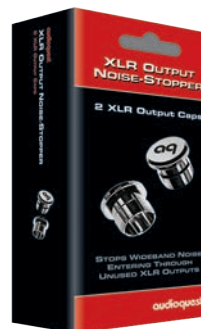

XLR Output (Male) Noise-Stopper Caps

Blocks a significant path for incoming high-frequency energy to interfere with circuit performance.

Euro Retail Per Pair: 39,95

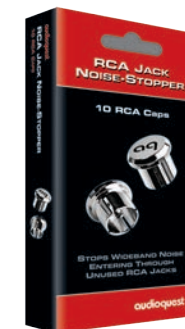

RCA Noise-Stopper Caps

Blocks a significant path for incoming high-frequency energy to interfere with circuit performance.

Set of 10
Euro Retail: 49,95

Analog-Audio Interconnect Accessories

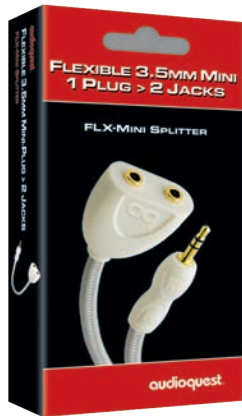

FLX-Mini Splitter
 3.5mm Mini Male Stereo >
 (2) 3.5mm Female Stereo
Metal: Solid PSC+
Length: 15cm

Euro Retail: 19,95



FLX-Mini/RCA Adaptor
 3.5mm Mini Male Stereo <>
 2 Female RCA (L & R)
Metal: Solid PSC+
Length: 15cm

Euro Retail: 19,95

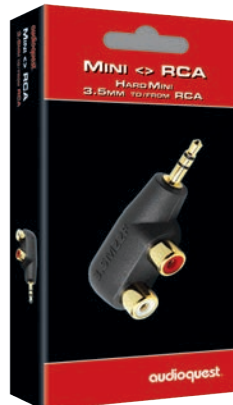

Hard Mini/RCA Adaptor
 Hard Mini 3.5mm Male <>
 2 Female RCA (L & R)
 (Not for Bridges & Falls)

Euro Retail: 19,95



FLX-X RCA Splitter
 RCA Male >
 2 Female RCA (L & R)
Metal: SolidLGC
Length: 15cm

Euro Retail: 19,95



FLX-X RCA Splitter
 RCA Female >
 2 Male (L & R)
Metal: Solid LGC
Length: 15cm

Euro Retail: 19,95

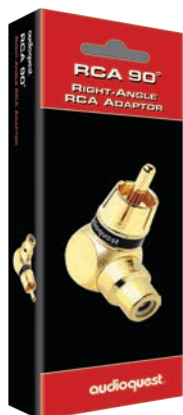

M21F-90 Adaptor
 Female RCA to Right Angle
 Male RCA

Euro Retail: 12,95



Hard RCA Splitter
 Male RCA > 2 Female RCA

Euro Retail: 15,95



RCA - RCA Coupler
 Female RCA <> Female RCA

Euro Retail: 9,95



PreAmp Jumpers
 Solid Perfect-Surface Copper+ (PSC+) conductors
 in Polyethylene Air-Tubes. Replaces factory fitted
 "U" jumpers on integrated amps and receivers.

Euro Retail: 39,95

Instant Tool-less Connectors (ITC) for analog-audio, mini-coax, and RG6 cables on spools

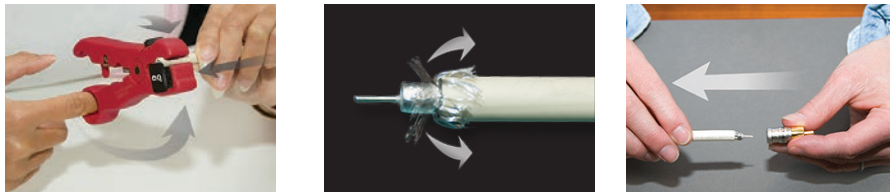

ITC One-Step Stripper for 18 and 24 AWG
For HD6, ITA, and ITV Cables

Euro Retail: 19,95

18 AWG connectors and cables for video, RF, digital, subwoofer



ITC-18G/RCA

Euro Retail per piece: 3,00

Supplied in bags of 50



ITC-18G/F

Euro Retail per piece: 3,00

Supplied in bags of 50



ITC-18G/BNC

Euro Retail per piece: 4,00

Supplied in bags of 50



ITC-18G EU/Coax M

Euro Retail per piece: 3,50

Supplied in bags of 50



ITC-18G EU/Coax F

Euro Retail per piece: 3,50

Supplied in bags of 50

24 AWG connectors and cables for analog-audio and video



ITC-24G/RCA

Euro Retail per piece: 3,00

Supplied in bags of 50



ITC-24G/F

Euro Retail per piece: 3,00

Supplied in bags of 50



ITC-24G/BNC

Euro Retail per piece: 4,00

Supplied in bags of 50

Coax	HD6 Pearl	HD6 Forest	HD6 Carbon
Metal	Solid Conductive-Coated Copper	Solid 0,5% Silver	Solid 5% Silver
Shield	3-Layer Shield: Foil + 90% Braid + Foil		4-Layer Shield: Carbon-Loaded PE + Foil + 90% Braid + Foil
Jacket	Dark Gray or White Striped	Gray, Green or White Striped	Black, Gray, or White Striped
Length	Euro Retail	Euro Retail	Euro Retail
76m	-	-	12,50/m
152m	3,00/m	6,50/m	-

Audio	ITA-1/1	ITA-3/3	ITA-5/5
Center Conductor Metal	Solid LGC	Solid PSC	Solid PSC+
Neg. Conductor/ Shield	LGC HyperLitz	PSC HyperLitz	PSC+ HyperLitz
Jacket	Blue	Green	Dark Gray
Length	Euro Retail	Euro Retail	Euro Retail
15m	10,00/m	-	-
76m	10,00/m	20,00/m	30,00/m
152m	10,00/m	-	-

Color bands for 18 and 24 AWG ITC connectors

Silicon rubber bands fit all ITC connectors—even after they're attached to the cable—for easy cable identification. Available in bags of 20. One color per bag - no mixed colors. Available in 10 colors.

Bag of 20
Euro Retail:
4,00



In-Wall Rated Bulk Speaker Cables

16/2 + 14/2 16/4 + 14/4

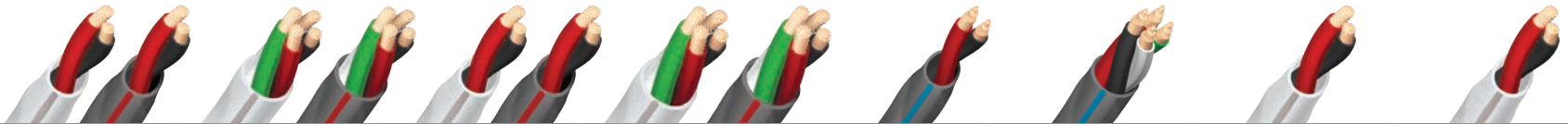

Model	SLiP-DB 16/2	SLiP-DB 16/4	SLiP-DB 14/2	SLiP-DB 14/4	SLiP XTRM 14/2	SLiP XTRM 14/4	SLiP-LSZH 16/2	SLiP-LSZH 14/2
Metal	Semi-Solid Concentric LGC				Semi-Solid True Concentric PSC and LGC		Semi-Solid Concentric LGC	
Gauge	1,31mm ²		2,08mm ²					
Jacket	White PVC with Silver Stripes or Gray PVC with Red Stripes				Dark Gray PVC with Blue Stripes		LSZH (Low Smoke Zero Halogen) White PVC with Silver Stripes	
Length	Euro Retail	Euro Retail	Euro Retail	Euro Retail	Euro Retail	Euro Retail	Euro Retail	Euro Retail
50m	-	-	-	-	20,00/m	-	-	-
100m	-	-	-	-	20,00/m	40,00/m	-	-
152m	4,75/m	7,75/m	6,00/m	10,50/m	-	-	6,50/m	7,75/m

Note: For 100m & 152m spools, retail price per meter is listed.

Non-Rated Bulk Speaker Cables

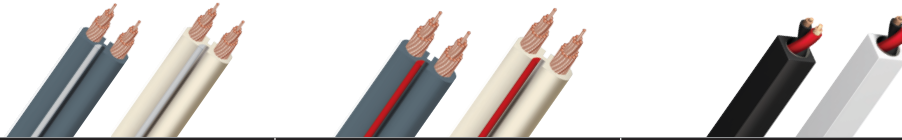

Model	G2	X2	Q2
Metal	Semi-Solid Concentric LGC		
Gauge	1,31mm ²	2,08mm ²	1,65mm ²
Jacket	Dark Gray PVC or White PVC	Dark Gray PVC or White PVC	Black PVC or White PVC
Length	Euro Retail	Euro Retail	Euro Retail
10,0m - White Only	57,50	-	-
30,0m Pack - White Only	172,50	-	-
100m	5,75/m	8,25/m	11,50/m

Note: For 100m spools, retail price per meter is listed. Other packaged lengths are shown with retail price per pack.



Model	Rocket 11	Rocket 22	Rocket 33	Rocket 44	Rocket 88
Metal	Semi-Solid True-Concentric LGC	Semi-Solid True-Concentric PSC and LGC	Solid PSC and LGC	Solid PSC+ and PSC	Solid PSC+
Gauge	2,62mm ²	3,31mm ²	2,08mm ²	2,62mm ²	
Geometry	Double-Spiral		Double Star-Quad		
Dielectric	PVC		Foamed-Polyethylene (For All Positive Conductors)		
Noise-Dissipation	No		Carbon-Based Noise-Dissipation		
Jacket	Black PVC with Grey Stripes or White PVC with Grey Stripes	Black PVC with Blue Stripes or White PVC with Blue Stripes	Black PVC with Red Stripes	Satin Black PVC with Matte Black Stripes	Black PVC with Green Stripes
Single BiWire Capable	Yes				
Length	Euro Retail	Euro Retail	Euro Retail	Euro Retail	Euro Retail
50m	15,00/m	40,00/m	50,00/m	85,00/m	130,00/m
100m	15,00/m	40,00/m	50,00/m	-	-

Note: For 50m & 100m spools, retail price per meter is listed.

SureGrip® Speaker Connectors

Fits up to 6.63mm² Speaker Cables



SureGrip® 100 Banana
Direct-Silver or Gold over Beryllium-Copper

Set of 8
Euro Retail: 49,95

Set of 12
Euro Retail: 74,95

Bag of 80
Euro Retail: 499,50

Bag of 120
Euro Retail: 749,50

SureGrip® 100 Multi-Spade
Direct-Silver or Gold Plating over Purple Copper

Set of 8
Euro Retail: 49,95

Set of 12
Euro Retail: 74,95

Bag of 80
Euro Retail: 499,50

Bag of 120
Euro Retail: 749,50

Allen Tool Included



SureGrip® 300 Banana
Direct-Silver or Gold over Beryllium-Copper

Set of 4
Euro Retail: 49,95

Tray of 40
Euro Retail: 499,90

SureGrip® 300 Multi-Spade
Direct-Silver or Gold Plating over Purple Copper

Set of 4
Euro Retail: 49,95

Tray of 40
Euro Retail: 499,50

Allen Tool Included

BASS
TREBLE
AMP
SPEAKER

Black Labels Included



500 Series Banana or Multi-Spade
Hanging-Silver or Hanging-Gold directly over pure Purple Copper.

Set of 4 (Full Range)
Euro Retail: 119,00

Set of 6 (Single BiWire)
Euro Retail: 179,00

Combination Allen and Phillips Tool Included



1000 Series Banana or Multi-Spade
Hanging-Silver directly over pure Red Copper.









Set of 4 (Full Range)
Euro Retail: 199,00

Set of 6 (Single BiWire)
Euro Retail: 299,00

Combination Allen and Phillips Tool Included

Spade, Pin, and Banana Connectors

Supplied with Red and Black "Boots" (except 1002)

 <p>1410/S 1410/G Direct-Silver Plated and Direct-Gold Plated Up to 2,08mm² 4,76mm Binding Post</p> <p>Set of 4 Pack of 40 Euro Retail: 17,95 Euro Retail: 179,50</p>	 <p>1010/S 1010/G Direct-Silver Plated and Direct-Gold Plated Up to 5,26mm² 4,76mm Binding Post</p> <p>Set of 4 Pack of 40 Euro Retail: 17,95 Euro Retail: 179,50</p>	 <p>1414/S 1414/G Direct-Silver Plated and Direct-Gold Plated Up to 2,08mm² 6,35mm Binding Post</p> <p>Set of 4 Pack of 40 Euro Retail: 17,95 Euro Retail: 179,50</p>
 <p>1014/S 1014/G Direct-Silver Plated and Direct-Gold Plated Up to 2,08mm² 6,35mm Binding Post</p> <p>Set of 4 Pack of 40 Euro Retail: 17,95 Euro Retail: 179,50</p>	 <p>1056/S 1056/G Direct-Silver Plated and Direct-Gold Plated Up to 5,26mm² 7,94mm Binding Post</p> <p>Set of 4 Pack of 40 Euro Retail: 17,95 Euro Retail: 179,50</p>	 <p>P10M/S P10M/G Hanging-Silver and Hanging Gold Up to 5,26mm² 6,35mm and 7,94mm Binding Post</p> <p>Set of 4 Pack of 40 Euro Retail: 15,00 Euro Retail: 150,00</p>
 <p>BP10/S BP10/G Direct-Silver Plated and Direct-Gold Plated Up to 5,26mm² Bendable Pin Fits Almost Everything</p> <p>Set of 4 Pack of 40 Euro Retail: 12,50 Euro Retail: 125,00</p>	 <p>Crimp-BFA/S Crimp-BFA/G Direct-Silver Plated and Direct-Gold Plated Up to 6,63mm² Standard Banana Jack</p> <p>Set of 4 Bag of 40 Euro Retail: 20,00 Euro Retail: 200,00</p>	 <p>1002/S 1002/G Direct-Silver Plated and Direct-Gold Plated Up to 6,63mm² Standard Banana Jack</p> <p>Set of 4 Pack of 40 Euro Retail: 40,00 Euro Retail: 400,00</p>

Termination "Pants" for Speaker Cables

Model	Full-Range	Single BiWire
	Euro Retail	Euro Retail
Rocket 11 Pants set of 4	12,95	12,95
Rocket 22 Pants set of 4	12,95	12,95
Rocket 33 Pants set of 4	12,95	12,95
Rocket 44 Pants set of 4	12,95	12,95
Rocket 88 Pants set of 4	12,95	12,95
Type 5 Pants set of 4	12,95	-



Binding-Post Wrench

Real tool-quality double-ended nut driver with metal inserts. Fits 11,1 mm and 12,7 mm binding posts.



Euro Retail: 17,95

In-Wall Analog-Audio Bulk Cables



Model	Chicago	Red River	Mackenzie
Metal	Solid LGC	Solid PSC	Solid PSC+
Geometry	Double-Balanced	Triple-Balanced (Separate Ground-Reference Conductor)	
Dielectric	Hard-Cell Foam		
Noise-Dissipation	Metal-Layer Noise-Dissipation		Carbon-Based Multi-Layer Noise-Dissipation
Jacket	Green/Black Braid or Black PVC with Green Stripes	Red/Black Braid or Black PVC with Red Stripes	Brown/Black Braid or Black PVC with Brown Stripes
Length	Euro Retail	Euro Retail	Euro Retail
50m	-	-	30,00/m
100m	7,50/m	15,00/m	-

Field Termination Connectors

To download Chicago, Red River, and Mackenzie cable termination manuals, go to <https://www.audioquest.com/custom-install/manuals>
Rivers Crimp Tool Required.



Chicago RCA
Cold-Welded, Gold-Plated

Set of 4
Euro Retail: 69,00



Red River RCA
Cold-Welded, Gold-Plated

Set of 4
Euro Retail: 69,00



Red River XLR
Cold-Welded, Gold-Plated

Set of 4
Euro Retail: 129,00



Mackenzie RCA
Cold-Welded, Hanging-Silver
directly over pure Purple Copper

Set of 4
Euro Retail: 99,00



Mackenzie XLR
Cold-Welded, Hanging-Silver
directly over pure Purple Copper

Set of 4
Euro Retail: 149,00

CAT6 and CAT7 Ethernet Bulk Cables

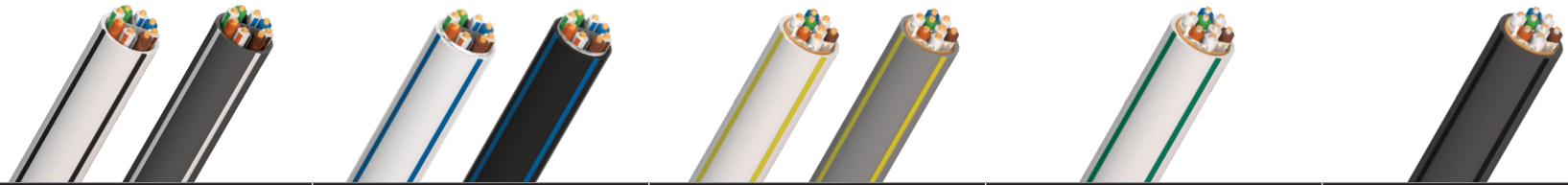

	CAT 600 DCP	CAT 600 FMJ	CAT 700 Pearl	CAT 700 Forest	CAT 700 Carbon
Metal		Solid LGC		Solid 0,5% Silver	Solid 5% Silver
Shield	N/A	Overall Shield	Overall Shield and Individual Pairs		
Gauge	23 AWG				
Dielectric	Solid High-Density Polyethylene		Hard-Cell Foam		
Jacket	White PVC with Black Stripes or Dark Gray PVC with White Stripes	White or Black PVC with Blue Stripes	White or Medium Gray PVC with Yellow Stripes	White PVC with Green Stripes	Dark Gray PVC with Black Stripes
Recommended Connector	CAT600 DCP	CAT 700 Connector & CAT 700 Telegärtner Connector			
Length	Euro Retail	Euro Retail	Euro Retail	Euro Retail	Euro Retail
152m	-	4,25/m	7,95/m	13,95/m	65,00/m
304m	3,25/m	-	-	-	-

CAT6/7 Connectors

To download CAT600 and CAT700 cable termination manuals, go to <https://www.audioquest.com/custom-install/manuals>



Load Bar Connector Boot

CAT600 DCP Connectors

Fits **CAT600DCP** cable and **standard unshielded Cat6** cables.

Each Euro Retail: 1,75 **Bag of 50 Euro Retail: 87,50**



Load Bar Connector Boot

CAT700 Connectors

Fits **CAT600FMJ**, **CAT700** and **standard shielded Cat6/Cat7** cables

Each Euro Retail: 3,50 **Bag of 50 Euro Retail: 175,00**



Telegärtner Connector

Fits **CAT600FMJ**, **CAT700** and **standard shielded Cat6/Cat7** cables

Each Euro Retail: 27,50

Installer Packs

Cables and Accessories in Installer-Friendly bags instead of hanging boxes.

Installer Packs provide exactly what you need to get the job done. Each Pack includes a number of high-value, high-performance AudioQuest pieces and comes with convenient integrated labels that you can peel off and place on your invoice. No retail packaging, no garbage in your truck, no excess waste or cost.



Analog-Audio Interconnect Cables

Packs of 5



	Tower	Golden Gate	Alpha-Snake
Length	Retail Per Cable	Retail Per Cable	Retail Per Pair of Cables
0,5m	-	-	22,50
0,6m	31,95	75,00	-
1m	33,95	79,00	25,00
2m	39,95	95,00	30,00
3m	45,95	109,00	35,00

0,6m available in RCA - RCA only.
1,0 - 3,0m available in RCA - RCA, 3,5mm - RCA, 3,5mm - 3,5mm.

Optical Cables

Packs of 5



	Pearl	Forest	Cinnamon
Length	Euro Retail Per Cable	Euro Retail Per Cable	Euro Retail Per Cable
0,75m	29,00	49,00	79,00
1,5m	35,00	59,00	99,00
3m	49,00	89,00	139,00

Available in Full-to-Full configurations only.

AC Power C7 90° Adaptors

Packs of 10



E = Equal radius	U = Unequal radius
Euro Retail per piece	Euro Retail per piece
17,95	17,95

Analog-Audio FLX-X RCA Splitters

Packs of 5



M22F	F22M
Euro Retail per piece	Euro Retail per piece
19,95	19,95

HDMI Cables

Packs of 5



	BlueBerry	Pearl 48	Forest 48
Length	Euro Retail Per Cable	Euro Retail Per Cable	Euro Retail Per Cable
0,6m	29,95	35,00	69,00
1,0m	34,95	39,00	79,00
1,5m	39,95	49,00	89,00
2,0m	44,95	59,00	99,00
3,0m	59,95	79,00	139,00
5,0m	99,95	179,00	289,00

HDMI Adaptors

Packs of 5

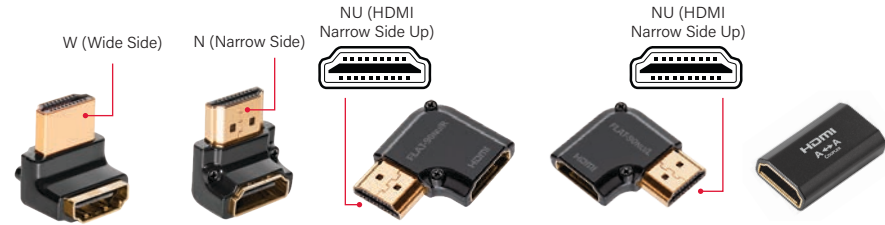

HDMI 90°/W	HDMI 90°/N	HDMI 90° NU/R	HDMI 90° NU/L	HDMI Coupler
Euro Retail per piece	Euro Retail per piece	Euro Retail per piece	Euro Retail per piece	Euro Retail per piece
19,95	19,95	19,95	19,95	19,95

Ethernet Cables (RJ/E)

Packs of 5



	Pearl	Forest	Cinnamon
Length	Euro Retail Per Cable	Euro Retail Per Cable	Euro Retail Per Cable
0,75m	39,00	59,00	99,00
1,5m	49,00	79,00	119,00
3m	69,00	109,00	159,00
5m	99,00	149,00	209,00

Digital Coax Cables

Packs of 5



	Forest
Length	Euro Retail Per Cable
0,75m	35,00
1,5m	39,00
3m	49,00
5m	69,00

AudioQuest Branded Point of Purchase (POP) Materials



Slat Wall Sign



Acrylic Wall Sign - Red



Acrylic Wall Sign - Black



Tent Card



Window Sticker



Individual Spool Holder

Rugged metal Spool holder will hold almost all AQ Spools. Supplied with merchandising stickers



In-Store Display Rack

Spool holder sold separately.
Dimensions: 193cm (h) x 89cm (w) x 33cm (d)



Standalone Display Rack

AudioQuest Branded Promotional Items

Please check with Roosendaal for availability and price



Polo Shirt

Our versatile polo shirt looks great with anything. Classic black with a discreet silver AudioQuest logo.

Men's sizes: S-2XL; Women's sizes: S-XL.



T-Shirt

Our classic crewneck t-shirt is made from 100% lightweight, preshrunk cotton for a perfect fit that's as attractive as it is comfortable. Our t-shirt features a tasteful red AudioQuest logo against a solid black background.

Sizes: S-3XL



Chino Washed Cotton Baseball Cap

Our baseball cap has a durable 8-stitch bill for a long-lasting, contoured shape. The Velcro fastener provides easy adjustments for a perfect fit. Available in black with red AudioQuest logo and trim, this cap looks and feels great. One size fits all.



Beanie

Red, gray, and black, with our classic red AudioQuest logo, our stylish beanie is made from super-stretch, fine-gauge acrylic, for a warm, snug fit over your head and ears. The perfect accessory for those cooler days. One size fits all.



Pen

Take note: With its discreet AQ logo, piano-black lacquered tube, and chrome accents, this ballpoint pen has the looks to match the quality of your prose. Keep it in your AudioQuest backpack and take it with you wherever you go.



Water Bottle

Made by Specialized, this 769ml leak-proof water bottle has a self-sealing valve and features easy-to-squeeze BPA-free, recyclable plastic. Our distinct Wolves artwork is printed with a non-solvent based, CPSC-approved ink. Just aim and squeeze for clean, pure refreshment.

AudioQuest Branded Promotional Items

Please check with Roosendaal for availability and price



License Plate Holder

It's all about the journey. Take your love for AudioQuest on the road with this license-plate frame. The clean, simple design features our red AudioQuest logo and "Experience the Difference" mantra set against a black background—perfect for any ride. Vroom!



Backpack

Available in black with our black AudioQuest and Four Elements logos. Accommodates laptops with 13" screens and tablets. Made of nylon.



Padded Backpack

Do no harm with our padded backpack. It features a discreet front-panel zipper, multiple internal pockets, and mesh side pockets for drinks and other items. A padded laptop insert safely accommodates screens up to 15". Mesh backing and straps are durable and comfortable, making the backpack as easy to carry as it is to wear.



Tote Bag

This super-durable tote bag is made of water-repellent polyester and has a long strap that fits easily over a shoulder. Measuring 38cm x 36.5cm, its slim pocket is perfect for carrying AudioQuest merchandise—pens, tumblers, price books—and even an LP or two! The simple black-on-black design features a subtly stylish AQ logo.

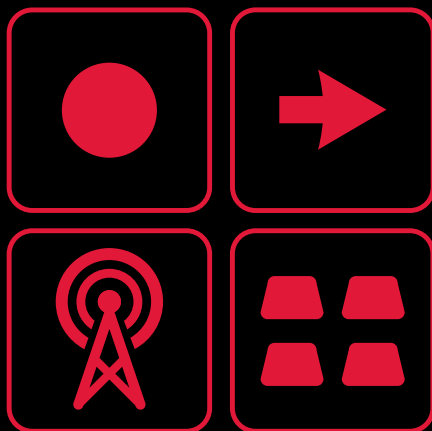

audioquest®

www.audioquest.com

Tel +31 165 54 1404