

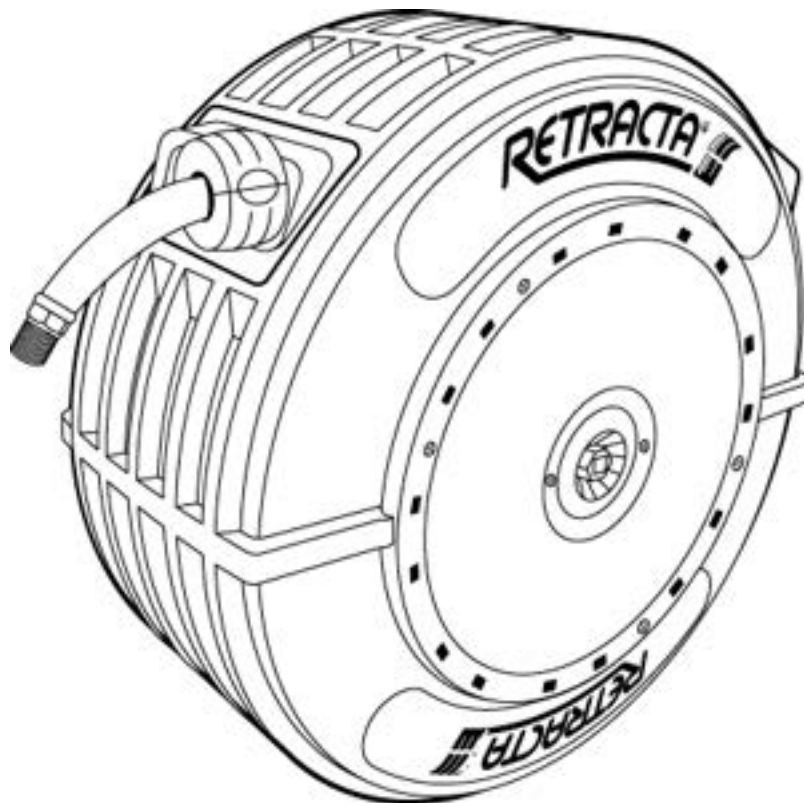

## Owners Manual



### Model Type

Air  
Air/Water  
Hot/Cold Water/Coolant  
Horticultural  
Weed pesticide  
Oil / Grease

### Quality Hose Reels

## INTRODUCTION

Thank you for purchasing the Retracta R3 retractable hose reel.

### PLEASE READ THIS SAFETY INFORMATION CAREFULLY BEFORE USE.

Read and retain this instruction manual to assist you in the operation of your new product.



'CAUTIONS' are listed throughout this manual to advise of actions that may cause damage to the operator or to the equipment.

you're



## CAUTION

The following general warnings should be observed when installing, operating or maintaining hose reel equipment. Further specific warnings pertaining to specific dangers may be found within this document

- \* Do not exceed the maximum working pressure for this reel. (Refer to the product specifications)
  - \* Check equipment daily for wear or damage. (Replace worn or damaged items immediately with genuine replacement parts).
  - \* Check equipment daily for leaks. (Repair or replace as required)
  - \* Only use compatible fluids with this reel. (Refer to compatible fluids in product specifications)
  - \* Use equipment for intended use only.
  - \* Operator should wear appropriate protection equipment to protect against personal injury .
  - \* Do not attempt to stop leaks with your hand or body.
  - \* Caution should be observed against burning due to hot water temperature when using hot water reels.
  - \* Do not alter or modify equipment.
  - \* Use reel in well ventilated areas if toxic or flammable fluids are in use
  - \* Do not let go of the hose when rewinding.
- Before attempting any maintenance disconnect and turn off supply line, then release the line pressure.**



### Note,

This is not an exhaustive list of hazards and warnings. All care should be taken to maintain safe working procedures when installing, operating and maintaining the equipment. It is recommended that only trained professional trades people with the appropriate working knowledge of such equipment be charged with its installation and maintenance.

## INSTALLATION INSTRUCTIONS

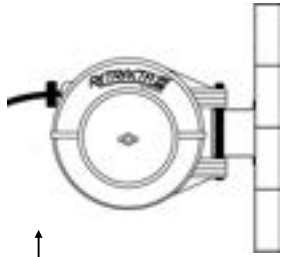

Fig.1 Wall mounting (max height 1.4m)

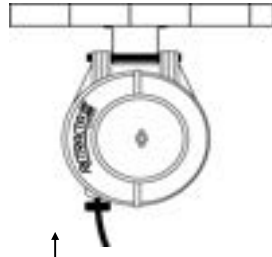

Fig.2 Overhead mounting (max height 4.5m)

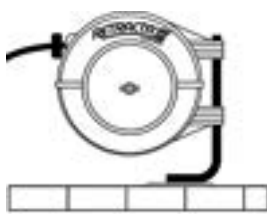

Fig.3 BB200 Bracket - Floor/Bench

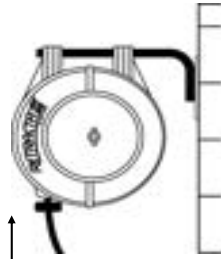

Fig.4 BB200 Bracket High wall mounting (max height 4.5m)

1) Use appropriate hardware to secure and support the reel and bracket to desired location and weight of the fluids.

(refer to back page for mounting bracket template)

2) To prevent the reel from pivoting in the overhead position (figure 2). Install locking bracket supplied.

(refer to back page for fitting instructions)

3) If spring recoil tension requires adjusting refer to "Add spring tension" for correct procedure

4) Connect the fluid supply line to the side of the reel making sure to tighten appropriately.

5) It is recommended that an isolation valve is installed before the reel inlet.

6) Connect a desired hose-end attachment and tighten appropriately. Thread sealant may be required.

7) Purge the air from the reel and check for any leaks or damage before initial use.

8) Before carrying out any maintenance, close isolation valve and remove all line pressure.

## INCREASE SPRING TENSION

(ALL MODELS)



# CAUTION

**Before attempting any maintenance disconnect and turn off supply line, then release the line pressure.**



1) Remove screws



2) Add 2 complete turns  
**Note:** 1 click on hub equals 90 deg



3) Replace screws

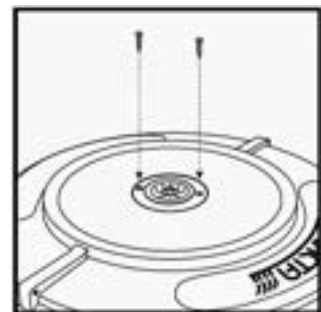

# REMOVE / REPLACE TENSION SIDE PLATE



(ALL MODELS)

Before attempting any maintenance disconnect and turn off supply line, then release the line pressure.



1) Remove screws with magnetic screwdriver

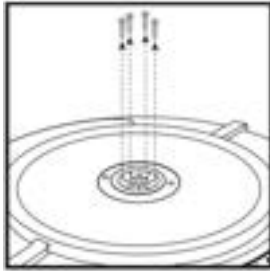

2) Hold hub and remove screws

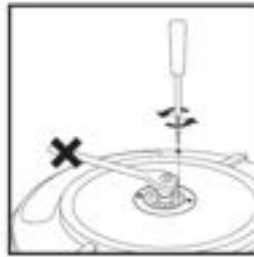

3) Release spring tension

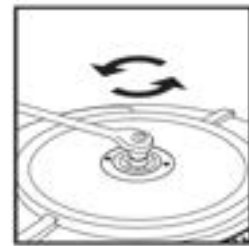

4) Remove screw and center hub



5) Remove screws.

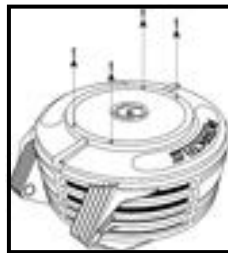

6) Remove side plate

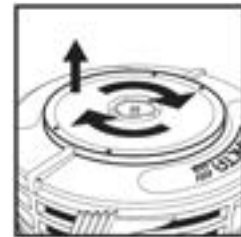

7) Fit new side plate.



8) Fit screws.



9) Fit screws

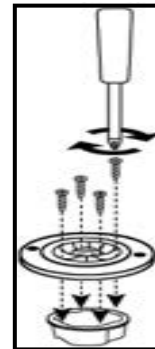

10) Fit screw.



11) Add 2 complete turns

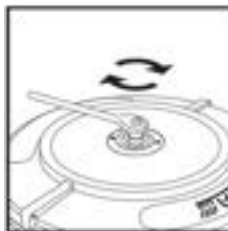

12) Fit screws



# HOSE REPLACEMENT INSTRUCTIONS (ALL MODELS EXCEPT GREASE)



Before attempting any maintenance disconnect and turn off supply line, then release the line pressure.



1) Pull out hose and latch

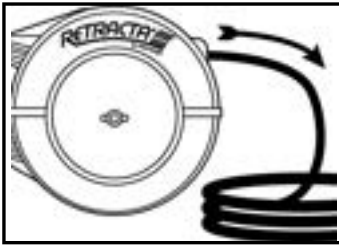

2) Remove screws

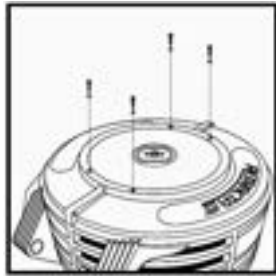

3) Remove screws

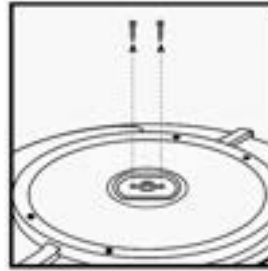

4) Remove plate



5) Remove cable tie



6) Remove swivel

(Air/Water/Hort)



(Hot Water)



(High Press Water and Oil)

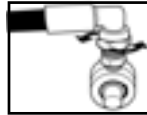

7) Remove old hose



8) Fit new hose



9) Attach hose to the swivel

(Air/Water/Hort)



(Hot Water)



(High Press Water and Oil)

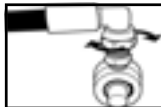

10) Fit swivel assembly



11) Fit cable tie

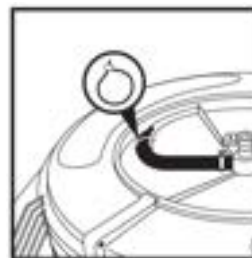

12) Fit sideplate



13) Fit screws.



14) Fit screws



15) Recoil hose evenly into reel

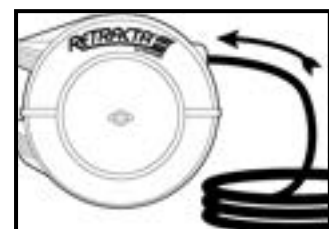

# HOSE REPLACEMENT INSTRUCTIONS (GREASE)



Before attempting any maintenance disconnect and turn off supply line, then release the line pressure.



1) Pull out hose and latch

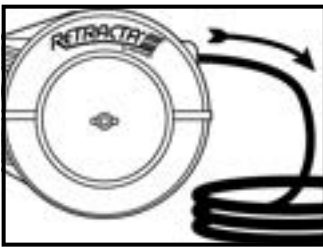

2) Remove screws

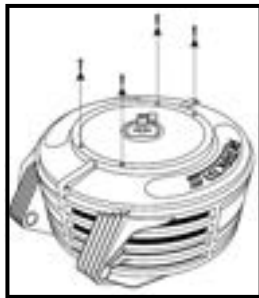

3) Remove sideplate



4) Remove screws

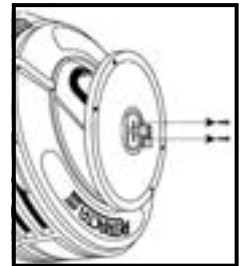

5) Remove swivel

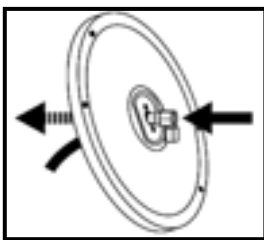

6) Remove cable tie



7) Remove hose from swivel

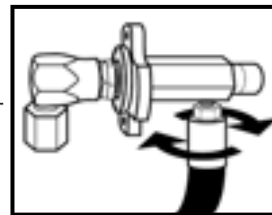

8) Remove old hose



9) Fit new hose



10) Fit hose to swivel

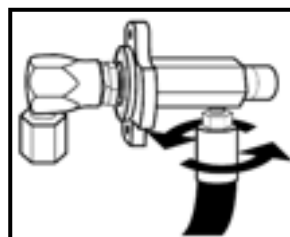

11) Fit cable tie



12) Fit swivel through side plate

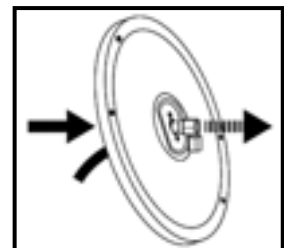

13) Fit screws.

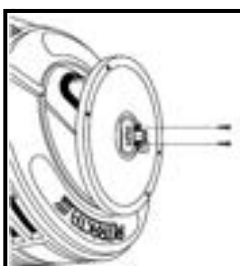

14) Fit side plate

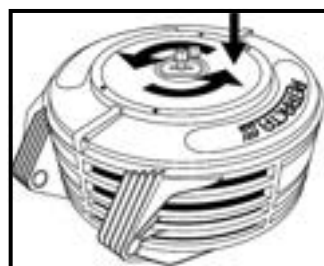

15) Fit screws.



16) Recoil hose evenly into reel

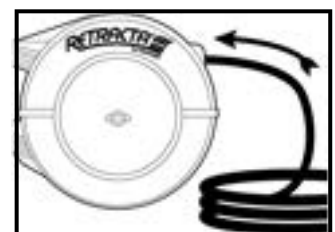

# SWIVEL REPLACEMENT SWIVEL SEALS REPLACEMENT



(AIR / AIR-WATER / COOLANT)  
(HORTICULTURAL / WEED PESTICIDE)

Before attempting any maintenance disconnect and turn off supply line, then release the line pressure.



1) Pull out hose and latch

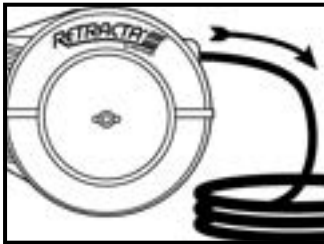

2) Remove screws

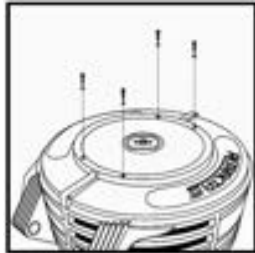

3) Remove screws

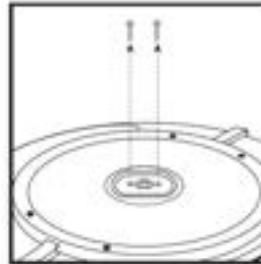

4) Remove plate



5) Remove cable tie



6) Remove circlip



### Swivel O'ring Replacement instructions (use steps 1-7 & 9-14)

- 7) a) Remove body from shaft
- b) Replace o'rings
- c) Apply water resistant grease
- d) Re-fit swivel body and circlip



### Swivel replacement Instructions (use steps 1-5 & 8-14)

8) Remove swivel



9) Fit swivel assembly

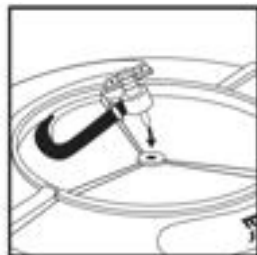

10) Fit cable tie

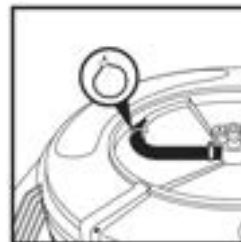

11) Fit sideplate



12) Fit screws.



13) Fit screws



14) Recoil hose evenly into reel

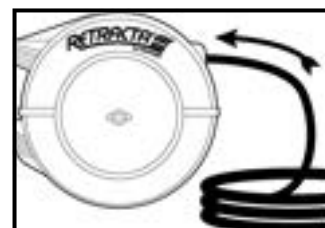

# SWIVEL REPLACEMENT SWIVEL SEALS REPLACEMENT

(OIL / HOT WATER)



Before attempting any maintenance disconnect and turn off supply line, then release the line pressure.



1) Pull out hose and latch

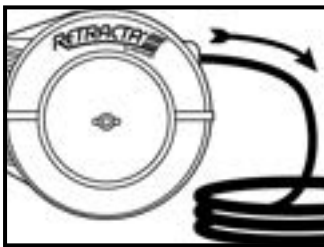

2) Remove screws

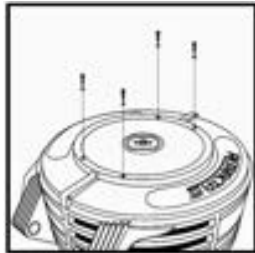

3) Remove screws

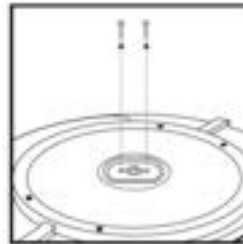

4) Remove plate



5) Remove cable tie



6) Remove circlip

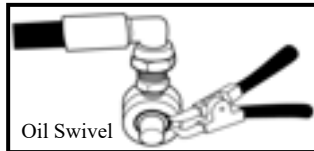

Oil Swivel

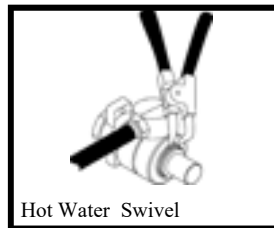

Hot Water Swivel

### Swivel O'ring Replacement instructions (use steps 1-7 & 10-15)

- 7) a) Remove body from shaft  
b) Replace o'rings  
c) Apply water resistant grease  
d) Re-fit swivel body and circlip



### Swivel replacement Instructions (use steps 1-5 & 8-15)

8) Remove hose from swivel

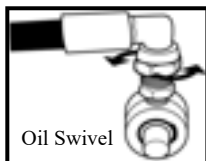

Oil Swivel

9) Fit hose to new swivel

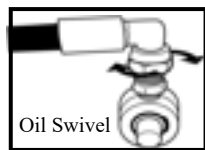

Oil Swivel

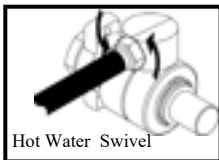

Hot Water Swivel

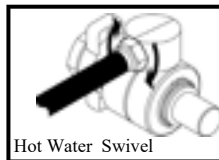

Hot Water Swivel

10) Fit swivel assembly



11) Fit cable tie



12) Fit sideplate



13) Fit screws.



14) Fit screws

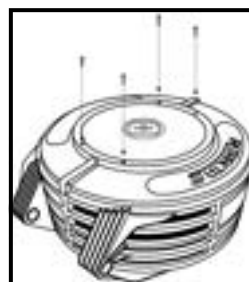

15) Recoil hose evenly into reel

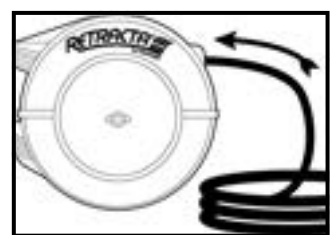



# SWIVEL REPLACEMENT (GREASE)



Before attempting any maintenance disconnect and turn off supply line then release line pressure.



1) Pull out hose and latch

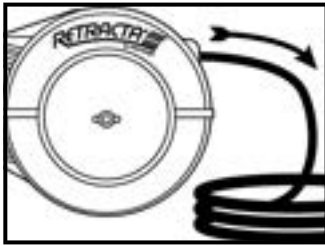

2) Remove screws



3) Remove sideplate



4) Remove screws

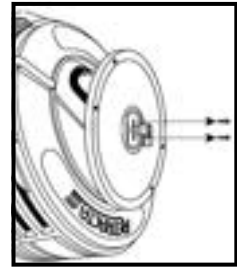

5) Remove swivel

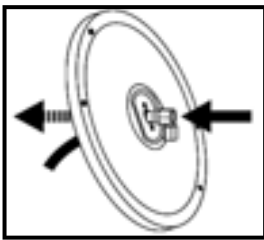

6) Remove cable tie



7) Remove SB6 swivel

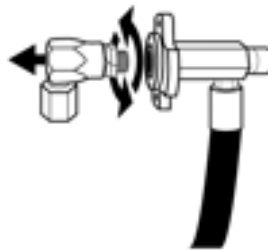

8) Fit new SB6 swivel

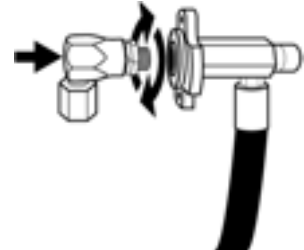

9) Fit cable tie



10) Fit swivel through side plate

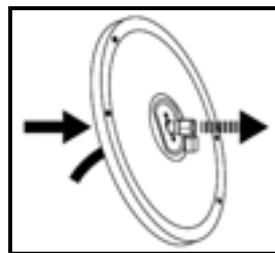

13) Fit screws.

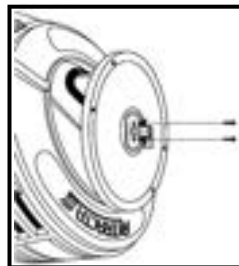

14) Fit side plate

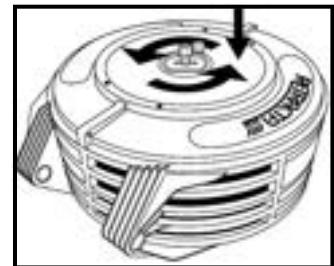

15) Fit screws.



16) Recoil hose evenly into reel

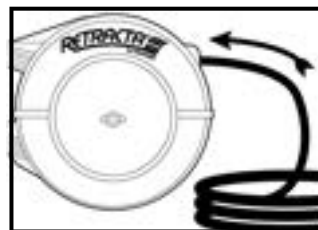

# RACR ADJUSTMENT CONTROL INSTRUCTIONS

(FOR MODELS FITTED WITH RACR)

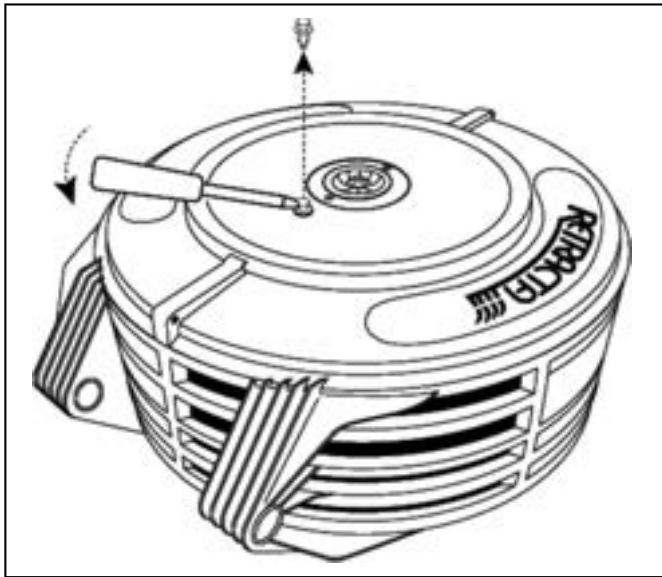
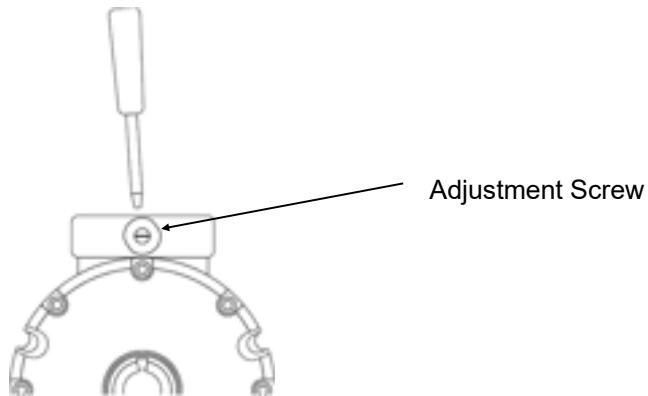

1. Lift centre button to unlock then lift out plug

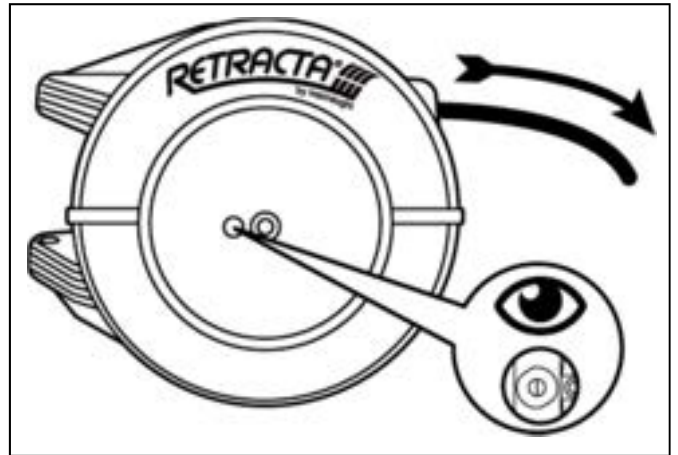

2. Pull hose out and latch when adjustment screw appears

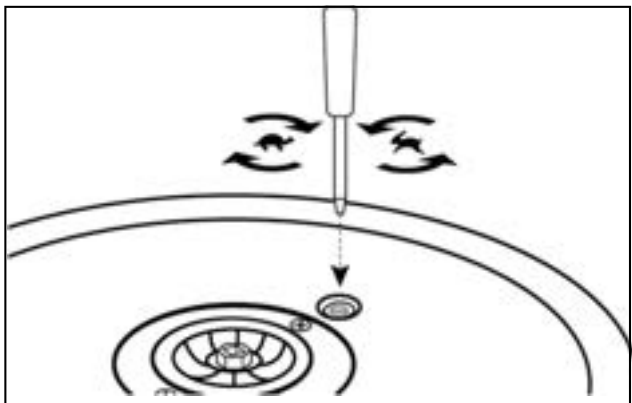

3. Adjust speed as desired  
(Clockwise for slower return)  
(Counter clockwise for faster return)

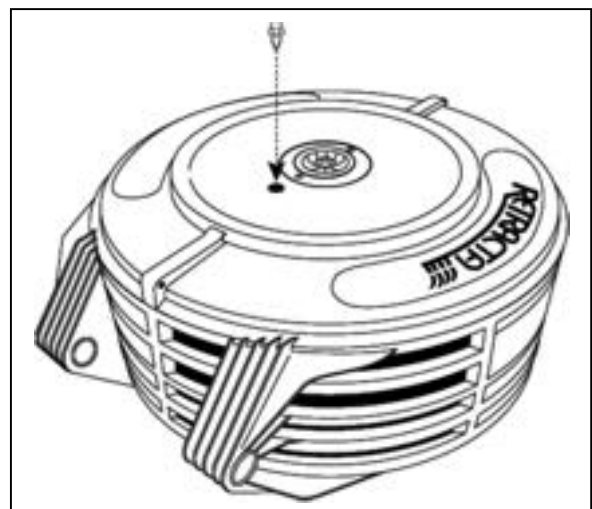

4. Replace plug then press centre button to lock

# TROUBLESHOOTING GUIDE



<p><b>Hose does not retract correctly</b></p>	<p>A) Outlet nozzle, gun or tool is too heavy</p> <p>B) Spring is fatigued and lost tension</p>	<p>Refer to INCREASE SPRING TENSION on page 3</p>
<p><b>Reel does not latch</b></p>	<p>A) Incorrect operation</p> <p>B) Latch assembly is broken</p>	<p>Refer to REMOVE/ REPLACE TENSION SIDE PLATE on page 4</p>
<p><b>Leaking from hose</b></p>	<p>Split in hose</p>	<p>Refer to HOSE REPLACEMENT on pages 5,6</p>
<p><b>Leaking from swivel</b></p>	<p>Swivel or swivel seals are worn</p>	<p>Refer to SWIVEL OR SWIVEL SEAL REPLACEMENT on pages 7,8,9</p>

## EXPLODED DIAGRAM

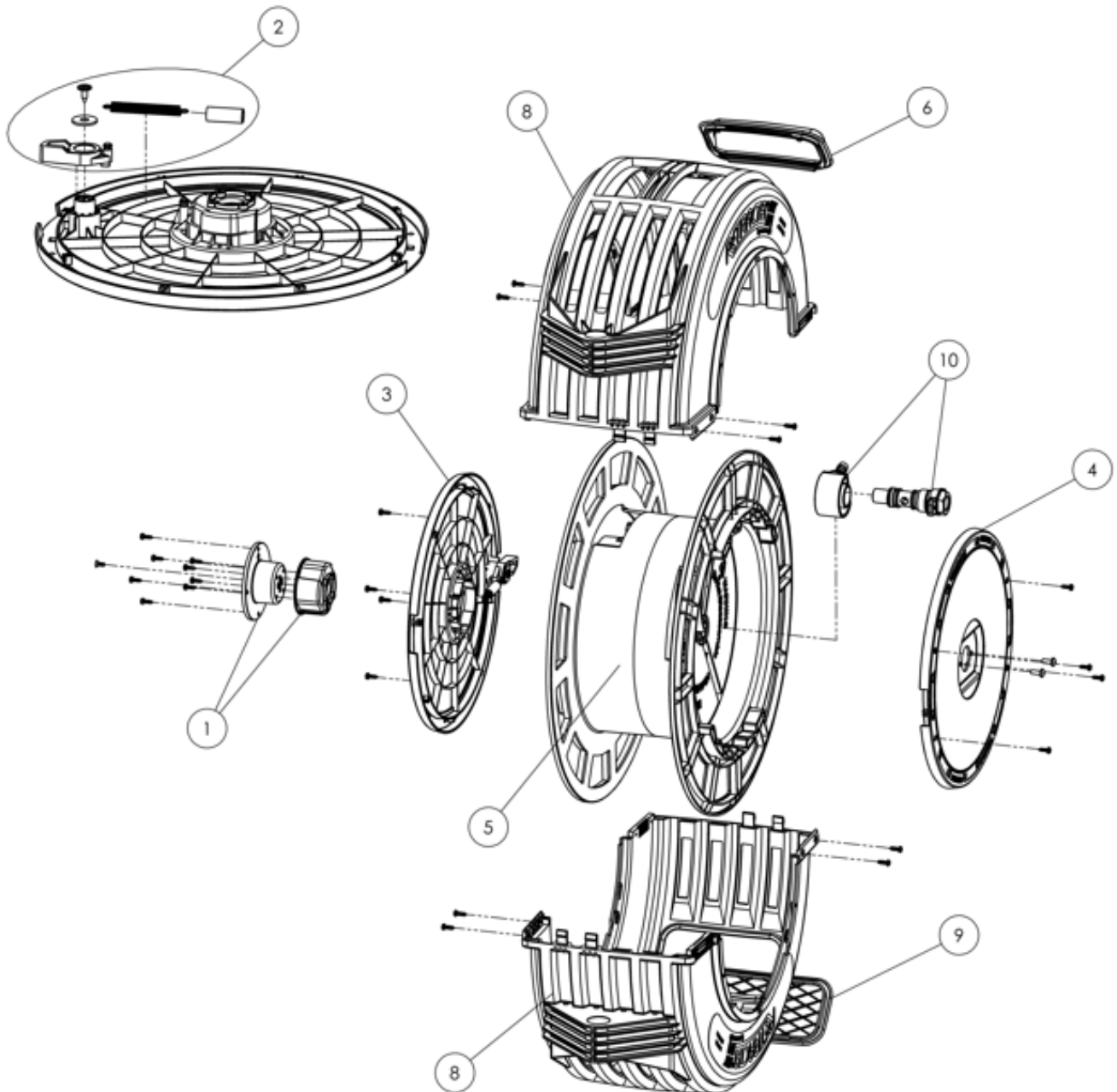

**Note:**

1. Outer casing set is supplied with screws, mouth set and lower insert
2. Standard bracket not shown

## SWIVEL ASSEMBLY PART NUMBERS



### Air / Air-Water / Coolant



O'Ring seal kit  
BS115Vs

#### AR / AW / Coolant Swivel Assembly Kit

Hose Size	BSP Swivel	NPT Swivel
3/8" (10mm)	RS116AS	RS130AS
1/2" (12mm)	RS115AS	RS129AS

### High Pressure Hot Water

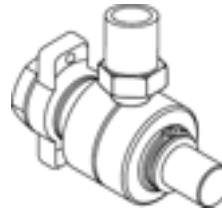

HP Swivel Assembly kit  
RS85s

### Oil

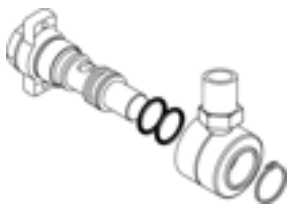

O'Ring seal kit  
BS115Vs

#### Oil Swivel Assembly Kit

Hose Size	BSP Swivel	NPT Swivel
3/8" (10mm)	RS117AS	RS131AS
1/2" (12mm)	RS117AS	RS131AS

### Grease

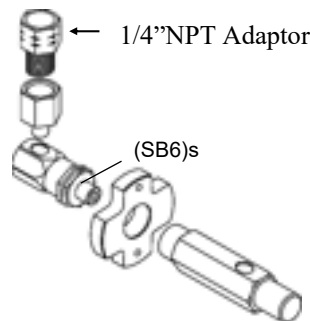

GR Swivel Assembly kit  
RS124As

### Cold Water



O'Ring seal kit  
BS115-1K

CWSwivel Assembly kit  
RS118As

### Weed Pesticide



O'Ring seal kit  
BS115Vs

WD Swivel Assembly kit  
RS67s

### Hot Water



O'Ring seal kit  
BS115ES

#### HW Swivel Assembly Kit

Hose Size	BSP Swivel	NPT Swivel
1/2" (12mm)	RS119AS	RS133AS

### Horticultural

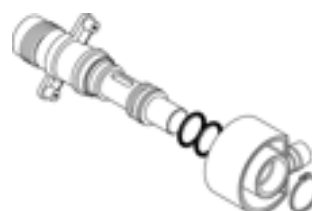

O'Ring seal kit  
BS115-1K

DR Swivel Assembly kit  
RS1s

# SPARE PARTS LIST



## Generic Parts

Item no	Description	Spare part no
1	Tension hub set	R3THs
2	Latch set	R3Ls
3	Latching side plate	R3LPs
4	Inlet side plate	R3IPs
5	Drum assembly	R3DAs
6	Mouth set	R3Ms
7	Standard Bracket (incl locking plate)	BU200
8	Outer Casing Set - (nominate colour)	R3OC-* (replace* with colour)
9	Lower insert (nominate colour)	R3LIS-* (replace * with colour)

Hose Assembly (BSP/AU)

	Hose Type	Hose ID	Length	Hose Part No.	Hose Stopper Part No.
Compressed Air	Air (AR)	3/8"	20m	RH35S	RP156-1S
	Air (AR)	1/2"	15m	RH22S	RP156-2S
	Air (AR)	1/2"	20m	RH150S	RP156-2S
	Air/Water (AW)	3/8"	15m	RH151S	RP156-1S
	Air/Water (AW)	3/8"	20m	RH152S	RP156-1S
	Air/Water (AW)	1/2"	15m	RH153S	RP156-2S
	Air/Water (AW)	1/2"	20m	RH154S	RP156-2S
	Air - FLEX Yellow (RY)	3/8"	20m	RH171S	RP156-5S
	Air - FLEX Yellow (RY)	1/2"	20m	RH175S	RP156-1S
	Air - FLEX Orange (RO)	3/8"	20m	RH181S	RP156-5S
Air - FLEX Orange (RO)	1/2"	20m	RH185S	RP156-1S	
Water	Garden (DR)	1/2"	18m	RH191S	RP156-1S
	Garden (DR)	1/2"	25m	RH203S	RP156-1S
	Cold Water (CW)	1/2"	15m	RH40S	RP156-3S
	Cold Water (CW)	1/2"	20m	RH155S	RP156-2S
	Hot Water (HW)	1/2"	15m	RH41S	RP156-2S
	Hot Water (HW)	1/2"	20m	RH168S	RP156-2S
Grease/Oil/Chemical	High Pressure Water (HP)	3/8"	15m	RH159S	RP156-1S
	Grease (GR)	1/4"	10m	RH45S	RP156-5S
	Grease (GR)	1/4"	15m	RH156S	RP156-5S
	Oil (OMP)	3/8"	10m	RH84S	RP156-1S
	Oil (OMP)	1/2"	15m	RH161S	RP156-3S
Weed Pesticide	1/2"	16m	RH50S	RP156-2S	

Inlet/Feeder hose BSP/AU

Garden (DR)	1/2"	2m	RH192S
-------------	------	----	--------

Hose Assembly (NPT/USA)

Hose Type	Hose ID	Length	Hose Part No.	Hose Stopper Part No.
Air - FLEX Yellow (RY)	3/8"	65 ft	RH169S	RP156-5S
Air - FLEX Yellow (RY)	1/2"	65 ft	RH173S	RP156-1S
Air - FLEX Orange (RO)	3/8"	65 ft	RH179S	RP156-5S
Air - FLEX Orange (RO)	1/2"	65 ft	RH183S	RP156-1S
Garden (DR)	1/2"	60 ft	RH189S	RP156-1S
Garden (DR)	1/2"	82 ft	RH206S	RP156-1S
Hot Water	1/2"	65 ft	RH196S	RP156-2S
Grease	1/4"	50 ft	RH197S	RP156-5S
Oil	1/2"	50 ft	RH193S	RP156-3S

Inlet/Feeder hose (NPT/USA)

Garden (DR)	1/2"	6 ft	RH190S
-------------	------	------	--------

## Hose Stoppers

## Hose Stoppers

Description	Spare part no
RP156-1S	15mm OD Hose (5/8")
RP156-2S	18mm OD Hose (3/4")
RP156-3S	20mm OD Hose (13/16")
RP156-5S	13MM OD Hose (1/2")
RP156-4S	OXY / LPG Hose

## Accessories

Description	Spare part no
Std wall bracket	BU200
bench mount bracket	BB200
Cold wash nozzle set	RH51s
Horticultural reel nozzle set	DR-GSETS

# DECLARATION OF CONFORMITY



EN (English)		Declaration of Conformity	
We:	Macnaught Pty Ltd	Ort:	41-49 Henderson Street, Turrella NSW 2205, Australia
Declare that:	Retracta Hose Reel models prefixed AR, ARC, ARS, ARSL, ARK, AW, CL, CLC, CW, CWC, DR, DRC, FRAS, GR, GRC, HP, HPC, HW, HWC, LPS, LPSL, DA, DAC, DG, DGC, DMF, DMPC, RO, ROC, RY, RYC, WD & WDC		
in accordance with:	2006/42/EC 2009/127/EC	(The Machinery Directive) (amending Directive - WD, DR & DRC models only)	
has been designed and manufactured to the following specifications:	EN ISO 12100:2010 (Safety of Machinery)		
I hereby declare that the equipment named above has been designed to comply with the relevant sections of the above referenced specification. The product complies with all essential requirements of the Directives.			
Signed by:			
	Marco Licciani, Engineering Manager, Macnaught Pty Ltd.		
Done at:	Macnaught Pty Ltd, 41-49 Henderson Street, Turrella, NSW 2205, Australia		
Date:	26/08/2021		
			

FR (French)		Déclaration de conformité	
Nous,	Macnaught Pty Ltd,	41-49 Henderson Street, Turrella NSW 2205, Australie	
Déclarons que	Les modèles d'ensembles de tuyaux retracta aux préfixes AR, ARC, ARS, ARSL, ARK, AW, CL, CLC, CW, CWC, DR, DRC, FRAS, GR, GRC, HP, HPC, HW, HWC, LPS, LPSL, DA, DAC, DG, DGC, DMF, DMPC, RO, ROC, RY, RYC, WD et WDC		
en vertu de :	2006/42/CE 2009/127/CE	(Directive Machines) (Directive modificative - modèles WD, DR et DRC uniquement)	
sont conçus et fabriqués selon la spécification suivante :	EN ISO12100:2010 (sécurité Machines)		
Je déclare par la présente que les équipements mentionnés ci-dessus sont conformes aux sections appropriées de la spécification susmentionnée. Le produit est conforme à toutes les exigences principales des directives.			
Signé par :			
	Marco Licciani, responsable de l'ingénierie, Macnaught Pty Ltd.		
Fait à :	Macnaught Pty Ltd, 41-49 Henderson Street, Turrella, NSW 2205, Australie		
Date :	26/08/2021		
			

DE (German)		Konformitätserklärungen	
Wir,	Macnaught Pty Ltd	mit Sitz in:	41-49 Henderson Street, Turrella NSW 2205, Australien
erklären, dass	die Retracta Schlauchtrammelmodelle mit den Präfixen AR, ARC, ARS, ARSL, ARK, AW, CL, CLC, CW, CWC, DR, DRC, FRAS, GR, GRC, HP, HPC, HW, HWC, LPS, LPSL, DA, DAC, DG, DGC, DMF, DMPC, RO, ROC, RY, RYC, WD und WDC		
in Übereinstimmung mit den Verordnungen:	2006/42/EG 2009/127/EG	(Maschinenrichtlinie) (Änderungsrichtlinie, nur Modelle WD, DR und DRC)	
gemäß folgenden Spezifikationen konzipiert und hergestellt worden sind:	EN ISO12100:2010 (Maschinenticherheit)		
Ich erkläre hiermit, dass die oben genannten Geräte so konzipiert wurden, dass sie mit den einschlägigen Abschnitten der oben genannten Spezifikation übereinstimmen. Das Produkt erfüllt alle grundlegenden Anforderungen der Richtlinien.			
Unterschiedet von:			
	Marco Licciani, Manager Ingenieurwesen, Macnaught Pty Ltd.		
Unternehmen, Ort:	Macnaught Pty Ltd, 41-49 Henderson Street, Turrella, NSW 2205, Australien.		
Datum:	26/08/2021		
			

# DECLARATION OF CONFORMITY



ES (Spanish)		Declaraciones de	
Nosotros:	Macnaught Pty Ltd	De:	41-49 Henderson Street, Turlella NSW 2205, Australia
Declaramos:	Modelos Retracta Hose Reel con prefijo AR, ARC, ARG, ARGC, AW, CL, CLC, CW, CWC, DR, DRC, FRAS, GR, GRC, HP, NPC, HW, HWC, LPS, LPGC, DA, DAC, DG, DGC, DMP, DMPC, RD, ROC, RR, RYC, WD & WDC.		
en conformidad con:	2006/42/EC 2009/127/EC	[La Directiva sobre maquinaria] [Directiva modificativa: solo los modelos WD, DR y DRC]	
No sido diseñada y fabricada de acuerdo con las siguientes especificaciones:			
	EN ISO 12100: 2010	[Seguridad de la maquinaria]	
Por la presente declaramos que el equipo mencionado anteriormente ha sido diseñado para cumplir con las secciones pertinentes de las especificaciones mencionadas con anterioridad. El producto cumple con todos los requisitos esenciales de las Directivas.			
Firmado por:			
	Marco Uccellini, Responsable de Ingeniería, Macnaught Pty Ltd.		
Redactado en:	Macnaught Pty Ltd, 41-49 Henderson Street, Turlella, NSW 2205, Australia.		
Fecha:	26/08/2021		

JA (Japanese)		商品宣言書	
当社	Macnaught Pty Ltd	所在地	41-49 Henderson Street, Turlella NSW 2205, Australia
は、次の製品が以下の指令及び仕様に基づいて設計、製造されていることを宣言します。			
製品:	AR, ARC, ARG, ARGC, AW, CL, CLC, CW, CWC, DR, DRC, FRAS, GR, GRC, HP, NPC, HW, HWC, LPS, LPGC, DA, DAC, DG, DGC, DMP, DMPC, RD, ROC, RR, RYC, WD, WDC の各種 Retracta ホースリールモデル		
指令:	2006/42/EC	(機械指令)	
	2009/127/EC	(指令の修正 - WD, DR, DRC モデルのみ)	
仕様:	EN ISO 12100: 2010	(機械の安全性)	
私は、上記の製品が上記仕様の関連セクションに適合するように設計されていることをここに宣言します。この製品は、本指令のすべての必要要件事項に基づいています。			
署名:			
	Marco Uccellini, 技術管理者, Macnaught Pty Ltd		
住所:	Macnaught Pty Ltd, 41-49 Henderson Street, Turlella, NSW 2205, Australia.		
日付:	2021年08月26日		



# DECLARATION OF CONFORMITY



EN (English)		Declaration of Conformity	
Wir:	Macnaught Pty Ltd	Of:	41-49 Henderson Street, Turlella NSW 2205, Australia
Declare that	Retracta Hose Reel models prefixed AR, ARC, ARG, ARGC, AW, CL, CLC, CW, CWC, DR, DRC, FRAS, GR, GRC, HP, HPC, HSK, HWC, LPS, LFGC, OA, DAC, OG, OGC, OMP, OMPC, RD, RDC, RY, RYC, WD & WDC		
In accordance with:	2006/42/EC 2009/127/EC	(The Machinery Directive) (amending Directive - WD, DR & DRC models only)	
Has been designed and manufactured to the following specifications:	EN ISO 12100: 2010 (Safety of Machinery)		
I hereby declare that the equipment named above has been designed to comply with the relevant sections of the above referenced specification. The product complies with all essential requirements of the Directives.			
Signed By:			
	Marco Uccellini, Engineering Manager, Macnaught Pty Ltd		
Done at:	Macnaught Pty Ltd, 41-49 Henderson Street, Turlella, NSW 2205, Australia.		
Date:	26/08/2021		
			

FR (French)		Déclaration de conformité	
Nous,	Macnaught Pty Ltd,	41-49 Henderson Street, Turlella NSW 2205, Australie	
Déclarons que	Les modèles d'enrouleurs de tuyaux Retracta aux préfixes AR, ARC, ARG, ARGC, AW, CL, CLC, CW, CWC, DR, DRC, FRAS, GR, GRC, HP, HPC, HSK, HWC, LPS, LFGC, OA, DAC, OG, OGC, OMP, OMPC, RD, RDC, RY, RYC, WD et WDC		
en vertu de :	2006/42/CE 2009/127/CE	(Directive Machines) (Directive modificative - modèles WD, DR et DRC uniquement)	
sont conçus et fabriqués selon la spécification suivante :	EN ISO12100: 2010 (sécurité Machines)		
Je déclare par la présente que les équipements mentionnés ci-dessus sont conformes aux sections appropriées de la spécification susmentionnée. Le produit est conforme à toutes les exigences principales des directives.			
Signé par :			
	Marco Uccellini, responsable de l'ingénierie, Macnaught Pty Ltd.		
Fait à :	Macnaught Pty Ltd, 41-49 Henderson Street, Turlella, NSW 2205, Australie		
Date :	26/08/2021		
			

DE (German)		Konformitätserklärungen	
Wir,	Macnaught Pty Ltd	mit Sitz in:	41-49 Henderson Street, Turlella NSW 2205, Australien
erklären, dass	die Retracta Schlauchtrommelmodelle mit den Präfixen AR, ARC, ARG, ARGC, AW, CL, CLC, CW, CWC, DR, DRC, FRAS, GR, GRC, HP, HPC, HSK, HWC, LPS, LFGC, OA, DAC, OG, OGC, OMP, OMPC, RD, RDC, RY, RYC, WD und WDC		
In Übereinstimmung mit den Verordnungen:	2006/42/EG 2009/127/EG	(Maschinenrichtlinie) (Änderungsrichtlinie, nur Modelle WD, DR und DRC)	
gemäß folgenden Spezifikationen konzipiert und hergestellt worden sind:	EN ISO12100: 2010 (Maschinensicherheit)		
Ich erkläre hiermit, dass die oben genannten Geräte so konzipiert wurden, dass sie mit den einschlägigen Abschnitten der oben genannten Spezifikation übereinstimmen. Das Produkt erfüllt alle grundlegenden Anforderungen der Richtlinien.			
Unterschiedet von:			
	Marco Uccellini, Manager Ingenieurwesen, Macnaught Pty Ltd.		
Unternehmen, Ort:	Macnaught Pty Ltd, 41-49 Henderson Street, Turlella, NSW 2205, Australien.		
Datum:	26/08/2021		
			

## DECLARATION OF CONFORMITY

ES (Spanish)		Declaraciones de	
Nosotros:	Macnaught Pty Ltd	De	41-49 Henderson Street, Turlella NSW 2205, Australia
Declaramos:	Modelos Retracta Hose Reel con prefijo AR, ARC, ARG, ARGC, A/W, CL, CLC, CW, CWC, DR, DRC, FRAS, GR, GRC, HP, HPC, HW, HWC, LPG, LPGC, OA, OAC, OG, OGC, OMP, OMPC, RO, ROC, RY, RYC, WD & WDC		
en conformidad con:	2006/42/EC 2009/127/EC	(La Directiva sobre maquinaria) (Directiva modificativa: solo los modelos WD, DR y DRC)	
ha sido diseñada y fabricada de acuerdo con las siguientes especificaciones:			
	EN ISO 12100: 2010	(Seguridad de la maquinaria)	
Por la presente declaro que el equipo mencionado anteriormente ha sido diseñado para cumplir con las secciones pertinentes de las especificaciones mencionadas con anterioridad. El producto cumple con todos los requisitos esenciales de las Directivas.			
Firmado por:			
	Marco Uccellani, Responsable de ingeniería, Macnaught Pty Ltd.		
Redactado en:	Macnaught Pty Ltd, 41-49 Henderson Street, Turlella, NSW 2205, Australia.		
Fecha:	26/08/2021		



UK  
CA

UKCA CONFORMITY ASSESSMENT  
by CE Marking  
© 2021 by UKCA

日本語		ボツロク	
当社:	Macnaught Pty Ltd	所在地:	41-49 Henderson Street, Turlella NSW 2205, Australia
は、次の製品が以下の指令及び仕様に準拠して設計、製造されていることを宣言します。			
製品:	AR, ARC, ARG, ARGC, A/W, CL, CLC, CW, CWC, DR, DRC, FRAS, GR, GRC, HP, HPC, HW, HWC, LPG, LPGC, OA, OAC, OG, OGC, OMP, OMPC, RO, ROC, RY, RYC, WD, WDC の各種Retractaホースリールモデル		
指令:	2006/42/EC	(機械指令)	
	2009/127/EC	(指令の修正 - WD, DR, DRC モデルのみ)	
仕様:	EN ISO 12100: 2010	(機械の安全性)	
私は、上記の製品が上記仕様の関連セクションに適合するように設計されていることをここに宣言します。この製品は、本指令のすべての必要要件事項に準拠しています。			
署名:			
	Marco Uccellani, 技術管理者, Macnaught Pty Ltd		
住所:	Macnaught Pty Ltd, 41-49 Henderson Street, Turlella, NSW 2205, Australia.		
日付:	2021年08月26日		



UK  
CA

UKCA CONFORMITY ASSESSMENT  
by CE Marking  
© 2021 by UKCA

**MOUNTING DETAILS**  
**BU200 WALL MOUNT BRACKET**

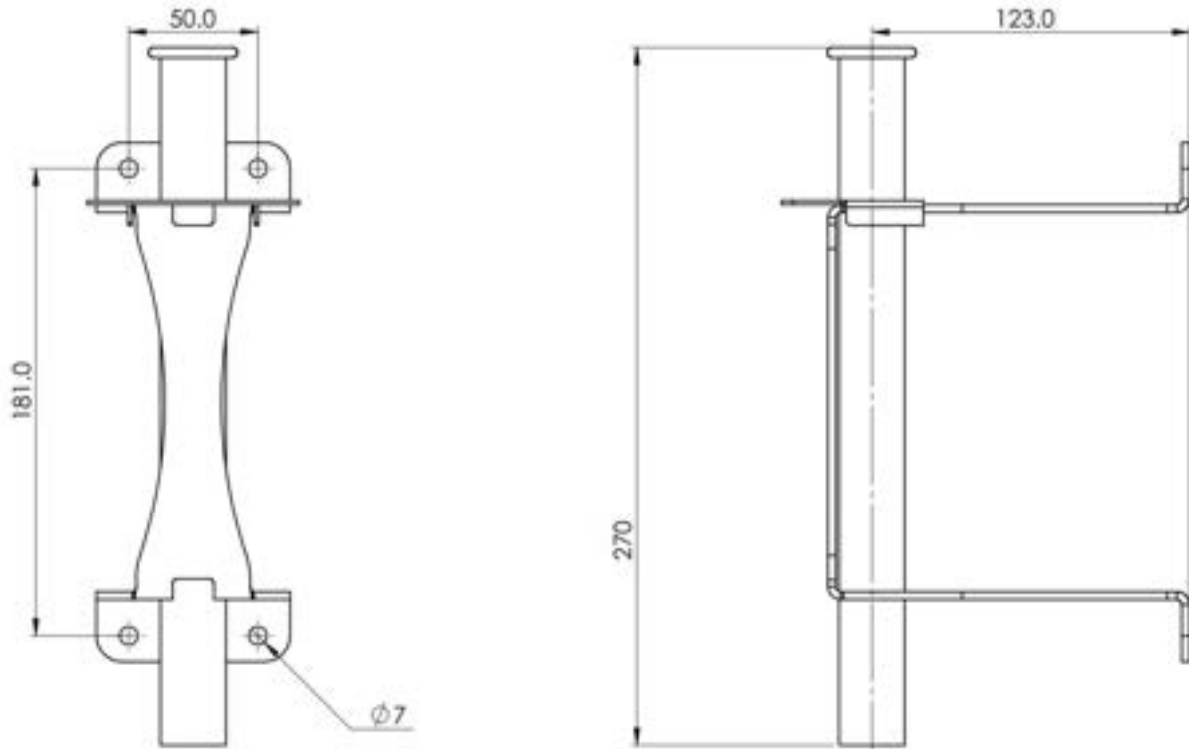

**DIMENSIONS**

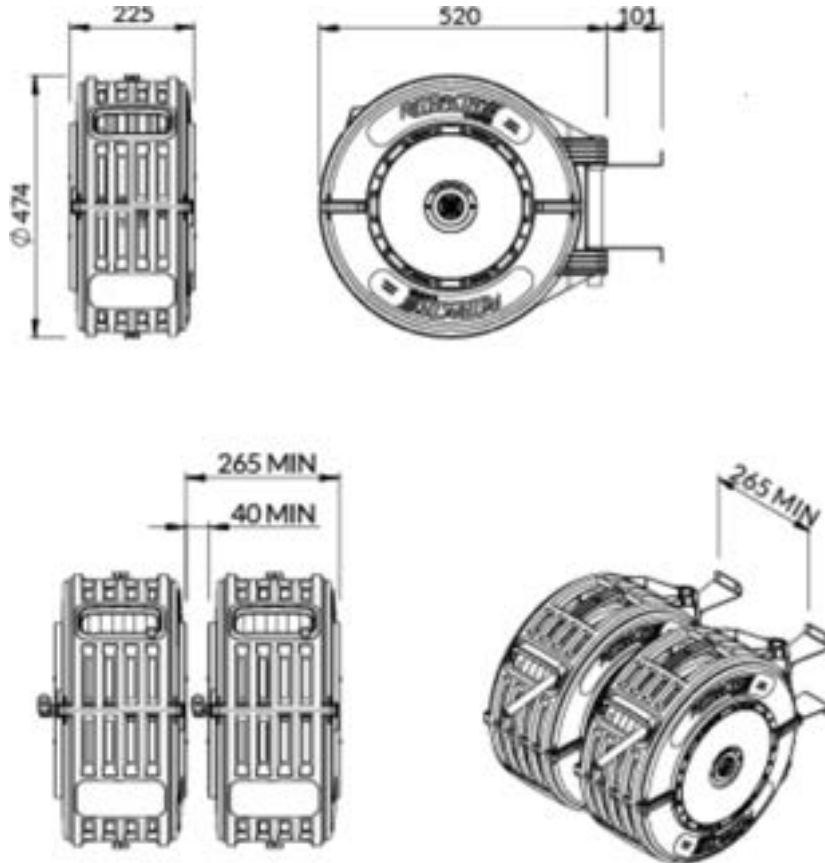

**WEIGHT: 11kg (24lb) - 15kg (33lb) MODEL DEPENDENT**

**NOTE: Not to scale**

**BB200 BENCH MOUNT BRACKET  
MOUNTING DETAILS**

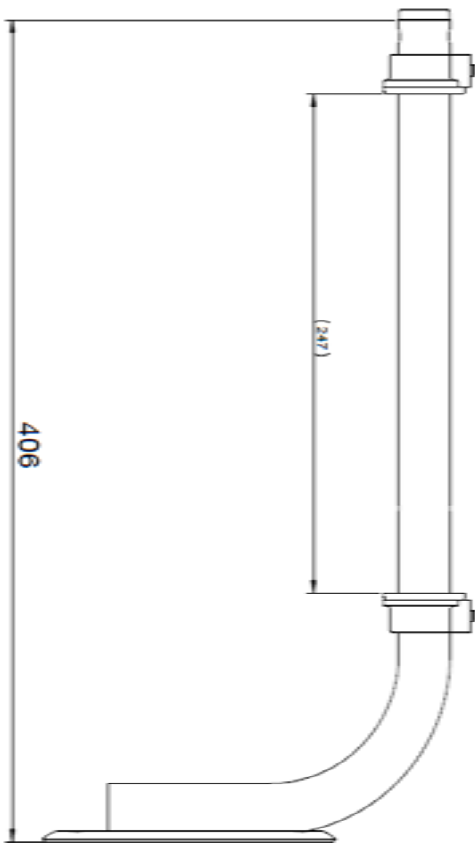
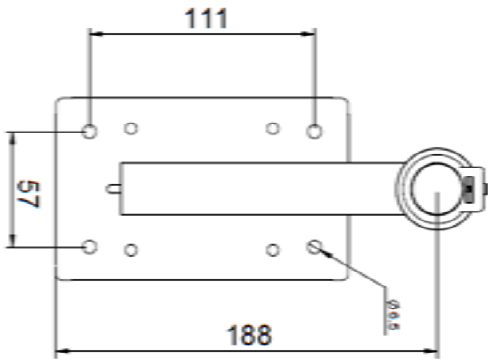

**NOTE: Not to scale**

**Note:**  
This product should be disposed of according to all applicable local and national government environment regulations and guidelines.

**FITTING LOCKING BRACKET**

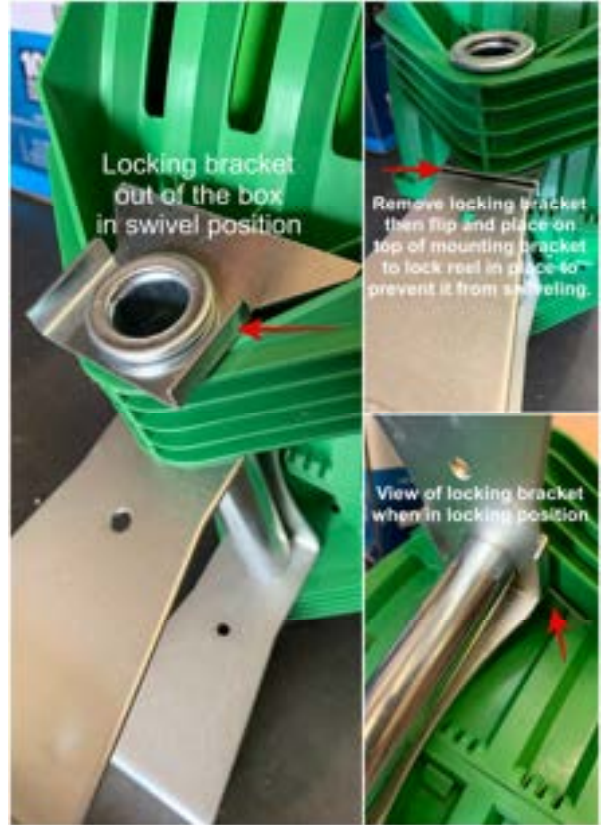

[www.macnaughtusa.com](http://www.macnaughtusa.com)

**macnaught**

**Macnaught Americas**

**(813) 628-5506 | [info@macnaughtusa.com](mailto:info@macnaughtusa.com)**

\* Read Manual Before Use!



**For Warranty Terms and Conditions see [macnaught.com.au](http://macnaught.com.au) / [macnaughtusa.com](http://macnaughtusa.com)  
For a list of Australian Service Centres see [macnaught.com.au](http://macnaught.com.au)**