

CERAGEM **PAUSE M6**

CERAGEM PAUSE M6 USER MANUAL

CGM EMCG-2401

Copyright 2024 CERAGEM. All rights reserved.



USER GUIDE

CERAGEM PAUSE M6
USER MANUAL

CERAGEM

CERAGEM **PAUSE M6**

USER GUIDE

CERAGEM PAUSE M6
USER MANUAL

CERAGEM PAUSE M6

CERAGEM PAUSE M6 USER MANUAL

01	Precautions for Safety	04
02	Transporting and Installation	08
03	Name of Each Part and Components	09
04	Name and Description of the Remote Control ...	10
05	Descriptions and Names of Massage Programs	13
06	Using the Massage Chair	14
07	Maintaining and Storing	23
08	Troubleshooting	24
09	FAQ	25
10	Customer Service	26
11	Product Specifications	28
12	Product Warranty	29

- In order to use the product safely and correctly, be sure to read this user manual before first use.
- Always keep this manual on hand and refer to it as necessary.

01. Precautions for Safety

Anyone with reduced physical, sensory or mental capabilities, or who lacks the appropriate experience or training (including children) must use this product under the supervision of their guardian who bears responsibility for their safety. Children should be supervised to ensure that they do not play with the product.

The following precautions for safety are to prevent unexpected risks or damage in advance through safe and correct use of the product.

When Installing

- Never modify, disassemble or repair the product; it must be done by a qualified service technician.
→ **Doing so may cause fire or electric shock.**
- Use the product on a flat surface.
→ **Failure to do so may cause a product failure or an accident.**

Power-related

- If the product does not move or operates abnormally, immediately unplug the power plug from the wall outlet and ask the Customer Service Center to check or repair the product.
→ **Failure to do so may cause fire or electric shock due to electric leakage or shorting.**
- If the product cover is torn or removed, your clothes or hair may get caught, resulting in a serious accident, so check that there is no abnormality visible on the exterior of the product. If the product is damaged in any way, contact the Customer Service Center.
→ **Failure to do so may cause electric shock or injury.**
- Supervise your children in avoiding touching the power plug.
→ **Failure to do so may cause electric shock or injury.**
- Do not forcibly bend the power cord or allow it to be compressed and damaged by a heavy object.
→ **Failure to do so may cause fire or electric shock.**
- When using a power strip, do not use a number of devices connected to the power strip at the same time.
→ **There is a risk of fire due to abnormal Temperature of the power outlet.**
- When unplugging the power plug, hold the plug, not the cord, and unplug it from the outlet.
→ **If the power cord snaps, there is a risk of fire or electric shock.**
- Do not touch the power plug with wet hands, and be sure to unplug the power plug from the outlet when cleaning or repairing the product.
→ **Failure to do so may cause electric shock.**
- When using a power strip, be sure to use a grounded power outlet.
→ **Using an ungrounded outlet may cause electric shock or injury.**
- In a case of power failure, immediately turn off the power switch and unplug the power plug from the outlet.
→ **Failure to do so may cause electric shock or fire.**
- During product operation, do not allow the AC cord or the remote control cable to become caught in the central connection support or five-legged chair support.
→ **Failure to do so cause a short circuit due to damage to the cable sheath, so caution should be taken while using the product.**

When Using the Product

As there is a risk of accidents related to unsafe use, the following persons should avoid using the massage chair.

(1) The following patients must not use the product:

- Patients with thrombosis, embolism, severe varicosity or acute varicosity which has been judged by a doctor to be incompatible with the use of a massage chair.
- Persons with a suspected acute cervical sprain (whiplash).
- Persons with symptoms of a sprain or sudden muscular contractions and straining.
- Pregnant women in their early pregnancy, or a mother immediately after giving birth.
- Persons with an abnormality in their backbone (spine) or with a backbone that is bent left and/or right due to a past accident or a disease, etc.
- Patients with acute splanchnopathy or a severe heart disorder.
- Patients with an implantable electronic medical device, such as an implantable pacemaker, etc.
- Patients with a symptom of acute seizure or psychogenic disorder (perceptual disorder)
- Patients with thermanesthesia caused by a high degree of peripheral circulatory disorders due to diabetes, etc.
- Persons with concerns regarding osteomyelitis or rickets.
* Rickets: Symptoms of shrinking muscles throughout the body and an inability to stretch the arms and legs.
- Persons with difficulty in making communicative expressions and physical movements.
- Persons with a symptom of disk disorders or under related medical treatment.
- Persons with special physical anomalies who are under medical treatment at a medical institution.

(2) The following persons must consult a doctor before use:

- Persons, such as pregnant women, etc., with a concern of side effects resulting from use of the product
- Persons with a higher body temperature than normal due to acute inflammation, chills, etc.
- Persons with symptoms of an acute skin disorder, malignant tumor or other skin disorders.
- Persons under a doctor's treatment who require rest.
- Persons experiencing other physical anomalies.
- Persons whose doctor has prohibited massage.
- Persons with weakened muscles or who have grown thin as a result of aging.
- Persons with back pain.

(3) If any of the following side effects occur whilst using the product, stop using it immediately.

- Abrasion, strain, bruising, cutting (stabbing) or knifing (cutting) by the product.
- Muscle, tendon, nerve, spinal core damage, etc., as a result of excessive use of the product and resultant pressure.
- Skin diseases and burns, etc., - fracture, dislocation, sprain, etc.
- Respiratory or digestive disorders, suffocation, etc.

-
- Do not use or store the product in damp areas, such as a bathroom.
→ **Doing so may cause electric shock, fire, product failure or the growth of mold.**
 - Do not allow children to play or climb on top of the massage chair.
→ **Failure to do so may cause product failure or injury.**
 - Do not use the product while wearing a hard object, such as a hair accessory, etc., on your head.
→ **Doing so may cause injury.**
 - The duration of use should be no more than 30 minutes per day, and continuous use of the product on the same area should be no more than 5 minutes.
→ **Use of the product for a long period of time may cause straining of your muscles or nerves.**
 - When massaging your hips and thighs, do not use the product with any object in your pants' pockets.
→ **Doing so may cause an accident or injury.**
 - Check if the power cord and the remote control cable are appropriately and safely positioned before use.
→ **Failure to do so may cause an accident, injury or product failure.**
 - This product has a Temperature surface. Anyone who is insensitive to the application of heat must pay attention regarding the chance of low temperature burns.
 - During massage operation, do not unplug the power plug from the outlet or turn the power switch [OFF].
→ **Doing so may cause injury.**
 - Do not use the product near fires, such as a heater, etc., or while smoking a cigarette. Also, do not use the product on top of Temperature apparatus, such as an electric pad, etc.
→ **Doing so may cause fire.**
 - Do not use the product after drinking alcohol.
→ **Doing so may result in an accident or injury.**
 - Do not allow more than two persons to sit on the product or to use it at the same time.
→ **Doing so may cause product failure or injury.**
 - Do not use the product on bare skin.
→ **Doing so may cause skin damage.**
 - When cleaning or repairing the product, unplug the power plug from the outlet.
→ **Failure to do so may cause electric shock or injury.**
 - The surface of the product may be hot. Anyone with sensitive skin must set a lower temperature on the product.
→ **Failure to do so may cause low temperature burns.**

02. Transporting and Installation

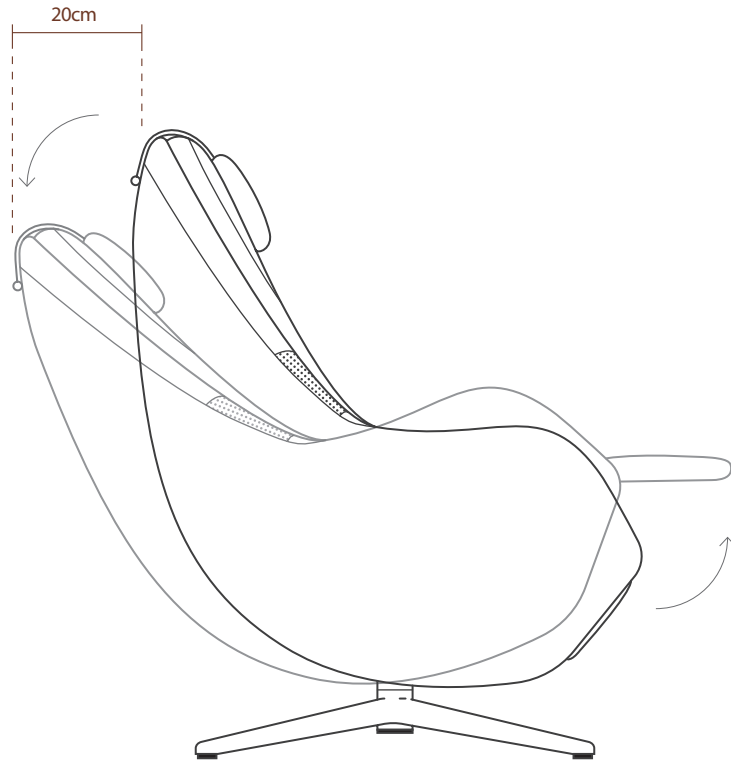

Installation for Use

- (1) Before installing the product, check if there is enough space to accommodate it.
- (2) Ensure that there are no obstacles with a risk of breakage near the product.
- (3) Lift the product, move it to the desired location, lower it slowly into position and complete installation.
- (4) Be careful not to place the power cord under the product and cause it to become trapped or compressed.

03. Name of Each Part and Components

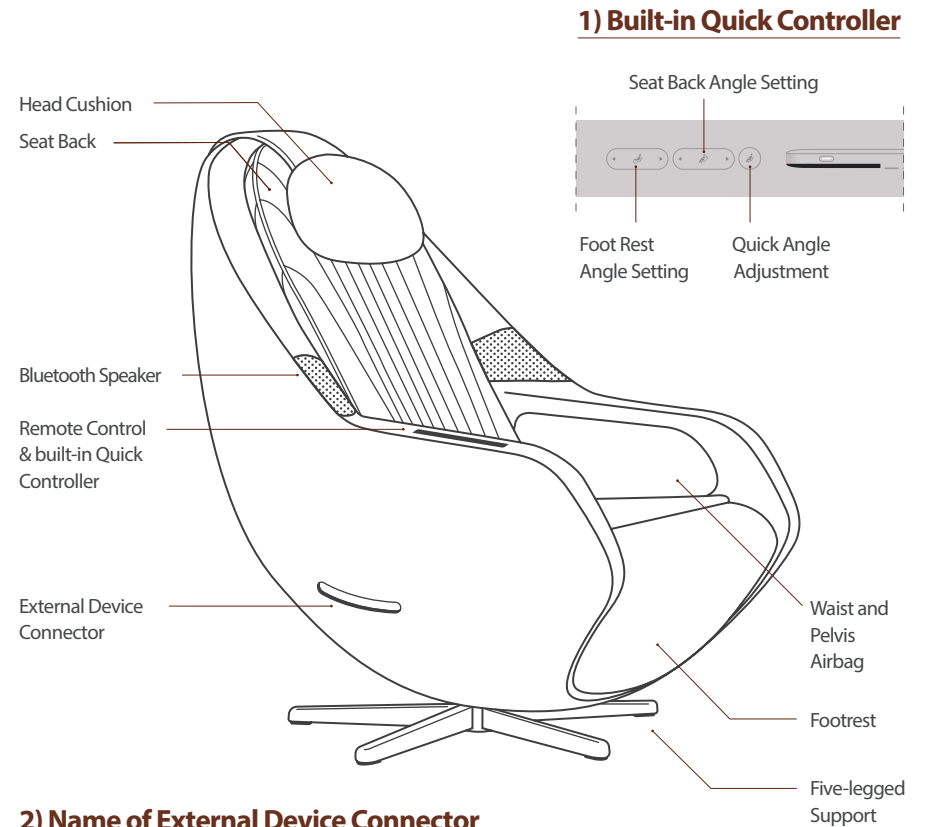

2) Name of External Device Connector

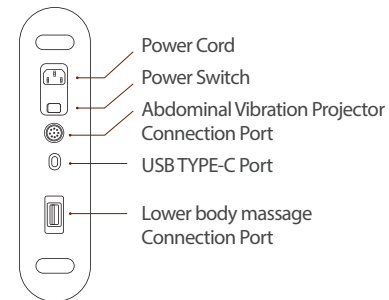

3) Separate Components

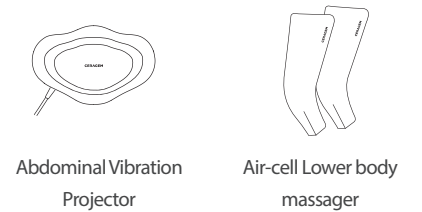

04. Name and Description of the Remote Control

1) Name of Control Units on the Remote Control

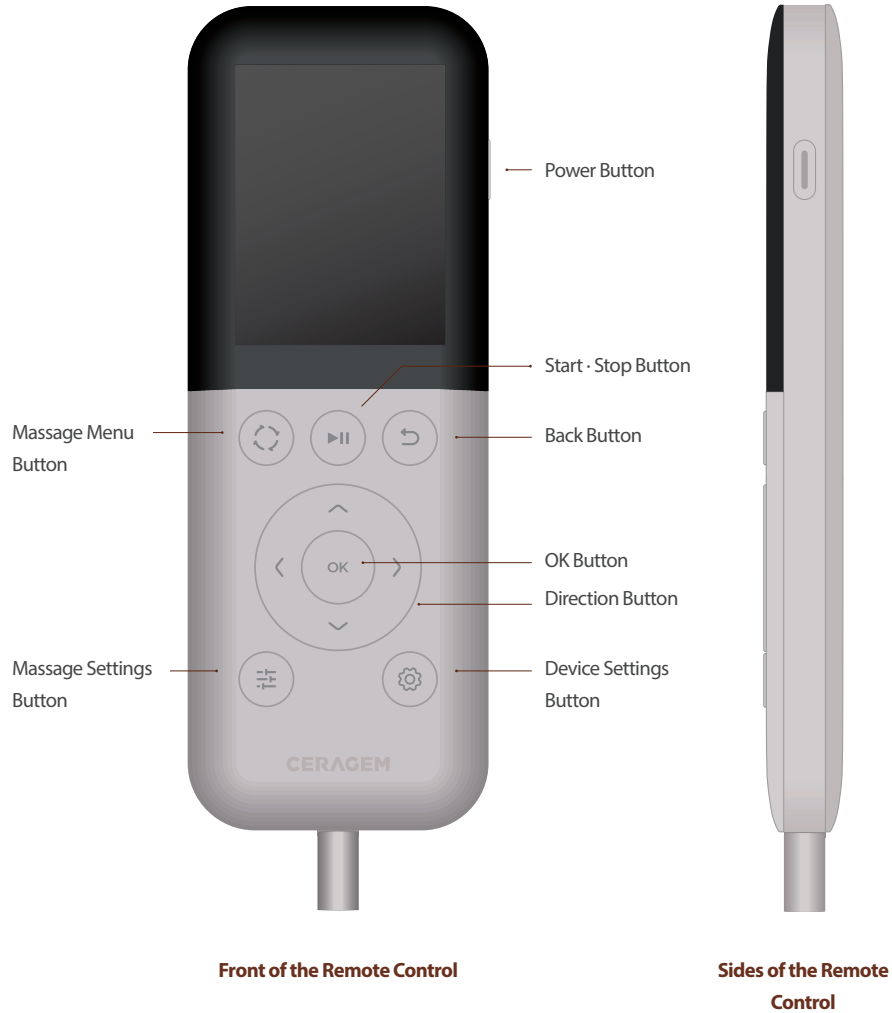

2) Description of Remote Control Buttons



Power Button

- Press the Power button to turn the product on.
- When you press and hold down the Power button during use, the Massage rollers will return to its original position and the operation of the M6 massage chair will end.



Message Menu Button

- Enters the Select Massage screen.
- Sets Auto mode, manual mode, Abdominal massage or Lower body massages and starts the selected massage.



Start/Stop Button

- When you select a massage mode and press the Start button, the selected massage mode will begin.
- When you press the Stop button during massage, the massage will be paused.
- When you press the button again during pause, the massage will resume.



Back Button

- Returns to the previous menu or previous screen.



Direction/OK Button

- Moves the focus or changes settings.
- Selects the menu and starts the selected massage mode.



Message Settings Button

- Allows you to adjust the massage Intensity, speed, roller position, Temperature and air massage intensity.



Device Settings Button

- Allows you to set and check the sound, voice guide, Bluetooth, language and product information for the M6 massage chair.

3) Message Screen on the Remote Control



05. Massage Programs

1) Automatic Program

Auto mode	Functions	Operation Time
Easy mode	Applies massage to the entire body fast.	15 minutes
Full Body	Loosens tense muscles and fatigue of the entire body through Temperature and massage.	30 minutes
Neck & shoulder	Relieves stiff neck and shoulder fatigue effectively by applying massage.	20 minutes
Back & waist	Applies intensive massage to muscles from the back to the waist.	20 minutes
Waist & pelvis	Loosens muscles from the waist to the hips by applying massage.	20 minutes
Vitality	Applies powerful and dynamic massage across the entire body.	30 minutes
Relax	Quietly applies heated massage to relieve stress and ease tension.	30 minutes
Energy	Applies intensive Temperature and massage to an exhausted back, waist and pelvis resulting from long hours of work and/or driving.	30 minutes
Study	Applies intensive Temperature and massage mainly to an exhausted neck and shoulders resulting from sitting for a long period of time.	30 minutes
Sleep	Relaxes a day's tensed muscles through the use of Temperature and massage.	90 minutes

※ The Temperature intensity set by default varies according to the mode.

2) Manual Program

Massage Partials	Functions
Full body	The Massage rollers moves up and down along the curve of the entire body, applying massage.
Neck-back	The Massage rollers moves up and down from the neck to the back, applying massage.
Waist-pelvis	The Massage rollers moves from the waist to the hips, applying massage.
Partial	The Massage rollers applies massage repeatedly to a particular part of the body at a position as designated by the user.
Fixed	The Massage rollers is held in a position designated by the user where it applies massage.

Massage method	Functions
Combination	Applies combined massaging actions of kneading and tapping the muscles.
Kneading	Applies massage by rubbing down muscles in a circular motion.
Kneading (R)	Applies massage by rubbing down muscles in a circular motion in the opposite direction.
Deep tissue	Applies massage by pressing down muscles just as when applying acupressure into the muscles.
Tapping	Applies massage through gentle tapping at a set rhythm.

※ The Temperature intensity set by default varies according to the mode.

06. Using the Massage Chair

1) Automatic Program



- (1) In the stand-by status while massage is in progress, press the Massage Menu button to enter the Select Massage screen and select [Auto mode].
- (2) Press the Up/Down button to select the desired form of automatic massage (10 types) mode.
- (3) To begin massage, the M6 recliner operates.
- (4) To verify the user's body type, it scans the position of the user's shoulders and the curvature of their spine.
- (5) The selected Auto mode will begin.

2) Manual Program

- (1) In the stand-by status while massage is in progress, press the Massage Menu button to enter the Select Massage screen and select [Manual Mode].
- (2) Press the Up/Down button to select the area where massage is required. Press the Up/Down button to select the desired massage method.
- (3) To deliver massage, the M6's angle will be adjusted.
- (4) To verify the user's body type, it scans the position of the user's shoulders and the curvature of their spine.
- (5) The selected manual mode will begin.

- ※ Once you select the Partial and fixed massage position, you can move the position of the Massage rollers using the Up/Down button and have massage applied to the desired area without scanning the user's body type.
- ※ During massage, you can use the Left/Right button to change the massage method.



3) Abdominal Massage

- (1) In the stand-by status while message is in progress, press the Message Menu button to enter the Select Message screen and select [Abdominal massage].
※ If the abdominal massager is not connected, connect it.
- (2) Select the desired vibration mode using the Up/Down button.
(OFF/Normal Mode/Rhythm Mode)
- (3) Press the Left/Right button to move to the vibration intensity settings window, and use the Up/Down button to select the vibration intensity. (Low/High)
- (4) Press the Left/Right button to move to the Temperature settings window, and use the Up/Down button to select the Temperature intensity.
(OFF/Low/Medium/High)
※ When using the Temperature function of the abdominal massager, be aware of the chance of low temperature burns.
- (5) You can check the abdominal massage operation status on the message screen.



4) Lower body Massage

- (1) In the stand-by status while message is in progress, press the Message Menu button to enter the Select Message screen and select [Lower body massage].
※ If the Lower body massager is not connected, connect it.
- (2) Select the desired mode using the Up/Down button.
(OFF/Full body/Circulation/Sequential)
- (3) Press the Left/Right button to move to the Intensity Settings Window, and set the air intensity using the Up/Down button. (Low/Medium/High)
- (4) You can check the Lower body massage operation status on the message screen.



5) Massage Settings

- (1) During massage, press the Massage Settings button to enter the Massage Settings Screen.
- (2) Select the desired item to select using the Left/Right button.
(Intensity/Speed/Roller position/Air Intensity)
- (3) Press the Up/Down button to select the detailed item values for massage.
 - ※ Massage roller position can be set only in manual massage Deep tissue/tapping status.
 - ※ In the Temperature item, you can set the Temperature temperature of the device seat and Massage rollers.
 - ※ When using the Temperature function, be aware of the chance of low temperature burns.
- (4) Massage Settings can be checked on the massage screen.



6) Device Settings

(1) Ceragem Sound

- ① On stand-by status or during massage, press the Device Settings button to enter the Device Settings Menu screen.
- ② On the Device Settings menu, select the Sound/Voice item and then enter the Ceragem Sound menu.
- ③ Select the desired sound source using the Up/Down button.

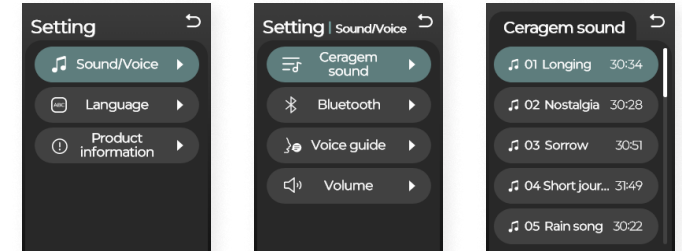

(2) Bluetooth Settings

- ① On the Device Settings menu, select the Sound/Voice item and then enter the Bluetooth menu.
- ② You can turn Bluetooth ON/OFF and initialize connection using the Up/Down button and the OK button.
- ③ When connecting via Bluetooth, search for and connect to Pause-M6-****-***** on the Bluetooth Search menu of the device to which you wish to connect.
(PIN : 1234)

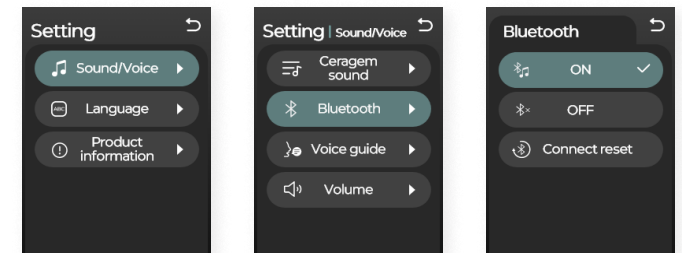

6) Device Settings

(3) Voice guide Settings

- ① On the Device Settings menu, select the Voice guide item using the Up/Down button.
- ② You can turn voice guide ON/OFF using the Up/Down button and the OK button.



(4) Volume Settings

- ① On the Device Settings menu, select the Sound/Voice item and then enter the Volume Settings menu.
- ② Adjust the volume of the Ceragem Sound using the Up/Down button.

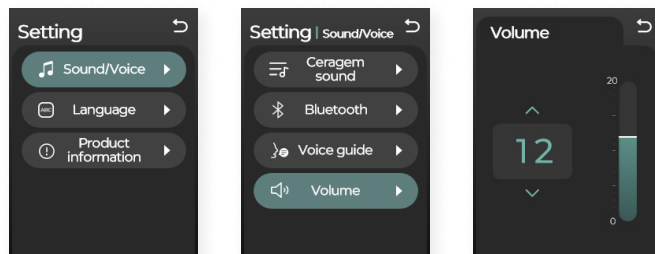

(5) Language Settings

- ① On the Device Settings menu, enter the Language Settings item using the Up/Down button.
- ② You can set either Korean or English.

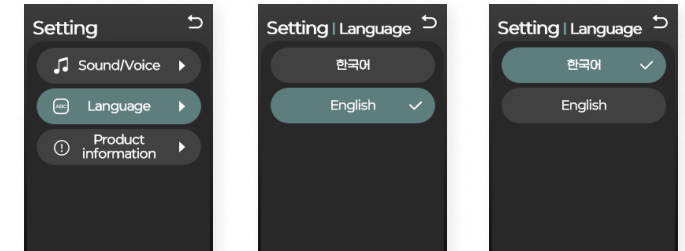

(6) Checking Product Information

- ① On the Device Settings menu, enter the Product Information item using the Up/Down button.
- ② You can check product version and SW version.

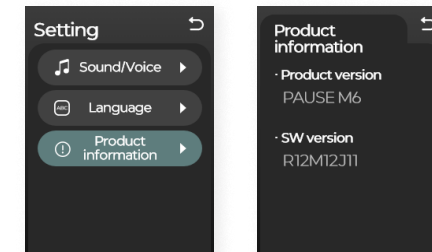

7) Use of the recliner

(1) Remote Control Operation

- ① On stand-by status or during massage, when you press and hold down the detailed massage settings button for 3 seconds, you will enter the manual recliner adjustment screen.
- ② You can adjust the angle of the back using the Up/Down button.
- ③ You can adjust the angle of legs using the Left/Right button.
- ④ When you press the Back button, OK button, or no operation is done for 30 seconds after adjusting the angle, you will return to the previous screen.



Detailed Settings Button

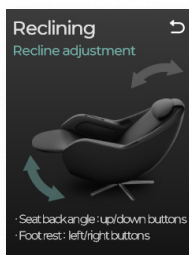
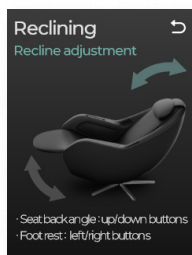
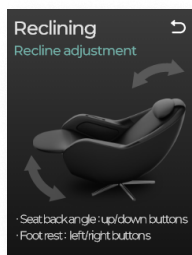

(2) Buttons Operation

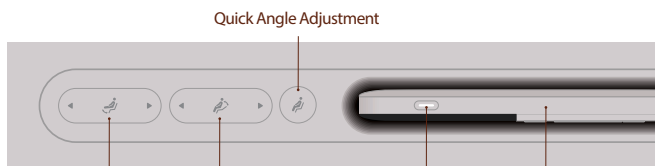

- ① When you press the ◀ Direction button on the (Leg Angle Button Icon) button, the angle of the legs will be increased.
- ② When you press the ▶ Direction button on the (Leg Angle Button Icon) button, the angle of the legs will be decreased.
- ③ When you press the ◀ Direction button on the (Back Angle Button Icon) button, the angle of the back will be increased forward.
- ④ When you press the ▶ Direction button on the (Back Angle Button Icon) button, the angle of back will be decreased backward.
- ⑤ When you press the (Quick Angle Adjustment Icon) button, the angle of the massage chair will change.
 - ※ (zero gravity 1 : 135°) when you press it for the first time, (zero gravity 2 : 150°) when you press it for the second time, and (Original position of all angles) when you press it for the third time.

8) Pre-heating Mode

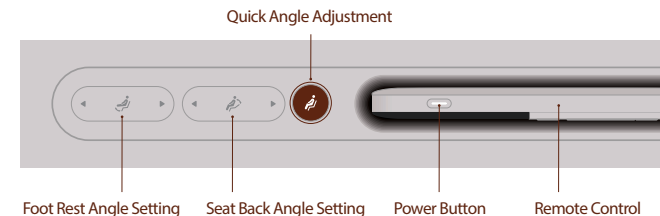

- (1) When you press and hold down the Original Position button for 3 seconds, the pre-heating mode will operate.
 - ※ The temperature of the Massage rollers will be set to a temperature similar to the human body temperature.
- (2) While preheating, the LED on the remote control blinks rapidly.
- (3) When preheating is complete, the LED on the remote control will gently turn on and off repeatedly.
 - ※ If no separate operation is conducted for 5 minutes, the preheating mode will end.

07. Maintaining and Storing

- When carrying out maintenance on the massage chair, be sure to unplug the power plug from the wall outlet.
Do not touch the product with wet hands.
→ **Doing so may cause electric shock or injury.**
- Do not wipe the product with benzene thinners, alcohol, or spray pesticides onto it.
→ **Doing so may cause discoloration, deterioration or fire.**
- It cannot be washed using water, and gently dry it using a towel.
- Never iron the head cushion or back pad.
- Please note that external finishing materials may be discolored by jeans and other clothing which carry a high level of dye/coloring.
- As a result of continuous exposure to UV rays, the product may become discolored, so, if possible, avoid positioning the product next to a window or on a place under strong sunlight.

08. Troubleshooting

If there is a problem while using the product, first check the following before contacting the Customer Service Center.

The product must not be disassembled or repaired arbitrarily by the user. If the product is damaged due to arbitrary disassembly or repair, the product warranty will not be recognized.

Symptoms	Causes:	Possible solutions:
The product does not operate.	The Power button on the remote control has not been pressed.	Press the Power button on the remote control.
	The program has not been executed.	Select and execute the program.
	Power plug contact failure	Check the plug connection status.
	Power plug or cable damage	Contact the Customer Service Center.
	An abnormality in electronic circuits	
A noise occurs from the massage chair.	A phenomenon of general machine noises:	This is a normal operating sound of the product which is not a sign of failure.
	· Air pump operation noises	
	· Airbag inflation/deflation noises	
	· Massage module operation noises	
	· Recliner friction noises	
If the product suddenly stops during operation.	Sudden power supply cutoff	Turn the power on again.
	End of operation time in massage mode	Restart the massage mode.
If the Massage rollers or the recliner cannot return to its original position	When you press a button or power supply is cut off while ending	Turn the power on again.
	When operating it excessively	Contact the Customer Service Center.
If the air massager does not operate	The air connection hose is detached	Contact the Customer Service Center.
	An air-related power cable has snapped	

* If the symptom cannot be solved by referring to the suggestions herein, refer to the product warranty and contact the Customer Service Center.

09. FAQ

Q1. Can I receive massage only to my back?

You can receive massage to the desired area by selecting Manual Massage and selecting "Fixed" as the massage area item.

(You can move the Massage rollers to the desired position using the Up/Down button among the direction buttons.)

Q2. How many degrees does the chair tilt backward?

The chair tilts backwards from 120 degrees, the default angle, up to 150 degrees.

The electric reclining function applied to PAUSE M6 allows you to adjust the angle using the angle adjustment button.

(The angle is adjusted only while the user is pressing and holding down the angle adjustment button, and it is at a standstill while the button is not being pressed and/or being held down.)

Q3. Bluetooth connection is not available.

After turning off and on the massage chair, you can connect to the device again after deleting Pause-M6-****.***** on the device to which you intend to connect. (PIN : 1234)

Q4. Will the product produce loud noise between floors?

Unlike other massage chairs, the driving main body is not attached to the floor, so there is virtually no noise issue between floors. You can further reduce noise by using the massage chair after placing a rug under the chair.

Q5. Is it possible to replace the seat pad?

Exterior parts, such as the head cushion, seat pad, air massage cover, etc., can be replaced at a specific cost.

Q6. The operating noises seem to be louder than the noises I experienced at the store.

At the store, you might have not heard the massage chair's operating noises as a result of the presence of ambient noises.

In a residential space which is relatively quiet, you may hear the machine operating noises when the massage chair is operating, but rest assured that these are normal operating noises.

Q7. Would you transport the massage chair if I were to move?

If you wish to have the chair transported, contact the Customer Service Center.

10. Customer Service

Free A/S Items

- (1) Machinery and instruments operating the massage unit which are inside the massage chair
- (2) Main boards, various motors and air pumps
- (3) Internal electronics, electrical wiring and air hoses

Paid A/S Items

- (1) Outer seat, inner seat, all inner and outer covers
- (2) Discoloration, decolorization, tearing caused by customer's use, or damage to seats caused by pets (PU leather, outer and inner covers made of fabric).
- (3) Damage to the main body case and cables due to customer negligence while using the remote control.

Service Period

- (1) If product failure occurs while you are using the product, you can receive free service for one year from the date of installation.
- (2) When the product is used in a shared facility, or for business purposes, the free service period is shortened to 6 months.
- (3) The notice required for a service visit is around 7 days for Seoul and the area of the capital, and around 14 days for non-capital areas based on weekdays, excluding holidays.

Information on Paid Service

- (1) If product failure occurs due to liquid or other foreign substances on the product
 - (2) When an impact is applied to the product so that damage or a functional failure occurs
 - (3) If the exterior is damaged or deformed by organic solvents, such as thinners or benzene, etc.
 - (4) If product failure occurs due to the use of non-genuine parts or consumables
 - (5) If product failure occurs due to an unforeseen disaster
 - (6) If product failure occurs due to a failure to comply with cautions in the User Manual
 - (7) If product failure occurs due to any other form of customer negligence
 - (8) If discoloration and decoloration occur due to continuous exposure to sunlight and ultraviolet light
 - (9) If the bottom frame has been damaged
-

Information on Exchange & Return

Exchange and/or return due to simply a change of a customer's mind are only acceptable within 2 weeks from the date of installation. Round-trip shipping costs (amounts vary depending on the region) and an installation fee will be charged. In case of a defect which requires major repair at the time of product installation, the product will be exchanged free of charge within 2 weeks.

Information on no Exchange or Refund

This product is an electronic product that is assembled, and exchange and/or refund will not be acceptable for any of the following reasons:

- (1) When the value of the product has significantly decreased due to an abnormality in the product caused by the consumer's carelessness and incorrect or inappropriate use of the product
- (2) Exchange and/or refund due to simply a change of a customer's mind after 2 weeks from the date of installation
- (3) Exchange and/or refund due to differences in user massage sensitivity or the user's heights that vary between individual users, not a product defect
- (4) In case of a defect which does not require major repair at the time of product installation

*Reasons for charging shipping costs : In case of product return due to simply a change of a customer's mind before opening the packaging box, the round-trip transportation costs will be charged to the customer. (Returned product will not be accepted if the product packaging has been opened)

11. Product Specifications

Product Name	PAUSE M6
Model Name	CGM EMCG-2401
Size of Massage Chair	W75XD113XH113cm
Net Weight	70.6kg
Service Voltage	AC100-240V, 50/60Hz
Power Consumption	350W
Electromagnetic Compatibility Certification No.	R-R-cer-CGMEMCG-2401 R-R-ZcE-ZEN-BMD10-A
Electrical Safety Certification No.	SU071482-24001
Customer Service Center	1577-5570

12. Product Warranty

1. Ceragem provides warranty services for this product in accordance with the regulations in the Consumer Protection Law.
2. When you purchase products approved by Ceragem, repair services of the parts normally used are provided within the warranty period which is calculated from the date of installation, so ensure that the date of installation is written down and stored securely.
3. This warranty is provided free of charge in the country where the product was purchased.
4. The warranty period is valid for one year (12 months) from the date of installation.
5. In the event of product failure, please contact the Customer Service Center.

Product Warranty	Product Name	Model Name
	Serial No.	Place of Purchase
	Date of Purchase	Date of Installation

Customer Information	Customer's Name
	Telephone Number
	Address
	Location
	Zip Code
	※ Warranty Period : It is 1 year (12 months) from the date of purchase, or in the case of rental, it varies according to the agreed rental period.
	※ Parts Holding Period : 6 years (calculated based on the date of manufacture.)

Free and Paid Repair Services **10. Please refer to the customer service information.**

Matters that require attention
 The customer assumes responsibility for product damage or failure in the following circumstances:

- If the product has been repaired by an unauthorized technician.
- If the product has been repaired or modified by the user.
- If the product has been damaged or has failed due to misuse, abuse or carelessness.

This warranty statement is effective from the time of purchase or rental contract. This warranty statement only applies to the person who first purchased the product, and the warranty will become null and void for anyone who acquires this product from the initial purchaser.

Any warranty statements that were not issued by Ceragem, or were issued by other parties, or have expired, are exempt from the terms stated above.

CERAGEM

Ceragem Co., Ltd.

10, Jeongja 1-gil, Seonggeo-eup, Seobuk-gu, Cheonan,
Chungcheongnam-do, Republic of Korea

16, Jeongja 1-gil, Seonggeo-eup, Seobuk-gu, Cheonan,
Chungcheongnam-do, Republic of Korea

WWW.CERAGEM.CO.KR

1577-5570