



PORTABLE POWER PACK

Model: GBL1500W



WARNING

Please read and understand the contents of this manual before using this product. Failure to operate this product in accordance with these instructions may cause: damage to the product; damage to attached external devices and/or equipment; personal injury.

SPECIFICATIONS

Input voltage/current:

AC adapter input: 36V \approx 6A (max)

Solar panel input: 36V-65V \approx 6A (max)

Time for full charge: 8 ~ 9 hours (with provided AC adapter)

DC output:

USB output voltage/current: 5V \approx 3.0A 15W (max)

DC output voltage/current: 12V \approx 10A 120W (max)

AC output:

Continuous output: 110V 60Hz or 220V 50Hz 1500W (max)

Instantaneous peak: 3000W

Capacity: 28.8V/52.2Ah | 3.6V/417.6Ah) | 524Wh

Size: 408 x 163 x 256 mm
16.1 x 6.4 x 10.1 inches

Net weight: 14 kg
30.9 lbs

Number of battery cycles: 1000 times (capacity \geq 80%)

Working temperature: -10°C ~ 50°C
14°F ~ 122°F

Working humidity: \leq 95%

Electrical protection: Short circuit protection
Over-charge protection
Over-heat protection
Over-discharge protection
Over-voltage protection



OVERVIEW

Welcome to the **OFF-GRID Portable Power Pack**, the next generation, multi-purpose power station and backup battery pack. It features a built-in, long-cycle, lithium-ion battery encased in a high strength, aluminum alloy body. Manufactured and rigorously tested in an ISO9001-rated factory, backed up by CE, RoHS, and FCC certificates, you can be confident of safety and reliability.

The **OFF-GRID Portable Power Pack** can be recharged by solar panel (optional accessory), vehicle charger (optional accessory), and home AC (with included adapter). Features multiple outputs, including dual 110V or 220V AC (up to 1500W), to power or charge a wide array of electric devices such as outdoor and camping gear, drone battery, medical equipment, emergency relief, home backup power, lighting, etc.

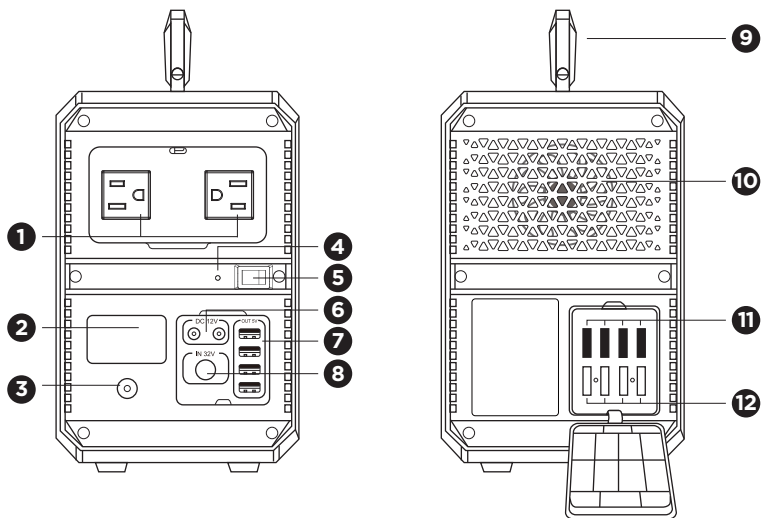

1. AC output port x2
2. LCD display
3. DC power button
4. AC indicator

5. AC power switch
6. DC 12V output x2
7. USB 5V output x4
8. DC input

9. Easy-carry handle
10. Cooling fan
11. Spare fuses
12. Working fuses

GROUND CABLE

When using this unit outdoors, in damp conditions, and/or when the unit is placed directly on the ground, it is advisable to install the provided ground cable. This is a preventative measure to reduce the risk of very rare power surges or short circuits. It is not necessary when using the unit indoors or when placed on a dry, hard surface.

- 1) Locate the ground cable and nut (from the accessory box that came with this unit).

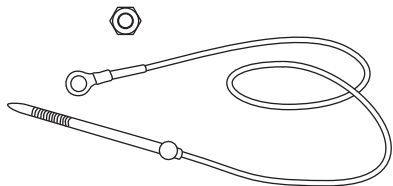

- 2) Lay the unit on its side and locate the connection stud.

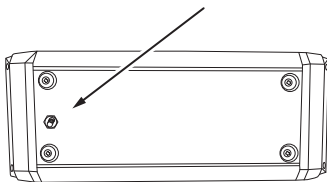

- 3) Place the lug end of the cable over the stud and secure with the nut.

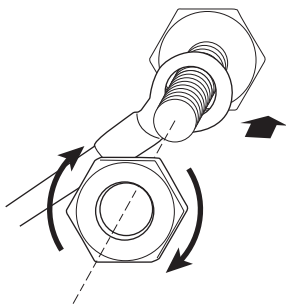

- 4) Insert the probe end of the cable into the ground.

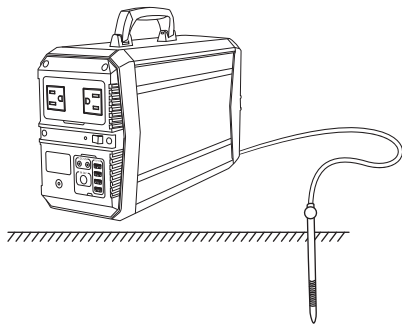

OPERATION

Before using the unit for the first time, insert the four provided fuses as shown. Two fuses are in-circuit and two are spares. Slight sparking may occur when inserting the fuses but this will not cause harm to the user or the unit. Charge the unit using the provided AC adapter.

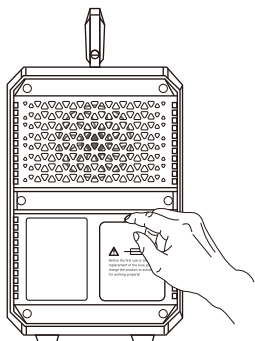

1) Open the fuse cover.

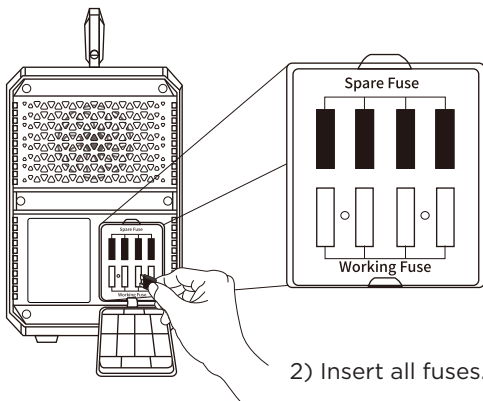

2) Insert all fuses.

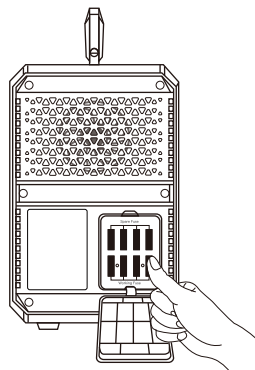

3) Ensure working fuses are fully seated. Unit will not function otherwise.

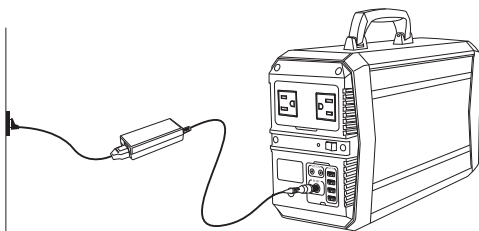

4) Insert AC adapter into the input socket and plug it into an electrical receptacle. After an initial charge of about 30 seconds, the unit can be activated as follows.

Press the DC power button to activate the display screen. You can check the battery capacity, temperature and output voltage. Screen will automatically turn off after one minute.

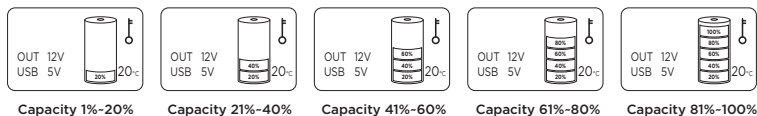

Charge the unit using the provided AC adapter or a solar panel (36V ~ 65V). The indicators on the display will flash to indicate the unit is charging. Input voltage is also displayed.

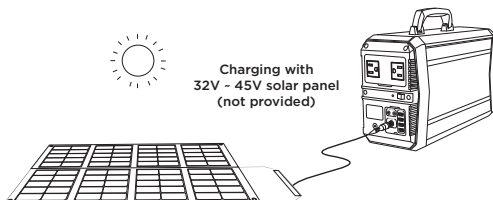
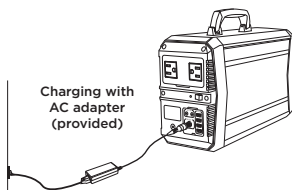
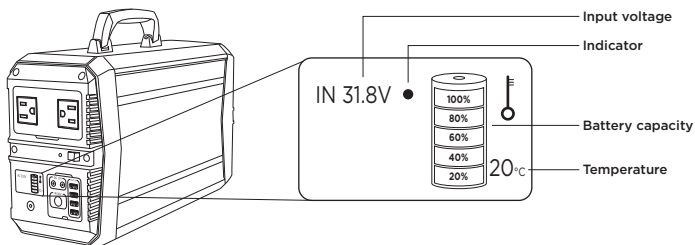

DC OUTPUT

Press the DC power button. The display screen indicates OUT 12V and USB 5V and the unit is ready to charge any 12V or 5V devices.

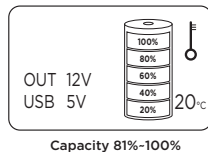

The indicators will flash according to which outputs are in use. If no devices are present, the unit will automatically disable the output after one minute.

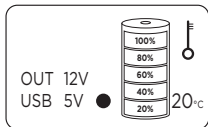

USB indicator flashing:
USB 5V output in use

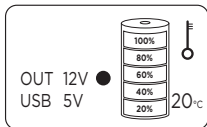

12V indicator flashing:
12V output in use

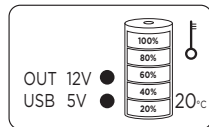

Both indicators flashing:
12V and USB outputs in use

Supply power to 12V LED light



Supply power to car equipment



Supply power to mobile phone



Supply power to tablet

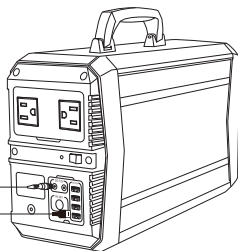

AC OUTPUT

Press the AC power switch to on position [—]
The red indicator will light. The unit is now ready to power your AC devices (maximum total load is 1500W).

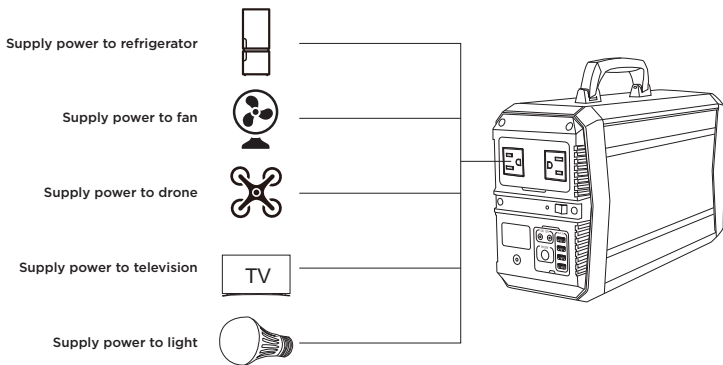
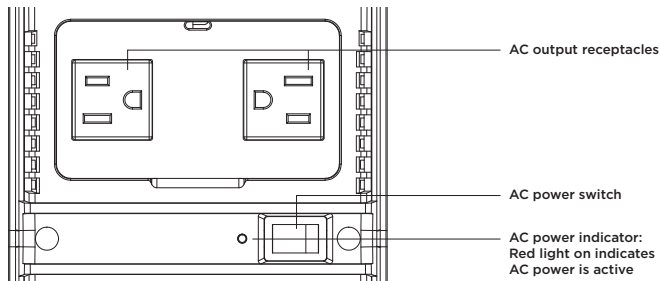

WARNING:

Do not place your finger or hand-held conductors inside the AC receptacles to avoid electric shock.

Before connecting your AC equipment, confirm that the equipment's voltage and power rating does not exceed the capacity of this unit (maximum total load is 1500W).

Do not connect the AC output of this unit to its own DC input. This will damage the unit.

USAGE TIMES

Approximate charging/run times for typical devices:

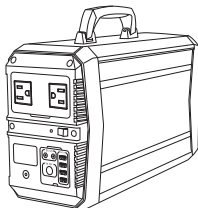

28.8V/52.2Ah
(3.6V/417600mAh)

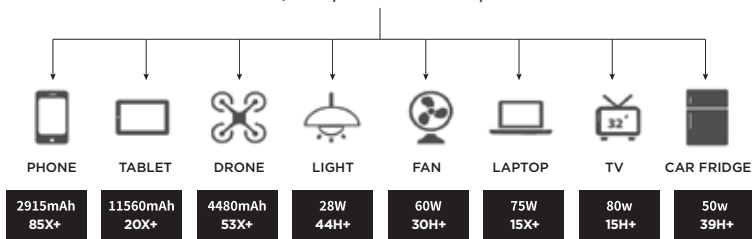

Charging while discharging: You can charge this unit while simultaneously powering your devices. When the input power is less than the output power, the battery will gradually decrease to a low power state. When this occurs, the unit will sound a beep alarm for you to disconnect any devices from the outputs. If you fail to turn off the output manually, the unit will do so automatically. The alarm will continue to sound until the unit is charged to more than 30%, after which the alarm will cease and the outputs will be reactivated.

Cooling system: This unit contains an intelligent temperature control system. The cooling fan will operate automatically to keep the internal temperature of the unit below 45°C (113°F).

POWERING OFF

To turn off DC outputs, press and hold the DC power button for 3 seconds. To turn off AC outputs, press the AC power switch to the off position: [O] The red indicator light will extinguish.

BEEP ALARMS

| SIGNAL | CONDITION |
|----------------------------------------------------------|---------------------------------------------------|
| beep beep beep repeated every two seconds | Low battery alarm or battery off |
| beep beep — beep beep repeated every two seconds | Overvoltage alarm or overvoltage shutdown |
| beep beep beep — beep beep beep repeated every second | Overload, short circuit or overcurrent alarm |
| long beep for ten seconds | Over temperature protection (turn off outputs) |

PRECAUTIONS

Do not store or use this unit beyond its humidity and temperature ratings to avoid short circuit or damage.

Do not squeeze, crush, drop, or otherwise mishandle the unit. Physically damaging the built-in battery could cause a fire.

Do not disassemble or modify this unit. Doing so will void your warranty and may cause personal harm.

Charge the unit every three months when not in use to retain the life span of the battery.

Keep away from children.

TROUBLESHOOTING

| CONDITION | REMEDY |
|--------------------------------------------------------------------------------------------------------------------------------------------------------------------------|--------------------------------------------------------------------------------------------------------------------------------------------------------------------------------------------------------------------------------------------------------------------------------------------------------------------------------------------------------------------------------------------------------------------------------------------------------------|
| <ul style="list-style-type: none">• AC or DC outputs inoperative• Pressing power button or switch ineffective• Power indicators inactive | <ul style="list-style-type: none">• Check that working fuses are fully seated.• If you suspect that the working fuses are blown, replace them with the two spare fuses. Then charge unit as usual.• Check that input source is active and providing sufficient power. |
| <ul style="list-style-type: none">• AC or DC outputs inoperative | <ul style="list-style-type: none">• Check remaining capacity of the unit. If low, charge the unit.• Check device power rating. Combined power load should not exceed 1500W.• Check that output voltage matches devices.• Check that either DC power button or AC power switch is on.• Check that unit is in self-protection mode. Charge unit to reactivate.• Check condition of charging cables. |
| <ul style="list-style-type: none">• Unit won't charge | <ul style="list-style-type: none">• Check that charging voltage meets unit requirement.• Check condition of charging cables and/or adapter. |
| <ul style="list-style-type: none">• Unit shutdown during charging | <ul style="list-style-type: none">• The unit will automatically shutdown if overheated. Remove the unit from high temperature/high humidity environment. Allow the unit to cool down and then restart. |

PRODUCT LIABILITY EXEMPTION

The manufacturer/distributor shall not be held liable for any damages to or loss of property or personal injury to the user or third parties due to improper use and/or failure to observe and follow all instructions and precautions contained within this manual.

The manufacturer/distributor shall not be held liable for any malfunction or any direct or indirect failure of the connected equipment when using the unit.

Do not use flammable gases or liquids, such as insecticides, alcohol, or gasoline, near the unit, which may cause fire.

Do not operate unit where salt air intrusion may occur. Corrosion may cause malfunction and reduce unit life.

Do not obstruct air vents of the unit. Overheating of the unit may cause fire, malfunction or reduce unit life.

Do not use this unit in a high temperature, high humidity, dusty, oily, and/or steamy environment, which may cause malfunction, fire, reduced unit life and/or risk of electric shock.

Do not place the unit in a fire or hot environment, which may cause overheating, fire, malfunction, or reduced unit life.

Do not touch the unit, operating parts and/or input and output ports of the unit with wet hands, which may cause electric shock or malfunction.

Do not insert foreign objects into unit gaps, input/output ports, or exhaust fans, as this may cause injury, electric shock (special attention for children), or malfunction.

If the unit is dropped or otherwise physically damaged, or you suspect electrical problems, stop using it and consult us for assistance. Continued use may cause electric shock, overheating or fire.

Do not touch any fluid leak from the internal battery. Contact with battery fluids may cause personal injury. Rinse with water and seek medical attention immediately.

Persons with pacemakers should not touch this unit. This unit may cause damage to the pacemaker putting your life at risk.

ACCESSORIES



AC Adapter
(included)



Power Cable
(included)



5521 to
Cigarette Lighter
(included)



USB Cable
(included)



Fuses x8
(included)



Folding Solar Panel
(sold separately)

To purchase optional accessories, please visit georgianbayleisure.com

WARRANTY

This unit is warranted for a period of 90 days from the date of purchase against manufacturer defects. Proof of purchase required. This warranty is applicable to the original purchaser and cannot be transferred.

Repair or replacement of defective parts are at the discretion of the manufacturer/distributor. In the event that a repair is not possible, the unit or part will be replaced, at the discretion of the manufacturer/distributor, if within the warranty period.

If this unit was purchased from a retailer/dealer, that dealer's return policy will be in effect.

Exclusions from the warranty provisions include but are not limited to: normal wear from use, user negligence, misuse, failure to follow instructions for use and care, and repair by unauthorized parties. The manufacturer/distributor is not liable for incidental or consequential damages incurred by such actions.



Georgian Bay
L E I S U R E

Imported and distributed by
Georgian Bay Leisure Distributors Ltd.

georgianbayleisure.com